

TMS3320C5515 DSP System

User's Guide



Literature Number: SPRUFX5A
October 2010—Revised November 2010

Preface	9
1 System Control	13
1.1 Introduction	13
1.1.1 Block Diagram	13
1.1.2 CPU Core	14
1.1.3 FFT Hardware Accelerator	14
1.1.4 Power Management	15
1.1.5 Peripherals	15
1.2 System Memory	16
1.2.1 Program/Data Memory Map	16
1.2.2 I/O Memory Map	20
1.3 Device Clocking	20
1.3.1 Overview	20
1.3.2 Clock Domains	23
1.4 System Clock Generator	23
1.4.1 Overview	23
1.4.2 Functional Description	24
1.4.3 Configuration	26
1.4.4 Clock Generator Registers	29
1.5 Power Management	33
1.5.1 Overview	33
1.5.2 Power Domains	33
1.5.3 Clock Management	34
1.5.4 Static Power Management	46
1.5.5 Power Configurations	50
1.6 Interrupts	53
1.6.1 IFR and IER Registers	54
1.6.2 Interrupt Timing	55
1.6.3 Timer Interrupt Aggregation Flag Register (TIAFR) [1C14h]	56
1.6.4 GPIO Interrupt Enable and Aggregation Flag Registers	56
1.6.5 DMA Interrupt Enable and Aggregation Flag Registers	56
1.7 System Configuration and Control	57
1.7.1 Overview	57
1.7.2 Device Identification	57
1.7.3 Device Configuration	61
1.7.4 DMA Controller Configuration	70
1.7.5 Peripheral Reset	73
1.7.6 EMIF and USB Byte Access	75
1.7.7 EMIF Clock Divider Register (ECDR) [1C26h]	77

List of Figures

1-1.	Functional Block Diagram	13
1-2.	DSP Memory Map	17
1-3.	DSP Clocking Diagram	22
1-4.	Clock Generator	24
1-5.	CLKOUT Control Source Select Register (CCSSR) [1C24h].....	25
1-6.	Clock Generator Control Register 1 (CGCR1) [1C20h]	30
1-7.	Clock Generator Control Register 2 (CGCR2) [1C21h]	30
1-8.	Clock Generator Control Register 3 (CGCR3) [1C22h]	31
1-9.	Clock Generator Control Register 4 (CGCR4) [1C23h]	31
1-10.	Clock Configuration Register 1 (CCR1) [1C1Eh].....	32
1-11.	Clock Configuration Register 2 (CCR2) [1C1Fh].....	32
1-12.	Idle Configuration Register (ICR) [0001h].....	36
1-13.	Idle Status Register (ISTR) [0002h].....	37
1-14.	Peripheral Clock Gating Configuration Register 1 (PCGCR1) [1C02h]	39
1-15.	Peripheral Clock Gating Configuration Register 2 (PCGCR2) [1C03h]	41
1-16.	Peripheral Clock Stop Request/Acknowledge Register (CLKSTOP) [1C3Ah]	42
1-17.	USB System Control Register (USBSCR) [1C32h]	44
1-18.	RTC Power Management Register (RTCPMGT) [1930h].....	46
1-19.	RTC Interrupt Flag Register (RTCINTFL) [1920h]	47
1-20.	RAM Sleep Mode Control Register1 [0x1C28]	48
1-21.	RAM Sleep Mode Control Register2 [0x1C2A]	49
1-22.	RAM Sleep Mode Control Register3 [0x1C2B]	49
1-23.	RAM Sleep Mode Control Register4 [0x1C2C].....	49
1-24.	RAM Sleep Mode Control Register5 [0x1C2D].....	49
1-25.	IFR0 and IER0 Bit Locations.....	54
1-26.	IFR1 and IER1 Bit Locations.....	55
1-27.	Die ID Register 0 (DIEIDR0) [1C40h].....	58
1-28.	Die ID Register 1 (DIEIDR1) [1C41h].....	58
1-29.	Die ID Register 2 (DIEIDR2) [1C42h].....	58
1-30.	Die ID Register 3 (DIEIDR3[15:0]) [1C43h]	59
1-31.	Die ID Register 4 (DIEIDR4) [1C44h].....	59
1-32.	Die ID Register 5 (DIEIDR5) [1C45h].....	59
1-33.	Die ID Register 6 (DIEIDR6) [1C46h].....	60
1-34.	Die ID Register 7 (DIEIDR7) [1C47h].....	60
1-35.	External Bus Selection Register (EBSR) [1C00h].....	61
1-36.	RTC Power Management Register (RTCPMGT) [1930h].....	63
1-37.	LDO Control Register (LDOCNTL) [7004h]	65
1-38.	Output Slew Rate Control Register (OSRCR) [1C16h].....	66
1-39.	Pull-Down Inhibit Register 1 (PDINHIBR1) [1C17h]	67
1-40.	Pull-Down Inhibit Register 2 (PDINHIBR2) [1C18h]	68
1-41.	Pull-Down Inhibit Register 3 (PDINHIBR3) [1C19h]	69
1-42.	DMA Interrupt Flag Register (DMAIFR) [1C30h]	72
1-43.	DMA Interrupt Enable Register (DMAIER) [1C31h].....	72
1-44.	DMA _n Channel Event Source Register 1 (DMA _n CESR1) [1C1Ah, 1C1Ch, 1C36h, and 1C38h]	73
1-45.	DMA _n Channel Event Source Register 2 (DMA _n CESR2) [1C1Bh, 1C1Dh, 1C37h, and 1C39h]	73
1-46.	Peripheral Software Reset Counter Register (PSRCR) [1C04h].....	74
1-47.	Peripheral Reset Control Register (PRCR) [1C05h].....	74

1-48. EMIF System Control Register (ESCR) [1C33h]	76
1-49. EMIF Clock Divider Register (ECCR) [1C26h]	77

List of Tables

1-1.	14
1-2.	DARAM Blocks	17
1-3.	SARAM Blocks.....	18
1-4.	SAROM Blocks	19
1-5.	PLL Output Frequency Configuration.....	24
1-6.	CLKOUT Control Source Select Register (CCSSR) Field Descriptions.....	25
1-7.	Clock Generator Control Register Bits Used In BYPASS MODE	27
1-8.	Output Frequency in Bypass Mode	27
1-9.	Clock Generator Control Register Bits Used In PLL Mode	27
1-10.	PLL Clock Frequency Ranges	28
1-11.	Examples of Selecting a PLL MODE Frequency, When CLK_SEL=L	29
1-12.	Clock Generator Registers	29
1-13.	Clock Generator Control Register 1 (CGCR1) Field Descriptions	30
1-14.	Clock Generator Control Register 2 (CGCR2) Field Descriptions	30
1-15.	Clock Generator Control Register 3 (CGCR3) Field Descriptions	31
1-16.	Clock Generator Control Register 4 (CGCR4) Field Descriptions	31
1-17.	Clock Configuration Register 1 (CCR1) Field Descriptions	32
1-18.	Clock Configuration Register 2 (CCR2) Field Descriptions	32
1-19.	Power Management Features	33
1-20.	DSP Power Domains.....	34
1-21.	Idle Configuration Register (ICR) Field Descriptions	36
1-22.	Idle Status Register (ISTR) Field Descriptions	37
1-23.	CPU Clock Domain Idle Requirements	37
1-24.	Peripheral Clock Gating Configuration Register 1 (PCGCR1) Field Descriptions	39
1-25.	Peripheral Clock Gating Configuration Register 2 (PCGCR2) Field Descriptions	41
1-26.	Peripheral Clock Stop Request/Acknowledge Register (CLKSTOP) Field Descriptions.....	42
1-27.	USB System Control Register (USBSCR) Field Descriptions	44
1-28.	RTC Power Management Register (RTCPMGT) Field Descriptions	46
1-29.	RTC Interrupt Flag Register (RTCINTFL) Field Descriptions.....	47
1-30.	On-Chip Memory Standby Modes.....	48
1-31.	Power Configurations	50
1-32.	Interrupt Table	53
1-33.	IFR0 and IER0 Bit Descriptions	54
1-34.	IFR1 and IER1 Bit Descriptions	55
1-35.	Die ID Registers	57
1-36.	Die ID Register 0 (DIEIDR0) Field Descriptions.....	58
1-37.	Die ID Register 1 (DIEIDR1) Field Descriptions.....	58
1-38.	Die ID Register 2 (DIEIDR2) Field Descriptions.....	58
1-39.	Die ID Register 3 (DIEIDR3[15:0]) Field Descriptions	59
1-40.	Die ID Register 4 (DIEIDR4) Field Descriptions.....	59
1-41.	Die ID Register 5 (DIEIDR5) Field Descriptions.....	59
1-42.	Die ID Register 6 (DIEIDR6) Field Descriptions.....	60
1-43.	Die ID Register 7 (DIEIDR7) Field Descriptions.....	60
1-44.	EBSR Register Bit Descriptions Field Descriptions	62
1-45.	RTCPMGT Register Bit Descriptions Field Descriptions	64
1-46.	LDOCNTL Register Bit Descriptions Field Descriptions.....	65
1-47.	LDO Controls Matrix	65

1-48. Output Slew Rate Control Register (OSRCR) Field Descriptions	66
1-49. Pull-Down Inhibit Register 1 (PDINHIBR1) Field Descriptions	67
1-50. Pull-Down Inhibit Register 2 (PDINHIBR2) Field Descriptions	68
1-51. Pull-Down Inhibit Register 3 (PDINHIBR3) Field Descriptions	69
1-52. Channel Synchronization Events for DMA Controllers	71
1-53. System Registers Related to the DMA Controllers	71
1-54. DMA Interrupt Flag Register (DMAIFR) Field Descriptions	72
1-55. DMA Interrupt Enable Register (DMAIER) Field Descriptions.....	72
1-56. DMA _n Channel Event Source Register 1 (DMA _n CESR1) Field Descriptions	73
1-57. DMA _n Channel Event Source Register 2 (DMA _n CESR2) Field Descriptions	73
1-58. Peripheral Software Reset Counter Register (PSRCR) Field Descriptions.....	74
1-59. Peripheral Reset Control Register (PRCR) Field Descriptions	74
1-60. Effect of BYTEMODE Bits on EMIF Accesses	76
1-61. Effect of USBSCR BYTEMODE Bits on USB Access	76
1-62. EMIF System Control Register (ESCR) Field Descriptions	76
1-63. EMIF Clock Divider Register (ECCR) Field Descriptions	77

Read This First

About This Manual

This document describes various aspects of the TMS320C5515 digital signal processor (DSP) including: system memory, device clocking options and operation of the DSP clock generator, power management features, interrupts, and system control.

Notational Conventions

This document uses the following conventions.

- Hexadecimal numbers are shown with the suffix h. For example, the following number is 40 hexadecimal (decimal 64): 40h.
- Registers in this document are shown in figures and described in tables.
 - Each register figure shows a rectangle divided into fields that represent the fields of the register. Each field is labeled with its bit name, its beginning and ending bit numbers above, and its read/write properties below. A legend explains the notation used for the properties.
 - Reserved bits in a register figure designate a bit that is used for future device expansion.

Related Documentation From Texas Instruments

The following documents describe the TMS320C5515/14/05/04 Digital Signal Processor (DSP) Digital Signal Processor (DSP). Copies of these documents are available on the internet at <http://www.ti.com>.

[SWPU073](#) — TMS320C55x 3.0 CPU Reference Guide. This manual describes the architecture, registers, and operation of the fixed-point TMS320C55x digital signal processor (DSP) CPU.

[SPRU652](#) — TMS320C55x DSP CPU Programmer's Reference Supplement. This document describes functional exceptions to the CPU behavior.

[SPRUFO1A](#) — TMS320C5515/14/05/04/VC05/VC04 Digital Signal Processor (DSP) Inter-Integrated Circuit (I2C) Peripheral User's Guide. This document describes the inter-integrated circuit (I2C) peripheral in the TMS320C5515/14/05/04/VC05/VC04 Digital Signal Processor (DSP) devices. The I2C peripheral provides an interface between the device and other devices compliant with Phillips Semiconductors Inter-IC bus (I2C-bus) specification version 2.1 and connected by way of an I2C-bus. This document assumes the reader is familiar with the I2C-bus specification.

[SPRUFO2](#) — TMS320C5515/14/05/04/VC05/VC04 Digital Signal Processor (DSP) Timer/Watchdog Timer User's Guide. This document provides an overview of the three 32-bit timers in the TMS320C5515/14/05/04/VC05/VC04 Digital Signal Processor (DSP) devices. The 32-bit timers of the device are software programmable timers that can be configured as general-purpose (GP) timers. Timer 2 can be configured as a GP, a Watchdog (WD), or both simultaneously.

[SPRUFO3](#) — TMS320C5515/14/05/04/VC05/VC04 Digital Signal Processor (DSP) Serial Peripheral Interface (SPI) User's Guide. This document describes the serial peripheral interface (SPI) in the TMS320C5515/14/05/04/VC05/VC04 Digital Signal Processor (DSP) devices. The SPI is a high-speed synchronous serial input/output port that allows a serial bit stream of programmed length (1 to 32 bits) to be shifted into and out of the device at a programmed bit-transfer rate. The SPI supports multi-chip operation of up to four SPI slave devices. The SPI can operate as a master device only.

- [SPRUFO4](#) — TMS320C5515/14/05/04/VC05/VC04 Digital Signal Processor (DSP) General-Purpose Input/Output (GPIO) User's Guide.** This document describes the general-purpose input/output (GPIO) on the TMS320C5515/14/05/04/VC05/VC04 digital signal processor (DSP) devices. The GPIO peripheral provides dedicated general-purpose pins that can be configured as either inputs or outputs. When configured as an input, you can detect the state of an internal register. When configured as an output you can write to an internal register to control the state driven on the output pin.
- [SPRUFO5](#) — TMS320C5515/14/05/04/VC05/VC04 Digital Signal Processor (DSP) Universal Asynchronous Receiver/Transmitter (UART) User's Guide.** This document describes the universal asynchronous receiver/transmitter (UART) peripheral in the TMS320C5515/14/05/04/VC05/VC04 Digital Signal Processor (DSP) devices. The UART performs serial-to-parallel conversions on data received from a peripheral device and parallel-to-serial conversion on data received from the CPU.
- [SPRUFP1](#) — TMS320C5515/05/VC05 Digital Signal Processor (DSP) Successive Approximation (SAR) Analog to Digital Converter (ADC) User's Guide.** This document provides an overview of the Successive Approximation (SAR) Analog to Digital Converter (ADC) on the TMS320C5515/14/05/04/VC05/VC04 Digital Signal Processor (DSP) devices. The SAR is a 10-bit ADC using a switched capacitor architecture which converts an analog input signal to a digital value.
- [SPRUFP3](#) — TMS320C5515/05/VC05 Digital Signal Processor (DSP) Liquid Crystal Display Controller (LDC) User's Guide.** This document describes the liquid crystal display controller (LDC) in the TMS320C5515/14/05/04/VC05/VC04 Digital Signal Processor (DSP) devices. The LCD controller includes a LCD Interface Display Driver (LIDD) controller.
- [SPRUFT2](#)— TMS320C5515/14/05/04 DSP Direct Memory Access (DMA) Controller User's Guide** This document describes the features and operation of the DMA controller that is available on the TMS320C5515/14/05/04 Digital Signal Processor (DSP) devices. The DMA controller is used to move data among internal memory, external memory, and peripherals without intervention from the CPU and in the background of CPU operation.
- [SPRUGU6](#)— TMS320C5515/14/05/04 DSP External Memory Interface (EMIF) User's Guide.** This document describes the operation of the external memory interface (EMIF) in the TMS320C5515/14/05/04 Digital Signal Processor (DSP) devices. The purpose of the EMIF is to provide a means to connect to a variety of external devices.
- [SPRUFO6](#)— TMS320C5515/14/05/04/VC05/VC04 DSP Multimedia Card (MMC)/Secure Digital (SD) Card Controller** This document describes the Multimedia Card (MMC)/Secure Digital (SD) Card Controller on the TMS320C5515/14/05/04 Digital Signal Processor (DSP) devices. The multimedia card (MMC)/secure digital (SD) card is used in a number of applications to provide removable data storage. The MMC/SD card controller provides an interface to external MMC and SD cards.
- [SPRUFX2](#)— TMS320C5515/14/05/04 Digital Signal Processor (DSP) Real-Time Clock (RTC) User's Guide.** This document describes the operation of the Real-Time Clock (RTC) module in the TMS320C5515/14/05/04 Digital Signal Processor (DSP) devices. The RTC also has the capability to wake-up the power management and apply power to the rest of the device through an alarm, periodic interrupt, or external WAKEUP signal.
- [SPRUFX4](#)— TMS320C5515/14/05/04 Digital Signal Processor (DSP) Inter-IC Sound (I2S) Bus User's Guide.** This document describes the features and operation of Inter-IC Sound (I2S) Bus in the TMS320C5515/14/05/04 Digital Signal Processor (DSP) devices. This peripheral allows serial transfer of full duplex streaming data, usually streaming audio, between DSP and an external I2S peripheral device such as an audio codec.
- [SPRUFX5](#)— TMS320C5515 DSP System User's Guide.** This document describes various aspects of the TMS320C5515 digital signal processor (DSP) including: system memory, device clocking options and operation of the DSP clock generator, power management features, interrupts, and system control.

- [SPRUGH5](#)**— **TMS320C5505 DSP System User's Guide.** This document describes various aspects of the TMS320C5505 digital signal processor (DSP) including: system memory, device clocking options and operation of the DSP clock generator, power management features, interrupts, and system control.
- [SPRUFX6](#)**— **TMS320C5514 DSP System User's Guide.** This document describes various aspects of the TMS320C5514 digital signal processor (DSP) including: system memory, device clocking options and operation of the DSP clock generator, power management features, interrupts, and system control.
- [SPRUGH6](#)**— **TMS320C5504 DSP System User's Guide.** This document describes various aspects of the TMS320C5504 digital signal processor (DSP) including: system memory, device clocking options and operation of the DSP clock generator, power management features, interrupts, and system control.
- [SPRUGH9](#)**— **TMS320C5515 DSP Universal Serial Bus 2.0 (USB) Controller User's Guide** This document describes the universal serial bus 2.0 (USB) in the TMS320C5515 Digital Signal Processor (DSP) devices. The USB controller supports data throughput rates up to 480 Mbps. It provides a mechanism for data transfer between USB devices.
- [SPRABB6](#)**— **FFT Implementation on the TMS320VC5505, TMS320C5505, and TMS320C5515 DSPs** This document describes FFT computation on the TMS320VC5505 and TMS320C5505/15 DSPs devices.

System Control

1.1 Introduction

The TMS320C5515 digital signal processor (DSP) contains a high-performance, low-power DSP to efficiently handle tasks required by portable audio, wireless audio devices, industrial controls, software defined radio, fingerprint biometrics, and medical applications. The C5515 DSP consists of the following primary components:

- A C55x CPU and associated memory
- FFT hardware accelerator
- Four DMA controllers and external memory interface
- Power management module
- A set of I/O peripherals that includes I2S, I2C, SPI, UART, Timers, EMIF, 10-bit SAR ADC, LCD Controller, USB 2.0

For more information on these components see the following documents:

- *TMS320C55x 3.0 CPU Reference Guide* ([SWPU073](#)).
- *TMS320C55x DSP Peripherals Overview Reference Guide* ([SPRU317](#)).

1.1.1 Block Diagram

The C5515 DSP block diagram is shown in [Figure 1-1](#).

Figure 1-1. Functional Block Diagram

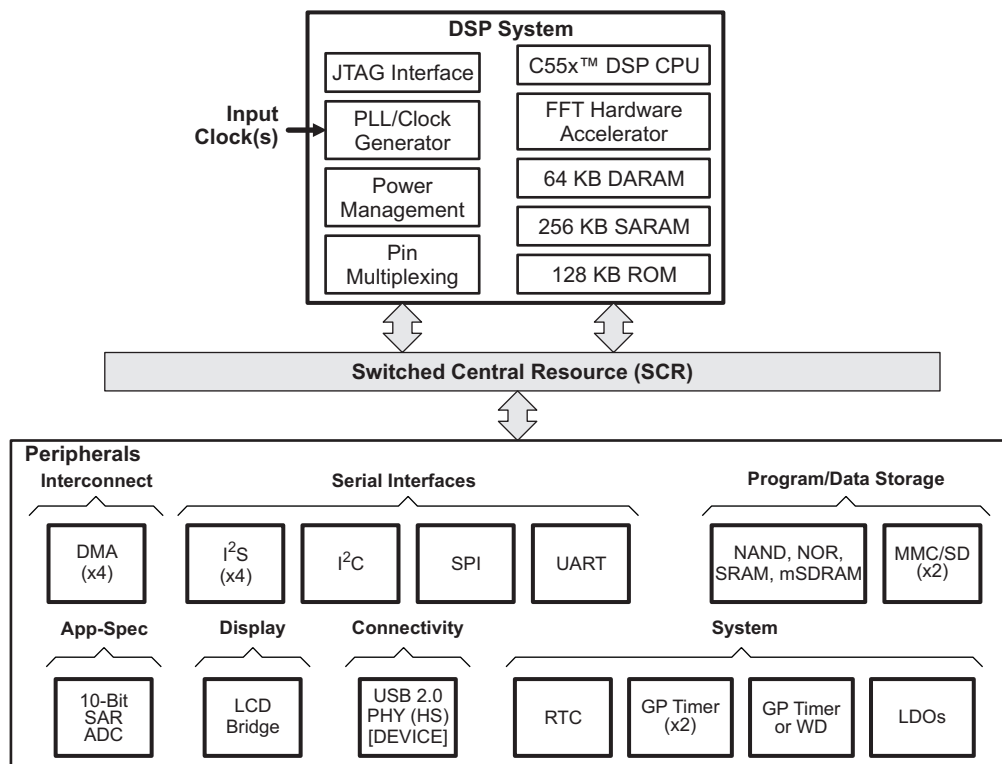

1.1.2 CPU Core

The C55x CPU is responsible for performing the digital signal processing tasks required by the application. In addition, the CPU acts as the overall system controller, responsible for handling many system functions such as system-level initialization, configuration, user interface, user command execution, connectivity functions, and overall system control.

Tightly coupled to the CPU are the following components:

- DSP internal memories
 - Dual-access RAM (DARAM)
 - Single-access RAM (SARAM)
 - Read-only memory (ROM)
- FFT hardware accelerator
- Ports and buses

The CPU also manages/controls all peripherals on the device. Refer to the device-specific data manual for the full list of peripherals.

Figure 1-1 shows the functional block diagram of the DSP and how it connects to the rest of the device. The DSP architecture uses the switched central resource (SCR) to transfer data within the system.

1.1.3 FFT Hardware Accelerator

The C55x CPU includes a tightly-coupled FFT hardware accelerator that communicates with the C55x CPU through the use coprocessor instructions. For ease of use, the ROM has a set of C-callable routines that use these coprocessor instructions to perform 8, 16, 32, 64, 128, or 256-point FFTs. The main features of the FFT hardware accelerator are:

- Support for 8 to 1024-point (in powers of 2) real and complex-valued FFTs and IFFTs.
- An internal twiddle factor generator for optimal use of memory bandwidth and more efficient programming.
- Basic and software-driven auto-scaling feature provides good precision vs cycle count trade-off.
- Single-stage and double-stage modes enabling computation of one or two stages in one pass, thus handling odd power of two FFT widths.

1.1.3.1 Using FFT Accelerator ROM routines

The C5505 includes C-callable routines in ROM to execute FFT and IFFT using the tightly coupled FFT accelerator. The routines reside in the following address:

Table 1-1.

Address	Name	Description	Calling Convention
0x00ff6cd6	hwafft br	Vector bit-reversal	void hwafft_br(Int32 *data, Int32 *data_br, Uint16 data_len);
0x00ff6cea	hwafft 8pts	8-pt FFT/IFFT	Uint16 hwafft_8pts(Int32 *data, Int32 *scratch, Uint16 fft_flag, Uint16 scale_flag);
0x00ff6dd9	hwafft 16pts	16-pt FFT/IFFT	Uint16 hwafft_16pts(Int32 *data, Int32 *scratch, Uint16 fft_flag, Uint16 scale_flag);
0x00ff6f2f	hwafft 32pts	32-pt FFT/IFFT	Uint16 hwafft_32pts(Int32 *data, Int32 *scratch, Uint16 fft_flag, Uint16 scale_flag);
0x00ff7238	hwafft 64pts	64-pt FFT/iFFT	Uint16 hwafft_64pts(Int32 *data, Int32 *scratch, Uint16 fft_flag, Uint16 scale_flag);
0x00ff73cd	hwafft 128pts	128-pt FFT/IFFT	Uint16 hwafft_128pts(Int32 *data, Int32 *scratch, Uint16 fft_flag, Uint16 scale_flag);
0x00ff75de	hwafft 256pts	256-pt FFT/IFFT	Uint16 hwafft_256pts(Int32 *data, Int32 *scratch, Uint16 fft_flag, Uint16 scale_flag);
0x00ff77dc	hwafft 512pts	512-pt FFT/iFFT	Uint16 hwafft_512pts(Int32 *data, Int32 *scratch, Uint16 fft_flag, Uint16 scale_flag);
0x00ff7a56	hwafft 1024pts	1024-pt FFT/IFFT	Uint16 hwafft_1024pts(Int32 *data, Int32 *scratch, Uint16 fft_flag, Uint16 scale_flag);

Note that for the FFT routines, output data is dependent on the return value (T0). If return = 0 output data is in-place, meaning the result will overwrite the input buffer. If return = 1, output data is placed in the scratch buffer. The 32-bit input and output data consist of 16-bit real and 16-bit imaginary data. If only real data is used, the imaginary part can be zeroed. The Scale flag determines if the butterfly output is divided by 2 to prevent overflow at the expense of resolution. For further information on how to use these routines, see *FFT Implementation on the TMS320VC5505, TMS320C5505, and TMS320C5515 DSPs* ([SPRABB6](#)).

1.1.4 Power Management

Integrated into the C5515/14 DSP are the following power management features:

- One low dropout LDO for analog portions of the device, DSP PLL (V_{DDA_PLL}), SAR, and power management circuits (V_{DDA_ANA}): ANA_LDO
- One LDO for DSP core (CV_{DD}): DSP_LDO
- One LDO for USB core and PHY (USB_V_{DDA1P3}): USB_LDO
- Idle controller with several clock domains:
 - CPU domain
 - Clock generator domain
 - Peripheral domain
 - USB domain
 - Real-time clock (RTC) domain
- Independent voltage and power domains
- LDO (LDOs and Bandgap Power Supply)
- Analog POR, SAR, and PLL (V_{DDA_ANA} and V_{DDA_PLL})
- Real-time clock core (CV_{DDRTC})
- Digital core (CV_{DD})
- USB core (USB_V_{DD1P3} and USB_V_{DDA1P3})
- USB PHY and USB PLL (USB_V_{DDOSC} , USB_V_{DDA3P3} , and USB_V_{DDPLL})
- EMIF I/O (DV_{DDEMIF})
- RTC I/O (DV_{DDRTC})
- Rest of the I/O (DV_{DDIO})

1.1.5 Peripherals

The DSP includes the following peripherals:

- Four direct memory access (DMA) controllers, each with four independent channels.
- One external memory interface (EMIF) with 21-bit address and 16-bit data. The EMIF has support for mobile SDRAM and non-mobile SDRAM single-level cell (SCL) NAND with 1-bit ECC, and multi-level cell (MLC) NAND with 4-bit ECC.

NOTE: The C5515 can support non-mobile SDRAM under certain circumstances. The C5515 always uses mobile SDRAM initialization but it is able to support SDRAM memories that ignore the BA0 and BA1 pins for the 'load mode register' command. During the mobile SDRAM initialization, the device issues the 'load mode register' initialization command to two different addresses that differ in only the BA0 and BA1 address bits. These registers are the Extended Mode register and the Mode register. The Extended mode register exists only in mSDRAM and not in non-mSDRAM. If a non-mobile SDRAM memory ignores bits BA0 and BA1, the second loaded register value overwrites the first, leaving the desired value in the Mode register and the non-mobile SDRAM will work with C5515.

- Two serial busses each configurable to support one Multimedia Card (MMC) / Secure Digital (SD/SDIO) controller, one inter-IC sound bus (I2S) interface with GPIO, or a full GPIO interface.
- One parallel bus configurable to support a 16-bit LCD bridge or a combination of an 8-bit LCD bridge, a serial peripheral interface (SPI), an I2S, a universal asynchronous receiver/transmitter (UART), and GPIO.
- One inter-integrated circuit (I2C) multi-master and slave interface with 7-bit and 10-bit addressing

modes.

- Three 32-bit timers with 16-bit prescaler; one timer supports watchdog functionality.
- A USB 2.0 slave.
- A 10-bit successive approximation (SAR) analog-to-digital converter with touchscreen conversion capability.
- One real-time clock (RTC) with associated low power mode.

1.2 System Memory

The DSP supports a unified memory map (program code sections and data sections can be mixed and interleaved within the entire memory space) composed of both on-chip and external memory. The on-chip memory consists of 320KB of RAM and 128KB of ROM.

The external memory interface (EMIF) port provides the means for the DSP to access external memory and devices including: mobile and non-mobile single data rate (SDR) SDRAM, (for limitations, see note in [Section 1.1.5](#)), NOR Flash, NAND Flash and SRAM.

Separate from the program and data space, the DSP also includes a 64K-byte I/O space for peripheral registers.

1.2.1 Program/Data Memory Map

The device provides 16MB of total address space composed of on-chip RAM, on-chip ROM, and external memory space supporting a variety of memory types. The on-chip, dual-access RAM allows two accesses to a given block during the same cycle. The device has 8 blocks of 8K-bytes of dual-access RAM. The on-chip, single-access RAM allows one access to a given block per cycle. The device has 32 blocks of 8K-bytes of single-access RAM. Attempts to perform two accesses in a cycle to single-access memory will cause one access to stall until the next cycle. An access is defined as either a read or write operation. For the most efficient use of DSP processing power (MIPS), it is important to pay attention to the memory blocks that are being simultaneously accessed by the code and data operations.

The external memory space is divided into five spaces. Each space has a chip select decode signal (called CS) that indicates an access to the selected space. The external memory interface (EMIF) supports access to asynchronous memories such as SRAM Flash, mobile SDRAM and SDRAM.

The DSP memory is accessible by different master modules within the DSP, including the device CPU, the four DMA controllers, and the USB. The DSP memory map as seen by these modules is illustrated in [Figure 1-2](#).

Figure 1-2. DSP Memory Map

CPU BYTE ADDRESS ^(A)	DMA/USB/LCD BYTE ADDRESS ^(A)	MEMORY BLOCKS	BLOCK SIZE
000000h	0001 0000h	MMR (Reserved) ^(B)	
0000C0h	0001 00C0h	DARAM ^(D)	64K Minus 192 Bytes
010000h	0009 0000h	SARAM	256K Bytes
050000h	0100 0000h	External-CS0 Space ^{(C)(E)}	8M Minus 320K Bytes SDRAM/mSDRAM
800000h	0200 0000h	External-CS2 Space ^(C)	4M Bytes Asynchronous
C00000h	0300 0000h	External-CS3 Space ^(C)	2M Bytes Asynchronous
E00000h	0400 0000h	External-CS4 Space ^(C)	1M Bytes Asynchronous
F00000h	0500 0000h	External-CS5 Space ^(C)	1M Minus 128K Bytes Asynchronous
FE0000h	050E 0000h	ROM (if MPNMC=0)	128K Bytes Asynchronous (if MPNMC=1)
FFFFFFh	050F FFFFh	External-CS5 Space ^(C) (if MPNMC=1)	128K Bytes ROM (if MPNMC=0)

- A Address shown represents the first byte address in each block.
- B The first 192 bytes are reserved for memory-mapped registers (MMRs).
- C Out of the four DMA controllers, *only* DMA controller 3 has access to the external memory space.
- D The USB controller does not have access to DARAM.
- E The CS0 space can be accessed by CS0 *only* or by CS0 *and* CS1.

1.2.1.1 On-Chip Dual-Access RAM (DARAM)

The DARAM is located in the CPU byte address range 00 00C0h - 00 FFFFh and is composed of eight blocks of 4K words each (see Table 1-2). Each DARAM block can perform two accesses per cycle (two reads, two writes, or a read and a write). DARAM can be accessed by the internal program, data, and DMA buses.

As shown in Table 1-2, the DMA controllers access DARAM at an address offset 0x0001_0000 from the CPU memory byte address space.

Table 1-2. DARAM Blocks

Memory Block	CPU Byte Address Range	DMA/USB Controller Byte Address Range
DARAM 0 ⁽¹⁾	00 00C0h - 00 1FFFh	0001 00C0h - 0001 1FFFh
DARAM 1	00 2000h - 00 3FFFh	0001 2000h - 0001 3FFFh
DARAM 2	00 4000h - 00 5FFFh	0001 4000h - 0001 5FFFh
DARAM 3	00 6000h - 00 7FFFh	0001 6000h - 0001 7FFFh
DARAM 4	00 8000h - 00 9FFFh	0001 8000h - 0001 9FFFh
DARAM 5	00 A000h - 00 BFFFh	0001 A000h - 0001 BFFFh

⁽¹⁾ First 192 bytes are reserved for memory-mapped registers (MMRs).

Table 1-2. DARAM Blocks (continued)

Memory Block	CPU Byte Address Range	DMA/USB Controller Byte Address Range
DARAM 6	00 C000h - 00 DFFFh	0001 C000h - 0001 DFFFh
DARAM 7	00 E000h - 00 FFFFh	0001 E000h - 0001 FFFFh

1.2.1.2 On-Chip Single-Access RAM (SARAM)

The SARAM is located at the CPU byte address range 01 0000h - 04FFFFh and is composed of 32 blocks of 4K words each (see [Table 1-3](#)). Each SARAM block can perform one access per cycle (one read or one write). SARAM can be accessed by the internal program, data, and DMA buses.

As shown in [Table 1-3](#), the DMA controllers access SARAM at an address offset 0x0008_0000 from the CPU memory byte address space.

Table 1-3. SARAM Blocks

Memory Block	CPU Byte Address Range	DMA/USB Controller Byte Address Range
SARAM 0	01 0000h - 01 1FFFh	0009 0000h - 0009 1FFFh
SARAM 1	01 2000h - 01 3FFFh	0009 2000h - 0009 3FFFh
SARAM 2	01 4000h - 01 5FFFh	0009 4000h - 0009 5FFFh
SARAM 3	01 6000h - 01 7FFFh	0009 6000h - 0009 7FFFh
SARAM 4	01 8000h - 01 9FFFh	0009 8000h - 0009 9FFFh
SARAM 5	01 A000h - 01 BFFFh	0009 A000h - 0009 BFFFh
SARAM 6	01 C000h - 01 DFFFh	0009 C000h - 0009 DFFFh
SARAM 7	01 E000h - 01 FFFFh	0009 E000h - 0009 FFFFh
SARAM 8	02 0000h - 02 1FFFh	000A 0000h - 000A 1FFFh
SARAM 9	02 2000h - 02 3FFFh	000A 2000h - 000A 3FFFh
SARAM 10	02 4000h - 02 5FFFh	000A 4000h - 000A 5FFFh
SARAM 11	02 6000h - 02 7FFFh	000A 6000h - 000A 7FFFh
SARAM 12	02 8000h - 02 9FFFh	000A 8000h - 000A 9FFFh
SARAM 13	02 A000h - 02 BFFFh	000A A000h - 000A BFFFh
SARAM 14	02 C000h - 02 DFFFh	000A C000h - 000A DFFFh
SARAM 15	02 E000h - 02 FFFFh	000A E000h - 000A FFFFh
SARAM 16	03 0000h - 03 1FFFh	000B 0000h - 000B 1FFFh
SARAM 17	03 2000h - 03 3FFFh	000B 2000h - 000B 3FFFh
SARAM 18	03 4000h - 03 5FFFh	000B 4000h - 000B 5FFFh
SARAM 19	03 6000h - 03 7FFFh	000B 6000h - 000B 7FFFh
SARAM 20	03 8000h - 03 9FFFh	000B 8000h - 000B 9FFFh
SARAM 21	03 A000h - 03 BFFFh	000B A000h - 000B BFFFh
SARAM 22	03 C000h - 03 DFFFh	000B C000h - 000B DFFFh
SARAM 23	03 E000h - 03 FFFFh	000B E000h - 000B FFFFh
SARAM 24	04 0000h - 04 1FFFh	000C 0000h - 000C 1FFFh
SARAM 25	04 2000h - 04 3FFFh	000C 2000h - 000C 3FFFh
SARAM 26	04 4000h - 04 5FFFh	000C 4000h - 000C 5FFFh
SARAM 27	04 6000h - 04 7FFFh	000C 6000h - 000C 7FFFh
SARAM 28	04 8000h - 04 9FFFh	000C 8000h - 000C 9FFFh
SARAM 29	04 A000h - 04 BFFFh	000C A000h - 000C BFFFh
SARAM 30	04 C000h - 04 DFFFh	000C C000h - 000C DFFFh
SARAM 31	04 E000h - 04 FFFFh	000C E000h - 000C FFFFh

1.2.1.3 On-Chip Single-Access Read-Only Memory (SAROM)

The zero-wait-state ROM is located at the CPU byte address range FE 0000h - FF FFFFh. The ROM is composed of four 16K-word blocks, for a total of 128K-bytes of ROM. Each ROM block can perform one access per cycle (one read or one write). ROM can be accessed by the internal program or data buses, but not the DMA buses. The ROM address space can be mapped by software to the external memory or to the internal ROM via the MPNMC bit in the ST3 status register.

The standard device includes a Bootloader program resident in the ROM and the bootloader code is executed immediately after hardware reset. When the MPNMC bit field of the ST3 status register is set through software, the on-chip ROM is disabled and not present in the memory map, and byte address range FE 0000h - FF FFFFh is directed to external memory space (extends CS5 address reach). A hardware reset always clears the MPNMC bit, so it is not possible to disable the ROM at hardware reset. However, the software reset instruction does not affect the MPNMC bit. The ROM can be accessed by the program and data buses. Each SAROM block can perform one word read access per cycle.

Table 1-4. SAROM Blocks

Memory Block	CPU Byte Address Range	CPU Word Address Range
SAROM0	FE 0000h - FE 7FFFh	7F 0000h - 7F 3FFFh
SAROM1	FE 8000h - FE FFFFh	7F 4000h - 7F 7FFFh
SAROM2	FF 0000h - FF 7FFFh	7F 8000h - 7F BFFFh
SAROM3	FF 8000h - FF FFFFh	7F C000h - 7F FFFFh

1.2.1.4 External Memory

The external memory space of the device is located at the byte address range 05 0000h - FF FFFFh. The external memory space is divided into five chip select spaces. The synchronous space is activated by one chip select pin (EM_CS0) or by a pair of chip selects pins (EM_CS0 and EM_CS1). Each asynchronous chip select space has a corresponding chip select pin (called EMIF_CS[2:5]) that is activated during an access to the chip select space.

The external memory interface (EMIF) provides the means for the DSP to access external memories and other devices including: NOR Flash, NAND Flash, SRAM, mSDRAM, and SDRAM (see section 1.5 for limitations). Before accessing external memory, you must configure the EMIF through its registers. For more detail on the EMIF, see the *TMS320C5515/14/05/04 DSP External Memory Interface (EMIF) User's Guide* ([SPRUGU6](#)).

As described in [Section 1.2.1.3](#), when the MPNMC bit field of the ST3 status register is cleared (default), the byte address range FE 0000h - FF FFFFh is reserved for the on-chip ROM, which decreases the addressable size for EM_CS5.

The EMIF provides a configurable 16-bit (synchronous or asynchronous) or 8-bit (asynchronous only) data bus, an address bus width of up to 21-bits, and five dedicated chip selects, along with memory control signals. To maximize power savings, the I/O pins of the EMIF can be operated at lower voltage independently of other I/O pins on the DSP. Further power savings may be achieved by setting the EMIF I/O pins to have slow slew rate, as described in [Section 1.7.3.4](#).

1.2.1.4.1 Asynchronous EMIF Interface

The EMIF provides a configurable 16- or 8-bit data bus with address bus width of up to 21-bits, and six dedicated chip selects, along with memory control signals. The cycle timings of the asynchronous interface are fully programmable, allowing for access to a wide range of devices including NAND flash, NOR flash, and SRAM as well as other asynchronous devices such as a TI DSP HPI interface. In NAND mode, the asynchronous interface supports 1-bit ECC for 8- and 16-bit NAND flash and 4-bit ECC for 8-bit NAND flash.

1.2.1.5 Synchronous EMIF Interface

The EMIF provides a 16-bit data bus with one or two dedicated chip selects for mSDRAM. Non-mobile SDRAM can be supported under certain circumstances. The C5515 always uses a mobile SDRAM initialization command sequence, but it is able to support SDRAM memories that ignore the BA0 and BA1

pins for the load mode register command. During the mobile SDRAM initialization, the device issues the load mode register initialization command to two different addresses that differ in only the BA0 and BA1 address bits. These registers are the Extended Mode register and the Mode register. The extended mode register exists only in mSDRAM, and not in non-mSDRAM. If a non-mobile SDRAM memory ignores bits BA0 and BA1, the second loaded register value overwrites the first, leaving the desired value in the mode register and the non-mobile SDRAM works with the device.

Some timing parameters are programmable such as the refresh rate and CAS latencies. The EMIF supports up to 100 MHz SDCLK and has the ability to run the SDCLK at half the system clock to meet the EMIF I/O timing requirements and/or at lower power if a slower SDCLK can be used. Detailed information is available in the *Clock Control* section of the *TMS320C5515/14/05/04 DSP External Memory Interface (EMIF) User's Guide* ([SPRUGU6](#)).

1.2.2 I/O Memory Map

The C5x DSP has a separate memory map for peripheral and system registers, called I/O space. This space is 64K-words in length and is accessed via word read and write instructions dedicated for I/O space.

Separate documentation for I/O space registers related to each peripheral exists and is listed in the preface of this guide. System registers, which provide system-level control and status, are described in detail in other sections throughout this guide. Unused addresses in I/O space should be treated as reserved and should not be accessed. Accessing unused I/O space addresses may stall or hang the DSP.

Each of the four DMA controllers has access to a different set of peripherals and their I/O space registers. This is shown in [Section 1.7.4](#).

NOTE: Writing to I/O space registers incurs in at least 2 CPU cycle latency. Thus, when configuring peripheral devices, wait at least two cycles before accessing data from the peripheral. When more than one peripheral register is updated in a sequence, the CPU only needs to wait following the final register write. For example, if the EMIF is being reconfigured, the CPU must wait until the very last EMIF register update takes effect before trying to access the external memory. The users should consult the respective peripheral user's guide to determine if a peripheral requires additional initialization time.

Before accessing any peripheral register, make sure the peripheral is not held in reset and its internal clock is enabled. The peripheral reset control register ([Section 1.7.5.2](#)) and the peripheral clock gating control registers ([Section 1.5.3.2.1](#)) control these functions. Accessing a peripheral whose clocks are gated will either return the value of the last address read from the peripheral (when the clocks were last ON) or it may possibly hang the DSP -- depending on the peripheral.

1.3 Device Clocking

1.3.1 Overview

The DSP requires two primary reference clocks: a system reference clock and a USB reference clock. The system clock, which is used by the CPU and most of the DSP peripherals, is controlled by the system clock generator. The system clock generator features a software-programmable PLL multiplier and several dividers. The system clock generator accepts an input reference clock from the CLKIN pin or the output clock of the 32.768-KHz real-time clock (RTC) oscillator. The selection of the input reference clock is based on the state of the CLK_SEL pin. The CLK_SEL pin is required to be statically tied high or low and cannot change dynamically after reset. The system clock generator can be used to modify the system reference clock signal according to software-programmable multiplier and dividers. The resulting clock output, the DSP system clock, is passed to the CPU, peripherals, and other modules inside the DSP. Alternatively, the system clock generator can be fully bypassed and the input reference clock can be passed directly to the DSP system clock. The USB reference clock is generated using a dedicated on-chip oscillator with a 12 MHz external crystal connected to the USB_MXI and USB_MXO pins. This crystal is not required if the USB peripheral is not being used. The USB oscillator cannot be used to provide the system reference clock.

The RTC oscillator generates a clock when a 32.768-KHz crystal is connected to the RTC_XI and

RTC_XO pins. RTC core (CV_{DDRTC}) must be powered all the time but the 32.768-KHz crystal can be disabled if CLKIN is used as the clock source for the DSP. However, when the RTC oscillator is disabled, the RTC peripheral will not operate and the RTC registers (I/O address range 1900h - 197Fh) will not be accessible. This includes the RTC power management register (RTCPMGT) which controls the RTCLKOUT and WAKEUP pins. To disable the RTC oscillator, connect the RTC_XI pin to CV_{DDRTC} and the RTC_XO pin to ground.

The USB oscillator is powered down at hardware reset. It must be enabled (by the NNN register) and must be allowed to settle for an amount of time specified by USB Oscillator Startup Time parameter in the device specific manual before using the USB peripheral.

[Figure 1-3](#) shows the overall DSP clock structure. For detailed specifications on clock frequency, voltage requirements, and oscillator/crystal requirements, see the device-specific data manual.

Figure 1-3. DSP Clocking Diagram

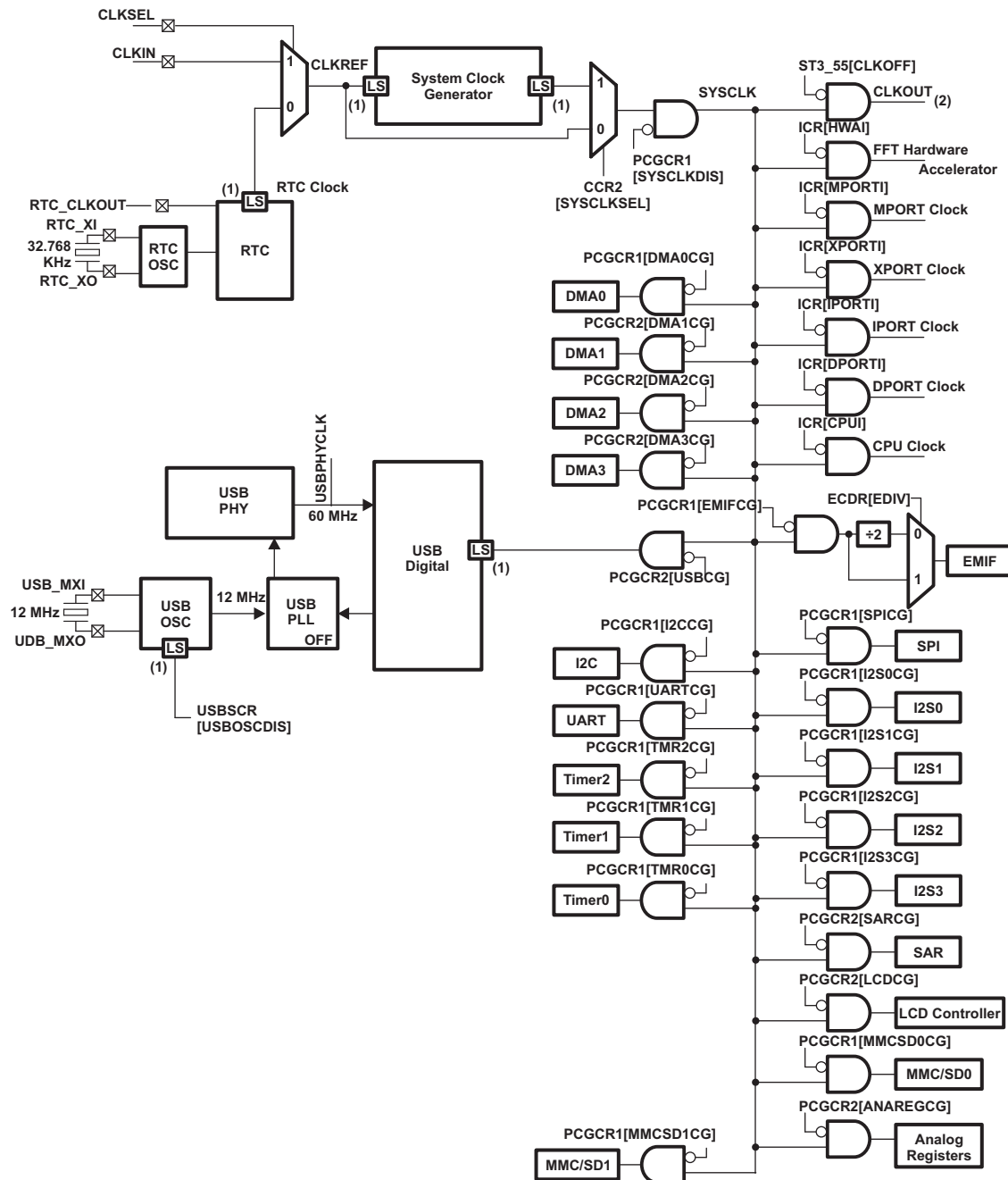

- (1) LS = Level Shifter
- (2) The CLKOUT pin's output driver is enabled/disabled through the CLKOFF bit of the CPU ST3_55 register. At the beginning of the boot sequence, the on-chip Bootloader sets CLKOFF = 1 and CLKOUT pin is disabled (high-impedance). For more information on the ST3_55 register, see the *TMS320C55x 3.0 CPU Reference Guide* ([SWPU073](#)).

1.3.2 Clock Domains

The device has many clock domains defined by individually disabled portions of the clock tree structure. Understanding the clock domains and their clock enable/disable control registers is very important for managing power and for ensuring clocks are enabled for domains that are needed. By disabling the clocks and thus the switching current in portions of the chip that are not used, lower dynamic power consumption can be achieved and prolonging battery life.

Figure 1-3 shows the clock tree structure with the clock gating represented by the AND gates. Each AND gate shows the controlling register that allows the downstream clock signal to be enabled/disabled. Once disabled most clock domains can be re-enabled, when the associated clock domain logic is needed, via software running on the CPU. But some domains actually stop the clocks to the CPU and therefore software running on the CPU cannot be responsible for re-enabling those clock domains. Other mechanism must exist for restarting those clocks, and the specific cases are listed below:

- The System Clock Generator (PLL) can be powered-down by writing a 1 to PLL_PWRDN bit in the clock generator control register CGCR1. This stops the PLL from oscillating and shuts down its analog circuits. It is important to bypass the System Clock Generator by writing 0 to SYSCLKSEL bit in CCR2 (clock configuration register 2) prior to powering it down, else the CPU will lose its clock and not be able to recover without hardware reset.

NOTE: Failsafe logic exists to prevent selecting the PLL clock if it has been powered down but this logic does not protect against powering down the PLL while it is selected as the system clock source. Therefore, software should always maintain responsibility for bypassing the PLL prior to and whenever it is powered down.

- The SYSCLKDIS bit in PCGCR1 [clock gating control register 1] is the master clock gater. Asserting this bit causes the main system clock, SYSCLK, to stop and, therefore, the CPU and all peripherals no longer receive clocks. The WAKEUP pin, INTO & INT1 pin, or RTC interrupt can be used to re-enable the clock from this condition.
- The ICR bit in CPUIC (clock gating control register) gates clocks to the CPU and uses the CPU's *idle* instruction to initiate the clock off mode. Any non-masked interrupt can be used to re-enable the CPU clocks.

1.4 System Clock Generator

1.4.1 Overview

The system clock generator (Figure 1-4) features a software-programmable PLL multiplier and several dividers. The clock generator accepts an input clock from the CLKIN pin or the output clock of the real-time clock (RTC) oscillator. The clock generator offers flexibility and convenience by way of software-configurable multiplier and divider to modify the clock rate internally. The resulting clock output, SYSCLK, is passed to the CPU, peripherals, and other modules inside the DSP.

A set of registers are provided for controlling and monitoring the activity of the clock generator. You can write to the SYSCLKSEL bit in CCR2 register to toggle between the two main modes of operation:

- In the BYPASS MODE (see Section 1.4.3.1), the entire clock generator is bypassed, and the frequency of SYSCLK is determined by CLKIN or the RTC oscillator output. Once the PLL is bypassed, the PLL can be powered down to save power.
- In the PLL MODE (see Section 1.4.3.2), the input frequency can be both multiplied and divided to produce the desired SYSCLK frequency, and the SYSCLK signal is phase-locked to the input clock signal (CLKREF).

The clock generator bypass mux (controlled by SYSCLKSEL bit in CCR2 register) is a glitchfree mux, which means that clocks will be switched cleanly and not short cycle pulses when switching among the BYPASS MODE and PLL MODE.

For debug purposes, the CLKOUT pin can be used to see different clocks within the clock generator. For details, see Section 1.4.2.3.

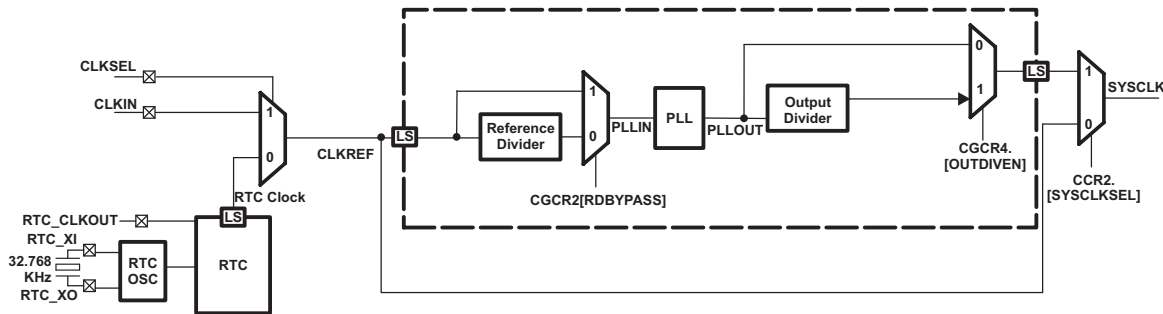
Figure 1-4. Clock Generator

1.4.2 Functional Description

The following sections describe the multiplier and dividers of the clock generator.

1.4.2.1 Multiplier and Dividers

The clock generator has a one multiplier and a two programmable dividers: one before the PLL input and one on the PLL output. The PLL can be programmed to multiply the PLL input clock, PLLIN, using a x4 to x4099 multiplier value. The reference clock divider can be programmed to divide the clock generator input clock from a /4 to /4099 divider ratio and may be bypassed. The Reference Divider and RDBYPASS mux must be programmed such that the PLLIN frequency range is 32.786 KHz to 170 KHz. At the output of the PLL, the output divider can be used to divide the PLL output clock, PLLOUT, from a /1 to a /128 divider ratio and may also be bypassed. The PLL output, PLLOUT, frequency must be programmed within the range of at least 60 MHz and no more than the maximum operating frequency defined by the datasheet, Fsysclk_max parameter. See [Table 1-10](#) for allowed values of PLLIN, PLLOUT, and SYSCLK. Keep in mind that programming the output divider with an odd divisor value other than 1 will result in a non-50% duty cycle SYSCLK. This is not a problem for any of the on-chip logic, but the non-50% duty cycle will be visible on chip pins such as EM_SDCLK (in full-rate mode) and CLKOUT. See [Table 1-10](#) for allowed values of PLLIN, PLLOUT, and SYSCLK.

The multiplier and divider ratios are controlled through the PLL control registers. The M bits define the multiplier rate. The RDRATIO and ODRATIO bits define the divide ratio of the reference divider and programmable output divider, respectively. The RDBYPASS and OUTDIVEN bits are used to enable or bypass the dividers. [Table 1-5](#) lists the formulas for the output frequency based on the setting of these bits.

The clock generator must be placed in BYPASS MODE when any PLL dividers or multipliers are changed. Then, it must remain in BYPASS MODE for at least 4 mS before switching to PLL MODE.

Table 1-5. PLL Output Frequency Configuration

RDBYPASS	OUTDIVEN	SYSCLK Frequency
0	0	$\text{CLKREF} \times \frac{(M + 4)}{\text{RDRATIO} + 4}$
0	1	$\text{CLKREF} \times \frac{(M + 4)}{\text{RDRATIO} + 4} \times \frac{1}{\text{ODRATIO} + 1}$
1	0	$\text{CLKREF} \times [M + 4]$
1	1	$\text{CLKREF} \times [M + 4] \times \frac{1}{\text{ODRATIO} + 1}$

1.4.2.2 Powering Down and Powering Up the System PLL

To save power, you can put the PLL in its power down mode. You can power down the PLL by setting the PLL_PWRDN = 1 in the clock generator control register CGCR1. However, before powering down the PLL, you must first place the clock generator in bypass mode.

When the PLL is powered up (PLL_PWRDN = 0), the PLL will start its phase-locking sequence. You must keep the clock generator in BYPASS MODE for at least 4 mS while the phase-locking sequence is ongoing. See [Section 1.4.3.2](#) for more details on the PLL_MODE of the clock generator.

1.4.2.3 CLKOUT Pin

For debug purposes, the DSP includes a CLKOUT pin which can be used to tap different clocks within the clock generator. The SRC bits of the CLKOUT control source register (CCSSR) can be used to specify the source for the CLKOUT pin (see [Figure 1-5](#) and [Table 1-6](#)).

NOTE: There is no internal logic to prevent glitches while changing the CLKOUT source. Also there is no provision for internally dividing down the CLKOUT frequency other than the options inherently available for selecting the CLKOUT source.

The CLKOUT pin's output driver is enabled/disabled through the CLKOFF bit of the CPU ST3_55 register. At hardware reset, CLKOFF is cleared to 0 so that the clock is visible for debug purposes. But within the bootloader romcode, CLKOFF is set to 1 to conserve power. After the bootloader finishes, the customer application code is free to re-enable CLKOUT. For more information on the ST3_55 register, see the *TMS320C55x 3.0 CPU Reference Guide* ([SWPU073](#)).

The slew rate (i.e., dV/dt) of the CLKOUT pin can be controlled by the CLKOUTSR bits in the output slew rate control register (OSRCR). This feature allows for additional power savings when the CLKOUT pin does not need to drive large loads.

Figure 1-5. CLKOUT Control Source Select Register (CCSSR) [1C24h]

15	4	3	0
Reserved		SRC	
R-0		R/W-Bh	

LEGEND: R/W = Read/Write; R = Read only; -n = value after reset

Table 1-6. CLKOUT Control Source Select Register (CCSSR) Field Descriptions

Bit	Field	Value	Description
15-4	Reserved	0	Reserved.
3-0	SRC	0	CLKOUT pin outputs System PLL output clock, PLLOUT.
		1h	CLKOUT pin is set high.
		2h	CLKOUT pin outputs System PLL output clock, PLLOUT.
		3h	CLKOUT pin is set low.
		4h	CLKOUT pin outputs System PLL output clock, PLLOUT.
		5h	CLKOUT pin is set low.
		6h	CLKOUT pin outputs System PLL output clock, PLLOUT.
		7h	CLKOUT pin outputs USB PLL output clock.
		8h	CLKOUT pin outputs System PLL output clock, PLLOUT.
		9h	CLKOUT pin outputs SAR clock.
		Ah	CLKOUT pin outputs System PLL output clock, PLLOUT.
		Bh	CLKOUT pin outputs system clock, SYSCLK (default mode).
		Ch	CLKOUT pin outputs System PLL output clock, PLLOUT.
		Dh	Reserved, do not use.
		Eh	CLKOUT pin outputs System PLL output clock, PLLOUT.
		Fh	CLKOUT pin outputs USB PLL output clock.

1.4.2.4 DSP Reset Conditions of the System Clock Generator

The following sections describe the operation of the system clock generator when the DSP is held in reset state and the DSP is removed from its reset state.

1.4.2.4.1 Clock Generator During Reset

During reset, the PLL_PWRDN bit of the clock generator control register 1 (CGCR1) is set to 1, and the PLL does not generate an output clock. Furthermore, the SYSCLKSEL bit of the clock configuration register 2 (CCR2) defaults to 0 (BYPASS MODE), and the system clock (SYSCLK) is driven by either the CLKIN pin or the real-time clock (RTC). See [Section 1.4.3.1](#) for more information on the bypass mode of the clock generator.

1.4.2.4.2 Clock Generator After Reset

After reset, the on-chip bootloader programs the system clock generator based on the input clock selected via the CLK_SEL pin. If CLK_SEL = 0, the bootloader programs the system clock generator and sets the system clock to 12.288 MHz (multiply the 32.768-kHz RTC oscillator clock by 375). If CLK_SEL = 1, the bootloader bypasses the system clock generator altogether and the system clock is driven by the CLKIN pin. In this case, the CLKIN frequency is expected to be 11.2896 MHz, 12.0 MHz, or 12.288 MHz. While the bootloader tries to boot from the USB, the clock generator is programmed to output approximately 36 MHz.

1.4.3 Configuration

1.4.3.1 BYPASS MODE

When the system clock generator is in the BYPASS MODE, the clock generator is not used and the system clock (SYSCLK) is driven by either the CLKIN pin or the real-time clock (RTC).

NOTE: In bypass mode, the PLL is not automatically powered down and will still consume power. For maximum power savings, the PLL should be placed in its power-down mode. See [Section 1.4.2.2](#) for more details.

1.4.3.1.1 Entering and Exiting the BYPASS MODE

To enter the bypass mode, write a 0 to the SYSCLKSEL bit in the clock configuration register 2 (CCR2). In bypass mode, the frequency of the system clock (SYSCLK) is determined by the CLK_SEL pin. If CLK_SEL = 0, SYSCLK is driven by the output of the RTC. Otherwise, SYSCLK will be driven by the CLKIN pin.

To exit the BYPASS MODE, ensure the PLL has completed its phase-locking sequence by waiting at least 4 ms and then write a 1 to the SYSCLKSEL bit. The frequency of SYSCLK will then be determined by the multiplier and divider ratios of the PLL System Clock Generator.

If the clock generator is in the PLL MODE and you want to reprogram the PLL or any of the dividers, you must set the clock generator to BYPASS MODE before changing the PLL and divider settings.

Logic within the clock generator ensures that there are no clock glitches during the transition from PLL MODE to BYPASS MODE and vice versa.

1.4.3.1.2 Register Bits Used in the BYPASS MODE

Table 1-7 describes the bits of the clock generator control registers that are used in the BYPASS MODE. For detailed descriptions of these bits, see Section 1.4.4.

Table 1-7. Clock Generator Control Register Bits Used In BYPASS MODE

Register Bit	Role in BYPASS MODE
SYCLKSEL	Allows you to switch to the PLL or BYPASS MODES.
PLL_PWRDN	Allows you to power down the PLL.

1.4.3.1.3 Setting the System Clock Frequency In the BYPASS MODE

In the BYPASS MODE, the frequency of SYCLK is determined by the CLK_SEL pin. If CLK_SEL = 0, SYCLK is driven by the output of the RTC. Otherwise, SYCLK will be driven by the CLKIN pin.

NOTE: The CLK_SEL pin must be statically tied high or low; it cannot be changed after the device has been powered up.

Table 1-8. Output Frequency in Bypass Mode

CLK_SEL	SYCLK Source / Frequency
1	CLKIN, expected to be one of the following values by the bootloader: 11.2896 MHz, 12.0MHz, or 12.288 MHz
0	RTC clock = 32.768 kHz

The state of the CLK_SEL pin is read via the CLKSELSTAT bit in the CCR2 register.

1.4.3.2 PLL MODE

In PLL MODE, the frequency of the input clock signal (CLKREF) can be both multiplied and divided to produce the desired output frequency, and the output clock signal is phase-locked to the input clock signal.

1.4.3.2.1 Entering and Exiting the PLL MODE

To enter the PLL_MODE from BYPASS_MODE, first program the PLL to the desired frequency. You must always ensure the PLL has completed its phase-locking sequence before switching to PLL MODE. This PLL has no lock indicator as such indicators are notoriously unreliable. Instead, a fixed amount of time must be allowed to expire while in BYPASS_MODE to allow the PLL to lock. After 4 msec, write a 1 to the SYCLKSEL bit in the clock configuration register 2 (CCR2) to set the system clock to the output of the PLL.

Whenever PLL needs to be reprogrammed, first the clock generator must be in bypass mode, and then changed to PLL configuration. After waiting 4 msec, write a 1 to the SYCLKSEL bit to get into the PLL MODE.

Logic within the clock generator ensures that there are no clock glitches during the transition from BYPASS MODE to PLL MODE and vice versa.

1.4.3.2.2 Register Bits Used in the PLL Mode

Table 1-9 describes the bits of the clock generator control registers that are used in the PLL MODE. For detailed descriptions of these bits, see Section 1.4.4.

Table 1-9. Clock Generator Control Register Bits Used In PLL Mode

Register Bit	Role in Bypass Mode
SYCLKSEL	Allows you to switch to the PLL or bypass modes.
RDBYPASS	Determines whether reference divider should be bypassed or used.

Table 1-9. Clock Generator Control Register Bits Used In PLL Mode (continued)

Register Bit	Role in Bypass Mode
RDRATIO	Specifies the divider ratio of the reference divider.
M	Specify the multiplier value for the PLL.
OUTDIVEN	Determines whether the output divider is bypassed.
ODRATIO	Specifies the divider ratio of the output divider.

1.4.3.2.3 Frequency Ranges for Internal Clocks

There are specific minimum and maximum frequencies for all the internal clocks. [Table 1-10](#) lists the minimum and maximum frequencies for the internal clocks for the DSP.

NOTE: For actual maximum operating frequencies, see the device-specific data sheet.

Table 1-10. PLL Clock Frequency Ranges

Clock Signal Name	CV _{DD} = 1.05 V			CV _{DD} = 1.3 V			UNIT
	MIN	NOM	MAX	MIN	NOM	MAX	
CLKIN ⁽¹⁾		11.289 6 12 12.288			11.28 96 12 12.28 8		MHz
RTC Clock		32.768			32.76 8		KHz
PLLIN	32.0		170	32.0		170	KHz
PLLOUT	60		120	60		120	MHz
SYSClk	0		60 or 75	0		100 or 120	MHz
PLL_LOCKTIME	4			4			ms

⁽¹⁾ These CLKIN values are used when the CLK_SEL pin = 1. Bootloader assumes one of these CLKIN frequencies.

1.4.3.2.4 Setting the Output Frequency for the PLL MODE

The clock generator output frequency configured based on the settings programmed in the clock generator control registers. The output frequency depends on primarily on three factors: the reference divider value, the PLL multiplier value, and the output divider value (see [Figure 1-4](#)). Based on the register settings controlling these divider and multiplier values, you can calculate the frequency of the output clock using the formulas listed in [Table 1-5](#).

Follow these steps to determine the values for the different dividers and multipliers of the system clock generator:

1. With the desired clock frequency in mind, choose a PLLOUT frequency that falls within the range listed in [Table 1-10](#). Keep in mind that you can use the programmable output divider to divide the output frequency of the PLL.
2. Determine the divider ratio for the reference divider that will generate the PLLIN frequency that meets the requirements listed in [Table 1-10](#). When possible, choose a high value for PLLIN to optimize PLL performance. If the DSP is being clocked by the RTC oscillator output, the reference divider must be bypassed (set RDBYPASS = 1); PLLIN will be 32.768 kHz.
3. Determine a multiplier value that generates the desired PLLOUT frequency given the equation: multiplier = round(PLLOUT/PLLIN).
4. Using the multiplier, figure out the values for M (PLL multiplier = M + 4).

Table 1-11 shows programming examples for different PLL MODE frequencies.

Table 1-11. Examples of Selecting a PLL MODE Frequency, When CLK_SEL=L

RDBYPASS	OUTDIVEN	M	RDRATIO	ODRATIO	PLL Output Frequency
1	0	173h	X	X	32.768KHz x (173h+4) = 12.288 MHz
1	1	E4Ah	X	2	32.768KHz x (E4Ah + 4)/3 = 40.00 MHz
1	0	723h	X	X	32.768KHz x (723h + 4) = 60.00 MHz
1	0	8EDh	X	X	32.768KHz x (8EDh + 4) = 75.01 MHz
1	0	BE8h	X	X	32.768KHz x (BE7h + 4) = 100.01 MHz
1	0	E4Ah	X	X	32.768KHz x (E4Ah + 4) = 120.00 MHz

1.4.3.2.5 Lock Time

As previously discussed, you must place the clock generator in bypass mode before changing the PLL settings. The time it takes the PLL to complete its phase-locking sequence is referred to as the lock time. The PLL has a lock time of 4 ms. Software is responsible for ensuring the PLL remains in BYPASS_MODE for at least 4 ms before switching to PLL_MODE.

1.4.3.2.6 Software Steps To Modify Multiplier and Divider Ratios

You can follow the steps below to program the PLL of the DSP clock generator. The recommendation is to stop all peripheral operation before changing the PLL frequency, with the exception of the device CPU and USB. The device CPU must be operational to program the PLL controller. Software is responsible for ensuring the PLL remains in BYPASS_MODE for at least 4 ms before switching to PLL_MODE.

1. Make sure the clock generator is in BYPASS MODE by setting SYSCLKSEL = 0.
2. Set CLR_CNTL = 0 in CGCR1.
3. Program RDRATIO, M, and RDBYPASS in CGCR2 according to your required settings.
4. Program ODRATIO and OUTDIVEN in CGCR4 according to your required settings.
5. Write 0806h to the INIT field of CGCR3.
6. Set PLL_PWRDN = 0, CLR_CNTL = 1.
7. Wait 4 ms for the PLL to complete its phase-locking sequence.
8. Place the clock generator in its PLL MODE by setting SYSCLKSEL = 1.

1.4.4 Clock Generator Registers

Table 1-12 lists the registers associated with the clock generator of the DSP. The clock generator registers can be accessed by the CPU at the 16-bit addresses specified in Table 1-12. Note that the CPU accesses all peripheral registers through its I/O space. All other register addresses not listed in Table 1-12 should be considered as reserved locations and the register contents should not be modified.

Table 1-12. Clock Generator Registers

CPU Word Address	Acronym	Register Description	Section
1C20h	CGCR1	Clock Generator Control Register 1	Section 1.4.4.1
1C21h	CGCR2	Clock Generator Control Register 2	Section 1.4.4.2
1C22h	CGCR3	Clock Generator Control Register 3	Section 1.4.4.3
1C23h	CGCR4	Clock Generator Control Register 4	Section 1.4.4.4
1C1Eh	CCR1	Clock Configuration Register 1	Section 1.4.4.5
1C1Fh	CCR2	Clock Configuration Register 2	Section 1.4.4.6

1.4.4.1 Clock Generator Control Register 1 (CGCR1) [1C20h]

The clock generator control register 1 (CGCR1) is shown in [Figure 1-6](#) and described in [Table 1-13](#).

Figure 1-6. Clock Generator Control Register 1 (CGCR1) [1C20h]

15	14	13	12	11	8
Reserved	Reserved		PLL_PWRDN	M	
R/W-0	R/W-0		R/W-1	R/W-0	
7	6	5	4	3	2
M					
R/W-0					

LEGEND: R/W = Read/Write; R = Read only; -n = value after reset

Table 1-13. Clock Generator Control Register 1 (CGCR1) Field Descriptions

Bit	Field	Value	Description
15	Reserved	0	This bit must be set to 1 for normal operation.
14-13	Reserved	0	Reserved. This bit must be always written to be zero.
12	PLL_PWRDN	0 1	PLL power down bit. This bit is used to power down the PLL when it is not being used. 0 PLL is powered up. 1 PLL is powered down.
11-0	M	0-FFFh	PLL multiplier value bits. These bits define the PLL multiplier value. Multiplier value = M + 4.

1.4.4.2 Clock Generator Control Register 2 (CGCR2) [1C21h]

The clock generator control register 2 (CGCR2) is shown in [Figure 1-7](#) and described in [Table 1-14](#).

Figure 1-7. Clock Generator Control Register 2 (CGCR2) [1C21h]

15	14	12	11	0
RDBYPASS	Reserved		RDRATIO	
R/W-0	R-0		R/W-0	

LEGEND: R/W = Read/Write; R = Read only; -n = value after reset

Table 1-14. Clock Generator Control Register 2 (CGCR2) Field Descriptions

Bit	Field	Value	Description
15	RDBYPASS	0 1	Reference divider bypass control. When this bit is set to 1 the PLL reference divider is bypassed (i.e., $F_{PLLIN} = F_{CLKREF}$). When this bit is set to 0, the reference clock to the PLL is divided by the reference divider (i.e., $F_{PLLIN} = F_{CLKIN} / (RDRATIO+4)$). The RDRATIO bits specify the divider value. 0 Use the reference divider. 1 Bypass the reference divider.
14-12	Reserved	0	Reserved.
11-0	RDRATIO	0-FFFh	Divider ratio bits for the reference divider. Divider value = RDRATIO + 4. For example, setting RDRATIO = 0 means divide the input clock rate by 4.

1.4.4.3 Clock Generator Control Register 3 (CGCR3) [1C22h]

The clock generator control register 3 (CGCR3) is shown in [Figure 1-8](#) and described in [Table 1-15](#).

Figure 1-8. Clock Generator Control Register 3 (CGCR3) [1C22h]

15	INIT	0
R/W-0806h		

LEGEND: R/W = Read/Write; -n = value after reset

Table 1-15. Clock Generator Control Register 3 (CGCR3) Field Descriptions

Bit	Field	Value	Description
15-0	INIT	0x0806h	Initialization bits for the DSP clock generator. These bits are used for testing purposes and must be initialized with 0x806 during PLL configuration for proper operation of the PLL.

1.4.4.4 Clock Generator Control Register 4 (CGCR4) [1C23h]

The clock generator control register 4 (CGCR4) is shown in [Figure 1-9](#) and described in [Table 1-16](#).

Figure 1-9. Clock Generator Control Register 4 (CGCR4) [1C23h]

15	10	9	8	7	0
Reserved		OUTDIVEN	Reserved		ODRATIO
R-0		R/W-0	R-0		R/W-0

LEGEND: R/W = Read/Write; R = Read only; -n = value after reset

Table 1-16. Clock Generator Control Register 4 (CGCR4) Field Descriptions

Bit	Field	Value	Description
15-10	Reserved	0	Reserved.
9	OUTDIVEN	0 1	Output divider enable bit. This bit determines whether the output divider of the PLL is are enabled or bypassed. The output divider is bypassed. The output divider is enabled.
8	Reserved	0	Reserved.
7-0	ODRATIO	0-FFh	Divider ratio bits for the output divider of the PLL. Divider value = ODRATIO + 1.

1.4.4.5 Clock Configuration Register 1 (CCR1) [1C1Eh]

The clock configuration register 1 (CCR1) is shown in [Figure 1-10](#) and described in [Table 1-17](#).

Figure 1-10. Clock Configuration Register 1 (CCR1) [1C1Eh]

15	1	0
Reserved	SDCLK_EN	
R-0	R/W-0	

LEGEND: R = Read only; -n = value after reset

Table 1-17. Clock Configuration Register 1 (CCR1) Field Descriptions

Bit	Field	Value	Description
15-1	Reserved	0	Reserved. This bit must be kept as 0 during writes to this register.
0	SDCLK_EN	0 1	SDRAM clock enable control. When ON, the EM_SDCLK pin will drive the clock signal at the SYSCLK frequency if in full_rate mode or at SYSCLK frequency divided by 2 if in half_rate mode. When OFF, the EM_SDCLK pin will drive low. Transitions from ON to OFF and OFF to ON are not guaranteed to be glitchless. Therefore, the EMIF should be reset after any change. EM_SDCLK off (default) EM_SDCLK on. This bit must be set to 1 before using SDRAM or mSDRAM.

1.4.4.6 Clock Configuration Register 2 (CCR2) [1C1Fh]

The clock configuration register 2 (CCR2) is shown in [Figure 1-11](#) and described in [Table 1-18](#).

Figure 1-11. Clock Configuration Register 2 (CCR2) [1C1Fh]

15	6	5	4	3	2	1	0
Reserved	SYCLKSRC	Reserved	CLKSELSTAT	Reserved	SYCLKSEL		
R-0	R-0	R/W-0	R-0	R-0	R/W-0		

LEGEND: R/W = Read/Write; R = Read only; -n = value after reset

Table 1-18. Clock Configuration Register 2 (CCR2) Field Descriptions

Bit	Field	Value	Description
15-6	Reserved	0	Reserved.
5-4	SYCLKSRC	0 1h 2h 3h	System clock source status bits. These read-only bits reflect the source for the system clock. This status register exists to indicate that switching from the PLL BYPASS_MODE to the PLL_MODE was successful or not. Logic exists on the chip to prevent switching to PLL_MODE if the PLL has its PWRDN bit already asserted. However, this circuit does not protect against asserting the PWRDN bit after already in PLL_MODE. Therefore, software must ultimately make sure not to do something that would cause the system clock to be lost. The system clock generator is in bypass mode; SYSCLK is driven by the RTC oscillator output. The system clock generator is in PLL mode; the RTC oscillator output provides the input clock. The system clock generator is in bypass mode; SYSCLK is driven by CLKIN. The system clock generator is in PLL mode; the CLKIN pin provides the input clock.
3	Reserved	0	Reserved. This bit must be written to be 0.
2	CLKSELSTAT	0 1	CLK_SEL pin status bit. This reflects the state of the CLK_SEL pin. CLK_SEL pin is low (RTC input clock selected). CLK_SEL pin is high (CLKIN input clock selected).
1	Reserved	0	Reserved. This bit must be written to be 0.
0	SYCLKSEL	0 1	System clock source select bit. This bit is used to select between the two main clocking modes for the DSP: bypass and PLL mode. In bypass mode, the DSP clock generator is bypassed and the system clock is set to either CLKIN or the RTC output (as determined by the CLKSEL pin). In PLL mode, the system clock is set to the output of the DSP clock generator. Logic in the system clock generator prevents switching from bypass mode to PLL mode if the PLL is powered down. Bypass mode is selected. PLL mode is selected.

1.5 Power Management

1.5.1 Overview

In many applications there may be specific requirements to minimize power consumption for both power supply (and battery) and thermal considerations. There are two components to power consumption: active power and leakage power. Active power is the power consumed to perform work and, for digital CMOS circuits, scales roughly with clock frequency and the amount of computations being performed. Active power can be reduced by controlling the clocks in such a way as to either operate at a clock frequency just high enough to complete the required operation in the required time-line or to run at a high enough clock frequency until the work is complete and then drastically cut the clocks (that is, to bypass mode or clock gate) until additional work must be performed.

Leakage power is due to static current leakage and occurs regardless of the clock rate. Leakage, or standby power, is unavoidable while power is applied and scales roughly with the operating junction temperatures. Leakage power can only be avoided by removing power completely.

The DSP has several means of managing the power consumption, as detailed in the following sections. There is extensive use of automatic clock gating in the design as well as software-controlled module clock gating to not only reduce the clock tree power, but to also reduce module power by freezing its state while not operating. Clock management enables you to slow the clocks down on the chip in order to reduce switching power. Independent power domains allow you to shut down parts of the DSP to reduce static power consumption. When not being used, the internal memory of the DSP can also be placed in a low leakage power mode while preserving the memory contents. The operating voltage and drive strength of the I/O pins can also be reduced to decrease I/O power consumption.

Table 1-19 summarizes all of the power management features included in the DSP.

Table 1-19. Power Management Features

Power Management Features	Description
Clock Management	
PLL power-down	The system PLL can be powered-down when not in use to reduce switching and bias power.
Peripheral clock idle	Peripheral clocks can be idled to reduce switching power.
Dynamic Power Management	
Core Voltage Scaling	The DSP LDO and DSP logic support two voltage ranges to allow voltage adjustments on-the-fly, increasing voltage during peak processing power demand and decreasing during low demand.
Static Power Management	
DARAM/SARAM low power modes	The internal memory of the DSP can be placed in a low leakage power mode while preserving memory contents.
Independent power domains	DSP Core (CV _{DD}) and USB Core (USB_V _{DD1P3} , USB_V _{DDA1P3}) can be shut off while other supplies remain powered.
I/O Management	
I/O voltage selection	The operating voltage and/or slew rate of the I/O pins can be reduced (at the expense of performance) to decrease I/O power consumption.
USB power-down	The USB peripheral can be powered-down when not being used.

1.5.2 Power Domains

The DSP has separate power domains which provide power to different portions of the device. The separate power domains allow the user to select the optimal voltage to achieve the lowest power consumption at the best possible performance. Note that several power domains have similar voltage requirements and, therefore, could be grouped under a single voltage domain.

Table 1-20. DSP Power Domains

Power Domains	Description
Real-Time Clock Power Domain (CV _{DDRTC})	This domain powers the real-time clock digital circuits and oscillator pins (RTC_XI, RTC_XO). Nominal supply voltage can be 1.05 V through 1.3 V. Note: This domain must be always powered for proper operation. This domain cannot be regulated internally, external regulation must be provided.
Core Power Domain (CV _{DD})	This domain powers the digital circuits that include the C55x CPU, on-chip memory, and peripherals. Nominal supply voltage is either 1.05 V or 1.3 V. This domain can be powered from the on-chip DSP_LDO.
Digital I/O Power Domain 1 (DV _{DDEMI})	This domain powers all I/Os, except the EMIF I/O, USB I/O, USB oscillator I/O, some of the analog related digital pins, and the real-time clock power domain I/O. Nominal supply voltage can be 1.8, 2.5, 2.75, or 3.3 V. This domain cannot be powered by internal LDOs, external regulation must be provided.
Digital I/O Power Domain 2 (DV _{DDIO})	This domain powers all EMIF I/O only. Nominal supply voltage can be 1.8, 2.5, 2.75, or 3.3 V. This domain cannot be powered by internal LDOs, external regulation must be provided.
RTC I/O Power Domain (DV _{DDRTC})	This domain powers the WAKEUP and RTC_CLKOUT pins. Nominal supply voltage can be 1.8, 2.5, 2.75, or 3.3 V. This domain cannot be powered by internal LDOs, external regulation must be provided.
PLL Power Domain (V _{DPA_PLL})	This domain powers the system clock generator PLL. Nominal supply voltage is 1.3 V. This domain can be powered from the on-chip analog LDO output pin (ANA_LDOO).
Analog Power Domain (V _{DPA_ANA})	This domain powers the power management analog circuits and the 10-bit SAR. Nominal supply voltage is 1.3 V. This domain can be powered from the on-chip analog LDO output pin (ANA_LDOO). Note: When externally powered, this domain must be always powered for proper operation.
USB Analog Power Domain (USB_V _{DDA1P3})	This domain powers the USB analog PHY. Nominal supply voltage is 1.3 V. This domain can be powered from on-chip USB_LDO output pin (USB_LDOO).
USB Digital Power Domain (USB_V _{DD1P3})	This domain powers the USB digital module. Nominal supply voltage is 1.3 V. This domain can be powered from on-chip USB_LDO output pin (USB_LDOO).
USB Oscillator Power Domain (USB_V _{DDOSC})	This domain powers the USB oscillator. Nominal supply voltage is 3.3 V. This domain cannot be powered by internal LDOs, external regulation must be provided.
USB Transceiver & Analog Power Domain (USB_V _{DDA3P3})	This domain powers the USB transceiver. Nominal supply voltage is 3.3 V. This domain cannot be powered by internal LDOs, external regulation must be provided.
USB PLL Power Domain (USB_V _{DDPLL})	This domain powers the USB PLL. Nominal supply voltage is 3.3 V. This domain cannot be powered by internal LDOs, external regulation must be provided.
LDO Power Domain (LDO)	This domain powers LDOs, POR comparator, and I/O supply for some pins. Nominal supply voltage is 1.8 V through 3.6 V. Note: This domain must be always powered for proper operation.

1.5.3 Clock Management

As mentioned in [Section 1.3.2](#), there are several clock domains within the DSP. The device supports clock gating features that allows software to disable clocks to entire clock domains or modules within a domain in order to reduce the domain's active power consumption to very-near zero (a very small amount of logic will still see a clock).

There are two distinct methods of clock gating. The first uses the ICR CPU register and the CPU's IDLE instruction. This method is used for the following domains: CPU, IPORT, DPORT, MPORT, XPORT & HWA. See [Figure 1-3](#) for a diagram of these domains. In this method, the ICR is written with a value indicating the desired clock gating configuration and then (possibly much later) the IDLE instruction is executed. The contents of the ICR do not become effective until the IDLE instruction is executed. The second method uses system registers, PCGCR1 & PCGCR2. These registers control most of the peripheral clock domains and writes to this register take effect immediately.

The SYSCLKDIS bit in PCGCR register has global effect and, therefore, is a superset of the two methods. When this bit is asserted the whole device is clock gated with the exceptions of the PLL, the USB PLL, the RTC, and the oscillators.

NOTE: Stopping clocks to a domain or a module within that domain only affects active power consumption; it does not affect leakage power consumption.

NOTE: The on-chip Bootloader idles all peripherals and CPU ports at startup, but it enables some peripherals as it uses them. Application code should not assume all peripherals and CPU ports are disabled. To get the minimum power consumption, make sure to disable all peripherals and CPU ports first and then enable only necessary peripherals and CPU ports before using them.

1.5.3.1 CPU Domain Clock Gating

Two registers are provided to individually configure and monitor the clock gating modes of the CPU domain: the idle configuration register (ICR) and the idle status register (ISTR).

ICR lets you configure how the CPU domain will respond the next time the idle instruction is executed. When you execute the idle instruction, the content of ICR is copied to ISTR. Then the ISTR values are propagated to the different portions of the CPU domain.

In the CPU domain, there are five CPU ports.

- IPORT: this port is used by the CPU for fetching instructions from external memory.
- DPORT: this port is used by the CPU when reading and writing data from/to external memory.
- XPORT: this port is used by the CPU when reading and writing from/to IO-space (peripheral) registers.
- MPORT: this port is used by the four DMAs, the USB's CDMA, and the LCD controller's DMA when accessing SARAM or DARAM.
- MPORT: this port is used by the four DMAs and the USB's CDMA when accessing SARAM or DARAM.
- HWA: this port is the hardware accelerator (FFT coprocessor). It shares all CPU buses.

1.5.3.1.1 Idle Configuration Register (ICR) [0001h] and IDLE Status Register (ISTR) [0002h]

Table 1-21 describes the read/write bits of ICR, and Table 1-22 describes the read-only bits of ISTR.

NOTE: To prevent an emulation lock up, idle requests to these domains may be overridden or ignored when an emulator is connected to the JTAG port of the DSP.

Figure 1-12. Idle Configuration Register (ICR) [0001h]

15				10				9	8
Reserved							HWAI	IPORTI	
R/W-0							R/W-0	R/W-0	
7		6	5	4			1	0	
MPORTI	XPORTI	DPORTI	IDLECFG					CPUI	
R/W-0	R/W-0	R/W-0	R/W-0					R/W-0	

LEGEND: R/W = Read/Write; -n = value after reset

Table 1-21. Idle Configuration Register (ICR) Field Descriptions

Bit	Field	Value	Description
15-10	Reserved	0	Reserved.
9	HWAI	0	FFT hardware accelerator idle control bit. Hardware accelerator remains active after execution of an IDLE instruction.
		1	Hardware accelerator is disabled after execution of an IDLE instruction.
8	IPORTI	0	Instruction port idle control bit. The IPORT is used for all external memory instruction accesses. IPORT remains active after execution of an IDLE instruction.
		1	IPORT is disabled after execution of an IDLE instruction.
7	MPORTI	0	Memory port idle control bit. The memory port is used for all DMA, LCD DMA, and USB CDMA transactions into on-chip memory. MPORT remains active after execution of an IDLE instruction.
		1	MPORT is disabled after execution of an IDLE instruction.
6	XPORTI	0	I/O port idle control bit. The XPORT is used for all CPU I/O memory transactions. XPORT remains active after execution of an IDLE instruction.
		1	XPORT is disabled after execution of an IDLE instruction.
5	DPORTI	0	Data port idle control bit. The data port is used for all CPU external memory data accesses. DPORT remains active after execution of an IDLE instruction.
		1	DPORT is disabled after execution of an IDLE instruction.
4-1	IDLECFG	0111b	Idle configuration bits. You must always set bit 1, 2 and 3 to 1 and bit 4 to 0 before executing the idle instruction.
0	CPUI	0	CPU idle control bit. CPU remains active after execution of an IDLE instruction.
		1	CPU is disabled after execution of an IDLE instruction.

Figure 1-13. Idle Status Register (ISTR) [0002h]

15				10				9		8	
Reserved								HWAIS		IPORTIS	
R-0								R-0		R-0	
7		6		5		4		1		0	
MPORTIS		XPORTIS		DPORTIS		Reserved				CPUIS	
R-0		R-0		R-0		R-0				R-0	

LEGEND: R = Read only; -n = value after reset

Table 1-22. Idle Status Register (ISTR) Field Descriptions

Bit	Field	Value	Description
15-10	Reserved	0	Reserved.
9	HWAIS	0	Hardware accelerator is active.
		1	Hardware accelerator is disabled.
8	IPORTIS	0	Instruction port idle status bit. The IPORT is used for all external memory instruction accesses. IPORT is active.
		1	IPORT is disabled.
7	MPORTIS	0	Memory port idle status bit. The memory port is used for all DMA, LCD DMA, and USB CDMA transactions into on-chip memory. MPORT is active.
		1	MPORT is disabled.
6	XPORTIS	0	I/O port idle status bit. The XPORT is used for all CPU I/O memory transactions. XPORT is active.
		1	XPORT is disabled.
5	DPORTIS	0	Data port idle status bit. The data port is used for all CPU external memory data accesses. DPORT is active.
		1	DPORT is disabled.
4-1	Reserved	0	Reserved.
0	CPUIS	0	CPU idle status bit. CPU is active.
		1	CPU is disabled.

1.5.3.1.2 Valid Idle Configurations

Not all of the values that you can write to the idle configuration register (ICR) provide valid idle configurations. The valid configurations are limited by dependencies within the system. For example, the IDLECFG bits 1, 2 and 3 of ICR must always be set to 1, and bit 4 must always be cleared to 0. As another example, the XPORT cannot be idled unless the CPU is also idled. Before any part of the CPU domain is idled, you must observe the requirements outlined in [Section 1.5.3.2](#).

A bus error will be generated (BERR = 1 in IFR1) if you execute the idle instruction under any of the following conditions and the idle command will not take effect:

1. If you fail to set IDLECFG = 0111 while setting any of these bits: DPORTI, XPORTI, IPORTI or MPORTI.
2. If you set DPORTI, XPORTI, or IPORTI without also setting CPUI.

Table 1-23. CPU Clock Domain Idle Requirements

To Idle the Following Module/Port	Requirements Before Going to Idle
CPU	No requirements.
FFT Hardware Accelerator	No requirements.
MPORT	DMA controllers, LCD, and USB CDMA must not be accessing DARAM or SARAM.

Table 1-23. CPU Clock Domain Idle Requirements (continued)

To Idle the Following Module/Port	Requirements Before Going to Idle
XPORT DPORT	CPU CPUI must also be set.

1.5.3.1.3 Clock Configuration Process

The clock configuration indicates which portions of the CPU clock domain will be idle, and which will be active. The basic steps to the clock configuration process are:

1. To idle MPORT, DMA controller, LCD DMA, and USB CDMA must not be accessing SARMA or DARAM. If any DMA is in active, wait for completion of the DMA transfer.
2. Write the desired configuration to the idle configuration register (ICR). Make sure that you use a valid idle configuration (see [Section 1.5.3.1.2](#)).
3. Apply the new idle configuration by executing the IDLE instruction. The content of ICR is copied to the idle status register (ISTR). The bits of ISTR are then propagated through the CPU domain system to enable or disable the specified clocks. If the CPU domain was idled, then program execution will stop immediately after the idle instruction. If the CPU domain was not idled, then program execution will continue past the idle instruction but the appropriate domains will be idle.

The IDLE instruction cannot be executed in parallel with another instruction.

The CPU, DPORT, XPORT, and IPORT domains are enabled automatically by any unmasked interrupts. There is a logic in the DSP core that enables CPU, DPORT, XPORT, and IPORT (clears the bits 0, 5, 6, and 8 of the ISTR register) asynchronously upon detecting an interrupt signal. Therefore, when an unmasked interrupt signal reaches the DSP core, these domains are un-idled automatically. Once the CPU is enabled, it takes 3 CPU cycles to detect the interrupt in the IFR. Note that HWA and MPORT have to be manually enabled after being disabled.

1.5.3.2 Peripheral Domain Clock Gating

The peripheral clock gating allows software to disable clocks to the DSP peripherals, in order to reduce the peripheral's active power consumption to zero. Aside from the analog logic, the DSP is designed in static CMOS; thus, when a peripheral clock stops, the peripheral's state is preserved, and no active current is consumed. When the clock is restarted the peripheral resumes operating from the stopping point.

NOTE: Stopping clocks to a peripheral only affects active power consumption; it does not affect leakage power consumption.

If a peripheral's clock is stopped while being accessed, the access may not occur completely, and could potentially lock-up the device. To avoid this issue, some peripherals have a clock stop request and acknowledge protocol that allows software to ask the peripheral when it is safe to stop the clocks. This is described further in [Section 1.5.3.2.2](#). For the peripherals that do not have the request/acknowledge protocol, the user must ensure that all of the transactions to the peripheral are finished prior to stopping the clocks.

The procedure to turn peripheral clocks on/off is described in [Section 1.5.3.2.3](#).

Some peripherals provide additional power saving features by clock gating components within its peripheral boundary. See the peripheral-specific user's guide for more details on these additional power saving features.

1.5.3.2.1 Peripheral Clock Gating Configuration Registers (PCGCR1 and PCGCR2) [1C02 - 1C03h]

The peripheral clock gating configuration registers (PCGCR1 and PCGCR2) are used to disable the clocks of the DSP peripherals. In contrast to the idle control register (ICR), these bits take effect within 6 SYSCLK cycles and do not require an idle instruction.

The peripheral clock gating configuration register 1 (PCGCR1) is shown in [Figure 1-14](#) and described in [Table 1-24](#).

Figure 1-14. Peripheral Clock Gating Configuration Register 1 (PCGCR1) [1C02h]

15	14	13	12	11	10	9	8
SYSCLOCKDIS	I2S2CG	TMR2CG	TMR1CG	EMIFCG	TMR0CG	I2S1CG	I2S0CG
R/W-0	R/W-0	R/W-0	R/W-0	R/W-0	R/W-0	R/W-0	R/W-0
7	6	5	4	3	2	1	0
MMCS1CG	I2CCG	Reserved	MMCS0CG	DMA0CG	UARTCG	SPICG	I2S3CG
R/W-0	R/W-0	R/W-0	R/W-0	R/W-0	R/W-0	R/W-0	R/W-0

LEGEND: R/W = Read/Write; R = Read only; -n = value after reset

Table 1-24. Peripheral Clock Gating Configuration Register 1 (PCGCR1) Field Descriptions

Bit	Field	Value	Description
15	SYSCLOCKDIS	0 1	System clock disable bit. This bit can be used to turn off the system clock. Setting the WAKEUP pin high enables the system clock. Since the WAKEUP pin is used to re-enable the system clock, the WAKEUP pin must be low to disable the system clock. NOTE Disabling the system clock disables the clock to most parts of the DSP, including the CPU. System clock is active. System clock is disabled.
14	I2S2CG	0 1	I2S2 clock gate control bit. This bit is used to enable and disable the I2S2 peripheral clock. Peripheral clock is active. Peripheral clock is disabled.
13	TMR2CG	0 1	Timer 2 clock gate control bit. This bit is used to enable and disable the Timer 2 peripheral clock. Peripheral clock is active. Peripheral clock is disabled.
12	TMR1CG	0 1	Timer 1 clock gate control bit. This bit is used to enable and disable the Timer 1 peripheral clock. Peripheral clock is active. Peripheral clock is disabled.
11	EMIFCG	0 1	EMIF clock gate control bit. This bit is used to enable and disable the EMIF peripheral clock. NOTE You must request permission before stopping the EMIF clock through the peripheral clock stop request/acknowledge register (CLKSTOP). Peripheral clock is active. Peripheral clock is disabled.
10	TMR0CG	0 1	Timer 0 clock gate control bit. This bit is used to enable and disable the Timer 0 peripheral clock. Peripheral clock is active. Peripheral clock is disabled.
9	I2S1CG	0 1	I2S1 clock gate control bit. This bit is used to enable and disable the I2S1 peripheral clock. Peripheral clock is active. Peripheral clock is disabled.
8	I2S0CG	0 1	I2S0 clock gate control bit. This bit is used to enable and disable the I2S0 peripheral clock. Peripheral clock is active. Peripheral clock is disabled.
7	MMCS1CG	0 1	MMC/SD1 clock gate control bit. This bit is used to enable and disable the MMC/SD1 peripheral clock. Peripheral clock is active. Peripheral clock is disabled.

Table 1-24. Peripheral Clock Gating Configuration Register 1 (PCGCR1) Field Descriptions (continued)

Bit	Field	Value	Description
6	I2CCG	0	I2C clock gate control bit. This bit is used to enable and disable the I2C peripheral clock. Peripheral clock is active.
		1	Peripheral clock is disabled.
5	Reserved	0	Reserved, you must always write 1 to this bit.
4	MMCSDOCG	0	MMC/SD0 clock gate control bit. This bit is used to enable and disable the MMC/SD0 peripheral clock. Peripheral clock is active.
		1	Peripheral clock is disabled.
3	DMA0CG	0	DMA controller 0 clock gate control bit. This bit is used to enable and disable the peripheral clock the DMA controller 0. Peripheral clock is active.
		1	Peripheral clock is disabled.
2	UARTCG	0	UART clock gate control bit. This bit is used to enable and disable the UART peripheral clock. NOTE You must request permission before stopping the UART clock through the peripheral clock stop request/acknowledge register (CLKSTOP). Peripheral clock is active.
		1	Peripheral clock is disabled.
1	SPICG	0	SPI clock gate control bit. This bit is used to enable and disable the SPI controller peripheral clock. Peripheral clock is active.
		1	Peripheral clock is disabled.
0	I2S3CG	0	I2S3 clock gate control bit. This bit is used to enable and disable the I2S3 peripheral clock. Peripheral clock is active.
		1	Peripheral clock is disabled.

The peripheral clock gating configuration register 2 (PCGCR2) is shown in [Figure 1-15](#) and described in [Table 1-25](#).

Figure 1-15. Peripheral Clock Gating Configuration Register 2 (PCGCR2) [1C03h]

15							8
Reserved							
R-0							
7	6	5	4	3	2	1	0
Reserved	ANAREGCG	DMA3CG	DMA2CG	DMA1CG	USBCG	SARCG	LCDCG
R-0	R/W-0	R/W-0	R/W-0	R/W-0	R/W-0	R/W-0	R/W-0

LEGEND: R/W = Read/Write; R = Read only; -n = value after reset

Table 1-25. Peripheral Clock Gating Configuration Register 2 (PCGCR2) Field Descriptions

Bit	Field	Value	Description
15-7	Reserved	0	Reserved.
6	ANAREGCG	0 1	Analog registers clock gate control bit. This bit is used to enable and disable the clock to the registers that control the analog domain of the device, i.e. registers in the 7000h-70FFh I/O space address range. NOTE When SARCG = 0, the clocks to the analog domain registers are enabled regardless of the ANAREGCG setting. 0 Clock is active. 1 Clock is disabled.
5	DMA3CG	0 1	DMA controller 3 clock gate control bit. This bit is used to enable and disable the DMA controller 3 peripheral clock. 0 Peripheral clock is active. 1 Peripheral clock is disabled.
4	DMA2CG	0 1	DMA controller 2 clock gate control bit. This bit is used to enable and disable the DMA controller 2 peripheral clock. 0 Peripheral clock is active. 1 Peripheral clock is disabled.
3	DMA1CG	0 1	DMA controller 1 clock gate control bit. This bit is used to enable and disable the DMA controller 1 peripheral clock. 0 Peripheral clock is active. 1 Peripheral clock is disabled.
2	USBCG	0 1	USB clock gate control bit. This bit is used to enable and disable the USB controller peripheral clock. NOTE You must request permission before stopping the USB clock through the peripheral clock stop request/acknowledge register (CLKSTOP). This register does not stop the USB PLL. 0 Peripheral clock is active. 1 Peripheral clock is disabled.
1	SARCG	0 1	SAR clock gate control bit. This bit is used to enable and disable the SAR peripheral clock. NOTE When SARCG = 0, the clock to the analog domain registers is enabled regardless of the ANAREGCG setting. 0 Peripheral clock is active. 1 Peripheral clock is disabled.
0	LCDCG	0 1	LCD controller clock gate control bit. This bit is used to enable and disable the LCD controller peripheral clock. 0 Peripheral clock is active. 1 Peripheral clock is disabled.

1.5.3.2.2 Peripheral Clock Stop Request/Acknowledge Register (CLKSTOP) [1C3Ah]

You must execute a handshaking procedure before stopping the clock to the EMIF, USB, and UART. This handshake procedure ensures that current bus transactions are completed before the clock is stopped. The peripheral clock stop request/acknowledge register (CLKSTOP) enables this handshaking mechanism.

To stop the clock to the EMIF, USB, or UART, set the corresponding clock stop request bit in the CLKSTOP register, then wait for the peripheral to set the corresponding clock stop acknowledge bit. Once this bit is set, you can idle the corresponding clock in the PCGCR1 and PCGCR2.

To enable the clock to the EMIF, USB, or UART, first enable the clock the peripheral through PCGCR1 or PCGCR2, then clear the corresponding clock stop request bit in the CLKSTOP register.

The peripheral clock stop request/acknowledge register (CLKSTOP) is shown in [Figure 1-16](#) and described in [Table 1-26](#).

Figure 1-16. Peripheral Clock Stop Request/Acknowledge Register (CLKSTOP) [1C3Ah]

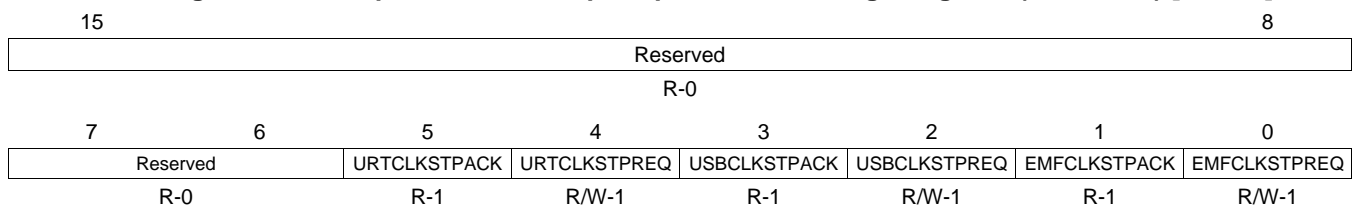

LEGEND: R/W = Read/Write; R = Read only; -n = value after reset

Table 1-26. Peripheral Clock Stop Request/Acknowledge Register (CLKSTOP) Field Descriptions

Bit	Field	Value	Description
15-6	Reserved	0	Reserved.
5	URTKLKSTPACK	0 1	UART clock stop acknowledge bit. This bit is set to 1 when the UART has acknowledged a request for its clock to be stopped. The UART clock should not be stopped until this bit is set to 1. 0 The request to stop the peripheral clock has not been acknowledged. 1 The request to stop the peripheral clock has been acknowledged, the clock can be stopped.
4	URTKLKSTPREQ	0 1	UART peripheral clock stop request bit. When disabling the UART internal peripheral clock, you must set this bit to 1 to request permission to stop the clock. After the UART acknowledges the request (URTKLKSTPACK = 1) you can stop the clock through the peripheral clock gating control register 1 (PCGCR1). When enabling the UART internal clock, enable the clock through PCGCR1, then set URTCKLSTPREQ to 0. 0 Normal operating mode. 1 Request permission to stop the peripheral clock.
3	USBCLKSTPACK	0 1	USB clock stop acknowledge bit. This bit is set to 1 when the USB has acknowledged a request for its clock to be stopped. The USB clock should not be stopped until this bit is set to 1. 0 The request to stop the peripheral clock has not been acknowledged. 1 The request to stop the peripheral clock has been acknowledged, the clock can be stopped.
2	USBCLKSTPREQ	0 1	USB peripheral clock stop request bit. When disabling the USB internal peripheral clock, you must set this bit to 1 to request permission to stop the clock. After the USB acknowledges the request (USBCLKSTPACK = 1) you can stop the clock through the peripheral clock gating control register 2 (PCGCR2). When enabling the USB internal clock, enable the clock through PCGCR2, then set USBCKLSTPREQ to 0. 0 Normal operating mode. 1 Request permission to stop the peripheral clock.

Table 1-26. Peripheral Clock Stop Request/Acknowledge Register (CLKSTOP) Field Descriptions (continued)

Bit	Field	Value	Description
1	EMFCLKSTPACK	0 1	EMIF clock stop acknowledge bit. This bit is set to 1 when the EMIF has acknowledged a request for its clock to be stopped. The EMIF clock should not be stopped until this bit is set to 1. The request to stop the peripheral clock has not been acknowledged. The request to stop the peripheral clock has been acknowledged, the clock can be stopped.
0	EMFCLKSTPREQ	0 1	EMIF peripheral clock stop request bit. When disabling the EMIF internal peripheral clock, you must set this bit to 1 to request permission to stop the clock. After the EMIF acknowledges the request (EMFCLKSTPACK = 1) you can stop the clock through the peripheral clock gating control register 1 (PCGCR1). When enabling the EMIF internal clock, enable the clock through PCGCR1, then set EMFCLKSTPREQ to 0. Normal operating mode. Request permission to stop the peripheral clock.

1.5.3.2.3 Clock Configuration Process

The clock configuration indicates which portions of the peripheral clock domain will be idle, and which will be active. The basic steps to the clock configuration process are:

1. Wait for completion of all DMA transfers. You can poll the DMA transfer status and disable DMA transfers through the DMA registers.
2. If idling the EMIF, USB, and UART clock, set the corresponding clock stop request bit in CLKSTOP.
3. Wait for confirmation from the module that its clock can be stopped by polling the clock stop acknowledge bits of CLKSTOP.
4. Set the clock configuration for the peripheral domain through PCGCR1 and PCGCR2. The clock configuration takes place as soon as you write to these registers; the idle instruction is not required

1.5.3.3 Clock Generator Domain Clock Gating

To save power, the system clock generator can be placed in its BYPASS MODE and its PLL can be placed in power down mode. When the system clock generator is in the BYPASS MODE, the clock generator is not used and the system clock (SYSCLK) is driven by either the CLKIN pin or the real-time clock (RTC). For more information entering and exiting the bypass mode of the clock generator, see [Section 1.4.3.1.1](#).

When the clock generator is placed in its bypass mode, the PLL continues to generate a clock output. You can save additional power by powering down the PLL. [Section 1.4.2.2](#) provides more information on powering down the PLL.

1.5.3.4 USB Domain Clock Gating

The USB peripheral has two clock domains. The first is a high speed domain that has its clock supplied by a dedicated USB PLL. The reference clock for the USB PLL is the 12.0 MHz USB oscillator. The clock output from the PLL must support the serial data stream that, in high-speed mode, is at a rate of 480 Mb/s. The second clock into the USB peripheral handles the data once it has been packetized and transported in parallel fashion. This clock supports all of the USB registers, CDMA, FIFO, etc., and is clocked by SYSCLK. In order to keep up with the serial data stream, the USB requires SYSCLK to be at least 30 MHz for low-speed/full-speed modes and at least 60 MHz for high-speed mode.

By stopping both of these clocks, it is possible to reduce the USB's active power consumption (in the digital logic) to zero.

NOTE: Stopping clocks to a peripheral only affects active power consumption; it does not affect leakage power consumption. USB leakage power consumption can be reduced to zero by not powering the USB.

1.5.3.4.1 Clock Configuration Process

The clock configuration process for the USB clock domain consists of disabling the USB peripheral clock followed by disabling the USB on-chip oscillator. This procedure will completely shut off USB module, which does not comply with USB suspend/resume protocol.

To set the clock configuration of the USB clock domain to idle follow these steps:

1. Set the SUSPENDM bit in FADDR register. For more information about the SUSPENDM bit, see the TMS320C5515/14/05/04 DSP Universal Serial Bus 2.0 (USB) Controller User's Guide ([SPRUGH9](#)).
2. Set the USB clock stop request bit (USBCLKSTREQ) in the CLKSTOP register to request permission to shut off the USB peripheral clock.
3. Wait until the USB acknowledges the clock stop request by polling the USB clock stop acknowledge bit (USBCLKSTPACK) in the CLKSTOP register.
4. Disable the USB peripheral clock by setting USBCG = 1 in the peripheral clock gating control register 2 (PCGCR2).
5. Disable the USB oscillator by setting USBOSCDIS = 1 in the USB system control register (USBSCR).

To enable the USB clock domain, follow these steps:

1. Enable the USB oscillator by setting USBOSCDIS = 0 in USBSCR.
2. Wait for the oscillator to stabilize. Refer to the device-specific data manual for oscillator stabilization time.
3. Enable the USB peripheral clock by setting USBCG = 0 in the peripheral clock gating control register 2 (PCGCR2).
4. Clear the USB clock stop request bit (USBCLKSTREQ) in the CLKSTOP register.
5. Clear the SUSPENDM bit in FADDR register.

1.5.3.4.2 USB System Control Register (USBSCR) [1C32h]

The USB system control register is used to disable the USB on-chip oscillator and to power-down the USB.

The USB system control register (USBSCR) is shown in [Figure 1-17](#) and described in [Table 1-27](#).

Figure 1-17. USB System Control Register (USBSCR) [1C32h]

15	14	13	12	11	8				
USBPWDN	USBSSESEND	USBVBUSDET	USBPLLEN	Reserved					
R/W-1	R/W-0	R/W-1	R/W-0	R-0					
7	6	5	4	3	2	1	0		
Reserved	USBDATPOL	Reserved	Reserved	USBOSCBIAISDIS	USBOSCDIS	BYTEMODE			
R-0	R/W-1	R-0	R-0	R/W-1	R/W-1	R/W-0			

LEGEND: R/W = Read/Write; R = Read only; -n = value after reset

Table 1-27. USB System Control Register (USBSCR) Field Descriptions

Bit	Field	Value	Description
15	USBPWDN		USB module power. Asserting USBPWDN puts the USB PHY and PLL in their lowest power state. The USB peripheral is not operational in this state.
		0	USB module is powered.
		1	USB module is powered-down.
14	USBSSESEND		USB VBUS session end comparator enable. The USB VBUS pin has two comparators that monitor the voltage level on the pin. These comparators can be disabled for power savings when not needed.
		0	USB VBUS session end comparator is disabled.
		1	USB VBUS session end comparator is enabled.

Table 1-27. USB System Control Register (USBSCR) Field Descriptions (continued)

Bit	Field	Value	Description
13	USBVBUSDET	0 1	USB VBUS detect enable. The USB VBUS pin has two comparators that monitor the voltage level on the pin. These comparators can be disabled for power savings when not needed. USB VBUS detect comparator is disabled. USB VBUS detect comparator is enabled.
12	USBPLEN	0 1	USB PLL enable. This is normally only used for test purposes. Normal USB operation. Override USB suspend end behavior and force release of PLL from suspend state.
11-7	Reserved	0	Reserved. Always write 0 to these bits.
6	USBDATPOL	0 1	USB data polarity bit. Changing this bit can be useful since the data polarity is opposite on type-A and type-B connectors. Reverse polarity on DP and DM signals. Normal polarity (normal polarity matching pin names).
5-4	Reserved	0	Reserved.
3	USBOSCBIASDIS	0 1	USB internal oscillator bias resistor disable. Internal oscillator bias resistor enabled (normal operating mode). Internal oscillator bias resistor disabled. Disabling the internal resistor is primarily for production test purposes. But it can also be used when an external oscillator bias resistor is connected between the USB_MXI and USB_MXO pins (but this is not a recommended configuration).
2	USBOSCDIS	0 1	USB oscillator disable bit. USB internal oscillator enabled. USB internal oscillator disabled. Causes the USB_MXO pin to be tristated and the oscillator's clock into the core is forced low.
1-0	BYTEMODE	0 1h 2h 3h	USB byte mode select bits. Word accesses by the CPU are allowed. Byte accesses by the CPU are allowed (high byte is selected). Byte accesses by the CPU are allowed (low byte is selected). Reserved.

1.5.3.5 RTC Domain Clock Gating

Dynamic RTC domain clock gating is not supported. Note that the RTC oscillator, and by extension the RTC domain, can be permanently disabled by not connecting a crystal and tying off the RTC oscillator pins. However, in this configuration, the RTC must still be powered and the RTC registers starting at I/O address 1900h will not be accessible. This includes the RTC Power Management Register ([RTCPMGT](#)) that provides powerdown control to the on-chip LDO and control of the WAKEUP and RTC_CLKOUT pins. See the device-specific data manual for more details on permanently disabling the RTC oscillator.

1.5.4 Static Power Management

1.5.4.1 RTC Power Management Register (RTCPMGT) [1930h]

This register enables static power management with power down and wake up register bits as described in the device-specific data sheet and, more generally, below. The RTC power management register (RTCPMGT) is shown in [Figure 1-18](#) and described in [Table 1-28](#).

Figure 1-18. RTC Power Management Register (RTCPMGT) [1930h]

15	5	4	3	2	1	0
Reserved		WU_DOUT	WU_DIR	BG_PD	LDO_PD	RTCCLKOUTEN
R-0		RW-0	RW-0	RW-0	RW-0	RW-0

LEGEND: R/W = Read/Write; R = Read only; -n = value after reset

Table 1-28. RTC Power Management Register (RTCPMGT) Field Descriptions

Bit	Field	Value	Description
15-5	Reserved	0	Reserved
4	WU_DOUT	0 1	Wakeup output, active low/Open-drain. 0 WAKEUP pin driven low. 1 WAKEUP pin driver is in high impedance.
3	WU_DIR	0 1	Wakeup pin direction control. 0 WAKEUP pin is configured as input. 1 WAKEUP pin is configured as output. NOTE: The WAKEUP pin, when configured as an input, is active high. When it is configured as an output, it is open-drain and thus it should have an external pull-up and it is active low.
2	BG_PD	0 1	Powerdown control bit for the bandgap, on-chip LDOs, and the analog POR (power on reset) comparator. This bit shuts down the on-chip LDOs (ANA_LDO, DSP_LDO, and USB_LDO), the Analog POR, and Bandgap reference. BG_PD and LDO_PD are only intended to be used when the internal LDOs supply power to the chip. If the internal LDOs are bypassed and not used then the BG_PD and LDO_PD power down mechanisms should not be used since the POR gets powered down and the POWERGOOD signal would not get generated properly. After this bit is asserted, the on-chip LDOs, Analog POR, and the Bandgap reference can only be re-enabled by the WAKEUP pin (being driven HIGH externally) or an enabled RTC alarm or an enabled RTC periodic event interrupt. Once reenabled, the Bandgap circuit takes about 100 msec to charge the external 0.1 μ F capacitor on the BG_CAP pin via the the internal resistance of approximately. 320 k Ω . 0 On-chip LDOs, Analog POR, and Bandgap reference are enabled. 1 On-chip LDOs, Analog POR, and Bandgap reference are disabled (shutdown).
1	LDO_PD	0 1	On-chip LDOs and Analog POR power down bit. This bit shuts down the on-chip LDOs (ANA_LDO, DSP_LDO, and USB_LDO) and the Analog POR. BG_PD and LDO_PD are only intended to be used when the internal LDOs supply power to the chip. If the internal LDOs are bypassed and not used then the BG_PD and LDO_PD power down mechanisms should not be used since POR gets powered down and the POWERGOOD signal is not generated properly. After this bit is asserted, the on-chip LDOs and Analog POR can only be re-enabled by the WAKEUP pin (being driven HIGH externally) or an enabled RTC alarm or an enabled RTC periodic event interrupt. This bit keeps the Bandgap reference turned on to allow a faster wake-up time with the expense power consumption of the Bandgap reference. 0 On-chip LDOs and Analog POR are enabled. 1 On-chip LDOs and Analog POR are disabled (shutdown).
0	RTCCLKOUTEN	0 1	Clock-out output enable. 0 Clock output disabled. 1 Clock output enabled.

1.5.4.2 RTC Interrupt Flag Register (RTCINTFL) [1920h]

The RTC interrupt flag register (RTCINTFL) is shown in [Figure 1-19](#) and described in [Table 1-29](#).

Figure 1-19. RTC Interrupt Flag Register (RTCINTFL) [1920h]

15	14							8
ALARMFL		Reserved						
R-0		R-0						
7	6	5	4	3	2	1	0	
Reserved		EXTFL	DAYFL	HOURFL	MINFL	SECFL	MSFL	
R-0		R-0	R-0	R-0	R-0	R-0	R-0	

LEGEND: R/W = Read/Write; R = Read only; -n = value after reset

Table 1-29. RTC Interrupt Flag Register (RTCINTFL) Field Descriptions

Bit	Field	Value	Description
15	ALARMFL	0	Indicates that an alarm interrupt has been generated. Alarm interrupt did not occur.
		1	Alarm interrupt occurred (write 1 to clear).
14-6	Reserved	0	Reserved.
5	EXTFL	0	External event (WAKEUP pin assertion) has occurred. External event interrupt has not occurred.
		1	External event interrupt occurred (write 1 to clear).
4	DAYFL	0	Day event has occurred. Periodic Day event has not occurred.
		1	Periodic Day event occurred (write 1 to clear).
3	HOURFL	0	Hour event has occurred. Periodic Hour event has not occurred.
		1	Periodic Hour event occurred (write 1 to clear).
2	MINFL	0	Minute Event has occurred. Periodic Minute event has not occurred.
		1	Periodic Minute event occurred (write 1 to clear).
1	SECFL	0	Second Event occurred. Periodic Second event has not occurred.
		1	Periodic Second event occurred (write 1 to clear).
0	MSFL	0	Millisecond event occurred. Periodic Millisecond event has not occurred.
		1	Periodic Millisecond event occurred (write 1 to clear).

1.5.4.3 Internal Memory Low Power Modes

To save power, software can place on-chip memory (DARAM or SARAM) in one of two power modes: memory retention mode and active mode. These power modes are activated through the SLPZVDD and SLPZVSS bits of the RAM Sleep Mode Control Register 1-5 ([RAMSLPMDCTRL\[1:5\]](#)). To activate memory retention mode, set SLPZVDD bit and clear SLPZVSS bit of each memory bank to be put in retention mode. The retention/active mode of each 4kW DARAM and SARAM bank is independently controllable.

When either type of memory is placed in memory retention, read and write accesses are not allowed. In memory retention mode, the memory is placed in a low power mode while maintaining its contents. The contents are retained as long as there are no access attempts to that memory. In active mode, the memory is readily accessible by the CPU, but consumes more leakage power.

For the entire duration that the memory is in retention mode, there can be no attempts to read or write to the memories address range. This includes accesses by the CPU or any DMA. If an access is attempted while in retention mode then the memory contents will be lost.

NOTE: You must wait at least 10 CPU clock cycles after taking memory out of a low power mode before initiating any read or write access.

[Table 1-30](#) summarizes the power modes for both DARAM and SARAM.

Table 1-30. On-Chip Memory Standby Modes

SLPZVDD	SLPZVSS	Mode	CV _{DD} Voltage
1	1	Active - Normal operational mode - Read and write accesses are allowed	1.05 V or 1.3 V
1	0	Retention - Low power mode - Contents are retained - No read or write access is allowed	1.05 V or 1.3 V
0	0	Memory Disabled Mode - Lowest leakage mode - Contents are lost - No read or write access is allowed	1.05 V or 1.3 V

1.5.4.3.1 RAM Sleep Mode Control Register 1 (RAMSLPMDCTRL1) [1C28h]

The RAM sleep mode control register 1 (RAMSLPMDCTRL1) is shown in [Figure 1-20](#) through [Figure 1-24](#).

Figure 1-20. RAM Sleep Mode Control Register1 [0x1C28]

15	14	13	12	11	10	9	8
DARAM7 SLPZVDD	DARAM7 SLPZVSS	DARAM6 SLPZVDD	DARAM6 SLPZVSS	DARAM5 SLPZVDD	DARAM5 SLPZVSS	DARAM4 SLPZVDD	DARAM4 SLPZVSS
R/W+1	R/W+1	R/W+1	R/W+1	R/W+1	R/W+1	R/W+1	R/W+1
7	6	5	4	3	2	1	0
DARAM3 SLPZVDD	DARAM3 SLPZVSS	DARAM2 SLPZVDD	DARAM2 SLPZVSS	DARAM1 SLPZVDD	DARAM1 SLPZVSS	DARAM0 SLPZVDD	DARAM0 SLPZVSS
R/W+1	R/W+1	R/W+1	R/W+1	R/W+1	R/W+1	R/W+1	R/W+1

LEGEND: R/W = Read/Write; R = Read only; -n = value after reset

Figure 1-21. RAM Sleep Mode Control Register2 [0x1C2A]

15	14	13	12	11	10	9	8
SARAM7 SLPZVDD	SARAM7 SLPZVSS	SARAM6 SLPZVDD	SARAM6 SLPZVSS	SARAM5 SLPZVDD	SARAM5 SLPZVSS	SARAM4 SLPZVDD	SARAM4 SLPZVSS
R/W+1	R/W+1	R/W+1	R/W+1	R/W+1	R/W+1	R/W+1	R/W+1
7	6	5	4	3	2	1	0
SARAM3 SLPZVDD	SARAM3 SLPZVSS	SARAM2 SLPZVDD	SARAM2 SLPZVSS	SARAM1 SLPZVDD	SARAM1 SLPZVSS	SARAM0 SLPZVDD	SARAM0 SLPZVSS
R/W+1	R/W+1	R/W+1	R/W+1	R/W+1	R/W+1	R/W+1	R/W+1

LEGEND: R/W = Read/Write; R = Read only; -n = value after reset

Figure 1-22. RAM Sleep Mode Control Register3 [0x1C2B]

15	14	13	12	11	10	9	8
SARAM15 SLPZVDD	SARAM15 SLPZVSS	SARAM14 SLPZVDD	SARAM14 SLPZVSS	SARAM13 SLPZVDD	SARAM13 SLPZVSS	SARAM12 SLPZVDD	SARAM12 SLPZVSS
R/W+1	R/W+1	R/W+1	R/W+1	R/W+1	R/W+1	R/W+1	R/W+1
7	6	5	4	3	2	1	0
SARAM11 SLPZVDD	SARAM11 SLPZVSS	SARAM10 SLPZVDD	SARAM10 SLPZVSS	SARAM9 SLPZVDD	SARAM9 SLPZVSS	SARAM8 SLPZVDD	SARAM8 SLPZVSS
R/W+1	R/W+1	R/W+1	R/W+1	R/W+1	R/W+1	R/W+1	R/W+1

LEGEND: R/W = Read/Write; R = Read only; -n = value after reset

Figure 1-23. RAM Sleep Mode Control Register4 [0x1C2C]

15	14	13	12	11	10	9	8
SARAM23 SLPZVDD	SARAM23 SLPZVSS	SARAM22 SLPZVDD	SARAM22 SLPZVSS	SARAM21 SLPZVDD	SARAM21 SLPZVSS	SARAM20 SLPZVDD	SARAM20 SLPZVSS
R/W+1	R/W+1	R/W+1	R/W+1	R/W+1	R/W+1	R/W+1	R/W+1
7	6	5	4	3	2	1	0
SARAM19 SLPZVDD	SARAM19 SLPZVSS	SARAM18 SLPZVDD	SARAM18 SLPZVSS	SARAM17 SLPZVDD	SARAM17 SLPZVSS	SARAM16 SLPZVDD	SARAM16 SLPZVSS
R/W+1	R/W+1	R/W+1	R/W+1	R/W+1	R/W+1	R/W+1	R/W+1

LEGEND: R/W = Read/Write; R = Read only; -n = value after reset

Figure 1-24. RAM Sleep Mode Control Register5 [0x1C2D]

15	14	13	12	11	10	9	8
SARAM31 SLPZVDD	SARAM31 SLPZVSS	SARAM30 SLPZVDD	SARAM30 SLPZVSS	SARAM29 SLPZVDD	SARAM29 SLPZVSS	SARAM28 SLPZVDD	SARAM28 SLPZVSS
R/W+1	R/W+1	R/W+1	R/W+1	R/W+1	R/W+1	R/W+1	R/W+1
7	6	5	4	3	2	1	0
SARAM27 SLPZVDD	SARAM27 SLPZVSS	SARAM26 SLPZVDD	SARAM26 SLPZVSS	SARAM25 SLPZVDD	SARAM25 SLPZVSS	SARAM24 SLPZVDD	SARAM24 SLPZVSS
R/W+1	R/W+1	R/W+1	R/W+1	R/W+1	R/W+1	R/W+1	R/W+1

LEGEND: R/W = Read/Write; R = Read only; -n = value after reset

1.5.5 Power Configurations

The power-saving features described in the previous sections, such as peripheral clock gating, and on-chip memory power down to name a few, can be combined to form a power configuration. Many different power configurations can be created by enabling and disabling different power domains and clock domains, however, this section defines some basic power configurations that may be useful. These are shown and described in [Table 1-31](#). Please note that there is no single instruction or register that can place the device in these power configurations. Instead, these power configurations are achieved by modifying multiple registers.

NOTE: Before you change the power configuration, make sure that there is a method for the device to exit the power configuration. After exiting a power configuration, your software may have to take additional steps to change the clock and power configuration for other domains.

NOTE: The on-chip Bootloader idles all peripherals and CPU ports at startup. It enables some peripherals as it uses them. Your application code should check the idle configuration of peripherals and CPU ports before using them to be sure these are not idle.

Table 1-31. Power Configurations

Power Configuration	Power Domain State	Clock Domain State	Steps to Enter Clock and Power Configuration	Available Methods for Changing/Exiting Clock and Power Configuration
RTC only mode	DV _{DDRTC} , LDO1, and CV _{DDRTC} powered all others powered-down	Only RTC clock is running	Set LDO_PD and BG_PD bits in RTCPMGT register	A. RTC interrupt B. WAKEUP pin
IDLE3	All power domains on	RTC clock domain enabled Other clock domains disabled. Clock generator domain disabled (BYPASS MODE and PLL powerdown).	Idle peripheral domain Idle CPU domain PLL in BYPASS MODE PLL powerdown Master clock disable Execute idle instruction	A. WAKEUP pin B. RTC interrupt C. External hardware interrupt (INT0 or INT1). D. Hardware Reset
IDLE2	All power domains on	RTC clock domain enabled Clock generator domain enabled (PLL_MODE) Other clock domains disabled	Idle peripheral domains Idle CPU domain Execute idle instruction	A. WAKEUP pin B. RTC interrupt C. External hardware interrupt (INT0, INT1). D. Any unmasked peripheral interrupt. E. Hardware Reset
Active	All power domains on	All clock domains enabled	Turn on all power domains Enable all clock domains	

1.5.5.1 IDLE2 Procedure

In this power configuration all the power domains are turned on, the RTC and clock generator domains are enabled, the CPU domain is disabled, and the DSP peripherals are disabled. When you enter this power configuration all CPU and peripheral activity in the DSP is stopped. Leaving the clock generator domain enabled allows the DSP to quickly exit this power configuration since there is no need to wait for power domains to turn on or for the PLL to re-lock.

Follow these steps to enter the IDLE2 power configuration:

1. Wait for completion of all DMA transfers. You can poll the DMA transfer status and disable DMA transfers through the DMA registers.
2. Disable the USB clock domain as described in [Section 1.5.3.4](#).
3. Idle all the desired peripherals in the peripheral clock domain by modifying the peripheral clock gating configuration registers (PCGCR1 and PCGCR2). See [Section 1.5.3.2](#) for more details on setting the DSP peripherals to idle mode.
4. Clear all interrupts by writing ones to the CPU interrupt flag registers (IFR0 and IFR1).
5. Enable the appropriate wake-up interrupt in the CPU interrupt enable registers (IER0 and IER1). If using the WAKEUP pin to exit this mode, configure the WAKEUP pin as input by setting WU_DIR = 1 in the RTC power management register (RTCPMGT). If using the RTC alarm or periodic interrupt as a wake-up event, the RTCINTEN bit must be set in the RTC interrupt enable register (RTCINTEN).
6. Disable the CPU domain by setting to 1 the CPUI, MPORTI, XPORTI, DPORTI, IPORTI, and CPI bits of the idle configuration register (ICR). Note that the MPORT will not go into idle mode if the USB CDMA, LCD or DMA controllers is not idled.
7. Apply the new idle configuration by executing the "IDLE" instruction. The content of ICR is copied to the idle status register (ISTR). The bits of ISTR are then propagated through the CPU domain system to enable or disable the specified clocks.

The IDLE instruction cannot be executed in parallel with another instruction.

To exit the IDLE2 power configuration, follow these steps:

1. Generate the wake-up interrupt you specified during the IDLE2 power down procedure.
2. After the interrupt is generated, the DSP will execute the interrupt service routine.
3. After exiting the interrupt service routine, code execution will resume from the point where the "IDLE" instruction was originally executed.

You can also exit the IDLE2 power configuration by generating a hardware reset. However, in this case, the DSP is completely reset and the state of the DSP before going into IDLE2 is lost.

1.5.5.2 IDLE3 Procedure

In this power configuration all the power domains are turned on, the CPU and clock generator domains are disabled, and the RTC clock domain is enabled. The DSP peripherals and the USB are also disabled in this mode. When you enter this power configuration, all CPU and peripheral activity in the DSP is stopped.

Since the clock generator domain is disabled, you must allow enough time for the PLL to re-lock before exiting this power configuration.

Follow these steps to enter the IDLE3 power configuration:

1. Wait for completion of all DMA transfers. You can poll the DMA transfer status and disable DMA transfers through the DMA registers.
2. Disable the USB clock domain as described in [Section 1.5.3.4](#).
3. Idle all the desired peripherals in the peripheral clock domain by modifying the peripheral clock gating configuration registers (PCGCR1 and PCGCR2). See [Section 1.5.3.2](#) for more details on setting the DSP peripherals to idle mode.
4. Disable the clock generator domain as described in [Section 1.5.3.3](#).
5. Clear all interrupts by writing ones to the CPU interrupt flag registers (IFR0 and IFR1).
6. Enable the appropriate wake-up interrupt in the CPU interrupt enable registers (IER0 and IER1). If using the WAKEUP pin to exit this mode, configure the WAKEUP pin as input by setting WU_DIR = 1 in the RTC power management register (RTCPMGT). If using the RTC alarm or periodic interrupt as a wake-up event, the RTCINTEN bit must be set in the RTC interrupt enable register (RTCINTEN).
7. Disable the CPU domain by setting to 1 the CPUI, MPORTI, XPORTI, DPORTI, IPORTI, and CPI bits of the idle configuration register (ICR).
8. Apply the new idle configuration by executing the IDLE instruction. The content of ICR is copied to the idle status register (ISTR). The bits of ISTR are then propagated through the CPU domain system to enable or disable the specified clocks.

The IDLE instruction cannot be executed in parallel with another instruction.

To exit the IDLE3 power configuration, follow these steps:

1. Generate the wake-up interrupt you specified during the IDLE3 power down procedure.
2. After the interrupt is generated, the DSP will execute the interrupt service routine.
3. After exiting the interrupt service routine, code execution will resume from the point where the "IDLE" instruction was originally executed.
4. Enable the clock generator domain as described in [Section 1.5.3.3](#). You can also enable the clock generator domain inside the interrupt service routine.

You can also exit the IDLE3 power configuration by generating a hardware reset, however, in this case the DSP is completely reset and the state of the DSP before going into IDLE3 is lost.

1.5.5.3 Core Voltage Scaling

When the core voltage domain (CV_{DD}) is ON, it can be set to two voltages: 1.3 V or 1.05 V (nominal). The core voltage can be reduced during periods of low processing demand and increased during high demand. Core voltage scaling can be accomplished with an external power management IC (LDO, DC-DC, etc) or with the on-chip DSP_LDO. When the core voltage is decreased (1.3 V to 1.05 V), care must be taken to ensure device stability. The following rules must be followed to maintain stability:

- When using an external PMIC (power management IC), the board designer must ensure that the 1.3 V to 1.05 V transition does not have ringing that would violate our V_{DDC} minimum rating (1.05 V - 5% = 0.998 V).
- Software must ensure that the clock speed of the device does not exceed the maximum speed of the device at the lower voltage before making the voltage transition. For example, if the device is running at 100 MHz @ 1.3 V, then the PLL must be changed to 60 MHz (for -100 parts) or 75 MHz (for -120 parts) before changing the core voltage to 1.05 V.

When the core voltage is increased (1.05 V to 1.3 V) clock speed is not an issue since the device can operate faster at the higher voltage. However, when switching from 1.05 V to 1.3 V software must allow time for the voltage transition to reach the 1.3 V range. Additionally, external regulators might produce an overshoot that must not pass the maximum operational voltage of the core supply (see the *Recommended Operating Conditions* section in device-specific data manual). Otherwise, the device will be operating out of specification. This could happen if large current draw occurs while the regulator transitions to the higher voltage.

For external PMICs, the step response varies greatly and it is up to the system designer to ensure that the ringing is maintained within the DSP's core supply high voltage operational tolerance (see the *Recommended Operating Conditions* section in device-specific data manual).

1.6 Interrupts

Vector-relative locations and priorities for all internal and external interrupts are shown in [Table 1-32](#).

Table 1-32. Interrupt Table

NAME	SOFTWARE (TRAP) EQUIVALENT	RELATIVE LOCATION (HEX BYTES) ⁽¹⁾	PRIORITY	FUNCTION
RESET	SINT0	0x0	0	Reset (hardware and software)
NMI ⁽²⁾	SINT1	0x8	1	Non-maskable interrupt
INT0	SINT2	0x10	3	External user interrupt #0
INT1	SINT3	0x18	5	External user interrupt #1
TINT	SINT4	0x20	6	Timer aggregated interrupt
PROG0	SINT5	0x28	7	Programmable transmit interrupt 0 (I2S0 transmit or MMC/SD0 interrupt)
UART	SINT6	0x30	9	UART interrupt
PROG1	SINT7	0x38	10	Programmable receive interrupt 1 (I2S0 receive or MMC/SD0 SDIO interrupt)
DMA	SINT8	0x40	11	DMA aggregated interrupt
PROG2	SINT9	0x48	13	Programmable transmit interrupt 1 (I2S1 transmit or MMC/SD1 interrupt)
-	SINT10	0x50	14	Software interrupt
PROG3	SINT11	0x58	15	Programmable receive interrupt 3 (I2S1 Receive or MMC/SD1 SDIO interrupt)
LCD	SINT12	0x60	17	LCD interrupt
SAR	SINT13	0x68	18	10-bit SAR A/D conversion or pin interrupt
XMT2	SINT14	0x70	21	I2S2 transmit interrupt
RCV2	SINT15	0x78	22	I2S2 receive interrupt
XMT3	SINT16	0x80	4	I2S3 transmit interrupt
RCV3	SINT17	0x88	8	I2S3 receive interrupt
RTC	SINT18	0x90	12	Wakeup or real-time clock interrupt
SPI	SINT19	0x98	16	SPI interrupt
USB	SINT20	0xA0	19	USB Interrupt
GPIO	SINT21	0xA8	20	GPIO aggregated interrupt
EMIF	SINT22	0xB0	23	EMIF error interrupt
I2C	SINT23	0xB8	24	I2C interrupt
BERR	SINT24	0xC0	2	Bus error interrupt
DLOG	SINT25	0xC8	25	Data log interrupt
RTOS	SINT26	0xD0	26	Real-time operating system interrupt
-	SINT27	0xD8	14	Software interrupt #27

⁽¹⁾ Absolute addresses of the interrupt vector locations are determined by the contents of the IVPD and IVPH registers. Interrupt vectors for interrupts 0-15 and 24-31 are relative to IVPD. Interrupt vectors for interrupts 16-23 are relative to IVPH.

⁽²⁾ The NMI signal is internally tied high (not asserted). However, NMI interrupt vector can be used for SINT1.

Table 1-32. Interrupt Table (continued)

NAME	SOFTWARE (TRAP) EQUIVALENT	RELATIVE LOCATION (HEX BYTES) ⁽¹⁾	PRIORITY	FUNCTION
-	SINT28	0xE0	15	Software interrupt #28
-	SINT29	0xE8	16	Software interrupt #29
-	SINT30	0xF0	17	Software interrupt #30
-	SINT31	0xF8	18	Software interrupt #31

1.6.1 IFR and IER Registers

The interrupt flag register 0 (IFR0) and interrupt enable register 0 (IER0) bit layouts are shown in [Figure 1-25](#) and described in [Table 1-33](#).

Figure 1-25. IFR0 and IER0 Bit Locations

15	14	13	12	11	10	9	8
RCV2	XMT2	SAR	LCD	PROG3	Reserved	PROG2	DMA
R/W-0	R/W-0	R/W-0	R/W-0	R/W-0	R/W-0	R/W-0	R/W-0
7	6	5	4	3	2	1	0
PROG1	UART	PROG0	TINT	INT1	INT0	Reserved	
R/W-0	R/W-0	R/W-0	R/W-0	R/W-0	R/W-0	R-0	

LEGEND: R/W = Read/Write; R = Read only; -n = value after reset

Table 1-33. IFR0 and IER0 Bit Descriptions

Bit	Field	Value	Description
15	RCV2	1-0	I2S2 receive interrupt flag/mask bit.
14	XMT2	1-0	I2S2 transmit interrupt flag/mask bit.
13	SAR	1-0	10-BIT SAR A/D conversion or pin interrupt flag/mask bit.
12	LCD	1-0	LCD interrupt bit.
11	PROG3	1-0	Programmable receive interrupt 3 flag/mask bit. This bit is used as either the I2S1 receive interrupt flag/mask bit or the MMC/SD1 SDIO interrupt flag/mask bit. The function of this bit is selected depending on the setting of the SP1MODE bit in the external bus selection register. If SP1MODE = 00b, this bit supports MMC/SD1 SDIO interrupts. If SP1MODE = 01, this bit supports I2S1 interrupts.
10	Reserved	0	Reserved. This bit should always be written with 0.
9	PROG2	1-0	Programmable transmit interrupt 2 flag/mask bit. This bit is used as either the I2S1 transmit interrupt flag/mask bit or the MMC/SD1 interrupt flag/mask bit. The function of this bit is selected depending on the setting of the SP1MODE bit in the external bus selection register. If SP1MODE = 00b, this bit supports MMC/SD1 interrupts. If SP1MODE = 01, this bit supports I2S1 interrupts.
8	DMA	1-0	DMA aggregated interrupt flag/mask bit
7	PROG1	1-0	Programmable receive interrupt 1 flag/mask bit. This bit is used as either the I2S0 receive interrupt flag/mask bit or the MMC/SD0 SDIO interrupt flag/mask bit. The function of this bit is selected depending on the setting of the SP0MODE bit in the external bus selection register. If SP0MODE = 00b, this bit supports MMC/SD0 SDIO interrupts. If SP0MODE = 01, this bit supports I2S0 interrupts.
6	UART	1-0	UART interrupt flag/mask bit
5	PROG0	1-0	Programmable transmit interrupt 0 flag/mask bit. This bit is used as either the I2S0 transmit interrupt flag/mask bit or the MMC/SD0 interrupt flag/mask bit. The function of this bit is selected depending on the setting of the SP0MODE bit in the external bus selection register. If SP0MODE = 00b, this bit supports MMC/SD0 interrupts. If SP0MODE = 01, this bit supports I2S0 interrupts.
4	TINT	1-0	Timer aggregated interrupt flag/mask bit.
3	INT1	1-0	External user interrupt #1 flag/mask bit.
2	INT0	1-0	External user interrupt #0 flag/mask bit.
1-0	Reserved	0	Reserved. This bit should always be written with 0.

The interrupt flag register (IFR1) and interrupt enable register 1 (IER1) bit layouts are shown in [Figure 1-26](#) and described in [Table 1-34](#).

Figure 1-26. IFR1 and IER1 Bit Locations

15					11		10	9	8
Reserved		R-0			RTOS		DLOG	BERR	
7		6	5	4	3	2	1	0	
I2C	EMIF	GPIO	USB	SPI	RTC	RCV3	XMT3		
R/W-0	R/W-0	R/W-0	R/W-0	R/W-0	R/W-0	R/W-0	R/W-0	R/W-0	

LEGEND: R/W = Read/Write; R = Read only; -n = value after reset

Table 1-34. IFR1 and IER1 Bit Descriptions

Bit	Field	Value	Description
15-11	Reserved	0	Reserved. This bit should always be written with 0.
10	RTOS	1-0	Real-Time operating system interrupt flag/mask bit.
9	DLOG	1-0	Data log interrupt flag/mask bit.
8	BERR	1-0	Bus error interrupt flag/mask bit.
7	I2C	1-0	I2C interrupt flag/mask bit.
6	EMIF	1-0	EMIF error interrupt flag/mask bit.
5	GPIO	1-0	GPIO aggregated interrupt flag/mask bit.
4	USB	1-0	USB interrupt flag/mask bit.
3	SPI	1-0	SPI interrupt flag/mask bit.
2	RTC	1-0	Wakeup or real-time clock interrupt flag/mask bit.
1	RCV3	1-0	I2S3 receive interrupt flag/mask bit.
0	XMT3	1-0	I2S3 transmit interrupt flag/mask bit.

1.6.2 Interrupt Timing

The interrupt signals on the external interrupts pins ($\overline{\text{INT0}}$ and $\overline{\text{INT1}}$) are detected with a synchronous negative edge detector circuit. To reliably detect the external interrupts, the interrupt signal must have at least 2 SYSCLK high followed by at least 2 SYSCLK low.

To define the minimum low pulse width in nanoseconds scale, you should take into account that the on-chip PLL of the device is software programmable and that your application may be dynamically changing the frequency of PLL. You should use the slowest frequency that will be used by your application to calculate the minimum interrupt pulse duration in nanoseconds.

When the system master clock is disabled (SYSCLKDIS = 1), the external interrupt pins ($\overline{\text{INT0}}$ and $\overline{\text{INT1}}$) will be asynchronously latched and held low while the clocks are re-enabled. Once the clocks are re-enabled, the DSP will latch the interrupt in the IFR.

1.6.3 Timer Interrupt Aggregation Flag Register (TIAFR) [1C14h]

The CPU has only one interrupt flag that is shared among the three timers. The CPU's interrupt flag is bit 4 (TINT) of the IFR0 & IER0 registers (see Figure 1-25). Since the interrupt flag is shared, software must have a means of determining which timer instance caused the interrupt. Therefore, the timer interrupt aggregation flag register (TIAFR) is a secondary flag register that serves this purpose.

The timer interrupt aggregation flag register (TIAFR) latches each timer (Timer 0, Timer 1, and Timer 2) interrupt signal when the timer counter expires. Using this register, the programmer can determine which timer generated the timer aggregated CPU interrupt signal (TINT). Each Timer flag in TIAFR needs to be cleared by the CPU with a write of 1. Note that the IFR0[TINT] bit is automatically cleared when entering the interrupt service routine (ISR). Therefore there is no need to manually clear it in the ISR. If two (or more) timers happen to interrupt simultaneously, the TIAFR register will indicate the two (or more) interrupt flags. In this case, the ISR can choose to service both timer interrupts or only one-at-a-time. If the ISR services only one of them, then it should clear only one of the TIAFR flags and upon exiting the ISR, the CPU will immediately be interrupted again to service the second timer flag. If the ISR services all of them, then it should clear all of them in the TIAFR flags and upon exiting the ISR, the CPU won't be interrupted again until a new timer interrupt comes in. For more information, see the *TMS320C5515/14/05/04/VC05/VC04 DSP Timer/Watchdog Timer User's Guide* ([SPRUFO2](#)).

1.6.4 GPIO Interrupt Enable and Aggregation Flag Registers

The CPU has only one interrupt flag that is shared among all GPIO pin interrupt signals. The CPU's interrupt flag is bit 5 (GPIO) of the IFR1 & IER1 registers (see Figure 1-26). Since the interrupt flag is shared, software must have a means of determining which GPIO pin caused the interrupt. Therefore, the GPIO interrupt aggregation flag registers (IOINTFLG1 and IOINTFLG2) are secondary flag registers that serve this purpose.

If any of the GPIO pins are configured as inputs, they can be enabled to accept external signals as interrupts using the GPIO Interrupt Enable Registers (IOINTEN1 and IOINTEN2). The GPIO Interrupt Flag Registers (IOINTFLG1 and IOINTFLG2) can be used to determine which of the 32 GPIO pins triggered the interrupt. Note that the IFR0[GPIO] bit is automatically cleared when entering the interrupt service routine (ISR). Therefore, there is no need to manually clear it in the ISR. If two (or more) GPIO pins happen to interrupt simultaneously, the IOINTFLG1/IOINTFLG2 register indicates the two (or more) interrupt flags. In this case, the ISR can choose to service both/all GPIO interrupts or only one-at-a-time. If the ISR services only one of them, then it should clear only one of the IOINTFLG1/IOINTFLG2 flags and upon exiting the ISR, the CPU is immediately interrupted again to service the others. For more information, see the *TMS320C5515/14/05/04/VC05/VC04 DSP General-Purpose Input/Output (GPIO) User's Guide* ([SPRUFO4](#)).

1.6.5 DMA Interrupt Enable and Aggregation Flag Registers

The CPU has only one interrupt flag that is shared among the 16 DMA interrupt sources. The CPU's interrupt flag is bit 8 (DMA) of the IFR0 & IER0 registers (see Figure 1-25). Since the interrupt flag is shared, software must have a means of determining which DMA instance caused the interrupt. Therefore, the DMA interrupt aggregation flag registers (DMAIFR) are secondary flag registers that serve this purpose.

Each of the four channels of a DMA controller has its own interrupt, which you can enable or disable a channel interrupt through the DMA_nCH_m bits of the DMA Interrupt Enable Register (DMAIER) (see [Section 1.7.4.2.1](#)). The interrupts from the four DMA controllers are combined into a single CPU interrupt. You can determine which DMA channel generated the interrupt by reading the bits of the DMA interrupt flag register (DMAIFR). For more information, see the *TMS320VC5505/VC5504 DSP Direct Memory Access (DMA) Controller User's Guide* ([SPRUFO9](#)).

1.7 System Configuration and Control

1.7.1 Overview

The DSP includes system-level registers for controlling, configuring, and reading status of the device. These registers are accessible by the CPU and support the following features:

- Device Identification
- Device Configuration
 - Pin multiplexing control
 - Output drive strength configuration
 - Internal pull-up and pull-down enable/disable
 - On-chip LDO control
- DMA Controller Configuration
- Peripheral Reset
- EMIF and USB Byte Access

1.7.2 Device Identification

The DSP includes a set of device ID registers that are intended for use in TI chip manufacturing, but can be used by users as a 128-bit unique ID for each device. These registers are summarized in the following table.

Table 1-35. Die ID Registers

CPU Word Address	Acronym	Register Description	Section
1C40h	DIEIDR0	Die ID Register 0	Section 1.7.2.1
1C41h	DIEIDR1	Die ID Register 1	Section 1.7.2.2
1C42h	DIEIDR2	Die ID Register 2	Section 1.7.2.3
1C43h	DIEIDR3	Die ID Register 3	Section 1.7.2.4
1C44h	DIEIDR4	Die ID Register 4	Section 1.7.2.5
1C45h	DIEIDR5	Die ID Register 5	Section 1.7.2.6
1C46h	DIEIDR6	Die ID Register 6	Section 1.7.2.7
1C47h	DIEIDR7	Die ID Register 7	Section 1.7.2.8

1.7.2.1 Die ID Register 0 (DIEIDR0) [1C40h]

The die ID register 0 (DIEIDR0) is shown in [Figure 1-27](#) and described in [Table 1-36](#).

Figure 1-27. Die ID Register 0 (DIEIDR0) [1C40h]

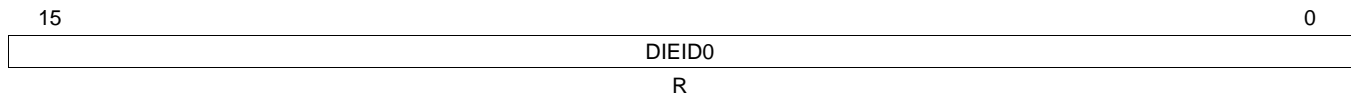

LEGEND: R = Read only; -n = value after reset

Table 1-36. Die ID Register 0 (DIEIDR0) Field Descriptions

Bit	Field	Value	Description
15-0	DIEID0	0-FFFFh	Die ID bits.

1.7.2.2 Die ID Register 1 (DIEIDR1) [1C41h]

The die ID register 1 (DIEIDR1) is shown in [Figure 1-28](#) and described in [Table 1-37](#).

Figure 1-28. Die ID Register 1 (DIEIDR1) [1C41h]

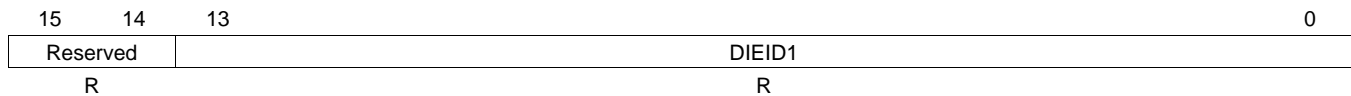

LEGEND: R = Read only; -n = value after reset

Table 1-37. Die ID Register 1 (DIEIDR1) Field Descriptions

Bit	Field	Value	Description
15-14	Reserved	0	Reserved.
13-0	DIEID1	0-3FFFh	Die ID bits.

1.7.2.3 Die ID Register 2 (DIEIDR2) [1C42h]

The die ID register 2 (DIEIDR2) is shown in [Figure 1-29](#) and described in [Table 1-38](#).

Figure 1-29. Die ID Register 2 (DIEIDR2) [1C42h]

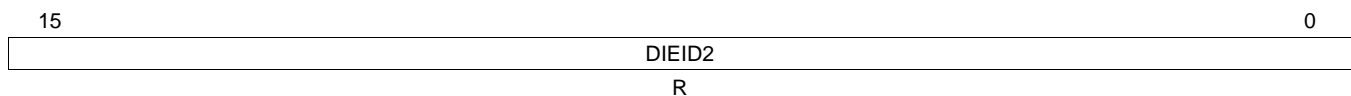

LEGEND: R = Read only; -n = value after reset

Table 1-38. Die ID Register 2 (DIEIDR2) Field Descriptions

Bit	Field	Value	Description
15-0	DIEID2	0-FFFFh	Die ID bits.

1.7.2.4 Die ID Register 3 (DIEIDR3[15:0]) [1C43h]

The die ID register 3 (DIEIDR3) is shown in [Figure 1-30](#) and described in [Table 1-39](#).

Figure 1-30. Die ID Register 3 (DIEIDR3[15:0]) [1C43h]

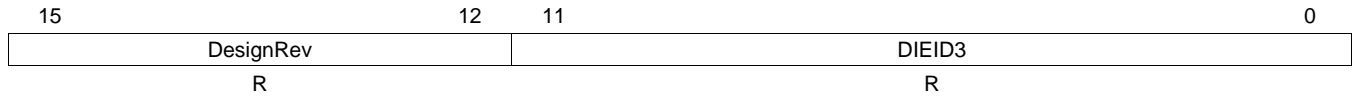

LEGEND: R = Read only; -n = value after reset

Table 1-39. Die ID Register 3 (DIEIDR3[15:0]) Field Descriptions

Bit	Field	Value	Description
15-12	DesignRev	0-Fh 0	Silicon Revision Silicon 2.0
11-0	DIEID3	0-FFFFh	Die ID bits.

1.7.2.5 Die ID Register 4 (DIEIDR4) [1C44h]

The die ID register 4 (DIEIDR4) is shown in [Figure 1-31](#) and described in [Table 1-40](#).

Figure 1-31. Die ID Register 4 (DIEIDR4) [1C44h]

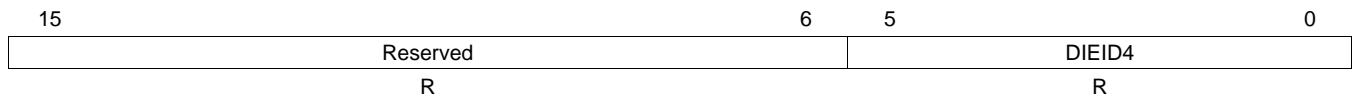

LEGEND: R = Read only; -n = value after reset

Table 1-40. Die ID Register 4 (DIEIDR4) Field Descriptions

Bit	Field	Value	Description
15-6	Reserved	0	Reserved.
5-0	DIEID4	0-3Fh	Die ID bits.

1.7.2.6 Die ID Register 5 (DIEIDR5) [1C45h]

The die ID register 5 (DIEIDR5) is shown in [Figure 1-32](#) and described in [Table 1-41](#).

Figure 1-32. Die ID Register 5 (DIEIDR5) [1C45h]

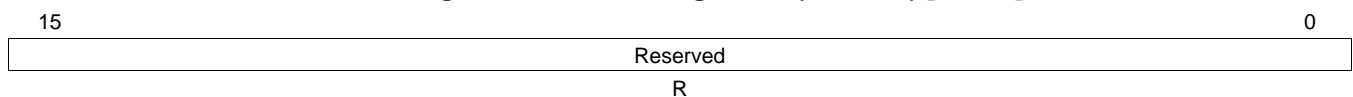

LEGEND: R = Read only; -n = value after reset

Table 1-41. Die ID Register 5 (DIEIDR5) Field Descriptions

Bit	Field	Value	Description
15-0	Reserved	0	Reserved.

1.7.2.7 Die ID Register 6 (DIEIDR6) [1C46h]

The die ID register 6 (DIEIDR6) is shown in [Figure 1-33](#) and described in [Table 1-42](#).

Figure 1-33. Die ID Register 6 (DIEIDR6) [1C46h]

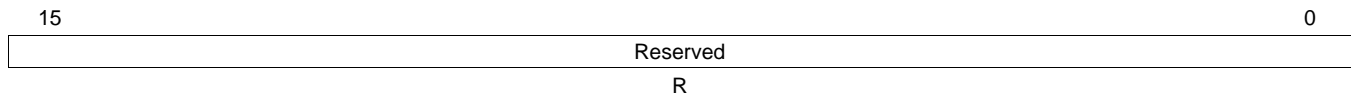

LEGEND: R = Read only; -n = value after reset

Table 1-42. Die ID Register 6 (DIEIDR6) Field Descriptions

Bit	Field	Value	Description
15-0	Reserved	0	Reserved.

1.7.2.8 Die ID Register 7 (DIEIDR7) [1C47h]

The die ID register 7 (DIEIDR7) is shown in [Figure 1-34](#) and described in [Table 1-43](#).

Figure 1-34. Die ID Register 7 (DIEIDR7) [1C47h]

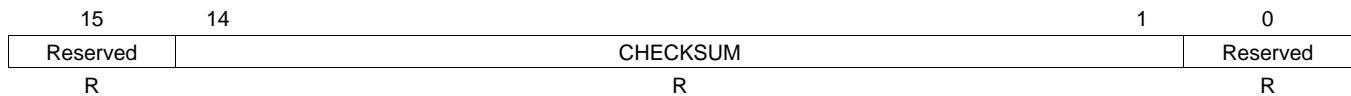

LEGEND: R = Read only; -n = value after reset

Table 1-43. Die ID Register 7 (DIEIDR7) Field Descriptions

Bit	Field	Value	Description
15	Reserved	0	Reserved.
14-1	CHECKSUM	0-3FFFh	Checksum bits.
0	Reserved	0	Reserved.

1.7.3 Device Configuration

The DSP includes registers for configuring pin multiplexing, the pin output slew rate, the internal pull-ups and pull-downs, DSP_LDO voltage selection and USB_LDO enable.

1.7.3.1 External Bus Selection Register (EBSR)

The external bus selection register (EBSR) determines the mapping of the LCD controller, I2S2, I2S3, UART, SPI, and GPIO signals to 21 signals of the external parallel port pins. It also determines the mapping of the I2S or MMC/SD ports to serial port 1 pins and serial port 2 pins. The EBSR register is located at port address 0x1C00. Once the bit fields of this register are changed, the routing of the signals takes place on the next CPU clock cycle.

Additionally, the EBSR controls the function of the upper bits of the EMIF address bus. Pins EM_A[20:15] can be individually configured as GPIO pins through the Axx_MODE bits. When Axx_MODE = 1, the EM_A[xx] pin functions as a GPIO pin. When Axx_MODE = 0, the EM_A[xx] pin retains its EMIF functionality.

Before modifying the values of the external bus selection register, you must clock gate all affected peripherals through the Peripheral Clock Gating Control Register (for more information on clock gating peripherals, see [Section 1.5.3.2](#)). After the external bus selection register has been modified, you must reset the peripherals before using them through the Peripheral Software Reset Counter Register.

After the boot process is complete, the external bus selection register must be modified only once, during device configuration. Continuously switching the EBSR configuration is not supported.

The external bus selection register (EBSR) is shown in [Figure 1-35](#) and described in [Table 1-44](#).

Figure 1-35. External Bus Selection Register (EBSR) [1C00h]

15	14	12	11	10	9	8	
Reserved	PPMODE		SP1MODE		SP0MODE		
R-0	R/W-000		R/W-00		R/W-00		
7	6	5	4	3	2	1	0
Reserved	Reserved	A20_MODE	A19_MODE	A18_MODE	A17_MODE	A16_MODE	A15_MODE
R-0	R-0	R/W-0	R/W-0	R/W-0	R/W-0	R/W-0	R/W-0

LEGEND: R/W = Read/Write; R = Read only; -n = value after reset

Table 1-44. EBSR Register Bit Descriptions Field Descriptions

Bit	Field	Value	Description
15	Reserved	0	Reserved. Read-only, writes have no effect.
14-12	PPMODE	000 001 010 011 100 101 110 111	Parallel Port Mode Control Bits. These bits control the pin multiplexing of the LCD Controller, SPI, UART, I2S2, I2S3, and GP[31:27, 20:18] pins on the parallel port. Mode 0 (16-bit LCD Controller). All 21 signals of the LCD Bridge module are routed to the 21 external signals of the parallel port. Mode 1 (SPI, GPIO, UART, and I2S2). 7 signals of the SPI module, 6 GPIO signals, 4 signals of the UART module and 4 signals of the I2S2 module are routed to the 21 external signals of the parallel port. Mode 2 (8-bit LCD Controller and GPIO). 8-bits of pixel data of the LCD Controller module and 8 GPIO are routed to the 21 external signals of the parallel port. Mode 3 (8-bit LCD Controller, SPI, and I2S3). 8-bits of pixel data of the LCD Controller module, 4 signals of the SPI module, and 4 signals of the I2S3 module are routed to the 21 external signals of the parallel port. Mode 4 (8-bit LCD Controller, I2S2, and UART). 8-bits of pixel data of the LCD Controller module, 4 signals of the I2S2 module, and 4 signals of the UART module are routed to the 21 external signals of the parallel port. Mode 5 (8-bit LCD Controller, SPI, and UART). 8-bits of pixel data of the LCD Controller module, 4 signals of the SPI module, and 4 signals of the UART module are routed to the 21 external signals of the parallel port. Mode 6 (SPI, I2S2, I2S3, and GPIO). 7 signals of the SPI module, 4 signals of the I2S2 module, 4 signals of the I2S3 module, and 6 GPIO are routed to the 21 external signals of the parallel port. Reserved
11-10	SP1MODE	00 01 10 11	Serial Port 1 Mode Control Bits. The bits control the pin multiplexing of the MMC1, I2S1, and GPIO pins on serial port 1. Mode 0 (MMC/SD1). All 6 signals of the MMC/SD1 module are routed to the 6 external signals of the serial port 1. Mode 1 (I2S1 and GP[11:10]). 4 signals of the I2S1 module and 2 GP[11:10] signals are routed to the 6 external signals of the serial port 1. Mode 2 (GP[11:6]). 6 GPIO signals (GP[11:6]) are routed to the 6 external signals of the serial port 1. Reserved
9-8	SP0MODE	00 01 10 11	Serial Port 0 Mode Control Bits. The bits control the pin multiplexing of the MMC0, I2S0, and GPIO pins on serial port 0. Mode 0 (MMC/SD0). All 6 signals of the MMC/SD0 module are routed to the 6 external signals of the serial port 0. Mode 1 (I2S0 and GP[5:0]). 4 signals of the I2S0 module and 2 GP[5:4] signals are routed to the 6 external signals of the serial port 0. Mode 2 (GP[5:0]). 6 GPIO signals (GP[5:0]) are routed to the 6 external signals of the serial port 0. Reserved
7-6	Reserved	0	Reserved. Read-only, writes have no effect.
5	A20_MODE	0 1	A20 Pin Mode Bit. This bit controls the pin multiplexing of the EMIF address 20 (EM_A[20]) and general-purpose input/output pin 26 (GP[26]) pin functions. 0 Pin function is EMIF address pin 20 (EM_A[20]). 1 Pin function is general-purpose input/output pin 26 (GP[26]).
4	A19_MODE	0 1	A19 Pin Mode Bit. This bit controls the pin multiplexing of the EMIF address 19 (EM_A[19]) and general-purpose input/output pin 25 (GP[25]) pin functions. 0 Pin function is EMIF address pin 19 (EM_A[19]). 1 Pin function is general-purpose input/output pin 25 (GP[25]).
3	A18_MODE	0 1	A18 Pin Mode Bit. This bit controls the pin multiplexing of the EMIF address 18 (EM_A[18]) and general-purpose input/output pin 24 (GP[24]) pin functions. 0 Pin function is EMIF address pin 18 (EM_A[18]). 1 Pin function is general-purpose input/output pin 24 (GP[24]).

Table 1-44. EBSR Register Bit Descriptions Field Descriptions (continued)

Bit	Field	Value	Description
2	A17_MODE	0 1	A17 Pin Mode Bit. This bit controls the pin multiplexing of the EMIF address 17 (EM_A[17]) and general-purpose input/output pin 23 (GP[23]) pin functions. Pin function is EMIF address pin 17 (EM_A[17]). Pin function is general-purpose input/output pin 23 (GP[23]).
1	A16_MODE	0 1	A16 Pin Mode Bit. This bit controls the pin multiplexing of the EMIF address 16 (EM_A[16]) and general-purpose input/output pin 22 (GP[22]) pin functions. Pin function is EMIF address pin 16 (EM_A[16]). Pin function is general-purpose input/output pin 22 (GP[22]).
0	A15_MODE	0 1	A15 Pin Mode Bit. This bit controls the pin multiplexing of the EMIF address 15 (EM_A[15]) and general-purpose input/output pin 21 (GP[21]) pin functions. Pin function is EMIF address pin 15 (EM_A[15]). Pin function is general-purpose input/output pin 21 (GP[21]).

1.7.3.2 LDO Control Register [7004h]

When the DSP_LDO is enabled by the $\overline{\text{DSP_LDO_EN}}$ pin [D12], by default, the DSP_LDOO voltage is set to 1.3 V. The DSP_LDOO voltage can be programmed to be either 1.05 V or 1.3 V via the DSP_LDO_V bit (bit 1) in the LDO Control Register (LDOCNTL).

At reset, the USB_LDO is turned off. The USB_LDO can be enabled via the USBLDOEN bit (bit 0) in the LDOCNTL register.

1.7.3.3 LDO Control

All three LDOs can be simultaneously disabled via software by writing to either the BG_PD bit or the LDO_PD bit in the RTCPMGT register (see Figure 1-36). When the LDOs are disabled via this mechanism, the only way to re-enable them is by asserting the WAKEUP signal pin (which must also have been previously enabled to allow wakeup), or by a previously enabled and configured RTC alarm, or by cycling power to the CV_{DDRTC} pin.

ANA_LDO: The ANA_LDO is only disabled by the BG_PD and the LDO_PD mechanism described above. Otherwise, it is always enabled.

DSP_LDO: The DSP_LDO can be statically disabled by the $\overline{\text{DSP_LDO_EN}}$ pin. It can be also dynamically disabled via the BG_PD and the LDO_PD mechanism described above. The DSP_LDO can change its output voltage dynamically by software via the DSP_LDO_V bit in the LDOCNTL register (see Figure 1-37). The DSP_LDO output voltage is set to 1.3 V at reset.

USB_LDO: The USB_LDO can be independently and dynamically enabled or disabled by software via the USB_LDO_EN bit in the LDOCNTL register (see Figure 1-37). The USB_LDO is disabled at reset.

Table 1-47 shows the ON/OFF control of each LDO and its register control bit configurations.

Figure 1-36. RTC Power Management Register (RTCPMGT) [1930h]

15	Reserved						8
R-0							
7	5	4	3	2	1	0	
Reserved	WU_DOUT	WU_DIR	BG_PD	LDO_PD	RTCCCLKOUTEN		
R-0	R/W-0	R/W-0	R/W-0	R/W-0	R/W-0	R/W-0	

LEGEND: R/W = Read/Write; R = Read only; -n = value after reset

Table 1-45. RTCPMGT Register Bit Descriptions Field Descriptions

Bit	Field	Value	Description
15-5	Reserved	0	Reserved. Read-only, writes have no effect.
4	WU_DOUT	0 1	Wakeup output, active low/open-drain. WAKEUP pin driven low. WAKEUP pin is in high-impedance (Hi-Z).
3	WU_DIR	0 1	Wakeup pin direction control. WAKEUP pin configured as an input. WAKEUP pin configured as an output. Note: When the WAKEUP pin is configured as an input, it is active high. When the WAKEUP pin is configured as an output, is an open-drain that is active low and should be externally pulled-up via a 10-k Ω resistor to DV _{DDRTC} . WU_DIR must be configured as an input to allow the WAKEUP pin to wake the device up from idle modes.
2	BG_PD	0 1	Bandgap, on-chip LDOs, and the analog POR power down bit. This bit shuts down the on-chip LDOs (ANA_LDO, DSP_LDO, and USB_LDO), the Analog POR, and Bandgap reference. BG_PD and LDO_PD are only intended to be used when the internal LDOs supply power to the chip. If the internal LDOs are bypassed and not used then the BG_PD and LDO_PD power down mechanisms should not be used since POR gets powered down and the POWERGOOD signal is not generated properly. After this bit is asserted, the on-chip LDOs, Analog POR, and the Bandgap reference can be re-enabled by the WAKEUP pin (high) or the RTC alarm interrupt. The Bandgap circuit will take about 100 msec to charge the external 0.1 uF capacitor via the internal 326-k Ω resistor. On-chip LDOs, Analog POR, and Bandgap reference are enabled. On-chip LDOs, Analog POR, and Bandgap reference are disabled (shutdown).
1	LDO_PD	0 1	On-chip LDOs and Analog POR power down bit. This bit shuts down the on-chip LDOs (ANA_LDO, DSP_LDO, and USB_LDO) and the Analog POR. BG_PD and LDO_PD are only intended to be used when the internal LDOs supply power to the chip. If the internal LDOs are bypassed and not used then the BG_PD and LDO_PD power down mechanisms should not be used since POR gets powered down and the POWERGOOD signal is not generated properly. After this bit is asserted, the on-chip LDOs and Analog POR can be re-enabled by the WAKEUP pin (high) or the RTC alarm interrupt. This bit keeps the Bandgap reference turned on to allow a faster wake-up time with the expense power consumption of the Bandgap reference. On-chip LDOs and Analog POR are enabled. On-chip LDOs and Analog POR are disabled (shutdown).
0	RTCCLKOUTEN	0 1	Clockout output enable bit Clock output disabled Clock output enabled

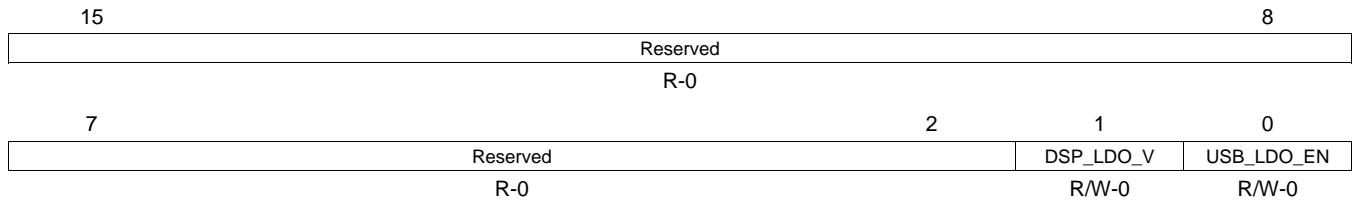
Figure 1-37. LDO Control Register (LDOCNTL) [7004h]

LEGEND: R/W = Read/Write; R = Read only; -n = value after reset

Table 1-46. LDOCNTL Register Bit Descriptions Field Descriptions

Bit	Field	Value	Description
15-2	Reserved	0	Reserved. Read-only, writes have no effect.
1	DSP_LDO_V	0	DSP_LDO voltage select bit. DSP_LDOO is regulated to 1.3 V.
		1	DSP_LDOO is regulated to 1.05 V.
0	USB_LDO_EN	0	USB_LDO enable bit. USB_LDO output is disabled. USB_LDOO pin is placed in high-impedance (Hi-Z) state.
		1	USB_LDO output is enabled. USB_LDOO is regulated to 1.3 V.

Table 1-47. LDO Controls Matrix

RTCPMGT Register (0x1930)		LDOCNTL Register (0x7004)	DSP_LDO_EN (Pin D12)	ANA_LDO	DSP_LDO	USB_LDO
BG_PD Bit	LDO_PD Bit	USB_LDO_EN Bit				
1	Don't Care	Don't Care	Don't Care	OFF	OFF	OFF
Don't Care	1	Don't Care	Don't Care	OFF	OFF	OFF
0	0	0	Low	ON	ON	OFF
0	0	0	High	ON	OFF	OFF
0	0	1	Low	ON	ON	ON

1.7.3.4 Output Slew Rate Control Register (OSRCR) [1C16h]

To provide the lowest power consumption setting, the DSP has configurable slew rate control on the EMIF and CLKOUT output pins. The output slew rate control register (OSRCR) is used to set a subset of the device I/O pins, namely CLKOUT and EMIF pins, to either fast or slow slew rate. The slew rate feature is implemented by staging/delaying turn-on times of the parallel p-channel drive transistors and parallel n-channel drive transistors of the output buffer. In the slow slew rate configuration, the delay is longer, but ultimately the same number of parallel transistors are used to drive the output high or low; therefore, the drive strength is ultimately the same. The slower slew rate control can be used for power savings and has the greatest effect at lower DVDDIO and DVDDDEMIF voltages.

The output slew rate control register (OSRCR) is shown in [Figure 1-38](#) and described in [Table 1-48](#).

Figure 1-38. Output Slew Rate Control Register (OSRCR) [1C16h]

15	3	2	1	0
Reserved		CLKOUTSR	Reserved	EMIFSR
R-0		RW-1	R-0	RW-1

LEGEND: R/W = Read/Write; R = Read only; -n = value after reset

Table 1-48. Output Slew Rate Control Register (OSRCR) Field Descriptions

Bit	Field	Value	Description
15-3	Reserved	0	Reserved.
2	CLKOUTSR		CLKOUT pin output slew rate bits. These bits set the slew rate for the CLKOUT pin.
		0	Slow slew rate
		1	Fast slew rate
1	Reserved	0	Reserved.
0	EMIFSR		EMIF pin output slew rate bits. These bits set the slew rate for the EMIF pins.
		0	Slow slew rate
		1	Fast slew rate

1.7.3.5 Pull-Up/Pull-Down Inhibit Register (PDINHIBR1, PDINHIBR2, and PDINHIBR3 [1C17h, 1C18h, and 1C19h])

The device allows you to individually enable or disable the internal pull-up and pull-down resistors. You can individually inhibit the pull-up and pull-down resistors of the I/O pins through the pull-down/up inhibit registers (PDINHIBRn). There is one pin, TRSTN, that has a pulldown that is permanently enabled and cannot be disabled.

The pull-down inhibit register 1 (PDINHIBR1) is shown in [Figure 1-39](#) and described in [Table 1-49](#).

Figure 1-39. Pull-Down Inhibit Register 1 (PDINHIBR1) [1C17h]

15	14	13	12	11	10	9	8
Reserved		S15PD	S14PD	S13PD	S12PD	S11PD	S10PD
R-0		R/W-1	R/W-1	R/W-1	R/W-1	R/W-1	R/W-1
7	6	5	4	3	2	1	0
Reserved		S05PD	S04PD	S03PD	S02PD	S01PD	S00PD
R-0		R/W-1	R/W-1	R/W-1	R/W-1	R/W-1	R/W-1

LEGEND: R/W = Read/Write; R = Read only; -n = value after reset

Table 1-49. Pull-Down Inhibit Register 1 (PDINHIBR1) Field Descriptions

Bit	Field	Value	Description
15-14	Reserved	0	Reserved.
13	S15PD	0	Serial port 1 pin 5 pull-down inhibit bit. Setting this bit to 1 disables the pin's internal pull-down. Pin pull-down is enabled.
		1	Pin pull-down is disabled.
12	S14PD	0	Serial port 1 pin 4 pull-down inhibit bit. Setting this bit to 1 disables the pin's internal pull-down. Pin pull-down is enabled.
		1	Pin pull-down is disabled.
11	S13PD	0	Serial port 1 pin 3 pull-down inhibit bit. Setting this bit to 1 disables the pin's internal pull-down. Pin pull-down is enabled.
		1	Pin pull-down is disabled.
10	S12PD	0	Serial port 1 pin 2 pull-down inhibit bit. Setting this bit to 1 disables the pin's internal pull-down. Pin pull-down is enabled.
		1	Pin pull-down is disabled.
9	S11PD	0	Serial port 1 pin 1 pull-down inhibit bit. Setting this bit to 1 disables the pin's internal pull-down. Pin pull-down is enabled.
		1	Pin pull-down is disabled.
8	S10PD	0	Serial port 1 pin 0 pull-down inhibit bit. Setting this bit to 1 disables the pin's internal pull-down. Pin pull-down is enabled.
		1	Pin pull-down is disabled.
7-6	Reserved	0	Reserved.
5	S05PD	0	Serial port 0 pin 5 pull-down inhibit bit. Setting this bit to 1 disables the pin's internal pull-down. Pin pull-down is enabled.
		1	Pin pull-down is disabled.
4	S04PD	0	Serial port 0 pin 4 pull-down inhibit bit. Setting this bit to 1 disables the pin's internal pull-down. Pin pull-down is enabled.
		1	Pin pull-down is disabled.
3	S03PD	0	Serial port 0 pin 3 pull-down inhibit bit. Setting this bit to 1 disables the pin's internal pull-down. Pin pull-down is enabled.
		1	Pin pull-down is disabled.

Table 1-49. Pull-Down Inhibit Register 1 (PDINHIBR1) Field Descriptions (continued)

Bit	Field	Value	Description
2	S02PD	0	Serial port 0 pin 2 pull-down inhibit bit. Setting this bit to 1 disables the pin's internal pull-down. Pin pull-down is enabled.
		1	Pin pull-down is disabled.
1	S01PD	0	Serial port 0 pin 1 pull-down inhibit bit. Setting this bit to 1 disables the pin's internal pull-down. Pin pull-down is enabled.
		1	Pin pull-down is disabled.
0	S00PD	0	Serial port 0 pin 0 pull-down inhibit bit. Setting this bit to 1 disables the pin's internal pull-down. Pin pull-down is enabled.
		1	Pin pull-down is disabled.

The pull-down inhibit register 2 (PDINHIBR2) is shown in [Figure 1-40](#) and described in [Table 1-50](#).

Figure 1-40. Pull-Down Inhibit Register 2 (PDINHIBR2) [1C18h]

15	14	13	12	11	10	9	8
Reserved	INT1PU	INT0PU	RESETPU	EMU01PU	TDIPU	TMSPU	TCKPU
R-0	R/W-1	R/W-1	R/W-0	R/W-0	R/W-0	R/W-0	R/W-0
7	6	5	4	3	2	1	0
Reserved	A20PD	A19PD	A18PD	A17PD	A16PD	A15PD	
R-0	R/W-1	R/W-1	R/W-1	R/W-1	R/W-1	R/W-1	R/W-1

LEGEND: R/W = Read/Write; R = Read only; -n = value after reset

Table 1-50. Pull-Down Inhibit Register 2 (PDINHIBR2) Field Descriptions

Bit	Field	Value	Description
15	Reserved	0	Reserved.
14	INT1PU	0	Interrupt 1 pin pull-up inhibit bit. Setting this bit to 1 disables the pin's internal pull-up. Pin pull-up is enabled.
		1	Pin pull-up is disabled.
13	INT0PU	0	Interrupt 0 pin pull-up inhibit bit. Setting this bit to 1 disables the pin's internal pull-up. Pin pull-up is enabled.
		1	Pin pull-up is disabled.
12	RESETPU	0	Reset pin pull-up inhibit bit. Setting this bit to 1 disables the pin's internal pull-up. Pin pull-up is enabled.
		1	Pin pull-up is disabled.
11	EMU01PU	0	EMU1 and EMU0 pin pull-up inhibit bit. Setting this bit to 1 disables the pin's internal pull-up. Pin pull-up is enabled.
		1	Pin pull-up is disabled.
10	TDIPU	0	TDI pin pull-up inhibit bit. Setting this bit to 1 disables the pin's internal pull-up. Pin pull-up is enabled.
		1	Pin pull-up is disabled.
9	TMSPU	0	TMS pin pull-up inhibit bit. Setting this bit to 1 disables the pin's internal pull-up. Pin pull-up is enabled.
		1	Pin pull-up is disabled.
8	TCKPU	0	TCK pin pull-up inhibit bit. Setting this bit to 1 disables the pin's internal pull-up. Pin pull-up is enabled.
		1	Pin pull-up is disabled.
7-6	Reserved	0	Reserved.

Table 1-50. Pull-Down Inhibit Register 2 (PDINHIBR2) Field Descriptions (continued)

Bit	Field	Value	Description
5	A20PD	0	EMIF A[20] pin pull-down inhibit bit. Setting this bit to 1 disables the pin's internal pull-down. Pin pull-down is enabled.
		1	Pin pull-down is disabled.
4	A19PD	0	EMIF A[19] pin pull-down inhibit bit. Setting this bit to 1 disables the pin's internal pull-down. Pin pull-down is enabled.
		1	Pin pull-down is disabled.
3	A18PD	0	EMIF A[18] pin pull-down inhibit bit. Setting this bit to 1 disables the pin's internal pull-down. Pin pull-down is enabled.
		1	Pin pull-down is disabled.
2	A17PD	0	EMIF A[17] pin pull-down inhibit bit. Setting this bit to 1 disables the pin's internal pull-down. Pin pull-down is enabled.
		1	Pin pull-down is disabled.
1	A16PD	0	EMIF A[16] pin pull-down inhibit bit. Setting this bit to 1 disables the pin's internal pull-down. Pin pull-down is enabled.
		1	Pin pull-down is disabled.
0	A15PD	0	EMIF A[15] pin pull-down inhibit bit. Setting this bit to 1 disables the pin's internal pull-down. Pin pull-down is enabled.
		1	Pin pull-down is disabled.

The pull-down inhibit register 3 (PDINHIBR3) is shown in [Figure 1-41](#) and described in [Table 1-51](#).

Figure 1-41. Pull-Down Inhibit Register 3 (PDINHIBR3) [1C19h]

15	14	13	12	11	10	9	8
PD15PD	PD14PD	PD13PD	PD12PD	PD11PD	PD10PD	PD9PD	PD8PD
R/W-1	R/W-1	R/W-1	R/W-1	R/W-1	R/W-1	R/W-1	R/W-1
7	6	5	4	3	2	1	0
PD7PD	PD6PD	PD5PD	PD4PD	PD3PD	PD2PD	Reserved	
R/W-1	R/W-1	R/W-1	R/W-1	R/W-1	R/W-1	R-0	

LEGEND: R/W = Read/Write; R = Read only; -n = value after reset

Table 1-51. Pull-Down Inhibit Register 3 (PDINHIBR3) Field Descriptions

Bit	Field	Value	Description
15	PD15PD	0	Parallel port pin 15 pull-down inhibit bit. Setting this bit to 1 disables the pin's internal pull-down. Pin pull-down is enabled.
		1	Pin pull-down is disabled.
14	PD14PD	0	Parallel port pin 14 pull-down inhibit bit. Setting this bit to 1 disables the pin's internal pull-down. Pin pull-down is enabled.
		1	Pin pull-down is disabled.
13	PD13PD	0	Parallel port pin 13 pull-down inhibit bit. Setting this bit to 1 disables the pin's internal pull-down. Pin pull-down is enabled.
		1	Pin pull-down is disabled.
12	PD12PD	0	Parallel port pin 12 pull-down inhibit bit. Setting this bit to 1 disables the pin's internal pull-down. Pin pull-down is enabled.
		1	Pin pull-down is disabled.
11	PD11PD	0	Parallel port pin 11 pull-down inhibit bit. Setting this bit to 1 disables the pin's internal pull-down. Pin pull-down is enabled.
		1	Pin pull-down is disabled.

Table 1-51. Pull-Down Inhibit Register 3 (PDINHIBR3) Field Descriptions (continued)

Bit	Field	Value	Description
10	PD10PD	0	Parallel port pin 10 pull-down inhibit bit. Setting this bit to 1 disables the pin's internal pull-down. Pin pull-down is enabled.
		1	Pin pull-down is disabled.
9	PD9PD	0	Parallel port pin 9 pull-down inhibit bit. Setting this bit to 1 disables the pin's internal pull-down. Pin pull-down is enabled.
		1	Pin pull-down is disabled.
8	PD8PD	0	Parallel port pin 8 pull-down inhibit bit. Setting this bit to 1 disables the pin's internal pull-down. Pin pull-down is enabled.
		1	Pin pull-down is disabled.
7	PD7PD	0	Parallel port pin 7 pull-down inhibit bit. Setting this bit to 1 disables the pin's internal pull-down. Pin pull-down is enabled.
		1	Pin pull-down is disabled.
6	PD6PD	0	Parallel port pin 6 pull-down inhibit bit. Setting this bit to 1 disables the pin's internal pull-down. Pin pull-down is enabled.
		1	Pin pull-down is disabled.
5	PD5PD	0	Parallel port pin 5 pull-down inhibit bit. Setting this bit to 1 disables the pin's internal pull-down. Pin pull-down is enabled.
		1	Pin pull-down is disabled.
4	PD4PD	0	Parallel port pin 4 pull-down inhibit bit. Setting this bit to 1 disables the pin's internal pull-down. Pin pull-down is enabled.
		1	Pin pull-down is disabled.
3	PD3PD	0	Parallel port pin 3 pull-down inhibit bit. Setting this bit to 1 disables the pin's internal pull-down. Pin pull-down is enabled.
		1	Pin pull-down is disabled.
2	PD2PD	0	Parallel port pin 2 pull-down inhibit bit. Setting this bit to 1 disables the pin's internal pull-down. Pin pull-down is enabled.
		1	Pin pull-down is disabled.
1-0	Reserved	0	Reserved.

1.7.4 DMA Controller Configuration

The DSP includes four DMA controllers that allow movement of blocks of data among internal memory, external memory, and peripherals to occur without intervention from the CPU and in the background of CPU operation. Each DMA has an EVENT input signal (per channel) that can be used to tell it when to start the block transfer. And each DMA has an interrupt output (per channel) that can signal the CPU when the block transfer is completed. While most DMA configuration registers described in the *TMS320C5515/14/05/04 DSP Direct Memory Access (DMA) Controller User's Guide (SPRUFT2)*, the EVENT source and interrupt aggregation is more of a system-level concern and, therefore, they are best described in this guide.

The following sections provide more details on these features. In this section and subsections, the following notations will be used:

- Lowercase, italicized, n is an integer, 0-3, representing each of the 4 DMAs.
- Lowercase, italicized, m is an integer, 0-3, representing each of the 4 channels within each DMA.

1.7.4.1 DMA Synchronization Events

The DMA controllers allow activity in their channels to be synchronized to selected events. The DSP supports 20 separate synchronization events and each channel can be tied to separate sync events independent of the other channels. Synchronization events are selected by programming the CH n EVT field in the DMA n channel event source registers (DMA n CESR1 and DMA n CESR2) (where n is an integer, 0-3, representing each of the 4 DMAs). The synchronization events available to each DMA controller are shown in [Table 1-52](#).

Table 1-52. Channel Synchronization Events for DMA Controllers

CH m EVT Options	DMA0 Synchronization Event	DMA1 Synchronization Event	DMA2 Synchronization Event	DMA3 Synchronization Event
0000b	Reserved	Reserved	Reserved	Reserved
0001b	I2S0 transmit event	I2S2 transmit event	I2C transmit event	I2S1 transit event
0010b	I2S0 receive event	I2S2 receive event	I2C receive event	I2S1 receive event
0011b	Reserved	Reserved	SAR A/D event	Reserved
0100b	Reserved	Reserved	I2S3 transmit event	Reserved
0101b	MMC/SD0 transmit event	UART transmit event	I2S3 receive event	Reserved
0110b	MMC/SD0 receive event	UART receive event	Reserved	Reserved
0111b	MMC/SD1 transmit event	Reserved	Reserved	Reserved
1000b	MMC/SD1 receive event	Reserved	Reserved	Reserved
1001b	Reserved	Reserved	Reserved	Reserved
1010v	Reserved	Reserved	Reserved	Reserved
1011b	Reserved	Reserved	Reserved	Reserved
1100b	Timer 0 event	Timer 0 event	Timer 0 event	Timer 0 event
1101b	Timer 1 event	Timer 1 event	Timer 1 event	Timer 1 event
1110b	Timer 2 event	Timer 2 event	Timer 2 event	Timer 2 event
1111b	Reserved	Reserved	Reserved	Reserved

1.7.4.2 DMA Configuration Registers

The system-level DMA registers are listed in [Table 1-53](#). The DMA interrupt flag and enable registers (DMAIFR and DMAIER) are used to control the aggregation and CPU interrupt generation for the four DMA controllers and their associated channels. In addition, there are two registers per DMA controller which control event synchronization in each channel; the DMA n channel event source registers (DMA n CESR1 and DMA n CESR2).

Table 1-53. System Registers Related to the DMA Controllers

CPU Word Address	Acronym	Register Description
1C30h	DMAIFR	DMA Interrupt Flag Register
1C31h	DMAIER	DMA Interrupt Enable Register
1C1Ah	DMA0CESR1	DMA0 Channel Event Source Register 1
1C1Bh	DMA0CESR2	DMA0 Channel Event Source Register 2
1C1Ch	DMA1CESR1	DMA1 Channel Event Source Register 1
1C1Dh	DMA1CESR2	DMA1 Channel Event Source Register 2
1C36h	DMA2CESR1	DMA2 Channel Event Source Register 1
1C37h	DMA2CESR2	DMA2 Channel Event Source Register 2
1C38h	DMA3CESR1	DMA3 Channel Event Source Register 1
1C39h	DMA3CESR2	DMA3 Channel Event Source Register 2

1.7.4.2.1 DMA Interrupt Flag Register (DMAIFR) [1C30h] and DMA Interrupt Enable Register (DMAIER) [1C31h]

The DSP includes two registers for aggregating the four channel interrupts of the four DMA controllers. Use the DMA interrupt enable register (DMAIER) to enable channel interrupts. At the end of a block transfer, if the DMA controller channel interrupt enable (DMA n CH m IE) bit is 1, an interrupt request is sent to the DSP CPU, where it can be serviced or ignored. Each channel can generate an interrupt, although all channel interrupts are aggregated into a single DMA interrupt signal to the CPU.

To see which channel generated an interrupt, your program can read the DMA interrupt flag register (DMAIFR). The DMA controller channel interrupt flag (DMA n CH m IF) bits are set to 1 when a DMA channel generates an interrupt. Your program must manually clear the bits of DMAIFR by writing a 1 to the bit positions to be cleared.

Figure 1-42. DMA Interrupt Flag Register (DMAIFR) [1C30h]

15	14	13	12	11	10	9	8
DMA3CH3IF	DMA3CH2IF	DMA3CH1IF	DMA3CH0IF	DMA2CH3IF	DMA2CH2IF	DMA2CH1IF	DMA2CH0IF
RW-0	RW-0	RW-0	RW-0	RW-0	RW-0	RW-0	RW-0
7	6	5	4	3	2	1	0
DMA1CH3IF	DMA1CH2IF	DMA1CH1IF	DMA1CH0IF	DMA0CH3IF	DMA0CH2IF	DMA0CH1IF	DMA0CH0IF
RW-0	RW-0	RW-0	RW-0	RW-0	RW-0	RW-0	RW-0

LEGEND: R/W = Read/Write; R = Read only; - n = value after reset

Figure 1-43. DMA Interrupt Enable Register (DMAIER) [1C31h]

15	14	13	12	11	10	9	8
DMA3CH3IE	DMA3CH2IE	DMA3CH1IE	DMA3CH0IE	DMA2CH3IE	DMA2CH2IE	DMA2CH1IE	DMA2CH0IE
RW-0	RW-0	RW-0	RW-0	RW-0	RW-0	RW-0	RW-0
7	6	5	4	3	2	1	0
DMA1CH3IE	DMA1CH2IE	DMA1CH1IE	DMA1CH0IE	DMA0CH3IE	DMA0CH2IE	DMA0CH1IE	DMA0CH0IE
RW-0	RW-0	RW-0	RW-0	RW-0	RW-0	RW-0	RW-0

LEGEND: R/W = Read/Write; R = Read only; - n = value after reset

Table 1-54. DMA Interrupt Flag Register (DMAIFR) Field Descriptions

Bit	Field	Value	Description
15-0	DMA n CH m IF	0	Channel interrupt status bits. DMA controller n , channel m has not completed its block transfer.
		1	DMA controller n , channel m block transfer complete.

Table 1-55. DMA Interrupt Enable Register (DMAIER) Field Descriptions

Bit	Field	Value	Description
15-0	DMA n CH m IE	0	Channel interrupt enable bits. DMA controller n , channel m interrupt is disabled.
		1	DMA controller n , channel m interrupt is enabled.

1.7.4.2.2 DMA_n Channel Event Source Registers (DMA_nCESR1 and DMA_nCESR2) [1C1Ah, 1C1Bh, 1C1Ch, 1C1Dh, 1C36h, 1C37h, 1C38h, and 1C39h]

When SYNCMODE = 1 in a channel's DMACH_mTCR2 (see the *TMS320C5515/14/05/04 DSP Direct Memory Access (DMA) Controller User's Guide (SPRUFT2)*), activity in the DMA controller is synchronized to a DSP event. You can specify the synchronization event used by the DMA channels by programming the CH_mEVT bits of the DMA_nCESR registers.

Each DMA controller contains two channel event source registers (DMA_nCESR1 and DMA_nCESR2). DMA_nCESR1 controls the synchronization event for DMA_n channel 0 and 1 while DMA_nCESR2 controls the synchronization event for DMA_n channel 2 and 3.

The synchronization events available to each DMA controller are shown in [Table 1-52](#). Multiple DMAs and multiple channels within a DMA are allowed to have the same synchronization event.

Figure 1-44. DMA_n Channel Event Source Register 1 (DMA_nCESR1) [1C1Ah, 1C1Ch, 1C36h, and 1C38h]

15	12	11	8	7	4	3	0
Reserved		CH1EVT		Reserved		CH0EVT	
R-0		RW-0		R-0		RW-0	

LEGEND: R/W = Read/Write; R = Read only; -n = value after reset

Figure 1-45. DMA_n Channel Event Source Register 2 (DMA_nCESR2) [1C1Bh, 1C1Dh, 1C37h, and 1C39h]

15	12	11	8	7	4	3	0
Reserved		CH3EVT		Reserved		CH2EVT	
R-0		RW-0		R-0		RW-0	

LEGEND: R/W = Read/Write; R = Read only; -n = value after reset

Table 1-56. DMA_n Channel Event Source Register 1 (DMA_nCESR1) Field Descriptions

Bit	Field	Value	Description
15-12	Reserved	0	Reserved.
11-8	CH1EVT	0-Fh	Channel 1 synchronization events. When SYNCMODE = 1 in a channel's DMACH _m TCR2, the CH1EVT bits in the DMA _n CESR registers specify the synchronization event for activity in the DMA controller. See Table 1-52 for a list of available synchronization event options.
7-4	Reserved	0	Reserved.
3-0	CH0EVT	0-Fh	Channel 0 synchronization events. When SYNCMODE = 1 in a channel's DMACH _m TCR2, the CH0EVT bits in the DMA _n CESR registers specify the synchronization event for activity in the DMA controller. See Table 1-52 for a list of available synchronization event options.

Table 1-57. DMA_n Channel Event Source Register 2 (DMA_nCESR2) Field Descriptions

Bit	Field	Value	Description
15-12	Reserved	0	Reserved.
11-8	CH3EVT	0-Fh	Channel 3 synchronization events. When SYNCMODE = 1 in a channel's DMACH _m TCR2, the CH3EVT bits in the DMA _n CESR registers specify the synchronization event for activity in the DMA controller. See Table 1-52 for a list of available synchronization event options.
7-4	Reserved	0	Reserved.
3-0	CH2EVT	0-Fh	Channel 2 synchronization events. When SYNCMODE = 1 in a channel's DMACH _m TCR2, the CH2EVT bits in the DMA _n CESR registers specify the synchronization event for activity in the DMA controller. See Table 1-52 for a list of available synchronization event options.

1.7.5 Peripheral Reset

All peripherals can be reset through software using the peripheral reset control register (PRCR). The peripheral software reset counter register (PSRCR) controls the duration, in SYSCLK cycles, that the reset signal is asserted low once activated by the bits in PRCR.

To reset a peripheral or group of peripherals, follow these steps:

1. Set COUNT = 08h in PSRCR.
2. Initiate the desired peripheral reset by setting to 1 the bits of PRCR.
3. Do not attempt to access the peripheral for at least the number of clock cycles set in the PSRCR register. A repeated NOP may be necessary.

In some cases, a single reset is used for multiple peripherals. For example, PG4_RST controls the reset to the LCD controller, I2S2, I2S3, UART, and SPI.

1.7.5.1 Peripheral Software Reset Counter Register (PSRCR) [1C04h]

The Peripheral Software Reset Counter Register (PSRCR) is shown in [Table 1-58](#) and described in [Table 1-58](#).

Figure 1-46. Peripheral Software Reset Counter Register (PSRCR) [1C04h]

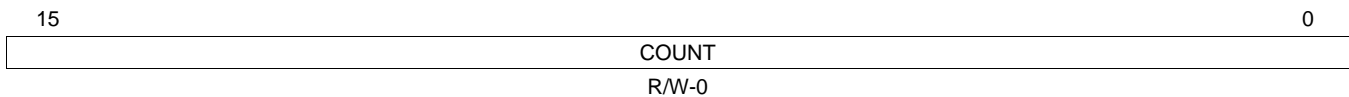

LEGEND: R/W = Read/Write; -n = value after reset

Table 1-58. Peripheral Software Reset Counter Register (PSRCR) Field Descriptions

Bit	Field	Value	Description
15-0	COUNT	0-FFFFh	Count bits. These bits specify the number of system clock (SYSCLK) cycles the software reset signals are asserted. When the software counter reaches 0, the software reset bits will be cleared to 0. Always initialize this field with a value of at least 08h.

1.7.5.2 Peripheral Reset Control Register (PRCR) [1C05h]

Writing a 1 to any bits in this register initiates the reset sequence for the associated peripherals. The associated peripherals will be held in reset for the duration of clock cycles set in the PSRCR register and they should not be accessed during that time. Reads of this register return the state of the reset signal for the associated peripherals. In other words, polling may be used to wait for the reset to become de-asserted.

The Peripheral Reset Control Register (PRCR) is shown in [Figure 1-47](#) and described in [Table 1-59](#).

Figure 1-47. Peripheral Reset Control Register (PRCR) [1C05h]

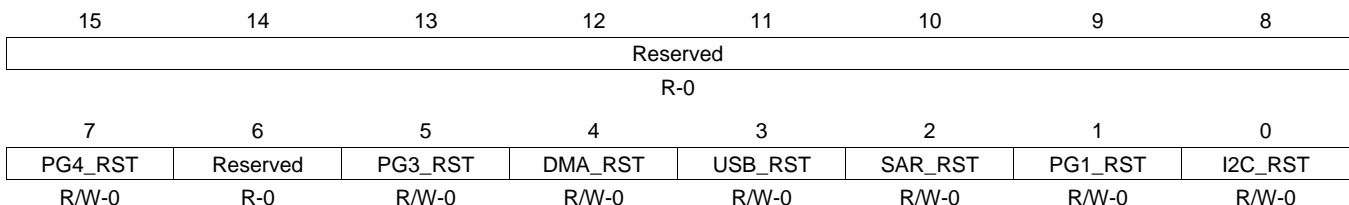

LEGEND: R/W = Read/Write; R = Read only; -n = value after reset

Table 1-59. Peripheral Reset Control Register (PRCR) Field Descriptions

Bit	Field	Value	Description
15-8	Reserved	0	Reserved. Always write 0 to these bits.
7	PG4_RST	Write 0 Write 1 Read 0 Read 1	Peripheral group 4 software reset bit. Drives the LCD, I2S2, I2S3, UART, and SPI reset signal. Writing zero has no effect Writing one starts resetting the peripheral group Reading zero means that peripheral group is out of reset Reading one means the peripheral group is being held in reset and should not be accessed
6	Reserved	0	Reserved, always write 0 to this bit.

Table 1-59. Peripheral Reset Control Register (PRCR) Field Descriptions (continued)

Bit	Field	Value	Description
5	PG3_RST	Write 0 Write 1 Read 0 Read 1	Peripheral group 3 software reset bit. Drives the MMC/SD0, MMC/SD1, I2S0, and I2S1 reset signal. Writing zero has no effect Writing one starts resetting the peripheral group Reading zero means that peripheral group is out of reset Reading one means the peripheral group is being held in reset and should not be accessed
4	DMA_RST	Write 0 Write 1 Read 0 Read 1	DMA software reset bit. Drives the reset signal to all four controllers. Writing zero has no effect Writing one starts resetting the peripheral group Reading zero means that peripheral group is out of reset Reading one means the peripheral group is being held in reset and should not be accessed
3	USB_RST	Write 0 Write 1 Read 0 Read 1	USB software reset bit. Drives the USB reset signal. Writing zero has no effect Writing one starts resetting the peripheral group Reading zero means that peripheral group is out of reset Reading one means the peripheral group is being held in reset and should not be accessed
2	SAR_RST	Write 0 Write 1 Read 0 Read 1	SAR software reset bit and reset for most analog-related register in the IO-space address range of 0x7000-0x70FF Writing zero has no effect Writing one starts resetting the peripheral group Reading zero means that peripheral group is out of reset Reading one means the peripheral group is being held in reset and should not be accessed
1	PG1_RST	Write 0 Write 1 Read 0 Read 1	Peripheral group 1 software reset bit. Drives the EMIF and all three timer reset signal. Writing zero has no effect Writing one starts resetting the peripheral group Reading zero means that peripheral group is out of reset Reading one means the peripheral group is being held in reset and should not be accessed
0	I2C_RST	Write 0 Write 1 Read 0 Read 1	I2C software reset bit. Drives the I2C reset signal. Writing zero has no effect Writing one starts resetting the peripheral group Reading zero means that peripheral group is out of reset Reading one means the peripheral group is being held in reset and should not be accessed

1.7.6 EMIF and USB Byte Access

The C55x CPU architecture cannot generate 8-bit accesses to its data or I/O space. But in some cases specific to the USB and EMIF peripherals, it is necessary to access a single byte of data. For example, when writing byte commands to NAND Flash devices.

For these situations, the upper or lower byte of a CPU word access can be masked using the BYTEMODE bits of the EMIF system control register (ESCR) and the USB system control register (USBSCR). The BYTEMODE bits of ESCR only affect accesses to the external memory and the EMIF registers. The BYTEMODE bits of USBSCR only affect CPU accesses to the USB registers. [Table 1-60](#) and [Table 1-61](#) summarize the effect of the BYTEMODE bits for different CPU operations.

NOTE: The BYTEMODE bits of the EMIF system control register should only be used for controlling CPU accesses to NAND Flash devices and EMIF registers.

Table 1-60. Effect of BYTEMODE Bits on EMIF Accesses

BYTEMODE Setting	CPU Access to EMIF Register	CPU Access To External Memory
BYTEMODE = 00b (16-bit word access)	Entire register contents are accessed	ASIZE = 01b (16-bit data bus): EMIF generates a single 16-bit access to external memory for every CPU word access. ASIZE = 00b (8-bit data bus): EMIF generates two 8-bit accesses to external memory for every CPU word access.
BYTEMODE = 01b (8-bit access with high byte selected)	Only the upper byte of the register is accessed.	ASIZE = 01b (16-bit data bus): EMIF generates a 16-bit access to external memory for every CPU word access; only the high byte of the EMIF data bus is used. ASIZE = 00b (8-bit data bus): EMIF generates a single 8-bit access to external memory for every CPU word access.
BYTEMODE = 10b (8-bit access with low byte selected)	Only the lower byte of the register is accessed.	ASIZE = 01b (16-bit data bus): EMIF generates a 16-bit access to external memory for every CPU word access; only the low byte of the EMIF data bus is used. ASIZE = 00b (8-bit data bus): EMIF generates a single 8-bit access to external memory for every CPU word access.

The USB system control register (USBSCR) is described in [Section 1.5.3.4.2](#).

Table 1-61. Effect of USBSCR BYTEMODE Bits on USB Access

BYTEMODE Setting	CPU Access to USB Register
BYTEMODE = 00b (16-bit word access)	Entire register contents are accessed
BYTEMODE = 01b (8-bit access with high byte selected)	Only the upper byte of the register is accessed
BYTEMODE = 10b (8-bit access with low byte selected)	Only the lower byte of the register is accessed

1.7.6.1 EMIF System Control Register (ESCR) [1C33h]

The EMIF system control register (ESCR) is shown in [Figure 1-48](#) and described in [Table 1-62](#).

Figure 1-48. EMIF System Control Register (ESCR) [1C33h]

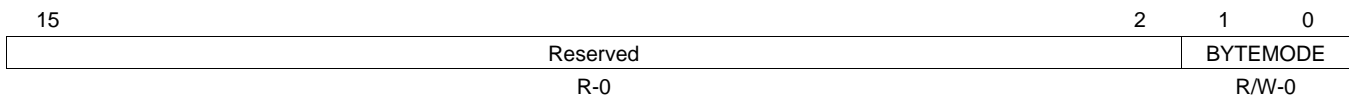

LEGEND: R/W = Read/Write; R = Read only; -n = value after reset

Table 1-62. EMIF System Control Register (ESCR) Field Descriptions

Bit	Field	Value	Description
15-2	Reserved	0	Reserved.
1-0	BYTEMODE	0	Word accesses by the CPU are allowed.
		1h	Byte accesses by the CPU are allowed (high byte is selected).
		2h	Byte accesses by the CPU are allowed (low byte is selected).
		3h	Reserved.

1.7.7 EMIF Clock Divider Register (ECDR) [1C26h]

The EMIF clock divider register (ECDR) controls the input clock frequency to the EMIF module. When EDIV = 1 (default), the EMIF operates at the same clock rate as the system clock (SYSCLK). When EDIV = 0, the EMIF operates at half the clock rate of the system clock.

This register affects both asynchronous memory mode timing as well as synchronous (mobile SDRAM, SDRAM) mode. But half-rate mode is normally only needed to meet synchronous memory timing. For more information regarding when half-rate mode is required, see the mSDRAM timing sections of the device-specific data sheet.

The EMIF clock divider register (ECDR) is shown in [Figure 1-49](#) and described in [Table 1-63](#).

Figure 1-49. EMIF Clock Divider Register (ECDR) [1C26h]

15	Reserved	1	0
R-0		EDIV R/W-1	

LEGEND: R/W = Read/Write; R = Read only; -n = value after reset

Table 1-63. EMIF Clock Divider Register (ECDR) Field Descriptions

Bit	Field	Value	Description
15-1	Reserved	0	Reserved.
0	EDIV	0	EMIF clock divider select bits. The EMIF module can internally divide its input peripheral clock. When this bit is set to 0, the EMIF operates at half the clock rate of its peripheral clock. When this bit is set to 1 the EMIF operates at the full rate of its peripheral clock.
		0	EMIF operates at half the peripheral clock rate.
		1	EMIF operates at the same rate as the peripheral clock.

IMPORTANT NOTICE

Texas Instruments Incorporated and its subsidiaries (TI) reserve the right to make corrections, modifications, enhancements, improvements, and other changes to its products and services at any time and to discontinue any product or service without notice. Customers should obtain the latest relevant information before placing orders and should verify that such information is current and complete. All products are sold subject to TI's terms and conditions of sale supplied at the time of order acknowledgment.

TI warrants performance of its hardware products to the specifications applicable at the time of sale in accordance with TI's standard warranty. Testing and other quality control techniques are used to the extent TI deems necessary to support this warranty. Except where mandated by government requirements, testing of all parameters of each product is not necessarily performed.

TI assumes no liability for applications assistance or customer product design. Customers are responsible for their products and applications using TI components. To minimize the risks associated with customer products and applications, customers should provide adequate design and operating safeguards.

TI does not warrant or represent that any license, either express or implied, is granted under any TI patent right, copyright, mask work right, or other TI intellectual property right relating to any combination, machine, or process in which TI products or services are used. Information published by TI regarding third-party products or services does not constitute a license from TI to use such products or services or a warranty or endorsement thereof. Use of such information may require a license from a third party under the patents or other intellectual property of the third party, or a license from TI under the patents or other intellectual property of TI.

Reproduction of TI information in TI data books or data sheets is permissible only if reproduction is without alteration and is accompanied by all associated warranties, conditions, limitations, and notices. Reproduction of this information with alteration is an unfair and deceptive business practice. TI is not responsible or liable for such altered documentation. Information of third parties may be subject to additional restrictions.

Resale of TI products or services with statements different from or beyond the parameters stated by TI for that product or service voids all express and any implied warranties for the associated TI product or service and is an unfair and deceptive business practice. TI is not responsible or liable for any such statements.

TI products are not authorized for use in safety-critical applications (such as life support) where a failure of the TI product would reasonably be expected to cause severe personal injury or death, unless officers of the parties have executed an agreement specifically governing such use. Buyers represent that they have all necessary expertise in the safety and regulatory ramifications of their applications, and acknowledge and agree that they are solely responsible for all legal, regulatory and safety-related requirements concerning their products and any use of TI products in such safety-critical applications, notwithstanding any applications-related information or support that may be provided by TI. Further, Buyers must fully indemnify TI and its representatives against any damages arising out of the use of TI products in such safety-critical applications.

TI products are neither designed nor intended for use in military/aerospace applications or environments unless the TI products are specifically designated by TI as military-grade or "enhanced plastic." Only products designated by TI as military-grade meet military specifications. Buyers acknowledge and agree that any such use of TI products which TI has not designated as military-grade is solely at the Buyer's risk, and that they are solely responsible for compliance with all legal and regulatory requirements in connection with such use.

TI products are neither designed nor intended for use in automotive applications or environments unless the specific TI products are designated by TI as compliant with ISO/TS 16949 requirements. Buyers acknowledge and agree that, if they use any non-designated products in automotive applications, TI will not be responsible for any failure to meet such requirements.

Following are URLs where you can obtain information on other Texas Instruments products and application solutions:

Products		Applications	
Amplifiers	amplifier.ti.com	Audio	www.ti.com/audio
Data Converters	dataconverter.ti.com	Automotive	www.ti.com/automotive
DLP® Products	www.dlp.com	Communications and Telecom	www.ti.com/communications
DSP	dsp.ti.com	Computers and Peripherals	www.ti.com/computers
Clocks and Timers	www.ti.com/clocks	Consumer Electronics	www.ti.com/consumer-apps
Interface	interface.ti.com	Energy	www.ti.com/energy
Logic	logic.ti.com	Industrial	www.ti.com/industrial
Power Mgmt	power.ti.com	Medical	www.ti.com/medical
Microcontrollers	microcontroller.ti.com	Security	www.ti.com/security
RFID	www.ti-rfid.com	Space, Avionics & Defense	www.ti.com/space-avionics-defense
RF/IF and ZigBee® Solutions	www.ti.com/lprf	Video and Imaging	www.ti.com/video
		Wireless	www.ti.com/wireless-apps

Mailing Address: Texas Instruments, Post Office Box 655303, Dallas, Texas 75265
Copyright © 2010, Texas Instruments Incorporated

Free Manuals Download Website

<http://myh66.com>

<http://usermanuals.us>

<http://www.somanuals.com>

<http://www.4manuals.cc>

<http://www.manual-lib.com>

<http://www.404manual.com>

<http://www.luxmanual.com>

<http://aubethermostatmanual.com>

Golf course search by state

<http://golfingnear.com>

Email search by domain

<http://emailbydomain.com>

Auto manuals search

<http://auto.somanuals.com>

TV manuals search

<http://tv.somanuals.com>