

**Texas
Instruments**

**TravelMate 2000
Notebook Computer
User's Manual**

Contents

Preface	v
---------------	---

1 Taking a First Look

The Hardware	1-3
TravelMate 2000 Options	1-7
The Software	1-10
The Hard Disk	1-11

2 More About Hardware

LCD Screen	2-3
Right Side Panel	2-6
Left Side Panel	2-7
Rear Panel	2-9
Bottom Panel	2-11
Front Panel	2-12
Keyboard	2-13
Status Indicators	2-19

3 Setting Up

Guidelines & Precautions	3-2
Installing the Battery	3-3
Removing the Battery	3-5
Charging the Battery/AC Operation	3-7
Setting DIP Switches	3-9

4 Getting Started

System Start-up	4-4
Accessing the Set Up Screen	4-6
Making Selections on the Set Up Screen	4-8
Set Up Screen Fields	4-9
Setting Up the LCD	4-14
Displaying the Hardware	
Installation Screen	4-18
Making Selections on the Hardware	
Installation Screen	4-20
Hardware Installation Screen Fields	4-21
Restarting the System	4-25
Backing Up the Hard Disk	4-26

5 Application Programs

Guidelines for Installing Applications	5-3
LapLink	5-10
Laptop Manager	5-13
Using the Password Utility	5-15

6 TravelMate 2000 Options

Add-On Battery Pack	6-2
3.5-inch Floppy Drive Unit	6-5
Numeric Keypad	6-10
RAM Card	6-12
CRT	6-16
External Monitor	6-18
2400 BPS Modem with Send-Fax and MNP Class 5	6-19
80C287 Coprocessor	6-20
External Keyboards	6-24
Printers	6-25

Appendices

Specifications	A-1
Taking Care of Your Computer	B-1
Character Sets	C-1
Keyboard Layouts	D-1
Diagnostics	E-1
Troubleshooting	F-1
BIOS Messages	G-1
Configuring Memory	H-1
Connector Pin Assignments	I-1
Screen Standards	J-1
Restoring MS-DOS System Files	K-1
Warranty and Service	L-1

Glossary

Index

Copyright(C) 1990 Texas Instruments Incorporated
All Rights Reserved - Printed in U.S.A

TravelMate 2000 Personal Computer, User's Manual Part No. 2568084-0001
Original Issue: July 1990 Revision C: January 1991

Changes may be made periodically to the information in this publication. Such changes will be incorporated in new editions of this manual.

Record the serial number, purchase date, and model number in the spaces provided below. The serial number and model number are recorded on the label affixed to the case. AR correspondence concerning your unit should include the serial number, model number, and date of purchase.

TravelMate 2000 Personal Computer:

Serial Number: _____ **Purchase Date:** _____

No part of this publication may be reproduced, stored in a retrieval system, or transmitted in any form or by any means, electronic, mechanical, photocopy, recording, or otherwise, without the prior written permission of Texas Instruments Incorporated.

The equipment, as well as the programs that TI has created to use with them, are tools that can help people better manage the information used in their business. But tools-including TI products--cannot replace sound judgment nor make the manager's business decisions.

Consequently, TI cannot warrant that its products are suitable for any specific customer application. The manager must rely on judgment of what is best for Ms or her business.

TravelMate and BatteryPro are trademarks of Texas Instruments incorporated. BitCom and BitFax are trademarks of BIT Software, Inc.
Hayes is a registered trademark and Hayes SmartModem 2400 B is a trademark of Hayes Microcomputer Products Inc.
IBM PC, XT, AT and PS/2 are trademarks of International Business Machines Corporation.
Intel is a trademark of Intel Corporation.
LapLink is a trademark of Traveling Software, Inc.
Lotus is a trademark of Lotus Development Corporation.
Microcom Is a trademark and MNP is a registered trademark of Microcom, Inc.
Microsoft, MS-DOS, SHELL, and InPort Mouse are trademarks of Microsoft Corporation.

Congratulations ... you have purchased one of the most powerful notebook computers available, the Texas Instruments TravelMate™ 2000 Computer.

The TravelMate 2000 is a lightweight, full-function computer with the features and power of many desktop personal computers, including a 20-megabyte internal hard disk drive, an 80C286 microprocessor, built-in MS-DOS™ 4.01, built-in LapLink™ file transfer utility that connects your TravelMate 2000 to another computer, and many options to make your TravelMate 2000 more powerful and specialized for your particular applications.



Note: Your new TravelMate 2000 hard disk drive and the built-in ROM are already formatted and loaded with MS-DOS 4.01, GW-BASIC, Laptop Manager, Laptop File Manager, power-up diagnostics, and other utilities. **Do not** format the hard disk (drive C) or you will delete these programs. However, these programs also are included on the floppy disk furnished with your new computer so that you can restore the programs to the hard disk if necessary. Any data entered by you into the computer will be lost forever if you reformat the hard disk unless you have backed up the data on floppy diskettes.

Your TravelMate 2000 accepts a variety of options, including an external 3.5-inch Floppy Drive Unit, CRT Adaptor, Internal Modem, 80C287 Coprocessor, Add-On Battery Pack, Expansion Unit, RAM expansion cards, Numeric Keypad and printers, available from Texas Instruments. Contact your distributor or telephone TI-Express, 1-800-TI PARTS.



Preface

When you open the container in which your computer is packaged, you will find the following items:

- Computer
- Battery
- AC Adaptor
- AC Cord
- Parallel Port Conversion Adaptor
- User's Manual (this manual)
- LapLink Cable
- LapLink File Transfer Utility and Device Driver User's Manual*
- MS-DOS User's Manual*
- BatteryPro™* and *Productivity Software User's Manual* and floppy diskette
- Two Function Key template strips

If any of the above items are missing, contact your Texas Instruments dealer.

Conventions and Symbols

Throughout this manual, the following conventions are used to distinguish elements of text:

- | | |
|-------------|---|
| SMALL CAPS | Used for commands, options, switches, and literal portions of syntax that must appear exactly as shown |
| italic | Used for filenames, variables, and placeholders that represent the type of text to be entered by the user |
| Monospace | Used for sample prompts and screens that appear during operation of your computer, including prompts (text generated by the system) and entries that you type on the keyboard |
| Bold | Used for keys, key sequences, and MS-DOS prompts |

Several international symbols are used throughout this manual to advise you of important information.



This symbol indicates a **Note** concerning operating procedures or information you should know to help you operate your TravelMate 2000.



This symbol alerts you to a **Warning** or **Caution** that can prevent you from causing injury to yourself or damage to your equipment.



This symbol tells you that more information about the same subject is contained on the next page.



About this Manual

This manual describes the operation of your Texas Instruments TravelMate 2000 Notebook Computer. We have designed this manual so that you can locate information quickly and easily. Each chapter begins with a title page that gives the major sections in the chapter.

Keyboard keys are listed several ways in this manual, depending on the number of keys you must press to produce a character or function. For example, some key fronts on the keyboard are labeled with blue to indicate their use only in conjunction with the **Fn** key.

Some keys (for example, **Break** and **Num Lk**) must be pressed in conjunction with another key (for example, **Ctrl** and **Fn**) to perform their action. The text in this manual refers to these keys according to their function, preceded by the additional key you must also press. Software programs use various key combinations; refer to your software program manual for specific information.

The word *floppy* is used in this manual to refer to diskettes, microdiskettes, disks, and other terms commonly used to describe a removable, nonvolatile, magnetic-media diskette. The words *disk and diskette* are used in direct quotations, for example, in describing a displayed error message, setup menu, etc.

Contents of this Manual

Here is an overview of what to expect in each chapter:

Chapter 1 - Taking A First Look gives users who are not familiar with computers some basic information about the parts of a computer and a simple technical overview of the TravelMate 2000 and its options. Experienced users may only need to skim this chapter.

Chapter 2 - More About Hardware describes the TravelMate 2000's hardware features and explains how they work.

Chapter 3 - Setting Up tells you what to do to get your TravelMate 2000 ready for operation.

Chapter 4 - Getting Started shows how to customize the TravelMate 2000 for your own special needs.

Chapter 5 - Installing and Using Application Programs tells you about the software that comes installed in your TravelMate 2000, including the MS-DOS and GW-BASIC firmware and the LapLink and Laptop Manager utilities.

Chapter 6 - TravelMate 2000 Options describes the use of options that can improve the performance of your TravelMate 2000-Add-On Battery Pack, 3.5-inch Floppy Drive Unit, Numeric Keypad, RAM Card, CRT Adaptor, Internal Modem, 80C287 12 MHz Coprocessor, external keyboards, CRT monitors, and printers.

Appendix A - Specifications lists operating and environmental specifications for your TravelMate 2000.

Appendix B - Taking Care of Your Computer provides information for cleaning your TravelMate 2000, as well as caring for your battery and conserving battery power.

Appendix C - Character Sets illustrates and describes U.S. and international character sets used by the TravelMate 2000.

Appendix D - Keyboard Layouts illustrates the characters generated by the standard U.S. keyboard and using the **Fn** key and the **Num Lock** key, and the IBM Enhanced keyboard.

Appendix E - Diagnostics describes the diagnostics routines that are available to ensure your TravelMate 2000 is functioning properly.

Appendix F - Troubleshooting describes problems that can occur with your TravelMate 2000 and what to do about them.



Preface

Appendix G - BIOS Messages lists the error messages you may encounter and what to do about them.

Appendix H - Configuring Memory illustrates the TravelMate 2000's memory map and describes the memory options of the computer.

Appendix I - Connector Pin Assignments lists the signals produced by the standard and optional connectors on the TravelMate 2000.

Appendix J - Screen Standards lists the standard and expanded characteristics of the various displays supported by the TravelMate 2000.

Appendix K - Restoring MS-DOS Files describes the procedure for reinstalling MS-DOS system files to the hard disk from ROM.

Appendix L - Warranty and Service describes the standard warranty and outlines the procedure to follow should your TravelMate 2000 require service.

A **Glossary** of frequently used technical terms and an **Index** are included near the end of the manual to help you.

What to Read

Before performing any of the tasks below, we recommend you read the corresponding chapter(s) in this manual.

- Quick start - Chapters 3 and 4
- Setting up the TravelMate 2000 - Chapters 1 and 3
- Using the operating system - Chapter 4
- Using options - Chapters 1 and 5
- Troubleshooting and general care of the computer Chapter 1 and Appendices

Other Manuals About the TravelMate 2000

The following manuals are furnished with your new TravelMate 2000 to help you operate and maintain your computer and its optional devices.

Title	Part Number
<i>BatteryPro™ and Productivity Software User's Manual</i>	2568090-0001
<i>LapLink File Transfer and Device Driver User's Manual</i>	2568087-0001
<i>MS-DOS User's Manual</i>	2568085-0001

This chapter tells you about:

- Computer hardware such as the system main circuit board, the display, and the keyboard
- Options for your TravelMate 2000
- Software operating systems and application programs
- Caring for the Hard Disk

Contents

The Hardware.....	1-3
System Board.....	1-4
Microprocessor	1-4
RAM.....	1-5
ROM	1-5
Keyboard	1-5
LCD Screen	1-6
Hard Disk	1-6
Connectors.....	1-6
TravelMate 2000 Options.....	1-7
Add-On Battery Pack.....	1-8
3.5-inch Floppy Drive Unit.....	1-8
Numeric Keypad.....	1-8
1 M byte RAM Card	1-8
CRT Adaptor	1-9
2400 BPS Modem with Send-Fax and MNP Class 5 (Internal Modem).....	1-9
80C287 12 MHz Coprocessor	1-9
Printers	1-9
External Keyboards	1-9



Contents

The Software.....	1-10
The Hard Disk	1-11
Hard Disk Format.....	1-11
Taking Care of the Hard Disk.....	1-11

1-2 Taking a First Look

This is what the standard TravelMate 2000 Computer looks like when it is closed.

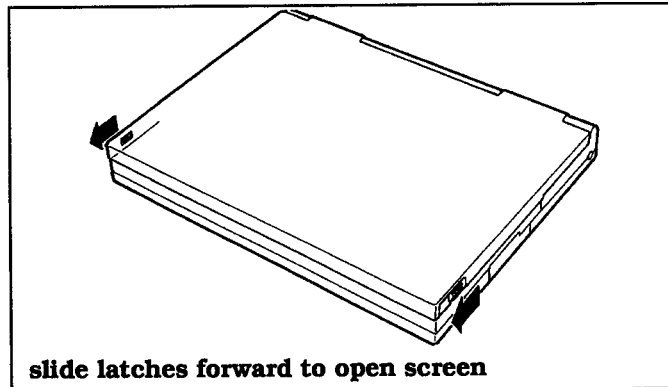

Here's how the TravelMate 2000 looks when it is set up and ready to operate.

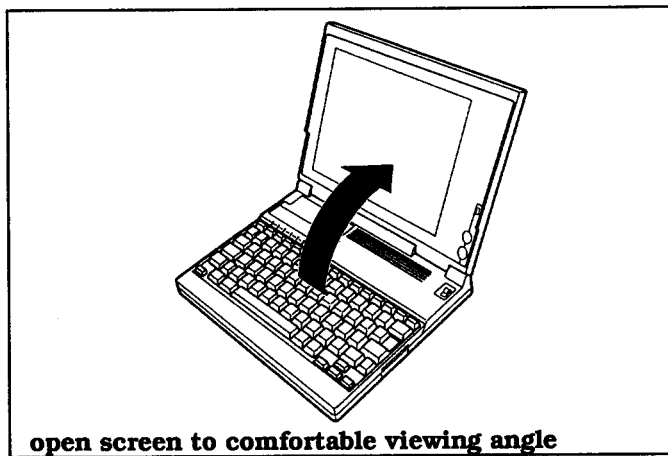

The Hardware

Let's take a closer look at each part of the computer.

The TravelMate 2000's hardware consists of a system board, keyboard, liquid crystal display (LCD) screen, hard disk drive, I/O (input/output) ports, and other electronic circuits needed to control the display and externally connectable options.

System Board

The system board carries integrated circuits that make up the microprocessor and memory. The system board also contains hardware that controls the screen and keyboard. The optional RAM cards, CRT Adaptor, Internal Modem, and 80C287 coprocessor plug into the system board.

Microprocessor

The microprocessor is the "brain" of the computer. It processes data-or information-at speeds so fast, its performance is measured in millionths of a second. The microprocessor handles information in binary code, using the digit 0 or 1. Any piece of information (e.g., a number or character) is represented by a string of 0's and 1's. For example, the number 23 in binary is 1 0 1 1 1. A 0 or 1 in the binary system is referred to as a bit, the smallest piece of information handled by the processor. A byte is a group of eight bits, and represents a single character or number, such as "H" or "9". The microprocessor in the TravelMate 2000 is a high-speed 80C286 microprocessor, running at a clock speed of up to 12 MHz.

RAM

RAM (Random Access Memory) stores data and application software for the processor. You can write to or read from RAM freely, but once the power is turned off, the data in RAM is lost. RAM size is described by the amount of information (bytes) it can store. Symbols often used for this are "K" and "M". One K byte (1 K byte) represents 1024 bytes and one M byte (1 M byte) represents 1024 K bytes. The TravelMate 2000 has a standard RAM size of 1 M byte. This can be increased to 3 M byte by installing two optional 1 M byte RAM cards.

ROM

ROM (Read-Only Memory) contains factory-programmed information, which remains stored even with the power off. You can never change the contents of ROM. The TravelMate 2000 has two ROM areas. One stores the IPL (Initial Program Loader), BIOS (Basic Input/Output System), and setup and hardware installation functions. These programs are sometimes referred to as firmware. The other ROM area stores the diagnostics program, LapLink program, and the operating system, MS-DOS 4.01. This area is called a ROM disk and is used to install MS-DOS on the hard disk.

Keyboard

You communicate with the computer by typing on the keyboard. Many of the keys work just like those on a regular typewriter. However, as you will see, some of the keys have special functions not available on a typewriter. The TravelMate 2000 keyboard is modeled after the IBM 101/ 102 -key enhanced keyboard layout.



The Hardware

LCD Screen

The LCD screen acts as a window where the computer sends information for you to view. Information entered on the keyboard, read from the hard disk or a floppy, or sent via a modem, for example, is displayed on the screen. The TravelMate 2000's LCD screen can be set to emulate industry standard display modes, including the VGA mode used by IBM in its latest PS/2 series of personal computers, and displays colors as 16 shades of gray. The illuminated, triple supertwist, LCD screen gives you maximum readability in all lighting conditions with a true black-on-white display.

Hard Disk

The hard disk can store up to 20 M byte of information the equivalent of about 14 high-density floppies-and can write and read data very quickly. This makes the hard disk the best place to keep the programs that you use most frequently.

Connectors

The parallel port is used to connect a parallel printer via the supplied conversion adaptor, and the serial RS-232C port is used to connect an external modem, a serial printer, and other devices that use a serial connector. An expansion bus connector is used to connect the optional Expansion Unit (TI Part No. 2568032-0001) or 3.5-inch Floppy Drive Unit RI Part No. 2568031-0001) to the computer. A numeric keypad connector is used to connect the optional Numeric Keypad (TI Part No. 2568033-0001) to the computer. The external battery connector is used to connect the Add-On Battery Pack (TI Part No. 2568030-0001) to the computer.

The performance of a standard TravelMate 2000 can be enhanced with the addition of hardware options available from Texas Instruments. These options enable you to send and receive data over telephone lines, operate the computer for longer periods, use external displays, increase memory, and a variety of other features.

TravelMate 2000 Options

The following hardware options are available from your Texas Instruments dealer or TI-Express, 1-800-TI-PARTS, for use with the standard TravelMate 2000 to expand its capabilities. See Chapter 6 for information about installing these options.

- Add-On Battery Pack (TI Part No. 2568030-0001)
- 1.44 M byte 3.5-inch Floppy Drive Unit (TI Part No. 2568031-0001)
- Expansion Unit (TI Part No. 2568032-0001)
- Numeric Keypad (TI Part No. 2568033-0001)
- 1 M byte RAM Card (TI Part No. 2568034-0001)
- CRT Adaptor (TI Part No. 2568035-0001)
- 2400 bps Modem with send FAX capabilities and MNP Class 5 (TI Part No. 2566941-0001)
- 80C287 12 MHz Coprocessor (TI Part No. 2560874-0001)
- Deluxe carrying case (TI Part No. 2568069-0001)
- Extra Internal Battery Pack (TI Part No. 2568094-0001)



TravelMate 2000 Options

- Laser and impact Printers
- External Keyboards

Add-On Battery Pack

Attaching the optional Add-On Battery Pack to the rear of the TravelMate 2000 adds 3 hours to the operating time. When the Add-On Battery Pack is installed, you cannot use the 3.5-inch Floppy Drive Unit or the Expansion Unit.

3.5-inch Floppy Drive Unit

Using the 3.5-inch Floppy Drive Unit allows you to store information on 1.44 M byte floppies. The 3.5-inch Floppy Drive Unit also has a port with which you can install a 5.25-inch floppy drive, not available from Texas Instruments, and an external keyboard as well.

Expansion Unit

Connecting the Expansion Unit allows you to expand the capabilities of your TravelMate 2000 Computer. The Expansion Unit supports one full-size and one half- size expansion card.

Numeric Keypad

Connecting the Numeric Keypad allows you to enter numeric data easily. The Numeric Keypad is laid out like the numeric keypad on an IBM keyboard.

1 M byte RAM Card

Using one or two RAM cards allows you to increase the amount of random access memory in your TravelMate 2000. The memory on these cards can be used as Extended memory or as Expanded memory conforming to version 4.0 of the Lotus/Intel/Microsoft Expanded Memory Specifications.

CRT Adaptor

Installing the CRT Adaptor into the computer allows you to connect a VGA or multi frequency monitor to the TravelMate 2000.

2400 BPS Modem with Send-Fax and MNP Class 5 (Internal Modem)

Installing the internal modem card in the TravelMate 2000 allows you to send Facsimile (fax) information over telephone lines.



Note: The Internal Modem Card may not be available in some countries. For information on this option, see the manual provided with the option.

80C287 12 MHz Coprocessor

Adding an 80C287 coprocessor to the system board significantly improves processing performance when you are running programs that support a math coprocessor.

Printers

Connecting a printer to your TravelMate 2000 allows you to produce a hard copy of information you have created. To connect a parallel printer, use the supplied conversion adaptor between the parallel port and the TravelMate 2000 printer port. To use a serial printer, simply connect the printer to the serial port of the TravelMate 2000.

External Keyboards

Using the 6-pin mini DIN connector on the 3.5-inch Floppy Drive Unit allows you to connect an additional IBM PS/2 or equivalent keyboard.

The Software

A computer system needs software before it can carry out any useful task. Without software, your computer is just a collection of electrical components. In order to use computer hardware for tasks like writing memos or balancing a checking account, software is necessary.

Software is a series of instructions that direct the computer to perform specific tasks. Generally, these instructions are loaded from a floppy or a hard disk into main memory where they remain until the software program is exited or the system is turned off.

Your computer needs three levels of software to function - an input/output system, an operating system, and an application program.

- The BIOS (basic input/output system) is stored in ROM on the system board. The BIOS controls the input/output functions of the hardware itself, according to information received from the operating system or software program, also known as BIOS calls.
- The operating system is a software program that manages the computer's resources, such as disk drives and printers. By performing these general routines, the operating system is the base on which programming languages like GW-BASIC and application programs run. The operating system for this computer is MS-DOS, version 4.01, and is stored in the ROM disk and on the hard disk.
- An application program is software that helps you perform business and personal tasks such as word processing, spreadsheet analysis, and graphics presentations. Almost all of the application programs written to run with MS-DOS on IBM and compatible personal computers can be used with the TravelMate 2000.

The Hard Disk

The hard disk is a permanently installed magnetic disk. Information is read from and written to both sides of the disk at extremely high speeds by heads that float above the disk surface on a cushion of air. When the disk is not actually being used, these heads automatically "park" themselves out of the way to prevent the disk surface from being damaged by head movement.

Hard Disk Format

The hard disk has a platter, which is divided into cylinders. A cylinder is a collection of tracks in the same position on different sides of the hard disk platters.

The tracks of each cylinder are further divided into sectors. Each sector is numbered and holds 512 bytes of data. The computer locates data on the disk by looking for its sector number.

The hard disk in the TravelMate 2000 is formatted and loaded with software by Texas Instruments during assembly. **Do not** format the hard disk.



Caution: If you format the hard disk, all data on the hard disk will be lost.

Taking Care of the Hard Disk

The hard disk in your TravelMate 2000 computer is specially designed to withstand the rigors of travel: the hard disk heads automatically park themselves when the computer is turned off. However, it is still a precision device and careful treatment will prolong its life.

Follow these guidelines to get the most out of your hard disk's performance:

- Never move the computer when the hard disk is being accessed.



- Never subject the computer to strong vibration or sudden shocks, especially during transportation.
- You can move your computer with the power on; however, it is a good idea to put the computer in Standby mode.
- Always keep backup floppies of all programs and data stored on your hard disk, just in case of a hard disk failure. The time spent backing up your data is always worthwhile.



Caution: You should back up your hard disk to floppies on a regular basis to protect against loss of data because of a hard disk failure. Follow the MS-DOS backup procedure in your MS-DOS manual or use a backup procedure provided by your application program. If your hard disk fails, TI service personnel may or may not be able to save some or most of the contents of your hard disk if replacement is required.

- When moving your computer to a location where the temperature is more than 18° F (10° C) different from the present location, do the move in two stages: first leave the computer in a place where the temperature is somewhere between that of the new location and the old location for about 1 hour. Then move the computer to the new location. This ensures that the hard disk mechanisms have time to adjust to the new environment and prevents moisture from condensing on the vital parts.
- In case of a hard disk failure, contact Texas Instruments at 1-800-847-5757 for information about data recovery.

This chapter tells you about:

- Your LCD screen and how to adjust it
- Controls and connectors on the sides of the TravelMate 2000 case
- Common keyboard key assignments
- Indicators and their meanings

Contents

LCD Screen	2-3
Resolution.....	2-3
Screen Angle.....	2-4
Backlight.....	2-4
Standard/Reverse Switch.....	2-4
Contrast Control.....	2-5
Brightness Control	2-5
Right Side Panel.....	2-6
Numeric Keypad Connector.....	2-6
Security Hook Holder	2-6
Left Side Panel.....	2-7
Parallel (Printer) Port.....	2-7
LCD/CRT Switch	2-8
Serial (RS-232C) Port.....	2-8
Rear Panel	2-9
Expansion Bus Connector	2-9
Add-On Battery Pack Connector.....	2-9
AC Adaptor Jack	2-10
Bottom Panel.....	2-11
Battery Slot.....	2-11
Front Panel	2-12
Power Switch	2-12
Optional Card Slot Cover	2-12



Contents

Keyboard	2-13
Enter Key	2-14
Shift	2-14
Caps Lock	2-14
Tab	2-15
Backspace	2-15
Ctrl	2-15
Alt	2-15
Alt Gr	2-15
Fn	2-15
Cursor Control Keys	2-16
Esc	2-16
Function Keys	2-16
Ins (Insert)	2-16
Del (Delete)	2-17
Num Lk	2-17
Scr Lk	2-17
Pause	2-17
Break	2-17
Sys Rq	2-17
Prt SC	2-18
Set Up	2-18
Status Indicators	2-19
Power	2-19
Low Battery	2-19
Charge	2-19
Floppy Disk	2-19
Hard Disk	2-20
Caps Lock	2-20
Num Lock	2-20
Scroll Lock	2-20

Your TravelMate 2000 displays text and graphics on a triple supertwist, illuminated, liquid crystal display (LCD), giving true black-on-white contrast. The TravelMate 2000 can emulate IBM's video graphics array (VGA), and it displays colors as 16 shades of gray.

You also can connect an external monitor to the TravelMate 2000 if the optional CRT Adaptor is installed. External monitor options are described in "TravelMate 2000 Options" in Chapter 6.

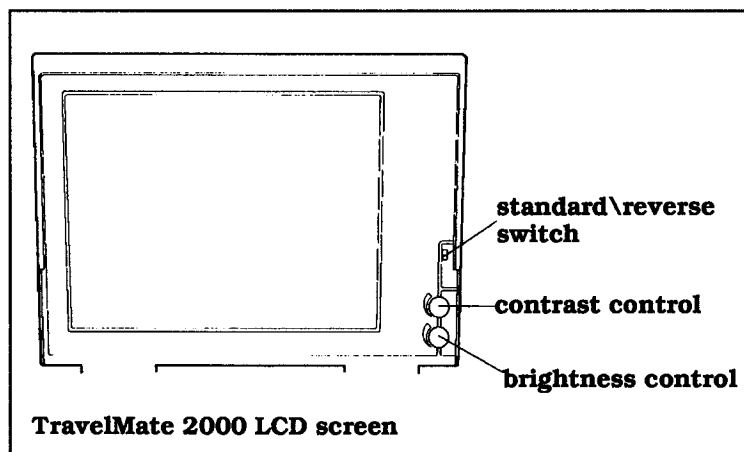

Resolution

The screen displays a maximum resolution of 640 dots horizontally by 480 dots vertically. The actual display resolution depends on which display mode you select on the Hardware Installation screen and the display mode your application program is designed to use.

The display adaptor in the TravelMate 2000 allows you to select display modes for the LCD screen. (See the Hardware Installation Screen described in Chapter 4.)



LCD Screen

Screen Angle

The LCD screen can be adjusted for the best viewing angle, but be careful not to tilt the screen more than necessary. Appropriate angles are 90° to 132° from horizontal.



Caution: To ensure safety and save battery, power, an alarm sounds for about 90 seconds when the screen is closed with the power on. The TravelMate 2000 is designed so that it can be used with the screen closed, for instance, when running a demonstration program with an external monitor. Nevertheless, never transport the computer with the power on.

Backlight

The illuminated screen allows you to control background brightness for better readability. The backlight goes on automatically when the computer is turned on. To conserve battery power, the backlight can be automatically turned off if there is no activity for a certain length of time: this time period can be set on the Set Up screen described in Chapter 4. Pressing any key on the keyboard turns the backlight on again.

Standard/Reverse Switch

The screen normally displays black characters on a white background. You can reverse this to display white on black by changing the setting of the Standard/Reverse switch on the right of the screen panel from Standard to Reverse.

Sometimes graphic images display like a photographic negative on the LCD screen. Reversing the display should correct this effect. You can change this setting with the power on.

Contrast Control

The Contrast Control adjusts the contrast between the displayed information and the background for the best viewing condition. Use in conjunction with the Brightness Control.

Brightness Control

The Brightness Control adjusts the brightness of the illuminated display. Use in conjunction with the Contrast Control.



Note: The brighter the setting on the display means more wear on the screen and more power consumption. To conserve battery power and reduce wear on the screen, use the lowest brightness setting possible.



Right Side Panel

The right side panel on the computer contains the numeric keypad connector and the security hook holder, as shown and described below.

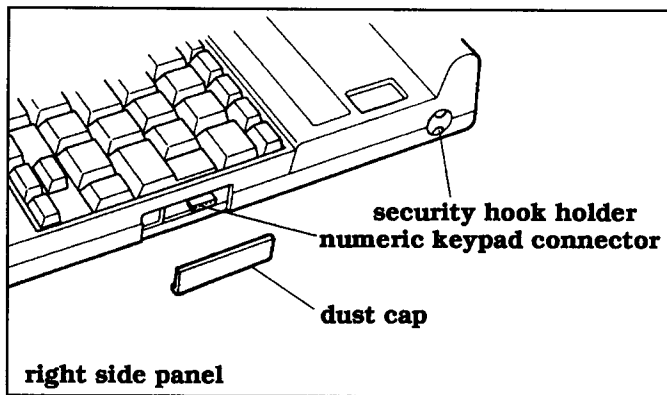

Numeric Keypad Connector

The Numeric Keypad connector connects the optional Numeric Keypad to your computer.



Note: A dust cap is provided for the Numeric Keypad connector. Remove and store this cap in the slot in the underside of the Numeric Keypad while the connector is in use.

Security Hook Holder

The Security Hook Holder attaches to metal fittings to help prevent theft of the computer.

There are two connectors and a slide switch on the left side panel of the computer, as illustrated and described below.

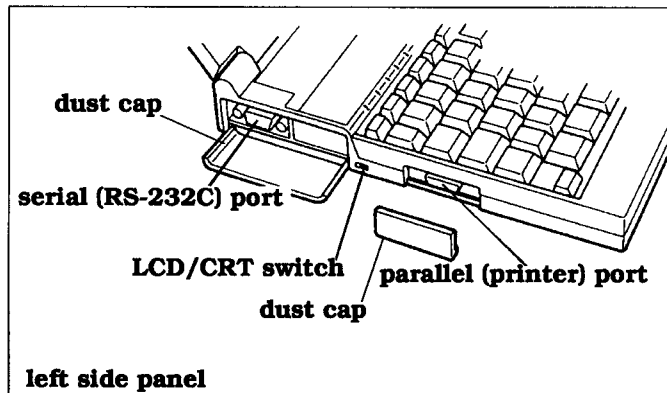

Caution: Connections and settings made on the left side of the computer must be done with the power off.

Parallel (Printer) Port

You can connect a printer or other device that uses a standard Centronics parallel interface to the TravelMate 2000 via the supplied conversion adaptor. The cable from the printer or other device must terminate in a 25-pin IBM-PC-style male connector to connect to this port. Specifications for this connector are given in Appendix H.



Note: A dust cap is provided for the parallel port. Remove and store this cap in the slot in the underside of the conversion adaptor while the parallel port is in use, and replace the cap when the parallel port is not in use.



Left Side Panel

LCD/CRT Switch

The TravelMate 2000 can display on either the standard LCD screen or on an external VGA monitor connected to the optional CRT Adaptor. Set the LCD/CRT switch appropriately. When the switch is set to CRT with the optional CRT Adaptor installed, the computer LCD screen is off. Always change the switch setting with the power off. See Chapter 6 for details on the CRT Adaptor and compatible CRTs.

Serial (RS-232C) Port

The RS-232C serial port is located behind a cover on the left side panel. This port connects I/O devices such as a serial printer, mouse, or an external modem for data communications. The cable that connects to this port must terminate in a 9-pin female IBM-AT-style connector. For detailed specifications, see Appendix H.



Caution: The dust cap for the serial port is connected to the unit. Do not try to force this dust cap off.

The rear panel of the computer has two connectors and an AC Adaptor jack.

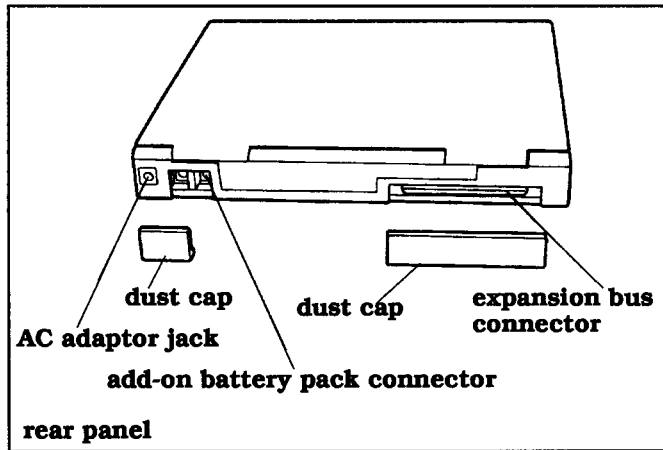

Expansion Bus Connector

The optional Floppy Drive Unit or the optional Expansion Unit plugs into the expansion bus connector on the rear of the TravelMate 2000. For details, see Chapter 6.

Add-On Battery Pack Connector

The optional Add-On Battery Pack plugs into the Battery pack connector. For details, see Chapter 6.



Note: Dust caps are provided for the expansion bus connector and Battery pack connector. Remove the caps and store them in the undersides of the options while the connectors are in use, and replace the caps when the connectors are not in use.



Rear Panel

AC Adaptor Jack

The AC Adaptor plugs into this jack for recharging the battery or supplying ac power to the computer. See Chapter 3 for instructions on how to recharge the battery.



Caution: Use only the supplied AC Adaptor with your TravelMate 2000 Computer. Other adaptors may not match the power requirements of the TravelMate 2000 and can cause serious damage to the system.

Battery Slot

The bottom panel of the computer has a slot for the supplied internal battery. For battery installation instructions, see Chapter 3.

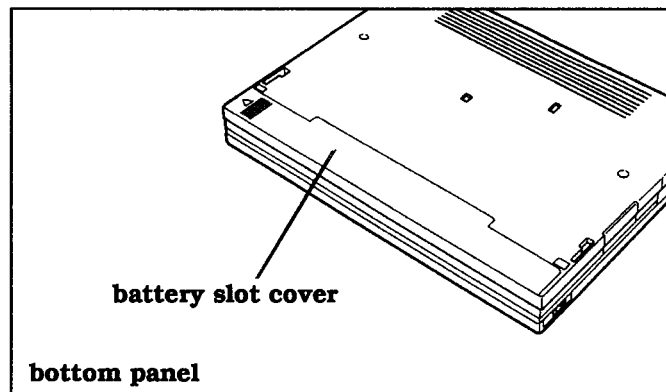

Front Panel

The front panel of the computer has a power switch, an optional card slot cover, a keyboard, and eight indicators.

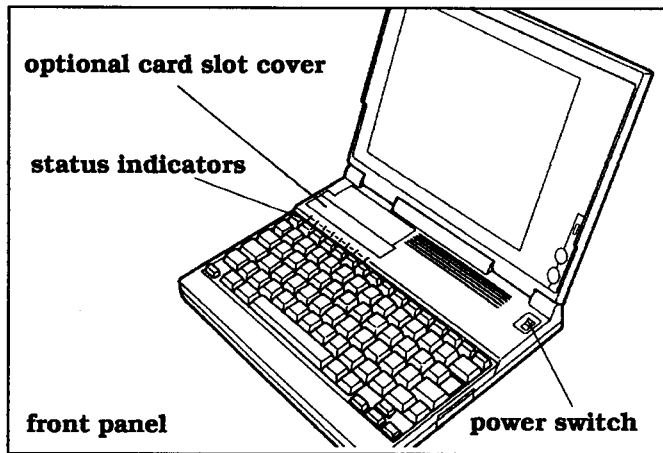

Power Switch

The power switch turns the power to the computer on and off for both battery-powered and ac operation. Set the switch to the **I** position to turn on the computer and to the  position to turn off the computer.

Optional Card Slot Cover

A cover for the optional card slot is located on the rear left of the front panel. The optional CRT Adaptor or Internal Modem Card can be installed in this slot. For details, see Chapter 6.

The TravelMate 2000 keyboard provides all the functions of the IBM enhanced keyboard. Many of the keys on the keyboard are similar to those on a standard typewriter. There are some keys, however, that might not be familiar to you. The following is a description of keys not found on a standard typewriter.



Note: MS-DOS and certain applications use keys for special purposes which are not defined here. Refer to your software and MS-DOS manuals.

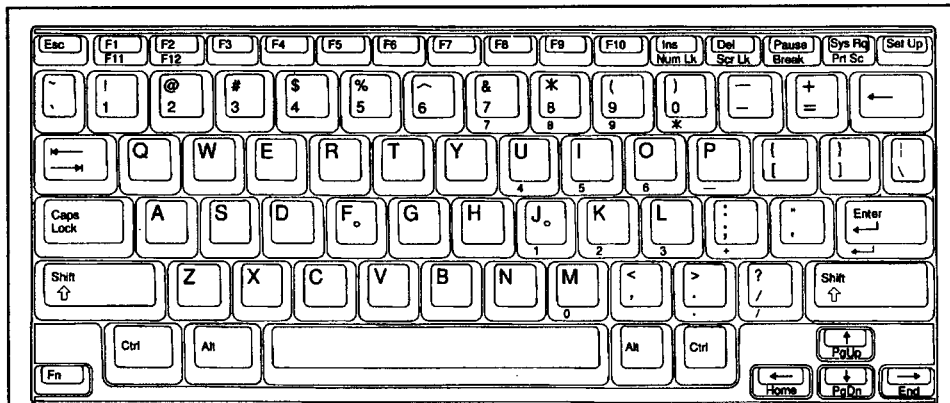

U.S. English Keyboard

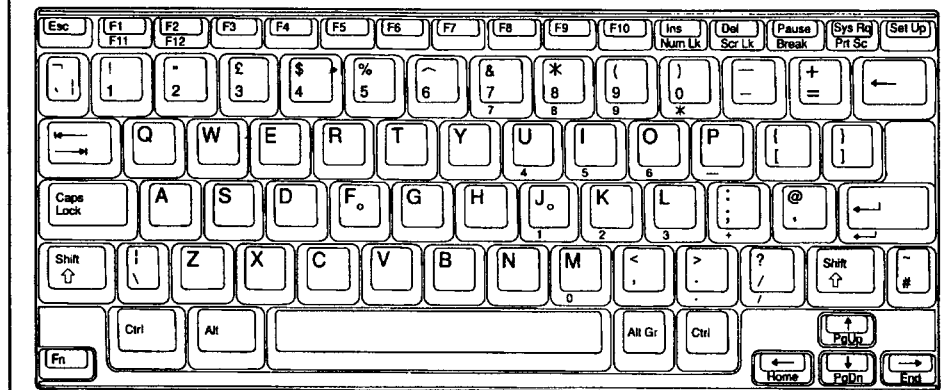

U.K. English Keyboard



Keyboard

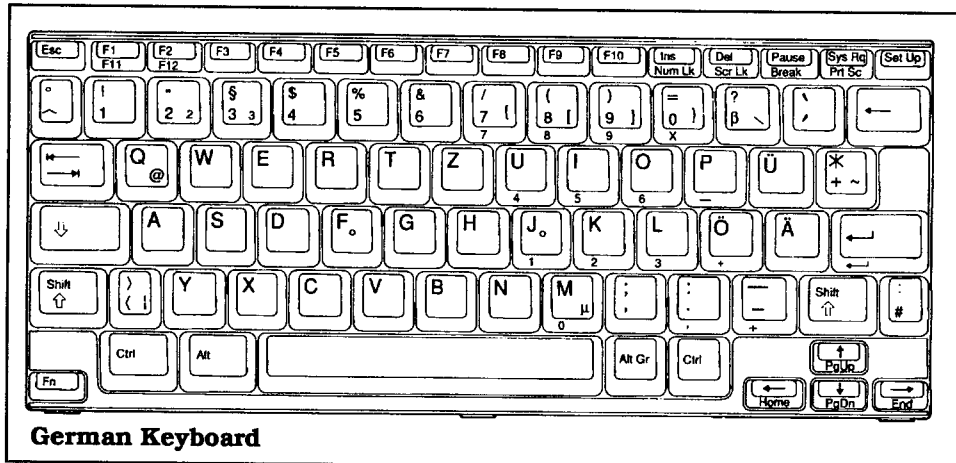

Enter Key

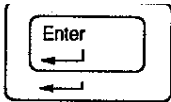

The **Enter** key is generally used to end a line or menu entry and move to the next one; also referred to as the Return key.

Shift

There are two identical **Shift** keys. Any alphanumeric key pressed while the **Shift** key is held down gives that key's uppercase character or the symbol on the top of the keytop. When the **Caps Lock** key is on, the **Shift** keys work in reverse for alphabetic characters, giving a lowercase letter.

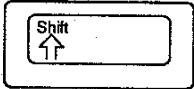

Caps Lock

The **Caps Lock** key makes all the alphabet letters you type uppercase. It is a toggle key; pressing it once turns it on and pressing it again turns it off. When the **Caps Lock** key is on, the **Caps Lock** indicator is lit.

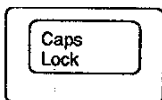

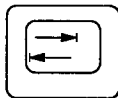

Tab

The **Tab** key works like the tab key on a regular typewriter. Pressing the **Shift** key with the **Tab** key allows you to backtab.

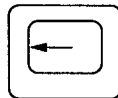

Backspace (←)

The ← (**Backspace**) key moves the cursor to the left one space at a time, erasing the character to the left of the cursor.



Ctrl

There are two identical **Ctrl** (Control) keys. The **Ctrl** key changes the function of another key when the two are pressed at the same time. For example, under MS-DOS, pressing the **Pause** key while holding down **Ctrl** sends a **Break** to stop the current program execution.



Alt

Like the **Ctrl** key, the two identical **Alt** (Alternate) keys give an alternate function to another key.



Alt Gr

On European keyboards, the **Alt Gr** (Alternate Graphics) key is located to the right of the **Spacebar**. The key is used to enter the characters printed on the lower right of keytops. On other keyboards, a second **Alt** key is located in this position.



Fn

The **Fn** (Function) key is used to access numbers, characters, or functions printed in blue on the front of the keys. See Appendix G for keyboard layouts using the **Fn** key.



Keyboard



Cursor Control Keys

The four arrow keys move the cursor by spaces or lines in the direction of the keytop arrows. The **Fn** key shifts the functions of these keys to **Home**, **End**, **PgUp**, and **PgDn**. These cursor and screen control functions may vary according to the software application. Refer to your software application manual for use of these keys. See Appendix G for keyboard layout variations when the **Fn** key is used.



Esc

The **Esc** (Escape) key is frequently used in applications to cancel a command or exit the application. See the *BatteryPro and Productivity Software User's Manual* for the use of this key.



Function Keys

There are ten function keys, **F1** through **F10**, in the row above the typewriter keys. Two additional function keys, **F11** and **F12**, are available by pressing the **F1** and **F2** keys with the **Fn** key. The function keys perform editing functions in MS-DOS (see your MS-DOS manual) and have application-defined functions at other times. Refer to your application software manual to see which functions are assigned to these keys.



Note: There is a blank template directly above the function keys where you can label the function of each key for your applications on the supplied template strips.



Ins (insert)

The **Ins** (Insert) key is used to toggle the insert mode on and off in MS-DOS and many applications. In insert mode, every character you type appears after the cursor position, moving the existing characters one space to the right instead of typing over them.



Del (Delete)

The **Del** (Delete) key is used to delete the character at the cursor position. In MS-DOS and many applications, remaining characters usually move left to fill the space.



Num Lk

The **Num Lk** key (**Fn - Ins**) toggles the numeric keypad keys on and off. When the **Num Lk** key is on, the **Num Lock** indicator is lit. When toggled on, the numbers in blue on the front faces of certain typewriter keys become active, giving a numeric keypad layout. See the Appendix D for details on keyboard layouts.



Scr Lk

Pressing the **Fn** and **Del** keys together gives you the **Scr Lk** (Scroll Lock) key. This key has no fixed function of its own, but has special functions in some application programs. Refer to your application software manual for specific use of this key. When this key is on, the **Scroll Lock** indicator is lit.



Pause

The **Pause** key temporarily stops the display from scrolling until another key is pressed on the keyboard.



Break

Pressing the **Pause** key while holding down the **Ctrl** key gives you the **Break** key, which sends a break signal to stop current program execution.

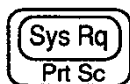

Sys Rq

The function of the **Sys Rq** (System Request) key is not fixed and varies according to the software application. Check your application software for details.



Keyboard



Prt Sc

Pressing the **Fn** and **Sys Rq** keys together gives you the **Prt Sc** (Print Screen) key. This prints whatever is displayed on the screen when a printer is connected. Note that the MS-DOS utility GRAPHICS.COM must first be executed in order to print graphic displays: otherwise, only text characters will be printed. When used with the **Ctrl** key, the **Prt Sc** key prints line by line as you press the **Enter** key. See the description of MS-DOS keyboard functions in your MSDOS manual.

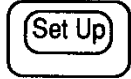

Set Up

The **Set Up** key displays the screen at which you set default values for the basic operation of the computer. See Chapter 4 for details on the Set Up screen. Pressing the **Set Up** key and the **Fn** key together (**Set Up - Fn**) changes palettes in the RPAL utility. See the *BatteryPro and Productivity Software User's Manual* for details.

There are eight status indicators on the upper left of the keyboard which light to show the state of the battery, keyboard and drives.

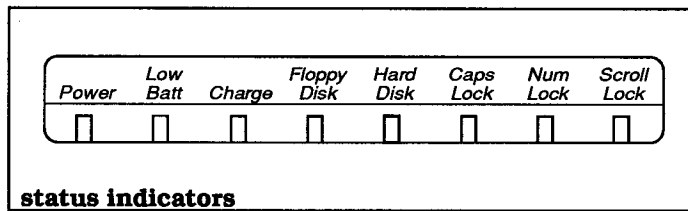

Power

The **Power** indicator lights green when the power is on, and lights orange when the computer is in the standby mode.

Low Battery

With the battery in the normally charged state, the **Low Batt** indicator remains off. When the battery is more than roughly 90 percent discharged, the indicator turns red. An alarm then beeps for about 15 seconds. If this occurs, plug in the AC Adaptor immediately. If you continue using the computer without plugging in the AC Adaptor, the indicator begins to blink and the alarm beeps again. After approximately 30 seconds of blinking and beeping, the computer is automatically turned off and the contents of memory are lost.

Charge

With the computer turned off, the **Charge** indicator blinks while the internal battery is being charged, and illuminates when the battery is at least 90 percent charged.

Floppy Disk

The **Floppy Disk** indicator comes on when the optional 3.5 inch Floppy Drive Unit is being accessed.



Status Indicators

Hard Disk

The **Hard Disk** indicator comes on when the computer writes to or reads from the built-in hard disk.

Caps Lock

The **Caps Lock** indicator comes on when you press the **Caps Lock** key to toggle on the caps lock function.

Num Lock

The **Num Lock** indicator comes on when you press the **Num Lk** key (**Fn - Ins**) to toggle the numeric keypad lock function.

Scroll Lock

The **Scroll Lock** indicator comes on when you press the **Scr Lk** key (**Fn - Del**) to toggle on the scroll lock function.

This chapter tells you about:

- ❑ Operating and storage environments for your Travel-Mate 2000
- ❑ Installing, removing, and charging the battery
- ❑ Setting the DIP switches

Contents

Guidelines & Precautions.....	3-2
Operating Environment	3-2
Operating Guidelines	3-2
Installing the Battery	3-3
Removing the Battery 3-5	
Charging the Battery/AC Operation.....	3-7
Setting DIP Switches	3-9



Guidelines & Precautions

Use your TravelMate 2000 according to the following environmental specifications and operating guidelines.

Operating Environment

When using your computer, always try to ensure that the temperature and humidity of the surroundings fall within the following ranges.

Temperature

Operating:	10° C to 35° C (50° F to 95° F)
Storage:	20° C to 60° C (-4° F to 140° F)

Relative Humidity (Noncondensing)

Operating:	20 to 80%
Storage:	10 to 90%

Operating Guidelines

Use a standard ac outlet when operating the computer with the AC Adaptor. Make sure the outlet supplies the correct voltage for your TravelMate 2000.

For information on how to install hardware options, see Chapter 6 of this manual and the instruction sheet supplied with the option.

Installing the Battery]

Follow these steps to install the battery. Charging the battery is described later.

1. Turn the computer off and disconnect the AC Adaptor.
2. Carefully turn the computer over on a padded surface. Then remove the battery cover by sliding it to the left.

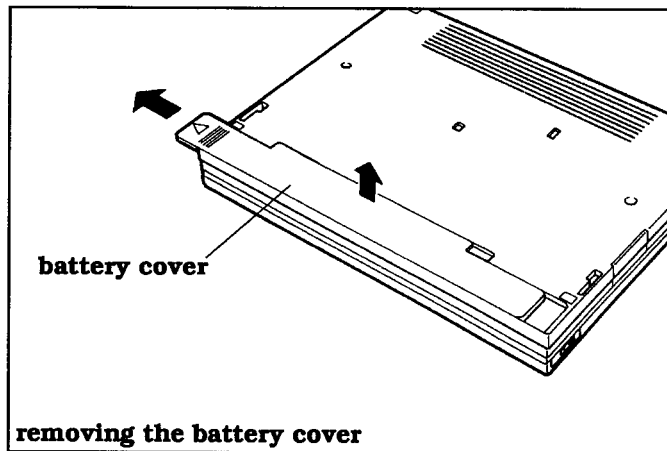

3. Plug the connector from the battery into the connector inside the case.

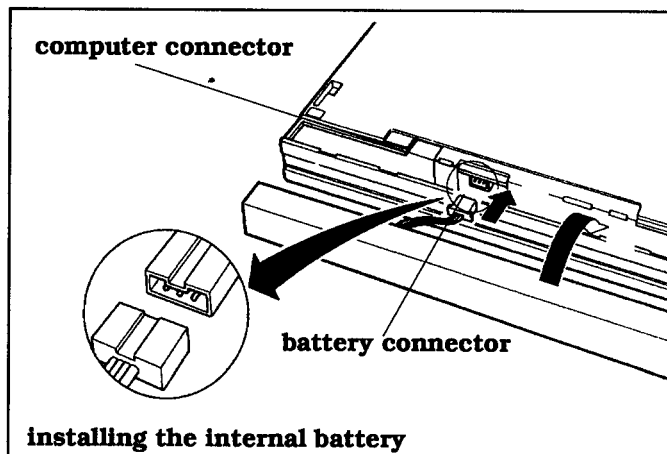

Installing the Battery



Note: When installing the battery, be careful to keep the lead wires out from under the battery.

4. Set the battery into the case.
5. Replace the battery cover by aligning the tabs on the cover with the slots on the computer, then slide the cover to the right.

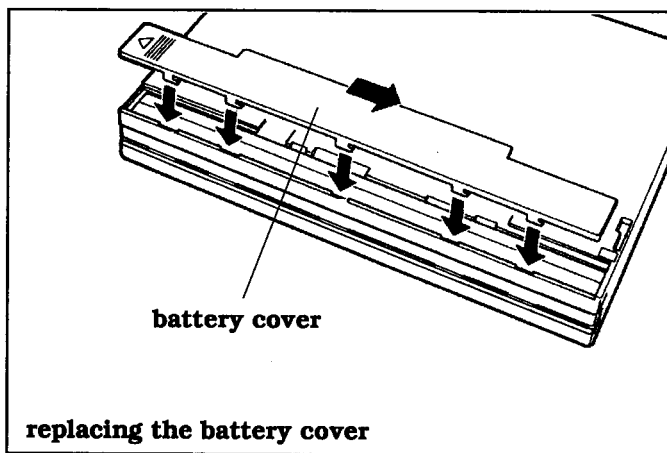

Removing the Battery

To remove the battery (when installing an internal option, for example):

1. Turn off the computer and disconnect any external devices.
2. Position the computer with the bottom panel facing up and remove the battery cover by sliding it to the left.

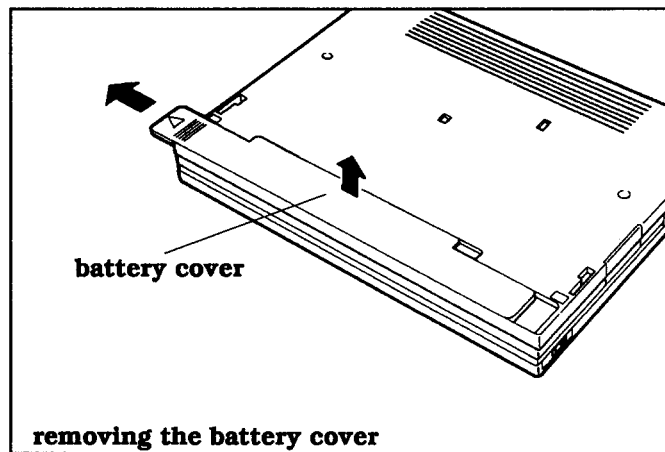

Removing the Battery

3. Covering the battery slot with your hands, turn the computer over and take out the battery.
4. Disconnect the battery connector.

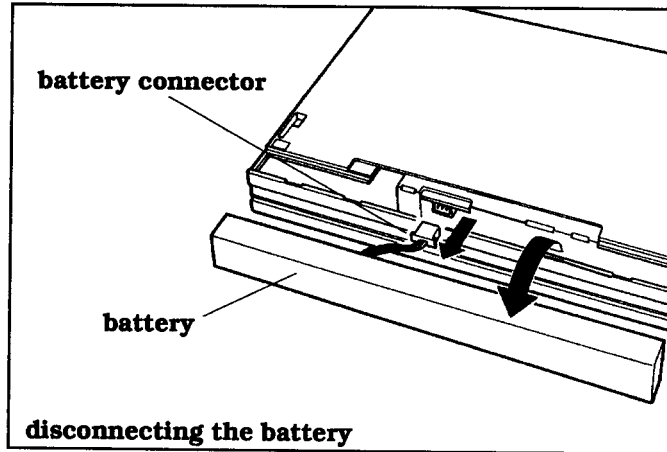

5. Replace the battery cover by aligning the tabs on the cover with the slots on the computer, then slide the cover to the right.

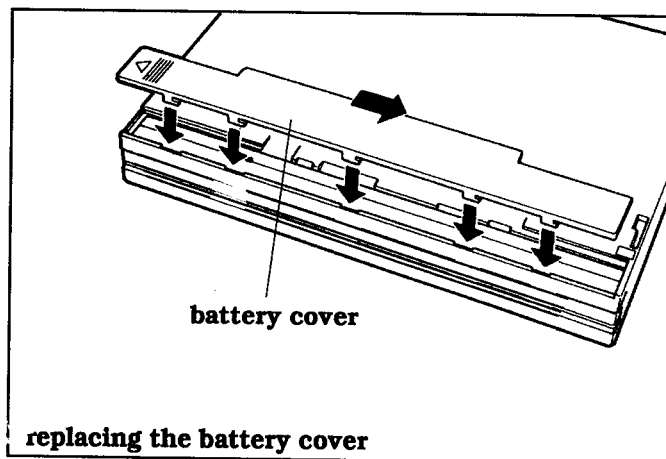

Charging the Battery/AC Operation

The AC Adaptor supplied with your TravelMate 2000 can be used to charge both the internal battery and the optional Add-On Battery Pack, as well as to operate the computer on ac power,



Caution: Use only the AC Adaptor supplied with your TravelMate 2000. Using another adaptor can damage your computer. Be sure to plug the AC Adaptor into a grounded outlet or use a grounded plug adaptor.

It takes about 2 hours to fully recharge the internal battery with the power to the computer turned off. The Add-On Battery Pack takes about 3.5 hours to recharge. The batteries are also being slowly charged while you operate the computer on ac power.

A fully charged internal battery allows the computer to run for up to 2 hours. The Add-On Battery Pack provides approximately 3 hours of operation and the add-on battery/internal battery combination can provide up to 5 hours of operation.

NiCad batteries tend to lose capacity if they are never fully discharged. An unconditioned battery—one that is brandnew, one installed in a computer that has not been used for a long time, or one that has sat uninstalled for a long time must be conditioned before it will achieve maximum life. Otherwise, your battery will hold a shorter charge than it is capable of holding.

To condition and charge the battery, follow these steps.

1. Install the internal battery if it is not already installed in your computer.
2. Allow the battery to fully discharge by using the computer on battery power.



Charging the Battery/AC Operation

3. After the battery is completely discharged, recharge the battery completely using the AC Adaptor.
 - a. Plug the female end of the supplied ac cord into the inlet on the AC Adaptor body.
 - b. Plug the male end of the ac cord into a grounded outlet. Use a grounded plug adaptor if necessary.
 - c. Plug the cord from the AC Adaptor into the jack on the rear panel of the computer.

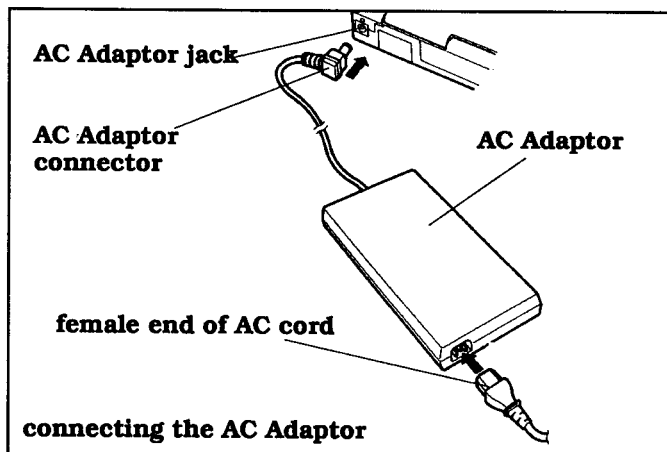

The **Charge** indicator on the front of the computer blinks while the battery is charging, then illuminates when the battery is 90 percent charged. The battery takes about 2 hours to completely charge.

4. Allow the battery to fully discharge again using the computer normally on battery power.
5. Recharge the battery completely a second time. Your battery is now conditioned and able to achieve maximum life.

Setting DIP Switches

Two DIP switches are provided inside the computer. These switches allow you to control whether an alarm sounds when certain conditions are met.

1. Turn off the computer and disconnect the AC Adaptor if installed.
2. Locate the option card slot cover on the top left of the computer.
3. Remove the template strip on the top of the keyboard; this reveals a groove. Hook a flat-headed object in the groove and open the option card slot cover.

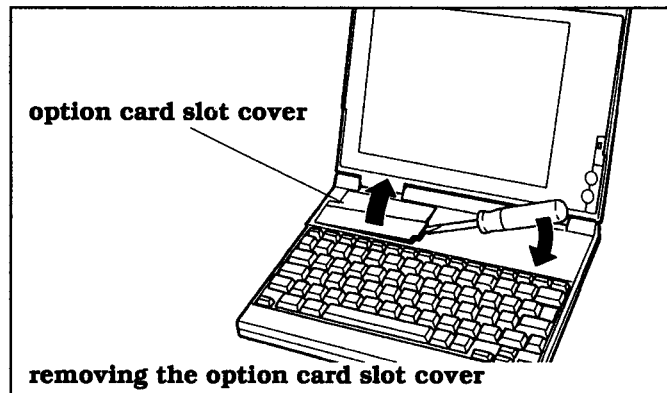

4. You will find the DIP switches inside the slot. If any option card is installed in the slot, remove the card to reveal the DIP switches, and store the card in a static free or protected bag.

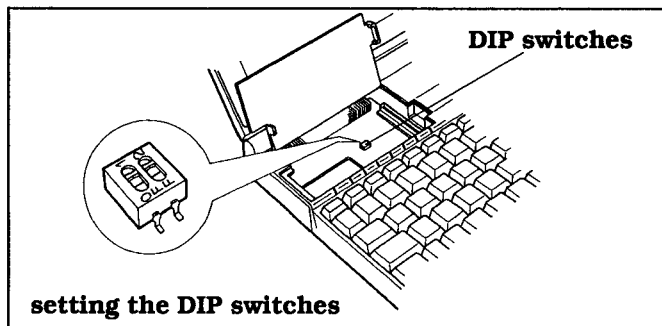

Setting DIP Switches

5. Set these two DIP switches appropriately using a pointed object such as a ball-point pen. The DIP switches are used to control the following functions:

Switch 1	Screen Closed Alarm/ System Speaker
ON	On
OFF	Off

Switch 2	Low Battery Alarm
ON	On
OFF	Off



Note: Change the DIP switch settings only when the power is off.

This chapter tells you about:

- Starting up your TravelMate 2000
- Defining your set-up options
- Setting up your LCD
- Configuring your hardware

Contents

System Start-up	4-4
Restoring Your System Configuration.....	4-5
Laptop Manager Screen	4-6
Accessing the Set Up Screen.....	4-7
Accessing the Set Up Screen from MS-DOS	4-7
Accessing the Set Up Screen Directly.....	4-7
Making Selections on the Set Up Screen	4-8
Set Up Screen Fields.....	4-10
Clock	4-10
Time	4-10
Date	4-10
Display	4-10
Cursor Type.....	4-10
LCD Mode.....	4-10
Keyboard	4-11
Caps Lock.....	4-11
Num Lock	4-11
Scroll Lock.....	4-11
Repeat Rate	4-11
Power Saving.....	4-11
Display Timeout	4-12
HDD Motor Off	4-12



Contents

System Timeout.....	4-12
System Configurations.....	4-13
CPU Speed/Bus Speed.....	4-13
Quick Boot.....	4-13
Standby Key.....	4-13
Speed Key.....	4-13
Serial I/O	4-14
Baud Rate	4-14
Data Bits	4-14
Stop Bits	4-14
Parity	4-14
Setting Up the LCD	4-15
LCD/CRT Switch	4-15
Screen Modes	4-16
Text Mode	4-17
Graphics Mode.....	4-17
LCD Modes	4-17
Setting the Display Mode.....	4-17
Changing the LCD Color Palette.....	4-18
Displaying the Hardware	
Installation Screen	4-19
Power-On Message	4-19
Key Operation	4-19
DIAG Command.....	4-19
Making Selections on the Hardware	
Installation Screen	4-21
Hardware Installation Screen Fields	4-22
Display Configuration.....	4-22
Display Mode.....	4-22
Display Adaptor.....	4-22
I/O Configuration.....	4-22
Internal and Optional Serial Ports	4-22
Internal Parallel Port.....	4-23
ROM Disk Port.....	4-23
EMS I/O Port.....	4-23
Drive Assignments.....	4-23
Drive A/Drive B.....	4-23

Drive C/Drive D	4-24
Memory Configuration.....	4-24
Internal Memory Size	4-24
Boundary Address	4-24
Restarting the System	4-26
Backing Up the Hard Disk	4-27

System Start-up

The TravelMate 2000 computer comes from the factory with software already installed on the hard disk. The TravelMate 2000 computer contains MS-DOS, version 4.01, LapLink, Laptop Manager, Laptop File Manager, BatteryPro, Battery Watch, RPAL palette utility, and other software programs that make your computer more powerful and easier to use.

When starting the computer, follow these steps.

1. If you have not done so, set up your computer for either battery operation or AC Adaptor operation, as described in Chapter 3.
2. **Turn** the power on. The TravelMate 2000 begins its internal memory check and displays this screen:

```
Chips 455 VGA BIOS
Version XXX
Copyright (c) 1988 Chips and Technologies, Inc. All Rights Reserved
```

Then displays this screen:

```
Phoenix 80286 ROM BIOS PLUS Version X.XX XX
Copyright (C) 1985-1988 Phoenix Technologies Ltd.
All Rights Reserved.

TI TravelMate 2000
Firmware Version X.XX
640K Main Memory, XXXXXXXK Extended
```

The TravelMate 2000 then loads the expanded memory driver, BatteryPro, MS-DOS, Cache, Shadow, RPAL, Battery Watch, and Laptop Manager, displaying messages on the screen as each program loads.

3. If you have not removed the internal battery or installed an internal option, the computer displays the Laptop Manager screen.

Restoring Your System Configuration

The system configuration in your Texas Instruments TravelMate 2000 Notebook Computer can be lost if you do any of the following:

- Remove the internal battery
- Discharge the battery completely without immediately recharging it
- Allow your computer to sit idle without charging the battery for more than 10 days

If you lose your system configuration, follow this procedure when starting your computer.

1. Charge the internal battery as described in Chapter 3. Ensure that your wall outlet provides the voltage required for your computer.
2. After the battery is fully charged, turn on the computer by setting the power switch to the I (on) position. The computer displays the following message:

Press Enter to run the Hardware Installation
Press F1 to continue

3. Press the **Enter** key.
4. If any additional error messages appear, press any key to acknowledge and continue.
5. When the Hardware Installation screen appears, press and hold the **Ctrl** key and press the **Spacebar** to install the factory default values.



System Start-up

6. Press the **SetUp** key and then press the **Enter** key to exit the Hardware Installation screen and restart the computer.
7. When the Laptop Manager main menu appears, press the **F8** (Reset Config) key to complete resetting the factory default values.

The computer again restarts, and the Laptop Manager main menu reappears.

Laptop Manager Screen

After MS-DOS has been loaded, along with the configured software, the standard Laptop Manager screen appears as in the following example.

```
Laptop Manager v.4.01                               Tue Oct 15 12:15 pm
----- Applications -----
  Texas Instruments Incorporated
  TravelMate 2000

  F1 - File Manager
  F2 -
  F3 -
  F4 -
  F5 -
  F6 -
  F7 -
  F8 -
  F9 -
  F10 - Battery Watch
  F11 - LapLink
  F12 - Change Menu

  D - DOS Command
  P - Path/Directory

C:\                                                    ESC = Exit
```

Read the *BatteryPro and Productivity Software User's Manual* for the instructions to use Laptop Manager.

You can customize many of the settings of your system so that your TravelMate 2000 always powers up with those settings. Normally, you should access the Set Up screen when the MS-DOS prompt is displayed, although you can access the Set Up screen from an application program.

Accessing the Set Up Screen from MS-DOS

You can enter the Set Up screen when the MS-DOS prompt is displayed by pressing the **Set Up** key. Pressing the **Set-Up** key executes the SET-UP command in the \DOS directory, which displays the Set Up screen. If you access the Set Up screen from the MS-DOS prompt, the computer does not reboot when you exit the Set Up screen.

Accessing the Set Up Screen Directly

You can access the Set Up screen directly from any program by holding down the **Ctrl** and **Alt** keys and pressing the **Set Up** key. When you access the Set Up screen this way the computer reboots upon leaving the Set Up screen, which clears memory.



Caution: You should avoid pressing the Ctrl-Alt-Set Up keys when you are in an application program. The computer restart when it exits the Set Up screen, which erases the contents of memory.



Making Selections on the Set Up Screen

```

                                TI TravelMate 2000 Set Up Menu                (v-x.xx)
----- Clock -----  -----Power Saving -----  -- Serial I/O --
Time: 11:00:00 a.m.      Display Timeout: 1 minute    Standard SIO
Date: SUN JAN 01,1990   HDD Motor Off: 1 minute    Baud Rate: 9600
                        System Timeout: Always On     Data Bits: 8
                                                Stop Bits: 1
                                                Parity: None

--- Display ---  -- System Configurations --  Optional SIO
Cursor Type: Underline   CPU Speed: 12MHz          Baud Rate: 9600
LCD Mode: Standard      BUS Speed: 6MHz          Data Bits: 8
                        Quick Boot: ON              Stop Bits: 1
                        Standby Key: Enable          Parity: None
                        Speed Key: Enable

----- Keyboard -----
Caps Lock: Off
Num Lock: Off
Scroll Lock: Off
Repeat Rate: Fast

-----
1. Position Cursor          2. Press Space Bar       3. Press Set-Up Key
   using cursor keypad     to change                to exit

```

1. To move forward through each field, use the → key (Right Arrow) or the ↓ key (Down Arrow). To move backward through each field, use the ← key (Left Arrow) or the ↑ key (Up Arrow).

To move to the first field in the next category, press the **PgDn** key (Page Down). To move to the first field in the previous category, press the **PgUp** key (Page Up).

To move to the very first category, press the **Home** key. To move to the very last category, press the **End** key.

2. After moving to a field, press the **Spacebar** to cycle through the possible settings for the field. Select the desired setting and move to the next field.

Making Selections on the Set Up Screen]

3. Press the **Set Up** key or the **Esc** key when you have finished all entries. Then the system prompts you to press the **Enter**, **Esc**, or **Set Up** keys.
4. Press the **Enter** key to save the new settings and return to MS-DOS. Press the **Esc** key to discard the new settings and return to MS-DOS or press the **Set Up** key to return to the Set Up Screen.



Note: If you entered the Set Up screen by pressing the **Ctrl-Alt-Set Up** keys, the system restarts when you exit the Set Up screen.

The selections you make on the Set Up screen are backed up by the battery. All selections are maintained even when power is turned off. If the battery is removed for approximately 5 minutes (when installing an internal option, for example), or if the battery is discharged, some of the selections may be invalid. When this happens, hold the **Ctrl** key down and press the **Spacebar** to install valid default values in all fields.

Each field on the Set Up screen is described on the following pages.



Set Up Screen Fields

Clock

The computer contains a battery-operated clock that keeps track of the time and date. This category allows the current time and date to be set and modified.

Time

This field specifies the current time. Time is set either in a 12-hour or a 24-hour clock format depending on the country setting. To advance the time, press the **Spacebar** or use the + key. To set the time back use the - key. For the 12-hour clock format, press the **Spacebar** to change between AM and PM. This also resets the seconds to 00.

Date

This field specifies the current date. The date is set either in the month-day-year or the day-month-year order depending on the country setting. The day of the week (MON, TUE, WED, etc.) is set automatically as the date is entered.

Display

This category sets the shape of the screen cursor and vertically expands the display on the LCD in certain modes.

Cursor Type

The shape of the cursor can be changed to one of the following settings: Underline, Underbar, or Block.

LCD Mode

The standard LCD screen has a resolution of 640 dots horizontally by 480 dots vertically. In MDA, CGA and EGA display modes, however, the screen does not normally use all of the 480-dot vertical display area. Specifying expanded mode for these display modes expands the screen display vertically to use the full screen. Possible settings are Standard or Expanded.

To use the entire display, set the LCD mode to Expanded. However, for some CGA- and EGA-based applications where the aspect ratio is critical, it may be desirable to use the Standard setting.

Keyboard

This category specifies the state of the three lock keys and the key repeat rate when the system is started up.

Caps Lock

Specifies the default state of the **Caps Lock** key. Possible settings are On or Off.

Num Lock

Specifies the default state of the **Num Lk** key. Possible settings are On or Off.

Scroll Lock

Specifies the default state of the **Scr Lk** key. Possible settings are On or Off.

Repeat Rate

Specifies the default key repeat rate. Possible settings are Fast or Standard.

Power Saving

This category specifies the period of three power-saving functions. Each power-saving function occurs approximately within the specified period.



Note: Your TravelMate 2000 is configured with BatteryPro, which helps you conserve battery life while running application programs. Read the *BatteryPro and Productivity Software User's Manual* for more information on optimizing battery charge life.

Set Up Screen Fields

Display Timeout

After a certain period of inactivity, with no input from the keyboard, the system automatically shuts off the power to the LCD screen. Pressing any key on the keyboard turns the LCD back on. The length of the timeout period can be set or the LCD can be kept on continuously. Possible settings are Always On, 1 minute, 2 minutes, 5 minutes, or 10 minutes. This feature is also valid for an external monitor.



Note: If you use a mouse in an application, you might want to set the Display Timeout to Always On.

HDD Motor Off

In order to conserve battery life, the hard disk motor can be set to turn off automatically after a period with no accesses to the hard disk. Possible settings are Always On, 15 seconds, 30 seconds, 1 minute, 2 minutes, 5 minutes, or 10 minutes.

Note: Although turning off the hard disk when not in use conserves battery life, you can experience a slowing of disk access time when the computer turns on power to the disk motor before accessing the disk. See the *BatteryPro and Productivity Software Users Manual* for information.



System Timeout

After a certain period with no input from the keyboard, the system automatically enters the standby mode. The hard disk drive is turned off and the **Power** indicator turns orange. Pressing the **FN-Pause** key or the **Ctrl-Alt-Pause** keys on the keyboard returns the system to the active mode. The length of the timeout period can be set or the computer can be kept on continuously. The possible settings are Always On, 1 minute, 2 minutes, 5 minutes, or 10 minutes.

Set Up Screen Fields

System Configurations

This category specifies various settings concerning the system configuration.

CPU Speed/Bus Speed

These fields specify the CPU clock speed and bus clock speed used on power-up. The speeds are set as a pair and change simultaneously to the values displayed when you exit the Set Up screen. The possible settings are 12 MHz/6 MHz, 6 MHz/6 MHz, or 7.16 MHz/7.16 MHz.

Quick Boot

This field selects quick loading of the system. When this field is set to On, the system bypasses some of the power-on self checks (including memory check) when starting up. The possible settings are On or Off.

Standby Key

This field lets you enter standby mode using the keyboard. Normally, the system enters the standby mode after a specified period of inactivity. If this field is set to Enable, the system enters standby mode when the **Fn-Pause** keys or **Ctrl-Alt-Pause** keys are pressed. The possible settings are Enable or Disable.

Speed Key

This field lets you change the CPU clock speed from the keyboard. If you set this field to Enable, you can change the CPU clock speed using the **Ctrl-Alt-↑** keys or the **Ctrl-Alt-↓** keys on the keyboard while using the computer. Pressing the **Ctrl-Alt-↑** keys quickens the CPU speed step by step in the 6MHz-7.16MHz-12MHz order, and pressing the **Ctrl-Alt-↓** keys slows down the CPU speed step by step in the 12MHz-7.16 MHz-6MHz order. The possible settings are Enable or Disable.



Set Up Screen Fields

You can hear a high-pitched beep when pressing the **Ctrl-Alt-↑** keys and a lower pitched beep when pressing the **Ctrl-Alt-↓** keys. The higher beep results from the higher CPU speed, while the lower beep results from the lower CPU speed.



Note: DIP switch I must be on in order to hear the beeps. See Chapter 3 for information on how to set the DIP switches.

You can display the current CPU speed by using the Speed Utility. See the *BatteryPro and Productivity Software User's Manual* for more information.



Note: In some cases, the above key functions (**Fn-Pause**, **Ctrl-Alt-Pause**, **Ctrl-Alt-↑** or **Ctrl-Alt-↓**) may not be effective even when Enable is set on the Set Up screen. In this case, use the system timeout function or change the CPU speed on the set up screen.

Serial I/O

This category defines the communications settings for the standard and optional serial input/output (SIO) ports.

Baud Rate

Possible settings are 110, 150, 300, 600, 1200, 2400, 4800, or 9600.

Data Bits

Possible settings are 7 or 8.

Stop Bits

Possible settings are 1 or 2.

Parity

Possible settings are None, Odd, or Even.

The TravelMate 2000 computer gives you many ways to set up the LCD, which allows you to create the screen configuration that suits your needs best. This section provides an overview of your options while setting up the LCD. The sections on the Set Up screen and Hardware Installation screen provide detailed information about your options.

When setting up the LCD on your computer, you should keep the following information in mind.

- Refer to your application program manual for instructions on how to set the display mode on the Hardware Installation screen, described later in this chapter. Then choose Standard or Expanded LCD mode on the Set Up screen. The default setting is Standard. In general, Standard mode gives a more accurate display of graphics, but may not fill the LCD screen in some display modes. Expanded mode will fill the screen, but may "stretch" some graphics unacceptably.
- Your computer automatically selects the display mode (text or graphics) required by your application software when the Display Mode field is set to VGA Mode and the Display Adaptor field on the Hardware Installation screen is set to Internal VGA.
- You can use the Shadow and RPAL utilities that come with the TravelMate 2000 to increase the readability of the cursor and LCD display for most application programs. Refer to the *BatteryPro and Productivity Software User's Manual* for details of these programs.

LCD/CRT Switch

Your TravelMate 2000 contains a VGA display adaptor. This display adaptor can be used with either the internal LCD screen or an external VGA monitor when an optional CRT Adaptor is installed.



Setting Up the LCD

The LCD/CRT switch (on the left side panel) determines whether the image is displayed on the LCD or on an optional external VGA monitor.

- ❑ When the LCD/CRT switch is set to CRT, the internal VGA display adaptor sends display signals to an external monitor connected to the optional CRT Adaptor. The CRT Adaptor supports the following external monitors:
 - Multi-frequency monitors
 - 31 kHz/70 Hz (400/200 line mode), 60 Hz (480 line mode) IBM PS/2 (VGA) monitors
- ❑ When the LCD/CRT switch is set to LCD, the internal VGA display adaptor uses the built-in LCD display, emulating 16 colors as 16 shades of gray. To assign colors to shades of gray, a palette utility, called RPAL, is supplied. This utility is described in the *BatteryPro and Productivity Software User's Manual*.



Note: The computer must be rebooted for changes made in the palette utility to take effect.

A detailed description of screen standards is included in Appendix J.

Screen Modes

The internal display adaptor in the TravelMate 2000 supports IBM screen standards (CGA, MDA, EGA, VGA) both for the LCD screen and for compatible external monitors, and emulates the Hercules Graphics Card (HGC) only for external multi-frequency monitors. An application program may not support all of these standards. Check your application program manual to determine which display modes are supported. The CGA, EGA, VGA and HGC standards have both text and graphics modes. The MDA standard does not support graphics displays.

Text Mode

In text mode, text is displayed on a 25-line screen in either 40 or 80 columns in CGA, EGA and VGA modes.

Graphics Mode

The TravelMate 2000 LCD screen can display high-quality graphic images. The VGA mode gives the best results, since it has the highest screen resolution. If your application does not support VGA, then EGA is an alternate high-resolution display mode. CGA is available for applications that do not support the higher resolution modes.

LCD Modes

The TravelMate 2000 has two LCD modes-standard and expanded-which are selected by accessing the Set Up screen, as described earlier in this chapter. In standard mode, the display area for CGA, MDA and EGA does not fill the LCD screen, so there are borders at the top and bottom of the screen. In expanded mode, the displays are expanded vertically-by duplicating a line every few lines-to use as much of the 640 by 480 screen as possible.

Setting the Display Mode

The MS-DOS MODE command allows you to specify the text display mode on the TravelMate 2000 LCD or on an external monitor. For the LCD type the command:

MODE 40	- for 40 chars/line or
MODE 80	- for 80 chars/line.

Refer to the MODE command in your MS-DOS manual for a detailed description.



Note: The 40-column text display is not supported in the MDA and HGC modes.



Setting Up the LCD

Changing the LCD Color Palette

The TravelMate 2000 LCD screen displays up to a maximum of 16 colors as shades of gray. The shade of gray selected to represent each of the 16 colors can be changed by the user to maximize contrast between adjacent gray scale shades when running programs which use particular color combinations. A given mapping of gray scales to colors is called a *palette*. See the RPAL section of the *BatteryPro and Productivity Software User's Manual* for more information.

Displaying the Hardware Installation Screen

If you have removed the battery or added an internal option, you may need to configure the hardware on the Hardware Installation screen. You can display the Hardware Installation screen in the following three ways:

Power-On Message

When turning on the computer or after adding an option, you may see the following message on the screen:

Invalid Configuration Information

- Press Enter to run the hardware installation.
- Press F1 to continue.

This message indicates that the settings on the Hardware installation screen do not match the actual hardware configuration you are using. Press the **Enter** key to display the Hardware Installation screen. Pressing the F1 key will bypass the message and allow you to start MS-DOS, although you still will have to set the new hardware configuration later.

Key Operation

Access the Set Up screen (described earlier in this chapter) either by pressing the **Set Up** key while holding down the **Ctrl** and **Alt** keys or by pressing the **Set Up** key at the MS-DOS prompt. Pressing the **Ctrl-Alt-Set Up** keys on the Set Up screen displays the Hardware Installation Screen.

DIAG Command

Type **DIAG** at the MS-DOS prompt and press the **Enter** key. The diagnostic program automatically runs and displays an opening menu. Select the Hardware Installation item from this menu. See Appendix E for a **full** description of the diagnostics program.



Displaying the Hardware Installation Screen

The Hardware Installation screen with its default settings appears as follows:

```
TI TravelMate 2000 Hardware Installation      (V-x.xx)

--- Display Configuration ---                --- Drive Assignment ---

Display Mode:      VGA Mode                 Drive A: External 3.5" FDD
Display Adaptor:  Internal VGA              Drive B: External 5.25" FDD
                                                Drive C: Internal HDD
                                                Drive D: None

---- I/O Configuration ----                --- Memory Configuration---

Internal Serial Port:  Port 1                Internal Memory Size:  1 MB
Optional Serial Port:  Disable              Boundary Address:    110000h
Internal Parallel Port: Port 1              * Main Memory:      640 KB
ROM Disk I/O Port:    1C8h - 1CBh           * Extended Memory:   64 KB
EMS I/O Port:         218h - 21Bh          * Expanded Memory:   320 KB
                                                * Disabled Memory:    0 KB

-----

1. Position Cursor      2. Press Space Bar      3. Press Set-Up Key
   using cursor keypad   to change                to exit
```

Making Selections on the Hardware Installation Screen

1. To move forward through each field, use the → key (Right Arrow) or the ↓ key (Down Arrow). To move backward through each field, use the ← key (Left Arrow) or the ↑ key (Up Arrow).

To move to the first field in the next category, press the **PgDn** key (Page Down). To move to the first field in the previous category, press the **PgUp** key (Page Up).

To move to the very first category, press the **Home** key. To move to the very last category, press the **End** key.

2. After moving to a field, press the **Spacebar** to cycle through the possible settings for the field. Stop at the desired setting and move to the next field.
3. Press the **Set Up** key when you have finished all entries. Then the system prompts you to press the **Enter**, **Esc**, or **Set Up** key.
4. Press the **Enter** key to save the new settings or press the **Esc** key to discard the new settings and return to MS-DOS. The system will restart in either case.

The selections you make on the Hardware Installation screen are backed up by the battery. All selections are maintained even when the power is turned off. If the battery is removed for more than approximately 5 minutes (when installing an internal option, for example), or if the battery is discharged, the selections may be invalid. When using the computer for the first time after the battery was removed or after the computer has not been used for a long period, reset the appropriate values in the Hardware Installation screen to their default values by pressing the **Ctrl-Spacebar** keys.

Each field on the Hardware Installation Screen is described on the following pages.

Hardware installation Screen Fields

Display Configuration

There are two settings for the display.

Display Mode

The Display Mode specifies the mode of the internal VGA controller. The possible settings are: VGA Mode, EGA Mode, CGA mode, MDA mode, and HGC mode. The HGC mode is effective only for an external CRT monitor connected through the optional CRT Adaptor.

Display Adaptor

The Display Adaptor specifies whether the internal VGA controller or an external display adaptor card installed in the optional Expansion Unit is being used. This field is effective only when the optional Expansion Unit is attached to the computer. Otherwise, the internal VGA controller is used regardless of the setting in this field. The possible settings are Internal VGA, CGA-40 col, CGA-80 col, and MDA.

I/O Configuration

This category specifies the configuration of various I/O ports.

Internal and Optional Serial Ports

These fields select the port numbers for the standard internal serial port and the optional internal serial port, usually used for an internal modem. You can assign either port as Port 1 or Port 2, but you cannot assign the same port number to both ports. You can also Disable either or both ports. To assign port values, press the **Spacebar** until the screen displays the desired configuration.

Internal Parallel Port

This field assigns a number to the standard parallel port. Possible settings are Port 1, Port 2, and Disable.

ROM Disk Port

This field specifies the ROM disk I/O port address. The possible settings are from 108h- 10Bh to 1F8h- 1FBh.

EMS I/O Port

This field specifies the EMS device driver I/O port address (EMM4J.SYS). The possible settings are 208h- 20Bh to 2E8h-2EBh.



Note: Make sure the addresses for the ROM disk port and EMS I/O port do not conflict with other I/O port addresses. The addresses apply even when the ROM disk or the EMS device driver is not used.

Drive Assignments

Drive A/Drive B

If a 3.5-inch Floppy Drive Unit is connected to the computer, the drive is assigned drive letter A regardless of the settings in this field. Although a 5.25-inch floppy drive is not an option of the TravelMate 2000, a third-party 5.25-inch floppy drive connected to the port on the 3.5-inch Floppy Drive Unit is always designated Drive B.



Hardware installation Screen Fields

Drive C/Drive D

These fields specify the drive assignments of the internal hard disk and the ROM disk. You should usually assign Drive C to the Internal HDD and Drive D to none. If you need to boot from the ROM disk to restore the system, you should assign Drive C to the ROM disk and Drive D to the internal HDD. See Appendix K for instructions on restoring MS-DOS to the hard disk.

Memory Configuration

This category specifies the configuration of the internal memory.

Internal Memory Size

This field specifies the total amount of internal memory. The amount of memory on the expansion card(s) installed in the Expansion Unit is not included in this size. Possible settings are 1M byte, 2M bytes, or 3M bytes.

Boundary Address

This field specifies the boundary address between internal Extended memory and Extended memory in the Expansion Unit.

Using the above two values, the system calculates the following four sizes:

- Main Memory**-This field always shows 640 K bytes.
- Extended Memory**-This field shows the amount of internal Extended memory.
- Expanded Memory**-This field shows the amount of internal Expanded memory. The minimum is 128 K bytes.

Hardware Installation Screen Fields

- Disabled Memory**-This field shows the amount of memory which is not available to the user.

See Appendix H for the relationship between the settings in this category and each memory size.

Restarting the System

You may sometimes want to return the system to its start-up state-with only MS-DOS, CONFIG.SYS and AUTOEXEC.BAT in memory-without turning off the power. This is called restarting or "rebooting" the system (sometimes called a "warm boot," as opposed to a "cold boot," which includes turning the power off and on again).



Caution: Any information in main memory will be lost when you restart the computer. Be sure to save any files you are working on first before rebooting.

To perform a warm boot, press the **Del** key while holding down the **Ctrl** and **Alt** keys. The system responds as if power was just turned on-it performs an internal check, then loads MS-DOS from the hard disk. The initial memory check is bypassed.

Backing Up the Hard Disk

Although the hard disk is a precision device, the data stored in it may be lost due to shock or vibration of the disk or in the event of disk or hardware failure. Once lost, the data cannot be restored unless you have backup copies. Be sure to back up the contents of the hard disk from time to time onto another computer using the COPY command in the LapLink utility or, if you have an optional floppy drive assembly, onto diskettes using the BACKUP command. For information on the LapLink utility, see the LapLink manual.

Installing and Using Application Programs

This chapter tells you about

- ❑ Guidelines for loading IBM AT-compatible application programs
- ❑ The furnished LapLink program that transfers files and lets you use another computer's peripheral devices
- ❑ How to set up and use the furnished Laptop Manager program for your operating environment

Contents

Guidelines for Installing Applications.....	5-3
Installing Applications Without the Floppy Drive Option.....	5-3
Installing Programs Not Copy-Protected.....	5-4
Installing Copy-Protected Programs.....	5-4
Installing Applications Using the Floppy Drive Option.....	5-5
Installation Considerations.....	5-5
Display	5-5
Keyboard	5-5
Communication Ports	5-6
Processing Speed	5-6
Memory	5-6
AUTOEXEC.BAT and CONFIG.SYS Files	5-7
Default AUTOEXEC.BAT File	5-7
Default CONFIG.SYS File	5-9
LapLink	5-10



Contents

LapLink File Transfer Utility	5-10
LapLink Device Driver	5-11
Laptop Manager.....	5-13
Laptop Manager Main Menu	5-13
Quick Commands Box.....	5-14
Single-Character Quick Commands	5-14
Selecting Applications From the Applications List	5-15
Using the Password Utility	5-16
Accessing the Password Utility.....	5-16
Installing a Password	5-17
Changing a Password.....	5-17
Removing a Password.....	5-18
Password Function	5-19

Guidelines for Installing Applications

Your TravelMate 2000 is fully compatible with IBM AT computers - All application programs written to execute on AT computers will execute on the TravelMate 2000, and you can install the programs in much the same way on the TravelMate 2000. However, like most computers, you must consider the exceptions to the installation process before you install programs into the TravelMate 2000.

Installing Applications Without the Floppy Drive Option

If your TravelMate 2000 is not equipped with the floppy drive option, you can use the furnished LapLink file transfer and device driver utility to install or copy a program by using another IBM AT-compatible computer.



Note: Before copying any commercial software currently in use on another computer, read the License Agreement and copyright protections that apply to that product. Many agreements limit the use of an application program to one owner, or even to one CPU-based system. If you are already using the software on an existing system, you may be prohibited from also running it on another computer. In other cases, you may have to completely remove the software from the current system before you can use it on another computer. It is your responsibility to ensure compliance with the terms and conditions pertaining to any software products you plan to use with the LapLink feature. Texas Instruments assumes no responsibility for the illegal or unauthorized use of proprietary software products on Texas Instruments TravelMate computers.



Guidelines for Installing Applications

Installing Programs Not Copy-Protected

If the application program you want to install in the TravelMate 2000 is not copy-protected and is already installed on another AT-compatible computer, you can use LapLink to copy the program to your TravelMate 2000. Refer to the *LapLink User's Manual* furnished with your TravelMate 2000 for detailed instructions.



Note: If the display on the AT-compatible computer with the application program is not a VGA monitor, you must configure the program and/or the TravelMate 2000 to the highest-resolution display that each can support. See your application software manual for details. Some programs allow you to change the display configuration while running; others require you to specify monitor type when you initially install the program.

Installing Copy-Protected Programs

If the application program you want to install in the TravelMate 2000 is copy-protected or if you can configure the program only during the installation process, you can use the LapLink device driver feature and the floppy drive of an AT compatible computer to install the program.

The LapLink device driver program enables the drives on your TravelMate 2000 to work as if they were a component of the other computer, so you can install the program according to the program's installation procedure using the floppy drive of the other computer. You can also use this procedure if the application program is available only on 5.25-inch floppies and your computer does not have a 5.25 inch floppy drive.

Refer to Section 4 of the *LapLink User's Manual* for detailed instructions on this procedure.

Guidelines for Installing Applications

Installing Applications Using the Floppy Drive Option

If you have the optional floppy drive unit attached to your TravelMate 2000, you can use it to install any application programs available on 3.5-inch floppies. Review the following special installation considerations and install the program according to the instructions furnished with the program.

If the program is not available on 3.5-inch floppies, you can use the furnished LapLink program, using the procedures described under "Installing Applications Without the Floppy Drive Option" earlier in this chapter.

Installation Considerations

The following configuration items will influence how you install application programs into your TravelMate 2000 (or any computer).

Display

The TravelMate 2000 has a 80-column by 25-line display with 640-by-480 (VGA) resolution and four other lower resolution displays. When installing an application program, select the highest-resolution monitor configuration for the program and the TravelMate 2000 that both can support.

Keyboard

The TravelMate 2000 keyboard emulates all functions of an IBM AT - 101 enhanced keyboard. When installing an application program, select the IBM 101 or AT -enhanced keyboard configuration.



Guidelines for Installing Applications

Communication Ports

The serial port is Port 1 (default) and the optional Internal Modem, if installed, is Port 2 (default). When installing an application program requiring communication support, select Port 1 or Port 2, as appropriate. You can change these values on the Hardware Installation screen (described in Chapter 4).

Processing Speed

Some application programs do not execute at the high speed (12 MHz) on the computer. Check the program documentation for the required processing speed and change the speed if necessary in one of the following ways.

- On the Set Up screen
- By pressing **Ctrl-Alt-↑** or **Ctrl-Alt-↓** when the Speed Key is enabled on the Set Up screen
- With the Laptop Manager menu configuration process (described in the *BatteryPro and Productivity Software User's Manual*).

If you use the Laptop Manager feature to load your application programs, you do not need to change the system setup procedure each time you load a different application program that requires a different processing speed.

Memory

The standard TravelMate 2000 has 1 M byte of memory 640 K byte system memory plus 384 K byte extended/expanded memory. You can add 1 or 2 M bytes of additional optional memory to your TravelMate 2000 that can be configured either as extended memory or LIM EMS memory. See Appendix H for details on memory options for your TravelMate 2000.

Guidelines for Installing Applications

Review your application program documentation for its memory requirements and set up the TravelMate 2000 memory to maximize your program's performance.

AUTOEXEC.BAT and CONFIG.SYS Files

If your application program requires additions or changes to the TravelMate 2000 AUTOEXEC.BAT and CONFIG.SYS files—as suggested several times in this and other chapters of this manual—carefully consider the consequences that may result from changes or deletions to these two files. The factory-furnished (default) files are listed and described in the following two sections. Please read and understand these two files before you change them. See the *MS-DOS User's Manual* furnished with your TravelMate 2000 for more details on constructing these files and their significance.

Default AUTOEXEC.BAT File

Each line of the TravelMate 2000 default AUTOEXEC.BAT file and its purpose are defined in the table following the file listing. Take special note of those lines relating to Laptop Manager and LapLink.

```
echo off
ver
set      comspec=c:\dos\command.com
set      path=c:;\c:\utils;c:\dos
set      mfile=c:\utils
set      lapsys=c:\config.sys
set      lapfile=c:\
prompt $P$G
cache 64 /e
shadow
rpal /i
bw
lm
```

Guidelines for Installing Applications

Default AUTOEXEC.BAT File

Line	Purpose
1	echo off - prevents the Me from displaying on the screen when invoked
2	ver - displays version number of MS-DOS
3	set comspec=c:\dos\command.com - tells MS-DOS to get its COMMAND.COM file from drive C. speeds processing. Do not remove this line from the file.
4	set path=c:\;c:\utilsc:\dos - defines the directories and order in which to search for files entered on the command line. You can add additional directories to this line as required.
5	set mfile=c:\utils - tells Laptop Manager in which directory to find its data file. This line is required by LapTop Manager.
6	set lapsys=c:\config.sys - tells the LapLink file, DDINSTAL.EXE, to look for the CONFIG.SYS file in the root directory of drive C. This line is required by the LapLink device driver.
7	set lapfile=c:\ - tells LapLink in which directory to find its configuration file. This line is required by LapLink.
8	prompt \$P\$G - tells MS-DOS to display the current drive and directory
9	cache 64 /e - installs Disk Cache in memory
10	shadow - installs Shadow for cursor enhancement
11	rpal /i - installs RPAL, a color palette control program
12	bw - installs Battery Watch program
13	lm - loads Laptop Manager and displays its main menu

Guidelines for Installing Applications

Default CONFIG.SYS File

Each line of the TravelMate 2000 default CONFIG.SYS file and its purpose are defined in the table following the file listing. You can add commands required by your application program(s), but **do not** delete the existing default commands.

```
FILES=20
BUFFERS=20
SHELL=C:\DOS\COMMAND.COM /P /E:256
DEVICE=C:\UTILS\EMM4J.SYS
DEVICE=C:\UTILS\BATTERY.PRO
DEVICE=C:\DOS\ANSI.SYS
INSTALL=C:\DOS\FASTOPEN.EXE C:=(50,25)
```

Default CONFIG.SYS File (Modify but do not delete these command lines)

Line	Purpose
1	FILES=20 - tells MS-DOS how many files can be open at any one time
2	BUFFERS=20 - tells MS-DOS how many buffers will be used for file input/output; you can adjust the value as required by your application program to maximize processing speed.
3	SHELL--C:\DOS\COMMAND.COM /P /E:256 - provides the path for COMMAND.COM and sets the environment to 256 bytes
4	DEVICE=C:\UTILS\EMM4J.SYS - installs EMMJ4.SYS, the expanded memory manager device driver
5	DEVICE=C:\UTILS\BATTERY.PRO - loads the device driver BATTERY.PRO
6	DEVICE=C:\DOS\ANSI.SYS - loads the device driver ANSI.SYS for enhanced standard input/output
7	INSTALL--C:\DOS\FASTOPEN.EXE C:=(50,25) - installs FASTOPEN, which decreases the amount of time to open frequently used files and directories



LapLink

The LapLink file transfer and device driver programs, products of Traveling Software Inc., are furnished with your TravelMate 2000. LapLink makes it practical to use a computer without a floppy drive. LapLink requires use of a special cable also furnished with your TravelMate 2000.

LapLink fills the need for a fast, convenient, error-free means of transferring files. Connected by the furnished LapLink cable and running the LapLink program, two computers have complete access to each other's disk drives-and to all the files on those drives. You can copy files the following ways:

- From one hard disk directly to another (without using floppies at all)
- From one floppy to another (eliminating the incompatibility between 5.25- and 3.5-inch floppies)
- From a hard disk to floppies

LapLink File Transfer Utility

Though copying is its specialty, LapLink is more than a simple file-transfer program. By offering such features as file Erase, Rename, and View, LapLink has proved itself a useful tool for managing files and directories on a single computer.

Just as important as what it does is the way LapLink does it. Whether you are copying, erasing, renaming, or viewing files, using LapLink is easier than using only MS-DOS commands. LapLink shows you the files and directories you are working with and the commands that perform the various operations.

LapLink displays a split screen: on one side you see the files and directories on one computer and on the other side the files and directories on the other computer. The split screen not only tells you what is happening on both computers but also gives you access to both. Instead of moving from one computer to the other, you simply move the highlight between the two sides or "windows." By moving the highlight *within* a window you select the particular files or directories you want to copy, rename, erase, and so on. Then by activating a command you perform the operation.

LapLink commands like Copy and Erase appear across the bottom of the screen and are available at the press of a key. When a command has finished, you usually see the results on the screen immediately.

Whether you are working with one computer or two, LapLink simplifies many tasks: the organization of disks into subdirectories, the copying of files from one disk to another and from one directory to another, and the backing up of entire disks.

LapLink Device Driver

The LapLink device driver gives your computer access to the disk drives and printers connected to another computer: it's as though those other disks and printers were actually a part of your TravelMate 2000, or vice versa.

Though the device driver does give you access to another computer's disks and thus to its files-you are better served if you use LAPLINK.EXE to transfer files between computers.



LapLink

One of the most common uses of the device driver is sharing a printer. You can create files on your TravelMate 2000 and, through the device driver, print them on a printer already connected to a second computer. Note that the connection to the printer is indirect: from your TravelMate 2000 to the second computer through the LapLink cable, from the second computer to the printer through the printer cable.

Users of the TravelMate 2000 and other laptop computers find the device driver useful for running programs located on a desktop computer from the keyboard of their TravelMate 2000. The programs may be copy-protected, making it impossible to copy them to the TravelMate 2000 in the first place. Even if you decide to use the device driver you should not forget LAPLINK.EXE. Used in combination with the device driver (or by itself), LAPLINK.EXE is still the better way to transfer files between computers.

See the *LapLink User's Manual* furnished with your TravelMate 2000 for complete information and instructions about using LapLink and the LapLink device driver.

Laptop Manager, furnished with your TravelMate 2000, is an application control program. Laptop Manager provides two submenus into which you can insert application programs you have installed on the hard disk.

You can then load application programs from one of the submenus with one keystroke, and from the other submenu using the arrow keys and the **Enter** key.

Laptop Manager Main Menu

Loaded in your TravelMate 2000 hard disk at the factory and furnished on the *BatteryPro and Productivity Software* 3.5-inch floppy, the Laptop Manager program displays its main menu after the power-up and copyright messages are displayed when you turn on the computer. The main menu enables you to select application programs with a few keystrokes. Procedures for adding items to the Applications list and Quick Commands box are described in the *BatteryPro and Productivity Software User's Manual* furnished with your computer.

Pressing the **F12** key at the Laptop Manager main menu loads the Laptop Manager Change Menu screen. It enables you to add, delete, or modify items on the main menu. Procedures for using the Change Menu are provided in the *BatteryPro and Productivity Software User's Manual*.

You can exit Laptop Manager to the current MS-DOS prompt from the Laptop Manager main menu by pressing the **Esc** key.

You can return to the Laptop Manager main menu from the MS-DOS prompt (**c:\>**) by typing

LM

and pressing the **Enter** key.



Quick Commands Box

Application programs you add to the Quick Commands box can be selected by pressing the function key (**F2** to **F9**) you assign to it. For your convenience the Laptop File Manager, Battery Watch, and LapLink file utility transfer program are installed and assigned at the factory to the **F1**, **F10**, and **F11** keys, respectively. However, you can replace them with your own application programs using the Change Menu procedure explained in the *BatteryPro and Productivity Software User's Manual*.

Single-Character Quick Commands

At the bottom of the Laptop Manager menu Quick Commands box are two single-character commands:

- ❑ Press the **D** key and Laptop Manager displays a prompt at the bottom of the screen at which you can enter MS-DOS commands of up to 67 characters. Pressing the **Enter** key starts the command. When the command is executed, pressing any key returns you to the Laptop Manager main menu.
- ❑ Press the **P** key and Laptop Manager displays a prompt at the bottom of the screen at which you can change drives and/or directories. For example, you can change from the **C:** \ prompt to the **A:** \ prompt by typing **P** and **A:** and pressing the **Enter** key. Note that the **C:** \ prompt at the bottom left corner of the menu changes to a **A:** \ prompt. See your *MS-DOS User's Manual* for details on selecting and changing drives and directories.

Using the Password Utility

The TravelMate 2000 includes the Password utility, a program which limits access of your computer only to people who know the password you specify using this utility. The password is valid until you remove or change it using the Password utility.

In addition, the Laptop Manager provides password protection on a per-application program basis. See the *BatteryPro and Productivity Software User's Manual* for more information about the Password features for the Laptop Manager.

Accessing the Password Utility

1. At the **C:\>** prompt, type

PW

and press the **Enter** key.



Note: Make sure PATH is set to **C: \DOS**.

The following Password Utility screen appears:

```
                Password Utility V-x.xx
Install Password
Change Password
Remove Password
Exit
```

From the Password Utility screen you can install, change or remove a password, or you can exit the screen.

2. To select an action, move the bar cursor to the desired selection using the **↑** key or the **↓** key (Up or Down Arrow), and press the **Enter** key.

Installing a Password

1. To install a password, select "Install Password" from the Password Utility screen. The following screen appears:

```
Install Password

Enter new password
[      ]
```

2. Type a password of up to eight characters and press the **Enter** key.
3. Press the **Enter** key again to install the new password, or press the **Esc** key to cancel the action and return to the Password Utility screen.



Note: The Password utility does not distinguish between upper and lower case; for example, you can type either PASSWORD or Password.

If you select "Install Password" when you have already installed a password, the following message appears:

Password already exists

Pressing any key on the keyboard will return you to the Password Utility screen.

Changing a Password

1. To change the current password, select "Change Password" from the Password Utility screen. The following screen appears:

```
Remove Password

Enter current password
[      ]
```



Using the Password Utility

2. Type the current password and press the **Enter** key. Your entry is shown as squares so that it is not seen by other people.

If you type the correct password, the message "Password check OK" appears on the next line and you are prompted to enter the new password.

3. Type a new password of up to eight characters and press the **Enter** key.
4. Press the **Enter** key again to install the new password, or press the **Esc** key to cancel the action and return to the Password Utility screen.

If you type the wrong password, the message "Incorrect Password" appears on the next line and you are prompted to press any key to return to the Password Utility screen. You may try to change the password again, or exit the Password Utility screen by selecting Exit.

Removing a Password

1. To remove the current password, select "Remove Password" from the Password Utility screen. The following screen appears:

Using the Password Utility

2. Type the current password and press the **Enter** key. Your entry is shown as squares so that it is not seen by other people.
 - If you type the correct password, the message "Password check OK" appears on the next line. Press the **Enter** key to remove the current password, or press the **Esc** key to cancel the action and return to the Password Utility screen.
 - If you type the wrong password, the message "Incorrect Password" appears on the next line and you are prompted to press any key to return to the Password Utility screen. You may try to remove the password again, or exit the Password Utility screen by selecting Exit.

Password Function

Once you install the password, you will see the following message every time you start up the computer:

Password

Type the correct password in either upper or lower case and press the **Enter** key. If you type the correct password, the screen is cleared and the system begins to load.

- If you type the wrong password, the message "Incorrect Password" appears and you are prompted to enter the password again. You have three chances to enter the correct password. If you enter the wrong password three times, the system locks and starts beeping. If this happens, restart the system by pressing the **Ctrl-Alt-Del** keys. This time, you have only one chance to enter the correct password before the system locks.



Using the Password Utility

- ❑ If you enter the correct password after several incorrect passwords, the following message appears:

Password :
Password OK

- ❑ incorrect passwords attempts
Press any key to continue

This message shows how many wrong passwords have been entered since you last entered the correct password. This may indicate that someone has tried to use your computer without permission.

Once you enter the correct password, you again have three chances to enter the password at the next system start-up.

If you forget your password, you will not be able to use the computer. Should this happen, contact your Texas Instruments dealer.



Note: We recommend always making a note of the password you have installed, in case you forget it. Store the password in a secure place away from where you store or operate your computer.

This chapter tells you about:

- Options available for your TravelMate 2000
- FCC requirements for modem users
- Care for your modem

Contents

Add-On Battery Pack.....	6-2
Installing the Battery Pack	6-2
Charging the Battery Pack	6-3
Charge Indication	6-4
Low Battery Indication.....	6-4
3.5-inch Floppy Drive Unit	6-5
Attaching the Floppy Drive Unit.....	6-5
3.5-inch Floppies	6-6
Formatting a Floppy	6-7
Taking Care of Floppies	6-7
Inserting a Floppy into the Drive.....	6-9
Numeric Keypad	6-10
Connection	6-10
RAM Card	6-12
Installing the RAM Card	6-12
CRT Adaptor	6-16
Installation	6-16
External Monitor	6-18
2400 BPS Modem with Send-Fax and MNP Class 5	6-19
80C287 Coprocessor.....	6-20
Installing the 80C287 Coprocessor	6-20
External Keyboards	6-24
Printers	6-25

Add-On Battery Pack

The Add-On Battery Pack attaches to the rear of the TravelMate 2000 to extend battery operation time up to 5 hours.

In order to save weight and still have longer battery life, the Add-On Battery Pack can be used without the internal battery installed. In this case, the computer can be operated for up to 3 hours.

Installing the Battery Pack

1. Turn off the computer.
2. Remove the dust cap from the battery pack connector.

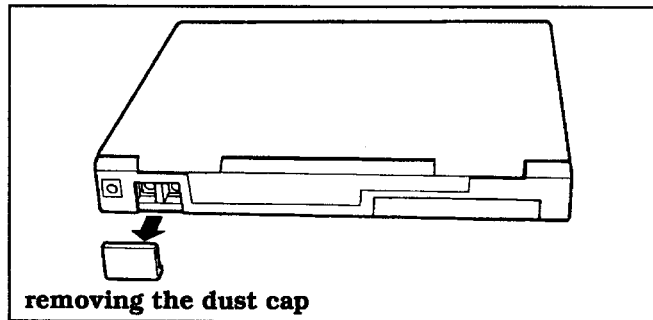

3. The removed cap can be put into the slot on the bottom panel of the battery pack for storage.



Note: When the battery pack connector is not in use, replace the cap.

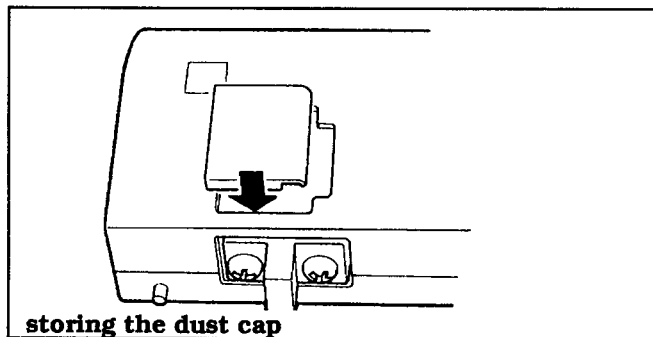

Add-On Battery Pack

4. Move the battery pack up to the rear of the computer, and push the two units together until the connectors mate.
5. Using your fingers, turn the two wheel screws clockwise until tight.

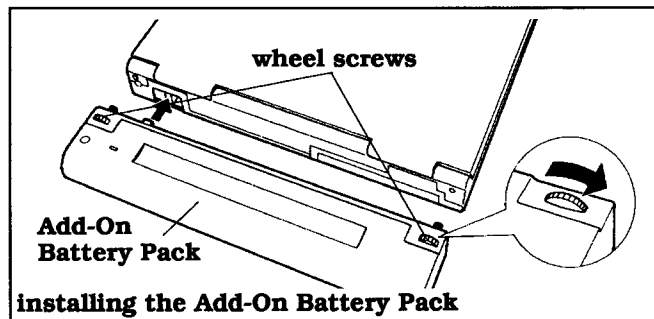

Charging the Battery Pack

The Add-On Battery Pack can be charged separately or when attached to the computer. (If the Add-On Battery Pack is attached to the computer, turn the computer off before charging the battery pack. Otherwise the charging time will be very long.)

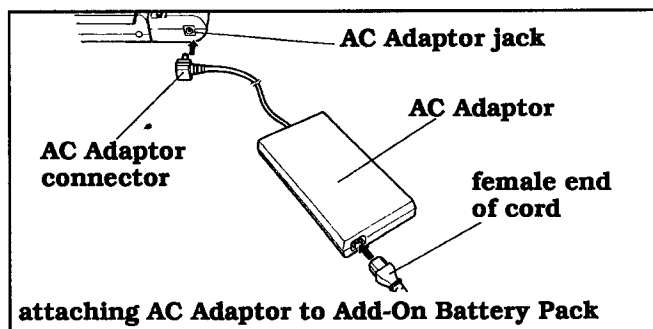

Plug the AC Adaptor into the jack on the right side of the pack to start charging the battery.



Add-On Battery Pack

When charged separately, the Add-On Battery Pack takes about 3.5 hours to fully charge. When installed along with the Internal Battery, charging takes about 5-1/2 hours.

The indicator on the top right of the Add-On Battery Pack blinks while it is being charged, and illuminates when it is at least 70 percent charged.

When mounted on the computer, the Add-On Battery Pack is connected in parallel with the internal battery. When operated in this configuration, the computer automatically draws power from whichever of the two batteries has more charge at a particular time, equalizing the power demand between both batteries.

Charge Indication

When charging the computer with the Add-On Battery Pack attached, the battery pack state of charge is shown by the pack's own indicator, and the computer's internal battery state of charge is shown by the **Charge** indicator (see the Indicator Lights section in Chapter 2). The state of charge of the Add-On Battery Pack also can be checked when the AC Adaptor is not connected, provided that at least 1 hour has passed since disconnecting the AC Adaptor. Press and hold down the button next to the battery pack's indicator for at least three seconds. The indicator shows green if the battery pack is at least 70 percent charged. If you press the button with the AC Adaptor still connected or within 1 hour of disconnecting the adaptor, the indicator may show green independent of the actual state of charge.

Low Battery Indication

The computer's **Low Batt** (Low Battery) indicator displays a low battery indication for the parallel combination of internal battery and Add-On Battery Pack. When the indicator shows red, the combined power of both batteries is low. When the indicator blinks red, the computer is about to shut down (see the description of the low battery indicator in Chapter 2).

3.5-inch Floppy Drive Unit

The optional 3.5-inch Floppy Drive Unit (TI Part No. 2568031 -0001) can be attached directly to the rear panel of the TravelMate 2000 or to the Expansion Unit attached to the computer.

Attaching the Floppy Drive Unit

To attach the 3.5-inch Floppy Drive Unit directly to the computer:

1. Turn the power off to the computer. Remove the Add-On Battery Pack if connected.



Caution: Be sure to turn off the power to the computer before attaching the floppy drive unit. Otherwise the system may be damaged.

2. Locate the expansion bus connector on the rear panel of the computer. If attached, remove the dust cap from the expansion bus connector. The removed cap can be put into the slot on the bottom panel of the floppy drive for storage.

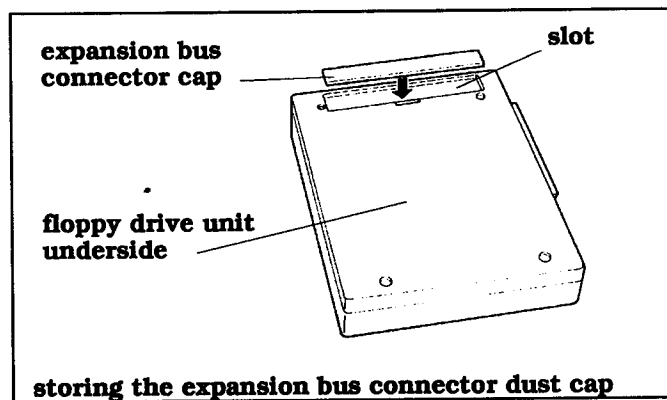

Note: When the expansion bus connector is not in use, replace the cap.

3. Attach the floppy drive unit to this connector.



3.5-inch Floppy Drive Unit

4. Turn the two wheel screws on the floppy drive unit clockwise to secure the floppy drive unit to the computer.

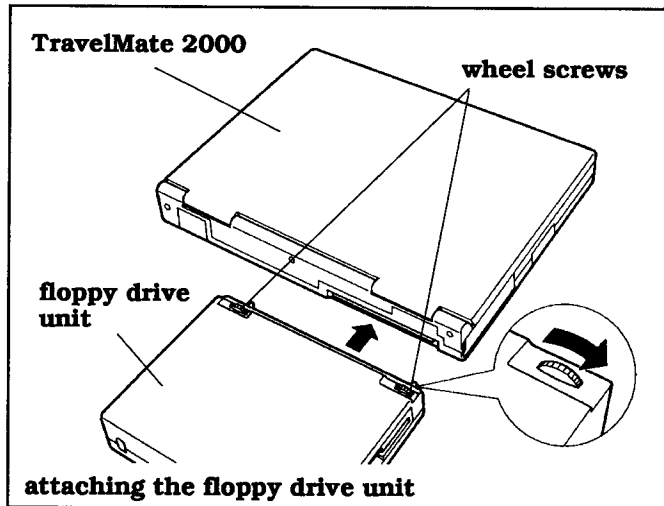

Note: Do not transport the TravelMate 2000 when the Floppy Drive Unit is attached.

Using the optional 3.5-inch Floppy Drive Unit enables you to add a 5.25-inch drive (not offered by Texas Instruments). The 5.25-inch drive connects to the 3.5-inch Floppy Drive Unit through a port on the rear panel of the 3.5-inch Floppy Drive Unit casing. You also can use an external keyboard when the 3.5-inch floppy drive unit is attached.

For directions on using your 5.25-inch drive, see the manual furnished with the 5.25-inch drive.

3.5-inch Floppies

The floppy drive unit uses 3.5-inch 720 K byte (2DD) or 1.44 M byte (2HD) floppy diskettes. A floppy is a magnetic storage medium that holds data created on a computer. Once data is stored on a floppy, it can be re-used whenever necessary or replaced when no longer needed.

3.5-inch Floppy Drive Unit

Formatting a Floppy

In order to store data on a floppy, the operating system must first prepare-format-the floppy. This process enables data on the floppy to be easily located.

During formatting, the floppy is divided into circular tracks, similar to those on a phonograph.

Each track is further divided into sectors that identify the data stored within the track. The track number and sector number act like addresses to the computer, making data access an automatic and rapid process.

During operation, the floppy rotates inside its plastic casing. As the floppy rotates, the read/write head of the drive moves from one track to another, locating data or finding space available for new data. You need not be concerned with where the data is stored on a floppy; MS-DOS manages that function automatically.

Taking Care of Floppies

To safeguard the data stored on a floppy, it is important that you handle floppies with care.

Storage-Although 3.5-inch floppies are housed in a durable plastic casing, it is a good idea to keep floppies you are not using in a box to protect them against dust, damage, or loss. A variety of plastic boxes are available at most computer stores.

Label-When you purchase blank floppies, labels usually are supplied. Get into the habit of always labeling your floppies with the names of the files or programs they contain and the date on which you made the copy. This is particularly important when making backup floppies.



3.5-inch Floppy Drive unit

Access Shutter-The access shutter allows the drive head to read from and write to the floppy. The shutter opens automatically when you insert the floppy into the drive. Do not open the shutter manually, as this will expose the floppy surface to dust.



Caution: Never open the access shutter on the floppy. This will expose the surface of the floppy to dust.

Write-Protect Tab -The write-protect tab is used to prevent inadvertent changes to important files. To

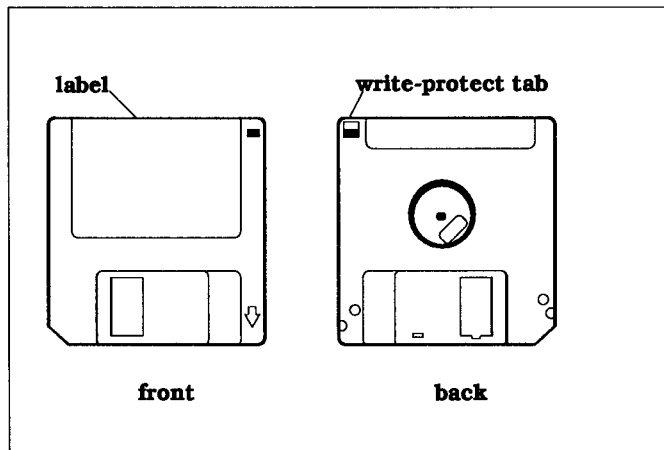

write-protect a floppy, slide the write protect tab to the open position: to allow the computer to write on the floppy, slide the tab to the closed position.

Follow these guidelines when handling floppies:

- Always keep floppies away from magnetic fields such as telephones or speakers.
- When inserting a floppy into a disk drive, be sure it clicks into place. Using the computer with an improperly inserted floppy may cause damage to the drive and the floppy. Never force the floppy into the 3.5-inch Floppy Drive Unit.

3.5-inch Floppy Drive Unit

- Never remove a floppy from the drive while the computer is reading from or writing to the floppy.
- Never expose floppies to moisture, excessive heat or direct sunlight.
- If a floppy appears to be damaged, make a copy of it if possible, and discard the damaged floppy immediately.

Inserting a Floppy into the Drive

- Insert the floppy into the drive slot, shutter end first, with the label side facing toward you.
- Gently push the floppy into the slot until it clicks into place. Never force the floppy into the 3.5-inch Floppy Drive Unit.

To remove a floppy, push in the eject button until the floppy pops out.



Caution: Never attempt to remove a floppy from the disk drive when the Floppy Drive indicator on the indicator panel is lit. This can damage both the contents of the floppy and the floppy drive.

Numeric Keypad

Connecting the optional Numeric Keypad (TI Part No. 2568033-000 1) enables numeric data to be conveniently entered while still permitting data entry on the keyboard. The Numeric Keypad also adds the convenience of direct access to some functions (such as **PgUp**, **PgDn**, **Home**, etc.) without the need to use the **Fn** key.

Connection

1. Turn off the computer.
2. Remove the dust cap from the Numeric Keypad connector. The removed cap can be put into the slot on the bottom panel of the Numeric Keypad for storage.

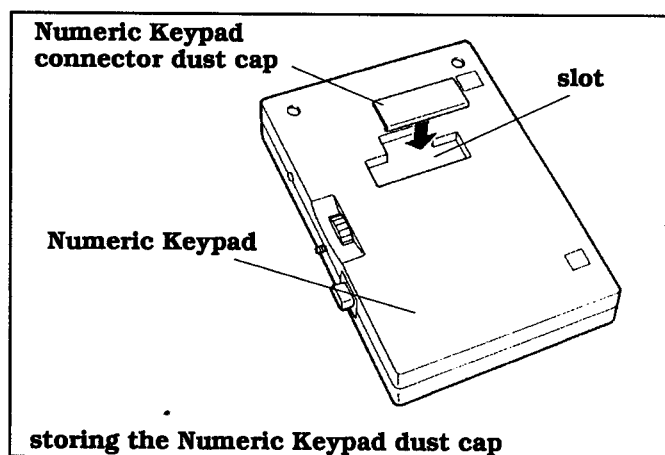

Note: When the Numeric Keypad connector is not in use, replace the cap.

Numeric Keypad

3. Attach the Numeric Keypad to the computer by joining the connector on the left side of the Numeric Keypad with the connector on the right side of the computer.
4. Using your fingers, turn the wheel screw on the Numeric Keypad clockwise until tight.

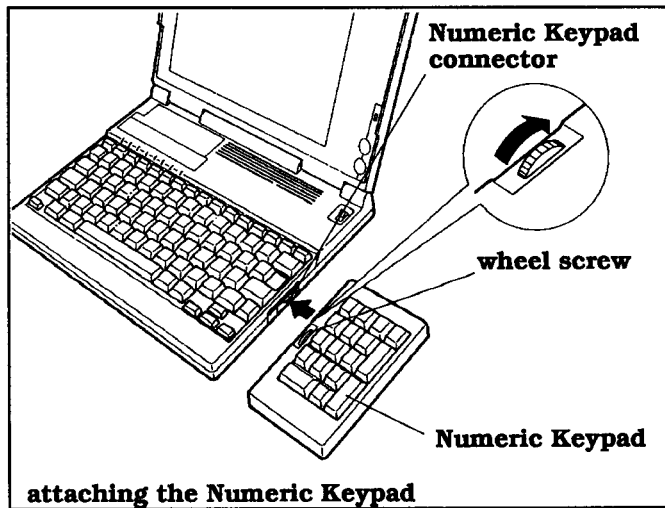

Note: Do not transport the TravelMate 2000 when the Numeric Keypad is attached.

RAM Card

The TravelMate 2000 computer comes with 1 M byte of main memory (RAM). If you need to expand the RAM capacity, up to two optional RAM cards (TI Part No. 2568034-0001), each containing 1 M byte of memory, can be installed.

Installing the RAM Card

1. Remove the internal battery as described in Chapter 3 and carefully turn the computer over on a padded surface.
2. Using a Phillips-head screwdriver, remove the two screws on the bottom panel of the computer.

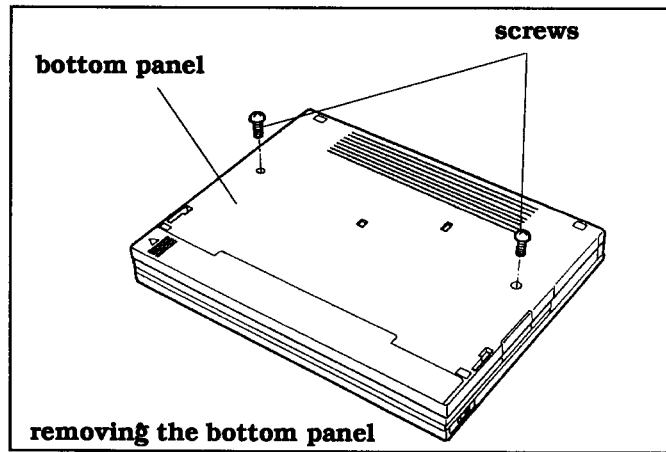

3. Holding the bottom panel with your hands, open the LCD screen and turn the computer on its side. Insert the straightened end of a paper clip into one of the screw holes. Push gently on the back of the keyboard to loosen it from the computer case.



Note: Do not disconnect the cable connecting the keyboard to the computer case.

4. Holding the keyboard, set the computer upright. Place the keyboard in front of you with the keys facing down as shown in the following figure.

Caution:



Prevent possible component damage cause by electrostatic discharge (ESD). Use a high-impedance, grounded-conductive floor mat or wrist strap to prevent ESD. Before touching the Integrated circuit devices, discharge static electricity from your hands, tools, and containers by touching them to a grounded surface.

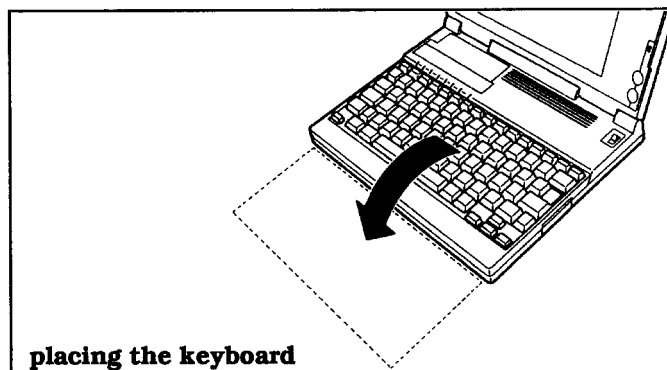

5. With the connector side of the RAM card facing up, slide the card along the guides so that the connector on the RAM card fully mates with the rear connector in the computer. The first M byte RAM card is inserted into the rear connector. A second RAM card, if installed, is inserted into the front connector.

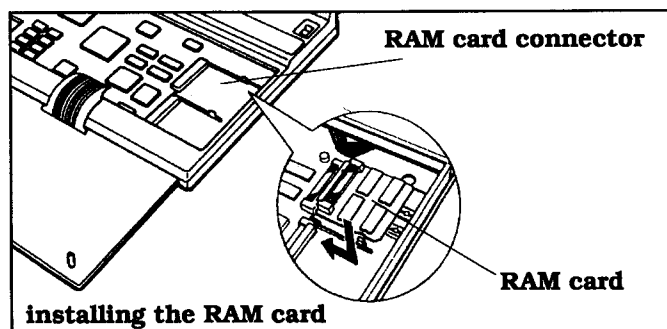

RAM Card

6. Insert the three tabs on the keyboard panel into the slots on the main unit, replace the keyboard panel and close the screen.

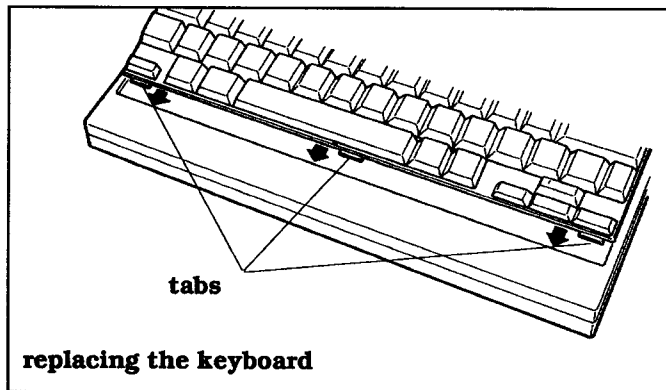

7. Holding the bottom panel with your hands, turn the computer over so that the bottom panel faces up.
8. Secure the bottom panel with two screws.

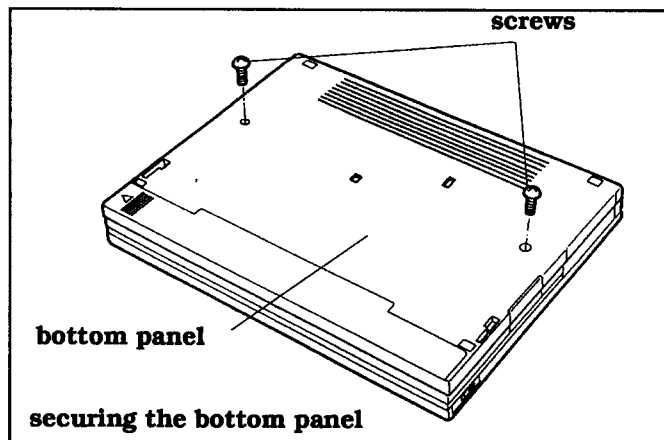

9. Reinstall the battery, as described in Chapter 3.

This completes the installation of the RAM card(s).

After installing the RAM card, return to the Hardware Installation Screen to set the correct amount of extended and/or expanded memory. In addition, the settings on the Set Up and Hardware Installation screens may no longer be valid if you kept the battery out too long during installation of the RAM card. See Chapter 4 for more information.

For details on extended and expanded memory, see Appendix H.

CRT Adaptor

The CRT Adaptor (TI Part No, 2568035-000 1) supplies an optional CRT port for your TravelMate 2000. With this adaptor installed, an analog multi frequency or a VGA monitor with a 15-pin male connector can be used with your computer.



Note: If the Internal Modem Option is installed in your TravelMate 2000, you must remove it to install the CRT Adaptor. Store the Internal Modem Option in a bag that protects against electrostatic discharge.

Installation

To install the CRT Adaptor:

1. Remove the battery, as described in Chapter 3.
2. Locate the option card slot cover on the top left of the computer.
3. Remove the template on the top of the keyboard, to reveal a groove. Hook a small screwdriver in the groove and open the option card slot cover.



Caution: Prevent possible component damage caused by electrostatic discharge (ESD). Use a high-impedance, grounded-conductive floor mat or wrist strap to prevent ESD. Before touching the integrated circuit devices, discharge static electricity from your hands, tools, and containers by touching them to a grounded surface.

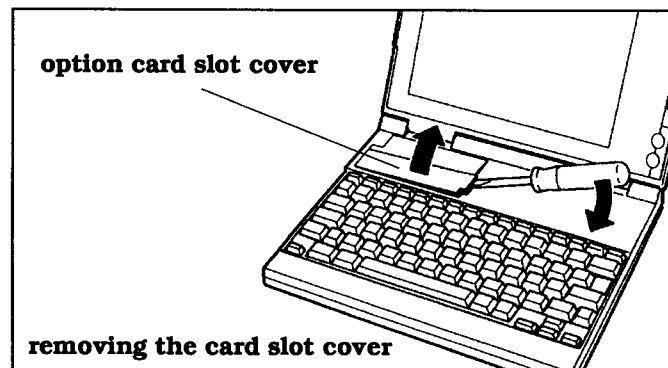

CRT Adaptor

4. With the component side facing down, insert the CRT Adaptor into the slot. Be sure that the connectors on the computer and on the lower side of the CRT Adaptor fully mate, and then tighten the two screws on the CRT Adaptor.

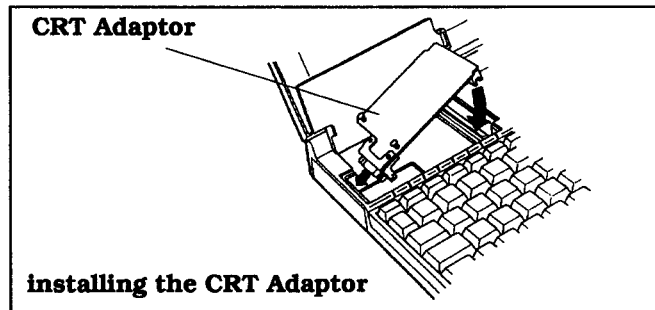

5. Close the option card slot cover by pushing down on both sides of the cover and replace the template.

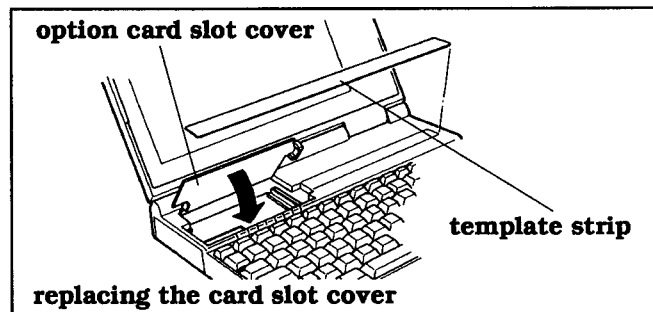

6. Reinstall the battery, as described in Chapter 3. This completes the installation of the CRT Adaptor. The external CRT connector can now be found on the left side of the computer.

Since you removed the battery during installation, the settings on the Set Up and Hardware Installation screens may have changed. From the Set Up and Hardware Installation screens, enter appropriate values for each category, as described in Chapter 4.

External Monitor

Using the optional CRT Adaptor allows you to connect an external monitor via a 15-pin analog connector.

To connect an external monitor:



Caution: Always turn the computer off before operating the LCD/CRT switch on the left side of the computer.

1. Slide the LCD/CRT switch on the left side panel of the TravelMate 2000 to the CRT position.
2. Connect the external monitor to the 15-pin analog connector on the left side panel of the computer.
3. If a snap-on ferrite was provided with the CRT Adaptor, you must snap the ferrite around the monitor interface cable next to the connector which attaches to your TravelMate 2000. Open the ferrite and place the cable along the groove within the ferrite. Close the ferrite and snap the casing shut.



Note: Failure to install the ferrite, if provided, results in noncompliance with FCC Regulations.

4. Turn on the power to the monitor, then turn on the power to the TravelMate 2000.

The following multi frequency external and VGA monitors are supported:

- 31 kHz/70 Hz (400/200 line mode)
- 60 Hz (480 line mode)
- IBM PS/2 monitors.

2400 BPS Modem with Send-Fax and MNP Class 5

The 2400 BPS Modem with Send-Fax and MNP Class 5 (Internal Modem) option (TI Part No. 2566941-0001) adds a 2400 bits-per-second (bps) modem to your TravelMate 2000. For modem or fax-sending operation, you can connect your TravelMate 2000 to the telephone network.

For more information on the Internal Modem option, see the user's manual that accompanies the modem.

80C287 Coprocessor

A Texas Instruments 80C287 coprocessor can be added to your system to speed up processing and improve throughput of calculations with application programs that support a math coprocessor.

Installing the 80C287 Coprocessor

1. Remove the internal battery as described in Chapter 3 and carefully turn the computer over on a padded surface.
2. Using a Phillips-head screwdriver, remove the two screws on the bottom panel of the computer.

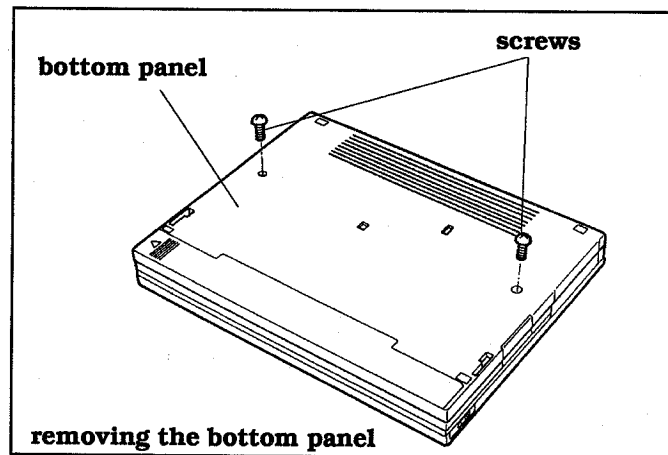

3. Holding the bottom panel with your hands, open the LCD screen and turn the computer on its side. Insert the straightened end of a paper clip into one of the screw holes. Push gently on the back of the keyboard to loosen it from the computer case.

80C287 Coprocessor

4. Holding the keyboard, set the computer upright. Place the keyboard in front of you with the keys facing down as shown in the following figure.

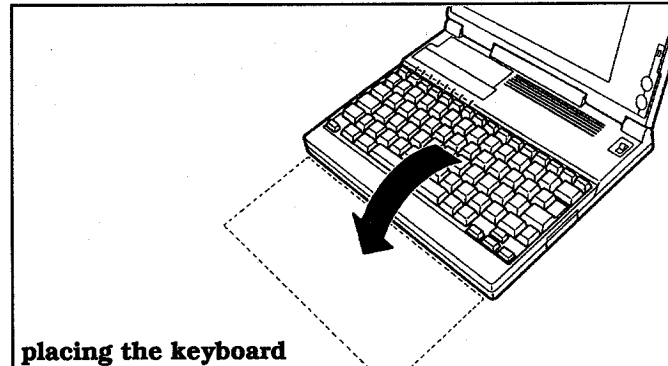

5. Making sure that the pins on the 80C287 coprocessor are straight and aligned with the socket, insert the 80C287 coprocessor into the socket. Be sure that the notch on the 80C287 coprocessor is in the same position as indicated by the outline on the board.



Caution: Prevent possible component damage caused by electrostatic discharge (ESD). Use a high-impedance, grounded-conductive floor mat or wrist strap to prevent ESD. Before touching the integrated circuit devices, discharge static electricity from your hands, tools, and containers by touching them to a grounded surface.

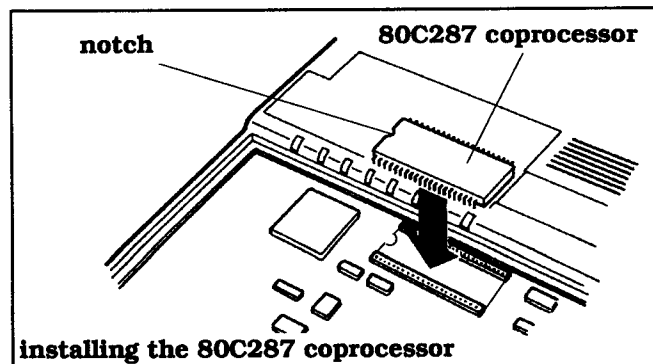

80C287 Coprocessor

6. Insert the three tabs on the keyboard panel into the slots on the main unit and replace the keyboard panel.

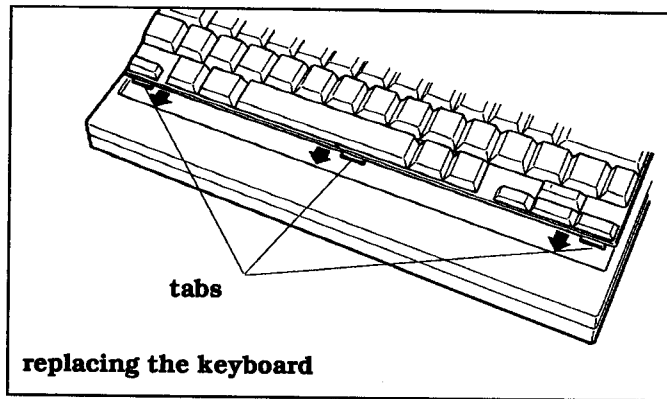

7. Holding the bottom panel with your hands, turn the computer over so that the bottom panel faces up.
8. Secure the bottom panel with two screws

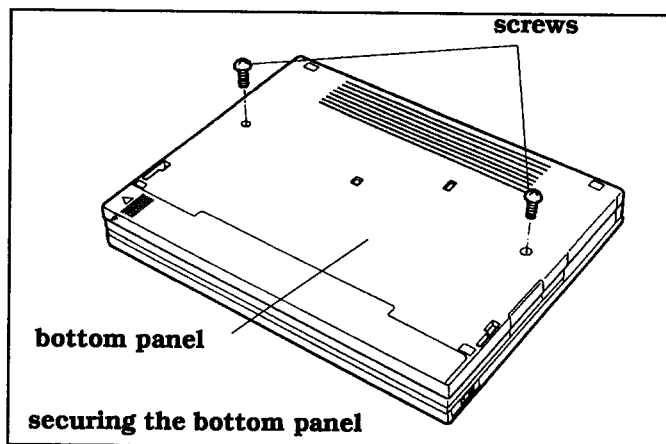

9. Reinstall the battery as described in Chapter 3.

80C287 Coprocessor

Because you removed the battery during installation, the settings on the Set Up and Hardware Installation screens may have changed. From the Set Up and Hardware Installation screens, enter appropriate values for each category, as described in Chapter 4.

External Keyboards

The TravelMate 2000's standard keyboard supports all the key functions of the IBM 101/102-key Enhanced Keyboard layout. In addition, a full-sized keyboard can be connected to the TravelMate 2000 via the external keyboard connector on the optional 3.5-inch Floppy Drive Unit.



Caution: Do not connect an external keyboard that draws more than 275 mA at +5 V. Texas Instruments accepts no liability for damage that may be caused either to the keyboard or to the TravelMate 2000 by connecting a keyboard which exceeds the above current limitation.

The keyboard cable from the external keyboard must have a 6-pin mini-DIN connector. An IBM PS/2 or compatible keyboard can be used with the TravelMate 2000.



Note: Always turn off the computer before connecting or disconnecting the external keyboard.

Texas Instruments makes a variety of printers, any of which can be used with your TravelMate 2000. To connect a parallel printer, use the supplied conversion adaptor between the parallel port and the TravelMate 2000 printer port. To use a serial printer, connect the printer to the serial port on the left side of the TravelMate 2000 case.

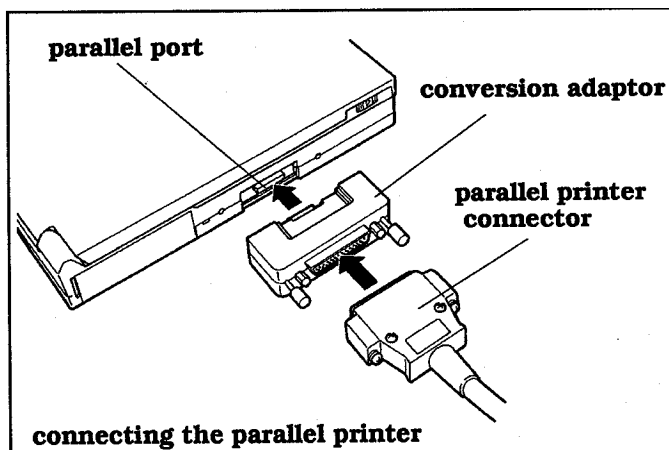

Note: When the conversion adaptor is in use, the dust cap removed from the main unit can be put into the slot on the conversion adaptor for storage. Always replace the dust cap when the conversion adaptor is not in use.

To connect a serial printer, select the hardware installation screen and set the Serial I/O field appropriately. Then connect the serial printer to the serial port on the left side panel of the TravelMate 2000 case.

Central Processing Unit (CPU)

Type: 16-bit 80C286
Clock Speed: 6 MHz/7.16 MHz/ 12 MHz

Memory

RAM: 1 M byte internal RAM standard, expandable to 3 M bytes. ROM: 128 K byte P-ROM for IPL, BIOS, power-on check, set up and hardware installation functions, and VGA-BIOS. One 1 M byte Mask-ROM for MS-DOS 4.01, LapLink, diagnostics, and other utilities

Display

Technology: Illuminated triple supertwist
liquid crystal display
Size: 8 by 6 inches (203 by 153 mm)
Characters/line: 80
Lines/screen: 25
Resolution: 640-by-480 pixels bit-mapped

Physical Dimensions

Size:
Width: 11 inches (279 mm)
Depth: 8.5 inches (216 mm)
Height: 1.4 inches (34.5 mm)
Weight: Approximately 4.4 lbs (2 kg) including battery



Specifications

Power Source

NiCad battery:	1 1 .5 watt hours/AC Adaptor
AC Adaptor	
Input:	100 to 240 Vac, 0.7 to 0.4 A, 50 to 60 Hz
Output:	15 Vdc, 1.8 A, approx. 27 W

Temperature

Operating:	50° to 95° F (10° to 35° C)
Storage/Transit:	-4° to 140° F (-20° to 60° C)

Humidity

Operating:	20% to 80%
Storage/Transit:	10% to 90%

Standard Ports

Parallel Port	Centronics Interface, 26-pin female connector with 25-pin conversion adaptor
Serial Port	RS-232C Interface, 9-pin male DB-9 connector for full duplex asynchronous transmission at up to 9600 baud

Drives

Hard disk drive:	2.5 inch 20 M byte hard disk Average access time = 23 ms
------------------	--

Keyboard

Keys:	79 (U.S. keyboard only)/80 including: 12 programmable function keys, Fn , and Set Up keys; all 101/ 102 keys on the IBM enhanced keyboard are supported.
-------	--

Options

Add-On Battery Pack

TI Part No. 2568030-0001
Attaches to rear of TravelMate 2000
Extends battery life by approx. 3 hours
Size:

Width: 1 1 inches (279 mm)
Depth: 2.3 inches (59 mm)
Height: 1.4 inches (34.5 mm)
Weight: 1.9 lbs (880g)

Internal Modem

TI Part No. 2566941-0001
Power

Requirements: Maximum 25mA at -5V
Maximum 200 mA at +5V

Power Control

The Internal Modem operates under two power modes:

Low Power: Only ring detect circuit powered
High Power: AU modem circuits powered
Agency Approvals: FCC, Part 15, Class B (U.S.A.)

FCC Part 68 (U.S.A.)
DOC CS-03 (Canada)
UL and CSA safety

Compatibility: Hayes 2400B
Bell 103 and 212A
CCITT V.2 1, V.22, V.22bix, and
V.27ter MNP class-5 error-correcting protocol
T.30 fax protocol

Telephone

Line Connectors: RJ-11-C

Asynchronous Data Formats:	Start Bits	Data Bits	Parity	Stop bits
	1	7	even or odd	1 or more
or:	1	8	none	1



Specifications

80C287 Coprocessor

TI Part No. 2560874-0001
16-bit 80C287 running at 12 MHz

CRT Interface Board

TI Part No. 2568035-0001
15-pin D-SUB analog connector
Size:

Width:	2.2 inches (55 mm)
Depth:	4.3 inches (110 mm)
Height:	0.6 inches (16 mm)
Weight:	0.11 lbs (50g)

Floppy Drive Unit

TI Part No. 2568031-0001
3.5-inch 1.44 M byte drive
5.25-inch Floppy Drive Connector
External keyboard connector
Size:

Width:	14.7 inches (166 mm)
Depth:	8.3 inches (143 mm)
Height:	1.4 inches (34.5 mm)
Weight:	1.4 lbs (630g)

RAM Card

TI Part No. 2568034-0001
1M byte RAM card
Extended or EMS support
Up to two cards can be installed
Size:

Width:	1.9 inches (47 mm)
Height:	1.7 inches (44 mm)
Weight:	0.03 lbs (17g)

Specifications

Numeric Keypad

TI Part No. 2568033-0001

Size:

Width: 3.9 inches (99 mm)

Depth: 5.5 inches (139 mm)

Height: 0.9 inches (24 mm)

Weight: 0.35 lbs (160g)



B

Taking Care of Your Computer

We recommend that you regularly take the time to check over your TravelMate 2000 and to clean the screen, keyboard and case. You can spot trouble before it starts, and help give you efficient, trouble-free computing with your TravelMate 2000.

Taking Care of Your Computer B-1

Do's and Don'ts

The TravelMate 2000 is a precision instrument containing many sensitive components. It should be handled with care. Here are some steps you can take to prevent damage to your system:

- Never use the TravelMate 2000 in harsh environments where it may be subjected to rapid temperature changes or excessive dust.
- Never expose the TravelMate 2000 to excessive vibration.
- Never place anything on top of the computer when it is recharging or operating, as this can cause overheating.
- Do not operate the TravelMate 2000 from a power socket whose voltage fluctuates excessively.
- Do not try to force the LCD screen beyond its fully opened position.



Caution: In the rare event that you should see or smell any-thing which indicates overheating (smoke or a strange smell), turn off the power immediately and contact your Texas Instruments dealer or TI Service, 1-800-522-4535.

Cleaning the Case

It is important to keep the case of the TravelMate 2000 free of dust. Apply a small amount of dust remover to a dry, lint-free cloth and wipe the case with the cloth.

Never use alcohol, benzine, thinner or other strong chemical agents that may damage the TravelMate 2000's case.

Cleaning the Screen

The surface of the screen is covered with a protective plastic film that may become smeared and accumulate dust during use. Try not to touch the screen with your fingers when using the computer.

Clean the screen regularly by applying a small amount of a diluted neutral detergent to a dry, lint-free cloth. Gently rub the surface of the screen with the cloth.



Caution: Never spray cleaning fluid or any liquid directly onto the case or screen.

Conserving Battery Power

With a little care, you can maximize the time that your TravelMate 2000 will operate on a single battery charge. The following tips will enable you to run your computer for the longest possible time on battery power.

- Keep the illumination of the LCD screen at the lowest comfortable brightness level.
- Use the hard disk Power Saving function on the Set Up screen to ensure that the hard disk is not powered for long periods when it is not being accessed. But bear in mind that if the HDD Motor Off period is too short, this will drastically increase hard disk access time, since the drive motor takes several seconds to power up before disk accesses.
- You can choose between three CPU speeds: 12 Mhz, 7.16 MHz and 6 MHz. The lower the CPU speed, the less power the computer uses. When using an application which is not CPU-intensive, (for instance, many word processing programs) set the CPU speed to the lowest setting on the Hardware Installation screen.
- The fewer options that are connected to the computer, the lower the power consumption. Note, however, that printers and external monitors do not get their power from the TravelMate 2000, and so have no effect on power consumption. A numeric keypad, an external keyboard, or an external floppy drive unit will drain the battery quickly, so we recommend running the TravelMate 2000 with the AC Adaptor when using any of these devices.
- Refer to your *BatteryPro* and *Productivity Software User's Manual* for more information on conserving battery power.

Care and Handling of the Battery]

The battery should be handled carefully to ensure maximum life. In particular:

- Do not drop the battery or subject it to shocks.
- Do not leave the battery exposed to direct sunlight.
- Do not try to take the battery apart.
- Do not expose the battery to moisture or chemical fluids.
- Do not short the battery leads, or connect the battery with the wrong polarity.
- Never use the battery to power other products.
- Never recharge the battery in a way different than described in this manual.
- Never dispose of an old battery in fire.
- Always charge the battery as soon as possible after the **Battery** indicator turns red. If you continue to use the computer, at some time after the indicator shows red it Will start to blink. This is to warn you that the computer is about to automatically turn off to prevent damage to the computer hardware.
- All batteries naturally discharge if unused for a long period of time. If you are not going to use your TravelMate 2000 for an extended period, be sure to recharge the battery every 6 months.



Care and Handling of the Battery

- ❑ When using the computer or External Battery Pack for the first time, or after prolonged storage in temperatures over 95° F (35° C), the life of a single battery charge may initially be shorter than normal. This problem will disappear after a few discharge-recharge cycles.

The TravelMate 2000 Computer character sets are identical to the IBM Code Pages for DOS version 4.01. This section shows the character sets for Code Page 437 (United States), 850 (Multilingual), 860 (Portuguese), 863 (Canadian-French), and 865 (Nordic), with the decimal and hexadecimal codes for each character. The five character sets contain differences in the international, symbol, and graphics characters above decimal code 128 (extended ASCII characters).



Note: The extended ASCII characters which are not on the keyboard (128 to 255 decimal) can be displayed at the MS-DOS prompt, and in many application programs as follows. Holding down the **Alt** key, type the ASCII decimal code for the character using the keys with numbers in their front face with the **Fn** key held down or with the **Num Lk** key on. Release the **Alt** key and the character is displayed on the screen. Your printer may or may not print these extended characters, depending on the type of printer you have. Refer to the character code tables in your printer manual.



Character Sets

Code Page 437, United States

Decimal Value	→	0	16	32	48	64	80	96	112	128	144	160	176	192	208	224	240
↓	Hexa-decimal Value	0-	1-	2-	3-	4-	5-	6-	7-	8-	9-	A-	B-	C-	D-	E-	F-
0	-0	▶		0	@	P	·	p	Ç	É	á	⋮	⋮	⋮	⋮	⋮	⋮
1	-1	☺	◀	!	1	A	Q	a	q	ü	æ	í	⋮	⋮	⋮	⋮	⋮
2	-2	☹	↑	'	2	B	R	b	r	é	Æ	ó	⋮	⋮	⋮	⋮	⋮
3	-3	♥	!!	#	3	C	S	c	s	â	ô	ú		⋮	⋮	⋮	⋮
4	-4	♦	¶	\$	4	D	T	d	t	ä	ö	ñ	⋮	⋮	⋮	⋮	⋮
5	-5	♣	§	%	5	E	U	e	u	à	ò	Ñ	⋮	⋮	⋮	⋮	⋮
6	-6	♠	—	&	6	F	V	f	v	â	û	±	⋮	⋮	⋮	⋮	⋮
7	-7	•	‡	'	7	G	W	g	w	ç	ù	°	⋮	⋮	⋮	⋮	⋮
8	-8	■	↑	(8	H	X	h	x	ê	ÿ	¿	⋮	⋮	⋮	⋮	⋮
9	-9	○	↓)	9	I	Y	i	y	ë	Ö	⋮	⋮	⋮	⋮	⋮	⋮
10	-A	■	→	*	:	J	Z	j	z	è	Ü	⋮	⋮	⋮	⋮	⋮	⋮
11	-B	♂	←	+	;	K	[k	{	ï	ç	½	⋮	⋮	⋮	⋮	⋮
12	-C	♀	⌞	,	<	L	\	l		ï	£	¼	⋮	⋮	⋮	⋮	⋮
13	-D	♪	↔	-	=	M]	m	}	ï	¥	ı	⋮	⋮	⋮	⋮	⋮
14	-E	🎵	▲	.	>	N	˘	n	˘	Ä	Pt	◀	⋮	⋮	⋮	⋮	⋮
15	-F	☼	▼	/	?	O	˘	o	◊	À	f	▶	⋮	⋮	⋮	⋮	⋮

Code Page 850, Multilingual

Decimal Value	→	0	16	32	48	64	80	96	112	128	144	160	176	192	208	224	240
↓	Hexa-decimal Value	0-	1-	2-	3-	4-	5-	6-	7-	8-	9-	A-	B-	C-	D-	E-	F-
0	-0		▶		0	ø	P	·	p	Ç	É	á	⋮	Ł	ø	Ó	-
1	-1	☺	◀	!	1	A	Q	a	q	ü	æ	í	⋮	±	Đ	β	±
2	-2	☹	↑	"	2	B	R	b	r	é	Æ	ó	⋮	±	Ê	Ô	=
3	-3	♥	!!	#	3	C	S	c	s	â	ô	ú		±	Ë	Ö	‰
4	-4	♦	¥	\$	4	D	T	d	t	ä	ö	ñ	±	-	È	õ	•
5	-5	♣	§	%	5	E	U	e	u	à	ò	Ñ	Á	+	ı	Ö	§
6	-6	♠	-	&	6	F	V	f	v	â	û	±	À	ã	í	μ	÷
7	-7	•	‡	'	7	G	W	g	w	ç	ù	±	À	Ã	î	þ	•
8	-8	■	↑	(8	H	X	h	x	ê	ÿ	¿	©	±	İ	þ	•
9	-9	○	↓)	9	I	Y	i	y	ë	Ö	®	±	±	±	Ú	•
10	-A	■	→	*	:	J	Z	j	z	è	Ü	±	±	±	±	Û	•
11	-B	♂	←	+	:	K	[k	{	ï	ø	½	±	±	■	Ü	¹
12	-C	♀	↳	.	<	L	\	l		î	£	¼	±	±	■	Ý	³
13	-D	♪	↔	-	=	M]	m	}	ì	Ø	ì	±	±	±	Ý	²
14	-E	♫	▲	.	>	N	^	n	^	Ä	x	<	¥	±	±	ì	•
15	*-F	⚙	▼	/	?	O	_	o	□	À	f	>	±	±	■	·	•



Character Sets

Code Page 860, Portuguese

Decimal Value	→	0	16	32	48	64	80	96	112	128	144	160	176	192	208	224	240
↓	Hexa-decimal Value	0-	1-	2-	3-	4-	5-	6-	7-	8-	9-	A-	B-	C-	D-	E-	F-
0	-0	▶		0	@	P	·	p	Ç	É	á	¶	⊥	α	=		
1	-1	☺	◀	!	1	A	Q	a	q	ü	À	í	⊕	≡	β	±	
2	-2	☹	↑	'	2	B	R	b	r	é	È	ó	⊖	≠	Γ	≥	
3	-3	♥	!!	#	3	C	S	c	s	â	ô	ú		⊗	π	≤	
4	-4	♦	¶	\$	4	D	T	d	t	ã	õ	ñ	⊘	—	Σ	f	
5	-5	♣	§	%	5	E	U	e	u	à	ò	Ñ	≡	+	=	σ	∫
6	-6	♠	—	&	6	F	V	f	v	Á	Ú	≡	⊗	⊗	μ	÷	
7	-7	●	‡	'	7	G	W	g	w	ç	ù	≡	⊗	⊗	τ	~	
8	-8	■	†	(8	H	X	h	x	ê	î	¿	⊗	⊗	φ	°	
9	-9	○	↓)	9	I	Y	i	y	Ê	Ô	Ò	⊗	⊗	∫	°	
10	-A	■	→	*	:	J	Z	j	z	è	Û	⊗	⊗	⊗	Ω	·	
11	-B	♂	←	+	;	K	[k	{	ï	ø	½	⊗	⊗	■	δ	✓
12	-C	♀	⊥	,	<	L	\	l		Ó	£	¼	⊗	⊗	■	∞	n
13	-D	♪	↔	-	=	M]	m	}	ì	Ü	ì	⊗	⊗	■	φ	z
14	-E	♫	▲	.	>	N	^	n	~	Ã	Pt	<	⊗	⊗	■	ε	▪
15	-F	⚙	▼	/	?	O	_	o	□	Ã	Ó	>	⊗	⊗	■	∩	·

Code Page 863 (Canadian-french)

Decimal Value	→	0	16	32	48	64	80	96	112	128	144	160	176	192	208	224	240
↓	Hexa-decimal Value	0-	1-	2-	3-	4-	5-	6-	7-	8-	9-	A-	B-	C-	D-	E-	F-
0	-0	▶	0	@	P	·	p	Ç	É	!		⌒	±	α	=		
1	-1	☺	◀	!	1	A	Q	a	q	ü	Ê	⌒	±	≠	β	+	
2	-2	☹	↑	·	2	B	R	b	r	é	Ê	ó		⌒	≠	Γ	≥
3	-3	♥	!!	#	3	C	S	c	s	â	ó	ú		⌒	≠	π	≤
4	-4	♦	¶	\$	4	D	T	d	t	Â	È	·	⌒	—	≠	Σ	∫
5	-5	♣	§	%	5	E	U	e	u	à	Ï	·	≠	+	≠	σ	∫
6	-6	♠	—	&	6	F	V	f	v	¶	û	·	≠	≠	≠	μ	÷
7	-7	●	‡	'	7	G	W	g	w	ç	ù	·	⌒	≠	≠	z	—
8	-8	■	↑	(8	H	X	h	x	ê	Ï	⌒	≠	≠	≠	Φ	·
9	-9	○	↓)	9	I	Y	i	y	ë	Ô	⌒	≠	≠	⌒	Θ	·
10	-A	■	→	*	:	J	Z	j	z	è	Û	⌒		≠	⌒	Ω	·
11	-B	♂	←	+	:	K	[k	{	ï	ø	½	⌒	≠	■	δ	✓
12	-C	♀	⌒	,	<	L	\	l		î	£	¼	≠	≠	■	ε	∞
13	-D	♪	↔	-	=	M]	m	}	ù	¼	≠	≠	≠	■	φ	∞
14	-E	♫	▲	.	>	N	^	n	~	À	Û	<	≠	≠	■	ε	■
15	*-F	☼	▼	/	?	O	_	o	□	§	f	>	⌒	≠	■	∩	



Character Set

Code Page 865, Nordic

Decimal Value	→	0	16	32	48	64	80	96	112	128	144	160	176	192	208	224	240
↓	Hexa-decimal Value	0-	1-	2-	3-	4-	5-	6-	7-	8-	9-	A-	B-	C-	D-	E-	F-
0	-0	▶		0	@	P	˘	p	Ç	É	á	⌘	⌘	⌘	⌘	⌘	⌘
1	-1	☺	◀	!	1	A	Q	a	q	ü	æ	í	⌘	⌘	⌘	⌘	⌘
2	-2	☹	↑	'	2	B	R	b	r	é	Æ	ó	⌘	⌘	⌘	⌘	⌘
3	-3	♥	!!	#	3	C	S	c	s	â	ô	ú		⌘	⌘	⌘	⌘
4	-4	♦	¶	\$	4	D	T	d	t	ä	ö	ñ	⌘	⌘	⌘	⌘	⌘
5	-5	♣	§	%	5	E	U	e	u	à	ò	Ñ	⌘	⌘	⌘	⌘	⌘
6	-6	♠	—	&	6	F	V	f	v	à	û	⌘	⌘	⌘	⌘	⌘	⌘
7	-7	•	‡	'	7	G	W	g	w	ç	ù	⌘	⌘	⌘	⌘	⌘	⌘
8	-8	■	↑	(8	H	X	h	x	ê	ÿ	é	⌘	⌘	⌘	⌘	⌘
9	-9	○	↓)	9	I	Y	i	y	ë	Ö	⌘	⌘	⌘	⌘	⌘	⌘
10	-A	■	→	*	:	J	Z	j	z	è	Ü	⌘	⌘	⌘	⌘	⌘	⌘
11	-B	♂	←	+	;	K	[k	(ï	ø	½	⌘	⌘	⌘	⌘	⌘
12	-C	♀	⌘	.	<	L	\	l		ï	£	¼	⌘	⌘	⌘	⌘	⌘
13	-D	♯	↔	-	=	M]	m)	ï	ø	ï	⌘	⌘	⌘	⌘	⌘
14	-E	♫	▲	.	>	N	˘	n	˘	Ä	Pt	<	⌘	⌘	⌘	⌘	⌘
15	-F	⚙	▼	/	?	O	˘	o	◊	À	f	⌘	⌘	⌘	⌘	⌘	⌘

Keyboard Layouts

The following diagrams show the TravelMate 2000 Computer keyboard layouts for the **Fn** and **Num Lk** keys. These combinations make all 101 / 102 keys on the IBM Enhanced Keyboard layout available.

U.S. English Keyboard Standard

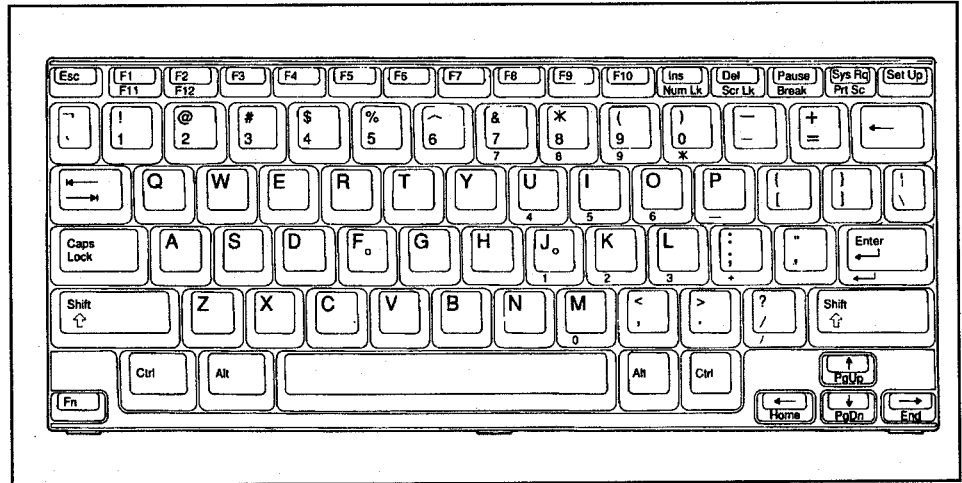

Keyboard Layouts

U.S. English Keyboard
F_n Key Held Down

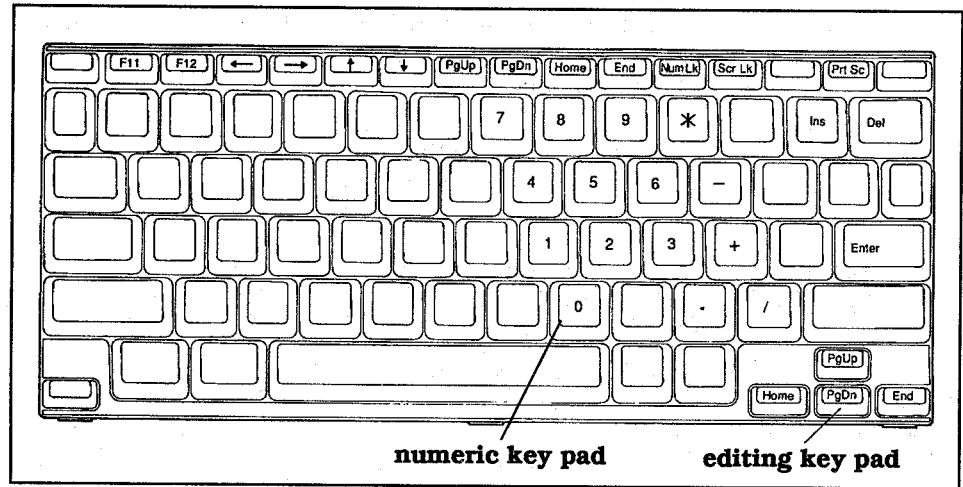

U.S. English Keyboard
Num Lk Key On

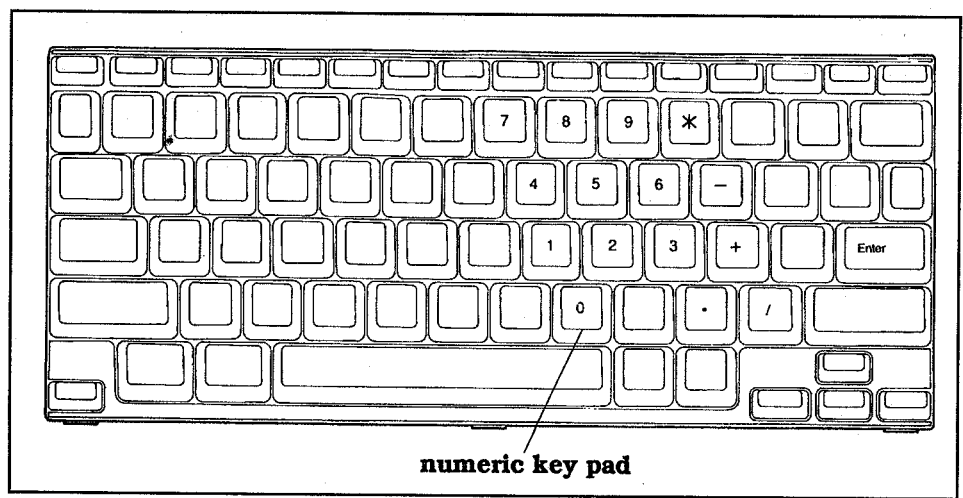

Keyboard Layouts

IBM Enhanced Keyboard

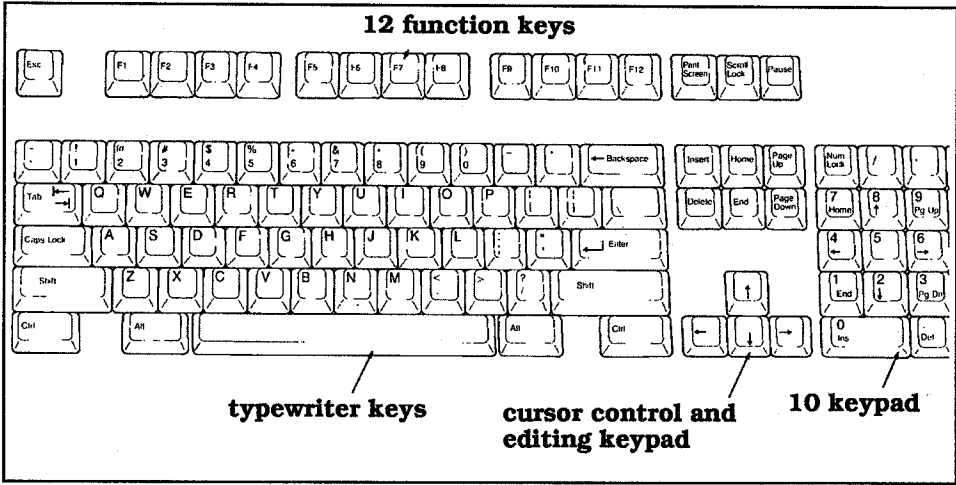

There are two diagnostic routines available to make sure your TravelMate 2000 Computer and its peripherals are functioning as they should. One routine is automatic and takes place every time you turn on the power. The other is accessed from a separate diagnostic program you have copied from the ROM disk to the hard disk during the installation procedure.

Power-On Diagnostics

When the system power is turned on, an automatic self-test begins. The self-test checks internal memory and displays the number of kilobytes available for use.

After a few seconds, MS-DOS starts to load, and the screen displays the following:

```
Texas Instruments Personal Computer System  
I/O Subsystem Version X.XX
```

before displaying the MS-DOS startup message. If MS-DOS fails to load from the hard disk (or a diskette if an optional Floppy Drive Unit is connected), an error message appears on the screen.

Turn off the power, wait 5 seconds, then turn it on again. If the error message appears repeatedly, call your Texas Instruments dealer.

Refer to the "BIOS Messages" section in this appendix for a list of power-on error messages.



Diagnostic Program

If the power-on diagnostic routine doesn't display any messages, but you suspect there is a problem, run the diagnostic Program included with MS-DOS on the ROM disk.

The diagnostic program contains the following checks:

- Real-Time Clock
- Memory
- Keyboard
- Video Subsystem
- Liquid Crystal Display
- Floppy Drive
- Printer
- Hard Disk Drive
- Hardware Installation

Note that you can access the Hardware Installation screen directly from the diagnostic program.

Starting the Diagnostic Program

Turn on power to the computer, and at the C:\> prompt type

DIAG

and press the **Enter** key. The diagnostic program starts up. This may take several seconds. The main menu is displayed on the screen.

Use the cursor keys to move the bar cursor to the particular diagnostic test you want to run and press the **Enter** key. Or press the **Esc** key to exit the diagnostic program and return to the C:\> prompt.

Some of the diagnostic test categories on the menu contain several separate tests. When you select one of these categories, a separate submenu is displayed. You can exit the sub-menu and return to the main menu by pressing the **Esc** key. Each category is described below.

Real-Time Clock (RTC)

This category contains the following four tests:

RTC Timer Check - Checks if the timer interrupt works correctly.

RTC Clock Check - Checks if the clock works correctly.

RTC CMOS RAM Check - Does a data read/write check on the special battery backed-up memory area used for the real-time clock.

Setup CMOS RAM Check - Does a data read/write check on the special battery backed-up memory area which holds the settings for the Set Up program.

Run All Checks - Checks all four above items in sequence.



Memory

This category contains the following checks:



Caution: **These checks will destroy the contents of the memory.**

Main Memory Check - Reads/writes data in the standard memory area. The check stops at the first error and displays an error message.

Extended Memory Check - Reads/writes data in the Extended memory area. The check stops at the first error and displays an error message.

Run All Checks - Checks both items above in sequence.

Keyboard

After selecting this test, you are prompted for the keyboard type. Move the bar cursor using the cursor keys to select either the U.S. English keyboard or other keyboard types and press the **Enter** key.

You are then prompted to answer whether or not you have an optional Numeric Keypad attached.

The keyboard test begins with a graphic representation of the keyboard layout displayed on the screen. To test whether a particular key functions as it should, press the key. A square should display on the keyboard layout at that position if the key is working correctly.

Video Subsystem

This test checks that the built-in video subsystem is working as it should. The video subsystem menu is displayed on the screen with the following categories:

Video Memory Check - Checks the buffer in the video subsystem.

DAC Check - Checks the digital-to-analog converter in the VGA subsystem when the optional CRT Adaptor is installed.

Attribute Check - Displays 16 foreground, 8 background, and 8 blinking shades of gray.

Character Set Check - Displays characters on the screen normally on an 80-by-25 text mode display.

Run All Checks - Runs all four checks above in sequence.

Liquid Crystal Display

This test checks the computer's LCD screen. Two test patterns are displayed-a checkered pattern and a striped pattern. Any defect in either pattern indicates a faulty screen.

Floppy Drive Unit



Note: This test is effective only when the optional Floppy Drive Unit is attached to the computer.

This test reads and writes data continuously to a floppy in the optional Floppy Drive Unit to test the read/write functions of the drive. After selecting the test, the floppy drive submenu is displayed with the following categories:



Caution: As the write-read check may erase data from the floppy in the drive under test, use a blank floppy or one containing data that you no longer need.

Read Check - Checks that data can be read from the floppy without errors. If an error is detected, the test stops and an error message is displayed.

Write-read Check - Checks if data can be written/read correctly by comparing data written to the floppy with data read from the floppy. This test destroys all existing data on the floppy. If an error is detected, the test stops and an error message is displayed.



Printer

This test checks the operation of the printer, if one is connected. After selecting the test, the printer submenu is displayed on the screen with the following categories:

Sense Printer Status Check - The printer status signals are checked and displayed. The following status categories are checked:

- Bsy** checks the printer busy signal
- Ack** checks that the printer can handshake with the main unit
- Pe** checks that the paper is set
- Sel** shows when the printer is online
- Ioe** checks that the printer's mechanical components are OK

An asterisk is displayed below a category when its check completes normally.

All Characters Print Check - Test printing will not start until the six status categories in the status check all show an asterisk (below the category). If a hardware malfunction is detected, an asterisk will not appear below the corresponding category. In this case, you will not be able to do a test print. Make a note of the error message, and contact your dealer.

Once all categories contain asterisks, press any key. The system returns to the menu. Try the print check. A test pattern should print.

Hard Disk Drive

This test reads and writes data continuously to the hard disk to test the read/write functions of the drive. After selecting the test, the hard disk submenu is displayed on the screen.



Caution: **The write-read check will erase all data on the hard disk.**

Read Check - Checks that data can be read from the hard disk without errors. If an error is detected, the test stops and an error message is displayed.

Write-read Check - Checks if data can be written/read correctly by comparing data written to the hard disk with data read from the hard disk. **This test destroys all existing data on the disk.** If an error is detected, the test stops and an error message is displayed. Do not run this test unless you have reason to believe there is a problem with your hard disk.

Hardware installation

This item displays the Hardware Installation screen. For details on how to make settings on this screen, refer to Chapter 4.



This section is designed to help you solve common problems you may encounter while using your TravelMate 2000 Computer. If you encounter a problem which is not listed here, please contact your nearest Texas Instruments dealer.

Unit doesn't come on when power switch is in ON position.

Low battery-Plug in AC Adaptor and run unit from ac power. After finishing operation, leave the unit plugged in for at least 2 hours to charge the battery.

AC Adaptor plugged into faulty outlet--Check ac outlet by plugging in another appliance (e.g., a lamp).

Neither of the above-Contact your Texas Instruments dealer.

The built-in LCD screen is blank.

Screen contrast control or brightness control-Adjust the contrast control or the brightness control on the right of the LCD screen.

LCD/CRT switch-Check that the LCD/CRT switch on the left side panel is set to LCD. When set to CRT, the built-in screen is automatically disabled.

None of the above-Screen power unit may be faulty. Contact your Texas Instruments dealer.

LCD screen backlight doesn't light, even when brightness control fully turned up.

Display unit turned off to save power (see "The Set up Screen" section in Chapter 4).-Press any key to turn backlight on again. Access the Set Up screen and change the Display Timeout setting. If the **POWER** indicator is orange, the unit is in Standby mode; press the **Fn-Pause** keys to turn Standby mode off.



Troubleshooting

The unit starts up but a message Indicates that a power-on test has failed.

TravelMate 2000 hardware-Turn the unit off and then on again. If the same message appears, check against the list of power-on error messages in the next section, and if necessary, make a note of the message and contact your Texas Instruments dealer.

Hardware installation setting--Check the settings on the Hardware Installation screen (see Chapter 4).

Power-up self-tests are the system tests and component initialization processes performed by the AT-compatible ROM BIOS in the TravelMate 2000 Computer. The central hardware is tested and initialized first. Proper functioning of the central hardware is required before further system tests can be run. In general, a failure in a test of the system board or its components will result in the sounding of a beep, and a halted system. A failure in add-on boards or memory is reported on the screen.

There are two types of messages displayed if the Travelmate 2000 fails one of the power-up tests:

- Error messages indicating a failure in the hardware, software, or firmware
- Informational messages about the power-up and booting processes

Power-up messages are listed below, with possible causes and solutions.

Messages that do not appear in this list indicate hardware faults that can be solved only by internal checks. Contact your authorized Texas Instruments dealer or Texas Instruments Service Center.

Power-On Self Test Error Messages

Diskette Drive X
seek failure

The optional Floppy Drive Unit has failed-Run the DIAG program to check the Floppy Drive Unit, then contact your Texas Instruments dealer.

Diskette read
failure

The floppy is either notformatted or defective-Replace with a formatted floppy.



BIOS messages

Hard disk failure	Reboot. If that doesn't work, run the DIAG program to check the hard disk drive, then contact your Texas Instruments dealer.
Hard disk read failure	<i>The hard disk is defective</i> - Reboot. If that doesn't work, run the DIAG program to check the hard disk, then contact your Texas Instruments dealer.
Invalid Configuration information	<i>Memory size is incorrectly configured, or Display adaptor is incorrectly configured, or Incorrect number of floppy drives</i> - Check the settings on the Set Up and Hardware Installation screens (see Chapter 4).
Keyboard clock/data line failure	<i>Either the keyboard or the external keyboard cable connection is defective</i> - Make sure the keyboard cable is connected properly.
Keyboard stuck key failure	<i>One or more keys are jammed</i> - Try pressing the key again. Run the DIAG program to check the keyboard keys.
No boot device available	<i>The floppy drive, the hard disk, or the floppy itself is defective</i> - Reboot. If that doesn't work, replace the floppy. If the hard disk is faulty, run the DIAG program, then contact your Texas Instruments dealer.
No boot sector on hard disk	<i>The hard disk is not formatted</i> - Format the hard disk. Remember that this will erase all contents of the hard disk.
Not a boot diskette.	<i>The floppy in the optional Floppy Drive Unit is not formatted as a bootable floppy</i> - Replace the floppy with a bootable floppy, then reboot.

Time-of-day clock
stopped

*The CMOS time-of-day clock chip
has failed*-Reset the time and date
on the Set Up screen (see Chapter 4).

Power-Up Self Test Informational Messages

XXX Main Memory,
XXX Extended

This message indicates the amount
of memory that has tested
successfully.

Memory tests
terminated by
keystroke

This message indicates that you
have pressed the **Spacebar** while
the memory tests were running.
This stops the memory tests.

Press Enter to run
the hardware
installation

This message indicates that an
error was found during the
power-up tests. Pressing the **Enter**
key brings you to the Hardware
Installation screen.

Press F1 to
continue/to retry
boot

This message indicates that an
error was found during the
power-up tests. Pressing the **F1** key
allows the system to attempt to
boot.

H

Configuring Memory

Computers handle information as strings of binary digits; one's and zero's. A single 1 or 0 is referred to as a "bit", the smallest piece of information handled by the processor. A group of eight bits, referred to as a "byte", is used to represent single characters or numbers such as "A" or "5". The size of the computer's memory is measured in terms of the number of bytes the memory can store. Because this number often runs into the thousands and even millions, the letter K (kilo) is used to represent thousands of bytes and M (mega) is used for millions of bytes. Because of differences between the binary and decimal number systems, one K byte actually represents 1024 bytes, and one M byte represents 1024 K bytes.

From the hardware point of view, there are two main types of internal memory used in computers: ROM and RAM.

ROM (Read Only Memory)-ROM is memory that permanently stores programs or data on integrated circuits. Information is programmed into the circuits in the manufacturing process and cannot be changed by the user.

RAM (Random Access Memory)-RAM is memory that is used to temporarily store data or programs-that is, information can be easily deleted and rewritten. RAM is used in the computer to store data and programs while the system is running. When the power is turned off, any information stored in RAM is lost.

Memory Map

MS-DOS accesses different areas of the TravelMate 2000's memory in different ways. This memory map shows the available memory areas and how MS-DOS uses them.

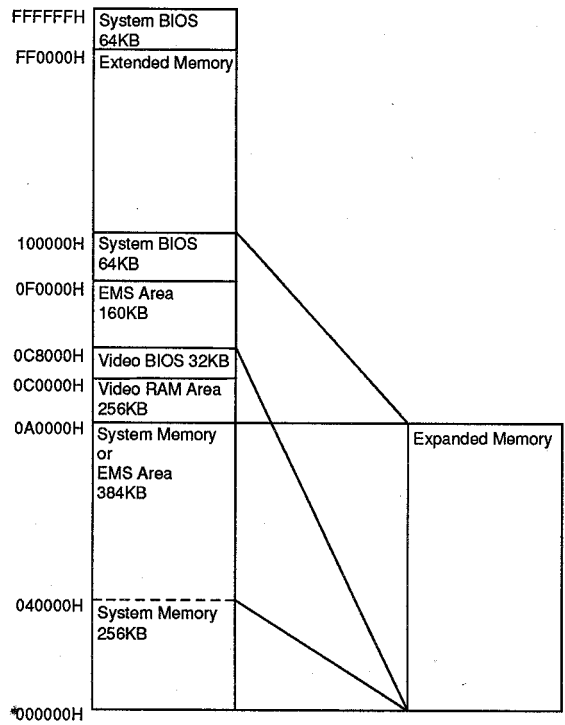

Memory Areas in the TravelMate 2000

Conventional memory

Also referred to as main memory, conventional memory is internal RAM up to 640 K bytes that MS-DOS accesses directly. Conventional memory is used for the execution of programs and commands and for storing temporary data. MS-DOS cannot directly access memory beyond this 640 K byte limit.

The amount of conventional memory (640 K byte) in the TravelMate 2000 is displayed on the Hardware Installation screen and cannot be changed.

Extended Memory

Extended memory is internal RAM above 1024 K byte. MS-DOS cannot directly access Extended memory as system memory, but the memory can be configured as one or more RAM disks. It can also be accessed by applications written to use this memory. The HIMEM.SYS device driver described later in this section allows MS-DOS programs to use an extra 64 K byte region located just above the 1 M byte mark for storage of code and data.

Expanded Memory

Expanded memory is memory conforming to the Expanded Memory Specification (EMS) developed by Lotus/Intel/Microsoft, and is known as LIM-EMS. The TravelMate 2000 supports EMS version 4.0. Expanded memory is accessed by allocating an area (usually 64 K byte) of the system memory between 640 K byte and 1 M byte (and between 256 K byte and 640 K byte when the /O option is used) as a "window." Pages of data are passed to and from Expanded memory through this window, which is called the "page frame". The page frame is divided into at least four physical pages of 16 K byte each.



Memory Areas in the TravelMate 2000

The total amount of internal memory above 640 K byte can be assigned to either Extended memory or Expanded memory by setting the internal memory size and boundary address on the hardware installation screen. The relationship between these two settings and each memory size is shown below.

Internal Memory: 1 M byte

Boundary	Extended	Expanded	Disable
100000H	0 K byte	384 K byte	0 K byte
110000H	64 K byte	320 K byte	0 K byte
140000H	256 K byte	128 K byte	0 K byte
180000H	256 K byte	128 K byte	0 K byte
200000H	0 K byte	128 K byte	256 K byte
240000H	256 K byte	128 K byte	0 K byte
300000H	0 K byte	128 K byte	256 K byte
340000H	256 K byte	128 K byte	0 K byte
400000H	0 K byte	128 K byte	256 K byte
440000H	256 K byte	128 K byte	0 K byte

Internal Memory: 2 M byte

Boundary	Extended	Expanded	Disable
100000H	0 K byte	1408 K byte	0 K byte
110000H	64 K byte	1344 K byte	0 K byte
140000H	256 K byte	1152 K byte	0 K byte
180000H	512 K byte	896 K byte	0 K byte
200000H	1024 K byte	128 K byte	256 K byte
240000H	1280 K byte	128 K byte	0 K byte
300000H	1024 K byte	128 K byte	256 K byte
340000H	1280 K byte	128 K byte	0 K byte
400000H	1024 K byte	128 K byte	256 K byte
440000H	1280 K byte	128 K byte	0 K byte

Memory Areas in the TravelMate 2000

Internal Memory: 3 M byte

Boundary	Extended	Expanded	Disable
100000H	0 K byte	2432 K byte	0 K byte
110000H	64 K byte	2368 K byte	0 K byte
140000H	256 K byte	2176 K byte	0 K byte
180000H	512 K byte	1920 K byte	0 K byte
200000H	1024 K byte	1152 K byte	256 K byte
240000H	1280 K byte	1152 K byte	0 K byte
300000H	2048 K byte	128 K byte	256 K byte
340000H	2304 K byte	128 K byte	0 K byte
400000H	2048 K byte	128 K byte	256 K byte
440000H	2304 K byte	128 K byte	0 K byte



Note: At least 128 K byte of memory is always assigned to Expanded memory.

A block of 128 K byte in the reserved memory area can also be assigned to Expanded memory. The Expanded Memory Manager (EMM) manages the interface between the program and Expanded memory, bringing data in and out through the page frame as required. Before you can use Expanded memory, you must install the EMM4J.SYS device driver, as described below.

You do not need to install the Expanded memory driver unless your application program supports use of Expanded memory.

Device Drivers

Four device drivers used for managing memory are included in ROM. They are:

EMM4J.SYS - device driver that supports LIM-EMS Expanded memory.

HIMEM.SYS - device driver that supports the use of Extended memory for storing a Terminate and Stay Resident (TSR) program or device driver.

RAMDRIVE.SYS - device driver that supports RAM disks in conventional, Extended and Expanded memory.



Memory Areas in the TravelMate 2000

SMARTDRV.SYS - device driver for use with a hard disk and Extended or Expanded memory that supports disk-caching to speed up reading from the hard disk.

Installing Device Drivers

To install a driver, add a DEVICE command line to your CONFIG.SYS file using MS-DOS EDLIN or a word processor which saves ASCII text files.

```
DEVICE = C:\DOS\XXXXXXXX.SYS [options]
```

You must then restart the computer to load the new CONFIG.SYS settings and activate the driver.

EMM4J.SYS

The EMM4J.SYS device driver must be installed before you can use Expanded Memory. To install EMM4J.SYS in its simplest form, include the following command line in your CONFIG.SYS file before any other DEVICE commands that use Expanded memory (e.g. RAMDRIVE.SYS):

```
DEVICE=C:\DOS\EMM4J.SYS
```

In this form, the Expanded memory manager will use default values-64K byte of page frame (D0000H to DFFFFH) available for application programs and 32K byte of page frame (C8000H to CFFFFH) occupied by the EMM4J.SYS device driver. Ms is sufficient for the vast majority of applications unless your software specifically instructs you otherwise. Refer to your application software manual for details.

Memory Areas in the TravelMate 2000

If you need to specify special conditions for Expanded memory, use the command in the following form:

```
DEVICE=C:\DOS\EMM4J.SYS [W=xx,xx,xx,xx.... ][/NL][/I][/O]
```

where:

- `/W=xx,xx,xx,xx..` □ specifies the upper two digits of the address of a 16 K byte physical page used for the page frame: possible settings are: C8, CC, D0, D4, D8, DC, E0, E4, E8, and EC. Specify the addresses so that the page frame will have at least four continuous physical pages (64 K byte). If you have installed an I/O card in the expansion slot, be sure to specify addresses the I/O card does not use.
- `/NL` specifies not to initialize logical pages in Expanded memory when the computer restarts; this switch is useful for running some application programs which require frequent page allocation.
- `/I` displays information on EMM4J.SYS every time the power is turned on.
- `/O` enables the use of the memory area between 256 K byte and 640 K byte as a page frame of Expanded memory; this switch is useful for running some application programs which support the EMS page frame in this area.



Note: In certain applications, the system restart (the **Ctrl-Alt-Del** keys) may not function properly when using Expanded memory. If this happens, turn off the computer, wait for 5 seconds, and turn on the computer again.



Memory Areas in the TravelMate 2000

HIMEM.SYS

HIMEM.SYS is an eXtended Memory Manager (XMM) conforming to eXtended Memory Specifications (XMS), version 2.0,

HIMEM.SYS uses 64 K byte of the high-memory area (HMA) at the beginning of Extended memory to store a single TSR program or device driver, or it uses this area for data storage. This effectively increases the size of conventional memory for use by your main application program. In order to use HMA, you must have at least 64 K byte of Extended memory.

To install HIMEM.SYS in its simplest form, include the following command line in your CONFIG.SYS file before any other device commands that use Extended memory:

```
DEVICE=C:\DOS\HIMEM.SYS
```

In this form HIMEM.SYS will use default values, and access to HMA will be on a "first come-first served" basis. The first device driver or TSR under 64 K byte which supports HMA will go into HMA. Other device drivers will go into conventional memory.

Memory Areas in the TravelMate 2000

If you need to specify special conditions for the use of the high-memory area, use the command in the following form:

```
DEVICE=C:\DOS\HIMEM.SYS [/HMAMIN=h][/NUMHANDLES=n]
```

where:

`/HMAMIN=h`

`h` is the minimum amount of memory required by a TSR program or device driver to be loaded into HMA; specify the amount of memory in kilobytes. Programs requiring less space will not be placed in the HMA. The minimum value is 0, the maximum is 63 K byte, and the default is 0. A zero default value allows "first come-first served" access to the HMA. Use this option when you run two or more TSR programs and/or device drivers that require use of the HMA.

`/NUMHANDLES=n`

`n` is the maximum number of EMB (Extended Memory Block) handles; the possible range is 1 to 128, and the default is 32. Each additional handle requires an additional six bytes of conventional memory. Use this option only when applications specifically require it.



Memory Areas in the TravelMate 2000

RAMDRIVE.SYS

A RAM disk is a portion of your computer's memory configured to simulate a disk drive. Such a disk can be called a "virtual disk" and can be accessed much faster than a normal disk drive. The contents of a RAM disk disappear when power is turned off, so some action must be taken to copy the contents of the RAM disk to a floppy disk or the hard disk before turning off the power. You can do this using the COPY command to copy all files from the RAM disk, or you can set up a batch file to do it automatically. Unlike a normal disk, a RAM disk does not need formatting before use.

To set up a RAM disk, include the following line in your CONFIG.SYS file:

```
DEVICE=C:\DOS\RAMDRIVE.SYS [size]
```

Specify the size in kilobytes. The minimum size is 16 K byte, and the default value is 64 K byte.

There are several other options which can be used when setting up a RAM disk. Refer to your *MS-DOS User's Manual* for a full description.

The RAM disk is given the drive letter that follows the last drive letter being used by your system.

- If your hard disk is configured as Drive C the RAM disk is Drive D.
- If your ROM disk is Drive C and your hard disk drive is Drive D, then the RAM disk is Drive E.

SMARTDRV.SYS

SMARTDRV.SYS is a disk-caching program used to reduce the time it takes your computer to read data from the hard disk.

When **SMARTDRV.SYS** is installed, information from the hard disk is temporarily stored in a cache in Extended or Expanded memory. When needed, the data can be accessed by the processor directly from the cache memory. The data on the hard disk is updated automatically to reflect the changes in the data stored in the cache. **SMARTDRV.SYS** works best when set up in Expanded memory, but also performs well in Extended memory.

To install **SMARTDRV.SYS** in its simplest form, include the following command line in your **CONFIG.SYS** file:

```
DEVICE=C:\DOS\SMARTDRV.SYS
```

In this form, a 256 K byte cache will be set up in Extended memory.

If you need to specify a particular size for the cache, or if you want the cache to be in Expanded memory, refer to your *MS-DOS User's Manual* for a full description of available options.

Connector Pin Assignments

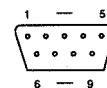

RS-232C Connector

Pin No.	Signal Name	Abbreviation	Direction
1	Carrier detect	CD	Input
2	Receive data	RD	Input
3	Transmit data	TD	Output
4	Data terminal ready	DTR	Output
5	Signal ground	SG	
6	Data set ready	DSR	Input
7	Request to send	RTS	Output
8	Clear to send	CTS	Input
9	Ring indicator	RI	Input

Parallel Connector

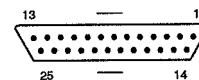

(with the supplied conversion adaptor attached)

Pin No.	Signal Name	Abbreviation	Direction
1	Strobe	STROBE-	Output
2	Data 0	DATA0	Output
3	Data 1	DATA1	Output
4	Data 2	DATA2	Output
5	Data 3	DATA3	Output
6	Data 4	DATA4	Output
7	Data 5	DATA5	Output
8	Data 6	DATA6	Output
9	Data 7	DATA7	Output
10	Acknowledge	ACK-	Input
11	Busy	BUSY	Input
12	Paper empty	PE	Input
13	Select	SLCT	Input
14	Auto feed	AUTO FEED-	Output
15	Printer error	PERROR-	Input
16	Initialize printer	INIT-	Output
17	Select input	SLCT IN-	Output
18-25	Ground	GND	



Connector Pin Assignments

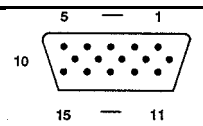

CRT Connector (option)

Pin No.	Signal Name	Direction
1	Red	Output
2	Green	Output
3	Blue	Output
4	Not used	
5	Ground	
6	Red Rtn	
7	Green Rtn	
8	Blue Rtn	
9	Not used	
10	Ground	
11	Not used	
12	Not used	
13	Horizontal synch	Output
14	Vertical synch	Output
15	Not Used	

The following is an overview of the screen standards supported by the TravelMate 2000 internal display adaptor.

MDA (Monochrome Display Adaptor)

The MDA standard supports a 720-by-350 monochrome text display using a 9-by- 14 pixel character box.

The TravelMate 2000 LCD screen supports MDA by displaying an 80-column by 25-line monochrome text display in two modes:

	Standard	Expanded
Character box:	8 x 16	8 x 16
Display area:	640 x 400	640 x 480

CGA (Color Graphics Adaptor)

The CGA standard supports 640-by-200 pixel two-color graphics or 320-by-200 pixel four-color graphics and uses an 8-by-8 pixel character box in text mode.

The TravelMate 2000 LCD screen supports CGA by displaying text in an 80-column by 25-line text display with 16 shades of gray in two modes:

	Standard	Expanded
Character box:	8 x 16	8x 16
Display area:	640 x 400	640 x 480



Screen Standards

Color graphics are supported by displaying color in two resolutions, each with standard and expanded modes:

Resolution : 320 by 200 pixels with four shades of gray

Standard

One pixel is converted to a 2 x 2 cell
Display area: 640 x 400

Expanded

Every fifth line is displayed twice
One pixel is converted to a 2 x 2 or 2 x 4 cell (every fifth line)
Display area: 640 x 480

Resolution: 640 by 200 pixel of gray Standard

Standard

One pixel is converted to a 1 x 2 cell
Display area: 640 x 400

Expanded

Every fifth line is displayed twice
One pixel is converted to a 1 x 2 or 1 x 4 cell (every fifth line)
Display area: 640 x 480

EGA (Enhanced Graphics Adaptor)

The EGA standard supports 640-by-350 pixel monochrome or 16-color graphics, 640-by-200 pixel and 320-by-200 pixel 16-color graphics, and uses an 8-by-14 pixel character box for text displays.

The TravelMate 2000 LCD screen supports EGA by displaying text in an 80-column by 25-line text display with 16 shades of gray in two modes:

	Standard	Expanded
Character box:	8x 16	8x 16
Display area:	640 x 400	640 x 480

Color graphics are supported in three resolutions, each with standard and expanded modes:

Resolution: 320 by 200 in 16 shades of gray

Standard

One pixel is converted to a 2 x 2 cell

Display area: 640 x 400

Expanded

Every fifth line is displayed twice

One pixel is converted to a 2 x 2 or 2 x 4 cell (every fifth line)

Display area: 640 x 480

Resolution: 640 by 200 in 16 shades of gray

Standard

One pixel is converted to a 1 x 2 cell

Display area: 640 x 400

Expanded

Every fifth line is displayed twice

One pixel is converted to a 1 x 2 or 1 x 4 cell (every fifth line)

Display area: 640 x 480

Resolution: 640 by 350 pixels with 16 shades of gray or monochrome

Standard

One pixel is displayed as a 1 x 1 cell

Display area: 640 x 350

Expanded

Every third line is displayed twice

Display area: 640 x 466



Screen Standards

VGA (Video Graphics Array)

The VGA standard supports 640-by-480 pixel monochrome or 16-color graphics and 320-by-200 pixel 256-color graphics, and uses an 8-by-16 pixel character box for text display.

The TravelMate 2000 LCD screen supports VGA by displaying text in an 80-column, by 25-line text display with 16 shades of gray in two modes:

	Standard	Expanded
Character box:	8 x 16	8 x 16
Display area:	640 x 400	640 x 480

Color graphics are supported by displaying colors as 16 shades of gray in three modes:

Resolution: 320 by 200 pixels with 16 shades of gray

Standard

One pixel is converted to a 2 x 2 cell
Display area: 640 x 400

Expanded

Every fifth line is displayed twice
One pixel is converted to a 2 x 2 or 2 x 4 cell (every fifth line)
Display area: 640 x 480

Resolution 640 by 480 with two or 16 shades of gray

Standard

One pixel is a 1 x 1 cell
Display area: 640 x 480

Screen Standards

HGC (Hercules Graphics Card)

The HGC standard supports a high-resolution 720-by-348 pixel monochrome text or graphics display. The text display for HGC mode is the same as for MDA mode. The TravelMate 2000 LCD screen does not support HGC graphics mode. To display HGC graphics, connect a multi-frequency monitor to the CRT connector on the optional CRT adaptor.

The MS-DOS files COMMAND.COM, IO.SYS, and MSDOS.SYS are necessary for the operation of your computer. If any of these files are accidentally deleted or modified, your computer will not function. This appendix describes the procedure for restoring these files without affecting the applications and data files that may be on your hard disk.



Note: IO.SYS and MSDOS.SYS are hidden files. You will not see these files if you view a directory of C:\.

If COMMAND.COM is missing

If COMMAND.COM is missing from your hard disk, the screen displays this message during the boot process

Bad or missing command interpreter

then the computer becomes dormant. Follow the steps outlined below to restore COMMAND.COM to your hard disk.

If IO.SYS or MSDOS.SYS are Missing

If your computer is missing IO.SYS and/or MSDOS.SYS, the screen displays the following message during the boot process

Non system disk or disk error Replace and press any key when ready

This message is repeated when any key is pressed. Follow the steps outlined below to restore IO.SYS or MSDOS.SYS to your hard disk.

Procedure for Restoring MS-DOS System Files

Follow these steps to restore COMMAND.COM, IO.SYS, and MSDOS.SYS.



Restoring MS-DOS System Files

1. Press the **Ctrl-Alt-SetUp** keys to access the Set Up screen, then press the **Ctrl-Alt-SetUp** keys again to access the Hardware Installation screen.
2. Press the **↓** key until the Drive C:/Drive D: field is highlighted, then press the **Spacebar** to toggle Drive C: to ROM Disk, and Drive D: to Internal HDD.
3. Press the **SetUp** key, followed by the **Enter** key, to update the Hardware Installation and reboot the computer. The screen displays the ROM Disk Installation screen with Installation Selection highlighted.
4. Press the **Enter** key. The following screen appears:

```

                                     Welcome

Welcome to DOS 4.0 and the SELECT program.
SELECT will install DOS 4.0 on your fixed disk.

Press Enter (↵) to continue or ESC to Cancel

Enter Esc=Cancel
```

5. Press the **Enter** key. The following screen appears:

```

                                     Introduction

As you view the SELECT displays, you will be asked to make
a choice or type an entry. If you are uncertain about what
to choose or type, you can accept the predefined choice or
press the F1 help key for more information about an item.

You will be using these keys in the SELECT program:

Enter           To proceed to the next step.
Esc             To cancel the current display.
Up/Down Arrow  To move the highlight bar to the
               next item.
F1             To view the help information.
F3             To exit SELECT.

You can press the Enter, Esc and F1 keys when they appear
on the display.
Enter Esc=Cancel
```

6. Press the **Enter** key. The following screen appears:

```
Specify Function and Workspace

SELECT sets up your computer to run DOS and your
programs most efficiently based on the option you
choose.

Note: You can review the results of your choice
later in this program.

Choose an option:

1. Minimum DOS function; maximum program workspace
2. Balance DOS function with program workspace
3. Maximum DOS function; minimum program workspace

Enter Esc=Cancel      F1=Help
```

Use the **↑** or **↓** keys to select option 1, 2, or 3 and press the **Enter** key.



Caution: If you select option 3, some application software may not run properly because of insufficient workspace.

7. **The following screen appears:**

```
Select Country and Keyboard

Predefined country . . . . . : United States (001)
Predefined keyboard . . . . . : None

Choose an option:

1. Accept predefined country and keyboard
2. Specify a different country and keyboard

Enter Esc=Cancel      F1=Help
```



Restoring MS-DOS System Files

This screen lets you select the appropriate country and keyboard settings for your computer. You can assign the monetary symbol, decimal separator, date and time format, and keyboard layout for the country of your choice. Choosing option 2 from this screen displays a menu of all available countries, followed by keyboards. If you select Denmark, Portugal, Norway, or French-speaking Canada, you must set the Code-Page Switching Option to Y (Yes) during the Installation Option Review.

8. Select the appropriate country and keyboard, then press the **Enter** key.

The following screen appears:

```
Accept DOS Location and Update DOS Files

You must accept the DOS directory name shown.

DOS Directory . . . .C:\DOS

To select option 1 below, press Enter. To change
your option, highlight your choice and then press
Enter.

1. Install all DOS files on fixed disk
2. Copy only non-system files to directory specified

Enter Esc=Cancel      F1=Help
```

This screen asks how much of DOS is to be installed. The bar cursor highlights option 1, which is to install both the system files (COMMAND.COM, IO.SYS, and MSDOS.SYS) and the non-system files (MS-DOS).

9. Press the **Enter** key. The following screen appears:

```
MS-DOS Shell Option

SELECT can install the MS-DOS Shell on the system
being set up. Indicate whether you want to do this.

Choose an option:

1. Install the MS-DOS Shell
2. Do not install the MS-DOS Shell

Enter Esc=Cancel      F1=Help
```

The bar cursor highlights option 2, which is to not install the MS-DOS Shell.

The MS-DOS Shell is a program that assists you in using your system, much in the same way Laptop Manager assists you.

10. Press the **Enter** key. The following screen appears:

```
Review Selections

SELECT defined a configuration based on the options
you chose for DOS function and program workspace.

Choose an option:

1. Accept configuration and continue with
   installation
2. Review installation choices

Enter Esc=Cancel      F1=Help
```

The bar cursor highlights option 1, which is to accept configuration and continue with installation.



Restoring MS-DOS System Files

11. Press the **Enter** key. The screen displays the following
Transferring system
followed by
Copying files
When the files are completely copied, the screen displays the following message
Installation of MS-DOS 4.0 is complete.
12. Press the **Ctrl-Alt-Del** keys to reboot the system and load the system files onto the hard disk from ROM.
13. When you reinstall MS-DOS on the hard disk, the existing AUTOEXEC.BAT and CONFIG.SYS files are renamed AUTOEXEC.BAK and CONFIG.BAK. A new set of AuToExEc.BAT and CONFIG.SYS files, with factory-set commands, are copied onto the hard disk.



Note: If you installed the MS-DOS Shell, the screen will display the shell when you turn on the computer. To exit to the MS-DOS prompt, press the **Enter** key at the command prompt. To change to the root directory, type **CD**.

It is very important that you replace the new AUTOEXEC.BAT and CONFIG.SYS files with the backups that contain the proper commands. To do this, follow these steps:

- a. At the **C:** prompt, type
copy \AUTOEXEC. BAK \AUTOEXEC. BAT
to replace the new AUTOEXEC.BAT with **AUTOEXEC.BAK**.
- b. At the **C:** prompt, type
copy \config.bak \config.sys
to replace the new CONFIG.SYS with **CONFIG.BAK**.

The TravelMate 2000 Notebook Computer and its Texas Instruments options are warranted for 12 months from the purchase date.

Standard Warranty

Texas Instruments offers a 1-day turnaround for domestic units carried in to local Customer Service Centers and a 5-day turnaround from receipt time at the National Service Center for units sent to one of the National Service Centers (Cypress, Texas, U.S.A. for domestic units; Toronto, Canada for Canadian units; or Plymouth, U.K. for international units) for repair.

The warranty does not include the following:

- Installation or removal of the computer's options
- User's required preventive maintenance
- Routine operational difficulties, such as software problems

For more information about upgrading your warranty, maintenance contract, or customer center location, please call your distributor or Texas Instruments at 1-800-847-5757.

If you must return your computer or an option for service, please complete the steps on the following checklist to speed processing of your order and lessen your inconvenience.



Warranty and Service

- Complete a separate Repair Request form (on the back of this page) for each computer or option you are returning and include the completed form or forms with your shipment. Make photocopies of the form if necessary.
- If you are returning the entire computer and all options, please use the original shipping container, if possible, or be certain your computer is carefully packed as a delicate electronic instrument.



Note: Damage caused in shipment because of inadequate packing is not covered by the warranty or maintenance contract.

- If your computer or option is still within warranty, attach a copy of your proof of purchase to the completed Repair Request form. If this repair is covered by a maintenance agreement, enter the agreement number of the maintenance contract on the form. Otherwise, attach a purchase order number to authorize payment for repairs.
- Return the computer and/or options to one of the following:

In the U.S.A.



Texas Instruments Incorporated
24500 Highway 290
Cypress, TX 77429
Telephone 1-800-522-4535
Attn: TI-CURE SVC

In Canada



Texas Instruments Canada Limited
70 Newkirk Road North
Richmond Hill, Ontario L4C 3G3
Telephone 416-884-9181
Attn: ITG Customer Service

Your name and address

Your Name _____
Company Name _____
Address _____
City State Zip Code _____
Phone number (_____) _____ Ext. _____
Product serial number _____

Unit(s) you are returning (check where applicable)

- TravelMate 2000
- 3.5 inch Floppy Drive Unit
- Expansion Unit
- 1 MB RAM Card
- Numeric Keypad
- Add-on Battery Pack
- 80C287 12 Mhz Coprocessor
- 2400-bps Internal Modem
- AC Adaptor
- Internal Battery
- CRT Adaptor

Type of Claim

- Warranty Claim (attach proof of purchase)
- Maintenance contract (Agreement No. _____)
- My purchase order number _____
- My check is enclosed
- Charge to my credit card. MC VISA AMEX

LLLLLLLLLLLLLLLLLLLLLLLL LLL
Card Number Exp. Date

Description of Problem (attach extra sheet if necessary)

This glossary explains many of the terms found in this manual as well as other computer -related terms you may encounter.

access -The ability to obtain data from or place data into internal memory, or a floppy or the hard disk.

access shutter - A metal door on a floppy diskette that slides open to allow the computer to save or retrieve data.

adaptor - A device that connects an option to the computer.

application program - Program that instructs the operating system to perform specific tasks by using either predesigned programs, such as a word-processing program, or programming languages such as BASIC, that allow you to design your own programs.

archiving - The process of storing back-up copies of data files in a specific location.

ASCII - An acronym for the American Standard Code for Information Interchange; an agreed-upon standard for the assignment of numeric values to letters, digits, punctuation marks, and control codes. The system processes only numbers even though characters, letters, and graphic symbols appear on the screen. The ASCII list is a set of numeric values for the most frequently used characters. The system converts these numeric values to their binary equivalents.

asynchronous communications software - Software that primarily is used to communicate with a subscription information service, send or receive electronic mail, or process using a remote system.

backlight - A feature that allows you to control background brightness for better readability.

Glossary

backing up - Duplicating a program or file onto a separate storage medium so that a copy will be preserved against possible loss or damage to the original.

backup - A duplicate copy of information or programs; usually stored on a diskette and kept in a separate location in case the original is lost or damaged.

BASIC - An acronym for Beginner's AR-purpose Symbolic Code; a programming language widely used because many of its commands resemble everyday language.

battery - A self-contained cell that provides power to your computer.

battery pack - An optional power source that can be affixed to your computer to provide additional power.

baud - A signal element change per second. If a signal element change has only one bit, baud equals bits per second.

binary - A system of numbering that uses patterns of only zero's and one's. Each item of information, whether a letter, graphic symbol, or an instruction, is converted to a binary number before it is processed by your computer.

BIOS - An acronym for Basic Input-Output System; instructions stored in read-only memory (ROM) at the factory that check hardware components and load the computer operating system (MS-DOS, for example) into the computer when you boot it.

bit - A binary digit (0 or 1); the smallest unit of information used by your system.

bits per second - The speed at which your system receives or sends data to a device such as a modem or serial printer.

boot - To start your system; also called *start-up* and *power up*.

bps - See *bits per second*.

brightness control - A control that allows you to adjust the brightness of the display.

buffer - A portion of the system's memory that temporarily holds information used by a program; for example, the portion of a document you are working on while using a word processor.

bug - An error in the hardware or software of your system that causes an operation to perform incorrectly.

byte - A grouping of eight binary digits (bits) that your system treats as one unit; usually represents one character.

cache - a software device that accumulates copies of recently used disk sectors in RAM. The application program can then read these copies without accessing the disk, thereby speeding up the performance of the application.

central processing unit (CPU) - The electronic circuits in your system where most processing of information takes place.

character - One of a set of symbols, such as letters, numerals, or punctuation marks, that can express information when collectively arranged. Although these symbols are intelligible to humans, they are not understood by your system. For this reason, standardized character codes consisting of groups of binary digits have been developed to allow characters to be processed by computers. In most cases, a character is represented by 8 bits or 1 byte.

character set - A list of codes, such as ASCII, that assigns a special standardized group of binary digits to each character.

clock - A timing device that coordinates all internal events in your system.

Glossary

CMOS - An acronym for Complementary Metal Oxide Semiconductor; a large-scale integration technology that requires low power consumption and is therefore used for battery-assisted memory systems.

command - The portion of a computer instruction that specifies what operation is to be performed.

communications - The electronic transfer of information between computers or between a terminal and a computer. An example is sending a data file to another computer by using telephone lines and a modem.

compiler - A program that translates a language, such as BASIC, into a language your system can understand. A compiler translates the entire program just once.

computer - A combination of a central processing unit (CPU) and memory designed to process information. Although a combination of the central processing unit and memory is defined as a computer, an input device (such as a keyboard) and an output device (such as a display unit) are required to make the system useful.

configure - To adapt software so that it sends the correct control codes to external devices, such as printers. Also called *setup*.

connector - A coupling device that allows you to install a hardware option onto your computer.

contrast control - A control that allows you to adjust how well data shows up against the background of the LCD screen.

control code - A code that initiates some kind of physical control action that is not printed (such as line feed and tab), turns off an external device, or, in combination with other characters, defines unique commands (for example, pressing the **Ctrl** and **C** keys might tell the system to abort a program); a numeric value that instructs the system or an external device to perform a specific instruction.

controller - Electronic circuitry that allows communication between the system unit and an external device.

conventional memory - Also called *main memory* and *RAM*; internal RAM up to 640 Kb, accessed by MS-DOS directly.

coprocessor - An auxiliary processing unit designed to speed up the processing of certain types of information.

CPU - See *central processing unit*.

CRT - Abbreviation for cathode ray tube, a common term for a television-like computer monitor.

CRT Adaptor - A hardware option that allows you to use a CRT with your computer.

cursor - A special graphic character on the screen (usually a block or underline shape, sometimes blinking) that indicates the next position at which a character will be entered or deleted from the keyboard.

data - Information that is input to your system and is then processed by mathematical and logical operations so that, ultimately, it can be output in a sensible form. It usually consists of numerals, letters, or symbols that describe an object, idea, condition, relationship, or other information.

data base - A collection of related information; usually a large number of data files stored in one or more storage medium.

Glossary

data file - A grouping of information with common descriptive attributes. For example, a customer data file might consist of basic customer information. Each file might represent one customer.

data processing - The input, storage, manipulation, and dissemination of information using sequences of mathematical and logical operations.

default value - A value that your system assumes as a response to a prompt, unless instructed otherwise.

device driver - Small programs used to control external devices or to run other programs. A device driver directs production, manipulation, and presentation of appropriate signals by the system so that the external device can perform as required.

diagnostics programs - Programs that test the components of your system to verify proper operation or to diagnose problems.

directory - The list of all files, which is itself a file, on your system storage medium for easy reference.

disk controller - A device that controls how information is transferred between the system unit and the hard disk or diskette drives.

DIP switches - A pair of switches in your computer that allow you to control certain operating features, such as beeps, parity settings, etc.

diskette - See *floppy diskette*.

diskette drive - A device that rotates a diskette and accesses its data by means of a read-write head.

DOS - Disk operating system

double density - A technique used to increase bit density on a magnetic storage medium to twice the amount of single density so that more information can be stored in the same amount of space.

double-sided diskette - A magnetic medium capable of storing information on both its surfaces.

drives - Devices that rotate magnetic media and access data by means of a read-write head.

dust cap - A plastic cover that protects connectors on your computer from dirt.

expanded memory - Memory that utilizes an area of the system memory as a window, through which pages of data are "passed."

expansion bus connector - A coupling device that allows you to connect the optional Expansion Unit or the optional 3.5-inch Floppy Drive Unit to your computer.

expansion card - A card you can install in the expansion slot of your computer that adds capabilities to the computer such as additional memory.

Expansion Unit - A hardware option that increases the capabilities of your computer.

extended memory - Internal RAM above 1,024 Kb.

external commands - The utility programs of an operating system (for example, MS-DOS) that enable you to perform occasional operations such as copying an entire floppy or partitioning a hard disk drive.

external devices - Devices, usually for input and output, connected to your system to increase its capability and usefulness. Examples include printers and modems.

external monitor - A hardware option you can connect to your computer via a connector.

Glossary

file - A group of organized data assembled for one particular purpose, considered as one unit, and stored in permanent off line storage, such as a drive or tape.

filename - A name that distinguishes one file from another; may consist of alphabetical characters, numeric characters, or a combination of both.

firmware - Software that is built into the hardware of a system and controls the functions of the hardware.

fixed disk drive - Same as *hard disk drive*.

floppy diskette - A flexible, flat, circular medium that magnetically records and provides access to stored data. It is divided into concentric circular tracks and wedge-shaped sectors. The diskette is sealed in a protective square envelope that is lined with a soft material that cleans as the diskette rotates. The cover has several openings and notches to accommodate the drive.

floppy drive - A device that rotates a floppy diskette to allow storage or retrieval of data by using read-write heads.

formatting - Preparation of various types of magnetic media to accept data. For example, before you can use diskettes, track and sector information must be set for the controller. After the diskette is formatted, it can be used for normal input-output and retrieval operations.

function keys - Keys that perform editing functions in MSDOS (see your *MS-DOS User's Manual*) and have application-defined functions at other times. Refer to your *Battery PRO™* and *Productivity Software User's Manual* for functions assigned to these keys.

graphics - Visual patterns displayed on the screen or produced on a printer; usually formed by patterns of dots.

hard disk drive - A combination of a drive mechanism and permanently sealed storage medium; capable of storing large amounts of information.

hardware - The physical components of a system: central processing unit, internal memory, drives, printer, display unit, option boards, external devices, etc. Contrast with *software*.

hardware options - Any of several devices that can make your computer more efficient and powerful for your applications.

head - A small electromagnetic device that reads, records, and erases data on a magnetic storage medium, such as a drive or tape cartridge. Also called a read-write head.

hexadecimal - A numbering system that consists of 16 symbols, 0 to 9 and A to F; used by programmers as a convenient method of expressing binary values.

input - Information that enters the system.

input/output - An operation that transfers information from the central processing unit to a device or from a device to the central processing unit. An example is storing and retrieving information with a diskette.

integrated circuit - A microscopic grouping of electronic components and their connections mounted on a small chip of material, usually silicon.

internal commands - The core program of the operating system (for example, MS-DOS) that consists of commands necessary for day-to-day operations, such as copying files.

internal memory - A temporary storage area for information (programs and data) in binary form.

internal modem - An option you can install inside your computer that allows the use of telephone lines for communication between computers.

Glossary

K byte- An abbreviation for 1,024 bytes, used to designate the memory capacity of a computer or the storage capacity of a storage device.

keyboard - A device, similar to a typewriter keyboard, that allows you to communicate with your computer.

kilo - A prefix that, in reference to computer memory devices, usually equals 1,024.

kilobyte - 1,024 bytes.

LCD - See *liquid crystal display*.

liquid crystal display (LCD)- A display made of material, the reflectance or transmittance of which changes when an electric field is applied.

load - To copy information from a storage device, such as a diskette or a hard disk drive, into internal memory of the system. Also called *download*.

loop - A series of instructions or one instruction in a program that is repeated a prescribed number of times, followed by a branch instruction that exits the program from the loop.

main directory -The primary directory of a diskette or a hard disk drive. Also called a *root directory*.

math coprocessor - An auxiliary processing unit used to speed up the processing of mathematical calculations.

M byte - An abbreviation for megabyte; used to designate the memory capacity of a computer or the storage capacity of a storage device.

mega - Prefix meaning one million.

megabyte - 1,024 kilobytes.

microprocessor - A central processing unit assembled on a single silicon integrated-circuit chip.

modem - A device that allows the use of telephone lines for communication between computers.

mouse - A device, manipulated by hand, that moves the cursor in the same direction as the movement created when the mouse is moved on a flat surface.

mouse device driver - Enables an operating system to interpret signals coming from the mouse.

multitasking - The concurrent execution of two or more programs.

multiuser system - A system in which the computer and other external devices are shared in any one of several arrangements by several people.

operating system - A set of programs that control the operation of the computer. Typically, the operating system regulates space allocation, keeps track of files, saves and retrieves files, and manages other control functions associated with data storage.

partitioning - Dividing a hard disk drive into work areas, usually approximately 20 Mb in size, to accommodate the working capacity of the operating system.

path, pathname - A sequence of directory names, ending usually in a filename, all separated by backslashes (\), to tell your computer where to find particular subdirectories and files.

plotter - A device for producing a hard copy of graphic images by controlling pens or other drawing media.

port - An input-output connection between external devices and the computer. The port has both male and female connectors that contain a specific number of pins.

processing - The calculating, sorting, storing, and retrieving of information.

Glossary

program - A list of instructions that tells your system how to perform a specific task.

program file - A program stored on a storage medium, such as a floppy or hard disk drive.

programming language - A set of words, abbreviations, or symbols that are converted into the binary numbers that represent instructions to the system. Programming languages enable programmers to write instructions using words or symbols and avoid the time-consuming task of entering the long string of 0s and 1s that represent the numeric language of the system. A programmer can use any one of several different programming languages designed for his or her system. Some programming languages have more than one version (for example, MS-BASIC and GW-BASIC).

RAM - See *random access memory*.

RAM cards - Devices which provide additional RAM storage for your computer.

random-access memory (RAM) - A type of internal memory used for the temporary storage of information. The contents of random-access memory can be altered, allowing information stored there to be processed. Unlike read-only memory, information in RAM is lost when power is turned off. For this reason, information in RAM must be saved on a storage device before the system is turned off.

read - To access information from a storage device.

read-only memory - A type of internal memory that contains permanent instructions for your system. The contents of read-only memory cannot be altered. For this reason, essential instructions are permanently stored in ROM. These instructions, such as those that execute the self-test, are not lost when the system is turned off.

resolution - The contrast between the display and the background on an LCD screen.

ROM - See *read-only memory*.

security hook holder - A locking device to help prevent theft of your computer.

self-test - An automatic check the system performs every time it is turned on.

serial transmission - A printer that ... need better definition, move alphabetically.

slide switch - A switch that you manipulate side to side.

software - Computer programs, usually supplied on floppies or on ROM.

state of charge - An indication of the level of charge of the computer's internal battery.

storage medium - Material coated with a magnetic substance that is used for the permanent storage of information.

system board - An internal circuit board that holds the integrated circuits for the microprocessor, memory, and clock in your computer.

tape backup - A device that stores information on a tape cartridge; primarily used to back up information from a hard disk drive.

turbo operation - A feature of a computer that increases its data processing speed by 20 to 30 percent.

typamatic - A feature that generates a character as long as an alphanumeric key is pressed.

Glossary

working copy - A copy of a floppy that is used in day-today operations while the original is kept in storage. This term also can mean a floppy that has both an operating system and an application program on it.

working directory - the default directory used by an application program when it first is loaded onto the hard disk.

write - To record information on a storage device.

write-protect tab - A switch on a floppy diskette that prevents recording data over existing data on the diskette.

80C287 12Mhz coprocessor..... 1-7, 6-20

a
ac adaptor..... 2-10, 3-7
ac adaptor Jack..... 2-10
adaptors
 display 4-21
 internal display 4-15
add-on battery pack..... 1-7, 6-2,
 connector..... 2-9
all-characters print check E-6
Alt key 2-15
Alt Gr (alternate graphics) key 2-15
application programs..... 1-10
 guidelines for installing 5-3
arrow keys..... 2-16
assigning
 Drive A..... 4-22
 Drive C 4-22
 Drive D..... 4-22
attribute check E-5
AUTOEXEC.BAT Me 5-7
 default 5-7

b
backing up the hard disk 4-26
backlight..... 2-4
backspace key 2-15
backtab 2-15
backup 1-12
battery 3-3
 caring for..... B-5
 conserving power..... B-4
BatteryPro utility 4-10
baud rate..... 4-13
binary code..... 1-4
binary digits H-1
BIOS 1-5, 1-10
BIOS calls..... 1-1
BIOS messages..... G-1
bits 1-4, H-1
 data 4-13
 stop 4-13

boot
 quick 4-12
 warm 4-25
bottom panel 2-11
boundary address 4-23
Break key 2-17
break signal..... 2-17
brightness control..... 2-5
BUS speed 4-12
byte 1-4, H-1

c
cache..... H-11
cache memory H-11
Caps Lock key..... 2-14, 2-20, 4-10
Caps Lock indicator..... 2-20
caring for
 battery B-5
 battery power B-4
 cleaning B-3
 computer B-1
CGA..... 4-21, J-1
changing the LCD color palette 4-17
character set check..... E-5
character sets C-1
 Canadian-French C-5
 default 5-7
 multilingual C-3
 Nordic C-6
 Portuguese..... C-4
 United States C-2
Charge indicator 2-19
charging the internal battery 3-7
cleaning
 case B-3
 computer B-3
 screen..... B-3
clock, customizing system..... 4-9
color palette..... 4-17
communication ports 5-6
CONFIG.SYS file..... 5-7
 default 5-8
configuration, system 4-12

Index

- configuring memory 4-23, H-1
- configuring the hardware 4-19
- connector pin assignments 1-1
- connectors 1-6
 - connector pin assignments 1-1
 - CRT I-2
 - parallel I-1
 - RS-232C 1-1
- conserving battery power B-4
- contrast control 2-5
- Ctrl (control) key 2-15
- conventional memory H-3, A-5, A-8
- CPU specifications A-1
- CPU speeds 4-12, A-1
- CRT 2-8
 - Adaptor 1-4, 1-7, 2-3, 2-8
 - adaptor specifications A-4
 - connector I-2
- cursor, setting 4-9
- cursor control keys 2-16
- customizing your system 4-6
 - clock 4-9
 - display 4-9
- cylinders, disk 1-11

- d**
- DAC check E-4
- data 1-4
- data bits 4-13
- date, setting 4-9
- default
 - AUTOEXEC file 5-7
 - CONFIG.SYS Me 5-9
 - setting 2-18
 - values 2-18
- Del(ete) key 2-17
- device drivers
 - EMM4J.SYS H-6
 - HIMEM.SYS H-8
 - installing H-6
 - LapLink 5-11
- DIAG command 4-18
- diagnostic program 4-18, E-2
 - starting E-3
- diagnostics 1-5, E-1
 - memory E-4
 - power-on E-1
 - real-time clock E-3
 - self-test E-1
- dimensions A-1
- DIP switches 3-9
- disabled memory 4-24
- display 1-6, 5-5
 - adaptor 4-21
 - customizing your system 4-9
 - hardware installation
 - configuration 4-21
 - internal adaptor 4-15
 - modes 2-3, 4-21
 - setting 4-16
 - specifications A-1
 - timeout function 4-11
- drive A 4-22
- drive assignment 4-22
- Drive C 4-22
- Drive D 4-22
- drivers, expanded memory H-5
- drives specifications A-2
- dust cap
 - Add-On Battery Pack connector 2-9
 - expansion bus connector 2-9
 - Numeric Keypad connector 2-6
 - parallel port 2-7

- e**
- EGA 4-21, J-2
- EMM4J.SYS device driver H-5
- EMS I/O port 4-22
- Enter key 2-14
- Esc(ape) key 2-16
- expanded memory 4-23, H-3
- Expanded Memory Manager A-5
- expanded memory specifications A-4
- expansion bus connector 1-6, 2-9
- extended memory 4-23, H-3, H-8
 - check E-4
 - manager H-8
- external battery pack
 - specifications A-3
- external modem 1-7, 2-8, 6-19
- external monitor 2-3, 4-15

f

files

- AUTOEXEC.BAT 5-7
- CONFIG.SYS 5-7

firmware 1-5

floppy disk 6-6

Floppy Disk indicator 2-19

floppy drive 1-6, 1-7, 2-9,
..... 6-5, A-4

Fn (Function) key 2-15

front panel 2-12

function keys 2-16

functions

- display timeout 4-11
- hard disk drive timeout 4-11
- power saving 4-10
- system timeout 4-11

g

graphics mode 4-16

guidelines, installing applications ... 5-3

GW-BASIC 1-10

h

hard disk 1-6, 1-11, 2-20

- backing up 4-26
- cylinders 1-11
- failure 1-12
- formatting 1-11
- platter 1-11
- sector number 1-11
- sectors 1-11
- tracks 1-11

hard disk drive 1-4, A-2, E-7

- timeout function 4-11

Hard Disk indicator 2-20

hardware, configuring 1-4, 4-18

hardware installation 4-18, A-7

- display configuration 4-21
- screen 2-3, 4-18

hardware options 1-7

HDD 1-6

Hercules Graphics Card J-5

HGC 4-21, J-5

high-memory area H-8

HIMEM.SYS

- device driver H-3, H-5, H-8

humidity specifications A-2

i

I/O (input/output)

- configuration 4-21
- port 1-4, 1-10
- serial 4-13
- system 1-10

indicators 2-12, 2-19

- Caps Lock 2-14, 2-20
- Charge 2-19
- Floppy Disk 2-19
- Hard Disk 2-20
- Low Batt(ery) 2-19
- Num Lock 2-17, 2-20
- Power 2-19
- Scr Lk (scroll lock) 2-20

initial program loader 1-5

Ins(ert) key 2-16

installation, hardware 4-18, A-7

installing

- application programs 5-3
- applications without drive option 5-3
- applications,
considerations when 5-5
- copy-protected programs 5-4
- device drivers H-6
- internal battery 3-3
- programs not copy-protected 5-4
- programs with floppy drive 5-5

integrated circuits 1-4

internal battery 2-11, 3-3, 3-7

- charging 3-7
- installing 3-3
- removing 3-5

internal display adaptor 4-15

internal memory H-1, H-5

internal memory check 4-4

internal memory size 4-23

Internal Modem option 1-7, 6-19

internal parallel port 4-22

internal RAM A-1, A-3

internal serial port 4-21

Index

IPL (initial program loader) 1-5

j
Jack, ac adaptor 2-9

k
keyboard 1-4, 2-13
..... 4-10, 5-5, A-2, D-1
customizing your system 4-10
IBM Enhanced D-3
layouts D-1
specifications A-2

keys
Alt 2-15
alternate graphics 2-15
arrow 2-16
backspace 2-15
Break 2-17
Caps Lock 2-14, 4-10
Ctrl (control) 2-15
cursor control 2-16
Del(ete) 2-17
Enter 2-14
Esc(ape) 2-16
Fn 2-15
function 2-16
Ins(ert) 2-16
Num. Lk 2-17
Num Lock 4-10
operation 4-18
Pause 2-17
Prt Sc (print screen) 2-18
repeat rate 4-10
Scr Lk (scroll lock) 2-17, 4-10
Set Up 2-18
Shift 2-14
speed 4-12
standby 4-12
Sys Rq 2-17
tab 2-15
keytop arrows 2-16

l
LapLink 1-5, 5-10
device driver 5-11
File Transfer Utility 5-10
Laptop File Manager 5-13

Laptop Manager 5-13
main menu 5-13
quick commands 5-14
screen 4-5
single-character commands 5-14

LCD (liquid crystal display)
..... 1-4, 2-3, A-1, B-3, E-5
brightness 2-4
brightness control 2-5
contrast control 2-5
modes 4-16
setting 4-9
screen 1-6, 2-4, 2-8, 4-14, E-5
viewing angle 2-4
LCD/CRT switch 2-8, 4-14
left side panel 2-7
lock keys 4-10

Low Batt(ery) indicator 2-19

m
magnetic disk 1-11
main memory 4-23, H-3
main menu, Laptop Manager 5-13
math coprocessor specifications A-4
MDA 4-21, J-1
memory H-1
accessing H-3
areas H-4
cache H-11
configuring H-1
conventional H-3, H-5, H-8
diagnostics E-4
disabled 4-24
expanded 4-23, H-3
expanded memory
specification H-3
extended 4-23, H-3, H-8
high-memory area H-8
HIMEM.SYS H-8
internal H-1, H-5
internal memory check 4-4
internal memory size 4-23
internal RAM H-3
main 4-23, H-3
RAM 1-5, H-1, H-3
RAMDRIVE.SYS H-10

- ROM..... 1-5, H-1
 - standard 5-6
 - memory configuration 4-23
 - memory map H-2
 - messages, power-on 4-18
 - microprocessor..... 1-4
 - modes
 - CGA..... 4-21
 - display 4-15
 - EGA..... 4-21
 - graphics 4-16
 - HGC..... 4-21
 - LCD 4-16
 - MDA..... 4-21
 - screen..... 4-15
 - setting the display 4-16
 - standby..... 4-12
 - text 4-16
 - VGA..... 4-21
 - monitors, external 4-15
 - mouse..... 2-8
 - MS-DOS..... 1-5, 1-10, 2-13
 - backup procedure..... 1-12
 - restoring system files K-1
- n**
- Num. Lock 2-20
 - indicator..... 2-17, 2-20
 - key 2-17, 4-10
 - numeric keypad option..... 1-6, 6-10
 - connector 1-6, 2-6
 - specifications..... A-5
- o**
- operating environment 3-2, A-2
 - humidity 3-2, A-2
 - temperature 3-2, A-2
 - operating system 1-5, 1-10
 - optional card slot cover..... 2-12
 - options 1-7, 6-1
 - Add-On Battery Pack..... 1-7, 6-2
 - Internal Modem..... 1-7, 6-19
 - power consumption..... A-3
 - printer 6-25
 - specifications..... A-3
 - Floppy Drive Unit..... 1-7, 6-5
 - Numeric Keypad..... 1-7, 6-10
 - RAM Card..... 1-7, 6-12
 - CRT Adaptor..... 1-7, 6-16
 - 80C287 Coprocessor..... 1-7, 6-20
 - deluxe carrying case 1-7
- p**
- palette..... 4-17
 - panel
 - bottom..... 2-11
 - front 2-12
 - left side..... 2-7
 - rear 2-9
 - right side..... 2-6
 - parallel connector..... 1-1
 - parallel interface 2-7
 - parallel port..... 1-6, 2-7, 4-22
 - Parity 4-13
 - Pause key..... 2-17
 - physical dimensions A-1
 - platter, disk..... 1-11
 - ports 5-6
 - communication..... 4-13
 - EMS 1/0 4-22
 - I/O 4-21
 - internal parallel 4-22
 - internal serial..... 4-21
 - ROM disk 4-22
 - Power indicator..... 2-19
 - power saving functions..... 4-10
 - power source specifications..... A-2
 - power switch..... 2-12
 - power-on diagnostics E-1
 - power-on message..... 4-18
 - printer..... 6-25, A-2
 - processing speed 5-6
 - programming language..... 1-10
 - programs
 - diagnostic 4-18
 - software..... 4-4
 - Prt Sc (print screen) key 2-18
- q**
- quick boot..... 4-12
 - quick commands, Laptop Manager 5-14

Index

r
RAM..... 1-5, A-1
 internal..... H-3
 card..... 1-4, 6-12
 card specifications..... A-5
 disks..... H-10
RAMDRIVE.SYS
 device driver H-5, H-10
random access memory (RAM) 1-5
read check
 floppy drive option E-5
 hard disk drive..... E-7
read-only memory (ROM) 1-5
real-time clock..... E-2
 check..... E-3
 CMOS RAM check..... E-3
rear panel..... 2-9
rebooting..... 4-25
removing the internal battery 3-5
repair for your computer..... L-1
repeat rate..... 4-10
resolution..... 2-3
restarting the system..... 4-25
right side panel 2-6
ROM..... 1-5, H-1
 disk 1-5, 1-10
 disk port..... 4-22
RPAL..... 4-14
RS-232C connector 1-1

s
Scr Lk (scroll lock) key 2-17
screen
 modes..... 4-15
 settings..... 4-14
screen mode standards..... J-1
 CGA..... J-1
 EGA..... J-2
 HGC..... J-5
 MDA..... J-1
 VGA..... J-4
screens
 hardware installation 4-18
 Laptop Manager 4-5
 LCD 1-6, 2-3, 4-14
 Set Up..... 4-6, 4-18

Scroll Lock indicator..... 2-20
Scroll Lock key 2-17, 4-10
sector number 1-11
sectors 1-11
security hook holder 2-6
self-test..... E-1
sense printer status check E-6
serial I/O 4-13
serial port 1-6, 2-8
 internal..... 4-21
serial printer..... 2-8
service centers..... L-1
Set Up key 2-18
Set Up screen..... 2-4, 4-6, 4-18
setting DIP switches 3-9
setup CMOS RAM check E-3
Shadow utility 4-14
Shift key..... 2-14
SMARTDRV.SYS
 device driver H-6, H- 1 1
software..... 1-10
solving problems F-1
specifications A-1
 CPU A-1
 CRT adaptor A-4
 dimensions..... A-1
 display A-1
 drives..... A-2
 external battery pack..... A-3
 humidity A-2
 keyboard..... A-2
 math coprocessor..... A-4
 numeric keypad..... A-5
 options A-3
 RAM card..... A-4
 power source A-2
 standard ports A-2
 temperature A-2
speed, CPU/BUS 4-12
speed key..... 4-12
standard memory check H-4
standard memory size 1-5
standard ports specifications A-2
standard/reverse switch..... 2-4
standby key 4-12

<p>standby mode 4-12</p> <p>start-up 4-4</p> <p>starting the diagnostics program E-3</p> <p>stop bits 4-13</p> <p>switches</p> <ul style="list-style-type: none"> DIP 3-9 LCD/CRT 2-4, 4-14 power 2-12 <p>Sys Rq key 2-17</p> <p>system</p> <ul style="list-style-type: none"> board 1-4 configurations 4-12 customizing 4-8 restarting 4-25 start-up 4-4 timeout 4-11 <p>t</p> <p>tab key 2-15</p> <p>temperature specifications A-2</p> <p>text mode 4-16</p> <p>time, setting 4-9</p> <p>timer check E-3</p> <p>toggle keys</p> <ul style="list-style-type: none"> Caps Lock 2-14 	<p>Ins(ert) 2-16</p> <p>Num Lk 2-17</p> <p>tracks 1-11</p> <p>troubleshooting F-1</p> <p>u</p> <p>utilities</p> <ul style="list-style-type: none"> Battery Watch 4-4 LapLink File Transfer 5-10 LapLink device driver 5-11 <p>v</p> <p>VGA (video graphics array)</p> <ul style="list-style-type: none"> 1-6, 2-3, 4-21, J-4 controller 4-21 <p>video memory check E-4</p> <p>video subsystem E-2, E-4</p> <p>w</p> <p>warm boot 4-24</p> <p>warranty L-1</p> <p>write check, floppy drive</p> <ul style="list-style-type: none"> option E-5 <p>write-read check,</p> <ul style="list-style-type: none"> hard disk drive E-7
---	--

This computer has been tested and found to comply with the limits for a Class B digital device pursuant to Part 15 of the FCC Rules. These limits are designed to provide reasonable protection against harmful interference in a residential installation. This computer generates, uses, and can radiate radio frequency energy and, if not installed and used in accordance with the instructions, may cause harmful interference to radio communications.

However, there is no guarantee that interference will not occur in a particular installation. If this computer does cause harmful interference to radio or television reception, which can be determined by turning the computer off and on, the user is encouraged to try to correct the interference by one or more of the following measures:

- Reorient or relocate the receiving antenna
- Increase the separation between the computer and receiver
- Connect the computer into an outlet on a circuit different from that to which the receiver is connected
- Consult the dealer or an experienced radio/television technician for help

Notice: Shielded Cables

All connections to other computing devices must be made using shielded cables to maintain compliance with FCC regulations.

Notice: Peripheral Devices

Only peripherals (input/output devices, terminal, printers, etc.) certified to comply with the Class B limits may be attached to this computer. Operation with non-certified peripherals is likely to result in interference to radio and TV reception.

Caution

Changes or modifications not expressly approved by Texas Instruments could void the user's authority, which is granted by the Federal Communications Commission, to operate this computer.

Use Conditions

This device complies with part 15 of the FCC Rules. Operation is subject to the following two conditions: (1) this device may not cause harmful interference, and (2) this device must accept any interference received, including interference that may cause undesired operation.

Notice Canadian users

This digital apparatus does not exceed the Class B limits for radio noise emissions from digital apparatus set out in the Radio Interference Regulations of the Canadian Department of Communications.

Please fold out this cover for an illustration of the TravelMate 2000 Notebook Computer.



**Texas Instruments reserves the right to change
its product and service offering at any time
without notice.**

TravelMate 2000 Notebook Computer

Major Components

Left Side View

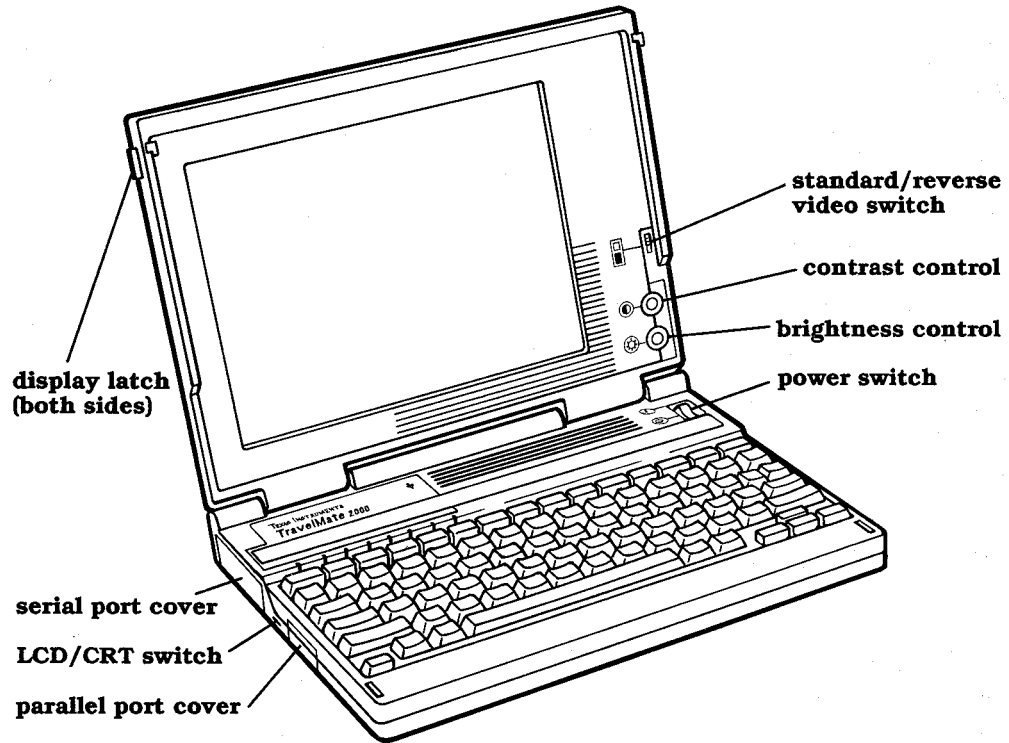

Rear View

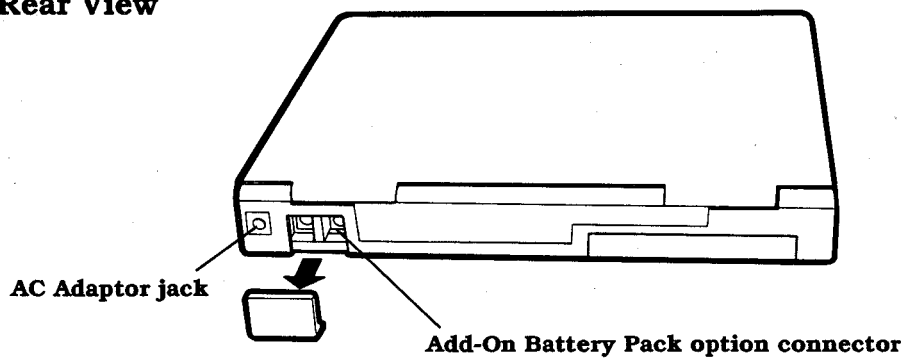

Manual part No. 2568084-0001, Rev. C
Printed in U.S.A.



Texas Instruments

Free Manuals Download Website

<http://myh66.com>

<http://usermanuals.us>

<http://www.somanuals.com>

<http://www.4manuals.cc>

<http://www.manual-lib.com>

<http://www.404manual.com>

<http://www.luxmanual.com>

<http://aubethermostatmanual.com>

Golf course search by state

<http://golfingnear.com>

Email search by domain

<http://emailbydomain.com>

Auto manuals search

<http://auto.somanuals.com>

TV manuals search

<http://tv.somanuals.com>