



**SMVG-600**

**COMPACT DISC + GRAPHICS  
WITH BUILT-IN TV KARAOKE CENTER**

# **OWNER'S MANUAL**

Please read before using this unit.

# WARNINGS

**WARNING:** TO REDUCE THE RISK OF FIRE OR SHOCK HAZARD, DO NOT EXPOSE THIS PRODUCT TO RAIN OR MOISTURE.



## CAUTION

RISK OF ELECTRIC SHOCK  
DO NOT OPEN



**CAUTION:** TO PREVENT THE RISK OF ELECTRIC SHOCK, DO NOT REMOVE COVER OR BACK. NO USER-SERVICEABLE PARTS INSIDE. REFER SERVICING TO QUALIFIED PERSONNEL.



This symbol is intended to alert you to the presence of uninsulated dangerous voltage within the product's enclosure that might be of sufficient magnitude to constitute a risk of electric shock. Do not open the product's case.



This symbol is intended to inform you that important operating and maintenance instructions are included in the literature accompanying this product.

## CAUTION

TO PREVENT ELECTRIC SHOCK, MATCH WIDE BLADE OF PLUG TO WIDE SLOT, FULLY INSERT.

## DRIPPING WARNING

The product shall not be exposed to dripping or splashing and that no objects filled with liquids, such as vases, shall be placed on the product.

## VENTILATION WARNING

The normal ventilation of the product shall not be impeded for intended use.

This CD player is made and tested to meet exacting safety standards. It meets FCC requirements and complies with safety performance standards of the U.S. Department of Health and Human Services.

## Warnings:

- This CD player employs a laser light beam. Only a qualified service person should remove the cover or attempt to service this device, due to possible eye injury.
- The use of controls, adjustments, or procedures other than those specified herein might result in hazardous radiation exposure.

## CAUTION

This compact disc player is classified as a CLASS 1 LASER product. The CLASS 1 LASER PRODUCT label is located on the rear panel.

**CLASS 1  
LASER PRODUCT**

## CAUTION!

Invisible laser radiation when open and interlocks defeated. Avoid exposure to beam.

# IMPORTANT SAFETY INSTRUCTIONS

1. **Read Instructions** - All the safety and operating instructions should be read before the product is operated.
2. **Retain Instructions** - The safety and operating instructions should be retained for future reference.
3. **Heed Warnings** - All warnings on the product and in the operating instructions should be adhered to.
4. **Follow instructions** - All operating and use instructions should be followed.
5. **Cleaning** - Unplug this product from the wall outlet before cleaning. Do not use liquid cleaners or aerosol cleaners. Use a damp cloth for cleaning the exterior only. Do NOT attempt to clean the inside.
6. **Attachments** - Do not use attachments not recommended by the product manufacturer as they may cause hazards.
7. **Water and Moisture** - Do not use this product near water - for example, near a bath tub, wash bowl, kitchen sink, or laundry tub; in a wet basement, or near a swimming pool, and the like.
8. **Accessories** - Do not place this product on an unstable cart, stand tripod, bracket, or table. The product may fall, causing serious injury to a child or adult, and serious damage to the product. Use only with a cart, stand, tripod, bracket, or table recommended by the manufacturer, or sold with the product. Any mounting of the product should follow the manufacturer's instructions, and should use a mounting accessory recommended by the manufacturer.
9. A product and cart combination should be moved with care. Quick stops, excessive force, and uneven surfaces may cause the appliance and cart combination to overturn.



10. **Ventilation** - Slots and openings in the cabinet are provided for ventilation and to ensure reliable operation of the product and to protect it from overheating, and these openings must not be blocked or covered. The openings should never be blocked by placing the product on a bed, sofa, rug, or other similar surface. This product should not be placed in a built-in installation such as a bookcase or rack unless proper ventilation is provided.
11. **Power Sources** - This product should be operated only from the type of power source indicated on the marking label. If you are not sure of the type of power supply to your home, consult your product dealer or local power company. For products intended to operate from battery power, or other sources, refer to the operating instruction.

# IMPORTANT SAFETY INSTRUCTIONS

12. **Grounding or Polarization** - This product may be equipped with a polarized alternating current line plug (a plug having one blade wider than the other). This plug will fit into the power outlet only one way. This is a safety feature. If you are unable to insert the plug fully into the outlet, try reversing the plug. If the plug should still fail to fit, contact your electrician to replace your obsolete outlet. Do not defeat the safety purpose of the polarized plug.

**Alternate Warnings** - This product may be equipped with a three-wire grounding-type plug, a plug having a third (grounding) pin. This plug will only fit into a grounding-type power outlet. This is a safety feature. If you are unable to insert the plug into the outlet, contact your electrician to replace your obsolete outlet. Do not defeat the safety purpose of the grounding-type plug.

13. **Power-Cord Protection** - Power supply cords should be routed so that they are not likely to be walked on or pinched by items placed upon or against them, paying particular attention to cords at plugs, convenience receptacles, and the point where they exit from the product.
14. **Protective Attachment Plug** - The product is equipped with an attachment plug having overload protection. This is a safety feature. See Instruction Manual for replacement or resetting of protective device. If replacement of the plug is required, be sure the service technician has used a replacement plug specified by the manufacturer that has the same overload protection as the original plug.
15. **Outdoor Antenna Grounding** - If an outside antenna is connected to the receiver, be sure the antenna system is grounded so as to provide some protection against voltage surges and built-up static charges. Article 810 of the National Electrical Code, ANSI/NFPA 70, provides information with regard to proper grounding of the mast and supporting structure, grounding of the lead-in wire to an antenna-discharge unit, size of grounding conductors, location of antenna-discharge unit, connection to grounding electrodes, and requirements for the grounding electrode. See figure:

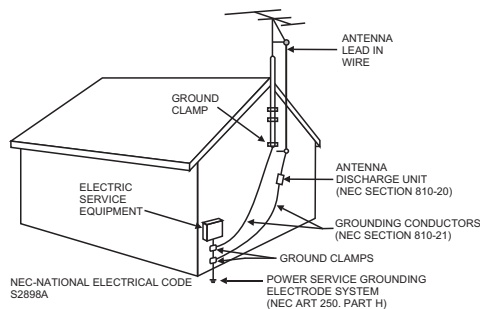

# IMPORTANT SAFETY INSTRUCTIONS

16. **Lightning** - For added protection for this product during a lightning storm, or when it is left unattended and unused for long periods of time, unplug it from the wall outlet and disconnect the antenna or cable system. This will prevent damage to the product due to lightning and power-line surges.
17. **Power Lines** - An outside antenna system should not be located in the vicinity of overhead power lines or other electric light or power circuits, or where it can fall into such power lines or circuits. When installing an outside antenna system, extreme care should be taken to keep from touching such power lines or circuits as contact with them might be fatal.
18. **Overloading** - Do not overload wall outlets, extension cords, or integral convenience receptacles as this can result in a risk of fire or electric shock.
19. **Object and Liquid Entry** - Never push objects of any kind into this product through openings as they may touch dangerous voltage points or short-out parts that could result in a fire or electric shock. Never spill liquid of any kind on the product.
20. **Servicing** - Do not attempt to service this product yourself as opening or removing covers may expose you to dangerous voltage or other hazards. Refer all servicing to qualified service personnel.
21. **Damage Requiring Service** - Unplug this product from the wall outlet and refer servicing to qualified service personnel under the following conditions:
  - a) When the power-supply cord or plug is damaged,
  - b) If liquid has been spilled, or objects have fallen into the product,
  - c) If the product has been exposed to rain or water,
  - d) If the product does not operate normally by following the operating instructions. Adjust only those controls that are covered by the operating instructions as an improper adjustment of other controls may result in damage and will often require extensive work by a qualified technician to restore the product to its normal operation.
  - e) If the product has been dropped or damaged in any way, and
  - f) When the product exhibits a distinct change in performance - this indicates a need for service.
22. **Replacement Parts** - When replacement parts are required, be sure the service technician has used replacement parts specified by the manufacturer or have the same characteristics as the original part. Unauthorized substitutions may result in fire, electric shock, or other hazards.
23. **Safety Check** - Upon completion of any service or repairs to this product, ask the service technician to perform safety checks to determine that the product is in proper operating condition.
24. **Wall or Ceiling Mounting** - The product should be mounted to a wall or ceiling only as recommended by the manufacturer.
25. **Heat** - The product should be situated away from heat sources such as radiators, heat registers, stoves, or other products (including amplifiers) that produce heat.
26. **Nonuse Periods** - Unplug the product's power cord when you will not use it for an extended period.

# **THE SINGING MACHINE KARAOKE GLOSSARY OF TERMS**

In addition to all of the terminology associated with consumer electronics products, a few additional terms are used almost exclusively in karaoke. These terms are meant to familiarize you with the world of Karaoke. The features listed below **may not** necessarily pertain to the particular model Singing Machine that you have. The following are some brief explanations of karaoke terms:

## **Echo:**

Echo adds depth and resonance to a singer's voice without affecting the music. This echo is produced by creating minor controlled feedback in the singer's voice.

## **Multiplex:**

Our multiplex recordings contain 2 copies of the same song. One version is a stereo recording of the song without the lead singer. The second version is recorded with the music and background vocals on the left channel and the lead singer recorded on the right channel. This 'split track' recording allows you to control the volume of the lead singer by adjusting the balance control. You can sing a duet with the lead singer or use the lead singer as a guide as you learn the song, gradually fading them out with the balance control until you are able to sing the song on your own.

## **Auto Voice Control (AVC):**

When the AVC function is activated, the vocals on a multiplex recording are eliminated as soon as the singer begins singing into the microphone. When the singer stops singing, the vocals on the multiplex recording are automatically re-activated. This useful function is used primarily during practice sessions while a singer is learning a song. Please note that the AVC function only works with multiplex recording and not with standard audio recordings.

## **Pitch Control:**

This function controls the pitch of music by controlling the speed at which a cassette tape plays back. By increasing the speed of the tape, the music sounds higher (sharp). By slowing the tape speed, the music sounds lower (flat).

## **Key Controller:**

Key Controller changes the key of the CD/CDG music (+ or - steps) to adjust to the singer's voice.

## **CDG:**

This is an acronym for Compact Disc plus Graphics. You will also see variations CD+G, and CD+Graphics. This is a regular audio CD with information stored on a data track simultaneous to music. In laymen's terms, CDG has a video output for simple graphics (not full motion video). In the case of karaoke, the graphics function is used to store song lyrics, and display the lyrics in synch with music. In most cases, CDG software displays lyrics which change color as they are to be sung. A regular television is all that is required to display CDG lyrics.

**NOTE** - CDG is a particular type of compact disc encoding system that is different from VCD or DVD. Your Singing Machine can decode standard audio compact discs and CDG discs. It will not read VCD or DVD encoded discs.

Standard audio discs and cassette tapes will not display lyrics on your TV. Audio CDs do not contain the software necessary to display lyrics.

# INTRODUCTION

---

Your SMVG-600 Compact Disc + Graphics with **KaraokeVision™** will provide you with many years of fun and entertainment. It can let you be the “star” as you sing along with your favorite recordings and hear your voice with the music through the system’s speakers.

This Karaoke Center is easy to use, yet full of features with a compact design. After just a few simple instructions, you will become an expert. Before you use your SMVG-600, please glance through this manual to familiarize yourself with all the features available and the sections of the manual that describe their operation. Next, go to the section for the specific operation you wish to perform.

For your easy reference, listed here are some of the main features of this Karaoke Center:

**Lyrics on TV screen** - displays the lyrics with the tempo of music when playing CD+G discs.

**Auto Voice Control** - lets you replace the original singer's voice with your own voice when any prerecorded, multiplex karaoke disc or tape is played. To activate, just rotate Mic Volume to a comfortable listening level, and Auto Voice Control for the best balance between playback and microphone levels.

**Balance Control** - lets you adjust the balance between the prerecorded original singer's voice and the music if you use a multiplex karaoke disc.

**Echo Control** - lets you add an echo to enrich your voice for a concert hall effect.

**Master Volume Control** - lets you turn the volume control clockwise or counter-clockwise until desired volume level is obtained.

**KaraokeVision™** - lift up camera lens to display your image on The Singing Machine’s monitor.

**Built-In Speaker** - lets you share the music with your family or friends.

**Auxiliary Output Jacks** - lets you connect another audio output component, such as an equalizer/booster or a PA system.

# CONTROL LOCATIONS

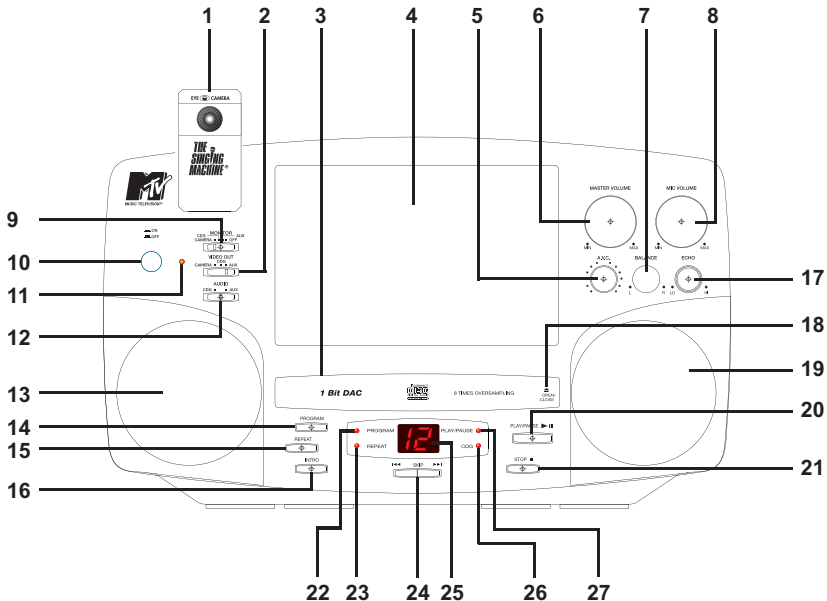

## FRONT VIEW

- |  |  |
|--|--|
| <ol style="list-style-type: none"> <li>1. CAMERA Lens</li> <li>2. VIDEO OUT Selector<br/>(CAMERA/CDG/AUX)</li> <li>3. CD Tray</li> <li>4. MONITOR</li> <li>5. A.V.C. Control (Auto Voice Control)</li> <li>6. MASTER Volume Control</li> <li>7. BALANCE Control</li> <li>8. MIC Volume Control</li> <li>9. MONITOR Selector<br/>(CAMERA/CDG/AUX/OFF)</li> <li>10. POWER Button</li> <li>11. POWER On Indicator</li> <li>12. AUDIO Selector (CDG/AUX)</li> <li>13. Loudspeaker</li> </ol> | <ol style="list-style-type: none"> <li>14. PROGRAM Button</li> <li>15. REPEAT Button</li> <li>16. INTRO Button</li> <li>17. ECHO Control</li> <li>18. CD Tray OPEN/CLOSE Button</li> <li>19. Loudspeaker</li> <li>20. PLAY/PAUSE Button</li> <li>21. STOP Button</li> <li>22. PROGRAM Indicator</li> <li>23. REPEAT Indicator</li> <li>24. SKIP Buttons</li> <li>25. LED Display</li> <li>26. CDG Indicator</li> <li>27. PLAY/PAUSE Indicator</li> </ol> |
|--|--|



# CONTROL LOCATIONS

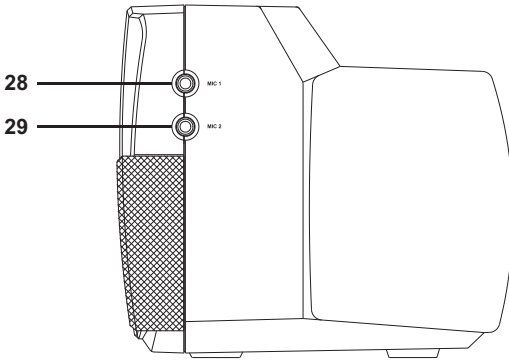

## SIDE VIEW

- 28. MIC 1 Jack
- 29. MIC 2 Jack

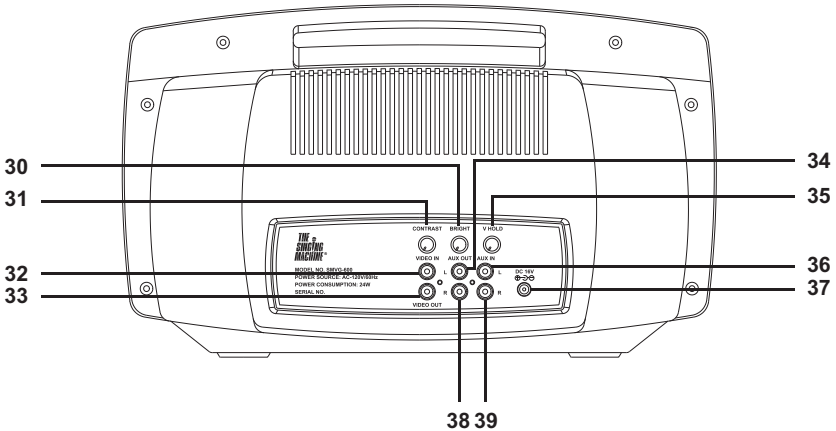

## REAR VIEW

- |                        |                           |
|------------------------|---------------------------|
| 30. BRIGHTNESS Control | 35. VERTICAL HOLD Control |
| 31. CONTRAST Control   | 36. AUX IN Jack (L)       |
| 32. VIDEO IN Jack      | 37. DC Jack (DC 16V)      |
| 33. VIDEO OUT Jack     | 38. AUX OUT Jack (R)      |
| 34. AUX OUT Jack (L)   | 39. AUX IN Jack (R)       |

# MAKING THE CONNECTIONS

---

## CONNECTING POWER

You can power the system from a standard AC outlet by using the supplied AC-DC adapter.

**CAUTION:** The adapter must be connected to the power voltage which is the same as the local area. If not, there is a danger of BURNING the unit that causes a fire.

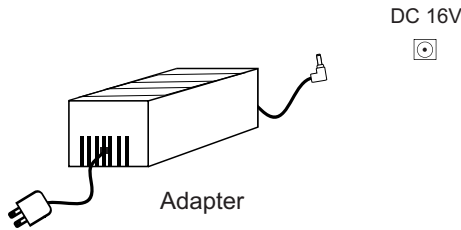

### For UK only

**CAUTION:** The adapter is designed to operate from a main supply of 230V AC~50Hz. The unit is fitted with a 13amp (BS 1363) main plug. Should the fuse in the main plug require replacing a **3amp** (BS 1363) fuse must be fitted. Ensure the voltage of your electrical power supply matches those indicated on the rating label located on the top of the adapter.

If the socket outlets in your home are not suitable for the plug supplied with the unit, the plug should be removed and an appropriate one fitted.

## CONNECTING TO YOUR TV

The Singing Machine provides a patch cord to give you the option of connecting your SMVG-600 to an external audio/sound system and video device. The patch cord has three RCA jacks at each end. White and Red are for left and right audio connections and the Yellow is for connecting the video.

Make sure that you have a CDG disc in the Singing Machine and playing when you are making this connection. You will know you have the proper settings on your TV or VCR as soon as you see the Singing Machine logo or lyrics on the screen!

# MAKING THE CONNECTIONS

## VIDEO CONNECTION (for TV)

Please follow the steps below to display CDG lyrics on the TV screen:

- (1) Locate the multicolored patch cords.
- (2) Connect Video Cable (yellow) to the Video Out of the back of the Singing Machine.
- (3) Connect the other end of the Video Cable (yellow) to the Video Input on your TV or VCR.

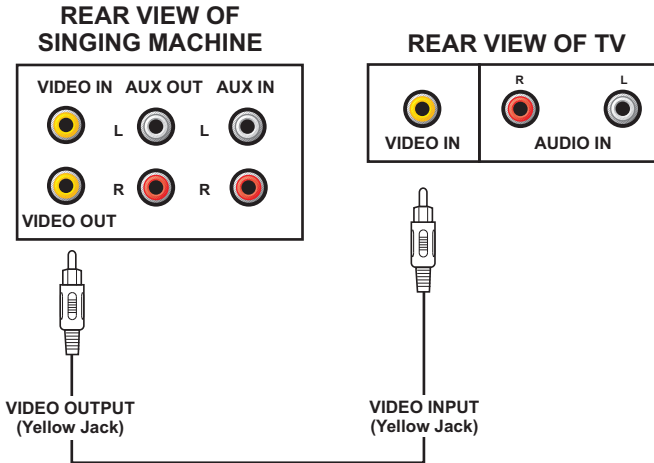

## VIDEO CONNECTION (for VCR recording)

Please follow the steps below to record CDG lyrics or image on the VCR:

- (1) Locate the multicolored patch cords.
- (2) Connect Video Cable (yellow) to the Video Out of the back of the Singing Machine.
- (3) Connect the other end of the Video Cable (yellow) to the Video Input on your VCR.

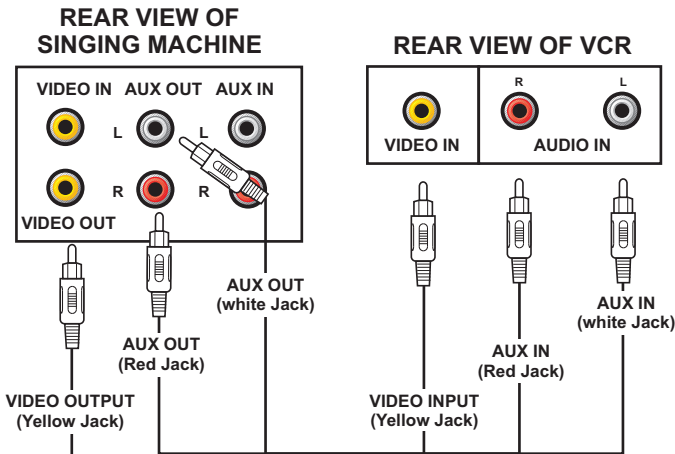

## **MAKING THE CONNECTIONS**

---

If your television or VCR does not have the required Video Input, you will need an RF Modulator (Radio Frequency Modulator), which connects through your TV Antenna or cable line and serves as Video Input.

An RF Modulator can be purchased at almost any consumer electronics retailer. If you are connecting the video from the Singing Machine to either a television or a VCR video input jack, you must specify the source the TV or VCR is to display. Your TV or VCR user guide can tell you how to display the video signal from the 'Video In' jack.

If you don't have the manual for your TV or VCR, we suggest calling the TV or VCR, manufacturer's customer service department. Only the manufacturer will be able to tell you very quickly how to configure your TV or VCR to display the video signal coming from the 'Video Input' jack.

\* Note: Some projection TV sets do not properly display the standard blue background when using most CDGs. If the background color is inconsistent or flashing, please try connecting your Singing Machine to a standard tube television.

### **COMMON WAYS TO CONFIGURE YOUR TV OR VCR**

Your Singing Machine is designed to connect to your TV the same way you would connect a video camera, VCR or video game. The Singing Machine is constantly sending the video and audio signals to the 'Video Out' and 'AUX OUT' jacks whenever you play a CDG. So, load a CDG into your Singing Machine before you start making these connections. You will see lyrics on the TV screen as soon as you get the setup completed correctly.

We refer to TV/VCR because manufacturers use very similar ways to connect TVs and VCRs and you can connect your Singing Machine to a TV, VCR or satellite system (contact your satellite company for instructions). The setup of your TV/VCR is the most difficult part of making the connection for displaying your Singing Machine lyrics. In most homes, the TV has either a cable connected or antennae in use. Once you connect your Singing Machine to the TV/VCR, you must 'tell' your TV/VCR to display the input from the Singing Machine instead of the usual input from the cable or antennae.

Check your TV/VCR user manual for the easiest way to setup your particular entertainment system. If you don't have your manual you can always call your TV/VCR manufacturer for that information or try hitting their website for online assistance. We've listed below the most common ways of setting up a TV/VCR:

- (1) In the setup menu for configuring the TV/VCR there may be an option on 'Input Selection' where you may choose between 'Cable/Ant.', 'Video 1', or 'Video 2' etc. as the input source.
- (2) Try looking for a 'Video' channel between the highest channel and the lowest channel on your TV or VCR. (i.e. Between 99 and 2 may be 'VIDEO' or 'INPUT' or 'GAME')
- (3) Look for a button on the remote control for the TV/VCR you are connecting to that says 'VIDEO', 'VIDEO 1', 'Game', 'AUX', 'EXT', 'LINE1', 'LINE-IN' or occasionally the 'VCR' button will display the Video input source.

# MAKING THE CONNECTIONS

## CONNECTING A VIDEO COMPONENT FOR INPUT

Please follow the steps below to display CDG lyrics on the Singing Machine's monitor from another video source:

- (1) Locate the multicolored patch cords.
- (2) Connect Video Cable (yellow) to the Video In of the back of the Singing Machine.
- (3) Connect the other end of the Video Cable (yellow) to the Video Output on another video source such as a VCR.
- (4) Set the MONITOR Selector to AUX mode and the AUDIO Selector to AUX mode.
- (5) Adjust the BRIGHTNESS, CONTRAST and VERTICAL HOLD Controls at the back of the Singing Machine to have the best picture quality.

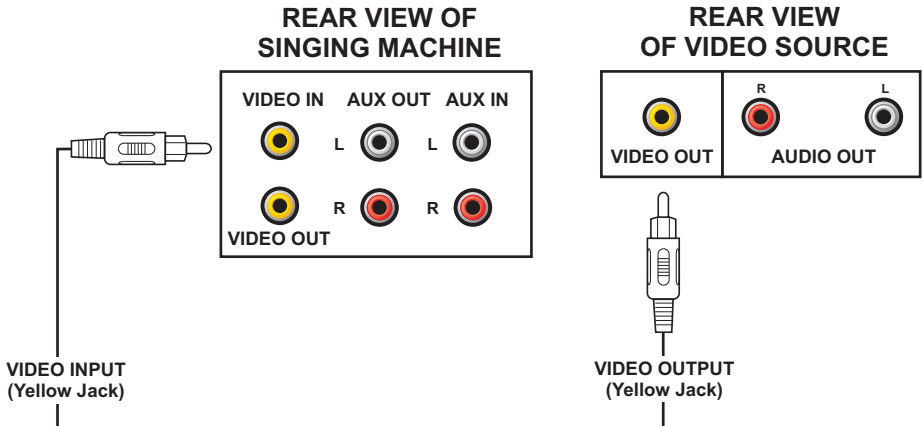

## AUDIO CONNECTION

Connect the SMVG-600 to your TV or home stereo system using the White and Red connections on the supplied patch cord. Plug the white end of the patch cord into the white AUX OUT jack on the SMVG-600. Plug the red end of the patch cord into the red AUX OUT jack on SMVG-600. Now connect the other end of the cable's white (left channel) and red (right channel) plugs to your TV or home stereo system's 'AUDIO IN' or 'AUX IN' jacks.

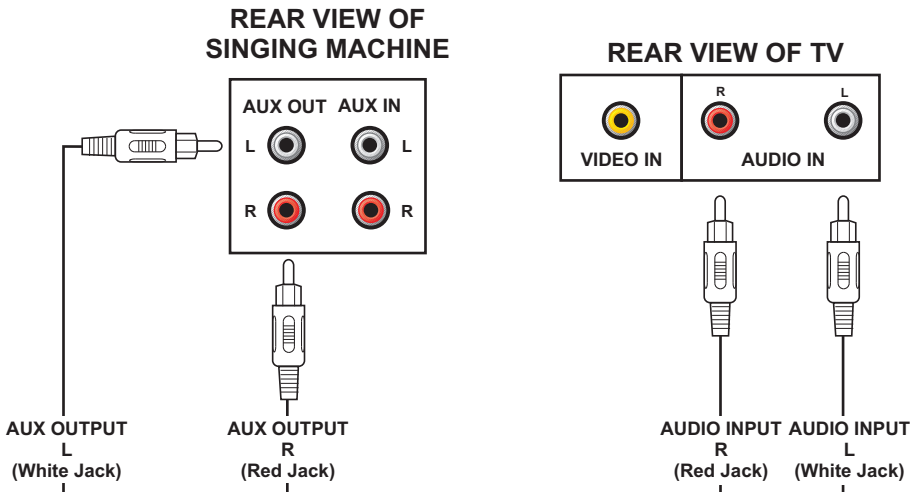

# MAKING THE CONNECTIONS

## CONNECTING AN AUDIO COMPONENT FOR INPUT

To connect another audio source (such as a Tuner, an AV Receiver or a VCR) so you can sing along with its music, simply connect the Audio Output jacks (Red & White RCA jacks) to the Singing Machine's AUX IN L & R jacks.

### REAR VIEW OF SINGING MACHINE

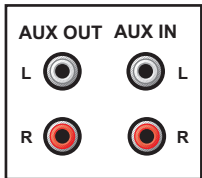

### ANOTHER AUDIO COMPONENT

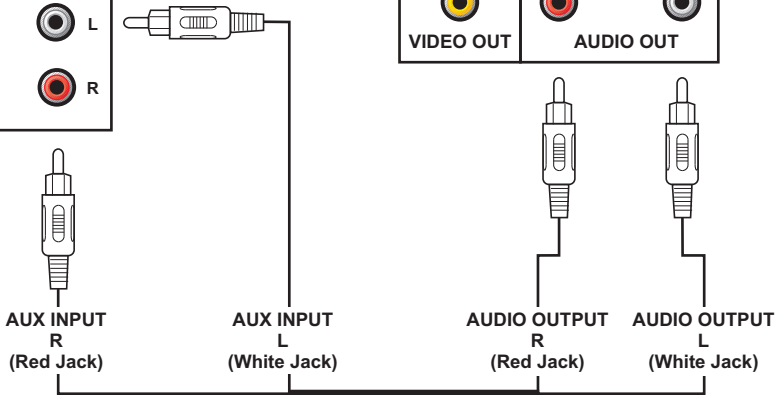
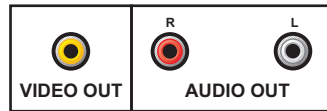

## MONITOR Selector

- To play a CDG disc, set the MONITOR Selector to either CAMERA, CDG or OFF mode.
- To play another audio component, set the MONITOR Selector to AUX mode.
- To display CDG lyrics on the Singing Machine's monitor, set the MONITOR Selector to CDG mode.
- To display your image on the Singing Machine's monitor, set the MONITOR Selector to CAMERA mode.
- To turn off the monitor on the Singing Machine, set the MONITOR Selector to OFF mode.
- Adjust the BRIGHTNESS, CONTRAST and VERTICAL HOLD Controls at the back of the Singing Machine to have the best picture quality.

## VIDEO OUT Selector

- To display image on the TV, set the VIDEO OUT Selector to CAMERA mode.
- To display CDG lyrics on the TV, set the VIDEO OUT Selector to CDG mode.
- To display image on the TV from another video source, set the VIDEO OUT Selector to AUX mode.

## AUDIO Selector

- To listen to music from your SMVG-600, set AUDIO Selector to CDG mode.
- To listen to music from another audio component, set the AUDIO Selector to AUX mode.

## CD OR CD+G OPERATION

---

**\*Warning - Tapping or dropping the microphone while it is on can permanently damage your microphone. Resist the urge to swing the microphone around by the cord!**

### PREPARATION

- This unit is designed to play CD's bearing the identification logo "  ". If CD's do not conform to the CD standard, they may not play properly.
- Fingerprints and dust should be carefully wiped off with a soft cloth. Wipe in a straight motion from the center of the disc to the outside edge.
- Never use chemicals, such as record cleaning sprays, antistatic sprays or fluids, benzene or thinner to clean compact discs. These chemicals will permanently damage the plastic surface of the disc.
- Always place the compact disc on the disc tray with the label facing upward. Compact discs can be played on only one side.
- To remove a disc from its storage case, press down on the center of the case and lift the disc out, holding it carefully by the edges.
- Discs should be returned to their cases after use to protect them from dust and scratches.
- To prevent warping the disc, do not expose it to direct sunlight, high humidity or high temperatures for extended periods of time.
- Do not apply paper or write anything on either side of the disc. The inks used in some felt-tips pens may damage the surfaces of the disc.

### PLAYING CD OR CD+G DISC

Reminders:

- Adjust MASTER VOLUME control on your SMVG-600, TV or audio system to a comfortable level.
- Adjust MIC/ECHO/BALANCE controls as needed to achieve the desired mix of music and vocals through your TV or sound system.
- Never place anything except a compact disc on the disc tray. Foreign objects can damage the unit.
- Only place one disc on the disc tray at a time.

### TURNING POWER ON/OFF

- To turn on the Karaoke center, press the POWER button. The POWER ON LED Indicator will light up.
- To turn off the system, press the POWER button again. The POWER ON LED Indicator will turn off.

### MONITOR SELECT

- To play a CD+G, set MONITOR Selector to either CAMERA, CDG or OFF mode.
- To display the CDG lyrics on the Singing Machine's monitor, set MONITOR Selector to CDG mode.
- To turn off the monitor on the Singing Machine, set MONITOR Selector to OFF mode.
- Adjust the BRIGHTNESS, CONTRAST and VERTICAL HOLD Controls at the back of the Singing Machine to have the best picture quality.

### AUDIO SELECT

- Set the AUDIO Selector to CDG mode. When using CDG.

### LOADING A DISC

- Press CD TRAY OPEN/CLOSE button to open CD drawer. Place a disc in the drawer with the printed side facing upward and the shiny side facing down.
- Press the CD Tray OPEN/CLOSE button again to close the CD drawer. The LED window will display total number of tracks. (If no disc is loaded, it will display " \_ \_ ")

**(Refer to the Trouble Shooting Guide on page 17 if a disc is loaded but the total tracks do not appear.)**

# CD OR CD+G OPERATION

---

## PLAY/PAUSE MODE

- To start playing, press the PLAY/PAUSE button, the first track [ 1 ] and the PLAY/PAUSE LED Indicator will be displayed.
- To temporarily stop playing, press the PLAY/PAUSE button, the PLAY/PAUSE LED Indicator will flash.
- To resume play, press this button again.

PLEASE NOTE: Pressing pause when a CDG is playing may cause distorted lyrics on the monitor. Any distortion will remain until the whole screen is refreshed during an instrumental break or you stop the song and start it from the beginning.

## STOP MODE

If the STOP button is pressed in the course of playing, the disc will cease to play. (The total number of tracks will be shown on the LED window).

## SKIP PLAY(For both CD and CDG discs)

- During STOP mode, you can skip up or down to your desired track number by pressing the SKIP button(⏮- SKIP -⏭).
- To resume playing the selected song, press PLAY/PAUSE button.

## SEARCH (For audio CD disc only)

When playing any audio CD, press and hold the SKIP button ( ⏮ -SKIP- ⏭ ), the CD will search at high speed in the forward or backward direction. Normal play will continue when you release the button.

## REPEAT PLAY

- To repeat the track currently playing, press the REPEAT button once, the REPEAT LED Indicator will flash, then press the PLAY/PAUSE button.
- To repeat all tracks, press the REPEAT button twice, the REPEAT LED Indicator will light up. Press the PLAY/PAUSE button to begin.
- To clear the repeat function. Press the REPEAT button again, the REPEAT LED Indicator will turn off.

## PROGRAM PLAY

- Use the PROGRAM button to program and play back songs in a pre-selected order.
- Programming should be done in the STOP mode only. Press the PROGRAM button once then the PROGRAM LED flashes, number [ 1 ] will also display. Press SKIP buttons (⏮- SKIP -⏭) to select a desired track and press the PROGRAM button to confirm entry. You can repeat the same steps up to a maximum of 19 tracks.
- Press PLAY/PAUSE button when you have completed programming and you are ready to start singing.
- To clear all the programmed memories, press STOP button.

## INTRO PLAY

- Press the INTRO button once, then press PLAY. The CD player will play up to 10 seconds of each track as an introduction.
- Press the INTRO button again to stop intro scan play.

Note: The first few seconds of most tracks is silence.



# CARE AND MAINTENANCE

---

## POWER SWITCH

After using the SMVG-600, turn off the power by pressing the POWER button.

## CLEANING THE UNIT

To clean the exterior of the unit, simply wipe with a soft clean cloth moistened with plain lukewarm water.

## CLEANING THE CD LASER LENS

For Best Results: Use a CD-lens cleaning disc according to the cleaning disc manufacturer instructions.



To prevent fire or shock hazard, disconnect your stereo system from the AC power plug when cleaning.

## COMPACT DISC

### Handling Disc

Although the music tracks in the disc are covered with a protective layer, it is still advisable to treat the disc carefully. Ensure that you always pick up discs by the edge, and put them back in their holders immediately after use.

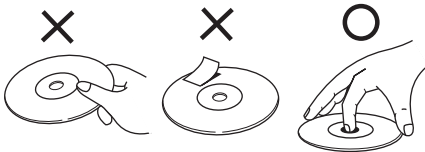

## CLEANING DISC

Cleaning will not normally be necessary. However, should fingerprints, dust or dirt appear, you can wipe them off with a soft, lint-free cloth. Wipe the disc in a straight line from center to edge. You can moisten the disc first with ordinary tap water if necessary.



**NOTE: Do not use the detergent or abrasive cleaning agents, for they can damage the disc.**

## CD PLAYER

The player mechanism is fitted with self-lubricating bearing and must not be oiled or greased.

# TROUBLE SHOOTING GUIDE

If you have followed the instructions and are having difficulty operating the unit, locate the PROBLEM in the left column below. Check the corresponding POSSIBLE CAUSE column to locate and remedy the problem.

PROBLEM	POSSIBLE CAUSE	SOLUTION
No power when POWER is on.	No DC jack connection at the AC adapter.	Insert the DC jack into the DC socket on back of cabinet.
No power when plugged in.	The AC outlet may not have power.	Check the outlet with a working lamp or other electrical appliance.
No sound.	Volume control is set to minimum.	Turn up the volume.
	Volume control on TV set/PA system is set to minimum.	Turn up the volume at TV/PA system.
	TV set/PA system power is OFF.	Turn on the power at TV/PA system.
	AUX OUT jacks not connected.	Follow directions on page 12 for 'Audio Connection'.
CD PLAYER cannot work normally or --, E, or 00 are displayed.	Disc is inserted upside down.	Insert disc correctly.
	Disc is dirty.	Wipe clean with soft cloth.
	Disc is scratched.	Use a new disc.
	Disc is warped.	Use a new disc.
	A nonstandard disc is inserted.	Only use discs bearing standard logo as described on page 14.
	Moisture has formed inside the CD deck.	Wait about 20 to 30 minutes to let it dry out.
	Singing Machine needs to be reset.	Unplug machine for 30 seconds.
No sound - If audio is going through home stereo.	Source Selection on your stereo is not set properly.	Select AUX IN as the source for your home stereo.
	Improper Connection to stereo system or PA.	Follow direction on page 12 for connecting to a home stereo system.

## TROUBLE SHOOTING GUIDE

PROBLEM	POSSIBLE CAUSE	SOLUTION
No sound - If audio is going through TV or VCR.	Source Selection on TV or VCR is not correct.	Follow directions on page 10 for 'Video Connection'.
No song lyrics appear on screen.	Video cable is not connected properly to the TV.	Connect the video cable to the Singing Machine's VIDEO OUT and to the TV VIDEO IN.
	Source selector on TV is not set to VIDEO.	Using your TV Remote to select VIDEO input.
	TV does not have video line input.	Connect from VIDEO OUT of the system to the VIDEO IN of your VCR or Connect to an RF Modulator and then to the TV cable input. Refer to "Making the Connections" on page 9. Check the disc to be sure it is a CDG. (See page 5 for details)
	A CDG is loaded but the CDG indicator is not lit.	Check disc to be sure it is clean. (See page 16 for cleaning instructions.)
Picture is jumping up.	VERTICAL HOLD Control is not set correctly.	Adjust the VERTICAL HOLD Control.
No image display on Singing Machine's monitor.	The Camera Lens is down.	Lift up a Camera Lens.
	Monitor Selector is not set properly.	Set MONITOR Selector to CAMERA mode.
No sound from mic.	Mic volume control.	Adjust mic volume to max. Then back it off to a comfortable level.
	Mic is off.	Turn on mic with the ON/OFF switch located on the microphone.

Please call Customer Service at 954-596-1110 if the Trouble Shooting Guide information doesn't correct your problem.

Servicing of a Singing Machine by an unauthorized repair facility will void your warranty. The Singing Machine cannot guarantee future repairs on machines that have been tampered with by unauthorized personnel.

## SPECIFICATIONS

<b>AUDIO SECTION:</b> OUTPUT POWER (10% THD) OUTPUT IMPEDANCE	2 WATTS + 2 WATTS (RMS) 8 ohms
<b>CD PLAYER SECTION:</b> FREQUENCY RESPONSE SIGNAL - TO - NOISE RATIO WOW AND FLUTTER D - A CONVERSION NUMBER OF PROGRAMS SAMPLING SYSTEM	100 Hz - 20KHz 50 dB IMMEASURABLE 1 BIT D/A CONVERTER 19 TRACKS PROGRAM MEMORY 8 TIME OVER SAMPLING
<b>MONITOR SECTION</b>	5.5" TV MONITOR NTSC, PAL 2 SYSTEM 220 LINE RESOLUTION
<b>MICROPHONE</b>	-74 dB 600OHM IMPEDANCE WITH 6.3mm DYNAMIC MICROPHONE
<b>POWER SECTION:</b> (Where applicable)	DC 16V/2500mA AC TO DC ADAPTER(INCLUDED)
<b>DIMENSIONS (H x W x D)</b>	11.7 x 7.6 x 8.6 Inches / 30 x 19.6 x 22 cm
<b>WEIGHT</b>	7.1 Lbs / 3.2Kg (Approx.)
<b>ACCESSORIES</b>	<ol style="list-style-type: none"> <li>1. Pre-recorded Karaoke CD+G disc</li> <li>2. AV Cable</li> <li>3. Dynamic Microphone</li> <li>4. Instruction Manual</li> </ol>

Specifications are typical, individual units might vary. They are subject to continuous improvement without notice and without incurring any obligation.

# NOTES

---

# NOTES

---

# NOTES

---

## LIMITED WARRANTY and SERVICE

THE SINGING MACHINE COMPANY, INC. warrants this product to be free from defects in material and workmanship for a period of Ninety (90) days from date of sale to the original consumer purchaser. Product will be replaced or repaired free of charge if it has proven to be defective within the Ninety (90) day period when said product is returned at customer expense within the warranty period. **THIS WARRANTY DOES NOT COVER ANY EXPENSES INCURRED IN THE REMOVAL AND REINSTALLATION OF THIS PRODUCT.**

This warranty does not apply to any product damaged by accident, misuse, abuse, improper line voltage, fire, water, lightning or other acts of God, or any parts or service furnished by anyone else. The warranty does not cover cartons, carrying cases, batteries, broken or damaged cabinets, or any other items used in connection with the product or consequential damages due to defect in the product. This warranty does not cover products sold AS IS or Re-manufactured units or units sold outside the SMC distribution channel.

ALL IMPLIED WARRANTIES ARE LIMITED TO THE DURATION OF THIS WARRANTY. THIS IS THE COMPLETE WARRANTY AND NO OTHER EXPRESSED WARRANTY IS VALID. SOME STATES DO NOT ALLOW LIMITATIONS ON HOW LONG AN IMPLIED WARRANTY LASTS OR AN EXCLUSION OR LIMITATIONS OF INCIDENTAL OR CONSEQUENTIAL DAMAGES, SO THE ABOVE LIMITATIONS OR EXCLUSIONS MAY NOT APPLY TO YOU.

This warranty gives you specific legal rights and you may also have other rights, which may vary from state to state.

**IF THE UNIT IS OUTSIDE THE WARRANTY PERIOD**, please call us at (954) 596-1110 and we will give you information on how to obtain repair services.

**TO OBTAIN SERVICE ON WARRANTY UNITS**, the unit must be sent prepaid by insured parcel post or UPS to the SMC service center address. To establish your eligibility for free repair or replacement, **YOU MUST INCLUDE** a note explaining how the unit is defective, the street address and your phone number we should use for shipping, **AND attach a COPY of your proof of purchase showing the unit is within the 90 day warranty.**

SERVICE CENTER:            THE SINGING MACHINE COMPANY  
   303 W. Artesia Blvd.  
   Compton, CA 90220-5525  
   USA

The Singing Machine Company, Inc.

---

6601 Lyons Road, Bldg. A7, Coconut Creek, FL33073-9902, USA.  
TEL: (954) 596-1110    FAX: (954) 596-2000

PRINTED IN CHINA

**VISIT OUR WEBSITE [www.singingmachine.com](http://www.singingmachine.com)**



## Free Manuals Download Website

<http://myh66.com>

<http://usermanuals.us>

<http://www.somanuals.com>

<http://www.4manuals.cc>

<http://www.manual-lib.com>

<http://www.404manual.com>

<http://www.luxmanual.com>

<http://aubethermostatmanual.com>

Golf course search by state

<http://golfingnear.com>

Email search by domain

<http://emailbydomain.com>

Auto manuals search

<http://auto.somanuals.com>

TV manuals search

<http://tv.somanuals.com>