



Instruction Manual

iSM-1028 N

Please read before using this unit.

Pedestal CDG karaoke system with built-in video camera, 7" TFT LCD color monitor, iPod docking and AM/FM radio

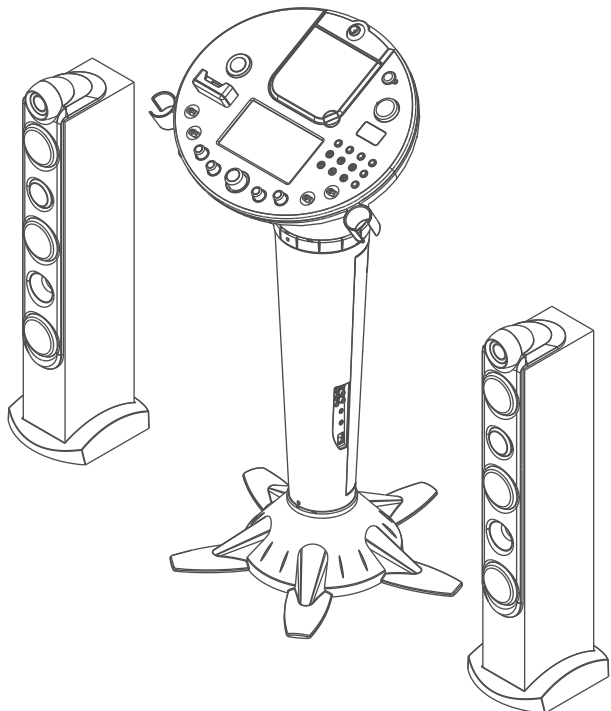

Made for
iPod

WARNINGS

- TO PREVENT FIRE OR SHOCK HAZARD. DO NOT EXPOSE THIS APPLIANCE TO RAIN OR MOISTURE.
- THIS APPLIANCE SHOULD NOT BE EXPOSED TO OR PLACED NEAR, DRIPPING, SPLASHING WATER OR OBJECTS FILLED WITH LIQUIDS (SUCH AS VASES.)



The lightning flash with arrowhead symbol, within an equilateral triangle, is intended to alert the user to the presence of uninsulated "dangerous voltage" within the product's enclosure that may be of sufficient magnitude to constitute a risk of electric shock to people.

CAUTION

**RISK OF ELECTRIC SHOCK
DO NOT OPEN**

WARNING: TO REDUCE THE RISK OF ELECTRIC SHOCK, DO NOT REMOVE COVER (OR BACK). NO USER-SERVIC-ABLE PARTS INSIDE. REFER SERVICING TO QUALIFIED SERVICE PERSONNEL.



The exclamation point within an equilateral triangle is intended to alert the user to the presence of important operating and maintenance (servicing) instructions in the literature accompanying the appliance.

IMPORTANT SAFETY INSTRUCTIONS

1. Read these instructions.
2. Keep these instructions.
3. Heed all warnings.
4. Follow all instructions.
5. Do not use this apparatus near water.
6. Clean only with dry cloth.
7. Do not block any ventilation openings. Install in accordance with the manufacturer's instructions.
8. Do not install near any heat sources such as radiators, heat registers, stoves, or other apparatus (including amplifiers) that produce heat.
9. Do not defeat the safety purpose of the polarized or grounding-type plug. A polarized plug has two blades with one wider than the other. A grounding type plug has two blades and a third grounding prong. The wide blade or the third prong are provided for your safety. If the provided plug does not fit into your outlet, consult an electrician for replacement of the obsolete outlet.
10. Protect the power cord from being walked on or pinched particularly at plugs, convenience receptacles, and the point where they exit from the apparatus.
11. Only use attachments/accessories specified by the manufacturer.
12. Use only with the cart, stand, tripod, bracket, or table specified by the manufacturer, or sold with the apparatus. When a cart is used, use caution when moving the cart/apparatus combination to avoid injury from tip-over.
13. Unplug this apparatus during lightning storms or when unused for long periods of time.
14. Refer all servicing to qualified service personnel. Servicing is required when the apparatus has been damaged in any way, such as power-supply cord or plug is damaged, liquid has been spilled or objects have fallen into the apparatus, the apparatus has been exposed to rain or moisture, does not operate normally, or has been dropped.
15. Grounding or Polarization - This product may be equipped with a polarized alternating current line plug (a plug having one blade wider than the other). This plug will fit into the power outlet only one way. This is a safety feature. If you are unable to insert the plug fully into the outlet, try reversing the plug. If the plug should still fail to fit, contact your electrician to replace your obsolete outlet. Do not defeat the safety purpose of the polarized plug.
16. Ventilation - Slots and openings in the cabinet are provided for ventilation and to ensure reliable operation of the product and to protect it from overheating, and these openings must not be blocked or covered. The openings should never be blocked by placing the product on a bed, sofa, rug, or other similar surface. This product should not be placed in a built-in installation such as a bookcase or rack unless proper ventilation is provided.
17. The MAINS plug or an appliance coupler is used as the disconnect device, the disconnect device shall remain readily operable.



IMPORTANT SAFETY INSTRUCTIONS

CAUTION: USE OF ANY CONTROLS, ADJUSTMENTS, OR PROCEDURES OTHER THAN THOSE SPECIFIED HEREIN MAY RESULT IN HAZARDOUS RADIATION EXPOSURE

CAUTION: Invisible laser radiation when open and inter locks defeated. Avoid exposure to beam. This class[B] digital apparatus complies with Canadian ICES-003.

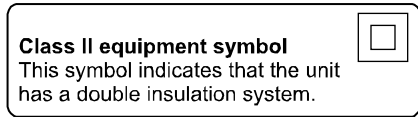

Warning: Changes or modifications to this unit not expressly approved by the party responsible for compliance could void the user's authority to operate the equipment.

NOTE: This equipment has been tested and found to comply with the limits for a Class B digital device , pursuant to Part 15 of the FCC Rules. These limits are designed to provide reasonable protection against harmful interference in a residential installation. This equipment generates, uses, and can radiate radio frequency energy and, if not installed and used in accordance with the instructions, may cause harmful interference to radio communications. However, there is no guarantee that interference will not occur in a particular installation. If this equipment does cause harmful interference to radio or television reception, which can be determined by turning the equipment off and on, the user is encouraged to try to correct the interference by one or more of the following measures:

- Reorient or relocate the receiving antenna.
- Increase the separation between the equipment and receiver.
- Connect the equipment into an outlet on a circuit different from that to which the receiver is connected.
- Consult the dealer or an experienced radio TV technician for help.

INSTALLATION

STEP 1

1. Attach the pedestal (middle) into the stand (bottom) according to the installation illustration and rotate clockwise.

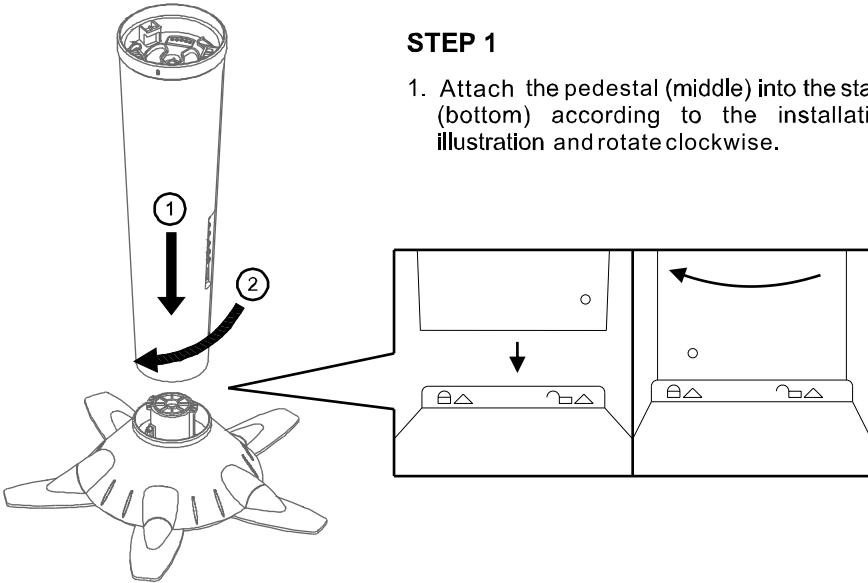

STEP 2

2. Tighten a self tapping screw at the bottom of the pedestal (middle).

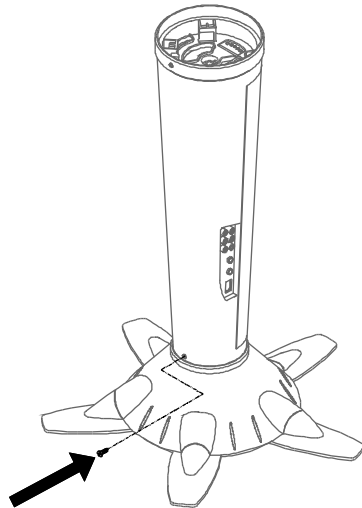

INSTALLATION

STEP 3

3. Plug the RED connector and WHITE connector into corresponding colored ports in the correct direction. Please follow these instructions carefully as the system will not function/power if connections are not made properly. Attach the control panel (top) onto the control base and rotate clockwise.

Warning: Do not remove the connectors with cable ties.

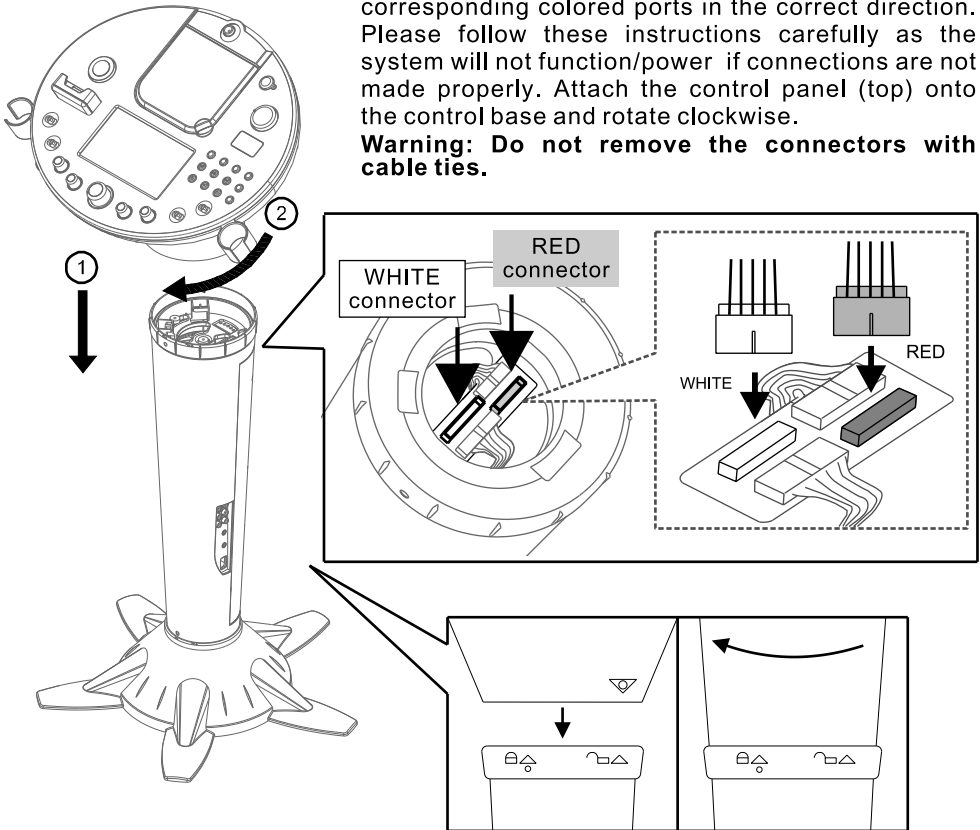

STEP 4

4. Tighten a self tapping screw at the control panel (top).

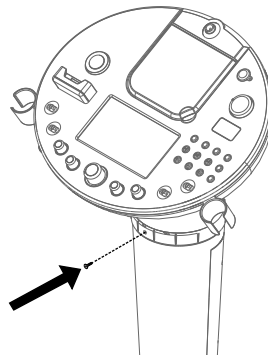

INSTALLATION INSTRUCTIONS FOR TOWER SPEAKERS

ENGLISH

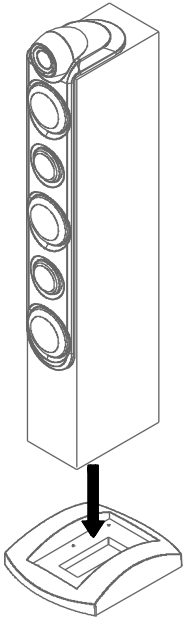

STEP 5

5. Attach the speaker into the stand according to the installation illustration.

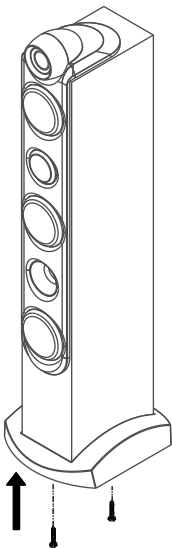

STEP 6

6. Tighten both screws on bottom of speaker.

CONTROL LOCATIONS

See control locations as indicated on the next few pages.

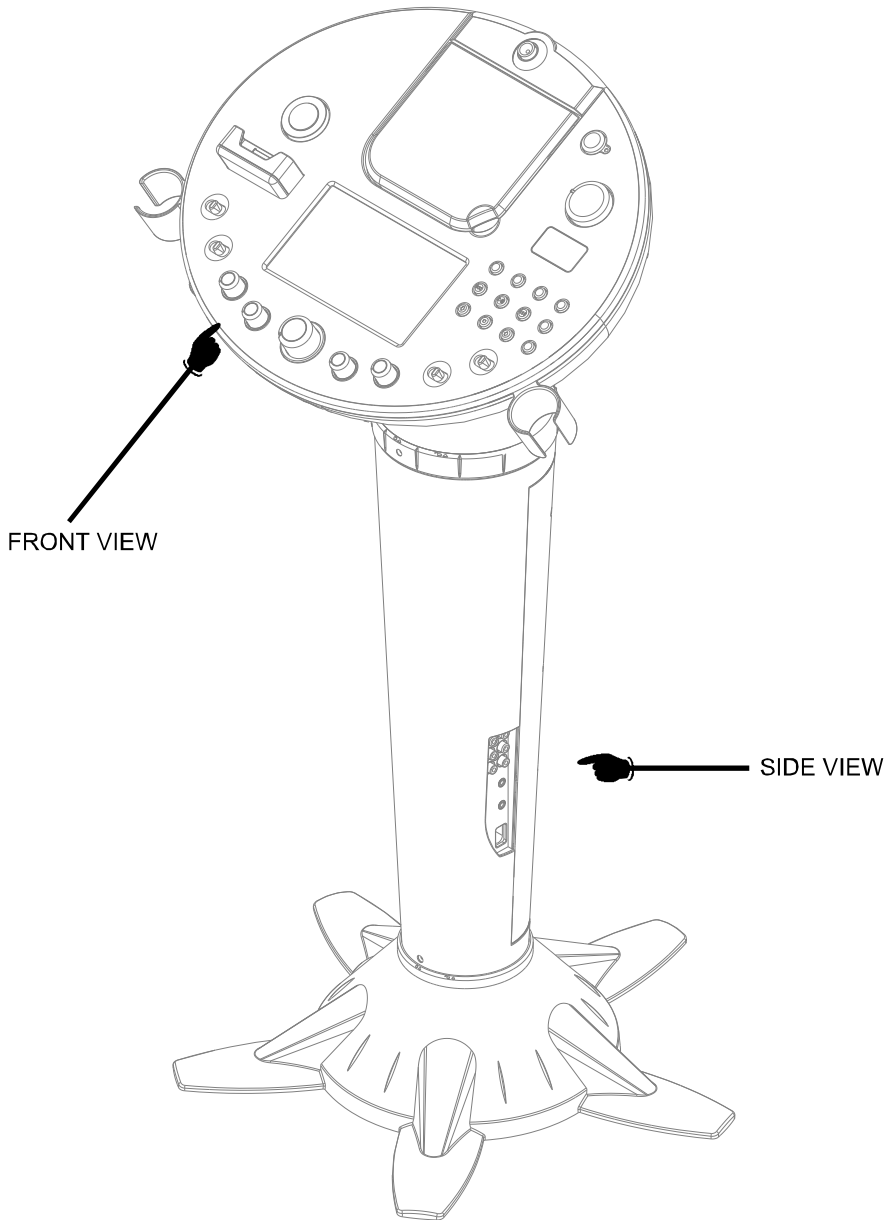

FRONT VIEW

SIDE VIEW

CONTROL LOCATIONS

ENGLISH

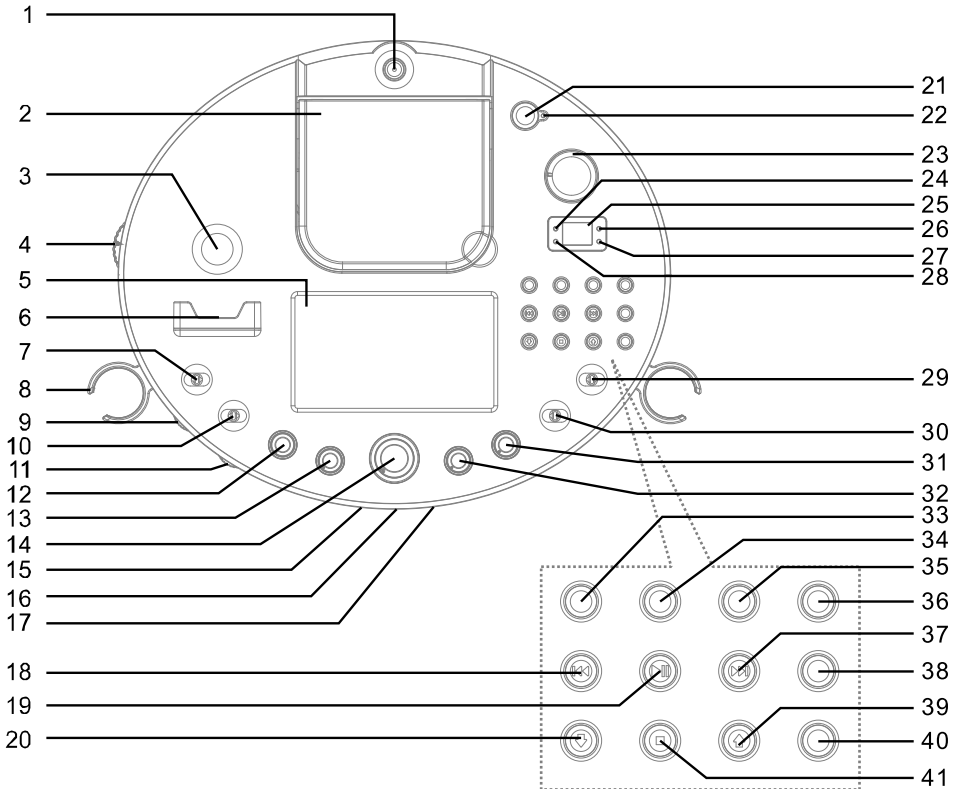

FRONT VIEW

- | | | |
|----------------------------|---------------------------------|---------------------------------|
| 1. Adjustable Camera Lens | 15. MIC 1 Jack | 29. BAND Selector |
| 2. CD Door | 16. HEADPHONE Jack | 30. Monitor Selector |
| 3. iPod support | 17. MIC 2 Jack | 31. AUTO VOICE CONTROL |
| 4. iPod adjustment knob | 18. SKIP ◀◀ (KEY/ECHO) - button | 32. MIC 2 Volume control |
| 5. 7" TFT LCD Color screen | 19. PLAY/PAUSE button | 33. PROGRAM button |
| 6. iPod Docking Station | 20. MENU DOWN button | 34. REPEAT button |
| 7. Function Selector | 21. ON/OFF button | 35. RANDOM button |
| 8. Mic Holder | 22. ON/OFF LED | 36. KEY button |
| 9. COLOR control | 23. TUNING knob | 37. SKIP ▶▶ (KEY/ECHO) + button |
| 10. VIDEO OUT Selector | 24. PROGRAM LED | 38. ECHO button |
| 11. BRIGHTNESS control | 25. LED Display | 39. MENU UP button |
| 12. BALANCE control | 26. PLAY/PAUSE LED | 40. SELECT button |
| 13. MIC 1 Volume control | 27. CDG LED | 41. STOP/MENU button |
| 14. MASTER VOLUME control | 28. REPEAT LED | |

CONTROL LOCATIONS

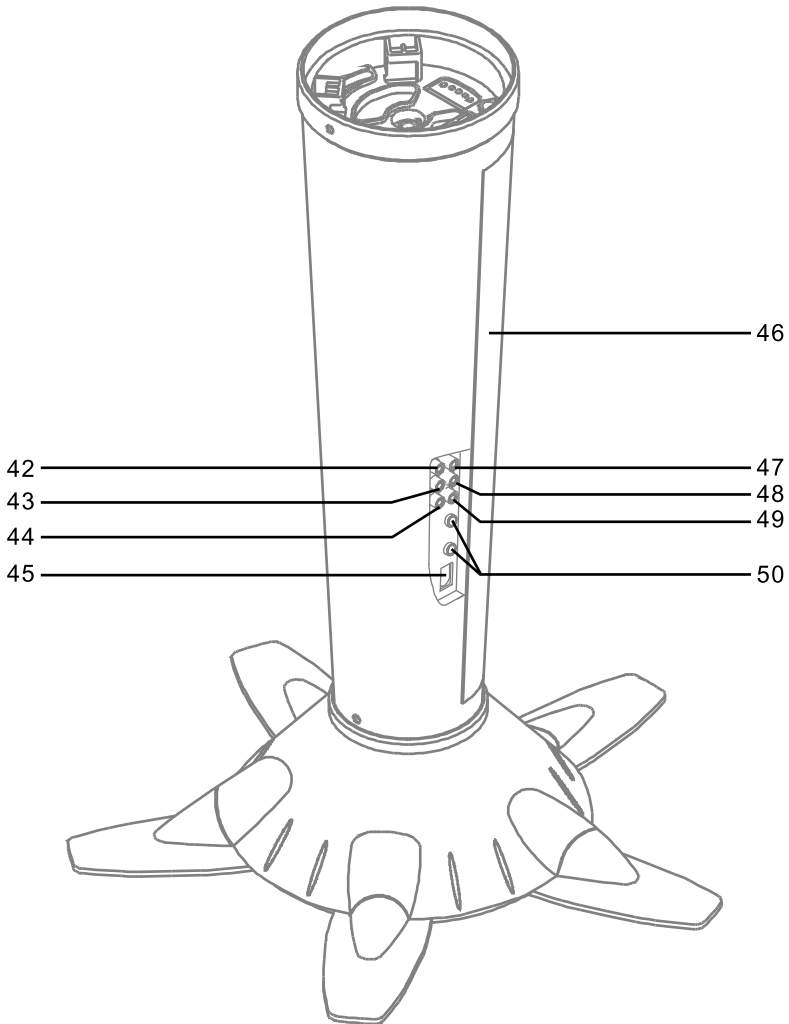

SIDE VIEW

- 42. VIDEO IN Jack
- 43. AUX IN Jack (L)
- 44. AUX IN Jack (R)
- 45. AC Power Cord Jack
- 46. Pedestal

- 47. VIDEO OUT Jack
- 48. AUX OUT Jack (L)
- 49. AUX OUT Jack (R)
- 50. Speaker Jacks (R/L)

MAKING THE CONNECTIONS

CONNECTING POWER

Plug the supplied AC power cord into the AC jack that is located on the side panel of the product and plug the other end into a standard AC socket.

CAUTION: The supplied AC power cord has a polarized plug that fits into the wall outlet only one way. If the plug does not fit properly, turn it over and try again. Do not force it.

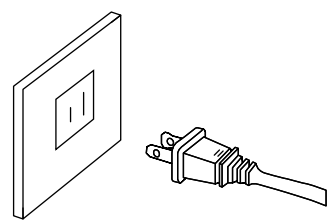

CONNECTING TO YOUR TV OR VCR/DVD PLAYER

Your Singing Machine is designed to connect to your TV the same way you would connect most video cameras, VCR/DVD players or video game consoles.

We have provided RCA cables to connect your unit to a TV, VCR/DVD player, video device or an external audio/sound system. The RCA cables have three connections at each end (white and red are for left and right audio connections and the yellow is for video connection).

Please follow the steps below to display CD+G lyrics on the TV screen:

- (1) Locate the multi-colored RCA cables
- (2) Connect video cable (yellow) to the VIDEO OUT on the side of the Singing Machine
- (3) Connect the other end of the video cable (yellow) to the video input on your TV or VCR/DVD Player

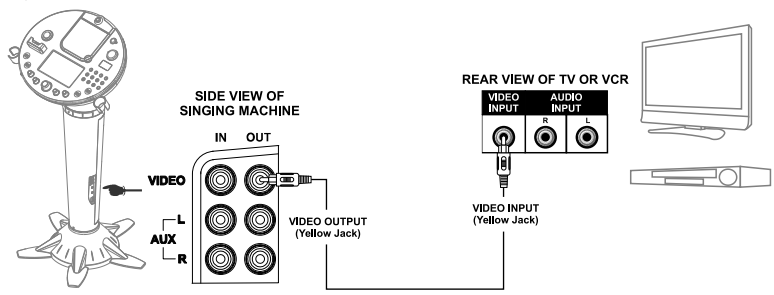

CONNECTING A VIDEO COMPONENT FOR INPUT

Please follow the steps below to display CDG lyrics on the Singing Machine's monitor from another video source:

- (1) Locate the multi-colored RCA cables
- (2) Connect video cable (yellow) to the VIDEO IN jack on the side of the Singing Machine
- (3) Connect the other end of the video cable (yellow) to the video output on another video source such as a VCR.
- (4) Set the Function selector to AUX mode and the Monitor Selector to AUX.

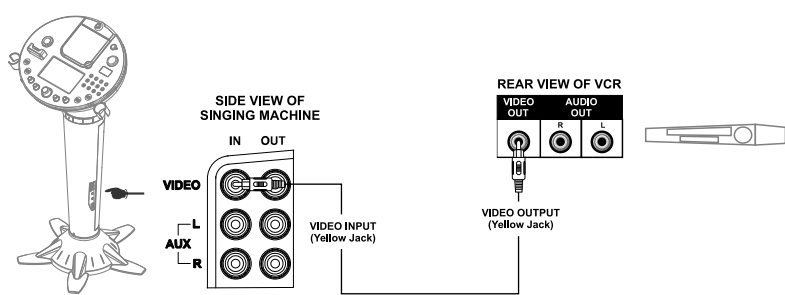

MAKING THE CONNECTIONS

SELECTING YOUR SINGING MACHINE AS YOUR SOURCE/INPUT

Selecting your Singing Machine as a source/input on your TV is very similar to connecting a VCR/DVD or Satellite system.

We've listed below the most common ways of selecting the source from your TV or VCR/DVD Player:

- (1) In the set up menu of the TV or VCR/DVD player there may be an option for "Input Select" where you can choose between "Cable/Ant., Video 1, Video 2, etc." as the input source.
- (2) Look for a TV channel between the highest and lowest channel on your TV or VCR/DVD player (i.e. AUX, EXT, LINE 1 or LINE IN)
- (3) Your remote control for either your TV or VCR/DVD player may have source input selections as detailed below:
"VIDEO, VIDEO 1, GAME, AUX, EXT or LINE-IN." Choosing one of those in most cases should display the lyrics from your Singing Machine as well.

AUDIO CONNECTION

Please follow the steps below to connect the unit to your TV or VCR or home stereo system:

- (1) Locate the multicolored patch RCA cords.
- (2) Connect audio cables (White and Red) to the Audio Out (White-Left and Red-Right) on the side of the Singing Machine.
- (3) Connect the other end of the audio cables to the audio/auxiliary input on your TV or VCR or home stereo system.

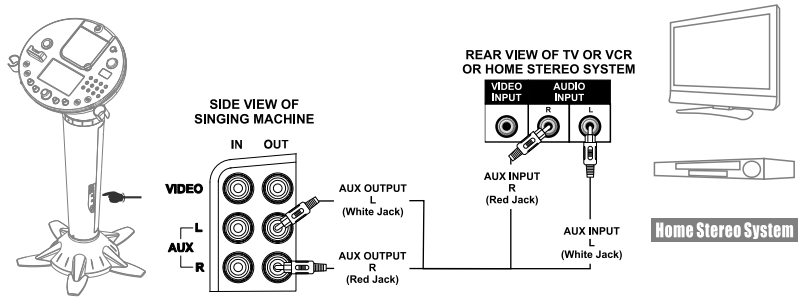

CONNECTING AN AUDIO COMPONENT FOR INPUT

To connect another audio source (such as a Tuner, an AV Receiver or a VCR) so you can sing along with its music, simply connect the Audio Output jacks (Red & White RCA jacks) to the Singing Machine's AUX IN L & R jacks.

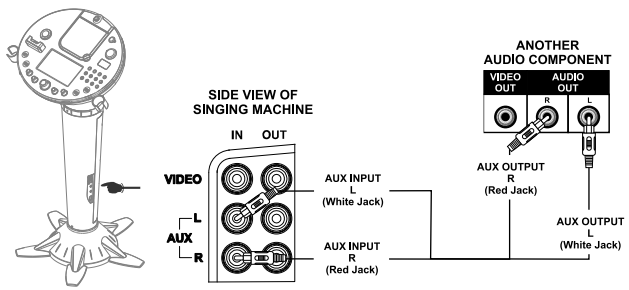

MAKING THE CONNECTIONS

MONITOR SELECTOR

- To display CDG lyrics/iPod Video/a video signal from another A/V component, set the Monitor Selector to CDG/iPod/AUX mode.
- To display your image on the Singing Machine's monitor, set the Monitor Selector to CAMERA mode.
- To turn off the TFT LCD on the Singing Machine, set the Monitor Selector to OFF mode.
- Adjust the COLOR and BRIGHTNESS controls of the Singing Machine for the best picture quality. (#9 and #11 noted on the control locations on page E7)

VIDEO OUT SELECTOR

- To display your image on the TV, set Function Selector to either iPod, CDG or AUX position and set the Video Out Selector to CAMERA mode.
- To display CDG lyrics/iPod Video/another A/V component on the TV, set Function Selector to CDG/iPod/AUX position and set the Video Out Selector to CDG/iPod/AUX mode.

CONNECTING TO THE TOWER SPEAKERS



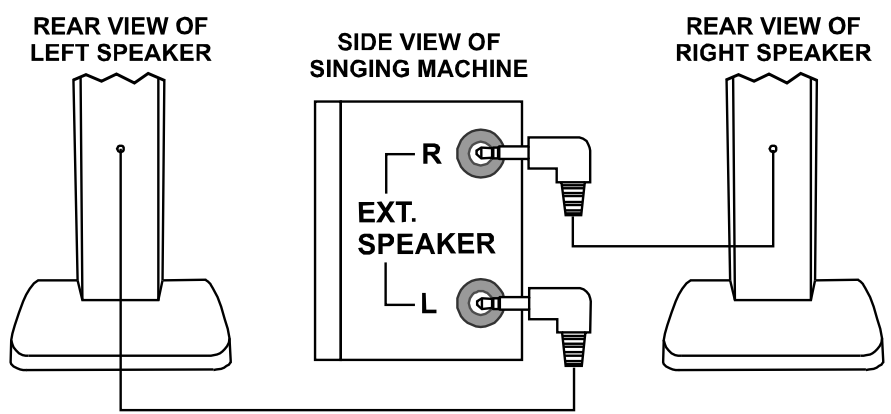











1. Before connecting the tower speakers, turn off the Singing Machine and adjust both the Master Volume and Mic Volume to minimum.
2. Connect the tower speakers to the Singing Machine according to the illustration below.
3. Power the ON/OFF button to ON. Adjust both the Master Volume and Mic Volume on your Singing Machine to a comfortable level.

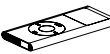

MAKING THE CONNECTIONS

iPod DOCKING

Your Singing Machine comes with an iPod connector which is compatible with the following iPod models. Note: This docking is not compatible with iPod shuffle models as they do not have a dock connector.

iPod®	Type	Memory	iPod Support Level
	iPod® mini	4GB & 6GB	C
	iPod® photo & Color U2 iPod®	20GB & 30GB	C
	iPod® with color display	20GB	C
	iPod® photo & Color U2 iPod®	40GB & 60GB	A
	iPod® with color display	60GB	A
	iPod® nano	2GB & 4GB	E
	5G iPod® with video, U2 iPod® with video	30GB	D
	5G iPod® with video	60GB & 80GB	B
	iPod® nano (2 nd generation)	2GB & 4GB & 8GB	E
	iPod® nano (3 rd generation)	4GB & 8GB	E
	iPod® nano (4 th generation)	8GB & 16GB	E
	iPod® touch	8GB & 16GB	D
	iPod® touch (2 nd generation)	8GB & 16GB & 32GB & 64GB	D
	iPod® classic	8GB & 120GB	D
	iPod® classic	160GB	B

MAKING THE CONNECTIONS

DOCK IPOD (iPod not included)

It is recommended to dock your iPod according to the following steps. Please refer to E12 to find your own iPod support level.

1. Adjust the iPod to the proper level by rotating the iPod adjustment knob.
2. Dock your iPod on the Singing Machine iPod connector. It is now ready to play.

CAUTION: - *DO NOT force the iPod docked on the iPod connector if there is an obstruction.*
- *Please remove your iPod protective case before docking.*

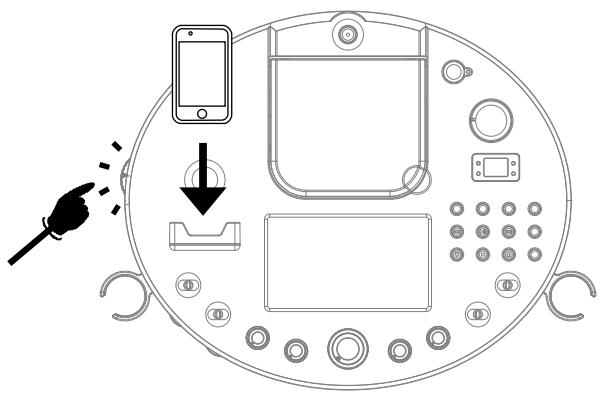

CONNECTING TO YOUR HEADPHONES

A headphone jack is provided to use headphones instead of the built-in speakers. (Headphones are sold separately.)

WARNING: *Excessive sound pressure from headphones can cause hearing loss.*

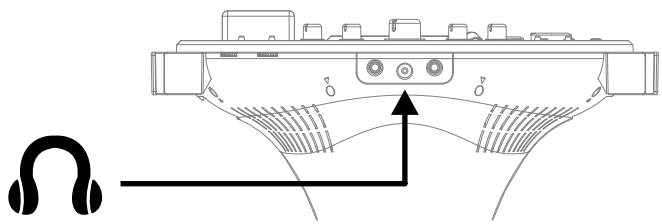

CD OR CD+G OPERATION

This unit is designed to play CDs and CD+Gs bearing the identification logo respectively. If the disc does not conform to the standard, it may not play properly.



TURNING POWER ON/OFF

- To turn on the unit, press the ON/OFF button, the ON/OFF LED Indicator will light up.
- To turn it off, press the ON/OFF button again, the ON/OFF LED Indicator will turn off.

FUNCTION SELECT

Set the FUNCTION SELECTOR switch to CDG.

LOADING A DISC

- Open the CD door, place a CD or CD+G disc in the compartment with the printed side facing upward and the shiny side facing down.
- Gently close the CD door. The LED window will display the total number of tracks. (If no disc is loaded, it will display "no". If a CDG is loaded, the CDG indicator will light up.)

Note: - Never place anything except a compact disc in the disc tray. Foreign objects can damage the unit.
- Only place one disc on the disc tray at a time.

(Refer to the Trouble Shooting Guide "If a disc is loaded but the total tracks do not appear".)

PLAY/PAUSE

- Adjust MASTER VOLUME control on your unit to adjust TV or audio system to a comfortable level.
- To start playing, press the PLAY/PAUSE button. The first track [1 1] and the PLAY/PAUSE LED light up.
- To temporarily stop playing, press the PLAY/PAUSE button. The PLAY/PAUSE LED Indicator will flash.
- To resume play, press this button again.

Note: - Pressing pause repeatedly when a CD+G is playing may cause distorted lyrics on your TV screen. Any distortion will remain on the TV screen until it is refreshed either during an instrumental break or when the song is stopped and/or when the song is started from the beginning.

STOP

If the STOP button is pressed in the course of playing, the disc will cease to play. (The total number of tracks will be shown on the LED window.)

MASTER VOLUME

Rotate to the MASTER VOLUME control to obtain the desired sound level.

Note: When using the microphone, the MIC Volume must be adjusted simultaneously with the master volume level.

SKIP (For both CD and CDG discs)

- During STOP mode, you can skip forward or back to your desired track number by pressing the SKIP buttons (◀◀ - SKIP - ▶▶).
- To resume playing the selected song, press PLAY/PAUSE button.

SEARCH (For audio CD disc only)

When playing any audio CD, press and hold the SKIP button (◀◀ -SKIP- ▶▶), The CD will search at high speed in the forward or backward direction. Normal play will continue when you release the button.

CD OR CD+G OPERATION

REPEAT

- To repeat the track currently playing, press the REPEAT button once. The REPEAT LED will start to flash.
- To repeat all tracks, press the REPEAT button twice. The REPEAT LED will light up and stay lit. Press the PLAY/PAUSE button to begin.
- To clear the REPEAT function, press the REPEAT button again. The REPEAT LED will turn off.

PROGRAM

- Use this button to program and play songs in a preselected order.
 - Step 1: Programming should be done in the stop mode only. Press the PROGRAM button until the PROGRAM LED flashes. The track will read [0].
 - Step 2: Press the SKIP buttons (◀◀ - SKIP - ▶▶) to select a desired track.
 - Step 3: Press PROGRAM button to confirm entry. You can repeat the same steps up to a maximum of 20 tracks.
 - Step 4: Press PLAY button when you have completed programming and you are ready to start singing.
- Press the STOP button to clear all the programmed entries.

RANDOM

- Press the RANDOM button to activate the random play function. Press play to start the random play.
- Press the STOP button to clear the random function.

iPOD OPERATION

FEATURES FOR YOUR IPOD

- Play video content of your iPod on the 7" widescreen TFT screen.
- Capable of displaying your favorite videos on your iPod to your TV.
- Capable of playing and singing along with your favorite songs on your iPod.
- Control your iPod through your Singing Machine control panel.
- Charge your iPod.

FUNCTION SELECT

Set the FUNCTION SELECTOR switch to iPod.

WATCHING YOUR IPOD VIDEOS ON THE 7" COLOR LCD TFT SCREEN

Set the MONITOR selector to the CDG/iPod/AUX position and follow the instructions below:

1. On the menu screen of your iPod, select the "Videos" option.
2. On the next menu screen, select the "Video Settings" option.
3. On the next menu screen, select the "TV Out" option and set it ON.
4. Install your iPod on the iPod dock.
5. Navigate the menu screen of your iPod to your favorite video.
6. Play the video file and watch it on the 7" color LCD screen.

WATCHING YOUR IPOD VIDEOS ON YOUR TV

Connect your TV to The Singing Machine VIDEO OUT jack and set the VIDEO OUT switch to CDG/iPod/AUX.

PLAYING YOUR FAVORITE SONGS ON YOUR IPOD

After installing your iPod, you can play your favorite songs using the iPod click wheel or Singing Machine control panel.

NOTE: Different iPod models may have different operations. Please refer to your iPod user manual.

KARAOKE FUNCTIONS

Karaoke functions can be performed on CDG/iPod/AUX function modes. Sing along with the music by plugging in the provided microphone into either one of the microphone jacks on the unit.

* **Warning - Tapping or dropping the microphone while it is on can permanently damage your microphone. Resist the urge to swing the microphone around by the cord!**

MIC VOLUME

Adjust the MIC VOLUME control to a desired level to obtain the best performance. (MIC 1 and MIC 2 volume can be adjusted separately.)

* **Warning - To avoid microphone feedback please avoid holding the microphone too close to the speaker.**

ECHO

Press the ECHO button once then press the SKIP (KEY/ECHO) (- / +) buttons to adjust the ECHO effect (Level: 0 to 8) to enhance the singers' voice for a concert hall effect.

KEY CONTROL

Press the KEY button once then press the SKIP (KEY/ECHO) (- / +) buttons to adjust the KEY control (Level: -4 to 4) to obtain the best key for the singers' performance.

BALANCE

Adjust the BALANCE control between the prerecorded singer's voice and the music when using a multiplex karaoke disc. (Please see Glossary of terms on our website to learn more about multiplex.)

KARAOKEVISION™

During the CDG/iPod/AUX function mode, KARAOKEVISION™ can be switched on for real-time performance to appear on the Singing Machine's screen.

1. Adjust the camera lens up or down to the desired angle.
2. Set the Monitor to the CAMERA. Your image will display on the built in screen.
3. To focus the camera display, rotate the camera lens until a clear image appears on screen.

Note:

- Camera video output can be connected through the VIDEO OUT jack and setting VIDEO OUT selector to CAMERA.

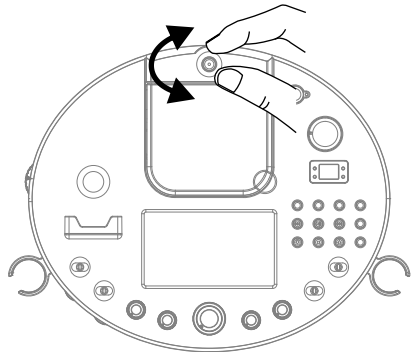

RADIO FUNCTION

FUNCTION SELECT

Set the FUNCTION SELECTOR switch to RADIO.

AM/FM RADIO

1. Switch Band Selector to either AM or FM radio position.
2. Turn the tuning knob to select desired station indicated on dial.
3. Adjust Master Volume to the desired level.

Note: There is no microphone or karaoke function on Radio function.

TROUBLE SHOOTING GUIDE

If you have followed the instructions and are having difficulty operating the unit, locate the **PROBLEM** in the left column below. Check the corresponding **POSSIBLE CAUSE** column to locate and remedy the problem.

PROBLEM	POSSIBLE CAUSE	SOLUTION
No power when ON/OFF button is on.	No power plug connection at the AC outlet.	Insert the power plug into the AC outlet.
No power when plugged in.	The AC outlet may not have power.	Check the outlet with a working lamp or other electrical appliance.
	AC plug is not secure on the back of the unit.	Securely plug cord into the back of the unit.
No sound.	Volume control is set to minimum.	Turn up the volume.
	Volume control on TV set/PA system is set to minimum.	Turn up the volume on TV/PA system.
	TV set/PA system power is OFF.	Turn on the power on TV/PA system.
	AUX OUT jacks not connected.	Follow directions on the "Audio Connection" page.
CD PLAYER does not work normally or the LED displays "--", "UN", or "NO".	Disc is inserted upside down.	Insert disc correctly.
	Disc is dirty.	Wipe clean with soft cloth.
	Disc is scratched.	Use a new disc.
	Disc is warped.	Use a new disc.
	A nonstandard disc is inserted.	Only use discs bearing standard logo.
	Lens is dirty.	Use a CD lens cleaner.
	Moisture has formed inside the CD deck.	Wait about 20 to 30 minutes to let it dry out.
Singing Machine needs to be reset.	Disconnect the machine from power source for 30 seconds.	

TROUBLE SHOOTING GUIDE

PROBLEM	POSSIBLE CAUSE	SOLUTION
No sound when audio is going through TV, VCR or home stereo.	Source Selection on your TV, VCR or home stereo is not set properly.	Select AUX IN as the source for your TV, VCR or home stereo.
	Improper Connection to stereo system or PA.	Follow directions on the "Audio Connection" page for connecting to a home stereo system.
No song lyrics appear on the TV screen.	Video cable is not connected properly to the TV.	Connect the video cable to the Singing Machine's VIDEO OUT and to the TV VIDEO IN.
	Source selector on TV is not set to VIDEO.	Using your TV Remote to select VIDEO input.
	TV does not have video line input.	Connect from VIDEO OUT of the system to the VIDEO IN on your VCR or Connect to an RF Modulator and then to the TV cable input. Check the disc to be sure it is a CDG.
	A CDG is loaded but the CDG indicator is not lit.	Check disc to be sure it is clean.
No sound from mic.	Mic volume control.	Adjust mic volume to max, and then re-adjust to a comfortable level.
	Mic is off.	Turn on mic with the ON/OFF switch located on the microphone.
While playing a CDG and singing with the microphone, the music or vocals cut out.	AVC is activated to Maximum.	Adjust AVC to Minimum.
	You are playing a music only track.	Play track that includes music and vocal.
Music and Vocals are playing at a high speed.	Key control is set to +4.	Adjust key control to 0.
While playing a CDG track with music and vocals, only music or vocals play.	Balance is set either to the left or right.	Adjust balance to mid point.

TROUBLE SHOOTING GUIDE

PROBLEM	POSSIBLE CAUSE	SOLUTION
Camera image is blurry.	Camera has not warmed up.	Wait a minute for the camera to warm up.
	Camera lens is dirty.	Clean the camera lens.
	Camera lens is out of focus.	Adjust the lens of the camera by slightly rotating either left or right until the display is clear. Do not overturn the lens.
No image displays on the monitor when attempting to use the camera function.	Monitor selector is not set properly.	Set MONITOR Selector to CAMERA mode.
	Lens cap is ON.	Remove lens cap.
	Brightness control not adjusted properly on the Singing Machine.	Adjust Brightness control on the Singing Machine.

SPECIFICATIONS

AUDIO SECTION: TOWER SPEAKER OUTPUT POWER (MAXIMUM) OUTPUT IMPEDANCE	7 WATTS (RMS) 3 OHMS
CD PLAYER SECTION: FREQUENCY RESPONSE SIGNAL - TO - NOISE RATIO NUMBERS OF PROGRAMS SAMPLING SYSTEM	100 Hz - 20 KHz 50dB (A-WTD) 20 STEPS RANDOM ACCESS PROGRAMMING 8 TIMES OVER SAMPLING
MONITOR SECTION	7" COLOR TFT LCD SCREEN NTSC SYSTEM
RADIO SECTION: AM FREQUENCY RANGE FM FREQUENCY RANGE	530 - 1710 KHz 88 - 108 MHz
MICROPHONE	-74dB 600 OHMS IMPEDANCE WITH Ø 6.3mm DYNAMIC MICROPHONE
POWER SECTION	AC 110V-120V~60Hz
DIMENSIONS (W x D x H): MAIN UNIT TOWER SPEAKER	18.7 x 17.9 x 37.9 inches / 47.5 x 45.5 x 96.3 cm 7.5 x 7.7 x 26.8 inches / 19.0 x 19.5 x 68.0 cm
WEIGHT: MAIN UNIT TOWER SPEAKER	13.2 lbs / 6.0 kgs 5.3 lbs / 2.4 kgs

Specifications are typical, individual units might vary. They are subject to continuous improvement without notice and without incurring any obligation.

THE SINGING MACHINE KARAOKE GLOSSARY OF TERMS

In addition to all of the terminology associated with consumer electronics products, a few additional terms are used almost exclusively in karaoke. These terms are meant to familiarize you with the world of Karaoke. The features listed below **may not** necessarily pertain to the particular model Singing Machine that you have. The following are some brief explanations of karaoke terms:

Echo:

Echo adds depth and resonance to a singer's voice without affecting the music. This echo is produced by creating minor controlled feedback in the singer's voice.

Multiplex:

Our multiplex recordings contain 2 copies of the same song. One version is a stereo recording of the song without the lead singer. The second version is recorded with the music and background vocals on the left channel and the lead singer recorded on the right channel. This 'split track' recording allows you to control the volume of the lead singer by adjusting the balance control. You can sing a duet with the lead singer or use the lead singer as a guide as you learn the song, gradually fading them out with the balance control until you are able to sing the song on your own.

Auto Voice Control (A.V.C.):

When the AVC function is activated, the vocals on a multiplex recording are eliminated as soon as the singer begins singing into the microphone. When the singer stops singing, the vocals on the multiplex recording are automatically re-activated. This useful function is used primarily during practice sessions while a singer is learning a song. Please note that the AVC function only works with multiplex recordings and not with standard audio recordings.

Pitch Control:

This function controls pitch of music by controlling the speed at which a cassette tape plays back. By increasing the speed of the tape, the music sounds higher (sharp). By decreasing the speed of the tape, the music sounds lower (flat).

Key Controller:

Key Controller changes the key of the CD/CDG music (+ or - steps) to adjust to the singer's voice.

CDG:

This is an acronym for Compact Disc plus Graphics. You will also see variations CD+G, and CD+Graphics. This is a regular audio CD with information stored on a data track simultaneous to music. In laymen's terms, CDG has a video output for simple graphics (not full motion video). In the case of karaoke, the graphics function is used to store song lyrics, and display the lyrics in sync with music. In most cases, CDG software displays lyrics which change color as they are to be sung. A regular television is all that is required to display CDG lyrics.

NOTE - CDG is a particular type of compact disc encoding system that is different from VCD or DVD. Your Singing Machine can decode standard audio compact discs and CDG discs. It will not read VCD or DVD encoded discs.

Standard audio discs and cassette tapes will not display lyrics on your TV. Audio CDs do not contain the software necessary to display lyrics.



The Singing Machine Company, Inc. d/b/a
SMC GLOBAL INC.

1028N-1008-ENG02

6601 Lyons Road, Suite A7, Coconut Creek, FL33073-9902, USA.
TEL: (954) 596-1000 FAX: (954) 596-2000

PRINTED IN CHINA

VISIT OUR WEBSITE www.singingmachine.com

Free Manuals Download Website

<http://myh66.com>

<http://usermanuals.us>

<http://www.somanuals.com>

<http://www.4manuals.cc>

<http://www.manual-lib.com>

<http://www.404manual.com>

<http://www.luxmanual.com>

<http://aubethermostatmanual.com>

Golf course search by state

<http://golfingnear.com>

Email search by domain

<http://emailbydomain.com>

Auto manuals search

<http://auto.somanuals.com>

TV manuals search

<http://tv.somanuals.com>