

Care & Use Manual



for
Thermador Built-In Ovens

Models
C302, C272
C301, C271

Thermador[®]

*A Special Message
to Our Customers*

Thank you for buying a Thermador oven. We recommend that you take the time to read this entire booklet before using your new appliance.

We hope that the information in this manual will help you easily operate and care for your oven for years of satisfaction.

Please contact us if you have any questions or comments. Phone us at 1-800-735-4328 or write to us at:

Customer Support Call Center
Thermador
5551 McFadden Avenue
Huntington Beach, CA 92649

Sincerely,

Thermador Test Kitchen Consumer Scientists

Table of Contents

Important Safety Instructions. 2-3

General Appliance and Oven Safety Features	2
---	---

Oven Features 4-9

Features of Your Oven.....	4
Oven Control Features	5
UsingThe Control Panel	6
Child Lockout/Panel Lock	6
Sights & Sounds	7
Voltage Connection	7
Oven Modes.....	8
General Oven Tips.....	9

Oven Operations 10 - 27

Setting the Clock	10
Setting the Lights.....	10
Setting the Timer	11
Bake	12
Baking Chart	13
Convection Mode Operation.....	14
Convection Chart	15
Convection Bake Mode Operation.....	16
Convection Bake Chart	17
Roast Mode Operation	18
Roasting Chart.....	19
Convection Roast Mode and Probe Operation.....	20
Convection Roast Chart	21
Broil and Convection Broil Mode Operation	22
Broil Chart	23
Convection Broil Chart	23
Proof Mode Operation.....	24
Dehydrate Mode Operation	25
Timed Oven Feature Operation	26
Setting the Sabbath Mode	27

Care and Cleaning..... 28-31

Self Cleaning The Oven.....	28
Self Clean Mode	29
Oven Cleaning Chart	30
Oven Finishes/Cleaning Method	31

Do-It-Yourself Maintenance .. 32-34

Removing the Oven Door	32
Replacing the Oven Light	33
Changing to 24-Hour Clock.....	33
Changing to Centigrade	34
Calibrating Oven Temperature.....	34

Problem Solving 35-36

Solving Baking Problems	35
Solving Operational Problems	36

Consumer Service 36

How to Obtain Service	36
Thermador® Warranty	37
Service Data Record	37

General Appliance and Oven SAFETY PRECAUTIONS

Please read all instructions before using this appliance.



WARNING

When properly cared for, your new Thermador oven has been designed to be a safe, reliable appliance. Read all instructions carefully before using this oven. These precautions will reduce the risk of burns, electric shock, fire, and injury to persons. When using kitchen appliances, basic safety precautions must be followed, including the following:

- This appliance must be properly installed and grounded by a qualified technician. Connect only to properly grounded outlet. See "Grounding Instructions" found in the Installation Instructions.
 - This appliance should be serviced only by qualified service technician. Contact the nearest **authorized service center** for examination, repair or adjustment.
 - **Do not** repair or replace any part of the oven unless specifically recommended. Refer service to an authorized servicer.
 - **Do not** operate this appliance if it is not working properly or if it has been damaged, until an authorized servicer has examined it.
 - Install or locate this appliance only in accordance with the Installation Instructions.
 - Use this oven only as intended by the manufacturer. If you have any questions, contact the manufacturer.
 - **Do not cover** or block any openings on this appliance.
 - Use this appliance only for its intended use as described in this manual. Do not use corrosive chemicals, vapors, or nonfood products in this appliance. This type of oven is specifically designed to heat or cook. It is not designed for industrial or laboratory use. The use of corrosive chemicals in heating or cleaning will damage the appliance.
 - In the event that personal clothing or hair catches fire, DROP AND ROLL IMMEDIATELY to extinguish flames.
- **Do not** allow children to use this appliance, unless closely supervised by an adult. Children and pets should not be left alone or unattended in the area where the appliance is in use. Never allow children to sit or stand on any part of the oven.
 - **Do not** store items of interest to children above the oven. If children should climb onto the appliance to reach these items, they could be seriously injured.

To reduce the risk of fire in the oven cavity:

1. **Do not** store flammable materials in or near the oven.
2. **Do not** use water on a grease fire. Smother fire or use a dry chemical or foam-type extinguisher.
3. It is highly recommended that a fire extinguisher be readily available and highly visible next to any cooking appliance.
4. **Do not** overcook food. Carefully attend oven if paper, plastic or other combustible materials are placed inside the oven.
5. **Do not** use the cavity for storage purposes. Do not leave paper products, cooking utensils or food in the cavity when not being used.
6. If materials inside the oven should ignite, keep oven door closed. Turn oven off and disconnect the circuit at the circuit breaker box.
7. **Do not** block any vent openings.
8. Be sure the blower fan runs whenever the oven is in operation. If the fan does not operate, **do not** use the oven. Call an authorized service center.
9. Never use the oven to warm or heat a room. This can damage the oven parts.
10. For personal safety, wear proper clothing. Loose fitting or garments with hanging sleeves should never be worn while using this appliance.

Continued on next page

IMPORTANT SAFETY INSTRUCTIONS

Please read all instructions before using this appliance.

SAFETY FOR THE OVEN

- Tie long hair so that it doesn't hang loose.
- Do not touch heating elements or interior surfaces of oven.
- The heating elements may be hot even though they are dark in color. Interior surfaces of an oven become hot enough to cause burns.
- During and after use, do not touch or let clothing or other flammable materials contact the heating elements or the interior surfaces of the oven until they have had sufficient time to cool.
- The trim on the top and sides of the oven door may become hot enough to cause burns.
- Use care when opening the door. Open the door slightly to let hot air or steam escape before removing or replacing food.
- Do not heat unopened food containers. Build-up of pressure may cause the container to burst and result in injury.
- Always place oven racks in desired location while oven is cool. If a rack must be moved while oven is hot, do not let potholder contact the hot heating elements.
- Use only dry pot holders. Moist or damp pot holders on hot surfaces may result in burns from steam. Do not let pot holder touch hot eating elements. Do not use a towel or other bulky cloth.

SAFETY FOR THE SELF-CLEANING OVEN

- Confirm that the door locks and will not open once START is touched and the door lock icon appears. If door does not lock, touch OVEN OFF and do not run Self Clean. Phone 800/735-4328 for service (see Page 36 for obtaining service).
- Do not clean the door gasket. It is essential for a good seal. Care should be taken not to rub, damage, move or remove the door gasket.
- Do not use commercial oven cleaners or oven liner protective coatings of any kind in or around any part of the oven.
- Clean only oven parts listed in this manual.
- Before self-cleaning the oven, remove the broiler pan, oven racks, other utensils and excess soft spillage.
- Listen for fan. A fan noise should be heard sometimes during the cleaning cycle. If no fan is heard, call for service.

WARNING

The California Safe Drinking Water and Toxic Enforcement Act requires businesses to warn customers of potential exposure to substances which are known by the State of California to cause cancer or reproductive harm.

The elimination of soil during self-cleaning generates some by-products which are on this list of substances.

To minimize exposure to these substances, always operate this oven according to the instructions in this manual and provide good ventilation to the room during and immediately after self-cleaning the oven.

Features of Your Oven

MODELS C301, C271
SINGLE OVENS

MODELS C302, C272
DOUBLE OVENS

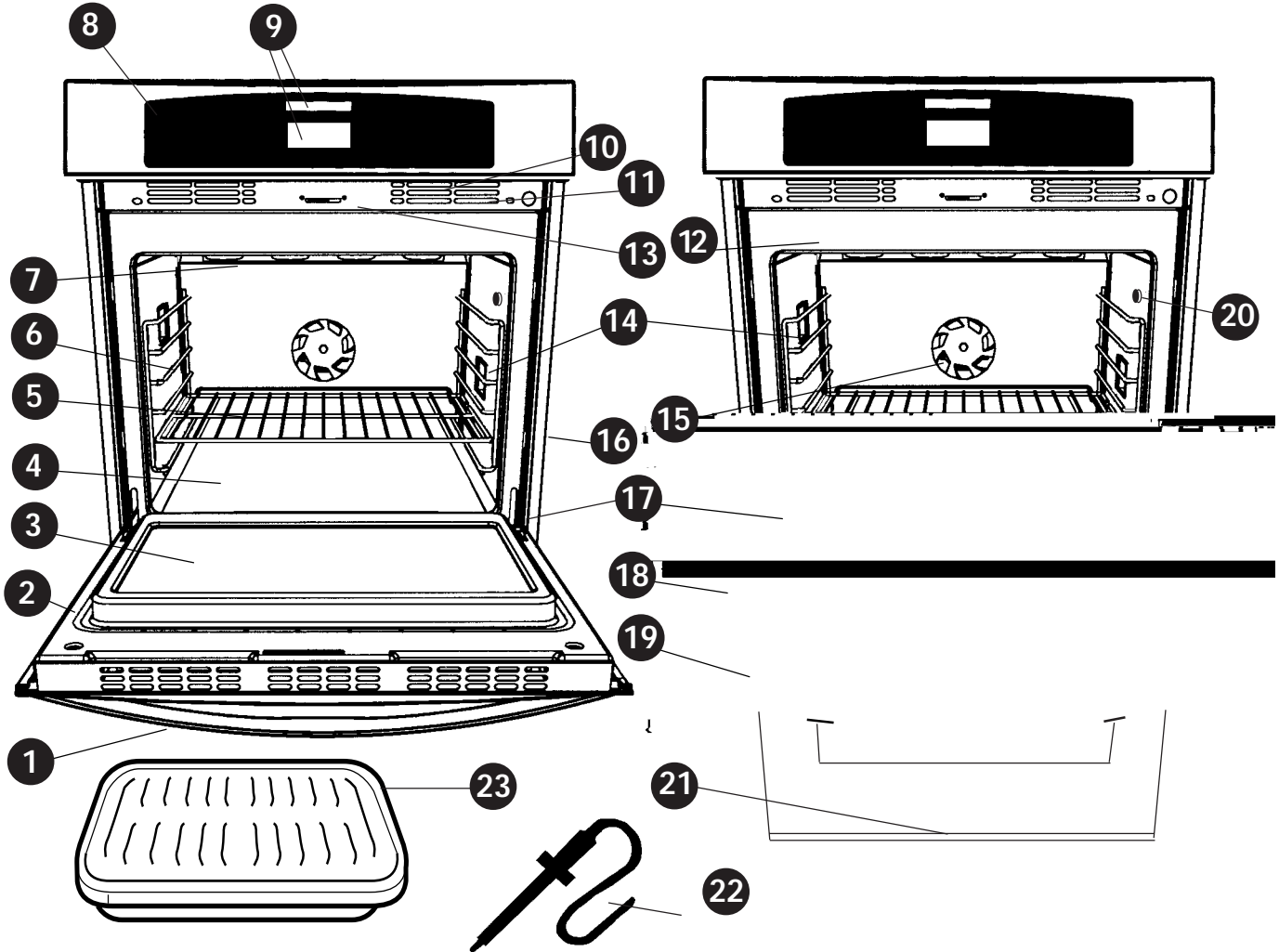

#	Item	#	Item
1	Door Handle	12	Front Frame
2	Oven Door Gasket	13	Automatic Door Lock Latch
3	Window	14	Halogen Oven Lamps (2)
4	Bake Element, under oven floor	15	Convection Fan and Cover
5	Removable Oven Racks	16	Side Trim
6	Rack Supports*	17	Door Hinge
7	Broil Element	18	Removable Door
8	Glass Touch Control Panel	19	Door Cooling Vents
9	Clock/Time Display & Control Display	20	Probe Receptacle
10	Model & Serial No. Location, (look through slot)	21	Vent Trim
11	Oven Cooling Vents	22	Probe
		23	Broiler Pan and Grid

*Rack support positions are numbered from the bottom rack support(#1) to the top (#6). Cooking charts in this manual refer to the recommended rack positions.

Oven Control Features

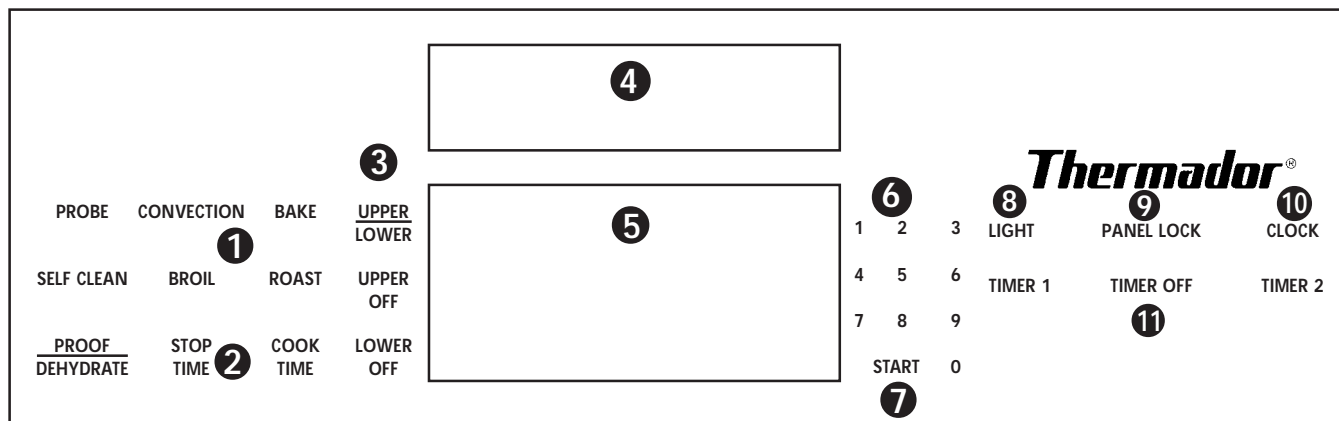

CONTROL MENU

1. Oven Mode Pads

- Probe – selects doneness temperatures.
- Convection – selects the Convection mode and may be used in combination with Bake, Roast or Broil.
- Bake – selects the Bake mode.
- Roast – selects the Roast mode.
- Broil – selects the Broil mode.
- Proof/Dehydrate – touch once to select proof; touch twice to select dehydrate.
- Self Clean – selects a Self-Clean mode.

2. Timed Cooking Pads

- Cook Time – selects the hours to cook.
- Stop Time – selects the time of day the oven is to automatically turn off.

3. Oven Selector Pads

- Upper/Lower – (double oven models only). touch once to select the upper oven; touch twice to select the lower oven.
- Upper Off – turns the upper oven off.
- Lower Off – turns the lower oven off.

DISPLAY WINDOWS

4. Clock

- Displays the time of day.
- Displays timer(s) countdown.
- Displays “Panel Lock” affirmation.

5. Oven

- Displays selected words, numbers and symbols.

NUMBER PADS

- Number pads – 1 to 0 – selects a time of day, temperatures, cook and stop time, or timer(s).
- Start pad – touch this pad last to start cooking modes or timing functions.

LIGHT, PANEL LOCK, CLOCK, and TIMER(S) MENU

- Light – turns oven lights on/off.
- Panel Lock – locks the cooking modes in the off position.
- Clock – selects the time of day on the 12-hour clock.
- Timers
 - Timer 1 – sets a kitchen timer.
 - Timer 2 – sets a second kitchen timer.
 - Timer Off – turns timer(s) off.

SPECIAL FEATURES

- **Sabbath Mode Setting** – complies with some religious requirements.
- **12 or 24 hour clock choice** – clock setting options.
- **Fahrenheit or Centigrade** – temperature setting options.
- **Panel Lock/Child Lockout** – Panel lock prevents any cooking mode from being set when oven is not being used.

Using The Control Panel

The control panel contains a series of electronic touch pads that enable you to set the oven. As you touch these pads, words and numbers appear in the display windows. These word and number displays are called "prompts" and show what has been selected and what must be done next. Touch only one mode or number pad at a time.

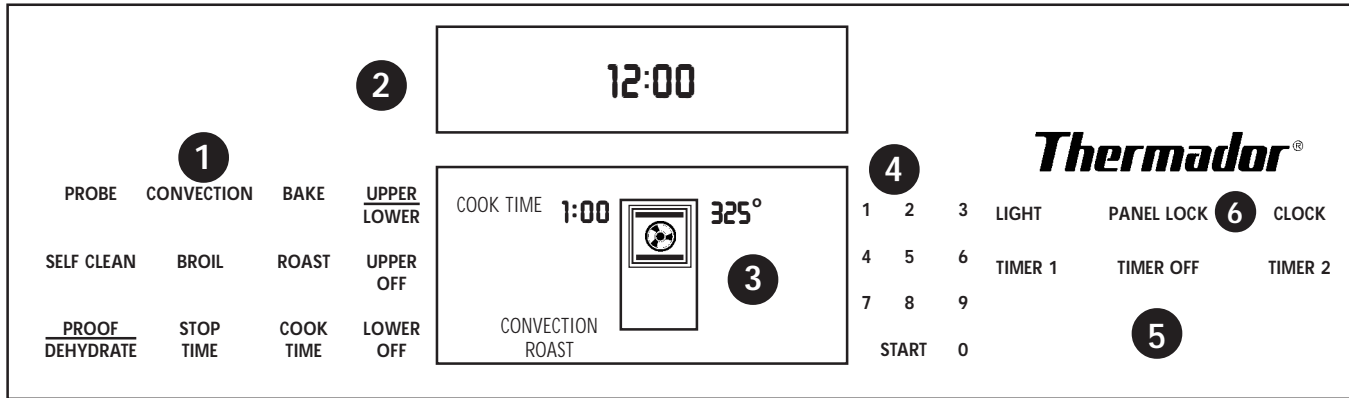

1 CONTROL MENU

These pads set the oven modes and select the oven to be used - in double oven models.

2 CLOCK /TIMER DISPLAY WINDOW

Clock and Timer settings are displayed in this window. The Timer settings countdown in minutes and seconds or in hours and minutes.

3 MODE DISPLAY WINDOW

The settings are shown in this window to verify what has been selected. The display shows the oven selected (in double oven models), cooking or timed mode, elements on in the oven, oven temperature, and the preheat function.

4 NUMBER PADS and START

The number pads select temperatures and time settings in seconds, minutes and hours. It is necessary to select the START pad to complete any mode or timed entry.

5 CLOCK and TIMER MENU

These pads select the Clock and minute Timers that operate independently of any oven mode. These pads control the interior oven lights and Panel Lock.

6 PANEL LOCK/Child Lockout

The Panel Lock is selected to prevent the control pads from being activated when the oven is not being used. Touch and hold for 5 seconds to activate; repeat to cancel.

7 TOUCH 'n' TILT PANEL

This panel is on single oven C301U model only. It can be used in the tilt or flush-to-oven position. Push in along the center, bottom of the panel to release latch and raise panel upward. Push again to release latch and lower the panel.

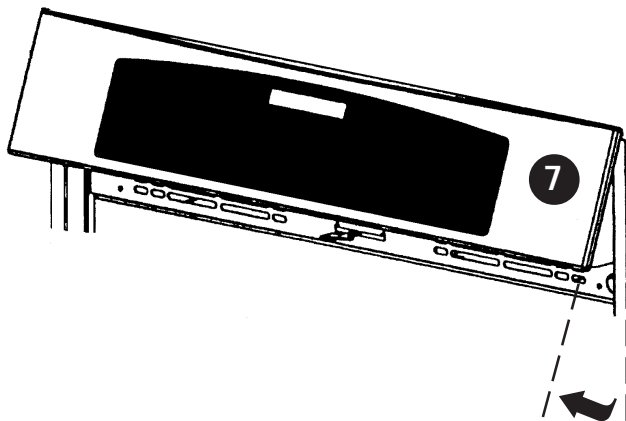

C301U model control panel shown in 20° open position.

Single oven models, C301U and C271U, will have only one oven displayed on the control panel and menu. Instructions and illustrations for double oven models are used throughout this manual.

Interpreting the Control Panel: Sights & Sounds

The directions in the Care and Use Manual for setting the oven and its various modes are based on the assumption that the panel displays and sounds will “lead” or help you set the controls easily. To aid in this path the following descriptions provide a basis for interpreting what is seen and heard.



Flashing Symbols or Numbers

Signals an incomplete setting; calls for another step or START to be touched.

1 Beep

Signals the receipt of an entry.

2 Beeps

Signal an error in entry.

4 Chimes

Signal the end of a setting.

Probe Symbol



Displays the internal temperature of the meat rather than the oven roasting temperature. Oven temperature can be seen briefly by touching the cook mode after touching START.

Lock Symbol



Displays during the Microwave, CookSmart, and Self Clean modes whenever the door is locked. Door can be opened when symbol no longer appears.

PAU

Displays when a Microwave or Cooksmart program is paused or interrupted and door unlocks.

Err

Displays if an invalid temperature or time is entered.

Power Failure

After the power returns to the oven, the clock displays the time when the power was lost or turned off.

120/208 Volt Connection

- Preheat the oven for all cooking modes. Preheat time will be slightly longer.
 - Preheat the broil element with the door open for 3 to 4 minutes or until the top element is red. Do not preheat with the broil pan in the oven.
 - The Self-Clean mode may need a longer clean time than normal, depending on the amount of soil.
-

UPPER

LOWER

(Double oven models only) Selects the active oven to be set by highlighting the oven in the mode display window.

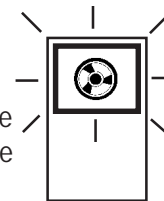

Default Settings

The cooking modes automatically select a suitable temperature. These can be changed when a different one is needed.

START

Touch to complete an entry and before entering an additional one.

UPPER OFF and LOWER OFF

Touch to cancel a mode that has already been started or completed.

COOK TIME

Sets the number of hours and minutes the oven will be “on”. Unlike Timer 1 or 2, the oven turns “off” automatically when the time elapses. This pad is used with the automatic timed oven control.

F Number Codes

These codes are displayed when there is a problem with the signal sent to the electronic control board. See Solving Operational Problems, Page 36.

Convection Fan

Operates during any convection mode. The fan turns off if the door is opened.

Component Cooling Fan

Activates during any cooking or self-cleaning mode to cool inner components and outer door surfaces. This air is exhausted through the vent located below the lower oven in double oven models. It continues to run until components have cooled sufficiently.

Heating Modes Available in Each Oven

The following illustrations give an overview of what happens in the oven with each mode setting. The arrows represent the location of the heat source during specific modes. The lower element is concealed under the oven floor.

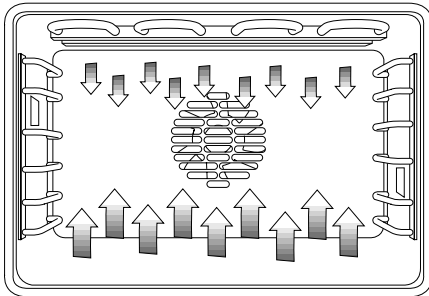

BAKE or PROOF

Baking is cooking with heated air. Both upper and lower elements are used to heat the air and cycle to maintain the temperature. **Proofing**, while similar to bake, holds an optimum low temperature for yeast to rise.

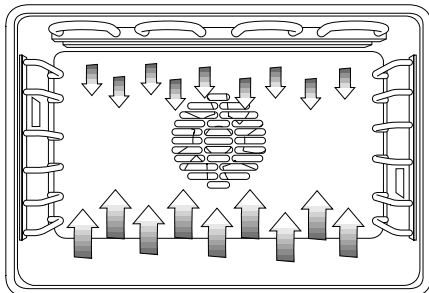

ROAST

Roast has more top heat than bake. This additional top heat is for conventional open roasting when drippings are desired or for covered-dish roasting.

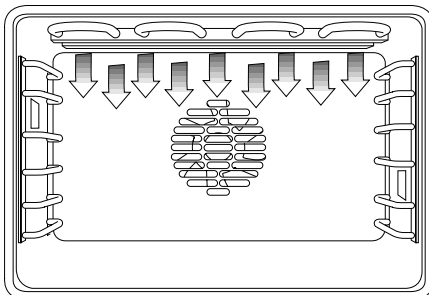

BROIL

Broiling uses intense heat radiated from the upper element to give excellent top browning or searing.

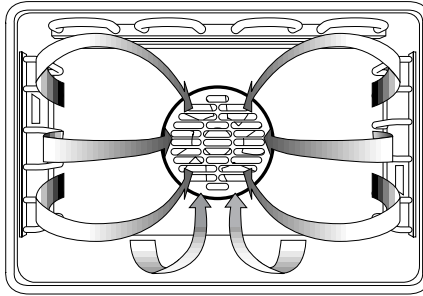

CONVECTION or DEHYDRATE

Convection is cooking with heat from a third element concealed behind the back wall of the oven. It is used with a fan to speed up the circulation of heated air throughout the oven. **Dehydrating** is similar to convection cooking and holds an optimum low temperature while circulating the heated air to remove moisture slowly for food preservation.

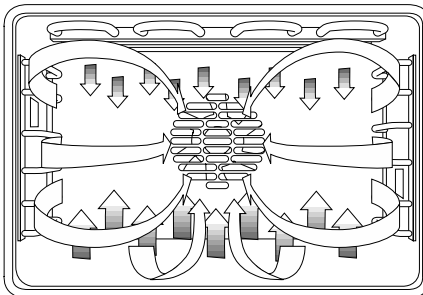

CONVECTION BAKE

Convection Bake has heat from the upper and lower element with circulation assisted by the convection fan. This mode is designed for breads and pastries.

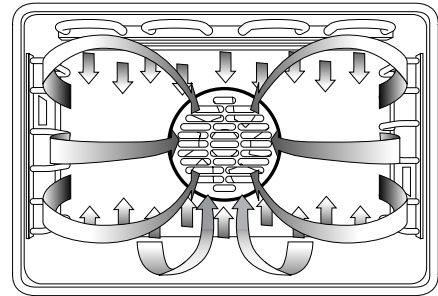

CONVECTION ROAST

Convection roasting combines the heat from the lower concealed element with additional heat from the convection element and fan and the top element. The result is a crispier exterior that seals in the interior juices. It is perfect for roasting tender meats in an uncovered, low-sided pan.

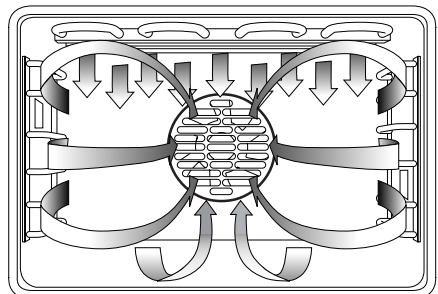

CONVECTION BROIL

Convection broiling combines the intense heat from the upper element with the circulation assisted by convection fan. This air circulation crisps the exterior surface and retains inner moisture in meats more than 1-1/2" thick.

General Tips

PREHEATING THE OVEN*

- Preheat the oven when using the BAKE, CONVECTION and ROAST modes.
- Preheat is not necessary for BROIL and CONVECTION BROIL modes.
- Preheat is optional for CONVECTION ROAST. Preheating is not recommended for CONVECTION ROAST when using the PROBE. A hot oven impairs connecting the meat probe into the receptacle.
- Oven is not preheated for CONVECTION BAKE, to take advantage of the lower heat yielding a better crust on baked items.
- Place racks in the oven before preheating.
- During preheat, the selected cooking temperature is displayed and alternates with a display of the actual oven temperature.
- The oven chimes once when it is preheated and the selected cooking temperature is displayed.

OPERATIONAL SUGGESTIONS

- Use the cooking charts as a guide.
- Do not set pans on the opened oven door.
- Use the interior oven light to view the food through the oven door window rather than opening the door frequently.
- Use TIMER 1 OR TIMER 2 to keep track of cooking times.

UTENSILS

- Reduce oven temperature 25° when baking in glass.
- Use pans that give the desired browning. For tender, golden brown crusts, use light nonstick/anodized or shiny metal utensils.
- For brown, crisp crusts, use dark nonstick/anodized or dark, dull metal utensils or glass bakeware. Insulated baking pans may increase the length of cooking time.
- Do not cook with the empty broiler pan in the oven, as this could change cooking performance. Store the broil pan outside of the oven.
- Tips for "Solving Baking Problems" are found on Page 35.

HIGH ALTITUDE BAKING

- When cooking at high altitude, recipes and cooking times will vary from the standard. For accurate information, write the Extension Service, Colorado State University, Fort Collins, Colorado 80521. There may be a cost for the bulletins.

CONDENSATION/TEMPERATURE SENSOR

- It is normal for a certain amount of moisture to evaporate from the food during any cooking process. The amount depends on the moisture content of the food. The moisture may condense on any surface cooler than the inside of the oven, such as the control panel.
- Your new Thermador® oven has an electronic temperature sensor that accurately maintains the temperature selected. Your previous oven may have had a mechanical thermostat that drifted gradually over time to a higher temperature. It is common to experience an adjustment period when cooking your favorite recipes in the new oven.

OVEN RACKS

- Rack positions are numbered from the bottom rail guide (#1) to the top (#6). Check the cooking charts for the recommended position.
- To insert racks into the oven, hold the rack with the back rail up and toward the back. Place the safety hooks under the front of the rail guides. Push the rack into the oven, lifting the rack stops over the front of the rail guides. Slide the rack into position.
- To remove racks or reposition racks in the oven, pull the rack towards the front of the oven. Lift up the front of rack over the safety stops and pull from the oven.
- Rack rail supports should not be removed from the oven.
- CAUTION! Never use aluminum foil to cover the oven racks or to line the oven. It can cause damage to the oven can liner if heat is trapped under the foil.
- When placing food on a rack, pull the rack out to the stop position. The racks are designed to lock when pulled forward.

Setting the Clock

- Always set the clock immediately after installation or after a power failure. Once power returns to the oven, the clock displays the time of day when power was turned off or lost.
- If 15 seconds elapse between touching the clock pad or number pads, the mode is automatically cancelled. Set again.
- The time of day clock can be set when an automatic timed cooking mode is in operation.

To Set the CLOCK:

1. Select the **CLOCK** pad.

Touch
CLOCK

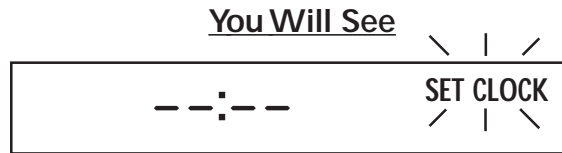

2. Set the current time of day.
(Example shows 8 o'clock set for the time of day.)

Touch
8
0
0



3. Select **START** or **CLOCK**.

Touch
START



Setting the Lights

- Oven lights turn on automatically when the door is opened and off when closed.
- To set manually, always start by highlighting the oven, whether it is "active" or not. (Touch the **UPPER** / **LOWER** pad to display the "active" oven; flashing outline is the active oven.)
- A single **LIGHT** pad activates the lights in either oven.
- The lights do not operate in the Self-Clean mode.

To manually control the interior oven lights if either oven is in use:

1. Select the "active" oven by touching once or twice to highlight oven display.
2. Touch **LIGHT** once to turn light on or off.

Touch
UPPER
LOWER

Touch
LIGHT

You Will See

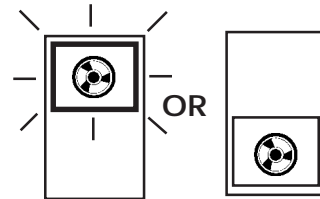

Setting the Timer

- The oven has two Timers, which are independent of each other. Neither timer controls oven operations.
- Touch once and the Timer is set in minutes and seconds.
- Touch twice and the Timer is set in hours and minutes.

To Set TIMER 1 or TIMER 2:

1. Select Timer 1 or 2.

Touch
TIMER 1

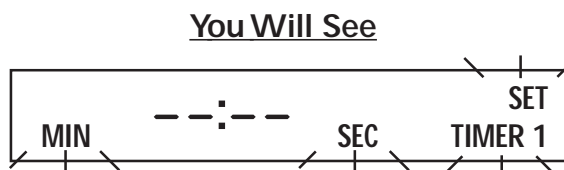

2. Set the amount of time.
(Example shows a 3-minute setting with Timer 1.)

Touch
3
0
0



3. Start Timer.

Touch
START



4. When set time is complete, "End" is displayed and 4 chimes signal. When turned off, display reverts to time of day.

Touch
TIMER OFF



Tip: If timer is not turned off, chimes will continue every 30 seconds. After 5 minutes, chimes stop and the display reverts to the time of day.

To Cancel an Active Timer:

1. Select Timer in use.
2. Cancel Timer.

Touch
TIMER 1 or 2

Touch
TIMER OFF

To Set Both TIMER 1 and TIMER 2:

Follow the steps above to set each Timer. The Timer with the **least amount** of countdown time has display priority. The countdown display for the second timer is shown automatically when the first timer has ended.

The words "TIMER 1" and "TIMER 2" are both displayed along with the number countdown. The word, "TIMER 1" or "TIMER 2", with the **least remaining countdown time** is more brightly lit than the other word.

During the countdown, touch CLOCK or TIMER. Depending on the pad touched, either the time of day or the remaining time is briefly displayed.

To Change a Timer:

1. Touch TIMER 1 or TIMER 2.
2. Enter the new desired time.
3. Touch the START pad.

Bake Mode Operation

- Preheat when using the Bake mode.
- Use BAKE for general cooking on one or two racks.

To set BAKE mode:

1. Select twice for LOWER OVEN.

Touch
UPPER
LOWER

You Will See

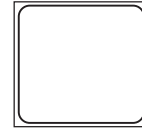

2. Select BAKE.
The temperature is automatically set at 350°F.

Touch
BAKE

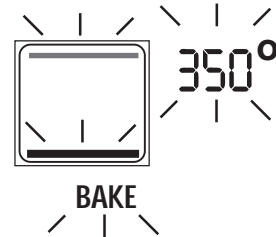

3. Optional step:
To change the temperature from 350°F, select another temperature *immediately* before starting.

Touch
3
7
5



4. Select START.
The temperature display alternates between the set temperature and the actual temperature, beginning with 100°F. The actual temperature counts up in 5°F increments.

Touch
START



The oven is preheated when the chime signals once. PREHEAT disappears from the display.

5. To end this mode, select the oven OFF pad.

Touch
LOWER
OFF

BAKE TIPS

- Follow the recipe, package directions, or the cooking chart on next page for baking temperatures, time and rack position.
- Baking time will vary with the size, shape and finish of the baking utensil. Dark metal pans or nonstick coatings will cook faster with darker results. Insulated bakeware will lengthen the cooking time for most foods.
- For best results, bake food on a single rack with at least 1-1/2" space between utensils and oven walls.
- Use a maximum of 2 racks when selecting the bake mode. Stagger pans or baking sheets so that one is not directly above another.
- Eliminate heat loss from the oven by using the window to periodically check food for doneness.
- Do not use any aluminum foil or a disposable aluminum tray to line any part of the oven. Foil is an excellent heat insulator and heat will be trapped beneath it. This will alter the cooking performance and can damage the finish of the oven.

Baking Chart







Food Item	Oven Temp	Rack Position	Time
Breads			
White Bread, Scratch	400°F (205°C)	3	30 to 35 minutes
Breads, Specialty			
Biscuits, scratch	450°F (232°F)	3	10 to 12 minutes
Biscuits, canned			
Large	375°F (190°C)	3	11 to 15 minutes
Medium	400°F (205°C)	3	8 to 11 minutes
Small	450° F (232°F)	3	8 to 10 minutes
Cornbread, mix or	400° F (205°C)	3	20 to 30 minutes
Scratch			
Gingerbread	350° F (177°C)	3	35 to 40 minutes
Muffins	425°F (219°C)	3	15 to 20 minutes
Quick Breads	350° F (177°C)	3	50 to 60 minutes
Cakes			
Angel Food Mix	350° F (177°C)	1	37 to 47 minutes
Cake Mix,			
8" or 9" round(s)	350° F (177°C)	3 or 2 and 5	30 to 35 minutes
9" x 13" rectangle	350° F (177°C)	3	30 to 35 minutes
Scratch	350°F (177°C)	3	30 to 40 minutes
Cakes, Specialty			
Bundt Cakes	350° F (177°C)	3	40 to 45 minutes
Cupcakes	350° F (177°C)	3	18 to 21 minutes
Pound Cakes	350° F (177°C)	2	48 to 58 minutes
Carrot Cake, Scratch	350° F (177°C)	3	30 to 40 minutes
Casseroles			
9" x 13", Scratch	350° F (177°C)	3	30 to 50 minutes
40 oz., frozen	375° F (190°C)	3	55 to 65 minutes
96 oz., frozen	400° F (205°C)	3	110 to 130 minutes
Cookies			
Bar	375° F (190°C)	3	18 to 23 minutes
Drop	375° F (190°C)	3	8 to 10 minutes
Sliced	375° F (190°C)	3	8 to 10 minutes
Desserts			
Custard	350° F (177°C)	2	40 to 50 minutes
Fruit, Crisps and	350° F (177°C)	3	40 to 45 minutes
Cobblers			45 to 55 minutes
Pies, frozen	400° F (205°C)	3	60 to 65 minutes
Pudding			
Bread Pudding	350° F (177°C)	2	50 to 60 minutes
Rice Pudding	325°F (163°F)	2	40 to 50 minutes
Fruits and Vegetables			
Apples, Baked (4)	400° F (205°C)	3	40 to 45 minutes
Potatoes, Baked (4),	400° F (205°C)	3	60 to 70 minutes
6 to 8 oz each			
Squash, Winter,	350° F (177°C)	3	50 to 55 minutes
Baked, 1-1/2 lbs			

* This chart is a guide. Follow recipe or package.

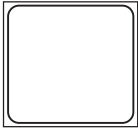
Convection Mode Operation

- **Preheat** when using the convection mode.
- For a quick recipe conversion, reduce the oven temperature 25° from the bake setting.
- Cook food in **low-sided, uncovered pans**.
- Set Timer 1 or 2 as a reminder to check doneness of the food at minimum time.

To Set the CONVECTION Mode:

- | | | |
|--|--|--|
| <p>1. Select twice for LOWER oven.</p> | <p>Touch
UPPER
LOWER</p> | <p><u>You Will See</u></p>  |
| <p>2. Select CONVECTION.</p> <p>The temperature is automatically set at 325°F.</p> | <p>Touch
CONVECTION</p> |  <p>CONVECTION</p>  |
| <p>3. Optional step:
To change the temperature from 325°F, select another temperature <i>immediately</i> before starting.</p> | <p>Touch
3
7
5</p> |  <p>CONVECTION</p>  |
| <p>4. Select START.</p> <p>The temperature display alternates between the set temperature and the actual temperature, beginning with 100°F. The actual temperature counts up in 5°F increments</p> <p>The oven is preheated when the chime signals once. PREHEAT disappears from the display.</p> | <p>Touch
START</p> |   |
| <p>5. To end this mode, select the oven OFF pad.</p> | <p>Touch
LOWER
OFF</p> | |

CONVECTION TIPS

- Use low-sided pans, such as a jelly roll pan, cookie sheets with 1 or 2 sides, and the 2-piece broil pan.
- Shiny aluminum pans are best, unless otherwise specified.
- Dark finish metal pans and heatproof glass or ceramic bakeware may require oven temperature to be reduced or the time shortened.
- Foods cooking in less than 15 minutes requires the same time as in bake mode.
- Foods taking 30 minutes or more to cook will have a 10 to 15% time savings.
- Check doneness 5 to 10 minutes sooner than the minimum time for foods taking 30 minutes or more to cook.

Convection Cooking Chart

FOOD ITEM	OVEN TEMPERATURE	RACK	TIME*
Cakes , mix or scratch: Angel Food Layers (8" or 9") Rectangle (9 x 13) Cupcakes	325°F (163° C) 325°F (163° C) 325°F (163° C) 325°F (163° C)	1 2 and 5 3 1, 3, and 5	40 to 45 minutes 32 to 35 minutes 31 to 34 minutes 17 to 20 minutes
Biscuits: Scratch or Refrigerator	425°F (219° C)	3	10 to 12 minutes
Cookies: Drop or Sliced	350°F (177° C)	3 or more racks any combination	8 to 10 minutes
Cream puffs	375°F (190° C)	3	20 to 30 minutes
Meringues	325°F (163° C)	2	20 minutes
Souffles	350°F (177° C)	3	35 to 40 minutes

* This chart is a guide. Follow recipe or package directions.

Convection Bake Mode Operation

- Oven is not preheated for CONVECTION BAKE to take advantage of the lower heat yielding a better crust on baked items.
- Use the conventional baking temperature and cooking time given in the recipe.
- Cook using only one rack at a time.

To Set the CONVECTION BAKE Mode:

You Will See

1. **Select OVEN.**

- Select twice for LOWER oven..

Touch
UPPER
LOWER



2. **Select CONVECTION BAKE.**

The temperature is automatically set at 325°F.

Touch
CONVECTION
then
BAKE

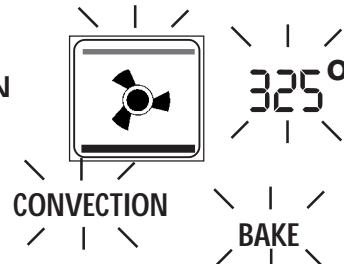

3. **Optional step:**

To change the temperature from 325°F, select another temperature *immediately* before starting.

Touch
3
7
5

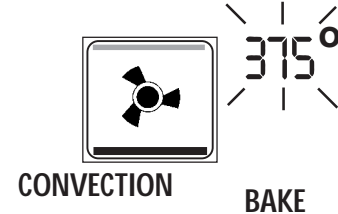

4. **Select START.**

The temperature display alternates between the set temperature and the actual temperature, beginning with 100°F. The actual temperature counts up in 5°F increments.

The oven is preheated when the chime signals once. PREHEAT disappears from the display.

Touch
START



5. **To end this mode,** select the oven OFF pad.

Touch
LOWER
OFF

CONVECTION BAKE TIPS

- Most recipes are cooked on rack positions 1 or 2 to take advantage of bottom heat.
- When a recipe has a two-step temperature cooking method (ex: pumpkin pie), use the lower temperature for the entire cooking time given.
- For extra crisp bottom crusts (ex: scratch pizza), place the metal pan directly on the oven floor.

Convection Bake Chart

FOOD ITEM	RACK	OVEN TEMPERATURE	TIME*
Breads-Yeast:			
Bread	2	350°F (177° C)	25 to 35 minutes
Dinner Rolls	2 or 3	400°F (205° C)	15 to 20 minutes
Sweet Rolls	2 or 3	375°F (190° C)	20 to 25 minutes
Frozen Dough	1 or 2	400°F (205° C)	25 to 35 minutes
Pizza:			
Prebaked crust**	1	450°F (232° C)	12 to 20 minutes
Scratch***	Oven Floor	450°F (232° C)	20 to 25 minutes
Refrigerator	1	425°F (219° C)	18 to 22 minutes
Frozen**	1	400°F (205° C)	18 to 25 minutes
Pies:			
2 Crust Fruit, scratch	1	375°F (190° C)	45 to 60 minutes
or frozen	2	400°F (205° C)	60 minutes
Pumpkin, scratch	2	350°F (177° C)	50 to 60 minutes
or frozen	2	400°F (205° C)	55 to 60 minutes
Meringue toppings	2	350°F (177° C)	15 to 20 minutes
Nut pies	1	350°F (177° C)	40 to 50 minutes
Pastry Crust:			
Scratch	2	425°F (219° C)	15 to 20 minutes
Graham Cracker	2	375°F (190° C)	8 to 10 minutes
Refrigerator	2	450°F (232° C)	10 to 15 minutes
Frozen	2	Follow directions	
Puff Pastries:			
Frozen or scratch	1	400°F (205° C)	20 to 25 minutes
Turnovers	1	400°F (205° C)	20 to 25 minutes
Strudel	1	350°F (177° C)	35 to 40 minutes





* This chart is a guide. Follow recipe or package directions.

** No pan used

Roast Mode Operation

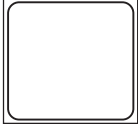
- Use ROAST for conventional open roasting when drippings are desired.
- Roast mode is excellent for less tender meats or poultry when meat is braised and a covered dish is used.
- Use a high-sided roasting pan or cover dish with a lid or foil.

To set ROAST mode:

- | | | |
|---|---|--|
| <p>1. Select OVEN.</p> <ul style="list-style-type: none"> • Select twice for LOWER oven. | <p>Touch
UPPER
LOWER</p> | <p><u>You Will See</u></p>  |
| <p>2. Select ROAST.
The temperature is automatically set at 350° F.</p> | <p>Touch
ROAST</p> |  <p>350°</p> |
| <p>3. Optional step:
To change the temperature from 350°F, select another temperature <i>immediately</i> before starting.</p> | <p>Touch
3
7
5</p> |  <p>375°</p> |
| <p>4. Select START.
The temperature display alternate between the set temperature and the actual temperature, beginning with 100°F. The actual temperature counts up in 5°F increments.</p> <p>The oven is preheated when the chime signals once. PREHEAT disappears from the display.</p> | <p>Touch
START</p> |  <p>100°/375°
PREHEAT</p> |
| <p>5. To end this mode, select the OFF pad.</p> | <p>Touch
LOWER
OFF</p> | |

ROAST TIPS

- This may be used to roast meats, poultry and vegetables, which would be covered or cooked in a high-sided open roaster.
- Add liquids, such as water, juice, wine, bouillon or stock for flavor and moisture.
- Roasting bags are suitable to use in this mode.
- When roasting whole chickens or turkey, tuck wings behind back and loosely tie legs with kitchen string.

Roasting Chart











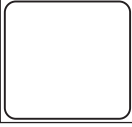

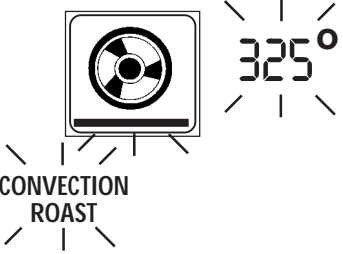
MEAT AND POULTRY – COVERED PAN	OVEN TEMPERATURE	RACK LEVEL	COOK TIME	END TEMP
Beef: Pot roast, 3-4 pounds	350°F (177°C)	1	40 to 60 minutes per pound	170°F (77° C)
Beef Brisket	350°F (177°C)	2	50 to 60 minutes per pound	170°F (77° C)
Beef Chuck	350°F (177°C)	1	45 to 55 minutes per pound	170°F (77° C)
Meat Loaf	350°F (177°C)	3	60 to 90 minutes total time	170°F (77° C)
Poultry: Chicken, whole or halves	375°F (190°C)	1	18 to 21 minutes per pound	Thigh 170°F (77°C)*
Chicken, pieces	375°F (190°C)	1	Total time 60 minutes	
Turkey, whole	350°F (177°C)	2	11 to 15 minutes per pound	170°F (77° C)*
Pork: Shoulder	325°F (163°C)	1	35 to 40 minutes per pound	170°F (77° C)
Smoked Ham, half	325°F (163°C)	1	2 to 3 hours total	160°F (71° C)

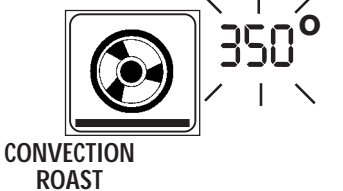
* Serving temperature is 175°F. Cover with foil and let stand for 10-15 minutes.

Convection Roast Mode and Probe Operation

- Preheating is optional for CONVECTION ROAST. Preheating is not recommended for CONVECTION ROAST when using the PROBE. A hot oven impairs connecting the probe into the receptacle and into the roast.
- Roast in a low-sided, uncovered pan.
- Use CONVECTION ROAST when roasting **tender cuts of meat or poultry** of any size.
- Results will yield a drier, crisper exterior that seals in the interior juices with few pan drippings.
- Place tip of probe into the center of thickest section, avoiding bone and fat.

To Set the CONVECTION ROAST and PROBE Mode:

- | Step | Action | Touch | Visual Feedback | Icon |
|------|---|-----------------------------|---|---|
| 1. | Insert the probe into the thickest part of the Meat. Push the plug into the oven receptacle. | | |  |
| 2. | Select OVEN.
For double ovens only | UPPER
LOWER |  |  |
| 3. | Select CONVECTION and ROAST.
The temperature is automatically set at 325°F. | CONVECTION
then
ROAST |  |  |
| 4. | Optional step:
To change the temperature from 325°F, select another temperature <i>immediately</i> before starting. | 3
5
0 |  |  |
| 5. | Select PROBE.
The temperature range for the probe is 100°F to 200°F (88°C – 143°C). The probe automatic default temperature is programmed at 160°F (71°C). | PROBE |  |  |
| 6. | To change the probe temperature from 160°F (71°C), select another temperature <i>immediately</i> before starting. The probe temperature continues to be displayed instead of the oven temperature. | 1
4
5 |  |  |
| 7. | Select START.
The temperature display alternates between the set probe temperature and the actual meat/poultry temperature, increasing in 5°F increments starting with 100°F. Touch CONVECTION to check the oven temperature setting when using the probe. The oven temperature is displayed for 5 seconds before the probe display continues. The oven chimes 3 times when the meat/poultry item is cooked. End is displayed as the heat turns off. | START |  |  |

CONVECTION ROAST TIPS

- When roasting whole chickens or turkey, tuck wings behind back and loosely tie legs with kitchen string.
- Use the 2-piece broil pan with the top grid for roasting uncovered.
- Use the PROBE or a meat thermometer to determine the internal doneness or "End" temperature. (See chart)
- Double-check the internal temperature of meat/poultry by inserting probe into another position.
- While covered, small roast temperatures increase 5°F and large roast increase 10°F.
- After removing the item from the oven, **cover loosely with foil for 10 to 15 minutes before carving.**

Convection Roast Chart

MEAT AND POULTRY – UNCOVERED PAN	OVEN TEMPERATURE	RACK	COOK TIME	PROBE TEMP	DONENESS	CARVING TEMP
Beef: Standing Rib 3 to 6 lbs. 6 to 9 lbs.	325°F (163° C)	2	<u>Minutes Per lb.</u> 28 to 32	135°F (57°C) 140°F (60°C) 160°F (71°C)	Med Rare Med Well	145°F (63°C) 150°F (66°C) 170°F (77°C)
Boneless rib 1 to 4 lbs.	325°F (163° C)	2	30 to 33	135°F (57°C) 140°F (60°C) 160°F (71°C)	Med Rare Med Well	145°F (63°C) 150°F (66°C) 170°F (77°C)
Sirloin, boneless Rump, eye 3 to 6 lbs.	325°F (163° C)	2	30 to 33	135°F (57°C) 140°F (60°C) 160°F (71°C)	Med Rare Med Well	145°F (63°C) 150°F (66°C) 170°F (77°C)
Tri-Tip Tenderloin 1-1/2 to 3 lbs	425°F (219° C)	2	Total Time 30 to 40 min. 35 to 45 min.	135° (57° C) 140° (60° C) 160°F (71°C)	Med Rare Med Well	145° (63° C) 150° (66° C) 170°F (77°C)
Chicken: 3 to 5 lbs. Unstuffed Stuffed Pieces	375°F (190° C) 350°F (177° C) 375°F (190° C)	3 3 3	<u>Minutes Per lb.</u> 18 to 21 18 to 21 Total Time 60 minutes	175°F (79°C) minimum Safe Temp. for Stuffing 165°F (74°C) 175°F (79°C)	Thigh Breast Thigh	175°F (79°C) 165°F (74°C) 170°F (77°C) 175°F (79°C)
Cornish game hens	350°F (177° C)	2	Total Time 60 to 90 minutes	180° (82° C)	Breast and thigh	180° (82° C)
Meatloaf 1 to 2 lbs.	350°F (177° C)	2	Total Time 60 to 75 minutes	170°F (77°C)	Well	170°F (77°C)
Lamb: Leg 4 to 8 lbs. Rack of Lamb 1 to 3 lbs.	325°F (163° C) 325°F (163° C)	1 1	<u>Minutes Per lb.</u> 24 to 30 30 to 35	135°F (57°C) 135°F (57°C)	Med Rare Med Rare	145°F (63°C) 145°F (63°C)
Pork: Loin 4 to 6 lbs. Shoulder 3 to 5 lbs.	325°F (163° C) 325°F (163° C)	2 2	<u>Minutes Per lb.</u> 32 to 35 32 to 35	155°F (68°C) 155°F (68°C)	Well Well	160°F (71°C) 160°F (71°C)
Turkey: Whole, 8 to 15 lbs. Unstuffed Stuffed Whole 16 to 24 lbs. Unstuffed Stuffed Breast, with bone 5 to 7 lbs.	325°F (163° C) 300°F (149° C) 325°F (163° C) 300°F (149° C) 325°F (163° C)	2 2 1 1 2	<u>Minutes Per lb.</u> 9 to 12 10 to 15 7 to 11 10 to 12 16 to 21	170°F (77°C) Minimum Safe Temp. for Stuffing 170°F (77°C) Minimum Safe Temp. for Stuffing 165°F (74°C)	Thigh Thigh Breast	175°F (79°C) 165°F (74°C) 175°F (79°C) 165°F (74°C) 170°F (77°C)
Veal: Loin (bone in) 2 to 4 lbs.	325°F (163° C)	2	<u>Minutes Per lb.</u> 32 to 34	155°F (68°C)	Well	160°F (71°C)

Broil and Convection Broil Mode Operation

- Do not Preheat for broil or convection broil.
- Broil with the door closed.
- Always use the two piece broil pan packaged with your oven.
- Use TIMER to signal when to turn food over.
- Use BROIL when broiling meats, fish or poultry pieces **up to 1-1/2" thick**.
- Use CONVECTION BROIL when broiling meats or poultry **over 1-1/2" thick**.

To Set the BROIL and CONVECTION BROIL Modes:

1. Select twice for LOWER oven.

Touch
UPPER
LOWER

You Will See

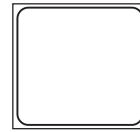

2. Select **BROIL** or **CONVECTION BROIL**.
The temperature is automatically set at HI (550°F/288°C)

Touch
BROIL
or
Touch
CONVECTION
then **BROIL**

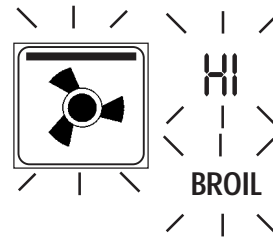

3. Optional step:
To change the setting from HI, select a 500°F for Medium Broil or 450°F for Low Broil temperature *immediately* before starting.

Touch
5
0
0

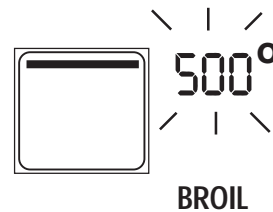

4. Select **START**.

Touch
START



5. To end this mode, select the oven OFF pad.

Touch
LOWER
OFF

BROIL AND CONVECTION BROIL TIPS

- Place rack at the rack level needed **before** turning on the oven.
- Start broiling with a cool oven and broiler pan.
- Brush fish and lean cuts of meat with vegetable oil before broiling to prevent sticking.
- Start poultry with skin side down.
- Turn food after one half of the total cooking time. Thicker cuts of meat or poultry can be turned more often.

Utensils:

- Slotted top grid on broiler pan lets fat drip away from the upper heating element; this reduces spattering and smoking.
- When top browning casseroles or toasting bread, use only metal or glass-ceramic (Pyroceram®) such as Corningware bakeware.
- Never use heatproof glass (Pyrex®) or pottery; they cannot tolerate the high temperatures.

⚠ CAUTION!

When broiling, open the door carefully. There may be an accumulation of steam and smoke. Do not place the hot broiler pan on the open oven door.

Broil Chart

FOOD ITEM and THICKNESS	RACK POSITION	BROIL SETTING	BROIL TOTAL TIME
Beef: Ground, patties, 3/4" to 1"	6	HI	Med Rare - 8 to 12 min. Med - 9 to 14 min. Well - 10 to 15 min.
Steaks, 3/4 to 1-1/4"	6	HI	Med Rare - 7 to 11 min. Med - 8 to 12 min. Well - 9 to 14 min.
Bread: Garlic Bread, 1/2" slices	6	HI	2-1/2 to 4 minutes
3/4" to 1" slices	6	HI	4 to 6 minutes
Fish: Fillets or steaks, 1/2" to 1"	5 or 6	Med - 500°F (260° C)	Flakes - 8 to 12 minutes (1/2" thickness does not need to be turned after half of broil time)
Lamb: Chops, 1/2" to 1"	6	HI	Med - 12 to 17 minutes Well - 15 to 20 minutes
Pork: Chops, 1/2" to 1"	6	Med - 500°F (260° C)	Well - 18 to 25 minutes
Smoked, ham steak, 1/2"	6	HI	Well - 7 to 11 minutes
Ham steak, 1"	6	HI	Well - 12 to 15 minutes
Poultry: Chicken, pieces	4 or 5	Low - 450°F(232° C)	30 to 45 minutes
Sausage: Hot Dogs, whole	6	HI	4 to 5 minutes
Veal: Chop, 1"	6	HI	Well - 12 to 16 minutes

Convection Broil Chart

FOOD ITEM and THICKNESS	RACK POSITION	BROIL SETTING	BROIL TOTAL TIME
Beef: Roasts, flat, 1-1/2" or more	4	Med - 500°F (260° C)	Med Rare - 16 to 22 min.
Steaks, 1-1/2" or more	4	HI	Med - 22 to 28 min. Well - 26 to 32 min.
Bread: Garlic Bread, 1-1/2" slices	5	HI	4 to 6 minutes
Lamb: Chops, 1-1/4" or more	5	HI	Med - 21 to 27 minutes Well - 27 to 33 minutes
Pork: Chops or tenderloin, 1-1/4" or more	5	Med - 500°F (260° C)	Well - 18 to 25 minutes
Poultry: Chicken, quarters	4 or 5	Low - 450°F (232° C)	30 to 45 minutes
Turkey, pieces	4	Low - 450°F (232° C)	30 to 50 minutes
Sausages: Fresh, uncooked	5	HI	Well - 6 to 8 minutes

Proof Mode Operation

- Place food in oven before selecting this mode.
- The proofing temperature is pre-set at 100°F.
- Use any rack level that accommodates the size of the bowl or pan.
- Lightly cover the bowl or pan.

To Set the PROOF Mode:

You Will See

1. Select twice for LOWER oven.

Touch
UPPER
LOWER



2. Select PROOF/DEHYDRATE once for the proof mode.

Touch
PROOF
DEHYDRATE

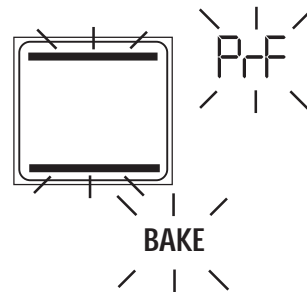

3. Select START.

The oven is preheated when the chime signals once. PREHEAT disappears from the display.

Touch
START



4. To end this mode, select the oven OFF pad.

Touch
LOWER
OFF

PROOFING TIPS





- Keep the oven door closed and use the oven light to check the rising of the dough.
- Use the reminder convenience of either TIMER 1 or TIMER 2.

Dehydrate Mode Operation

- Do not preheat when using the dehydrate mode.
- The dehydrating temperature is pre-set at 140°F.
- Use drying screens (not supplied with oven).
- Multiple racks can be used simultaneously.
- Place food in oven before selecting the mode.

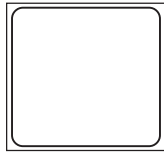
To Set the DEHYDRATE Mode:

You Will See

- | | | | |
|---|--|---|---|
| <p>1. Select twice for LOWER oven.</p> | <p>Touch
UPPER
LOWER</p> |  | |
| <p>2. Select PROOF/DEHYDRATE <u>twice</u> for the dehydrate mode.</p> | <p>Touch
PROOF
DEHYDRATE</p> | 
<p>CONVECTION</p> |  |
| <p>3. Select START.</p> <p>The oven is preheated when the chime signals once. PREHEAT disappears from the display.</p> | <p>Touch
START</p> |  |  |
| <p>4. To end this mode, select the oven OFF pad.</p> | <p>Touch
LOWER
OFF</p> | | |

DEHYDRATING TIPS

- Some foods require as much as 14 to 15 hours of time to fully dehydrate.
- Consult a food preservation book for specific times and handling of various foods.
- This mode is suitable for a variety of fruits, vegetables, herbs and meat strips.
- Drying screens can be purchased at specialty kitchen shops.
- By using paper towels, some food moisture should be absorbed before dehydrating begins (such as sliced tomatoes or sliced peaches).

Timed Oven Modes Operation

- In double oven models, both ovens can be set independently to operate a timed mode.
- Be sure that the time of day clock is displaying the correct time.
- The timed mode turns off the oven at the end of the cook time.

To Set Timed Mode:

Example shown has the time of day set at 3:00.

1. Select OVEN.

- Select twice for LOWER oven.

Touch
UPPER
LOWER

You Will See

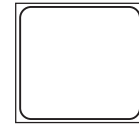

2. Select BAKE or CONVECTION.

Change the preset temperature at this time, if needed.

Touch
BAKE

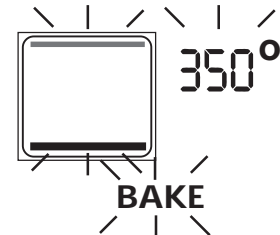

- ### 3. Immediately before starting, select the number of hours and minutes the oven will be on.
- For example, 2, 3, 0 is 2 hours 30 minutes.

Touch
COOK TIME
2
3
0

COOK TIME 2:30

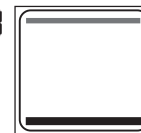

350°

4. Select START.

The oven turns on and heats to the temperature selected for the number of hours and minutes needed. The clock automatically calculates the time of day the mode will stop and the oven will turn off. The example shows that it will stop at 5:30 after cooking for 2-1/2 hours.

Touch
START

COOK TIME 2:30
STOP TIME 5:30



100°/350°
PREHEAT

To Delay the Start of the Timed Mode:

Example shown has the time of day set at 3:00

- ### 1. Follow steps 1, 2 and 3 above.
- Immediately after the number of hours are selected for the food to cook, select the Stop Time.

Touch
STOP TIME

COOK TIME 2:30
STOP TIME : --



350°

- ### 2. Select the time of day the oven will stop cooking or turn off.
- This example, shows that the oven will stop at 7:00 and cook for 2-1/2 hours.

Touch
7
0
0

COOK TIME 2:30
STOP TIME 7:00

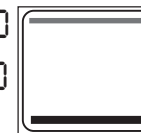

350°

3. Select START.

The oven turns on and heats to the temperature selected for the number of hours and minutes needed.

The clock automatically calculates the time of day the mode starts and stops.

Touch
START

COOK TIME 2:30
START AT 4:30



100°/350°
PREHEAT

Setting the Sabbath Mode

- This mode is for religious faiths with “no work” requirements on the Sabbath.
- Use only in the BAKE mode; do not use with Timed Bake or the Probe mode.

To Set the Sabbath Mode:

1. Cancel all modes.

2. Select OVEN.

- Select twice for LOWER oven.

Touch
UPPER
LOWER

You Will See



3. Select BAKE mode and temperature. (See Page 39 to change temperature.)

Touch
BAKE

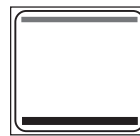

350°
BAKE

4. Select START.

Touch
START



100°/350°
PREHEAT

5. Select on or off status for the lights. To keep lights off, do not touch.

Touch
LIGHTS

6. To activate the Sabbath mode , touch and hold TIMER OFF pad for 5 seconds.

- The word “SAb” is displayed.
- Lights will remain on or off as previously set, if the door is open or closed.
- “Preheat” is displayed until the oven reaches temperature.
- All pads, except the oven OFF, will be inactive. No chime or beep signal is generated.
- Oven will remain “on” indefinitely until cancelled.
- When the red heating symbol in the display is illuminated, the bake element is on. Opening the door at this point will not cause the heating element to be activated, since it will already be on. The heating element will remain on, while the door is open under this condition.

Touch
TIMER OFF

SAb

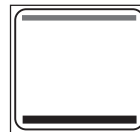

100°/350°
PREHEAT

7. To Cancel or Stop the Sabbath mode:

- Touch oven OFF.
- Turn off the light if it was set to stay on in Step 5.

Self-Cleaning The Oven

Your new oven features two pyrolytic self-cleaning ovens. When set into the **CLEAN** mode, the oven reaches a high temperature that burns off the food soil.

- Only one oven can be set to self clean at a time. The second oven cannot be used while one is self cleaning.
- The microwave mode can be used when the Lower oven is self-cleaning.
- It is common to see smoke and/or an occasional flame-up during the **CLEAN** cycle, depending on the content and amount of soil remaining in the oven. If a flame persists, turn off the oven and allow it to cool **before** opening the door to wipe up the excessive food soil.
- The oven light will not turn on when the oven is set for a clean cycle.

NOTE: Due to the high temperatures used for self-cleaning, the oven may develop fine hairlike lines or surface roughness. This is a common condition and does not affect either the cooking or the cleaning performance of the oven.

BEFORE YOU SELF-CLEAN

1. Hand-clean the oven door edge, window, oven front frame and oven cavity edges (shaded areas below). They do not get hot enough during the cleaning cycle for soil to burn away. Use a soapy sponge or plastic scrubber or an S.O.S.[®] pad. **DO NOT RUB THE GASKET.**

2. Wipe up large overspills and grease with paper towels.
3. Remove all utensils.
4. Remove oven racks. If the oven racks are left in the oven during a self-cleaning cycle, they will permanently lose their shiny finish and change to a dull dark finish. See the Oven Cleaning Chart for proper care, Page 30-31.
5. Be sure the light is turned off on the control panel and the bulb and glass cover are in place, see Page 33.
6. Heat and odors are normal during the Self-Cleaning cycle. Keep the kitchen well ventilated.

AFTER SELF-CLEAN

- At the end of the CLEAN cycle, gray ash remains inside the oven. The amount of ash depends on how heavily soiled the oven was before it was cleaned. It is easily removed, when the oven is cold, using a damp sponge or cloth. If the racks do not slide easily after being cleaned, lightly rub rack side rails with vegetable oil.

IMPORTANT: Be sure to let the inside window glass in the oven door cool completely before wiping up any ash left from the clean cycle.

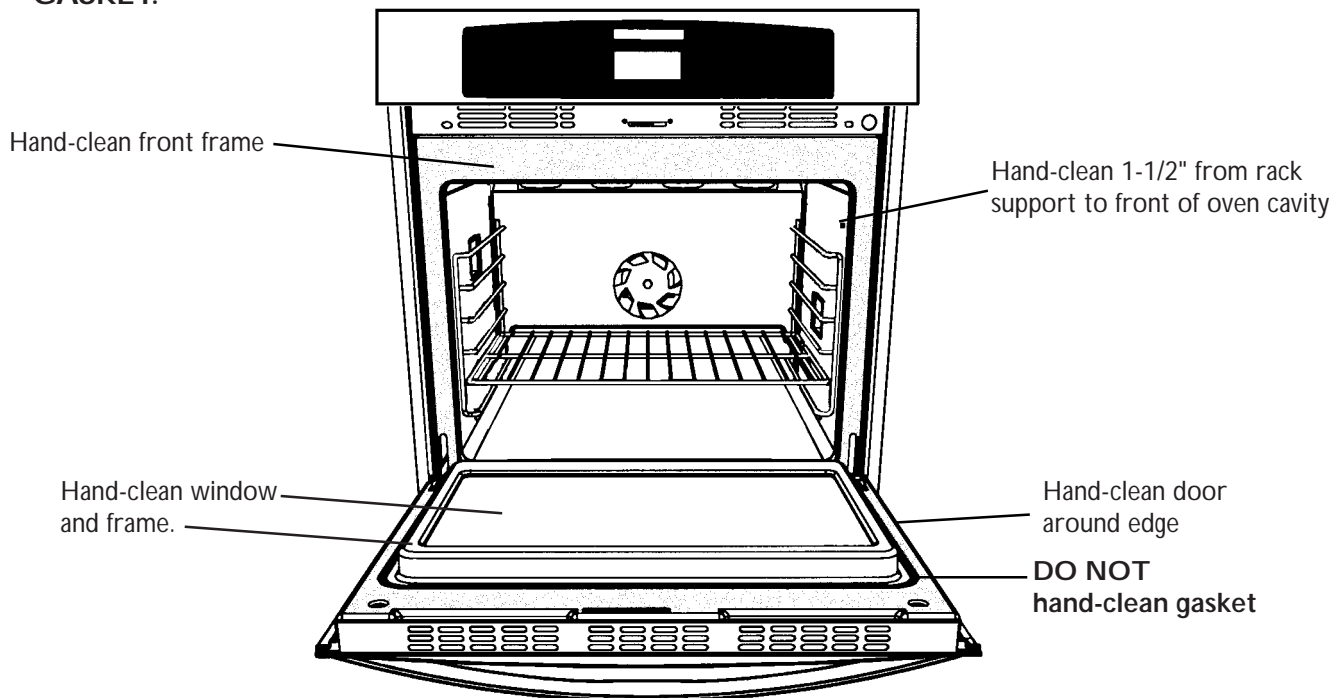

Self Clean Mode Operation

To Set the SELF CLEAN Mode to Start Now:

- Self-Clean only one oven at a time.
- The oven light does not operate during this mode.
- Be sure that the time of day clock is displaying the correct time.
- Three hours is the preset length of cleaning.
- The mode stops automatically at the end of the clean hours.

Example shows clock set at 5:00

1. Select OVEN.

- Select once for UPPER oven.
- Select twice for LOWER oven.

Touch
UPPER
LOWER

You Will See



2. Select SELF CLEAN.

The number of clean hours (3:00) is displayed automatically.

Touch
SELF
CLEAN

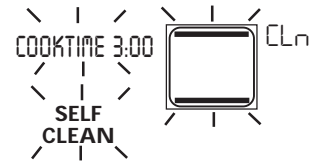

3. Optional Step:

To change the setting from 3 hours, select either 2 hours for light soil or 4 hours for heavy soil *immediately* before starting.

Touch
4
0
0

COOK TIME 4:00

CLn

4. Select START.

The door locks automatically. When the lock symbol is displayed, the door cannot be opened. Confirm that the door locks and will not open before starting self-clean mode. If door does not lock, press OFF and do not self-clean; phone 800 / 735-4328 for service (see Page 36 for obtaining service.) If the door is in the open position when this mode is selected, the display will flash the word "dor". This is a reminder that the door must be closed before the SELF CLEAN mode can be set.

Touch
START

TO DELAY THE START OF THE MODE:

1. Select OVEN.

- Select once for UPPER oven
- Select twice for LOWER oven

Touch
UPPER
LOWER

2. Select SELF CLEAN.

The number of clean hours (3:00) is displayed automatically. If the number of clean hours do not need to be changed, proceed to set the STOP TIME.

Touch
SELF
CLEAN

3. Select STOP TIME.

When the words STOP TIME flash, touch the time of day. The oven will stop. Oven will display the time when the clean cycle will stop.

Touch
STOP
TIME

4. Select START.

- ### 5. To cancel or stop the mode after the "lock" symbol is displayed, wait until the symbol disappears. Then the door can be opened.

Touch
START

Oven Cleaning – Upper and Lower Oven

How to use the Oven

Cleaning Chart

1. Locate the number of the part to be cleaned in the illustration on this page.
2. Match the letter adjacent to the part name with the letter on the chart (next page) for the recommended cleaning method.
 - Use the cleaning method in the left column if the oven is black or white.
 - Use the cleaning method in the right column if the oven is stainless steel.
3. Match the letter with the cleaning method on the chart on the next page.

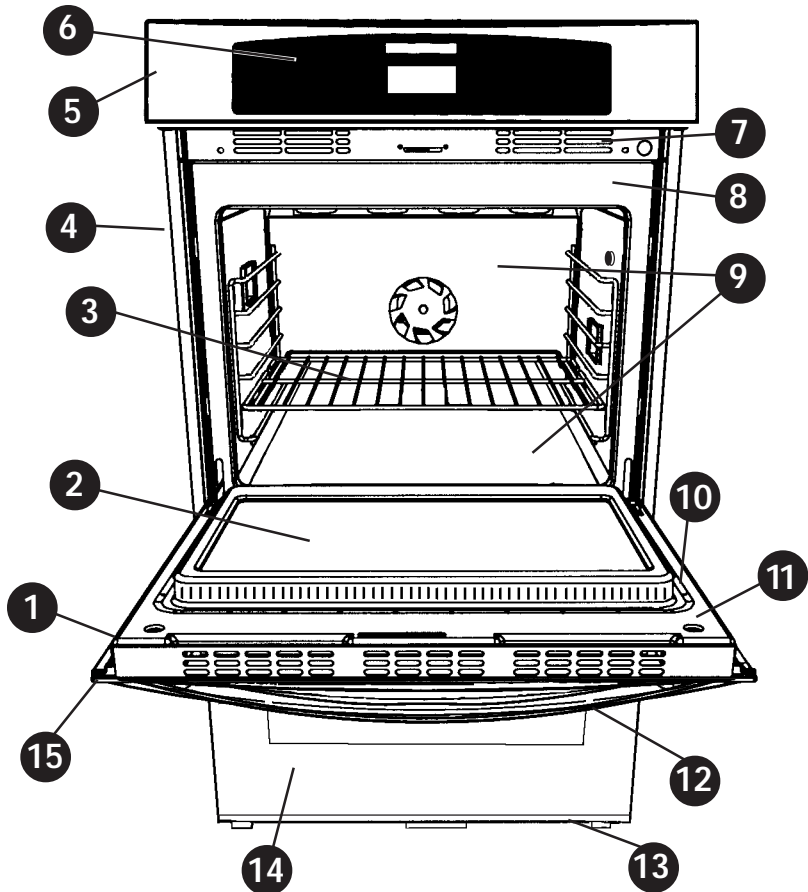
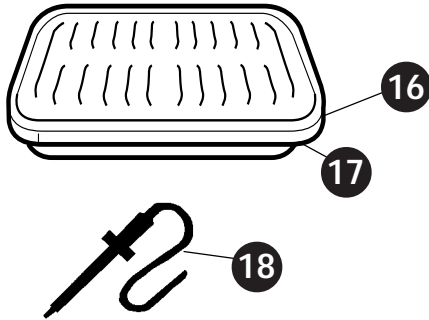

Part	Cleaning Method		Part	Cleaning Method	
	Blk / Wht Oven	Stainless Steel Oven		Blk / Wht Oven	Stainless Steel Oven
1 Door Frame	D	D	10 Seal (Gasket)		B
2 Interior Door Window	F	F	11 Interior Oven Door		E
3 Removable Oven Racks	A	A	12 Door Handle		D
4 Side Trim	D	D	13 Door Cooling Vent & Trim		D
5 Control Panel Trim	D	D	14 Door Front		C & G
6 Control Panel	C	C, G	15 Door End caps (not shown)		D
7 Oven Cooling Vents	D	D	16 Broil Pan Grid Top		A
8 Oven Front Frame	E	E	17 Broil Pan Bottom		E
9 Oven Cavity	E	E	18 Probe Accessory (Upper or Single oven only)		H

Oven Finishes / Cleaning Method

The entire oven can be safely cleaned with a soapy sponge, rinsed and dried. If stubborn soil remains, follow the recommended cleaning methods below.

- Always use the mildest cleaner that will do the job.
- Rub metal finishes in the direction of the grain.
- Use clean, soft cloths, sponges or paper towels.
- Rinse thoroughly with a minimum of water so it does not drip into door slots.
- Dry to avoid water marks.

The cleaners recommended below indicate a type and do not constitute an endorsement. Use all products according to package directions.

PART	CLEANING METHOD
A Chrome Plated	<p>Wash with hot sudsy water. Rinse thoroughly and dry. Or, gently rub with Soft Scrub[®], Bon-Ami[®], Comet[®], Ajax[®], Brillo[®] or S.O.S.[®] pads as directed. Easy Off[®] or Dow[®] Oven Cleaners (cold oven formula) can be used, but may cause darkening and discoloration. The broil pan top may be squirted with liquid detergent and covered with wet paper towels while pan is hot. Allow to stand.</p> <p>Racks may be cleaned in the oven during the self clean mode. They will lose their shiny finish and permanently change to a metallic gray.</p>
B Fiberglass Knit	DO NOT HAND CLEAN GASKET.
C Glass	Spray Windex [®] or Glass Plus [®] onto a cloth first, then wipe to clean. Use Fantastik [®] or Formula 409 [®] to remove grease spatters.
D Painted	Clean with hot sudsy water or apply Fantastik [®] or Formula 409 [®] first to a clean sponge or paper towel and wipe clean. <u>Avoid using powdered cleansers and steel wool pads.</u>
E Porcelain	Immediately wipe up acid spills like fruit juice, milk and tomatoes with a <u>dry</u> towel. Do not use a moistened sponge/towel on hot porcelain. When cool, clean with hot sudsy water or apply Bon-Ami [®] or Soft Scrub [®] to a damp sponge. Rinse and dry. For stubborn stains, gently use Brillo [®] or S.O.S. [®] pads. It is normal for porcelain to craze (fine lines) with age due to exposure from heat and food soil.
F Reflective Glass	Clean with hot sudsy water and sponge or plastic scrubber. Rub stubborn stains with vinegar, Windex [®] , ammonia or Bon-Ami [®] . DO NOT USE HARSH ABRASIVES.
G Stainless Steel	Always wipe or rub with grain. Clean with a soapy sponge; rinse and dry. Or, wipe with Fantastik [®] or Formula 409 [®] sprayed onto a paper towel. Protect and polish with Stainless Steel Magic [®] and a soft cloth. Remove water spots with a cloth dampened with white vinegar. Use Revereware Instant Stainless Steel Cleaner [®] to remove heat discoloration.
H Probe	Clean probe by hand with detergent and hot water. Rinse and dry. Do not soak or clean in dishwasher.
I Rubber	Clean with hot sudsy water and sponge. Avoid using steel wool pads.

Do-It-Yourself Maintenance

Removing the Oven Door

The oven door can be lifted off for your convenience in cleaning hard to reach areas inside the oven.

- Use caution when removing the lower door as it is very heavy.

To Remove the Oven Door

1. Fully open the oven door.
2. Raise the U-clip over the hook on each of the hinges to the "locked" position (see illustration below). This will prevent the hinge from snapping closed when the door is removed.
3. Grasp the door by the sides toward the back. Raise the front of the door several inches (there will be some spring resistance to overcome because of the hinge being locked). When the front of the door is high enough, you will be able to lift the hinges to clear the indents.
4. Pull the hinges out of the slots in the oven front frame.

To Replace the Oven Door

1. Grasp the sides of the door at the center and insert the ends of the hinges into the slots in the oven front frame as far as they will go (see illustration below).
2. With the door open all the way, lower the two locking clips.
3. Raise the oven door and make sure that it fits evenly with the front sides.



WARNING:

With the door off, never release the levers and try to close the hinges. Without the weight of the door, the powerful springs will snap the hinges closed with great force.

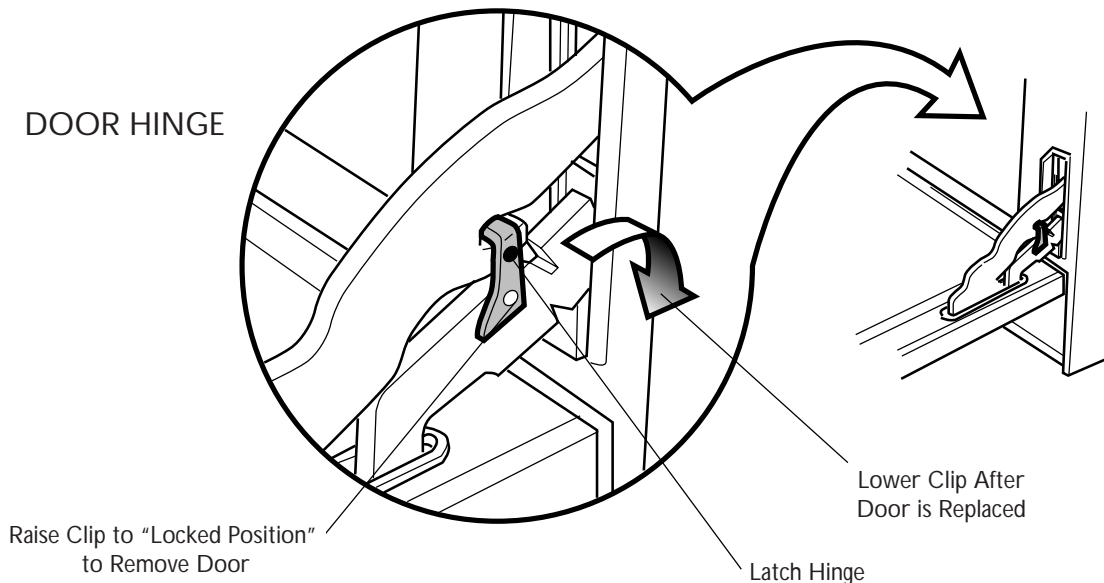

Do-It-Yourself Maintenance

REPLACING THE OVEN LIGHT - LOWER OVEN ONLY

! WARNINGS:

To prevent electrical shock and or personal injury:

- Before replacing the light bulb, be sure the electric power is turned off at the circuit breaker.
- Do not operate the oven unless the light cover is securely in position.
- Halogen bulbs get HOT instantly when turned ON.
- Be sure the oven and light bulb are cool.

CAUTION: If the light cover is damaged or broken, **do not use the oven** until a new cover is in place.

The oven lights are located, on the left and right side walls of the oven. The lights have a removable lens cover and a halogen light bulb. The ceramic light socket housing is not removable by the user.

- Replace bulb with a 12-Volt, 10-Watt Halogen bulb only.

Before replacing bulbs, turn off oven circuit.

To replace Halogen Bulb:

1. Remove oven racks.
2. Slide the tip of a table knife blade between oven wall and the center of the side of the protective glass lens cover.
3. Support the glass lens cover with two fingers along the bottom edge to prevent the cover from falling to the bottom of the oven.
4. Gently twist the knife blade to loosen the glass lens cover.
5. Remove the glass lens cover.

6. Remove the bulb by grasping and sliding the bulb straight up until the two prongs have cleared the ceramic holder.
7. Do not touch the glass of the new replacement bulb with your fingers. It will cause the bulb to fail when it first lights. Grasp the replacement bulb with a clean paper towel or facial tissue with the prongs facing down. Locate the two prongs in the ceramic holder, gently poking until the two prongs locate in the ceramic socket.
8. Press down to seat the bulb.
9. Snap the protective glass lens cover over the bulb housing.
10. Turn on circuit breaker.
11. The upper oven light must be replaced by a qualified service technician. See Page 36.

CHANGING TO THE 24-HOUR CLOCK FORMAT

The oven has been preset to a 12 hour clock format.

To Change the Time of Day Clock to a 24-Hour Clock, follow these steps:

1. Turn off both ovens.
2. Touch and hold the **UPPER OFF**, then touch the **CLOCK** pad at the same time.
3. 12H appears in the Clock window; release both pads.
4. Touch **CLOCK** and 24H replaces 12H. This alternates when **CLOCK** is touched.
5. To complete the change, touch **UPPER OFF** or **OFF**.

Do-It-Yourself Maintenance

FAHRENHEIT TO CENTIGRADE

The oven has been preset to a Fahrenheit temperature.

To Change to Centigrade, follow these steps:

1. Turn off both ovens.
2. Touch and hold the **UPPER OFF** and then the CONVECTION pad at the same time.
3. F appears in the temperature digits; release both pads.
4. Touch CONVECTION; C replaces F. This alternates when CONVECTION is touched.
5. To complete the change, touch **UPPER OFF**.

CALIBRATING OVEN TEMPERATURE

The electronic thermostat has been preset to 0°F and accurately maintains its setting. If the browning results are too light or too dark for your preferences, you can raise or lower the setting.

To change the Calibration of the Oven Temperature:

1. Turn off both ovens.
2. Touch and hold the **UPPER OFF** pad in a double oven or the OFF pad in a single oven; touch the BAKE pad.
3. 0 appears in the temperature digits; release all pads.
4. Touch BAKE and 0 changes in increments of 5 degrees each time it is touched. The maximum adjustment is $\pm 35^{\circ}\text{F}$. In Centigrade the range is $\pm 3^{\circ}\text{C}$ to 21°C .
5. To complete the change, touch **UPPER OFF**.

To calibrate the lower oven models: Repeat the steps with this exception, touch the **LOWER OFF instead of the **UPPER OFF** pad.**

Solving Baking Problems

With either BAKE or CONVECTION, poor results can occur for many reasons other than a malfunction of the oven. Check the chart below for causes of the most common problems. Since the size, shape and material of baking utensils directly affect the baking results, the best solution may be to replace old baking utensils that have darkened and warped with age and use. Check the Baking Charts for the correct rack position and baking time.

BAKING PROBLEM	CAUSE
Food browns unevenly	<ul style="list-style-type: none"> • Oven not preheated. • Aluminum foil on oven rack or oven bottom. • Baking utensil too large for recipe. • Pans touching each other or oven walls.
Food too brown on bottom	<ul style="list-style-type: none"> • Oven not preheated. • Using glass, dull or darkened metal pans. • Incorrect rack position. • Pans touching each other or oven walls.
Food dry or has shrunk excessively	<ul style="list-style-type: none"> • Oven temperature too high. • Baking time too long. • Oven door opened frequently. • Pan size too large.
Food baking or roasting too slowly	<ul style="list-style-type: none"> • Oven temperature too low. • Oven not preheated. • Oven door opened frequently. • Tightly sealed with aluminum foil. • Pan size too small.
Pie crusts do not brown on bottom or have soggy crust	<ul style="list-style-type: none"> • Baking time not long enough. • Using shiny steel pans. • Incorrect rack position. • Oven temperature is too low.
Cakes pale, flat and may not be done inside	<ul style="list-style-type: none"> • Oven temperature too low. • Incorrect baking time. • Cake tested too soon. • Oven door opened too often. • Pan size may be too large.
Cakes high in middle with crack on top	<ul style="list-style-type: none"> • Baking temperature too high. • Baking time too long. • Pans touching each other or oven walls. • Incorrect rack position. • Pan size too small.
Pie crust edges too brown	<ul style="list-style-type: none"> • Oven temperature too high. • Edges of crust too thin.

Solving Operational Problems

Before calling for service, check the following to avoid unnecessary service charges.

PROBLEM OVEN	PROBLEM SOLVING STEPS
All the numbers touched do not appear in display	The numbers were touched too rapidly. Be sure you remove your finger from the number pad before touching the next digit.
F followed by 2 digits appears in the display window	Touch OFF or turn power off at the circuit breaker, wait 3 minutes and turn it back on. If condition persists, note the code number and call an authorized servicer.
F-24 or F-25 appears in display window	This is caused by close contact to the control panel for more than 60 seconds, such as someone leaning against the controls or objects hanging in front of controls. See item above for correction.
5Fb appears in display window	Turn off the oven selected by touching OFF (single oven model) LOWER OFF or UPPER OFF (double oven model).
Cooling fan continues to run after oven is turned off.	The fan turns off automatically when the electronic components have cooled sufficiently.
Clock and timer do not work	Make sure there is proper electrical power to the oven. See the CLOCK and TIMER sections on Pages 10 & 11.
Oven will not work	Make sure there is proper electrical power to the oven. Check the circuit breaker or fuse box to your house.
Oven light does not work	Replace or reinsert the light bulb if loose or defective. See Page 33. Touching the bulb with your fingers may cause the bulb to burn out quickly. Oven light does not work if CLEAN mode is set.
Oven temperature is too hot or too cold	The oven thermostat needs adjustment. See CALIBRATING OVEN TEMPERATURE in Do-It-Yourself Maintenance, Page 34.
Oven will not self-clean	The oven temperature is too high to set the self-clean operation. Allow the oven to cool to room temperature and reset the controls. Be sure you have touched CLEAN.
Oven door will not unlock	Allow the oven to cool below the locking temperature.
Oven is not clean after the clean cycle	Heavily soiled ovens may need to self-clean again or for a longer period of time. Heavy spillovers should be cleaned before starting the clean cycle. See Preparing to Self-Clean, Pages 28 and 29.
Oven does not lock in Self Clean Mode	Do not run Self Clean. Call for service. See information below.

HOW TO OBTAIN SERVICE

For authorized service or parts information, call 800/ 735-4328.

We want you to remain a satisfied customer. If a problem does come up that cannot be resolved to your satisfaction write to Thermador Customer Support Call Center, 5551 McFadden Avenue, Huntington Beach CA, 92649 or call: 800/ 735-4328.

Please include the Model Number, Serial Number and Date of Original Purchase/Installation.

THERMADOR BUILT-IN OVEN WARRANTY

For Model **C302 • C272 • C301 • C271**

WHAT IS COVERED

Full One Year Warranty

For one year from the date of installation or date of occupancy for a new previously unoccupied dwelling, any part which fails in normal home use will be repaired or replaced free of charge. Save your dated receipt or other evidence of the installation/occupancy date. Thermador® will pay for all repair labor and replacement parts found to be defective due to materials and workmanship. Service must be provided by a Factory Authorized Service Agency during normal working hours.

WHAT IS NOT COVERED

1. Service by an unauthorized agency. Damage or repairs due to service by an unauthorized agency or use of unauthorized parts.
2. Service visits to:
 - Teach you how to use the appliance.
 - Correct the installation. You are responsible for providing electrical wiring and other connecting facilities.
 - Reset circuit breakers or replace home fuses.
3. Damage resulting from accident, alteration, misuse, abuse, improper installation or installation not in accordance with local electrical codes or plumbing codes, or improper storage of the appliance.
4. Repairs due to other than normal home use.

WARRANTY APPLICATIONS

This warranty applies to appliances used in normal family households; it does not cover their use in commercial situations.

This warranty is for products purchased and retained in the 50 states of the U.S.A., the District of Columbia and Canada. The warranty applies even if you should move during the warranty period. Should the appliance be sold by the original purchaser during the warranty period, the new owner continues to be protected until the expiration date of the original purchaser's warranty period.

THERMADOR® DOES NOT ASSUME ANY RESPONSIBILITY FOR INCIDENTAL OR CONSEQUENTIAL DAMAGES. Some states do not allow the exclusion or limitation of incidental or consequential damages, so the above limitation or exclusion may not apply to you. This warranty gives you specific legal rights and you may also have other rights which may vary from state to state or province to province.

SERVICE DATA RECORD

The serial tag on the product can be seen inside the cooling vents on the right-hand side. *Please see item 10 on Page 4.* Now is a good time to write this information in the space provided below. Keep your invoice for warranty validation. To obtain service, see Page 36.

Model Number:
Serial Number:
Date of Installation or Occupancy:

Specifications are for planning purposes only. Refer to installation instructions and consult your countertop supplier prior to making counter opening. Consult with a heating and ventilating engineer for your specific ventilation requirements. We reserve the right to change specifications or design without notice. Some models are certified for use in Canada. Thermador is not responsible for products which are transported from the U.S. for use in Canada. Check with your local Canadian distributor or dealer.

For the most up to date critical installation dimensions by fax, use your fax handset and call (702) 833-3600. Use code #8030.



Thermador®

5551 McFadden Avenue, Huntington Beach, CA 92649 • 800/735-4328
ECO 12629 • 16-10-191F • © 2001 BSH Home Appliances Corp. • Litho in USA 12 /01

Free Manuals Download Website

<http://myh66.com>

<http://usermanuals.us>

<http://www.somanuals.com>

<http://www.4manuals.cc>

<http://www.manual-lib.com>

<http://www.404manual.com>

<http://www.luxmanual.com>

<http://aubethermostatmanual.com>

Golf course search by state

<http://golfingnear.com>

Email search by domain

<http://emailbydomain.com>

Auto manuals search

<http://auto.somanuals.com>

TV manuals search

<http://tv.somanuals.com>