

Care & Use Manual



for
Thermador Built-In Oven

Model
CJ302

Thermador[®]

A Special Message to Our Customers

Thank you for buying a Thermador oven. We recommend that you take the time to read this entire booklet before using your new appliance.

We hope that the information in this manual will help you easily operate and care for your oven for years of satisfaction.

You have selected a remarkable oven capable of several advanced cooking operations. To help make your cooking transition smooth, we have dedicated a specific 888 number for your use. This special line is staffed with representatives trained to answer your speed cooking questions or comments about the oven. Just phone **1-888-SPD-COOK (1-888-773-2665)** or reach us through our web site at **www.thermador.com**.

We can also be reached at 1-800-735-4328 or write to us at:

Customer Support Call Center
Thermador
5551 McFadden Avenue
Huntington Beach, CA 92649

Always include your model and serial number with all communication.

Sincerely,

Thermador Test Kitchen Consumer Scientists

Table of Contents

Safety Precautions	2 – 5	Baking Chart	40
Microwave Precautions, Registration	2	Convection Mode Operation	41
Service Data Record	2	Convection Cooking Chart	42
General Appliance, Oven, and Microwave		Convection Bake Mode Operation	43
Oven Safety Precautions	3 – 4	Convection Bake Chart	44
Microwave Safety Precautions	5	Roast Mode Operation	45
Oven Features	6 – 12	Roasting Chart	46
Features of Your Oven	6	Food Safety Guidelines	46
The Control Panel	7	Convection Roast	
Panel Lock (Child Lockout)	7	and Probe Mode Operation	47
Voltage Connection	36, 64	Convection Roast Chart	48
Sights & Sounds	8	Broil and Convection Broil Modes	
Setting the Clock	9	Operation	49
Setting the Lights	9	Broil Chart	50
Setting the Timer	10	Convection Broil Chart	50
Upper Oven Modes/Operation	11 – 35	Proof Mode Operation	51
Upper Oven Heating Modes	11	Dehydrate Mode Operation	52
Upper Oven Control Menu	12	Timed Oven Modes Operation	53
COOKSMART* Mode Operation	13 – 14	Setting the Sabbath Mode	54
COOKSMART Cooking Charts		Self-Cleaning	55 – 57
CS1 - Breads, Desserts	15 – 16	Self-Cleaning the Oven	55
CS2 - Vegetables	17	Preparing Upper Oven for Self-Cleaning	55
CS3 - Meat, Casseroles	18 – 20	Preparing Lower Oven for Self-Cleaning	56
CS4 - Frozen Cooked Foods	20	Self Clean Mode Operation for	
JETDIRECT* Convection Operation	21	Upper and Lower Ovens	57
JETDIRECT Convection		Oven Care and Cleaning	58 – 59
Cooking Charts	22 – 23	Oven Cleaning Chart	58
Basics for Microwave Mode	24	Oven Finishes/Cleaning Method	59
Microwave Mode Operation	25 – 26	Do-It-Yourself Maintenance	60 – 62
Microwave Cooking Charts	27 – 30	Removing the Lower Oven Door	60
Custom Combination Mode		Replacing the Oven Light	61
Operation	31 – 33	Changing to the 24-Hour Clock Format	61
Custom Combination Cooking Chart	34	Changing Fahrenheit to Centigrade	62
Favorite Recipe Chart	35	Calibrating Oven Temperature	62
Lower Oven Modes/Operation	36 – 54	Problem Solving/Customer Service ..	63 – 65
Lower Oven General Tips	36	Solving Baking Problems	63
Voltage Connection	36	Solving Operational Problems	64
Lower Oven Heating Modes	37	How to Obtain Service	64
Lower Oven Control Menu	38	Thermador® Warranty	65
Bake Mode Operation	39		

* COOKSMART® and JETDIRECT® are federally registered trademarks owned by BSH Home Appliances Corporation.

MICROWAVE PRECAUTIONS AND REGISTRATIONS

PRECAUTIONS TO AVOID POSSIBLE EXPOSURE TO EXCESSIVE MICROWAVE ENERGY

- a) Do not attempt to operate this oven with the microwave door open, since open-door operation can result in harmful exposure to microwave energy. It is important not to defeat or tamper with the safety interlocks.
- b) Do not place any object between the oven front face and the door or allow soil or cleaner residue to accumulate on sealing surfaces.
- c) Do not operate the oven if it is damaged. It is particularly important that the oven door close properly and that there is no damage to: (1) the door (bent), (2) the hinges and latches (broken or loosened), (3) the door seals and sealing surfaces, inside window/glass area.
- d) The oven should not be adjusted or repaired by any one except properly qualified personnel.

YOUR MICROWAVE OVEN MUST BE REGISTERED

It is a Federal requirement that records be maintained on the location of all microwave ovens.

Therefore, please:

1. Fill in the registration card and mail it to us. (The registration card is packed with this manual in the plastic bag.)
2. If you are not the original purchaser of this appliance or if the card is missing, please establish your ownership by writing to us at:

THERMADOR
 Microwave Registration
 5551 McFadden Avenue
 Huntington Beach, CA 92649
3. When writing to us about your oven, please be sure to include the model and serial number.

NOTE: Do not operate the oven with any object trapped between the door and the oven front face.

Service Data Record

Data Plate

Copy the model and serial numbers from the data plate located inside the right upper oven vent on the right hand partition. (See Illustration, Item 3, Page 6). Keep your invoice for warranty validation. Fill in the information below as a handy reference.

 Dealer's Name

 Service Center

 Model Number

 Dealer's Telephone Number

 Service Center's Telephone Number

 Serial Number

 Date of Installation or Occupancy

BY LAW THIS APPLIANCE MUST BE REGISTERED. PLEASE BE CERTAIN THAT IT IS.

General Appliance, Oven and Microwave Oven

SAFETY PRECAUTIONS

Please read all instructions before using this appliance.



WARNING

When properly cared for, your new Thermador oven has been designed to be a safe, reliable appliance. **Read all instructions carefully before using this oven. These precautions will reduce the risk of burns, electric shock, fire, and injury to persons or exposure to excessive microwave energy. When using kitchen appliances, basic safety precautions must be followed, including the following:**

- Read and follow the specific PRECAUTIONS TO AVOID POSSIBLE EXPOSURE TO EXCESSIVE MICROWAVE ENERGY found on Page 2.
- This appliance must be properly installed and grounded by a qualified technician. Connect only to a properly grounded outlet. See “Grounding Instructions” found in the Installation Instructions.
- This appliance should be serviced only by a qualified service technician. Contact the nearest **authorized service center** for examination, repair or adjustment. (See Page 64)
- **Do not** repair or replace any part of the oven unless specifically recommended. Refer service to an authorized servicer.
- **Do not** operate this appliance if it is not working properly or if it has been damaged, until an authorized servicer has examined it.
- Install or locate this appliance only in accordance with the Installation Instructions.
- Use this oven only as intended by the manufacturer. If you have any questions, contact the manufacturer.
- **Do not cover** or block any openings on this appliance.
- Use this appliance only for its intended use as described in this manual. Do not use corrosive chemicals, vapors, or nonfood products in this appliance. This type of oven is specifically designed to heat or cook. It is not designed for industrial or laboratory use. The use of corrosive chemicals in heating or cleaning will damage the appliance.
- **Do not** allow children to use this appliance, unless closely supervised by an adult. Children and pets should not be left alone or unattended in the area where the appliance is in use. Never allow children to sit or stand on any part of the oven.
- **Do not** store items of interest to children above the oven. If children should climb onto the appliance to reach these items, they could be seriously injured.
- To reduce the risk of fire in the oven cavity:
 1. **Do not** store flammable materials in or near the oven.
 2. **Do not** use water on a grease fire. Smother fire or use a dry chemical or foam-type extinguisher.
 3. It is highly recommended that a fire extinguisher be readily available and highly visible next to any cooking appliance.
 4. **Do not** overcook food. Carefully attend oven if paper, plastic or other combustible materials are placed inside the oven.
 5. Remove wire twist-ties from paper or plastic bags before placing in microwave oven.
 6. **Do not** use the cavity for storage purposes. Do not leave paper products, cooking utensils or food in the cavity when not being used.
- If materials inside the oven should ignite, keep oven door closed. Turn oven off and disconnect the circuit at the circuit breaker box.
- **Do not** block any vent openings.
- Be sure the blower fan runs whenever the oven is in operation. If the fan does not operate, **do not** use the oven. Call an authorized service center.
- Never use the oven to warm or heat a room. This can damage the oven parts.
- For personal safety, wear proper clothing. Loose fitting clothes or garments with hanging sleeves should never be worn while using this appliance.

Continued on next page

General Appliance, Oven and Microwave Oven SAFETY PRECAUTIONS

- Tie long hair so that it doesn't hang loose.
- In the event that personal clothing or hair catches fire, **drop and roll immediately to extinguish flames.**
- Use only dry potholders. Moist or damp potholders in contact with hot surfaces may result in burns from steam.
- Do not use a towel or other types of bulky cloth in place of potholders. They may ignite if they touch a hot element.

GENERAL OVEN SAFETY

- Do not touch hot elements or hot interior surfaces of the oven.
- The heating elements may be hot even though they are dark in color. Interior surfaces of an oven become hot enough to cause burns.
- During and after use, do not touch or let clothing or other flammable materials contact the heating elements until they have had sufficient time to cool.
- The trim on top and on the sides of the oven door may become hot enough to cause burns.
- Use care when opening the oven door. Open slightly at first to let hot air or steam escape before removing or replacing food.
- Do not heat unopened food containers. Build-up of pressure may cause the container to burst and result in injury.
- Always place oven racks at desired level while oven is cool. If a rack must be moved while oven is hot, do not let potholder contact the hot elements.

SELF-CLEANING MODE SAFETY

- Clean only oven parts listed in this manual.
- Keep surfaces of door and oven that come together free of soil. Refer to cleaning instructions on Pages 58 – 59.
- Do not clean the mesh door gasket. Care should be taken not to rub, damage, loosen or remove the door gasket. It is essential for a good seal.
- Do not use commercial oven cleaners or oven liner protective coating of any kind in or around any part of the oven.
- Before setting the Self Clean mode, remove the



WARNING

The California Safe Drinking Water and Toxic Enforcement Act requires businesses to warn customers of potential exposure to substances which are known by the State of California to cause cancer or reproductive harm.

The elimination of soil during self-cleaning generates some by-products which are on this list of substances.

To minimize exposure to these substances, always operate this oven according to the instructions in this manual and provide good ventilation to the room during and immediately after self-cleaning the oven.

broiler pan, oven racks, other utensils and excess, soft spillage. Excess soil could pose a fire hazard.

- **Confirm that the door locks and will not open** once **START** is touched and the door lock icon appears. If the door does not lock, touch **OVEN OFF** and **do not run self-clean**. Phone 800-735-4328 for service (see Page 64 for obtaining service).

IMPORTANT: Do not overcook food; fire could result. Proper cooking depends on selecting the correct power level and cooking time for the amount of food in the oven. Smaller portions of food that are cooked too long may catch fire.

- Microwave can be used whether the oven is hot or cold.
- If oven is hot from prior use, only heat-resistant utensils should be used. Take additional care when removing item from oven.
- **DO NOT** operate the microwave, CookSmart or custom combination modes when the oven is empty. The microwave energy will reflect continuously throughout the oven causing overheating if food or water is not present to absorb energy. This could damage the oven and result in risk of fire. **Continued on next page**

Microwave Safety Precautions

Home Canning / Drying / Small Quantities of Foods

- Do not use microwave oven for home canning. It cannot maintain the food at a safe temperature. Improperly canned food may spoil and be dangerous to eat.
- Do not dry meats, herbs, fruits or vegetables. Small quantities or foods with low moisture content can dry out, scorch or catch on fire if overheated.

Deep Fat Frying

- Do not deep fat fry because the oil may ignite into flames and cause damage to the oven or burns.
- Microwave-safe utensils may not withstand the high temperatures of hot oil; they could shatter or melt.

Popcorn

- Microwave popcorn that pops in its own package can scorch or burn if placed directly on the metal rack. Use a microwave safe utensil to hold bag.
- Follow the directions on the bag which are suitable for the microwave wattage of your oven (750 W). Popping times may vary.
- Never leave oven unattended when popping popcorn.
- Allow bag to cool before opening; always open away from your face and body to prevent steam burns.

Foods with Nonporous Skins

- Potatoes, apples, whole eggs, egg yolks, whole squash and sausages are examples of foods with nonporous skins. They must be pierced before cooking to prevent bursting.

Liquids

- Heated liquids can erupt if not mixed with air. Overheated liquids become superheated and may erupt. Stir liquids before and after heating to avoid eruption.

Cooking Utensils

- Utensils get hot during cooking. Use potholders when removing the cookware, lids and plastic wrap to avoid burns.
- Do not heat foods in narrow necked bottles or sealed containers, i.e. closed glass jars. They may explode.

- Dishes with metallic trim should not be used as arcing may occur.
- When food is heated in a metal container, allow at least 1-inch (2.5 cm) spacing from the oven walls. Do not allow metal pans to touch each other or arcing may occur.

Paper Towels / Cloths

- Do not use paper towels or cloths that contain a synthetic fiber woven into them. The fiber may cause the towel to ignite.
- Use paper towels under supervision.

Oven Cooking Bags

- Do not use the wire twist-tie to close bag. Use plastic ties, cotton string or a strip of plastic cut from the open end of the bag.

Baby Formula / Food

- Do not heat baby food in glass jars. Transfer the food to a small dish and gently heat. Stir well and check temperature before serving.
- Heating formula in bottles is not recommended. If done, put nipple on bottle after gently heating. Shake thoroughly to obtain uniform temperature. Wrist test before feeding.

Ready-to-Eat Pastry products

- When reheating, check temperatures of any fillings before eating. The fillings of some foods heat faster than the surface, i.e. jelly donuts. The filling can be extremely hot.

MICROWAVE MODE SAFETY

- Do not tamper with, adjust or repair the door, safety interlock switches or any other part of the oven. Repairs must be done by a qualified service technician.
- Do not operate the microwave mode when the oven is empty. If food or water is not present to absorb the energy, the oven could be damaged with a risk of fire.
- Do not dry clothes, newspapers or other materials in the oven. Newspapers and paper bags are not suitable for cooking; a fire may result.
- Do not use recycled paper products unless it is labeled safe for microwave use. These products may contain impurities that may cause sparks and result in a fire.

Features of Your Oven

MODEL CJ302
DOUBLE OVEN

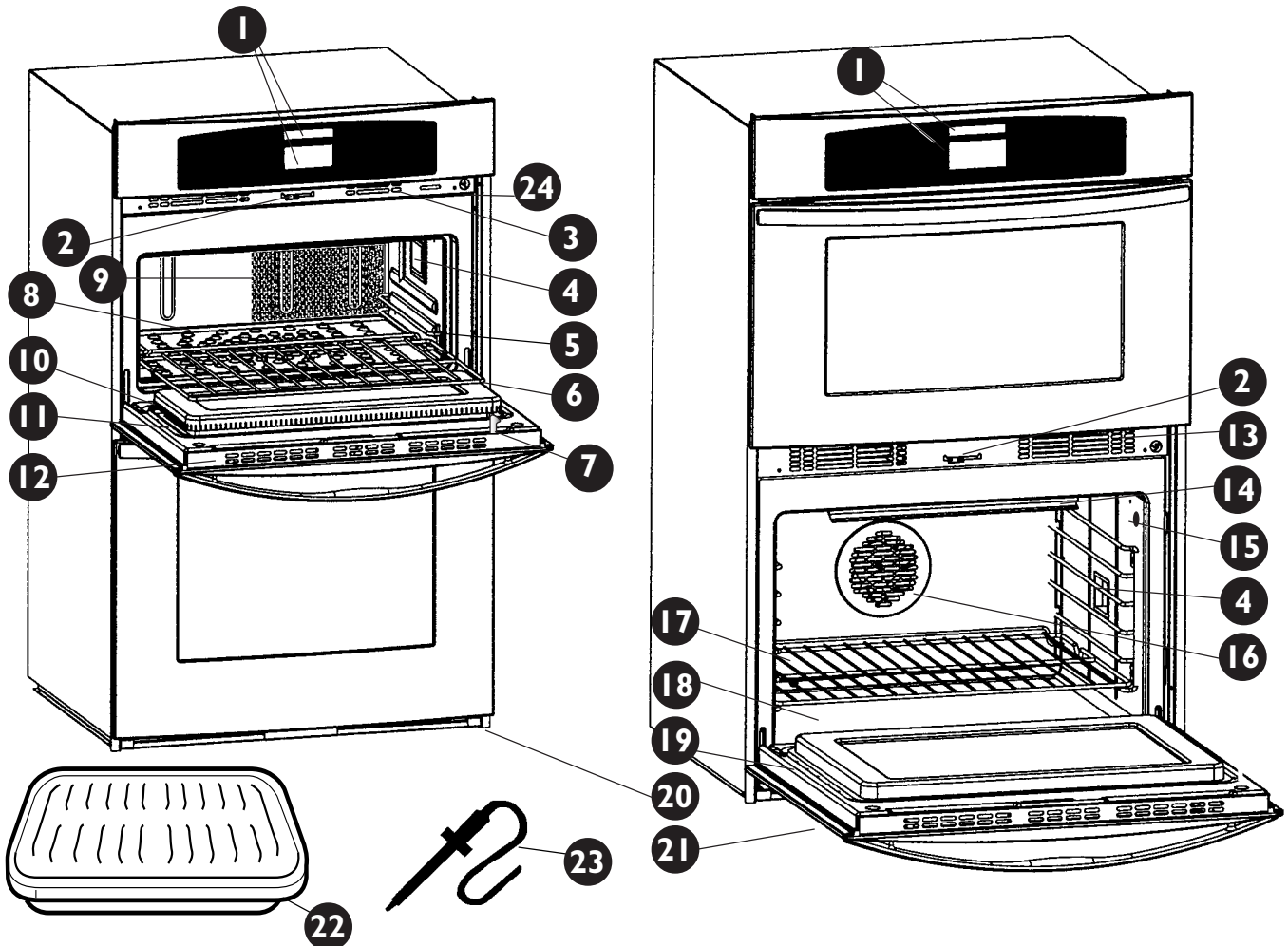

TOUCH CONTROL PANEL

1 Displays clock / time and oven modes and settings

UPPER OVEN

- 2** Door Lock Latch, automatic
- 3** Data Plate - behind oven cooling vents, right side
- 4** Halogen Oven Lamps (2 in each oven)
- 5** Rack Supports
- 6** Removable Rack (1)
- 7** Interlock Latch
- 8** JetDirect Floor Plate
- 9** JetDirect Exhaust Baffle
- 10** Microwave Seal
- 11** Door Gasket, upper oven
- 12** Door Cooling Vents

LOWER OVEN

- 13** Oven Cooling Vents
- 14** Broil Element
- 15** Probe Receptacle
- 16** Convection Fan and Baffle
- 17** Removable Oven Racks (3)
- 18** Bake Element (under oven floor)
- 19** Door Gasket, lower oven
- 20** Oven Exhaust Vent Trim
- 21** Removable Lower Door
- 22** Two-Piece Broil Pan
- 23** Oven Probe
- 24** Rubber Gasket

The Control Panel *

The control panel allows you to set either the upper or lower oven. As you touch the pads, words and numbers appear in the display windows. Touch only one pad at a time.

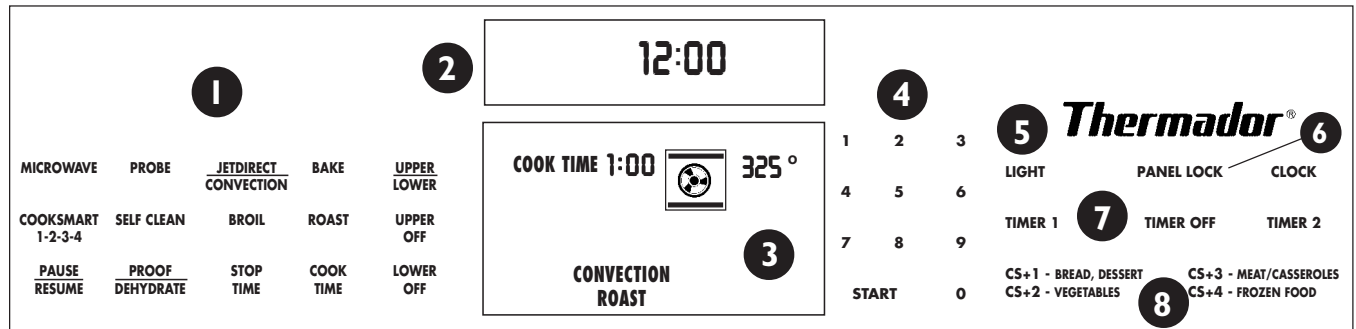

* For additional information and instructions, see page numbers in parentheses.

- 1 CONTROL MENU** – These pads set the oven modes and select the oven to be used. (For upper oven, see Page 12; for lower oven, Page 38.)
- 2 DISPLAY WINDOW – CLOCK/TIMER** – This window shows the clock and timer settings. The Timer setting counts down in minutes. The clock setting displays the time of day and the “panel lock” confirmation.
- 3 DISPLAY WINDOW – MODE** – This window displays the oven selected, cooking or timed mode, elements on the oven, oven temperature, and the preheat function.
- 4 NUMBER PADS and START PAD** – The numbers (1 to 0) are used to select the time of day, temperatures, microwave power level, cook and stop time or timer(s).
Touch the START pad last to start cooking modes or timing functions.
- 5 LIGHT** – turns oven light on or off.
- 6 PANEL LOCK (CHILD LOCKOUT)** – prevents the control pads from being activated when the oven is not being used. To lock cooking modes in the off position, touch and hold for 3 seconds; repeat to cancel.
- 7 CLOCK and TIMERS** – These pads select the CLOCK and TIMERS that operate independently of any oven mode.
CLOCK – selects the time of day on the 12-hour or 24-hour clock.
TIMER – counts down the time in minutes.
TIMER 1 – sets a kitchen timer
TIMER 2 – sets a second kitchen timer
TIMER OFF – turns timer(s) off
- 8 COOKSMART® MENU** – shows the type of food to cook in the preprogrammed settings.
CS+1 – Bread, Dessert
CS+2 – Vegetables
CS+3 – Meat, Casseroles
CS+4 – Frozen Food

SPECIAL FEATURES

- **Sabbath Mode Setting** – complies with some religious requirements (See Page 54).
- **12 or 24 hour clock choice** – clock setting options (See Page 61).
- **Fahrenheit or Centigrade** – temperature setting options (See Page 62).
- **Panel Lock (Child Lockout)** – prevents any cooking mode from being set when oven is not being used (see #6 above).

Sights & Sounds

Interpreting the Control Panel

The directions in the Care and Use Manual for setting the oven and its various modes are based on the assumption that the panel displays and sounds will “lead” or help you set the controls easily. To aid in this path, the following descriptions provide a basis for interpreting what is seen and heard.



Flashing Symbols or Numbers

Signals an incomplete setting; calls for another step or START to be touched.

1 Beep

Signals the receipt of an entry.

2 Beeps

Signal an error in entry.

4 Chimes

Signal the end of a setting.

Probe Symbol

Displays the internal temperature of the meat rather than the oven roasting temperature. Oven temperature can be seen briefly by touching the cook mode after touching START.

Lock Symbol

Displays during the Microwave, CookSmart, and Self-Clean modes and when the door is locked. Do not attempt to open door when lock symbol is displayed. Door can be opened when symbol no longer appears.

PAU

Displays when a microwave program is paused or interrupted and door unlocks.

Err

Displays if an invalid temperature or time is entered.

Power Failure

After the power returns to the oven, the clock displays the time when the power was lost or turned off.

UPPER LOWER

Selects the active oven to be set by highlighting the oven in the mode display window. To use the upper oven, it is not necessary to touch this pad before selecting the cooking mode. If the lower oven is in operation, press the UPPER/LOWER pad to use the upper oven.

Default Settings

The cooking modes automatically select a suitable temperature. These can be changed when a different one is needed. CookSmart settings cannot be changed. Use *Custom Combination Mode* if a specific combination setting is preferred (See Page 31).

START

Touch to complete an entry and before entering an additional one.

UPPER OFF and LOWER OFF

Touch to cancel a mode that has already been started or completed.

COOK TIME

Sets the number of hours and minutes the oven will be “on.” Unlike Timer 1 or 2, the oven turns “off” automatically when the time elapses. This pad is used with the automatic timed oven control.

F Number Codes

These codes are displayed when there is a problem with the signal sent to the electronic control board. See Solving Operational Problems, Page 64.

Convection Fan

The convection fans in both ovens operate during any convection mode. When the oven is operating in the convection mode, the fan will turn off automatically when the door is opened.

An advanced, powerful, high-performance JetDirect convection system is located in the upper oven. This revolutionary impingement convection system moves the heated air at an extremely high velocity and results in foods that are cooked in a much shorter time than standard convection ovens.

This process results in a higher noise level than standard convection ovens. This is normal.

Component Cooling Fan

Activates during any cooking or self-cleaning mode to cool inner components and outer door surfaces. This air is exhausted through the vent located below the lower oven. It continues to run until components have cooled sufficiently.

Setting the Clock

- Always set the clock immediately after installation or after a power failure. Once power returns to the oven, the clock displays the time of day when power was turned off or lost.
- The time of day clock can be set when an automatic timed cooking mode is in operation.
- If 15 seconds elapse between touching the clock pad or number pads, the mode is automatically cancelled. Set again.
- If 24-hour clock is desired, see Page 61.

To Set the CLOCK:

1. Select the **CLOCK** pad.

Touch
CLOCK

You Will See



2. Set the current time of day.
(Example shows 8 o'clock set for the time of day.)

Touch
8
0
0

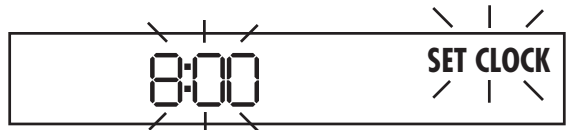

3. Select **START** or **CLOCK**.

Touch
START



Setting the Lights

- Oven lights turn on automatically when the door is opened and off when closed.
- To set manually, always start by highlighting the oven, whether it is "active" or not. (Touch the UPPER / LOWER pad to display the "active" oven; flashing outline indicates the active oven.)
- A single LIGHT pad activates the lights in either oven.
- The **Upper** oven lights are always on when the oven is being used.
- The lights do not operate in the Self Clean mode.

To manually control the interior oven lights if either oven is in use:

1. Select the "active" oven by touching once or twice to highlight oven display.
2. Touch LIGHT once to turn light on or off.

Touch
UPPER
LOWER

Touch
LIGHT

You Will See

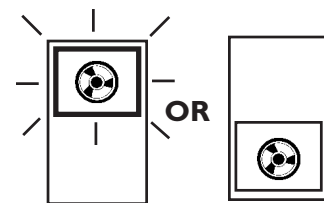

To manually control the upper oven lights if both ovens are in use:

1. To manually turn them off, select UPPER / LOWER until upper oven outline is flashing.
2. Touch LIGHT once to turn light on or off.

Touch
UPPER
LOWER

Touch
LIGHT

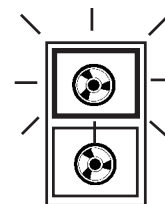

To manually control the lower oven lights if both ovens are in use:

1. Select UPPER / LOWER until lower oven outline is flashing in the display.
2. Touch LIGHT once to turn light on or off.

Touch
UPPER
LOWER

Touch
LIGHT

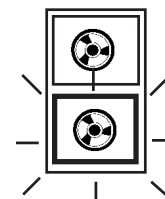

Setting the Timer

- The oven has two timers which are independent of each other. Neither timer controls oven operations.
- Touch once and the timer is set in minutes and seconds.
- Touch twice and the timer is set in hours and minutes.

To Set **TIMER 1** or **TIMER 2**:

You Will See

1. **Select Timer 1 or 2.**

Touch
TIMER 1

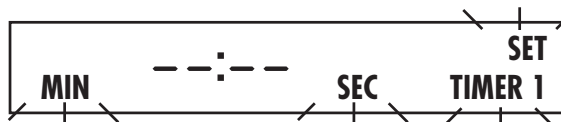

2. **Set the amount of time.**
(Example shows a 3-minute setting with Timer 1.)

Touch
3
0
0



3. **Start Timer.**

Touch
START



4. **When set time is complete,** "End" is displayed and 4 chimes signal. When turned off, display reverts to time of day.

Touch
TIMER OFF



Tip: If timer is not turned off, chimes will continue every 30 seconds. After 5 minutes, chimes stop and the display reverts to the time of day.

To Cancel an Active Timer:

1. **Select Timer in use.**
2. **Cancel Timer.**

Touch
TIMER 1 or **2**

Touch
TIMER OFF

To Set Both **TIMER 1** and **TIMER 2**:

Follow the steps above to set each timer. The timer with the **least amount** of countdown time has display priority. The countdown display for the second timer is shown automatically when the first timer has ended.

The words "TIMER 1" and "TIMER 2" are both displayed along with the number countdown. The word, "TIMER 1" or "TIMER 2", with the **least remaining countdown time** is more brightly lit than the other word.

During the countdown, touch **CLOCK** or **TIMER**. Depending on the pad touched, either the time of day or the remaining time is briefly displayed.

To Change a Timer:

1. **Touch **TIMER 1** or **TIMER 2**.**
2. **Enter the new desired time.**
3. **Touch the **START** pad.**

Upper Oven Heating Modes

The following illustrations give an overview of the heating activity with each mode setting. The arrows represent the heat source for specific cooking modes.

COOKSMART® – **COOKSMART** combines pre-programmed high-speed convection heat (i.e., JetDirect Convection) and microwave energy to cook food in about one-fourth the conventional cooking time. **COOKSMART** modes can be used to cook a variety of foods, such as small or low-profile roasts and meats, casseroles, breads and desserts, vegetables and frozen dinners. See Pages 13-14 for operation.

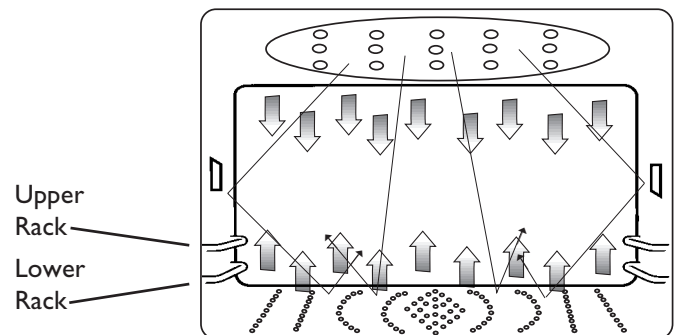

JETDIRECT® CONVECTION – **JETDIRECT** Convection cooks food by using high-speed convection heat. The speed is enhanced using high velocity blowers. The heat flows through the many jets located above and below the food. Food is cooked in approximately 2/3 the conventional cooking time when using **JETDIRECT** Convection. This mode is not an automatic or preprogrammed mode.

JETDIRECT mode can be used for cooking the following foods:

- Larger roasts and larger poultry items, resulting in a crispier exterior that seals in the interior juices.
- Baked items such as popovers, quick breads,

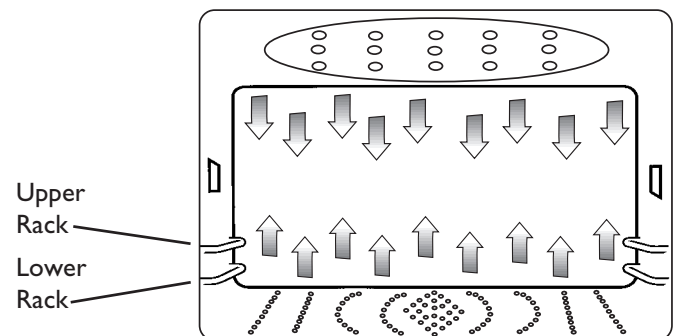

bundt cakes, angel food cake, cream puffs, egg souffles, quiche, pizza, puff pastry and pumpkin pie.

See Page 21 for operation.

MICROWAVE – The microwave mode cooks food by using microwave energy to significantly reduce cook time, depending on the type of food being prepared. The microwaves enter through the upper jet plate in the top of the oven. One of ten power levels may be used when microwaving. See Pages 25-26 for operation.

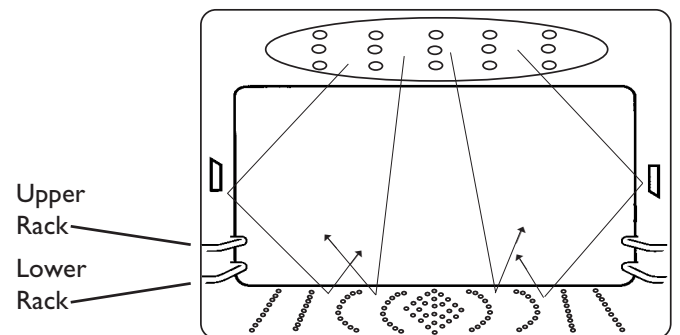

CUSTOM COMBINATION – Custom Combination combines **JETDIRECT** Convection mode and microwave mode to reduce cooking time. This is not a preprogrammed mode; the user selects the oven temperature, microwave power level and cooking time. See Pages 31-33 for operation.

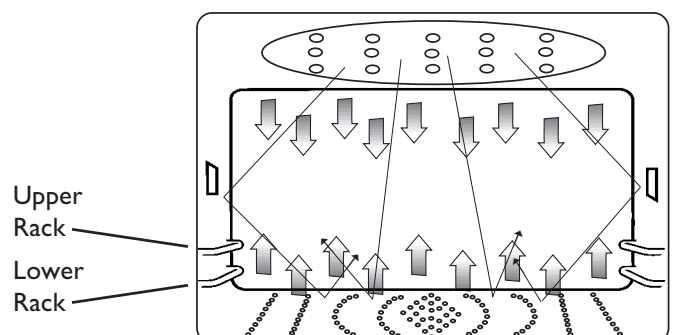

Upper Oven Control Menu

Upper Oven Mode Pads *

MICROWAVE	PROBE	JETDIRECT CONVECTION	BAKE	UPPER LOWER
COOKSMART 1-2-3-4	SELF CLEAN	BROIL	ROAST	UPPER OFF
PAUSE RESUME	PROOF DEHYDRATE	STOP TIME	COOK TIME	LOWER OFF

* Bold pads shown above are used to control the upper oven.

- **MICROWAVE** – selects microwave mode
- **COOKSMART** – selects a preprogrammed or automatic microwave power level and JetDirect Convection temperature
1-2-3-4
- **PAUSE** – use with any microwave or COOKSMART mode to interrupt oven operation
RESUME and check food (locks and unlocks door)
- **SELF CLEAN** – selects the Self Clean mode for either oven
- **JETDIRECT** – use to select a high speed convection for faster cooking
CONVECTION (mode is not preprogrammed or automatic)
- **STOP** – selects the time of day the oven is to automatically turn off
TIME (for Self Clean mode)
- **COOK** – selects the hours/minutes to cook
TIME (for Microwave and CookSmart modes)
- **UPPER**– touch once to select Upper Oven
LOWER
- **UPPER** – touch to turn the upper oven off
OFF

NOTE: Refer to Page 36 when using 120/208-volt connections.

CookSmart Mode Operation – Upper Oven

- *COOKSMART* (CS) combines preprogrammed high-speed convection heat (i.e. JETDIRECT convection) and microwave energy to cook food in about one-fourth of the conventional cook time.
- *COOKSMART* modes include:
 - CS1** – Breads, Desserts **CS2** – Vegetables **CS3** – Meat, Casseroles **CS4** – Frozen Food
- *COOKSMART* modes can be used to cook a variety of foods, such as small or low-profile roasts and meats, casseroles, breads and desserts, vegetables and frozen dinners.
- Enter the conventional cook time called for in your recipe. *COOKSMART* will automatically reduce the time entered to actual cooking time when preheating starts.
- Select bakeware without a cover that is made of either metal, oven-safe glass or glass ceramic. Metal pans become hot quickly and will yield more browning.
- Do not allow metal pans to touch in oven.
- Allow 1 inch of space between metal pans and oven walls.
- Do not use paper towels in *COOKSMART* modes.
- Select rack position before selecting the CS mode. Most *COOKSMART* cooking is done on upper rack.
- Always preheat oven before placing food in oven.
- Use Pause/Resume to check food early.
- **Operate all cooking modes with JetDirect floor plate in place.**

To Set a *COOKSMART* (CS) Mode

1. Select **UPPER** oven.

Touch
UPPER
LOWER

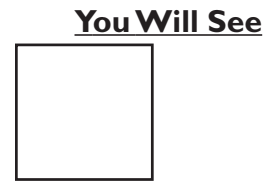

2. Select ***COOKSMART* Mode.**

Touch
COOKSMART
1 – 2 – 3 – 4

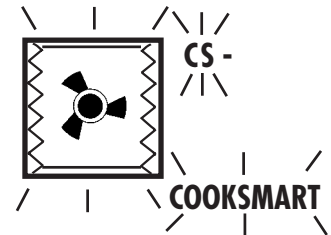

3. Use number pads to select ***COOKSMART* 1, 2, 3 or 4.** Example: CS1.

Touch
1

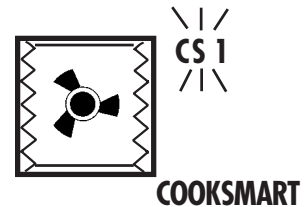

4. Select the **Cook Time.**

Touch
COOK
TIME

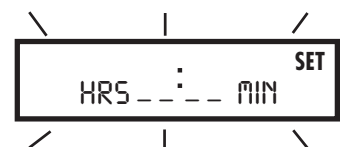

5. Use number pads to set maximum conventional or standard cook time.

- Cook time is displayed in hours and minutes.

Touch
1
2

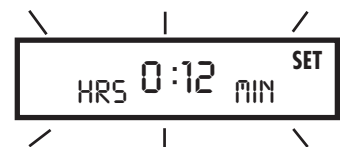

Continued next page.

CookSmart Mode Operation – Upper Oven

You Will See

6. Select **START** to preheat oven and to automatically reduce conventional cooktime by one-fourth.

Example: 12 minutes = 3 minutes.

- When the oven reaches the correct temperature one chime will sound and the word “PREHEAT” disappears.

Touch
START

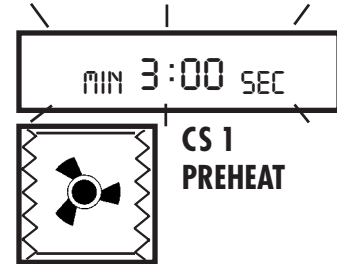

7. After oven is preheated, place food in center of rack and touch **START**.

- Motorized door latch locks door.
- Cooktime starts counting down.

Touch
START



8. To interrupt the mode or check doneness at minimum cooking time:

Pause the cooking process, by selecting **PAUSE/RESUME**.

- The door latch unlocks.
- Cooktime stops counting down.

Touch
PAUSE
RESUME

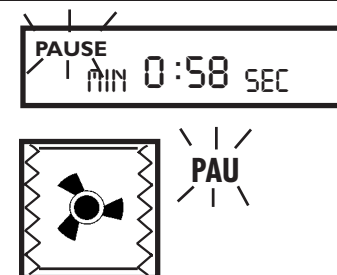

To resume the cooking process, close the door, touch **PAUSE/RESUME** pad again.

- The door latch locks the door.
- Cooktime continues counting down.

Touch
PAUSE
RESUME

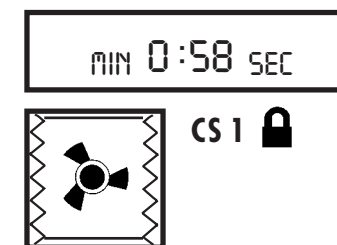

9. At the end of cooking:

- Oven chimes 4 times and the word “End” is displayed.
- The door latch unlocks the door.
- Oven will continue to chime as a reminder to check food.
- When the door is opened, the word “End” disappears from this display and chimes stop.

Touch
UPPER
OFF
- or -
open the door



10. To cancel a **COOKSMART** mode after cooking has started, touch **Upper Off**.

- The door latch unlocks the door.
- Timer display reverts to the time of day.

Touch
UPPER
OFF

11. To add more time to a **COOKSMART** mode after cooking time has ended, and more cook time is needed:

- Repeat steps 1 through 5; then touch **START** two times in succession.

Note: If **START** is not pressed twice, oven will preheat again and microwave will not start.

Touch
START
START

CookSmart Cooking Chart – Upper Oven

CSI - Breads, Desserts

- Metal pans become hot quickly and yield more browning.
- Items cooked in glass may require more time.
- Place food in center of oven for adequate air circulation.
- Biscuits and cookies should be left on pan for 3 to 4 minutes after removal from oven.
- Timings on the chart are a guide.
- Scratch and frozen pies and cobblers work best in this mode but will need additional time. See chart.

CSI BREADS, DESSERTS	RACK LEVEL	PAN SIZE AND TYPE (Pan measurements in inches)	CONVENTIONAL COOK TIME
Breads, Yeast French, Cuban, Baguettes or Braid	Upper	15x12 cookie sheet or 15x10-1/2 x1 jelly roll pan	25 to 30 minutes
Focaccia	Lower	15x10-1/2 x1 jelly roll pan	20 to 25 minutes
Rolls Cinnamon, scratch, 12 Cinnamon, refrigerator, large size Crescent Rolls, refrigerator, 8 oz. Croissant Rolls, 15.5 oz. Dinner rolls, scratch, 10 to 12	Upper Upper Upper Upper Upper	9x13 pan 8" square or round pan 15x12 cookie sheet 15x12 cookie sheet 15x12 cookie sheet or 15x10-1/2 x1 jelly roll pan	20 to 25 minutes 25 to 29 minutes 11 to 13 minutes 18 to 22 minutes 14 to 19 minutes
Dinner rolls, frozen	Upper	8" round pan, 12-cup muffin tin or 15x12 cookie sheet	18 to 22 minutes
Breads, Specialty Bread, Garlic, Fresh (1 lb.) Bread, Garlic, Frozen (1 lb.) Bread, Bruschetta (8 oz.) Corn bread, mix Muffins Scratch, nut variety Mini muffins, mix or scratch Quick Bread Scratch Mix Mix Mini loaves Scones, 8 to 10	Lower Lower Lower Upper Upper Upper Upper Upper Upper Upper Upper Upper Upper	15x10-1/2 x1 jelly roll pan Place on oven rack. 15x10-1/2 x1 jelly roll pan 8x8 or 9x9, metal or Pyrex pan 12-cup muffin pan (2) 12-cup mini-muffin pans 8x4 loaf pan 8x4 loaf pan 9x5 loaf pan (3) 3x5 loaf pans 15x12 cookie sheet	5 to 8 minutes 6 to 8 minutes 5 to 8 minutes follow package time 25 to 30 minutes 26 to 28 minutes 58 to 62 minutes 60 to 65 minutes 50 to 55 minutes 44 to 48 minutes 14 to 17 minutes
Biscuits Refrigerator, 12 oz. Refrigerator, 16 oz. Scratch or mix, 12	Upper Upper Upper	8-inch round pan 15x12 cookie sheet 15x12 cookie sheet	10 to 14 minutes 11 to 15 minutes 12 to 14 minutes

CookSmart Cooking Chart – Upper Oven

(continued from previous page)

CSI BREADS, DESSERTS	RACK LEVEL	PAN SIZE AND TYPE (Pan measurements in inches)	CONVENTIONAL COOK TIME
Brownies Fudge, Scratch Fudge, Mix, 20 to 22 oz.	Upper Upper Upper Upper	8x8 or 9x9 metal or glass 9x13 metal or glass 8x8 or 9x9 metal or glass 9x13 metal or glass	30 to 40 minutes 25 to 30 minutes 40 to 45 minutes 30 to 35 minutes
Cakes, Specialty Pineapple Upside-Down Streusel Coffeecake, mix Gingerbread, Scratch	Upper Upper Upper Upper Upper	8" round glass dish 9x13 metal or glass 9x9 glass or 9" cake pan 12 cup bundt pan 9x9 metal pan	50 to 55 minutes 35 to 40 minutes 25 to 30 minutes 40 to 44 minutes 40 to 45 minutes
Cookies Bar Drop Rolled Refrigerated Dough Frozen Dough	Upper Upper Upper Upper Upper	15x10-1/2x1 jelly roll pan 15x12 cookie sheet 15x12 cookie sheet 15x12 cookie sheet 15x12 cookie sheet	20 to 25 minutes 8 to 12 minutes 7 to 9 minutes 9 to 13 minutes 18 to 24 minutes
Desserts Cream Puffs, mini (20)	Upper	15x10-1/2x1 jelly roll pan	25 to 30 minutes
Pastry Crust Scratch Refrigerated Frozen Graham Cracker	Upper Upper Upper Upper	9" metal or glass pie pan 9" metal or glass pie pan 8" or 9" foil pie pan 9" metal or glass pie pan	15 to 20 minutes 9 to 13 minutes 7 to 9 minutes 4 to 5 minutes
Pies, Cobblers, Fruit Crisps Pie, two-crust scratch or frozen	Lower	8" or 9" foil or pan	70 to 80 minutes*
Cobbler, fruit, with biscuit topping	Upper Upper	8x8 or 9x13 metal or glass 2 quart deep dish	30 minutes 20 to 25 minutes
Cobbler, fruit, 2-crust, frozen 1 lb. 2 lb.	Lower Lower	Leave in original container Leave in original container	70 to 80 minutes* 70 to 80 minutes*
Crisp, fruit (peach or apple)	Upper Upper	8x8 metal or glass 9x13 glass	30 minutes 35 minutes
Pot pie, frozen, 1 lb.	Lower	15x12 cookie sheet	80 to 90 minutes*

* May need longer cooking time.

CookSmart Cooking Chart – Upper Oven

CS2 – Vegetables

- Peel or pierce fruits and vegetables to prevent bursting.
- These cooking times work best for fresh vegetables.

CS2 VEGETABLES	RACK LEVEL	PAN SIZE AND TYPE (Pan measurements in inches)	CONVENTIONAL COOKING TIME
Apples Baking, 4 large, halved	2	8x8 glass pan.	40 to 45 minutes
Asparagus 1 lb.	2	Bottom of 2-piece broil pan.	15 minutes
Carrots Quartered, cut into 2" strips	2	Bottom of 2-piece broil pan.	30 to 35 minutes
Corn 6 ears, husks removed	2	9x13 glass pan.	30 to 35 minutes
Mushrooms, stuffed	2	15x10 ⁻¹ /2x1 jelly roll pan.	15 to 16 minutes
Potatoes, Baking			
Large 10 to 12 oz. (2)	2	Place on oven rack.	80 to 90 minutes
Medium 7 to 9 oz. (4)	2	Place on oven rack.	65 to 70 minutes
Small 4 to 6 oz. (4)	2	Place on oven rack.	55 to 60 minutes
Potatoes, New Quartered, 3 lbs.	2	Bottom of 2-piece broil pan.	40 minutes
Squash, Winter 4 halves, placed face down in dish	2	9x13 glass pan.	60 to 65 minutes
Tomatoes 4 or 6 halves, with crumb topping	2	8x8 glass pan.	15 to 20 minutes
Vegetables, Assorted 6 cups, cut into 1" pieces	2	Bottom of 2-piece broil pan.	35 to 40 minutes
12 cups, cut into 1" pieces	2	Bottom of 2-piece broil pan.	50 to 60 minutes
Yams, Whole Large, 12 to 15 oz.	2	Bottom of 2-piece broil pan.	80 to 90 minutes
Medium, 8 to 10 oz.	2	Bottom of 2-piece broil pan.	50 to 55 minutes
Yams, Candied	2	9x13 glass pan.	30 to 35 minutes

- Frozen vegetables are prepared using microwave mode.

CookSmart Cooking Chart – Upper Oven

CS3 – Meat, Casseroles

- Allow refrigerated meats and poultry to stand at room temperature for 15 to 20 minutes before cooking.

Meats

- Select low-profile roasts up to 3-inches thick.
- Use bottom of two-piece broil pan for roasts. For larger roasts and meatloaf, refer to custom combination mode on Page 34.
- Calculate the total minutes per pound and enter total cook time.
- As the total weight increases, the cooking time per pound decreases.
- Cook all meats uncovered on the upper rack unless otherwise specified.
- Do not leave a meat thermometer in meat during roasting.
- Score fat on roasts before cooking.
- Do not cook food with large amounts of liquid.

- Brush lean cuts of meat and fish with vegetable or olive oil before roasting to prevent sticking.
- Check food for doneness with meat thermometer at minimum time.
- When a recipe has a two-step temperature/time cooking method, such as rack of lamb, use the total time from both steps to set cook time.
- Marinated and non-marinated meats require the same cooking time.
- **Because of the combination of thermal heat with microwave, foods will continue to cook and internal temperatures will rise during standing time.**

CAUTION!

When roasting, **open the door carefully**. There may be an accumulation of steam, smoke and spattering of fats due to speed of cooking.

CS3 MEATS	WEIGHT	CONVENTIONAL TIME Minutes Per Pound	DONENESS*
Beef: Tri-tip 1 Roast 2 Roasts Tenderloin Roast 1 Roast 2 Roasts	1-1/2 to 3 lbs. 3 to 5 lbs. 1 lb. to 2 lbs. 2 to 4 lbs.	32 to 34 minutes / lb. 21 to 23 minutes / lb. 30 to 32 minutes / lb. 18 to 20 minutes / lb.	Beef and lamb should be removed from oven at the end of cooking time. Cover with foil and allow to stand 10 to 20 minutes. Temperature will rise 20° F to 30° F during standing time. Serving temperatures should be 135° F – rare; 145° F – medium rare; and 150° F – medium.
London Broil	2 - 2-1/2 lbs.	21 to 23 minutes / lb.	
Ribs (To increase tenderness and flavor, ribs may be parboiled for 1 to 2 minutes before applying dry seasoning rub.)	3 – 4 lbs. (5 – 7 bones)	60 to 70 minutes total time	
Meat Balls, ground beef or turkey	1 lb. (35 to 40 1-inch meatballs)	15 to 20 minutes total time	Space evenly on jelly roll pan.
Pork: Spare Ribs Loin Back Ribs	3 to 5 lbs. 1-1/2 to 3 lbs.	1 hr. 45 min. to 1 hr. 50 60 to 70 minutes total time	Add sauce last 5 minutes of roasting. Let stand 10 minutes. Add sauce last 1-1/2 minutes of roasting. Let stand 10 minutes.
Lamb: Rack Rack, Crown	1-1/2 to 2 lbs. 3 to 4 lbs.	24 to 26 minutes / lb. 18 to 19 minutes / lb.	See beef information for doneness.

Chart continued next page

* See Page 46 for Food Safety Guidelines.

CookSmart Cooking Chart – Upper Oven

CS3 - MEAT, CASSEROLES, *continued from previous page*

Poultry

- Roast whole unstuffed chickens with breast-side up; tuck wing tips back and loosely tie legs with kitchen string.
- Whole unstuffed turkeys can be roasted using custom combination (Page 34).
- A basting sauce keeps the outside skin moist.
- Do not leave a meat thermometer in meat during roasting.
- Marinate boneless, skinless chicken breasts before cooking.
- Stuffed poultry is not recommended in this mode.
- Check inner thigh area for doneness with meat thermometer.
- Pound boneless, skinless chicken breasts for uniform thickness and more even cooking.
- If roasting bags are used, cooking time may need to be increased.

CS3 POULTRY	WEIGHT	CONVENTIONAL COOK TIME	DONENESS
Chicken: Breasts - with bones/skin (place in pan with skin up)	1 to 1-1/2 lbs. 2 to 2-1/2 lbs. 3 to 4 lbs.	27 to 28 minutes / lb. 20 to 22 minutes / lb. 17 to 19 minutes / lb.	Whole chicken and cornish hens should be removed from oven when internal temperature reaches 155° F to 160° F. Cover with foil and allow to stand 10 to 15 minutes. Temperature will rise 10° F to 15° F during standing time and juices should run clear. Serving temperatures should be 170° F to 175° F.
Breasts, Boneless, Skinless marinated	1/2 to 1 lb. 1 to 1-1/2 lbs. 1-1/2 to 2-1/2 lbs. 2-1/2 to 3-1/2 lbs. 3-1/2 to 4 lbs.	17 to 20 min. total time 21 to 25 min. total time 26 to 34 min. total time 33 to 39 min. total time 38 to 44 min. total time	
Pieces	1 to 1-1/2 lbs. 2 to 3 lbs. 3-1/2 to 4-1/2 lbs.	21 to 22 minutes / lb. 16 to 17 minutes / lb. 14 to 15 minutes / lb.	
Whole Chicken, (1) unstuffed (place on V-rack in oven pan)	3 to 5 lbs. 5-1/2 to 7 lbs.	26 to 27 minutes / lb. 23 to 24 minutes / lb.	
Whole Chickens, (2) unstuffed (place on V-racks in oven pan)	6 to 10 lbs.	15 to 16 minutes / lb.	
Cornish Hens, unstuffed, 2 *	Approx. 1-1/2 lb. each	55 to 60 min. total time	
Cornish Hens, unstuffed, 4 *	Approx. 1-1/2 lb. each	50 to 55 min. total time	
Fish: Salmon Fillets (1-1/2 to 2" thick)	1/2 to 1 lb. 1-1/2 to 3 lbs. 1/2 to 1 lb. 2 to 2-1/2 lbs.	16 to 20 min. total time 25 to 26 min. total time 18 to 22 min. total time 32 min. total time	Because of the tender qualities of fish, this item performs well at a high temperature for a short cooking time. Line roasting pan with foil, season as desired and place skin-side down in pan. When cooking is done, cover with foil and allow to stand for 10 minutes. Fish will flake with a fork at end of standing time.
Salmon Steaks (1 to 1-1/4" thick)	1 to 1-1/2 lbs. 2 to 2-1/2 lbs.	20 to 24 min. total time 35 to 40 min. total time	
White Fillets (1/2 to 3/4" thick)	1/2 to 1 lb. 1-1/2 to 2 lbs.	14 to 16 min. total time 24 to 26 min. total time	
White Fillets (3/4" to 1" thick)	1/2 to 1 lb. 1-1/2 to 2 lbs. 2 to 2-1/2 lbs.	10 to 12 min. total time 22 to 26 min. total time 30 to 35 min. total time	
White Steaks (1" thick)	1/2 to 1 lb. 1 to 1-1/2 lbs.	13 to 14 min. total time 19 to 20 min. total time	

* (Place on flat rack in oven pan)

Chart continued next page

CookSmart Cooking Chart – Upper Oven

CS3 – CASSEROLES, *continued from previous page*

- Select shallow, oblong or oval-shaped casserole dishes.
- When cooking casseroles with cheese toppings, add cheese during the last 3 to 4 minutes.
- Reduce amount of fine bread crumb toppings.
- As with conventional cooking, cold, refrigerated casseroles will need additional time.
- Cover casseroles with foil for first half of cooking time to prevent over browning.

CASSEROLES Scratch Recipes	RACK LEVEL	PAN SIZE AND TYPE (Pan measurements in inches)	CONVENTIONAL COOK TIME
Chicken Divan	2	9x9 glass	40 to 45 minutes
	2	9x13 glass	45 to 50 minutes
Egg Strata	2	9x13 glass	65 to 70 minutes
Enchilada Casserole	2	9x13 glass	40 minutes
Enchiladas, Chicken	2	9x13 glass	30 minutes
Lasagna*	2	9x13 glass	45 to 50 minutes
Macaroni and Cheese	2	2-quart casserole	30 to 35 minutes
Mostaccioli Casserole	2	7x12 glass or casserole	35 to 40 minutes
Scalloped Potatoes	2	9x13 glass	1 hour 40 minutes
Shepherd's Pie	2	9x13 glass	30 to 45 minutes
Stuffed Green Peppers	2	9x9 glass	45 to 55 minutes
Tuna Noodle Casserole	2	2-quart casserole	30 minutes
Turkey Tetrazzini	2	2-quart casserole	15 to 20 minutes

* Lasagna should be covered with foil during first half of cooking time to prevent over-browning. Add cheese on top after foil is removed.

CS4 – Frozen Cooked Foods

- Heat frozen packaged entrees, dinners, and casseroles in original container.
- Oversize frozen cooked foods, i.e. entrees and casseroles that are 20 oz. and larger, are cooked in Lower Oven Bake mode.
- Homemade frozen casseroles are cooked in the Lower Oven Bake mode.
- Small size frozen combination meals, i.e. less than 10 oz., are best cooked in the Microwave mode.
- To set cooking time, use the conventional oven time on the package (not microwave heating time). Use minimum recommended time and add more time if necessary.
- Follow package directions for removing cover, covering with foil, venting package, etc.
- Frozen items (20 ounces or more), such as lasagna or macaroni and cheese, may need more time. Rotate container in oven then add more time. Cover with foil during first half of cooking time if food browns too quickly.
- Frozen fruit pies or cobblers are baked using CookSmart I (Breads, Desserts). See CookSmart I chart on Page 16.
- Fresh frozen vegetables are cooked in the Microwave mode. Follow microwave instructions on package.
- Frozen fruit turnovers are baked using JetDirect mode. See chart on Page 23.

JETDIRECT Convection Operation – Upper Oven

JETDIRECT Convection cooks foods by using high-speed convection heat.

JETDIRECT is not an automatic mode and requires manual reduction of temperature and time.

JETDIRECT mode can be used for cooking the following foods:

- Larger roasts and poultry items, resulting in a crispier exterior that seals in the interior juices.
- Baked items such as bundt cakes, angel food cake, pumpkin pie, pizzas, puff pastry and egg dishes such as cream puffs, popovers, soufflés, and quiche.
- **When baking, always reduce the oven temperature 50°F.**
- When roasting meats, there is no need to reduce oven temperature.
- When baking or roasting, **reduce the conventional or standard cooking time by one-third.**
- As Jet Direct is not an automatic mode, the oven does not automatically turn off at end of cooking time.
- Always preheat oven before placing food in oven.
- To fully utilize the convection system, cook food uncovered on low-sided pans.
- Use metal pans for better browning and faster cooking.
- If roasting bags are used, cooking time may need to be increased.
- Set timer early as a reminder to check doneness of the food.
- Refer to Cooking Charts for correct rack position.

To set JETDIRECT Convection Mode

1. Select once for the **UPPER OVEN**.

Touch
UPPER
LOWER

You Will See



2. Select **JETDIRECT**
Oven temperature is preset to 325°F.
If a different temperature is needed, touch the number pads to set a new temperature.

Touch
JETDIRECT
CONVECTION

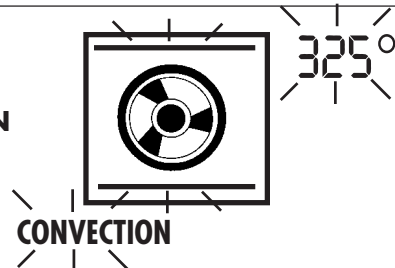

3. Select **START**

- The temperature display alternates between the set temperature and the actual temperature, beginning with 100°F. The actual temperature counts up in 5° increments.
- The oven is preheated when the chime signals once. PREHEAT will disappear from the display.
- Place food on center of oven rack.
- Use a handy kitchen timer or touch **OVENTIMER 1** or **OVENTIMER 2** to set cooking time for 1/3 less than the conventional or standard cook time. Example: 60 minutes cook time = 40 minutes JetDirect cook time.

Touch
START

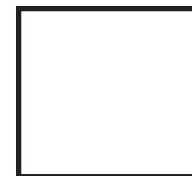

100°/350°
PREHEAT

4. Touch **START** to begin oven timer countdown.
5. When timer sounds, check food. Add additional time if necessary.

6. Touch **UPPER OFF** to end this mode. Oven does not turn off automatically.

Touch
UPPER
OFF

JETDIRECT Convection Cooking Chart

- Chart temperatures/times have been reduced for baking in this mode. Cooking times are a guide.

BAKED FOODS	UTENSIL (Pan measurements in inches)	JETDIRECT OVEN TEMPERATURE	RACK LEVEL	APPROXIMATE COOK TIME
Breads, Yeast Loaves, 1 or 2 Rolls, Dinner, 8 to 12 Rolls, Sweet, 12	9x5 or 8-1/2x4-1/2x2 loaf pans 15x12 cookie sheet or 9" cake pan 9x13 metal pan	325°F (163°C) 375°F (190°C) 350°F (177°C)	Upper Upper Upper	17 to 24 minutes 9 to 10 minutes 10 to 12 minutes
Breads, Specialty Cinnamon Rolls, 17.5 oz. refrig. Cornbread Mix, 15-16 oz. pkg Scratch Muffins Mini-muffins Popovers Quick Breads, Scratch or mix Rolls, Crescent, refrigerated	8" round cake pan 8x8 or 9x9 metal or glass pan 8x8 or 9x9 metal or glass pan 12-cup muffin tin (2) 12-cup muffin tins Six 6 oz. custard cups 8-1/2 x 4-1/2x2 loaf pans 15x12 cookie sheet	300°F (149°C) 350°F (177°C) 350°F (177°C) 375°F (190°C) 325°F (163°C) 350°F (190°C) 325°F (163°C) 325°F (163°C)	Upper Upper Upper Upper Upper Upper	17 to 19 minutes 13 to 18 minutes 13 minutes 11 to 13 minutes 15 to 16 minutes 26 to 27 minutes 40 to 45 minutes 7 to 9 minutes
Biscuits Scratch or mix Refrigerator, 8 oz. to 12 oz. Refrigerator, large size	15x12 cookie sheet 15x12 cookie sheet or 9" cake pan 15x12 cookie sheet	400°F (205°C) 400°F (205°C) 325°F (163°C)	Upper Upper Upper	6 to 7 minutes 4 to 5 minutes* 8 to 9 minutes
Brownies, fudge Scratch Mix	8x8 or 9x9 metal or glass pan 8x8 or 9x9 metal or glass pan 9x13 metal or glass pan	325°F (163°C) 300°F (149°C) 300°F (149°C)	Upper Upper Upper	16 to 20 minutes 23 to 30 minutes 17 to 20 minutes
Cakes, scratch or mix Coffee Cake, Streusel Coffee Cake, Streusel Bundt Carrot Cake Angel Food	8x8 or 9x9 9 x 13 10" Bundt pan 9x13 metal or glass 10" Angel food cake pan	300°F (149°C) 300°F (149°C) 300°F (149°C) 300°F (149°C) 300°F (149°C)	Upper Upper Upper Upper Lower	23 to 26 minutes 23 to 27 minutes 26 to 40 minutes 26 to 53 minutes 31 to 32 minutes
Cookies: Drop Sliced Bar	15x12 cookie sheet 15x12 cookie sheet 15x10x1 pan	325°F (163°C) 325°F (163°C) 325°F (163°C)	Upper Upper Upper	6 to 7 minutes 6 to 7 minutes 13 to 15 minutes
Cream Puffs	15x12 cookie sheet	350°F (177°C)	Upper	20 to 23 minutes
Egg Dishes Souffle	1 qt. souffle dish	300°F (149°C)	Upper	33 to 40 minutes
Pastry Crust Scratch Graham Cracker or Cookie Crumb Refrigerator Frozen	9" metal or glass pie pan 9" metal or glass pie pan 9" metal or glass pie pan 8" or 9" foil pie pan	400°F (205°C) 325°F (163°C) 400°F (205°C) 350°F (177°C)	Lower Lower Lower Lower	7 to 8 minutes 3 minutes 4 to 6 minutes 4 to 5 minutes
Pies Two crust, scratch Two crust, frozen Pumpkin, scratch Quiche, pre-baked crust	9" metal or glass pie pan 8" or 9" foil pie pan 9" metal or glass pie pan 9" metal or glass pie pan	350°F (177°C) 350°F (177°C) Preheat 400°F (205°C) Bake at 300°F (149°C) 300°F (149°C)	Lower Lower Lower Lower	36 to 43 minutes 40 minutes 36 to 40 minutes 29 to 31 minutes
Puff Pastry Frozen Sheets Frozen Turnovers	15x12 cookie sheet 15x12 cookie sheet	350°F (177° C) 350°F (177° C)	Upper Upper	10 to 12 minutes 16 to 17 minutes

* May need less time.

Continued next page

<p>Pizza Scratch, 12" crust Add Pizza toppings Frozen, Individual Frozen, 12" Prebaked crust, 12" Rising crust, Frozen, 8" or 12"</p>	<p>12" pizza pan place on oven rack place on oven rack place on oven rack</p>	<p>350°F (177° C) Reduce pkg temp. 50° F Reduce pkg temp. 50° F Reduce pkg temp. 50° F Reduce pkg temp. 75° F</p>	<p>Upper Upper Upper Upper</p>	<p>8 to 9 minutes Bake additional 5 to 6 min. Check at or before 2/3 of package time</p>
MEAT and POULTRY	JETDIRECT OVEN TEMPERATURE	RACK LEVEL	COOK TIME	END TEMP/ CARVING TEMP
<p>Beef: Boneless Rib Roast, 3-6 lbs. Standing Rib Roast 3-6 lbs. 6 to 8 lbs. Tenderloin, 1-1/2 to 2-1/2 lbs. Tri Tip, 1-1/2 to 2-1/2 lbs. Meatballs 1 lb. ground beef or turkey 35-40 1-inch meatballs</p>	<p>325°F (163°C) 325°F (163°C) 325°F (163°C) 425°F (219°C) 425°F (219°C) 350°F (177°C)</p>	<p>Upper Upper Upper Upper Upper Upper</p>	<p>18 to 21 minutes/lb. 18 to 21 minutes / lb. 15 to 17 minutes / lb. 30 to 33 min. total time 26 to 28 min. total time 10 to 13 min. total time</p>	<p>130°F / 140°F Rare (55°C / 60°C) 140°F / 150°F Med. Rare (60°C / 66°C) 150°F / 160°F Medium (66°C / 71°C) 160°F / 170°F Well Done (71°C / 77°C)</p>
<p>Chicken: Whole, unstuffed 3-1/2 to 4 lbs. 5 to 7 lbs. Pieces, with bones/skin 2 to 4 lbs. Breasts, boneless/skinless 1-1/2 to 2 lbs. Cornish game hens</p>	<p>375°F (190°C) 375°F (190°C) 375°F (190°C) 375°F (190°C) 375°F (190°C)</p>	<p>Upper Upper Upper Upper Upper</p>	<p>10 to 12 minutes / lb. 9 to 11 minutes / lb. 11 to 13 minutes / lb. 9 to 10 minutes / lb. 40 to 45 min. total time</p>	<p>165°F / 170°F (74°C / 77°C) 165°F / 170°F (74°C / 77°C) 165°F / 170°F (74°C / 77°C) 165°F / 170°F (74°C / 77°C) 165°F / 170°F (74°C / 77°C)</p>
<p>Turkey: Whole Breast, w/bone, 5 to 7 lbs. Half Breast, w/bone, 2 to 3 lbs. Boneless (tied/netted), 3 to 4 lbs.</p>	<p>325°F (163°C) 375°F (190°C) 425°F (163°C) 325°F (163°C)</p>	<p>Lower Upper Upper Upper</p>	<p>10 to 12 minutes/lb. 19 to 21 minutes/lb. first 15 minutes, then 45 additional minutes</p>	<p>165°F / 170°F (74°C / 77°C) 165°F / 170°F (74°C / 77°C) 165°F / 170°F (74°C / 77°C) 165°F / 170°F (74°C / 77°C)</p>
<p>Lamb: Leg or Shank 3 to 6 lbs. Rack of Lamb 1 to 3 lbs. Leg, boneless (tied) Chops, 1/2" to 1" Chops, 1" - 1 1/2"</p>	<p>325°F (163°C) 375°F (190°C) 325°F (163°C) 375°F (190°C) 375°F (190°C)</p>	<p>Upper Upper Upper Upper Upper</p>	<p>20 minutes/lb. 15 minutes/lb. 13 to 15 minutes/lb. 12 to 14 min. total time 14 to 16 min. total time</p>	<p>135°F / 145°F Med. Rare (57°C / 63°C) 135°F / 145°F Med. Rare 135°F / 145°F Med. Rare (57°C / 63°C)</p>
<p>Pork: Loin, Boneless 3 to 5 lbs. Shoulder, boneless Sirloin cut, bone-in Tenderloins (2) Chops, 1/2" Chops, 1" - 1 1/2" Chops, 1 1/2" - 2"</p>	<p>325°F (163°C) 325°F (163°C) 325°F (163°C) 425°F (219°C) 375°F (190°C) 375°F (190°C) 375°F (190°C)</p>	<p>Upper Upper Upper Upper Upper Upper Upper</p>	<p>20 minutes/lb. 21 minutes/lb. 23 minutes/lb. 16 to 23 min. total time 11 to 13 min. total time 14 to 16 min. total time 16 to 18 min. total time</p>	<p>155°F / 160°F Medium (68°C / 71°C) 165°F / 170°F Well Done 155°F / 160°F Medium (68°C / 71°C) 165°F / 170°F Well Done (74°C / 77°C)</p>
<p>Veal: Rolled roast, boneless 1 to 3 lbs. Shoulder, bone-in 1 to 3 lbs. Chops, 1" - 1 1/4"</p>	<p>325°F (163°C) 325°F (163°C) 375°F (190°C)</p>	<p>Upper Upper Upper</p>	<p>20 to 24 minutes/lb. 21 to 23 minutes/lb. 14 to 16 min. total time</p>	<p>130°F / 140°F Rare (55°C / 60°C) 140°F / 150°F Med. Rare (60°C / 66°C) 150°F / 160°F Medium (66°C / 71°C)</p>

Basics for Microwave Mode – Upper Oven

Refer to Pages 4 and 5 for microwave safety precautions.

Utensils

Recommended for Microwave Mode

- Glass ceramic (Pyroceram®, such as CorningWare®)
- Heat-safe glass (i.e. Pyrex®)
- Microwave-safe plastics
- Paper plates, paper cups
- Microwave-safe pottery, stoneware, porcelain
- Browning dish: follow manufacturer's directions for preheating dish.
- Metal Bakeware

Tips

- Microwave energy may cause some arcing between metal objects. Small amounts of arcing are neither harmful nor hazardous.
- To check whether a dish or mug is safe to use in this mode, put empty item on rack and heat on High for 30 seconds. If it becomes very hot, do not use it.

Not Recommended for Microwave Mode

- Non-heat resistant glass
- Food carton with metal handle
- Non-microwave-safe plastics (i.e. margarine tubs)
- Styrofoam containers or cups
- Metal or non-microwaveable plastic commuter beverage containers
- Recycled paper products (i.e. brown shopping bags)
- Metal twist ties
- Food storage bags

Recommended Disposable Covers

- Paper towels (See Page 5)
- Wax paper
- Microwave-safe plastic wraps (vent so steam escapes). Do not allow plastic wrap to touch food.
- Parchment paper

Food Selection

- **Quantity** - The cooking time is dependent on the amount of food in the oven.
- **Content** – The amount of fat, sugar and liquid in the food affects the cooking time. For example, eggs, cheese, mayonnaise, etc., cook very quickly.
- **Density** – A non-porous food, such as roast, takes longer to cook than a porous food such as bread.
- **Shape and Size** – Uniform shapes and sizes cook more evenly.

Cooking Techniques

- **Arranging** – Place food in a circular pattern with the thickest areas toward the outside of dish.
- **Covering** – Most foods cook and reheat more evenly when covered.
- **Piercing** – Foods with skins or membranes must be pierced, scored or have a strip of skin peeled before cooking to allow steam to escape.
- **Shielding** – Cover thinner areas of food with foil to prevent over-cooking or defrosting too quickly, such as chicken drumsticks. Allow one inch of space between foil and surfaces. Do not wrap baking potatoes in foil.
- **Stirring and Turning** – Stir foods from the outer edges toward center of utensil or turn food over once during cooking. Stir liquids before and after heating to help prevent “eruption.”
- **Standing Time** – It is necessary to allow food to stand to complete cooking.

Guide to Power Levels (Rated 750W)

HI (100%)	Poultry, fish, fresh and frozen vegetables, casseroles, boil water, pop corn, pudding.
9 (90%)	Reheat rice and pasta.
8 (80%)	Reheat precooked food, seafood.
7 (70%)	Cheese entrees.
6 (60%)	Scrambled eggs, cakes.
5 (50%)	Custards, pasta, tender meats: beef, ham, lamb, pork, veal.
4 (40%)	Slow cook entrees and less tender meats covered with liquid.
3 (30%)	Defrost uncooked or precooked food, simmer stews and sauces.
2 (20%)	Reheat pancakes, tortillas, French toast.
1 (10%)	Hold entrees at serving temperatures.

Microwave Mode Operation – Upper Oven

- Operate all cooking modes with JetDirect Floor Plate in place.
- Place food in center of rack and use rack position #2 (upper rack) unless otherwise noted.
- Oven cooks on HI (100% of power) unless another cooking power level is selected.
- Microwave timer can be set for 99 minutes and 99 seconds. Always enter the seconds after the minutes, even if both are zeroes.
- Microwave can be used when oven is hot from previous cooking. A hot oven may alter the time required for microwaving.
- If oven is hot, use heat-resistant utensils. Take additional care when removing item from oven.
- When using microwave mode, do not leave an oven thermometer in the oven.
- Do not leave an oven thermometer in meat while microwaving.

To Set a MICROWAVE Mode – Upper Oven Only:

1. Select once for the **UPPER OVEN**.

Touch
**UPPER
LOWER**

You Will See

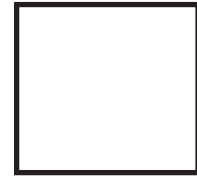

2. Select **Microwave mode**.
Power level is preset for HI.

Touch
MICROWAVE

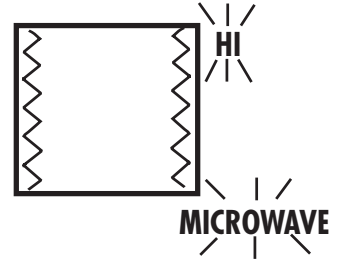

3. Optional step: to change cooking power level, select one number *immediately* before setting the cooking time. **Do not touch the zero digit after the number.**
The example shows a power level set at 30%.

- | | |
|---------------------|---------|
| 0 = HI (full power) | 5 = 50% |
| 9 = 90% | 4 = 40% |
| 8 = 80% | 3 = 30% |
| 7 = 70% | 2 = 20% |
| 6 = 60% | 1 = 10% |

Touch
3

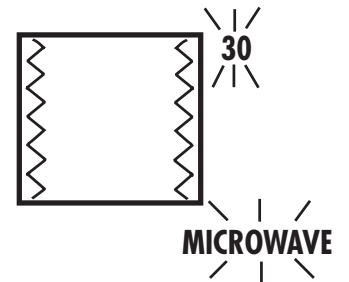

4. Select the cooking time.

Touch
**COOK
TIME**



5. Use number pads to select minutes/seconds to cook in clock display window. (Illustration shows 5 minutes and 30 seconds selected.)

Touch
**5
3
0**



Continued next page

Microwave Mode Operation – Upper Oven

You Will See

6. Select **START**.

- Door latch will lock door.
- Cooking will start.
- Cook time will count down.

Touch
START

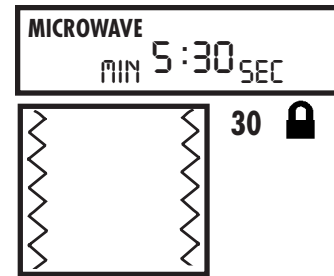

7. Optional step:

To check or stir food, select Pause/Resume.

- The microwave will stop; display shows **remaining time**.
- The lock symbol disappears when the door unlocks.

Touch
**PAUSE
RESUME**

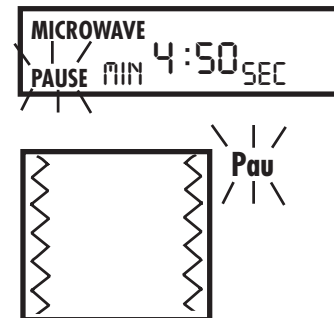

To resume microwave cooking, select **Pause/Resume**.

- The door latch will lock the door; microwave cooking will resume.
- Remaining cook time counts down in display.

Touch
**PAUSE
RESUME**

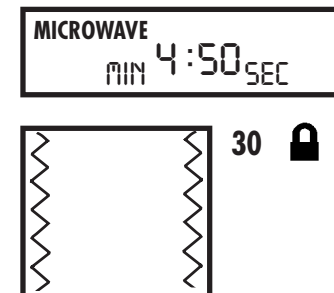

8. At the end of programmed cooking time:

- Word "End" lights in display.
- 4 chimes signal end of cooking.
- Microwave turns off.
- Door latch unlocks door.
- When door is opened, display again shows time-of-day.



9. To end or cancel mode before cooking time has expired, turn off oven.

Touch
**UPPER
OFF**

10. To change microwave time without re-setting entire program, touch Microwave mode. Select **COOK TIME** immediately. Enter the new time; touch **START**.

Touch
**COOK
TIME**

Microwave Cooking Chart – Upper Oven

Microwave Shortcuts

- Place all items on upper rack.

FOOD ITEMS (AMOUNT/WEIGHT)	POWER LEVEL	APPROX. TIME	PROCEDURES
Beverage/Cup of Soup - 6 oz.	100% (High)	2 minutes	Place bowl or cup in center of oven.
Butter, 1 stick (1/2 cup) - melted	50% (Medium)	1-3/4 minutes	Remove wrapper and place butter in dish, covered with plastic wrap. Stir once when melting.
Butter, 1 stick (1/2 cup) - softened	30% (Low)	1-1/2 to 1-3/4 minutes	Remove wrapper and place butter in dish, covered with plastic wrap.
Chocolate Chips, 1/2 cup – melted	100% (High)	1-1/2 to 2 minutes	Place chocolate chips in dish. Stir once during melting. Note that chocolate will hold shape even when softened.
Chocolate, Baking 1 square, 1 oz.	100% (High)	1-1/2 minutes	Will hold shape even when softened.
Frozen Vegetables, 1 lb.	100% (High)	7 to 10 minutes	Cooking times will vary depending on type of vegetable. Place frozen vegetables in 1-quart casserole dish. Add 2-3 Tbsp. water and cover. Allow to stand covered 2 to 3 minutes.
Chicken, breast pieces, boneless/ skinless, 1 lb.	100% (High)	9 minutes	Place pieces in baking dish. Cover with wax paper. Rotate once during cooking time.
Fish, Fillets, 1 lb.	100% (High)	4-6 minutes	Cover with plastic film, venting one corner. Test for doneness by flaking with a fork. Allow to stand 5 minutes covered.
Fish, Steaks, 4, 7oz. each	100% (High)	6-7 minutes	
Ground Beef, 1 lb. - lightly browned	100% (High)	5 minutes	Crumble into dish. Cover with plastic film, venting one corner. Stir twice during browning time. Drain grease.
Nachos	100% (High)	3 to 4 minutes	Place chips on dish; arrange ingredients on top and heat.
Quesadilla	100% (High)	3 to 4 minutes	Reheat on plate.
Popcorn, 3.5 oz. package (Prepackaged Microwave Popcorn only)	100% (High)	4-1/2 - 5 minutes	Time may vary depending on package size. Pop one bag at a time, placing in center of oven. After popping, open bag carefully, away from face and body since popcorn and steam are extremely hot. Do not reheat unpopped kernels or reuse bag.

Microwave Cooking Chart – Upper Oven

Cooking Fresh Vegetables

- Cook on upper rack on HI power.
- Timings are for vegetables peeled, trimmed and ready to cook.
- Stir or rearrange vegetables once during cooking.
- Allow vegetables to stand covered 2-3 minutes before serving.

VEGETABLE	AMOUNT (purchased weight)	CONTAINER Type & Size	WATER OR PREPARATION METHOD	APPROX. COOKING TIME
Asparagus, spears	1 lb. (454g)	1-quart w/lid	1/4 cup (50 ml)	4 to 5 minutes
Beans, green or wax, cut in pieces	1 lb. (454g)	1-quart w/lid	1/4 cup (50 ml)	11 to 13 minutes
Broccoli, cut in pieces	1 lb. (454g)	1-quart w/lid	1/4 cup (50 ml)	9 to 10 minutes
Brussels sprouts	10 oz. (280g)	1-quart w/lid	1/4 cup (50 ml)	9 to 12 minutes
Cabbage, wedges	1 lb. (454g)	1-quart w/lid	1/4 cup (50 ml)	9 to 10 minutes
Carrots, baby	1 lb. (454g)	1-quart w/lid	1/4 cup (50 ml)	7 to 8 minutes
Carrots, sliced	2 cups	1-quart w/lid	2 tbsp. (30 ml)	7 to 8 minutes
Cauliflower, cut in pieces	1 lb. (454g)	1-quart w/lid	1/4 cup (50 ml)	9 to 11 minutes
Corn, on the cob (husks & silks removed)	1 ear 2 ears 4 ears	2-quart w/lid	none none none	5 minutes 7 to 8 minutes 8 minutes
Potatoes, baking Medium (6-8 oz. each)	1 2 3 4	Place on rack in circle.	Wash & scrub well. Pierce with fork.	6 to 8 minutes 7 to 8 minutes 9 to 10 minutes 10 to 12 minutes
Potatoes, baking Large (10-12 oz. each)	1 2 3 4	Place on rack in circle.	Wash & scrub well. Pierce with fork. Allow to stand 5 minutes after baking.	8 to 9 minutes 10 to 11 minutes 12 to 13 minutes 15 to 17 minutes
Potatoes, red, boiling – cut into 1" to 1-1/2" pieces	1 lb. (454g) 2 lbs. (908g)	1-quart w/lid 2-quart w/lid	1/4 cup (50 ml) 1/4 cup (50 ml)	6 to 7 minutes 11 to 12 minutes
Spinach, leaf	1 lb. (454g)	3-quart w/lid	None	4 to 5 minutes
Squash, Acorn Large – 1 to 1-1/2 lbs. each	1 whole - cut in half	9x9 baking dish	Fill each half with 1 tbsp. brown sugar, 1/2-tsp. cinnamon & 1 tsp. butter.	10 to 12 minutes
Zucchini, sliced	1 lb. (454g)	1-quart w/lid	1/4-cup (50 ml)	6 to 8 minutes
Yams, whole	1 small 2 small 4 small 1 med. 2 med. 4 med. 1 large 2 large	Place on baking sheet.	Wash & scrub well. Dry & pierce with fork before baking.	8 to 9 minutes 13 to 14 minutes 15 to 16 minutes 9 to 10 minutes 11 to 13 minutes 15 to 16 minutes 11 to 12 minutes 17 to 18 minutes

Microwave Cooking Chart – Upper Oven

Reheating Cooked Foods

- Cover loosely with wax paper or microwave-safe plastic wrap.
- Arrange items according to Microwave Cooking Techniques, Page 24.
- Reheat items on upper rack.
- Timings are for items starting at refrigerator temperature.
- Stir food if possible, re-cover and allow to stand 2 to 3 minutes before serving.

COOKED FOOD	POWER LEVEL	AMOUNT or WEIGHT	APPROX. TIME	PROCEDURE
Casserole and Main Dishes – Stirrable (such as Macaroni and Cheese)	HIGH (100%)	8 oz. serving 2 - 6 oz. servings	1-1/2 to 2 minutes 2-1/2 to 3-1/2 minutes	Cover loosely with plastic wrap and stir after half the time.
Casseroles and Main Dishes – Non-stirrable (such as Lasagna)	MEDIUM 5 - (50%)	1 serving 2 servings 4 servings	3 to 6 minutes 5 to 7 minutes 10 to 11 minutes	Cover loosely with plastic wrap. Rotate after half the time.
Meat: Chicken pieces, chops, hamburgers, meat loaf slices	HIGH (100%)	1 serving 2 servings	1-1/2 to 2 minutes 2-1/2 minutes	Cover loosely with plastic wrap.
Meat Slices: Beef, ham, pork, turkey	HIGH (100%)	1 serving (3 to 5 oz.) 2 servings (6 to 10 oz.)	1-1/2 to 2 minutes 1-1/2 to 2 minutes	Cover with wax paper.
Potato, Baked	HIGH (100%)	1 large, 10-12 oz. 2 medium, 6-8 oz. each	3 minutes 3-1/2 minutes	Place on small plate or paper towel.
Pastry, Danish	MEDIUM 5 - (50%)	1 large pastry	1 to 1-1/2 minutes	Place on small plate or paper towel.
Pie	HIGH (100%)	1 slice 2 slices	1 to 1-1/2 minutes 2 to 2-1/2 minutes	Place on microwave-safe dish. Do not cover.
Pizza, slices	HIGH (100%)	1 slice 2-3 slices	1 minute 1-1/2 minutes	Place on microwaveable plate; cover with wax paper.
Tortillas, 6	MEDIUM 5 - (50%)	6 stacked	1 minute	Wrap between 2 paper towels with top towel as cover.
Vegetables	HIGH (100%)	1 cup 2 cups	1-1/2 to 2 minutes 3 to 4 minutes	Cover. Stir after half the time.
Waffles and French Toast	MEDIUM 5 - (50%)	1 waffle/toast 2 waffle/toast 3 waffle/toast 4 waffle/toast	40 seconds 1 minute 1-1/2 minutes 1-3/4 minutes	Warm on paper towel or dish.

Microwave Cooking Chart – Upper Oven

Defrosting

- Defrost uncooked meat, fish and poultry using 30% power.
- Defrost food when oven is cool (not immediately after using the *JETDIRECT* convection or *COOKSMART* modes).
- Remove all meat, poultry and fish from package. Failure to remove will cause steam to develop inside the closed package and food will begin cooking before defrosting is complete.
- Place meats on flat tray/dish or microwave roasting rack to catch drippings.
- Allow meat to stand after removing to complete defrosting.
- Place items on upper rack when defrosting.

FOOD ITEMS	PROCEDURE	APPROX. DEFROST TIME (Minutes per pound of weight)
Meat: Bacon 1 lb.	Remove from wrapper. Place on paper towel on a dish. Defrost until slices can be separated easily.	5 to 6 minutes
Chops 1 to 4 chops	Turn over and rearrange halfway through defrost time. Allow to stand 5-10 minutes.	7 to 11 minutes
Cubed Meat 1 to 4 lbs.	Turn over and separate pieces halfway through defrost time. Allow to stand 8-10 minutes.	8 to 10 minutes
Ground Meat 1 to 3 lbs.	Remove thawed portions halfway through defrost time. Turn meat over and continue defrosting. Allow to stand 5-10 minutes.	7 to 8 minutes for 1 lb. 8 to 9 minutes for 2 lbs. 9 to 10 minutes for 3 lbs.
Roast (Bone-in or Boneless) 2 to 6 lbs.	Turn over and rotate at half time. Cover warm areas with aluminum foil. Allow to stand 8-10 minutes.	Less than 2" thick - 7 to 8 minutes Over 2" thick, 9 to 12 minutes
Steaks 1 to 4 steaks	Turn steaks over and rearrange halfway through defrost time. Cover thawed areas with aluminum foil. Allow to stand 5-10 minutes.	8 to 11 minutes
Fish: Fillets/Steaks 1 lb. 2 lbs. 3 lbs.	Halfway through defrost time, turn over and rotate. If possible, separate and rearrange pieces. Let stand 5 to 10 minutes to complete defrosting.	3 to 4 minutes 5 to 6 minutes 7 to 8 minutes
Poultry: Chicken, Whole 3 to 5 lbs.	Turn over and rotate halfway through defrost. Allow to stand 8-10 minutes.	9 to 12 minutes
Chicken- Pieces 1 to 3 lbs.	Break apart pieces and turn over halfway through defrost time. Allow to stand 5-6 minutes.	9 to 13 minutes
Cornish Game Hens 1 to 4 hens, 1.5 lbs. each	Halfway through defrost time, remove birds from package, rotate and turn over. Shield end of legs, wings and any warm areas with foil. Allow to stand 8-10 minutes.	7 to 8 minutes
Turkey Breast 4 to 6 lbs.	Halfway through defrost time, remove from package, turn over and shield warm areas with foil. Allow to stand 15-20 minutes.	7 to 8 minutes
Cooked Poultry 1/2 to 1 lb. (2 to 4 cups)	Halfway through defrost time, break apart any pieces and remove thawed pieces. Allow 2 to 3 minutes standing time to complete defrosting.	4 to 6 minutes

Custom Combination Program – Upper Oven

JetDirect Convection plus Microwave

- The JetDirect Convection mode plus the Microwave mode can be manually combined to cook a variety of foods. The following items are examples of foods that can be cooked using the Custom Combination setting:
 - Specialty cakes - such as Cheesecake, Cheesepie and Chiffon Cake
 - Ham or Pork Roasts
 - Turkey Breast, Boneless or Bone-In
 - Whole Turkey (11-12 lbs)
- The user selects the combination of oven temperature, microwave power level and cooking time for this program.
- Use the chart on Page 34 as a guide for food items, ovenware, oven temperature, microwave power level and total cooking time.
- Custom Combination is not a preprogrammed mode and the oven does not reduce the cooking time.
- Always preheat the oven before entering the microwave power level and cooking time.
- Microwave cooking time cannot exceed 1 hour 40 minutes without being reset.
- When cooking time has finished, the microwave will turn off. The JetDirect Convection heat will remain on and must be turned off manually.
- Ovenware may be metal, oven-safe glass or glass ceramic.
- Use low-sided pans when possible. Place food in center of rack.

To set a customized program:

1. Select once for the UPPER OVEN.

Touch
**UPPER
LOWER**

You Will See



2. Select JetDirect.
The temperature is automatically set at 325°F.

Touch
**JetDirect
Convection**

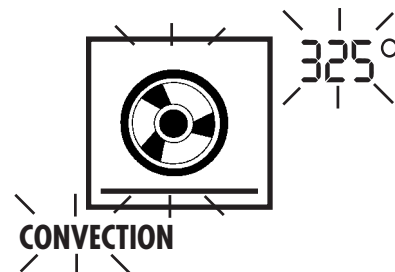

3. Select a temperature.
To change the temperature from 325°F, select another temperature immediately before starting.

Touch
**3
5
0**

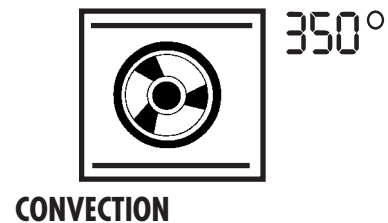

4. Select START.
The temperature display alternates between the set and actual temperature.

Touch
START

Wait until oven is preheated before proceeding to next step.

When the oven is preheated, the chime signals once. PREHEAT disappears from the display.



5. Place food in oven.

Continued next page

Continued from previous page

You Will See

6. **Select the Microwave mode.**
Power level is preset for HI.

Touch
MICROWAVE

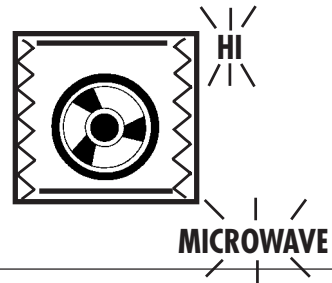

7. **Select a power level.**
While the HI power is flashing, select one number immediately before setting the cooking time. The example shows a power level of 40%.
Do not touch the zero pad unless you want the HI power.

Touch
4

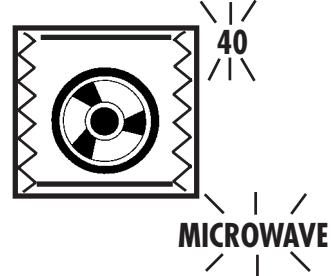

- | | | |
|---------------------|---------|---------|
| 0 = HI (full power) | 6 = 60% | 3 = 30% |
| 9 = 90% | 5 = 50% | 2 = 20% |
| 8 = 80% | 4 = 40% | 1 = 10% |
| 7 = 70% | | |

8. **Select cook time.**

Touch
COOK TIME

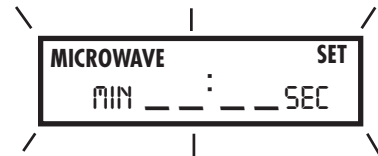

9. **Select the minutes/seconds to cook the food.**
Use the number pads to enter the cooking time. The example shows 7½ minutes or 7 minutes:30 seconds.

Touch
7
3
0



10. **Select START.**

- Door Latch will lock door.
- Cooking with heat and microwaves will begin when door is locked.
- Cook time will count down.

Touch
START

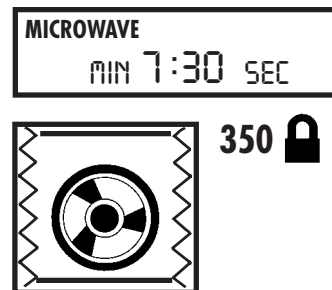

11. **To check or stir the food, select Pause/Resume.**

Touch
PAUSE
RESUME

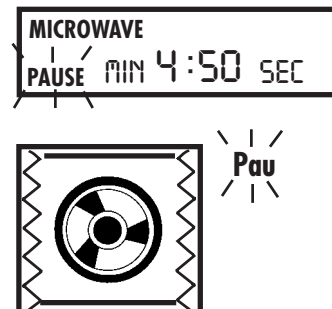

Continued next page

Continued from previous page

You Will See

12. To resume the cooking, select **Pause/Resume**.

Touch
PAUSE
RESUME

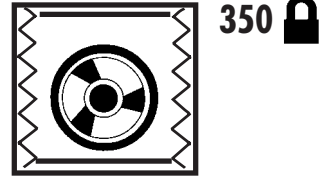
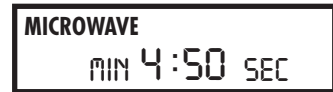

13. At the end of the set cooking time, **END** appears in the display and 4 chimes signal the end of microwave cooking.

Touch
UPPER
OFF



The heat remains on until the **UPPER OFF** pad is touched.

14. To change the microwave time, without resetting the entire program, touch the **Microwave mode**.

Touch
MICROWAVE

Select **COOK TIME** immediately.

COOK
TIME

Enter the new time and touch **START**.

START

Custom Combination Cooking Chart – Upper Oven

The following chart provides some suggestions for custom settings.

- The cooking times will be shorter than in conventional recipes.
- Consider the pan size and material, food temperature, food size and shape when selecting your own cooking program.
- Cook all items on the upper rack with the exception of whole turkey, pizza and chiffon cake, which are cooked on the lower rack.
- Do not use paper towels in Custom Combination.

FOOD ITEM	Ovenware Pan dimensions in inches	JETDIRECT Convection Temperature	Microwave Power Level	Cooking Time
Cakes, specialty Cheesecake Cheesepie Chiffon	9" spring form pan 9" pie pan 10" tube pan	300° F (149° C) 300° F (149° C) 300° F (149° C)	30% 30% 30%	19 to 22 minutes 14 to 17 minutes 32 to 35 minutes
Pizza, Cheese, frozen 12"	Place pizza directly on lower rack; use no pan	400° F (205° C)	100%	4 to 4-1/2 minutes
Beef Roasts Rib Eye, 5 to 6 lbs. 7 to 8 lbs. Top Sirloin, 4 to 6 lbs. Meat Loaf, 1-1/2 lbs.	Bottom of broil pan Bottom of broil pan Ring-shaped dish	250° F (123° C) 250° F (123° C) 250° F (123° C) 350° F (123° C)	20% 30% 20% 40%	15 minutes per pound 9 to 10 minutes per pound 15 to 16 minutes per pound 27 to 28 minutes
Ham, sliced, 3 lbs. Pork Roast Boneless /Bone-in 2 to 4-1/2 lbs.	9x13 glass dish Bottom of broil pan	250° F (123° C) 300° F (149° C)	20% 30%	30 to 40 minutes 16 to 17 minutes per pound
Turkey Breast Boneless, 5 to 6 lbs. Bone-in, 6 to 7 lbs.	Bottom of broil pan	300° F (149° C) 300° F (149° C)	40% 40%	13 minutes per pound 9 to 10 minutes per pound
Turkey, whole unstuffed 11 to 12 lbs.	Bottom of broil pan with flat or V-rack insert, place on Lower Rack	300° F (149° C)	50%	5 to 6 minutes per pound
Fresh Garlic, 1-3 bulbs	Covered Ceramic, Baking Dish	300° F (149° C)	20%	20 minutes

TIPS:

- When roasting a whole turkey, tuck the wings behind the back and loosely tie the legs with kitchen string.
- Shield the legs and breast area of a whole turkey with foil before roasting. Remove the foil after 2/3 of cooking time.
- A whole turkey may be rotated halfway through cooking time.
- For juicer and more flavorful meat, turkey may be brined before roasting.
- For best results, shape meat loaf in a ring-shaped dish. Invert dish and place meat loaf on a microwave bacon tray. Meat loaf will cook more evenly in the circular pattern and fat can easily drain off.

Cooking and Serving Temperatures

- **Beef and lamb** should be removed from oven at end of cooking time. Cover with foil and allow to stand 15-20 minutes. Temperature will rise 20-30°F

during standing time. Serving temperatures should be 135° F – rare; 145° F – medium rare and 150° F – medium.

- **Chicken and turkey** should be removed from oven when internal temperature reaches 155°-160°F. Cover with foil and allow to stand 10-20 minutes. Temperature will rise 10-15° during standing time and juices should run clear. Serving temperatures should be 170-175°F.
- **Pork** roast should be removed from oven when internal temperatures reach 135° – 150° F. Cover with foil and allow to stand 10-20 minutes. Depending on the size of roast, temperature will rise 10-20° F during the standing time. Juices should run clear. Serving temperatures will be 140° F for light pink and 160° F for well done.

Custom Combination Cooking Chart Upper Oven

Recipe Favorites

Record information on this page as you develop your favorite custom combination recipes.

Food Items	OvenWare	JetDirect Convection Temperature	Microwave Power Level	Cooking Time

Lower Oven General Tips

PREHEATING THE OVEN*

- Preheat the oven when using the BAKE, CONVECTION and ROAST modes.
- Preheat is not necessary for BROIL and CONVECTION BROIL modes.
- Preheat is optional for CONVECTION ROAST. Preheating is not recommended for CONVECTION ROAST when using the PROBE. A hot oven impairs connecting the meat probe into the receptacle.
- Allow oven to preheat while preparing recipe or food.
- Place racks in the oven before preheating.
- During preheat, the selected cooking temperature is displayed and alternates with a display of the actual oven temperature.
- The oven chimes once when it is preheated and the selected cooking temperature is displayed.

OPERATIONAL SUGGESTIONS

- Use the cooking charts as a guide.
- Do not set pans on the opened oven door.
- Use the interior oven light to view the food through the oven door window rather than opening the door frequently.
- Use TIMER 1 OR TIMER 2 to keep track of cooking times.

UTENSILS

- Reduce oven temperature 25° when baking in glass.
- Use pans that give the desired browning. For tender, golden brown crusts, use light nonstick/anodized or shiny metal utensils.
- For brown, crisp crusts, use dark nonstick/anodized or dark, dull metal utensils or glass bakeware. Insulated baking pans may increase the length of cooking time.
- Do not cook with the empty broiler pan in the oven, as this could change cooking performance. Store the broil pan outside of the oven.
- Tips for "Solving Baking Problems" are found on Page 63.

HIGH ALTITUDE BAKING

- When cooking at high altitudes, recipes and cooking times will vary from the standard. For accurate information, write the Extension Service, Colorado State University, Fort Collins, Colorado 80521. There may be a cost for the bulletins.

CONDENSATION / TEMPERATURE SENSOR

- It is normal for a certain amount of moisture to evaporate from the food during any cooking process. The amount depends on the moisture content of the food. The moisture may condense on any surface cooler than the inside of the oven, such as the control panel.
- Your new Thermador® oven has an electronic temperature sensor that accurately maintains the temperature selected. Your previous oven may have had a mechanical thermostat that drifted gradually over time to a higher temperature. It is common to experience an adjustment period when cooking your favorite recipes in the new oven.

OVEN RACKS

- Rack positions are numbered from the bottom rail guide (#1) to the top (#6). Check the cooking charts for the recommended position.
- To insert racks into the oven, hold the rack with the back rail up and toward the back. Place the safety hooks under the front of the rail guides. Push the rack into the oven, lifting the rack stops over the front of the rail guides. Slide the rack into position.
- To remove racks or reposition racks in the oven, pull the rack towards the front of the oven. Lift up the front of the rack over the safety stops and pull from the oven.
- Rack rail supports should not be removed from the oven.
- CAUTION! Never use aluminum foil to cover the oven racks or to line the oven. It can cause damage to the oven can liner if heat is trapped under the foil.
- When placing food on a rack, pull the rack out to the stop position. The racks are designed to lock when pulled forward.

* 120/208 Volt Connection

- Preheat time will be slightly longer.
 - The Self Clean mode may need a longer clean time than normal, depending on the amount of soil.
 - Preheat for all cooking modes.
 - Preheat the broil element with the door open for 3 to 4 minutes or until the top element is red. Do not preheat the broil pan in the oven.
-

Lower Oven Heating Modes

The following illustrations give an overview of what happens in the oven with each mode setting. The arrows represent the location of the heat source during specific modes. The lower element is concealed under the oven floor.

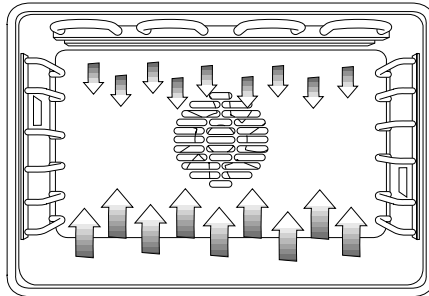

BAKE or PROOF

Baking is cooking with heated air. Both upper and lower elements are used to heat the air and cycle to maintain the temperature. **Proofing**, while similar to bake, holds an optimum low temperature for yeast dough to rise.

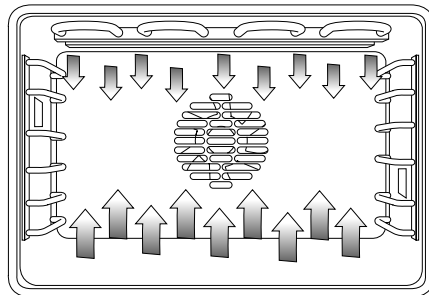

ROAST

Roasting has more top heat than baking. This additional top heat is for conventional open roasting when drippings are desired or for covered-dish roasting.

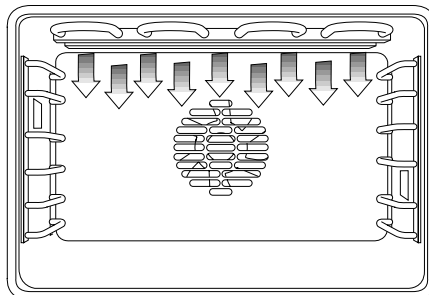

BROIL

Broiling uses intense heat radiated from the upper element to give excellent top browning or searing.

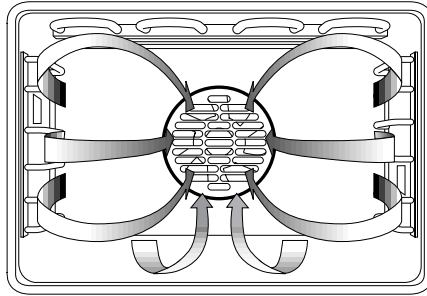

CONVECTION or DEHYDRATE

Convection is cooking with heat from a third element concealed behind the back wall of the oven. It is used with a fan to speed up the circulation of heated air throughout the oven. **Dehydrating** holds an optimum low temperature while circulating the heated air to remove moisture slowly for food preservation.

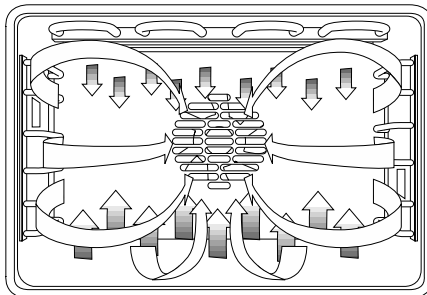

CONVECTION BAKE

Convection Bake has heat from the upper and lower element with circulation assisted by the convection fan. This mode is designed for breads, pastries and pies.

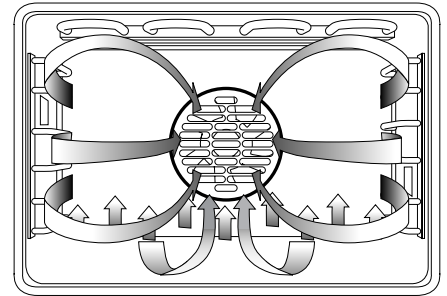

CONVECTION ROAST

Convection roasting combines the heat from the lower concealed element with additional heat from the convection ring element and the convection fan. The result is a crispier exterior that seals in the interior juices. It is perfect for roasting tender meats in an uncovered, low-sided pan.

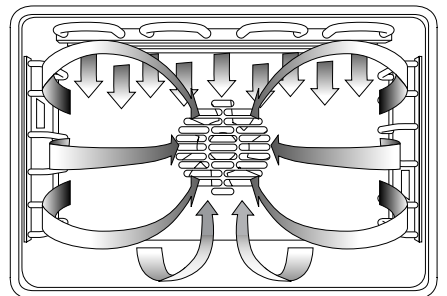

CONVECTION BROIL

Convection broiling combines the intense heat from the upper element with the circulation assisted by convection fan. This air circulation crisps the exterior surface and retains inner moisture in meats more than 1-1/2" thick.

Lower Oven Control Menu

Lower Oven Mode Pads

MICROWAVE	PROBE	<u>JETDIRECT</u> CONVECTION	BAKE	<u>UPPER</u> LOWER
COOKSMART 1-2-3-4	SELF CLEAN	BROIL	ROAST	UPPER OFF
<u>PAUSE</u> <u>RESUME</u>	<u>PROOF</u> DEHYDRATE	STOP TIME	COOK TIME	LOWER OFF

* Bold pads shown above are used to control the Lower oven.

- **PROBE** – selects interior meat temperatures with JetDirect/Convection and Roast modes.
- **SELF CLEAN** – selects self clean mode.
- **PROOF** – touch once to select Proof mode; touch twice to select Dehydrate mode.
DEHYDRATE
- **JETDIRECT** – selects the Convection mode (heat from third element in back of oven, assisted
CONVECTION with convection fan).
- **BROIL** – selects the Broil mode (heat from above).
- **STOP** – selects the time of day the oven is to automatically turn off (for automatic Timed-Bake
TIME and Self Clean mode)
- **BAKE** – selects the Bake mode (heat from above and below).
- **ROAST** – selects the Roast mode (heat from above and below).
- **UPPER** – touch twice to select the Lower Oven.
LOWER
- **LOWER** – turns the Lower Oven off.
OFF

Bake Mode Operation – Lower Oven

- Preheat when using the Bake mode.
- Use BAKE for general cooking on one or two racks.

To set BAKE mode:

1. Select twice for **LOWER OVEN**.

Touch
UPPER
LOWER

You Will See

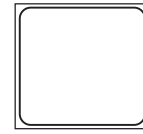

2. Select **BAKE**.

The temperature is automatically set at 350°F.

Touch
BAKE

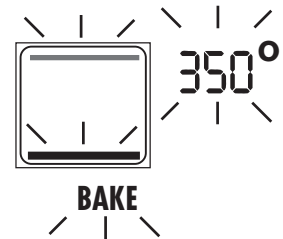

3. Optional step:
To change the temperature from 350°F, select another temperature *immediately* before starting.

Touch
3
7
5



4. Select **START**.

The temperature display alternates between the set temperature and the actual temperature, beginning with 100°F. The actual temperature counts up in 5°F increments.

Touch
START



The oven is preheated when the chime signals once. PREHEAT disappears from the display.

5. To end this mode, select the oven OFF pad.

Touch
LOWER
OFF

BAKE TIPS

- Follow the recipe, package directions, or the cooking chart on next page for baking temperatures, time and rack position.
- Baking time will vary with the size, shape and finish of the baking utensil. Dark metal pans or nonstick coatings will cook faster with darker results. Insulated bakeware will lengthen the cooking time for most foods.
- For best results, bake food on a single rack with at least 1-1/2" space between utensils and oven walls.
- Use a maximum of 2 racks when selecting the bake mode. Stagger pans or baking sheets so that one is not directly above another.
- Eliminate heat loss from the oven by using the window to periodically check food for doneness.
- Do not use any aluminum foil or a disposable aluminum tray to line any part of the oven. Foil is an excellent heat insulator and heat will be trapped beneath it. This will alter the cooking performance and can damage the finish of the oven.

Baking Chart – Lower Oven

Food Item	Rack Level	Oven Temperature	Time
Breads			
White Bread, Scratch	3	400°F (205°C)	30 to 35 minutes
Breads, Specialty			
Biscuits, scratch	3	450°F (232°C)	10 to 12 minutes
Biscuits, canned			
Large	3	375°F (190°C)	11 to 15 minutes
Medium	3	400°F (205°C)	8 to 11 minutes
Small	3	450°F (232°C)	8 to 10 minutes
Cornbread, mix or Scratch	3	400°F (205°C)	20 to 30 minutes
Gingerbread	3	350°F (177°C)	35 to 40 minutes
Muffins	3	425°F (219°C)	15 to 20 minutes
Quick Breads	3	350°F (177°C)	50 to 60 minutes
Cakes			
Angel Food Mix	1	350°F (177°C)	37 to 47 minutes
Cake Mix, 8" or 9" round(s)	3 or 2 and 5	350°F (177°C)	30 to 35 minutes
9" x 13" rectangle	3	350°F (177°C)	30 to 35 minutes
Scratch	3	350°F (177°C)	30 to 40 minutes
Cakes, Specialty			
Bundt Cakes	3	350°F (177°C)	40 to 45 minutes
Cupcakes	3	350°F (177°C)	18 to 21 minutes
Pound Cakes	2	350°F (177°C)	48 to 58 minutes
Carrot Cake, Scratch	3	350°F (177°C)	30 to 40 minutes
Casseroles			
9" x 13", Scratch	3	350°F (177°C)	30 to 50 minutes
40 oz., frozen	3	375°F (190°C)	55 to 65 minutes
96 oz., frozen	3	400°F (205°C)	110 to 130 minutes
Cookies			
Bar	3	375°F (190°C)	18 to 23 minutes
Drop	3	375°F (190°C)	8 to 10 minutes
Sliced	3	375°F (190°C)	8 to 10 minutes
Desserts			
Custard	2	350°F (177°C)	40 to 50 minutes
Fruit, Crisps and Cobblers	3	350°F (177°C)	40 to 45 minutes 45 to 55 minutes
Pies, frozen	3	400°F (205°C)	60 to 65 minutes
Pudding			
Bread Pudding	2	350°F (177°C)	50 to 60 minutes
Rice Pudding	2	325°F (163°C)	40 to 50 minutes
Fruits and Vegetables			
Apples, Baked (4)	3	400°F (205°C)	40 to 45 minutes
Potatoes, Baked (4), 6 to 8 oz. each	3	400°F (205°C)	60 to 70 minutes
Squash, Winter, Baked, 1-1/2 lbs	3	350°F (177°C)	50 to 55 minutes

* This chart is a guide. Follow recipe or package.

Convection Mode Operation – Lower Oven

- **Preheat** when using the convection mode.
- For a quick recipe conversion, reduce the oven temperature 25° from the bake setting.
- Cook food in **low-sided, uncovered pans**.
- Set Timer 1 or 2 as a reminder to check doneness of the food at minimum time.

To Set the CONVECTION Mode:

1. Select twice for **LOWER** oven.

Touch
**UPPER
LOWER**

You Will See

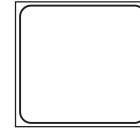

2. Select **CONVECTION**.

The temperature is automatically set at 325°F.

Touch
CONVECTION

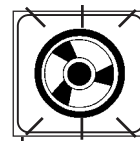

325°

CONVECTION

3. Optional step:
To change the temperature from 325°F, select another temperature *immediately* before starting.

Touch
3
7
5



375°

CONVECTION

4. Select **START**.

The temperature display alternates between the set temperature and the actual temperature, beginning with 100°F. The actual temperature counts up in 5°F increments.

The oven is preheated when the chime signals once. **PREHEAT** disappears from the display.

Touch
START



100°/375°
PREHEAT

5. To end this mode, select the oven OFF pad.

Touch
**LOWER
OFF**

CONVECTION TIPS

- Use low-sided pans, such as a jelly roll pan, cookie sheets with 1 or 2 sides, and the 2-piece broil pan.
- Shiny aluminum pans are best, unless otherwise specified.
- Dark finish metal pans and heatproof glass or ceramic bakeware may require oven temperature to be reduced or the time shortened.
- Foods cooking in less than 15 minutes requires the same time as in bake mode.
- Foods taking 30 minutes or more to cook will have a 10 to 15% time savings.
- Check doneness 5 to 10 minutes sooner than the minimum time for foods taking 30 minutes or more to cook.

Convection Cooking Chart – Lower Oven

FOOD ITEM	RACK LEVEL	OVEN TEMPERATURE	TIME*
Cakes , mix or scratch: Angel Food Layers (8" or 9") Rectangle (9 x 13) Cupcakes	1	325°F (163°C)	40 to 45 minutes
	2 and 5	325°F (163°C)	32 to 35 minutes
	3	325°F (163°C)	31 to 34 minutes
	1, 3, and 5	325°F (163°C)	17 to 20 minutes
Biscuits: Scratch or Refrigerator	3	425°F (219°C)	10 to 12 minutes
Cookies: Drop or Sliced	3 or more racks any combination	350°F (177°C)	8 to 10 minutes
Cream puffs	3	375°F (190°C)	20 to 30 minutes
Meringues	2	325°F (163°C)	20 minutes
Souffles	3	350°F (177°C)	35 to 40 minutes

* This chart is a guide. Follow recipe or package directions.

Convection Bake Mode Operation – Lower Oven

- This mode may be used for breads, pastries and pies to take advantage of the bottom heat, yielding a better crust.
- Use the cooking time given in the recipe.
- For a quick recipe conversion, reduce the oven temperature 25 degrees from the recommended bake setting.
- Cook using only one rack at a time.
- Most foods are baked on Rack 1 or 2.

To Set the CONVECTION BAKE Mode:

You Will See

1. Select OVEN.

- Select twice for LOWER oven.

Touch
UPPER
LOWER



2. Select CONVECTION and BAKE.

The temperature is automatically set at 325°F.

Touch
CONVECTION
and
BAKE

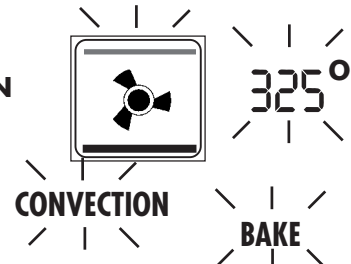

3. Optional step:

To change the temperature from 325°F, select another temperature *immediately* before starting.

Touch
3
7
5

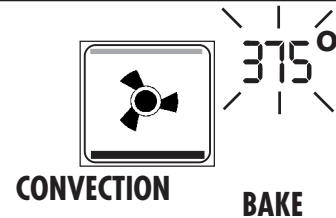

4. Select START.

The temperature display alternates between the set temperature and the actual temperature, beginning with 100°F. The actual temperature counts up in 5°F increments.

The oven is preheated when the chime signals once. PREHEAT disappears from the display.

Touch
START



5. To end this mode, select the oven OFF pad.

Touch
LOWER
OFF

CONVECTION BAKE TIPS

- Most recipes are cooked on rack positions 1 or 2.
- When a recipe has a two-step temperature cooking method (ex: pumpkin pie), use the lower temperature for the entire cooking time given.
- For extra crisp bottom crusts (ex: scratch pizza), place the metal pan directly on the oven floor.

Convection Bake Chart – Lower Oven

FOOD ITEM	RACK LEVEL	OVEN TEMPERATURE	TIME*
Breads-Yeast:			
Bread	2	350° F (177° C)	25 to 35 minutes
Dinner Rolls	2 or 3	400° F (205° C)	15 to 20 minutes
Sweet Rolls	2 or 3	375° F (190° C)	20 to 25 minutes
Frozen Dough	1 or 2	400° F (205° C)	25 to 35 minutes
Pizza:			
Prebaked crust**	1	450° F (232° C)	12 to 20 minutes
Scratch***	Oven Floor	450° F (232° C)	20 to 25 minutes
Refrigerator	1	425° F (219° C)	18 to 22 minutes
Frozen**	1	400° F (205° C)	18 to 25 minutes
Pies:			
2 Crust Fruit, scratch	1	375° F (190° C)	45 to 60 minutes
or frozen	2	400° F (205° C)	60 minutes
Pumpkin, scratch	2	350° F (177° C)	50 to 60 minutes
or frozen	2	400° F (205° C)	55 to 60 minutes
Meringue toppings	2	350° F (177° C)	15 to 20 minutes
Nut pies	1	350° F (177° C)	40 to 50 minutes
Pastry Crust:			
Scratch	2	425° F (219° C)	15 to 20 minutes
Graham Cracker	2	375° F (190° C)	8 to 10 minutes
Refrigerator	2	450° F (232° C)	10 to 15 minutes
Frozen	2	Follow directions	
Puff Pastries:			
Frozen or scratch	1	400° F (205° C)	20 to 25 minutes
Turnovers	1	400° F (205° C)	20 to 25 minutes
Strudel	1	350° F (177° C)	35 to 40 minutes

* This chart is a guide. Follow recipe or package directions.

** No pan used

*** Pan used

Roast Mode Operation – Lower Oven

- Use ROAST for conventional open roasting when drippings are desired.
- Roast mode is excellent for less tender meats or poultry when meat is braised and a covered dish is used.
- Use a high-sided roasting pan or cover dish with a lid or foil.

To set ROAST mode:

1. Select OVEN.

- Select twice for LOWER oven.

Touch
UPPER
LOWER

You Will See

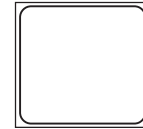

2. Select ROAST.

The temperature is automatically set at 350° F.

Touch
ROAST

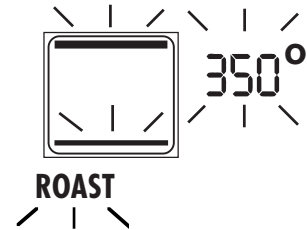

3. Optional step:

To change the temperature from 350°F, select another temperature *immediately* before starting.

Touch
3
7
5

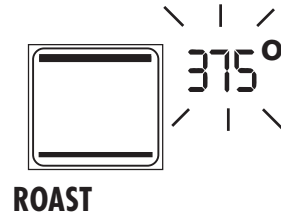

4. Select START.

The temperature display alternates between the set temperature and the actual temperature, beginning with 100°F. The actual temperature counts up in 5°F increments.

Touch
START



The oven is preheated when the chime signals once. PREHEAT disappears from the display.

5. To end this mode, select the OFF pad.

Touch
LOWER
OFF

ROAST TIPS

- This may be used to roast meats, poultry and vegetables, which would be covered or cooked in a high-sided open roaster.
- Add liquids, such as water, juice, wine, bouillon or stock for flavor and moisture.
- Roasting bags are suitable to use in this mode.
- When roasting whole chickens or turkey, tuck wings behind back and loosely tie legs with kitchen string.

Roasting Chart – Lower Oven

MEAT AND POULTRY – COVERED PAN	RACK LEVEL	OVEN TEMPERATURE	COOK TIME	END TEMP
Beef: Pot roast, 3-4 pounds	1	350°F (177°C)	40 to 60 minutes per pound	170°F (77°C)
Beef Brisket	2	350°F (177°C)	50 to 60 minutes per pound	170°F (77°C)
Beef Chuck	1	350°F (177°C)	45 to 55 minutes per pound	170°F (77°C)
Meat Loaf	3	350°F (177°C)	60 to 90 minutes total time	170°F (77°C)
Poultry: Chicken, whole or halves	1	375°F (190°C)	18 to 21 minutes per pound	Thigh 170°F (77°C)*
Chicken, pieces	1	375°F (190°C)	60 minutes total time	
Turkey, whole	2	350°F (177°C)	11 to 15 minutes per pound	170°F (77°C)*
Pork: Shoulder	1	325°F (163°C)	35 to 40 minutes per pound	170°F (77°C)
Smoked Ham, half	1	325°F (163°C)	2 to 3 hours total	160°F (71°C)

* Serving temperature is 175°F. Cover with foil and let stand for 10-15 minutes.

Food Safety Guidelines

FOOD SERVING TEMPERATURE GUIDELINES FROM FSIS (USDA Food Safety & Inspection Service)

140°F (60°C)

- Ham, pre-cooked (to reheat)

145°F (63°C)

- Fresh Beef, Veal, Lamb (medium rare)

160°F (71°C)

- Ground Meat & Meat Mixtures (Beef, Pork, Veal, Lamb)
- Fresh Beef, Veal, Lamb (medium)
- Fresh Pork (medium)
- Fresh Ham (raw)
- Egg Dishes

165°F (74°C)

- Ground Meat & Meat Mixtures (Turkey, Chicken)
- Stuffing (cooked alone or in bird)
- Leftovers & Casseroles

170°F (77°C)

- Fresh Beef, Veal, Lamb (well done)
- Poultry breasts
- Fresh Pork (well done)

180°F (82°C)











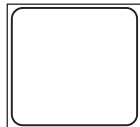

- Chicken & Turkey, whole
- Poultry thighs & wings
- Duck & Goose

NOTE: Eggs (not in a dish) – cook until yolk & white are firm.

Convection Roast and Probe Mode Operation – Lower Oven

- Preheating is optional for CONVECTION ROAST. Preheating is not recommended for CONVECTION ROAST when using the PROBE. A hot oven impairs connecting the probe into the receptacle and into the roast.
- Roast in a low-sided, uncovered pan.

To Set the CONVECTION ROAST and PROBE Mode:

- | | | <u>You Will See</u> | |
|--|--|---|---|
| <p>1. Insert the probe into the thickest part of the Meat. Push the plug into the oven receptacle.</p> | | |  |
| <p>2. Select OVEN.
• Select twice for LOWER oven.</p> | <p>Touch
UPPER
LOWER</p> |  |  |
| <p>3. Select CONVECTION and ROAST.
The temperature is automatically set at 325° F.</p> | <p>Touch
CONVECTION
then
ROAST</p> |  | <p>325° </p> |
| <p>4. Optional step:
To change the temperature from 325° F, select another temperature <i>immediately</i> before starting.</p> | <p>Touch
3
5
0</p> |  | <p>350° </p> |
| <p>5. Select PROBE.
The temperature range for the probe is 100° F to 200° F (88° C – 143° C). The probe automatic default temperature is programmed at 160° F (71° C).</p> | <p>Touch
PROBE</p> |  | <p>160° </p> <p>PROBE</p> |
| <p>6. To change the probe temperature from 160° F (71° C), select another temperature <i>immediately</i> before starting. The probe temperature continues to be displayed instead of the oven temperature.</p> | <p>Touch
1
4
5</p> |  | <p>145° </p> <p>PROBE</p> |
| <p>7. Select START.
The temperature display alternates between the set probe temperature and the actual meat/poultry temperature, increasing in 5°F increments starting with 100°F. Touch CONVECTION to check the oven temperature setting when using the probe. The oven temperature is displayed for 5 seconds before the probe display continues. The oven chimes 3 times when the meat/poultry item is cooked. End is displayed as the heat turns off.</p> | <p>Touch
START</p> |  | <p>100°/145° </p> |

CONVECTION ROAST TIPS

- When roasting whole chickens or turkey, tuck wings behind back and loosely tie legs with kitchen string.
- Use the 2-piece broil pan with the top grid for roasting uncovered meats.
- Use the PROBE or a meat thermometer to determine the internal doneness or “End” temperature (See chart).
- Double-check the internal temperature of meat/poultry by inserting probe into another position.
- While covered, small roast temperatures increase 5° F and large roast increase 10° F.
- After removing the item from the oven, **cover loosely with foil for 10 to 15 minutes before carving.**

Convection Roast Chart – Lower Oven

MEAT AND POULTRY – UNCOVERED PAN	RACK LEVEL	OVEN TEMPERATURE	COOK TIME	PROBE TEMP	DONENESS	CARVING TEMP
Beef: Standing Rib 3 to 6 lbs. 6 to 9 lbs.	2	325°F (163°C)	<u>Minutes Per lb.</u> 28 to 32	135°F (57°C) 140°F (60°C) 160°F (71°C)	Med Rare Med Well	145°F (63°C) 150°F (66°C) 170°F (77°C)
Boneless rib 1 to 4 lbs.	2	325°F (163°C)	30 to 33	135°F (57°C) 140°F (60°C) 160°F (71°C)	Med Rare Med Well	145°F (63°C) 150°F (66°C) 170°F (77°C)
Sirloin, boneless Rump, eye 3 to 6 lbs.	2	325°F (163°C)	30 to 33	135°F (57°C) 140°F (60°C) 160°F (71°C)	Med Rare Med Well	145°F (63°C) 150°F (66°C) 170°F (77°C)
Tri-Tip Tenderloin 1-1/2 to 3 lbs	2	425°F (219°C)	<u>Total Time</u> 30 to 40 min. 35 to 45 min.	135°F (57°C) 140°F (60°C) 160°F (71°C)	Med Rare Med Well	145°F (63°C) 150°F (66°C) 170°F (77°C)
Chicken: 3 to 5 lbs. Unstuffed Stuffed Pieces	3 3 3	375°F (190°C) 350°F (177°C) 375°F (190°C)	<u>Minutes Per lb.</u> 18 to 21 18 to 21 <u>Total Time</u> 60 minutes	175°F (79°C) Minimum Safe Temp. for Stuffing 165°F (74°C) 175°F (79°C)	Thigh Breast Thigh	175°F (79°C) 165°F (74°C) 170°F (77°C) 175°F (79°C)
Cornish game hens	2	350°F (177°C)	<u>Total Time</u> 60 to 90 minutes	180°F (82°C)	Breast and thigh	180°F (82°C)
Meatloaf 1 to 2 lbs.	2	350°F (177°C)	<u>Total Time</u> 60 to 75 minutes	170°F (77°C)	Well	170°F (77°C)
Lamb: Leg 4 to 8 lbs. Rack of Lamb 1 to 3 lbs.	1 1	<u>Minutes Per lb.</u> 325°F (163°C) 325°F (163°C)	24 to 30 30 to 35	135°F (57°C) 135°F (57°C)	Med Rare Med Rare	145°F (63°C) 145°F (63°C)
Pork: Loin 4 to 6 lbs. Shoulder 3 to 5 lbs.	2 2	<u>Minutes Per lb.</u> 325°F (163°C) 325°F (163°C)	32 to 35 32 to 35	155°F (68°C) 155°F (68°C)	Well Well	160°F (71°C) 160°F (71°C)
Turkey: Whole, 8 to 15 lbs. Unstuffed Stuffed Whole 16 to 24 lbs. Unstuffed Stuffed Breast, with bone 5 to 7 lbs.	2 2 1 1 2	<u>Minutes Per lb.</u> 325°F (163°C) 300°F (149°C) 325°F (163°C) 300°F (149°C) 325°F (163°C)	9 to 12 10 to 15 7 to 11 10 to 12 16 to 21	170°F (77°C) Minimum Safe Temp. for Stuffing 170°F (77°C) Minimum Safe Temp. for Stuffing 165°F (74°C)	Thigh Minimum Safe Temp. for Stuffing Thigh Minimum Safe Temp. for Stuffing Breast	175°F (79°C) 165°F (74°C) 175°F (79°C) 165°F (74°C) 170°F (77°C)
Veal: Loin (bone in) 2 to 4 lbs.	2	<u>Minutes Per lb.</u> 325°F (163°C)	32 to 34	155°F (68°C)	Well	160°F (71°C)

Broil and Convection Broil Mode Operation

- Do not Preheat for broil or convection broil.
- Broil with the door closed. This keeps the control panel cool to touch.
- Use the two-piece broil pan provided with your oven. The slotted grid allows the meat fat to drip into the lower pan, which minimizes spattering of fat and smoking. DO NOT cover top of slotted grid with aluminum foil. However, the bottom pan may be lined with aluminum foil.
- Use TIMER to signal when to turn food over.
- Use BROIL when broiling meats, fish or poultry pieces **up to 1-1/2"** thick.
- Use CONVECTION BROIL when broiling meats or poultry **over 1-1/2"** thick.

To Set the BROIL and CONVECTION BROIL Modes:

1. Select twice for LOWER oven.

Touch
UPPER
LOWER

You Will See



2. Select **BROIL** or **CONVECTION BROIL**.
The temperature is automatically set at HI (550° F/288° C)

Touch
BROIL
or
Touch
CONVECTION
then **BROIL**

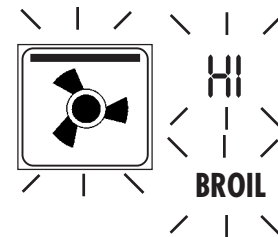

3. Optional step:
To change the setting from HI, select 500° F for Medium Broil or 450° F for Low Broil temperature *immediately* before starting.

Touch
5
0
0

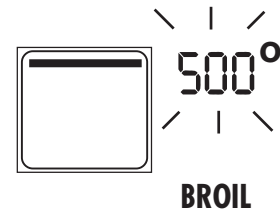

4. Select **START**.

Touch
START



5. To end this mode, select the oven OFF pad.

Touch
LOWER
OFF

BROIL AND CONVECTION BROIL TIPS

- Place rack at the rack level needed **before** turning on the oven.
- Start broiling with a cool oven and broiler pan.
- Brush fish and lean cuts of meat with vegetable oil before broiling to prevent sticking.
- Start poultry with skin side down.
- Turn food after one half of the total cooking time. Thicker cuts of meat or poultry can be turned more often.

CAUTION!

When broiling, open the door carefully. There may be an accumulation of steam and smoke. Do not place the hot broiler pan on the open oven door.

Utensils:

- Clean broiler pan and grid after each use. Do not allow grease and fat to accumulate and remain in pan. Flare-ups or fires can occur if grease and fat remain in broil pan.
- Do not use other pans for broiling, such as cookie sheets, cake pans, half-sheet pan or jelly roll pans.
- When top browning casseroles or toasting bread, use only metal or glass-ceramic (Pyroceram®) such as Corningware bakeware.
- Never use heatproof glass (Pyrexware®) or pottery; they cannot tolerate the high temperatures.

Broil Chart

FOOD ITEM and THICKNESS	RACK LEVEL	BROIL SETTING	BROIL TOTAL TIME
Beef: Ground, patties, 3/4" to 1" Steaks, 3/4 to 1-1/4"	6 6	HI HI	Med Rare - 8 to 12 min. Med - 9 to 14 min. Well - 10 to 15 min. Med Rare - 7 to 11 min. Med - 8 to 12 min. Well - 9 to 14 min.
Bread: Garlic Bread, 1/2" slices 3/4" to 1" slices	6 6	HI HI	2-1/2 to 4 minutes 4 to 6 minutes
Fish: Fillets or steaks, 1/2" to 1"	5 or 6	Med - 500°F (260°C)	Flakes - 8 to 12 minutes (1/2" thickness does not need to be turned after half of broil time)
Lamb: Chops, 1/2" to 1"	6	HI	Med - 12 to 17 minutes Well - 15 to 20 minutes
Pork: Chops, 1/2" to 1" Smoked, ham steak, 1/2" Ham steak, 1"	6 6 6	Med - 500°F (260°C) HI HI	Well - 18 to 25 minutes Well - 7 to 11 minutes Well - 12 to 15 minutes
Poultry: Chicken, pieces	4 or 5	Low - 450°F (232°C)	30 to 45 minutes
Sausage: Hot Dogs, whole	6	HI	4 to 5 minutes
Veal: Chop, 1"	6	HI	Well - 12 to 16 minutes

Convection Broil Chart

FOOD ITEM and THICKNESS	RACK LEVEL	BROIL SETTING	BROIL TOTAL TIME
Beef: Roasts, flat, 1-1/2" or more Steaks, 1-1/2" or more	4 4	Med - 500°F (260°C) HI	Med Rare - 16 to 22 min. Med - 22 to 28 min. Well - 26 to 32 min.
Bread: Garlic Bread, 1-1/2" slices	5	HI	4 to 6 minutes
Lamb: Chops, 1-1/4" or more	5	HI	Med - 21 to 27 minutes Well - 27 to 33 minutes
Pork: Chops or tenderloin, 1-1/4" or more	5	Med - 500°F (260°C)	Well - 18 to 25 minutes
Poultry: Chicken, quarters Turkey, pieces	4 or 5 4	Low - 450°F (232°C) Low - 450°F (232°C)	30 to 45 minutes 30 to 50 minutes
Sausages: Fresh, uncooked	5	HI	Well - 6 to 8 minutes

- Refer to Page 46 for Food Safety Guidelines.

Proof Mode Operation – Lower Oven

- Place food in oven before selecting this mode.
- The proofing temperature is pre-set at 100°F.
- Use any rack level that accommodates the size of the bowl or pan.
- Lightly cover the bowl or pan.

To Set the PROOF Mode:

You Will See

1. Select twice for **LOWER** oven.

Touch
UPPER
LOWER



2. Select **PROOF/DEHYDRATE** once for the proof mode.

Touch
PROOF
DEHYDRATE

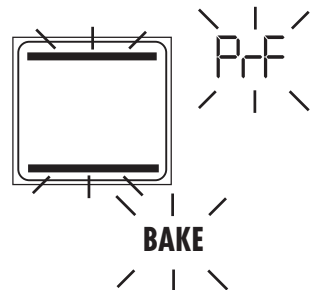

3. Select **START**.

The oven is preheated when the chime signals once. PREHEAT disappears from the display.

Touch
START



4. To end this mode, select the oven OFF pad.

Touch
LOWER
OFF

PROOFING TIPS

- Keep the oven door closed and use the oven light to check the dough rising.
- Use the reminder convenience of either TIMER 1 or TIMER 2.

Dehydrate Mode Operation – Lower Oven

- Do not preheat when using the dehydrate mode.
- The dehydrating temperature is pre-set at 140°F.
- Use drying screens (not supplied with oven).
- Multiple racks can be used simultaneously.
- Place food in oven before selecting the mode.

To Set the DEHYDRATE Mode:

You Will See

- 1. Select twice for LOWER oven.**

Touch
**UPPER
LOWER**

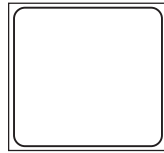

- 2. Select PROOF/DEHYDRATE twice for the dehydrate mode.**

Touch
**PROOF
DEHYDRATE**

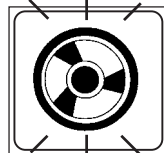

CONVECTION



- 3. Select START.**

The oven is preheated when the chime signals once. PREHEAT disappears from the display.

Touch
START



PREHEAT



- 4. To end this mode, select the oven OFF pad.**

Touch
**LOWER
OFF**

DEHYDRATING TIPS

- Some foods require as much as 14 to 15 hours of time to fully dehydrate.
- Consult a food preservation book for specific times and handling of various foods.
- This mode is suitable for a variety of fruits, vegetables, herbs and meat strips.
- Drying screens can be purchased at specialty kitchen shops.
- By using paper towels, some food moisture should be absorbed before dehydrating begins (such as sliced tomatoes or sliced peaches).

Timed Oven Modes Operation – Lower Oven

- Be sure that the time-of-day clock is displaying the correct time.
- The timed mode turns off the oven at the end of the cook time.

To Set Timed Mode:

Example shown has the time of day set at 3:00

You Will See

1. Select OVEN.

- Select twice for LOWER oven.

Touch
UPPER
LOWER

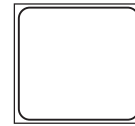

2. Select BAKE or CONVECTION.

Change the preset temperature at this time, if needed.

Touch
BAKE

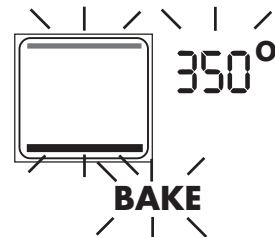

3. Immediately before starting, select the number of hours and minutes the oven will be on. For example: 2, 3, 0 is 2 hours 30 minutes.

Touch
COOK TIME
2
3
0



4. Select START.

The oven turns on and heats to the temperature selected for the number of hours and minutes needed. The clock automatically calculates the time of day the mode will stop and the oven will turn off. The example shows that it will stop at 5:30 after cooking for 2-1/2 hours.

Touch
START

COOK TIME 2:30
STOP TIME 5:30

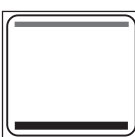

100°/350°
PREHEAT

To Delay the Start of the Timed Mode:

Example shown has the time of day set at 3:00

1. Follow steps 1, 2 and 3 above. Immediately after the number of hours are selected for the food to cook, select the Stop Time.

Touch
STOP TIME

COOK TIME 2:30
STOP TIME : --



350°

2. Select the time of day the oven will stop cooking or turn off. This example shows that the oven will stop at 7:00 and cook for 2-1/2 hours.

Touch
7
0
0

COOK TIME 2:30
STOP TIME 7:00

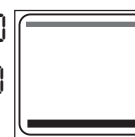

350°

3. Select START.

The oven turns on and heats to the temperature selected for the number of hours and minutes needed.

The clock automatically calculates the time of day the mode starts and stops.

Touch
START

COOK TIME 2:30
START AT 4:30



100°/350°
PREHEAT

Setting the Sabbath Mode – Lower Oven

- This mode is for religious faiths with “no work” requirements on the Sabbath.
- Use only in the BAKE mode; do not use with Timed Bake or the Probe mode.

To Set the Sabbath Mode:

1. Cancel all modes.

You Will See

2. Select OVEN.

- Select twice for LOWER oven.

Touch
UPPER
LOWER



3. Select BAKE mode and temperature. (See Page 39 to change temperature.)

Touch
BAKE

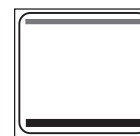

350°
BAKE

4. Select START.

Touch
START

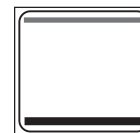

100°/350°
PREHEAT

5. Select on or off status for the lights. To keep lights off, do not touch.

Touch
LIGHTS

6. To activate the Sabbath mode, touch and hold TIMER OFF pad for 5 seconds.

- The word “SAB” is displayed.
- Lights will remain on or off as previously set, if the door is open or closed.
- “Preheat” is displayed until the oven reaches temperature.
- All pads, except the oven OFF, will be inactive. No chime or beep signal is generated.
- Oven will remain “on” indefinitely until cancelled.
- When the red heating symbol in the display is illuminated, the bake element is on. Opening the door at this point will not cause the heating element to be activated, since it will already be on. The heating element will remain on, while the door is open under this condition.

Touch
TIMER OFF

SAB

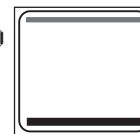

100°/350°
PREHEAT

7. To Cancel or Stop the Sabbath mode:

- Touch oven OFF.
- Turn off the light if it was set to stay on in Step 5.

Self-Cleaning the Ovens

Your new oven features two pyrolytic self-cleaning ovens. When using the **CLEAN** mode, the oven reaches a high temperature that burns off the food soil.

- Only one oven at a time can be set to self clean.
- It is common to see smoke and/or an occasional flame-up during the **CLEAN** cycle, depending on the content and amount of soil remaining in the oven. If a flame persists, turn off the oven and allow it to cool **before** opening the door to wipe up the excessive food soil.

- The oven light will not turn on when the oven is set for a clean cycle.
- Be sure the light is turned off on the control panel and the bulb and glass cover are in place, see Page 61.
- Heat and odors are normal during the self-cleaning cycle. Keep the kitchen well ventilated. During the first several times the oven is in the Self Clean mode, it is normal that the odors are more intense. This will lessen with use.

Preparing the Upper Oven for Self Clean

1. When oven is cold, remove all utensils, bakeware and oven rack.
2. If oven rack is left in the oven during the Self Clean cycle, it will permanently lose the shiny finish and change to a dull dark finish. See the Oven Cleaning Chart for proper care, Page 58.
3. **To remove the Jet Plate, grasp and lift up the front tabs on the Jet Plate and pull it forward and out. Set the Jet Plate aside top rack supports.** Moving Jet Plate above top rack position will help prevent the surface roughness created by the high temperatures.
4. Wipe up any soft soil spills and grease with paper towels.
5. Put Jet Plate back in oven above the upper rack supports.
6. Hand clean the oven window using a soapy sponge or a detergent-filled S.O.S. pad. **Do not rub the mesh gasket on door.**
7. See Page 57 for setting Self Clean mode.

After Self Clean

- After Self Clean has completed and the oven temperature drops to a safe temperature, the automatic door lock will release and the door can be opened.
- After Self Clean, some gray ash remains inside the oven. It is easily removed with a damp sponge or cloth. **When the oven is cold**, lift out the Jet Plate and wipe off the Jet Plate and oven cavity. Place the Jet Plate in the oven bottom and replace oven rack.

NOTE: Due to the high temperatures used for self-cleaning, the oven may develop fine lines or surface roughness. This does not affect either the cooking or the cleaning performance of the oven.

IMPORTANT: Be sure to let the inside window glass in the oven door cool completely before wiping up any ash left from the clean cycle.

Remove oven rack before starting SELF CLEAN.

JetDirect Floor Plate:
Lift out the Jet Plate by grasping the front tabs on each side and pulling it up and out. Place the Jet Direct Floor Plate above upper rack supports before starting SELF CLEAN.

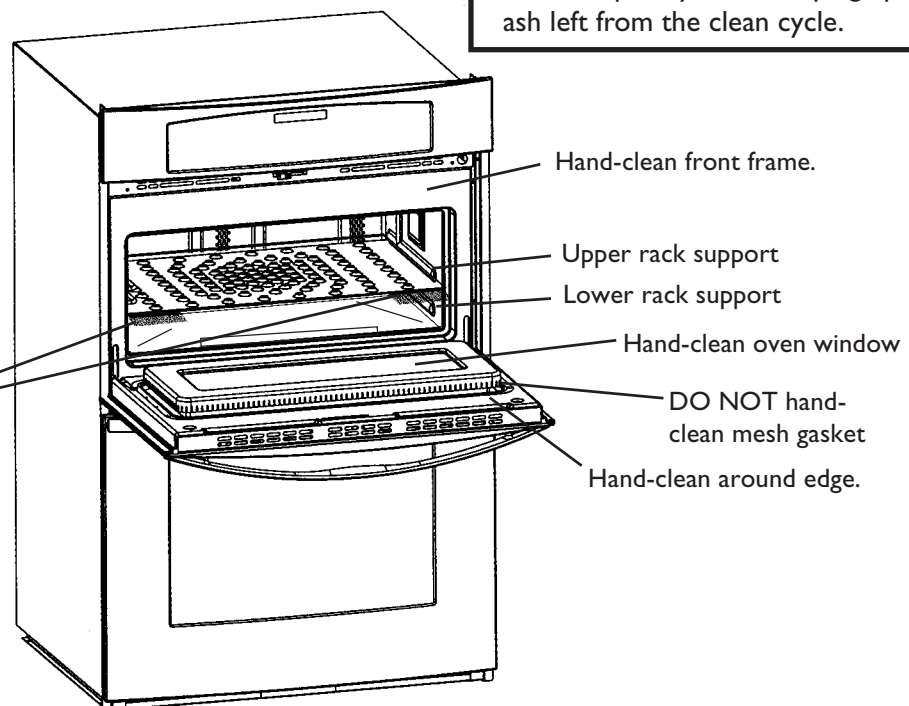

Preparing the Lower Oven for Self-Cleaning

Before you Self Clean:

1. When oven is cold, remove all utensils, bakeware and oven racks.
2. Remove oven racks. If oven racks are left in the oven during the Self Clean cycle, they will permanently lose the shiny finish and change to a dull dark finish. See the Oven Cleaning Chart for proper care, Pages 58 - 59.
3. Wipe up any soft soil spills and grease with paper towels. Excess grease will cause a flame and smoke inside the oven during self-cleaning.
4. Hand-clean the oven door edge, oven front frame and oven cavity edges. They do not get hot enough during the cleaning cycle for soil to burn away. Use a soapy sponge or plastic scrubber or a detergent-filled S.O.S. pad. **Do not rub the mesh gasket on door.**
5. Hand-clean the oven window using a soapy sponge or a detergent-filled S.O.S. pad.
6. Be sure oven interior lights are turned off and the light bulbs and lens covers are in place. See Page 61.

After Self Clean

- When Self Clean has completed and the oven temperature drops to a safe temperature, the automatic door lock will release and the door can be opened.
- After Self Clean, some gray ash remains inside the oven. It is easily removed with a damp sponge or cloth. Wipe oven out and replace oven racks.

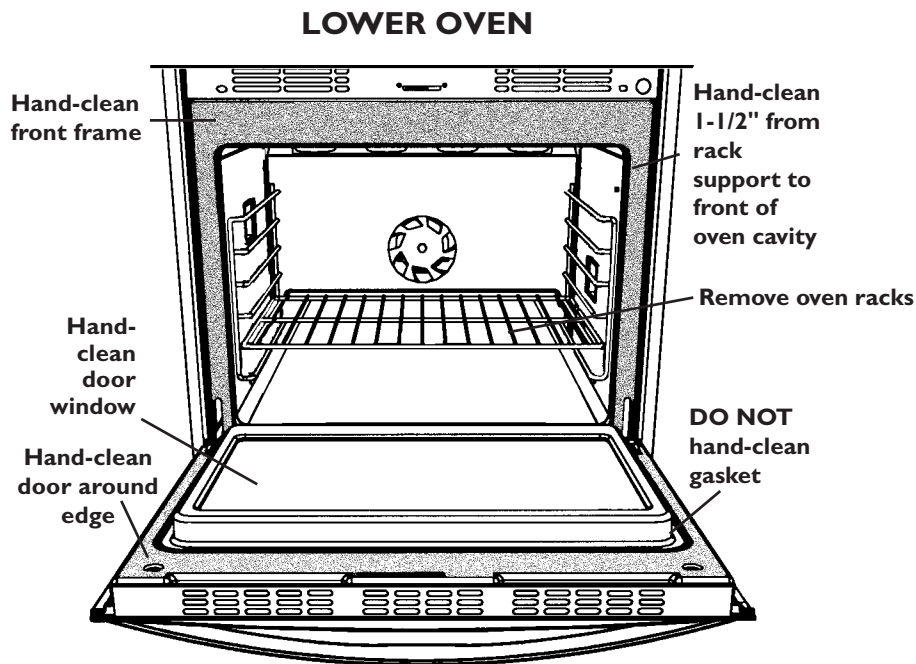

IMPORTANT: Be sure to let the inside window glass in the oven door cool completely before wiping up any ash left from the clean cycle.

Self Clean Mode Operation – Upper and Lower Oven

To Set the SELF CLEAN Mode to Start Now:

- Self Clean only one oven at a time.
- The oven light does not operate during this mode.
- Be sure that the time-of-day clock is displaying the correct time.
- Three hours is the preset length of cleaning.
- The mode stops automatically at the end of the clean hours.
- As a safety feature, the oven door locks during SELF CLEAN to protect you from very high temperatures. Do not try to open oven door.

Example shows clock set at 5:00

1. Select OVEN.

- Select once for UPPER oven.
- Select twice for LOWER oven.

Touch
UPPER
LOWER

You Will See



2. Select SELF CLEAN.

The number of clean hours (3:00) is displayed automatically.

Touch
SELF
CLEAN

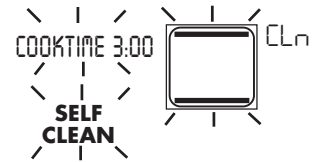

3. Optional Step:

Upper Oven: To change the setting from 3 hours, select 4 hours for heavy soil *immediately* before starting.

Lower Oven: To change the setting from 3 hours, select either 2 hours for light soil or 4 hours for heavy soil *immediately* before starting.

Touch
4
0
0



4. Select START.

The door locks automatically. When the lock symbol is displayed, the door cannot be opened. Confirm that the door locks and will not open before starting Self Clean mode. If door does not lock, press OFF and do not self-clean; phone 800/735-4328 for service (see Page 64 for obtaining service). If the door is in the open position when this mode is selected, the display will flash the word “dor.” This is a reminder that the door must be closed before the **SELF CLEAN** mode can be set.

Touch
START



When **Self Clean** has stopped, oven will cool down and door can be opened.

TO DELAY THE START OF THE MODE:

1. Select OVEN.

- Select once for UPPER oven
- Select twice for LOWER oven

Touch
UPPER
LOWER

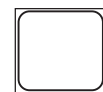

2. Select SELF CLEAN.

The number of clean hours (3:00) is displayed automatically. If the number of clean hours does not need to be changed, proceed to set the STOP TIME.

Touch
SELF
CLEAN

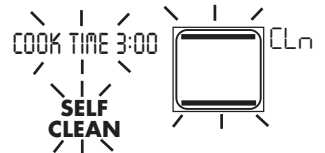

3. Select STOP TIME.

When the words STOP TIME flash, touch the time of day. The oven will stop. Oven will display the time when the clean cycle will stop.

Touch
STOP
TIME

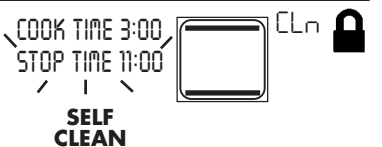

4. Select START.

To cancel or stop the mode after the “lock” symbol is displayed, touch **UPPER/OFF** or **LOWER/OFF**.

Touch
START



Oven Cleaning – Upper and Lower Oven

How to use the Oven

Cleaning Chart

1. Locate the number of the part to be cleaned in the illustration on this page.
2. Find the part name in the chart.
 - Use the cleaning method in the left column if the oven is black or white.
 - Use the cleaning method in the right column if the oven is stainless steel.
3. Match the letter with the cleaning method on Page 59.

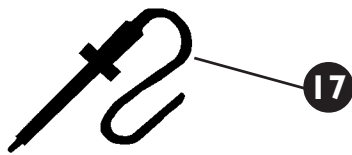
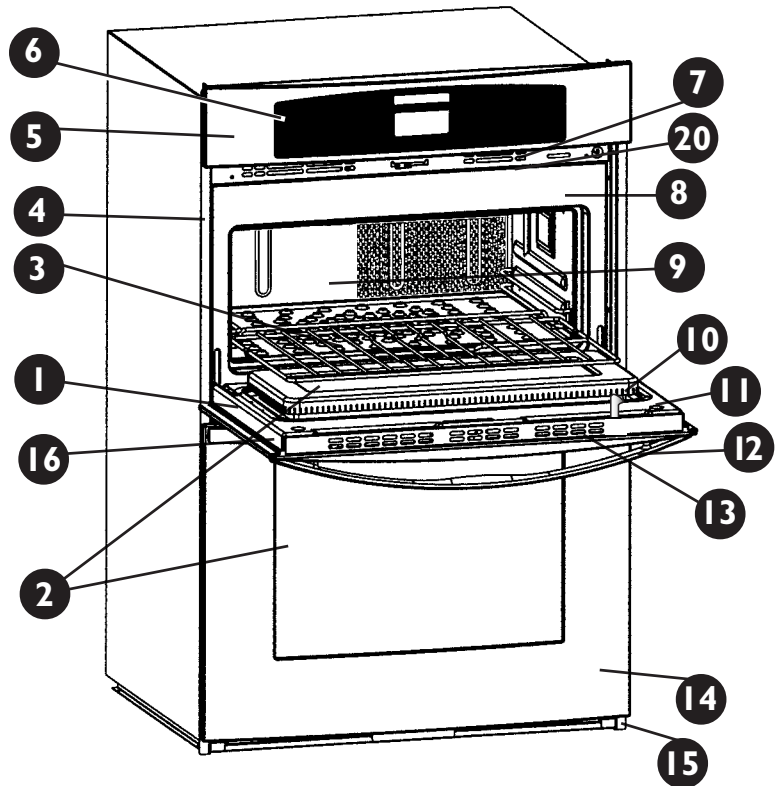

Part	Cleaning Method		Part	Cleaning Method	
	Blk / Wht Oven	Stainless Steel Oven		Blk / Wht Oven	Stainless Steel Oven
1 Door Frame	D	D	11 Interior Oven Door	E	E
2 Interior Door Window	F	F	12 Door Handle	D	D
3 Removable Oven Racks	A	A	13 Door Cooling Vent	G	D
4 Side Trim	D	D	14 Door Front	C & D	C & G
5 Control Panel Trim	D	D	15 Oven Trim	D	D
6 Control Panel	C	C, G	16 Door End caps	D	D
7 Oven Cooling Vents	D	D	17 Probe Accessory (lower oven only)	H	H
8 Oven Front Frame	E	E	18 Broil Pan Top (not shown)	A	A
9 Oven Cavity	E	E	19 Broil Pan Bottom (not shown)	E	E
10 Mesh Gasket	B	B	20 Rubber Gasket	I	I

Oven Finishes / Cleaning Method

The entire oven can be safely cleaned with a soapy sponge, rinsed and dried. If stubborn soil remains, follow the recommended cleaning methods below.

- Always use the mildest cleaner that will do the job.
- Rub metal finishes in the direction of the grain.
- Use clean, soft cloths, sponges or paper towels.
- Rinse thoroughly with a minimum of water so it does not drip into door slots.
- Dry to avoid water marks.

The cleaners recommended below indicate a type and do not constitute an endorsement. Use all products according to package directions.

PART	CLEANING METHOD
A Chrome Plated	<p>Wash with hot sudsy water. Rinse thoroughly and dry. Or, gently rub with Soft Scrub[®], Bon-Ami[®], Comet[®], Ajax[®], Brillo[®] or S.O.S.[®] pads as directed. Easy Off[®] or Dow[®] Oven Cleaners (cold oven formula) can be used, but may cause darkening and discoloration. The broil pan top may be squirted with liquid detergent and covered with wet paper towels while pan is hot. Allow to stand.</p> <p>Racks may be cleaned in the oven during the self clean mode. They will lose their shiny finish and permanently change to a metallic gray.</p>
B Fiberglass Knit	DO NOT HAND-CLEAN GASKET.
C Glass	Spray Windex [®] or Glass Plus [®] onto a cloth first, then wipe to clean. Use Fantastik [®] or Formula 409 [®] to remove grease spatters.
D Painted	Clean with hot sudsy water or apply Fantastik [®] or Formula 409 [®] first to a clean sponge or paper towel and wipe clean. <u>Avoid using powdered cleansers and steel wool pads.</u>
E Porcelain	Immediately wipe up acid spills like fruit juice, milk and tomatoes with a <u>dry</u> towel. Do not use a moistened sponge/towel on hot porcelain. When cool, clean with hot sudsy water or apply Bon-Ami [®] or Soft Scrub [®] to a damp sponge. Rinse and dry. For stubborn stains, gently use Brillo [®] or S.O.S. [®] pads. It is normal for porcelain to craze (fine lines) with age due to exposure from heat and food soil.
F Reflective Glass	Clean with hot sudsy water and sponge or plastic scrubber. Rub stubborn stains with vinegar, Windex [®] , ammonia or Bon-Ami [®] . DO NOT USE HARSH ABRASIVES.
G Stainless Steel	Always wipe or rub with grain. Clean with a soapy sponge; rinse and dry. Or, wipe with Fantastik [®] or Formula 409 [®] sprayed onto a paper towel. Protect and polish with Stainless Steel Magic [®] and a soft cloth. Remove water spots with a cloth dampened with white vinegar. Use Zud [®] or Cameo [®] to remove heat discoloration.
H Probe	Clean probe by hand with detergent and hot water. Rinse and dry. Do not soak or clean in dishwasher.
I Rubber	Clean with hot sudsy water and sponge. Avoid using steel wool pads.

Do-It-Yourself Maintenance

The Upper oven door is **NOT** removable.

Removing the Lower Oven Door

The oven door can be lifted off for your convenience in cleaning hard-to-reach areas inside the oven.

- **Use caution when removing the lower door as it is very heavy.**

To Remove the Oven Door

1. Fully open the oven door.
2. Raise the U-clip over the hook on each of the hinges to the "locked" position (see illustration below). This will prevent the hinge from snapping closed when the door is removed.
3. Grasp the door by the sides toward the back. Raise the front of the door several inches (there will be some spring resistance to overcome because of the hinge being locked). When the front of the door is high enough, you will be able to lift the hinges to clear the indents.
4. Pull the hinges out of the slots in the oven front frame.

To Replace the Oven Door

1. Grasp the sides of the door at the center and insert the ends of the hinges into the slots in the oven front frame as far as they will go (see illustration below).
2. With the door open all the way, lower the two locking clips.
3. Raise the oven door and make sure that it fits evenly with the front sides.



WARNING:

With the door off, never release the levers and try to close the hinges. Without the weight of the door, the powerful springs will snap the hinges closed with great force.

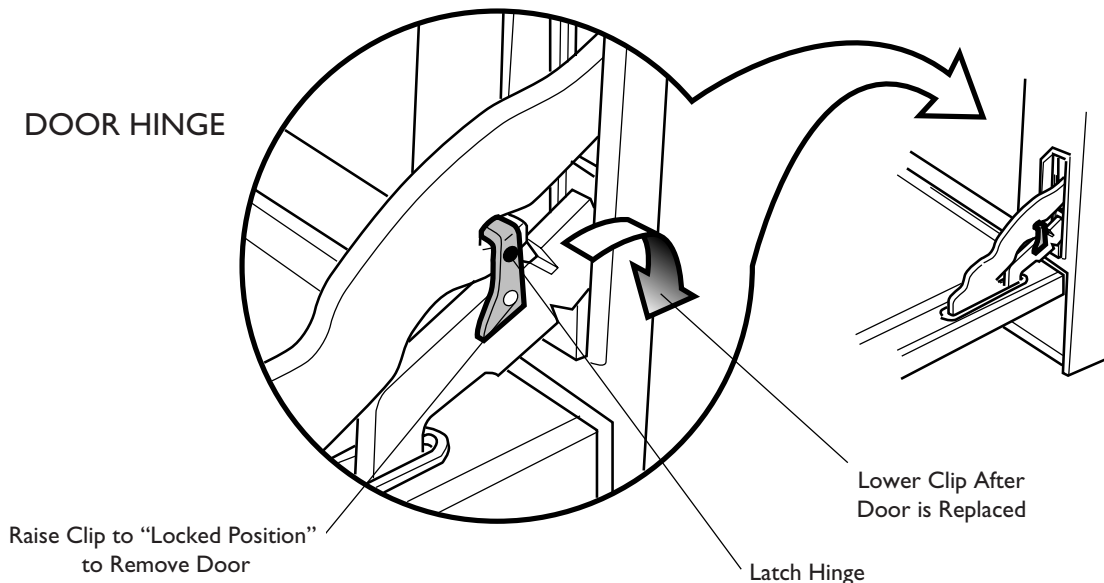

Do-It-Yourself Maintenance

REPLACING THE OVEN LIGHT – LOWER OVEN ONLY

! WARNINGS:

To prevent electrical shock and or personal injury:

- Before replacing the light bulb, be sure the electric power is turned off at the circuit breaker.
- Do not operate the oven unless the light cover is securely in position.
- Halogen bulbs get HOT instantly when turned ON.
- Be sure the oven and light bulb are cool.

CAUTION: If the light cover is damaged or broken, do not use the oven until a new cover is in place.

The oven lights are located on the left and right side walls of the oven. The lights have a removable lens cover and a halogen light bulb. The ceramic light socket housing is not removable by the user.

- Replace bulb with a 12-Volt, 10-Watt Halogen bulb only.

Before replacing bulbs, turn off oven circuit.

To replace Halogen Bulb:

1. Remove oven racks.
2. Slide the tip of a table knife blade between oven wall and the center of the side of the protective glass lens cover.
3. Support the glass lens cover with two fingers along the bottom edge to prevent the cover from falling to the bottom of the oven.
4. Gently twist the knife blade to loosen the glass lens cover.
5. Remove the glass lens cover.

6. Remove the bulb by grasping and sliding the bulb straight up until the two prongs have cleared the ceramic holder.
7. Do not touch the glass of the new replacement bulb with your fingers. It will cause the bulb to fail when it first lights. Grasp the replacement bulb with a clean paper towel or facial tissue with the prongs facing down. Locate the two prongs in the ceramic holder, gently poking until the two prongs locate in the ceramic socket.
8. Press down to seat the bulb.
9. Snap the protective glass lens cover over the bulb housing.
10. Turn on circuit breaker.
11. The upper oven light must be replaced by a qualified service technician. See Page 64.

CHANGING TO THE 24-HOUR CLOCK FORMAT

The oven has been preset to a 12- hour clock format.

To Change the Time-of-Day Clock to a 24-Hour Clock, follow these steps:

1. Turn off both ovens.
2. Touch and hold the **UPPER OFF**, then touch the **CLOCK** pad at the same time.
3. 12H appears in the Clock window; release both pads.
4. Touch **CLOCK** and 24H replaces 12H. This alternates when **CLOCK** is touched.
5. To complete the change, touch **UPPER OFF** or **OFF**.

Do-It-Yourself Maintenance

FAHRENHEIT TO CENTIGRADE

The oven has been preset to a Fahrenheit temperature.

To Change to Centigrade, follow these steps:

1. Turn off both ovens.
2. Touch and hold the **UPPER**
OFF and then the CONVECTION pad at the same time.
3. F appears in the temperature digits; release both pads.
4. Touch CONVECTION; C replaces F. This alternates when CONVECTION is touched.
5. To complete the change, touch **UPPER**
OFF .

CALIBRATING OVEN TEMPERATURE

The electronic thermostat has been preset to 0°F and accurately maintains its setting. If the browning results are too light or too dark for your preferences, you can raise or lower the setting.

To change the Calibration of the Oven Temperature:

1. Turn off both ovens.
2. Touch and hold the **UPPER**
OFF pad and then touch the BAKE pad.
3. 0 appears in the temperature digits; release all pads.
4. Touch BAKE and 0 changes in increments of 5 degrees each time it is touched. The maximum adjustment is $\pm 35^{\circ}\text{F}$. In Centigrade the range is $\pm 3^{\circ}\text{C}$ to 21°C .
5. To complete the change, touch **UPPER**
OFF .

To calibrate the lower oven models: repeat the steps with this exception, touch **LOWER
OFF pad instead of the **UPPER**
OFF pad.**

Solving Baking Problems

With either BAKE or CONVECTION, poor results can occur for many reasons other than a malfunction of the oven. Check the chart below for causes of the most common problems. Since the size, shape and material of baking utensils directly affect the baking results, the best solution may be to replace old baking utensils that have darkened and warped with age and use. Check the Baking Charts for the correct rack position and baking time.

BAKING PROBLEM	CAUSE
Food browns unevenly	<ul style="list-style-type: none"> • Oven not preheated. • Aluminum foil on oven rack or oven bottom. • Baking utensil too large for recipe. • Pans touching each other or oven walls.
Food too brown on bottom	<ul style="list-style-type: none"> • Oven not preheated. • Using glass, dull or darkened metal pans. • Incorrect rack position. • Pans touching each other or oven walls.
Food dry or has shrunk excessively	<ul style="list-style-type: none"> • Oven temperature too high. • Baking time too long. • Oven door opened frequently. • Pan size too large.
Food baking or roasting too slowly	<ul style="list-style-type: none"> • Oven temperature too low. • Oven not preheated. • Oven door opened frequently. • Tightly sealed with aluminum foil. • Pan size too small.
Pie crusts do not brown on bottom or have soggy crust	<ul style="list-style-type: none"> • Baking time not long enough. • Using shiny steel pans. • Incorrect rack position. • Oven temperature is too low.
Cakes pale, flat and may not be done inside	<ul style="list-style-type: none"> • Oven temperature too low. • Incorrect baking time. • Cake tested too soon. • Oven door opened too often. • Pan size may be too large.
Cakes high in middle with crack on top	<ul style="list-style-type: none"> • Baking temperature too high. • Baking time too long. • Pans touching each other or oven walls. • Incorrect rack position. • Pan size too small.
Pie crust edges too brown	<ul style="list-style-type: none"> • Oven temperature too high. • Edges of crust too thin.

Solving Operational Problems

Before calling for service, check the following to avoid unnecessary service charges.

PROBLEM OVEN	PROBLEM SOLVING STEPS
All the numbers touched do not appear in display	The numbers were touched too rapidly. Be sure you remove your finger from the number pad before touching the next digit.
F followed by 2 digits appears in the display window	Touch OFF or turn power off at the circuit breaker, wait 3 minutes and turn it back on. If condition persists, note the code number and call an authorized servicer.
F-24 or F-25 appears in display window	This is caused by close contact to the control panel for more than 60 seconds, such as someone leaning against the controls or objects hanging in front of controls. See item above for correction.
5Ab appears in display window	Turn off the oven selected by touching <u>UPPER OFF</u> or <u>LOWER OFF</u> .
Cooling fan continues to run after oven is turned off.	The fan turns off automatically when the electronic components have cooled sufficiently.
Clock and timer do not work	Make sure there is proper electrical power to the oven. See the CLOCK and TIMER sections on Pages 9 & 10.
Oven will not work	Make sure there is proper electrical power to the oven. Check the circuit breaker or fuse box to your house.
Oven light does not work	Replace or reinsert the light bulb if loose or defective (see Page 61). Touching the bulb with your fingers may cause the bulb to burn out quickly. Oven light does not work if CLEAN mode is set.
Oven temperature is too hot or too cold	The oven thermostat needs adjustment. See CALIBRATING OVEN TEMPERATURE in Do-It-Yourself Maintenance, Page 62.
Oven will not self-clean	The oven temperature is too high to set the Self Clean operation. Allow the oven to cool to room temperature and reset the controls. Be sure you have touched CLEAN.
Oven door will not unlock	Allow the oven to cool below the locking temperature.
Oven is not clean after the clean cycle	Heavily soiled ovens may need to Self Clean again or for a longer period of time. Heavy spillovers should be cleaned before starting the clean cycle. See Preparing to Self-Clean, Pages 55 and 57.
208 Volt Connection	1. Open oven door. 2. Press and hold the UPPER OFF pad in a double oven or the OFF pad in a single oven. 3. While pressing pad, press the CLEAN pad and 240 will appear in the display. 4. Release all pads. 5. Touch CLEAN and 208 will replace 240 in display. Touch UPPER OFF or OFF.

HOW TO OBTAIN SERVICE

For authorized service or parts information, call 800/ 735-4328.

We want you to remain a satisfied customer. If a problem does come up that cannot be resolved to your satisfaction write to: Thermador Customer Support Call Center, 5551 McFadden Avenue, Huntington Beach CA, 92649 or phone: 800/ 735-4328.

Please include the Model Number, Serial Number and Date of Original Purchase/Installation.

THERMADOR BUILT-IN OVEN WARRANTY

For Model CJ302

WHAT IS COVERED

Full One Year Warranty

Covers one year from date of installation, or date of occupancy on a new or previously unoccupied dwelling. Save your dated receipt or other evidence of installation / occupancy date. Thermador® will pay for all repair labor and replacement parts found to be defective due to materials and workmanship. A Factory Authorized Service Agency must provide Service during normal working hours.

Limited Four Year Warranty

Covers the second through fifth years from date of occupancy on a new, previously unoccupied dwelling. Replacements of the magnetron tube if it falls within four years following the expiration of the full warranty.

WHAT IS NOT COVERED

1. Service by an unauthorized agency. Damage or repairs due to service by an unauthorized agency or the use of unauthorized parts.
2. Service visits to:
 - Teach you how to use the appliance.
 - Correct the installation. You are responsible for providing electrical wiring, and other connecting facilities.
 - Reset circuit breakers or replace home fuses.
3. Damage resulting from accident, alteration, misuse, abuse, improper installation, or installation not in accordance with local electrical codes or plumbing codes, or improper storage of the appliance.
4. Repairs due to other than normal home use.
5. Any service visits and labor costs during the limited warranty.

WARRANTY APPLICATIONS

This warranty applies to appliances used in residential applications. It does not cover their use in commercial situations.

This warranty is for products purchased and retained in the 50 states of the U.S.A., the District of Columbia and Canada. The warranty applies even if you should move during the warranty period. Should the original purchaser sell the appliance, during the warranty period, the new owner continues to be protected until the expiration date of the original purchaser's warranty period.

This warranty gives you specific legal rights. You may also have other rights, which vary, from state to state.

SERVICE DATA

The serial tag on the product can be seen inside the front cooling vents on the right-hand side. Please see Item 2 on Page 6. Now is a good time to write this information in the space provided below. Keep your invoice for warranty validation. To obtain service, see Page 58.

Model Number:
Serial Number:
Date of Installation or Occupancy:

Specifications are for planning purposes only. Refer to installation instructions and consult your countertop supplier prior to making counter opening. Consult with a heating and ventilating engineer for your specific ventilation requirements. We reserve the right to change specifications or design without notice. Some models are certified for use in Canada. Thermador is not responsible for products which are transported from the U.S. for use in Canada. Check with your local Canadian distributor or dealer.

For the most up-to-date critical installation dimensions by fax, use your fax handset and call (702) 833-3600. Use code #8030.



Thermador®

5551 McFadden Avenue, Huntington Beach, CA 92649 • 800/735-4328
ECO 12786 • 5020006199 • 16-11-524G • © 2003 BSH Home Appliances Corp. • Litho Date: 1/03

Free Manuals Download Website

<http://myh66.com>

<http://usermanuals.us>

<http://www.somanuals.com>

<http://www.4manuals.cc>

<http://www.manual-lib.com>

<http://www.404manual.com>

<http://www.luxmanual.com>

<http://aubethermostatmanual.com>

Golf course search by state

<http://golfingnear.com>

Email search by domain

<http://emailbydomain.com>

Auto manuals search

<http://auto.somanuals.com>

TV manuals search

<http://tv.somanuals.com>