



REZNOR Thomas & Betts

Indirect Fired, Indoor, Downflow, Packaged Heaters

Installation/Operation FORM RZ-NA I-LDAP

APPLIES TO: Model LDAP

Table of Contents

	Page
Warnings	1
Installation/Operation	2-29
Check/Test/Startup	30-31
Accessories	32
Maintenance/Service	32-40

Index (by page)

Burners	13, 33
Burner Orifice	35
California Warning Label	2
Clearances	6
Installation Codes	2
Combustion Air	6
Confined Space	6
Destratification	18
Dimensions	4
Electrical Connections	13
Fan	20, 36
Fan Control (Destratification)	18, 38
Fan Motor	21, 36
Gas Piping and Pressures	10
Gas Valve	21, 37
General	2
Hazard Intensity Levels	2
Heat Exchanger Maintenance	33
High Altitude	3, 12
High Limit Control	17, 38
Ignition System	18, 35
LED Flash Codes	38
Limit Control	17, 38
Location (Heater)	7
Louvers	3, 10, 32
Maintenance Schedule	32-33
Nozzle (Option)	3, 32
Pressure Switch (Combustion Air)	5, 17, 37
Replacement Parts	See Form P-LDAP
Sound Data	8
Startup	30
Suspending Heater	8
Technical Data	4
Thermostat (Option)	14
Throw Data	7
Transformer	38
Troubleshooting	38-40
Uncrating and Preparation	3
Valve Outlet Pressure	12
Vent System Maintenance	38
Venter Motor (Heat Section)	35
Venter Motor (Main)	36
Venting	26
Wall Mounting	9
Warranty	2
Weights	8
Wiring Diagrams	22-25



Reznor® Model LDAP 1200



FOR YOUR SAFETY

If you smell gas:

- 1. Open windows.**
- 2. Don't touch electrical switches.**
- 3. Extinguish any open flame.**
- 4. Immediately call your gas supplier.**

FOR YOUR SAFETY

The use and storage of gasoline or other flammable vapors and liquids in open containers in the vicinity of this appliance is hazardous.

WARNING: Improper installation, adjustment, alteration, service, or maintenance can cause property damage, injury, or death. Read the installation, operation, and maintenance instructions thoroughly before installing or servicing this equipment.

WARNING: Gas-fired appliances are not designed for use in hazardous atmospheres containing flammable vapors or combustible dust, in atmospheres containing chlorinated or halogenated hydrocarbons, or in applications with airborne silicone substances. See Hazard Levels, page 2.

WARNING: Should overheating occur, or the gas supply fail to shut off, shut off the manual gas valve to the appliance before shutting off the electrical supply.

WARNING: Do not use this appliance if any part has been under water. Immediately call a qualified service technician to inspect the appliance and replace any gas control that has been under water.

Hazard Levels of Warnings in this Manual

HAZARD INTENSITY LEVELS

1. **DANGER:** Failure to comply will result in severe personal injury or death and/or property damage.
 2. **WARNING:** Failure to comply could result in severe personal injury or death and/or property damage.
 3. **CAUTION:** Failure to comply could result in minor personal injury and/or property damage.
-

1. General

All Model LDAP high bay packaged heaters are design certified by ITS for use in industrial and commercial installations. All models and sizes are available for use with either natural or propane gas. The type of gas, the input rate, and the electrical supply requirement are shown on the heater rating plate. Check the rating plate to determine if the heater is appropriate for the intended installation.

The instructions in this manual apply **only** to Reznor® Model LDAP heaters.

Installation should be done by a qualified agency in accordance with these instructions. The qualified service agency installing this heater is responsible for the installation.

2. Installation Codes

These heaters must be installed in accordance with local building codes. In the absence of local codes, in the United States, the heater must be installed in accordance with the National Fuel Gas Code, ANSI Z223.1. A Canadian installation must be in accordance with the CSA B149 Installation Codes. These codes are available from CSA Information Services, 1-800-463-6727. Local authorities having jurisdiction should be consulted before installation is made to verify local codes and installation procedure requirements.

Special Installations (Aircraft Hangars/ Repair Garages/ Parking Garages)

Installations in aircraft hangars should be in accordance with ANSI/NFPA No. 409 (latest edition), Standard for Aircraft Hangars; in public garages in accordance with ANSI/NFPA No. 88A (latest edition), Standard for Parking Structures; and for repair garages in accordance with ANSI/NFPA No. 88B (latest edition), Standard for Repair Garages. In Canada, installations in aircraft hangars should be in accordance with the requirements of the enforcing authorities, and in public garages in accordance with CSA B149 codes.

California Warning Label

If the heater is being installed in the state of California, the installer **MUST** attach a warning label on the outside of the access door. The California Warning label is shipped in the owner's envelope along with this manual, the warranty form, and any other paperwork that applies.

If installation is in California, select a location on the heater access panel. Be sure the surface is clean and dry and adhere the label.

Massachusetts Requirement

If the heater is being installed in the Commonwealth of Massachusetts, this heater must be installed by a licensed plumber or licensed gas fitter.

3. Warranty

Refer to the limited warranty information on the Warranty Card in the "Owner's Envelope".

Warranty is void if ...

- a. Wiring is not in accordance with the diagram furnished with the heater.
 - b. The heater is installed without proper clearance to combustible materials.
 - c. The heater is connected to a duct system or if the air delivery system is modified by other than manufacturer-designed accessories.
-

4. Uncrating and Preparation

This heater was test operated and inspected at the factory prior to crating and was in operating condition. If the heater has incurred any damage in shipment, document the damage with the transporting agency and contact an authorized Reznor Distributor. If you are an authorized Distributor, follow the FOB freight policy procedures as published by Thomas & Betts for Reznor products.

Check the rating plate for the gas specifications and electrical characteristics of the heater to be sure that they are compatible with the gas and electric supplies at the installation site.

IMPORTANT: The crate bottom should be removed after the heater is lifted. Shipping brackets are attached with cabinet screws. When removing shipping brackets, re-insert ALL screws into the cabinet.

Read this booklet and become familiar with the installation requirements of your particular heater. If you do not have knowledge of local requirements, check with the local gas company or any other local agencies who might have requirements concerning this installation. If the installation is above 2000 ft (610M) elevation, follow the instructions in Paragraph 5 and Paragraph 12.

Before beginning, make preparations for necessary supplies, tools, and manpower. Locate the hardware kit supplied with the heater. The plastic bag contains spring nuts, hex nuts, "U"-shape fittings, lock washers, louvers, and compression springs.

Be sure that all shipped-separate options that were ordered are at the installation site. Shipped-separate items could include a vent cap, louvers, nozzles, hanger kit, a manual shutoff valve, a thermostat, multiple heater controls, high temperature tape, and/or a high altitude kit.

5. High Altitude Operation



Pressure Switch

Instructions for Changing Heat section Pressure

NOTE: Do not change the main pressure switch located on top of a Size 800 and Size 1200 heater. It is the same for all elevations.

If the heater is being installed at an elevation above 2000 ft (610M), the input rate will have to be derated. This is done by adjusting the outlet pressure of the gas valve and can only be done after the heater is in operation. Follow the instructions in Paragraph 12.

If the heater is being installed at an elevation above 6000 ft (1830M), the heat section pressure switch(es) will need to be changed. If ordered with the heater as Option DJ20, the pressure switch is shipped separately.

High Altitude Unit Pressure Switch(es)							
Size	Qty	Start-up Cold	Equilibrium Hot	Setpoint OFF	Setpoint ON	Label Color	Switch Part No.
		Differential Pressure (in. w.c.)					
400	1	1.75 to 1.45	1.00 to 0.80	0.60	0.78	Lt. Blue	197029
800	2	1.85 to 1.55	1.05 to 0.85	0.60	0.78	Lt. Blue	197029
1200	3	2.35 to 1.85	1.50 to 0.95	0.60	0.78	Lt. Blue	197029

Switch(es)

1. In the control compartment of the first heat section, locate the pressure switch.
2. Mark and disconnect the two wires attached to the pressure switch.
3. Mark and disconnect the sensing tubes from the pressure switch.
4. Locate the two screws holding the switch mounting bracket. Remove the screws (save screws) and the pressure switch.
5. Using the same screws, install the high altitude pressure switch. Attach the sensing tubes and wires.
6. If installing a Model LDAP 400, the pressure switch change for high altitude is complete. If installing a Model LDAP 800, repeat Steps 1-5 to change the pressure switch on the second heat section. If installing a Model LDAP 1200, repeat Steps 1-5 to change the pressure switches on the second and third heat sections.

6. Technical Data

Model LDAP 400

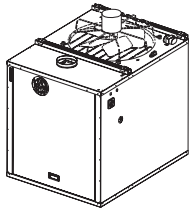

One Downflow Heater

Model LDAP 800

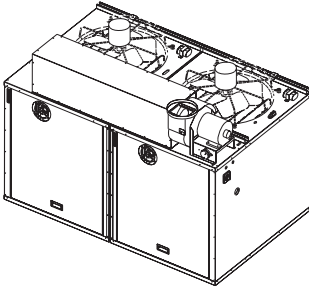

One Heater with Two Downflow Heat Sections

Model LDAP 1200

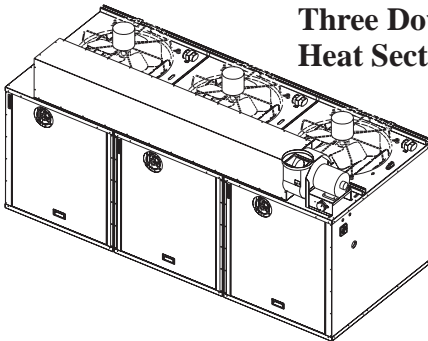

One Heater with Three Downflow Heat Sections

Model LDAP Size		400	800	1200
Input Heating Capacity	btuh	400,000	800,000	1,200,000
	kw/h	117.1	234.2	351.4
Thermal Efficiency (%)		83	83	83
Output Heating Capacity	btuh	332,000	664,000	996,000
	kw/h	97.2	194.4	291.6
Gas Connection (Inches)		1	1-1/4	1-1/4
Vent Connection Diameter (Inches)		6	8	8
Control Amps (24 volt)		1.0	2.0	3.0
Full Load Amps (208 volt)		5.6	13.6	19.4
Full Load Amps (230 volt)		5.5	12.8	18.5
Normal Power Consumption @ 208V (watts)		1150	2448	3730
Normal Power Consumption @ 230V (watts)		1230	2597	3959
Discharge Air Temperature Rise (°F)		55	55	55
Air Volume (Heat @ High Speed)	cfm	5589	11178	16768
	m ³ /minute	158	317	475
Discharge Air Opening Area	ft ²	3.67	7.35	11.02
	m ²	0.34	0.68	1.02
Outlet Velocity (Heat @ High Speed)	fpm	1521	1521	1521
	m/minute	464	464	464
Air Volume (Destratification @ Medium Speed)	cfm	4650	9300	13950
	m ³ /minute	132	263	395
Outlet Velocity (Destratification @ Medium Speed)	fpm	1266	1266	1266
	m/minute	386	386	386
Air Volume (Destratification @ Low Speed)	cfm	3250	6500	9750
	m ³ /minute	92	184	276
Outlet Velocity (Destratification @ Low Speed)	fpm	885	885	885
	m/minute	270	270	270
Fan Motor HP (Qty)		1 (1)	1 (2)	1 (3)
Fan Motor RPM		1050	1050	1050
Fan Diameter (Inches)		24	24	24

7. Dimensions

FIGURE 1A - Model LDAP 400

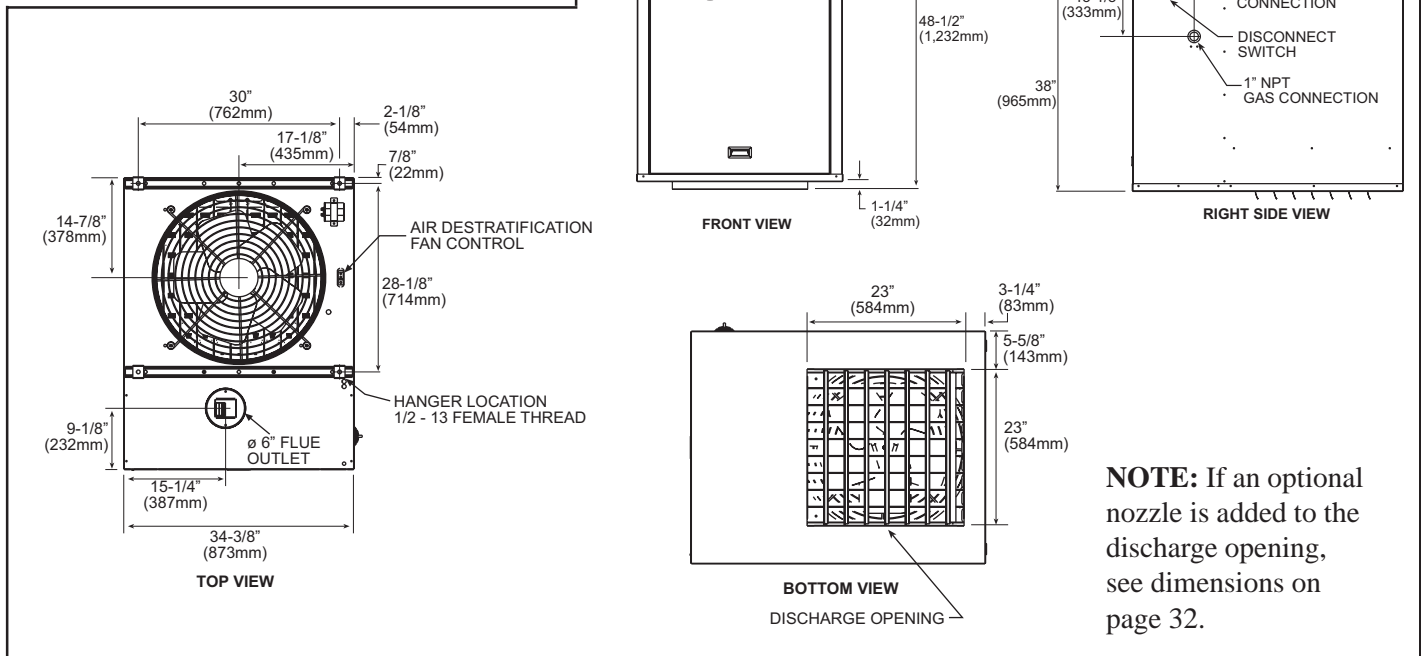

NOTE: If an optional nozzle is added to the discharge opening, see dimensions on page 32.

FIGURE 1B - Model LDAP800 and Model LDAP1200

A Model LDAP1200 with three heat sections is illustrated. A Model LDAP800 has two heat sections. A Model LDAP800 is the same layout as illustrated less the middle heat section.

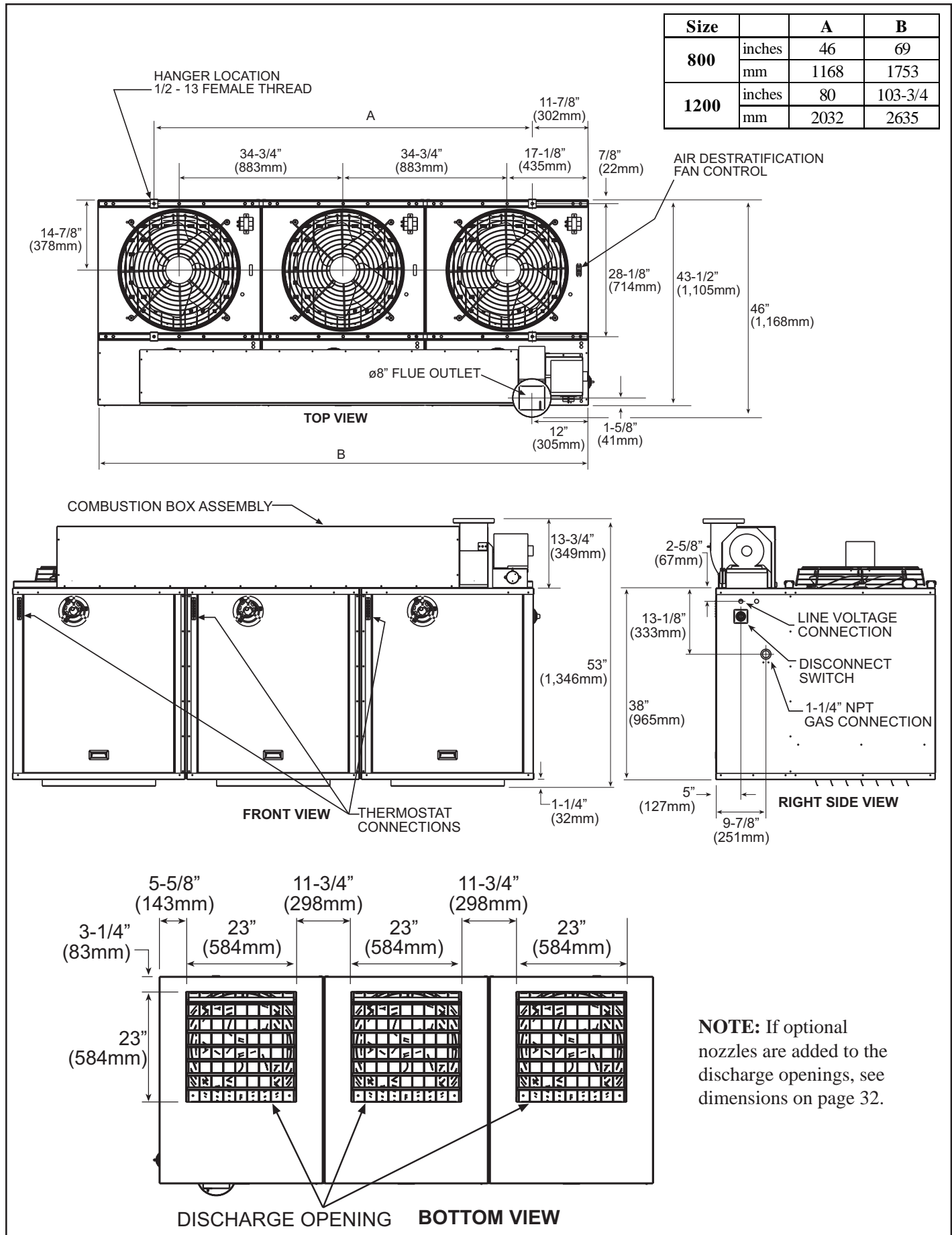

8. Clearances

Heaters must be installed so that the clearances in the table are provided for combustion air space, inspection and service, and for proper spacing from combustible construction. Clearance to combustibles is defined as the minimum distance from the heater to a surface or object that is necessary to ensure that a surface temperature of 90°F above the surrounding ambient temperature is not exceeded.

Clearances - inches/mm

Size	Top		Flue Connector		Front (Access Panel)		Rear		Disconnect Side		Side		Bottom	
	inches	mm	inches	mm	inches	mm	inches	mm	inches	mm	inches	mm	inches	mm
400	12	305	6	152.4	18	457	2	50.8	18	457	2	50.8	60	1524
800	12	305	6	152.4	18	457	2	50.8	18	457	2	50.8	60	1524
1200	12	305	6	152.4	18	457	2	50.8	18	457	2	50.8	60	1524

9. Combustion Air

This heater must be supplied with the air that enters into the combustion process and is then vented to the outdoors. Sufficient air must enter the equipment location to replace that exhausted through the heater vent system. In the past, the infiltration of outside air assumed in heat loss calculations (one air change per hour) was assumed to be sufficient. However, current construction methods using more insulation, vapor barriers, tighter fitting and gasketed doors and windows, weather-stripping, and/or mechanical exhaust fans may now require the introduction of outside air through wall openings or ducts.

The requirements for combustion and ventilation air depend upon whether the heater is located in a confined or unconfined space. An "unconfined space" is defined as a space whose volume is not less than 50 cubic feet per 1000 BTUH of the installed appliance. **Under ALL conditions**, enough air must be provided to ensure there will not be a negative pressure condition within the equipment room or space.

WARNING: A Model LDAP power-vented heater is designed to take combustion air from the space in which the heater is installed and is not designed for connection to outside combustion air intake ducts. Connecting outside air ducts voids the warranty and could cause hazardous operation. See Hazard Levels, page 2.

FIGURE 2 - Definition of Confined Space and Required Openings for Combustion Air

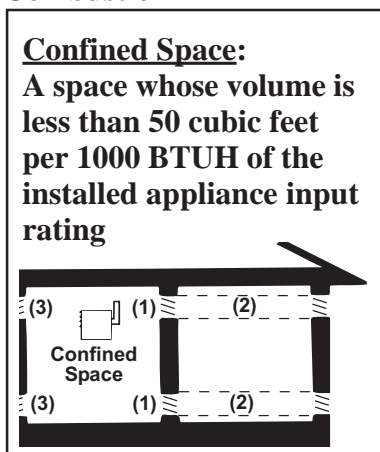

Combustion Air Requirements for a Heater Located in a Confined Space

Do not install a heater in a confined space without providing wall openings leading to and from the space. Provide openings near the floor and ceiling for ventilation and air for combustion as shown in **FIGURE 2**, depending on the combustion air source as noted in Items 1, 2, and 3 below.

Add total BTUH of all appliances in the confined space and divide by figures below for square inch free area size of each (top and bottom) opening.

- 1. Air from inside the building** - openings 1 square inch free area per 1000 BTUH. Never less than 100 square inches free area for each opening. See (1) in **FIGURE 2**.
- 2. Air from outside through duct** - openings 1 square inch free area per 2000 BTUH. See (2) in **FIGURE 2**.
- 3. Air direct from outside** - openings 1 square inch free area per 4000 BTUH. See (3) in **FIGURE 2**.

NOTE: For further details on supplying combustion air to a confined space, see the National Fuel Gas Code ANSI Z223.1a (latest edition).

10. Heater Location

Use the clearances in Paragraph 8; the combustion air requirements in Paragraph 9; the mounting height requirements, throw information, sound data, and location recommendations below; the weights in Paragraph 11; and the venting requirements in Paragraph 24 to determine where to suspend the heater.

CAUTION: Do not locate the heater where it may be exposed to water spray, rain, or dripping water.

Mounting Height

Locate the heater so that it is a minimum of 15 feet (4.6M) above the floor and in compliance with the clearances in Paragraph 8.

WARNING: If touched, the vent pipe and internal heater surfaces that are accessible from outside the heater will cause burns. Suspend the heater a minimum of 15 feet (4.6M) above the floor.

Heater Throw - All Models

FIGURE 3 - Model LDAP Air Throw (Heat Mode @ High Speed) - Applies to All Sizes

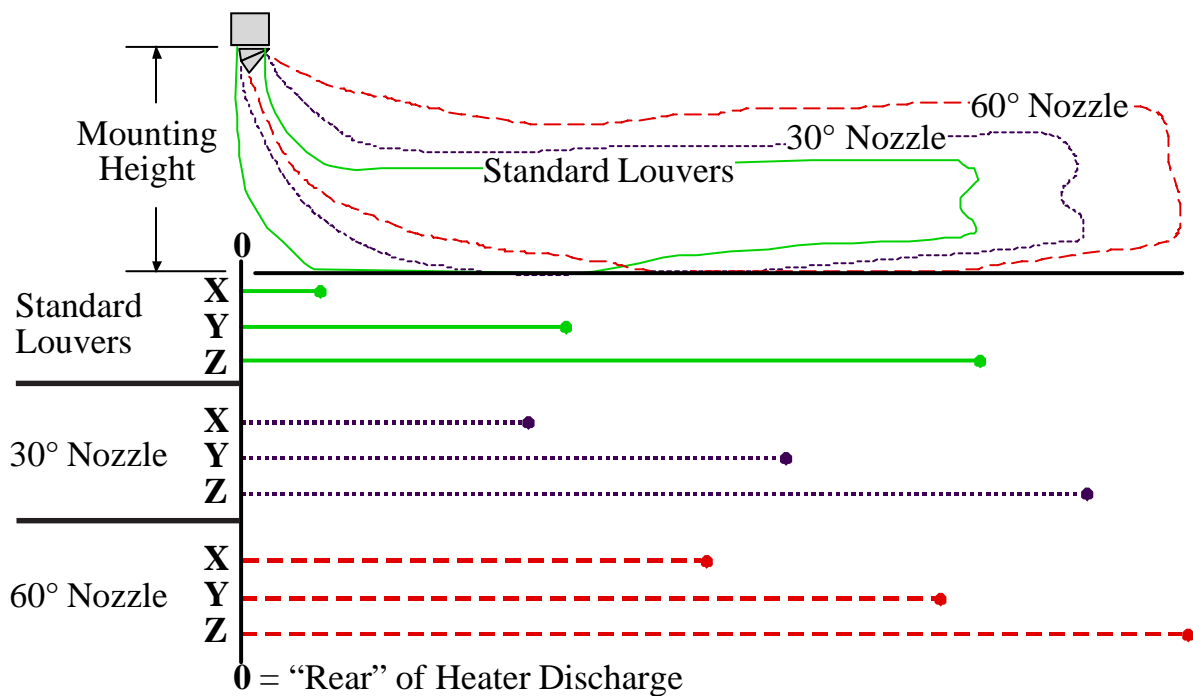

NOTES:

- X = Distance from “0” to beginning of floor coverage.
- Y = Distance from “0” to end of floor coverage.
- Length of floor coverage = Y - X.
- Z = Distance from “0” to the point where the air velocity drops below 50 feet (15.2M) per minute.
- Throws listed are with standard louvers facing one direction and fully open. Throw pattern changes with louver angle, 2-way louver direction, and or optional 4-way louvers.

Throw (feet and meters)

Mounting Height (feet)	Standard Louvers			30° Degree Nozzle			60° Degree Nozzle		
	X	Y	Z	X	Y	Z	X	Y	Z
	Throw (feet)								
20	5	55	134	40	90	146	70	125	158
30	8	53	121	44	86	133	76	119	145
40	12	49	109	47	81	120	N/A	N/A	N/A
50	17	45	96	N/A	N/A	N/A	N/A	N/A	N/A

Mounting Height (Meters)	Standard Louvers			30° Degree Nozzle			60° Degree Nozzle		
	X	Y	Z	X	Y	Z	X	Y	Z
	Throw (meters)								
6.1	1.5	16.8	40.8	12.2	27.4	44.5	21.3	38.1	48.2
9.1	2.4	16.2	36.9	13.4	26.2	40.5	23.2	36.3	44.2
12.2	3.7	14.9	33.2	14.3	24.7	36.6	N/A	N/A	N/A
15.2	5.2	13.7	29.3	N/A	N/A	N/A	N/A	N/A	N/A

10. Heater Location (cont'd)

Sound Data

Sound Chart - Model LDAP															
Model LDAP	DISTANCE														
	20 ft (6.1M)			25 ft (7.6M)			30 ft (9.1M)			35 ft (10.7M)			40 ft (12.2M)		
Size	db	Pa	µbar	db	Pa	µbar	db	Pa	µbar	db	Pa	µbar	db	Pa	µbar
400	69	0.058	0.580	65	0.037	0.371	62	0.026	0.258	60	0.019	0.189	57	0.015	0.145
800	72	0.080	0.800	68	0.051	0.512	65	0.036	0.356	62	0.026	0.261	60	0.020	0.200
1200	74	0.100	1.000	70	0.064	0.640	67	0.044	0.444	64	0.033	0.327	62	0.025	0.250

µbar = microbar Pa = Pascal

Location Recommendations

NOTE: Venting requirements may affect location. Consult requirements in Paragraph 24 before making final determination.

For best results, the heater should be placed with certain rules in mind. In general, a heater should be located from 15-40 feet (4.6-12.2 M) above the floor. If two or more heaters are installed in the same room, a general scheme of air circulation should be maintained for best results.

Suspended heaters are most effective when located as close to the working zone as possible, and this fact should be kept in mind when determining the mounting heights to be used. However, care should be exercised to avoid directing the discharged air directly on the room occupants.

Partitions, columns, counters, or other obstructions should be taken into consideration when locating the heater so that a minimum quantity of airflow will be deflected by such obstacles.

The presence of chlorine vapors in the combustion air of gas-fired heating equipment presents a potential corrosion hazard. Chlorine found usually in the form of freon or degreaser vapors, when exposed to flame will precipitate from the compound, and go into solution with any condensation that is present in the heat exchanger or associated parts. The result is hydrochloric acid which readily attacks all metals including 300 grade stainless steel. Care should be taken to separate those vapors from the combustion process. This may be done by wise location of the heater with regard to exhausters or prevailing wind directions. Chlorine is heavier than air. Keep these facts in mind when determining installation location of the heater in relation to building exhaust systems.

Hazards of Chlorine

11. Hanging or Mounting the Heater and Installing Louvers

Weight (lbs/kg)

Size	400	800	1200
lbs	375	805	1195
kg	170	365	542

Before installing the heater, check the supporting structure to be used to verify that it has sufficient load-carrying capacity to support the weight.

Suspending the Heater

Locate the hardware kit shipped with the heater. The kit contains spring nuts, hex nuts, "U"-shape fittings, and lock washers for suspending the heater. It also includes louvers and the compression springs needed to install them.

When the heater is lifted for suspension, support the bottom of the heater with the crate bottom. If the bottom is not supported, damage could occur. Before hanging or mounting, verify that any screws used for holding shipping brackets were re-installed in the cabinet.

WARNINGS: Check the supporting structure to be used to verify that it has sufficient load carrying capacity to support the weight of the heater. Suspend the heater only from the threaded nut retainers or with a manufacturer provided kit. Do NOT suspend from the heater cabinet.

See **FIGURE 1A** or **1B** for the appropriate hanging locations, and install the ½"-13 spring nuts in the strut that is attached to the top of the unit. Comply with the requirements in **FIGURE 4A** when using threaded rod. If ordered with swivel connectors for 1" pipe, Option CK10, attach the swivels to the spring nuts according to illustration in **FIGURE 4B** and suspend with 1" pipe.

WARNING: All heaters must be level for proper operation. Do not place or add additional weight to the suspended heater. Hazard Levels, page 2.

FIGURE 4A - Suspending the Heater with Rods from the Threaded Nut Retainers

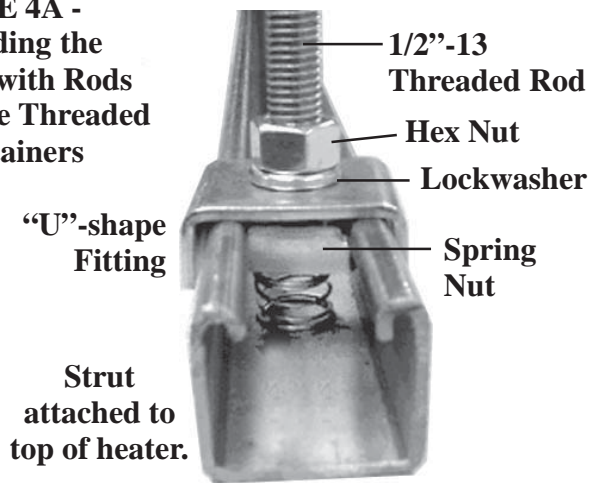

Be sure the threaded hanger rods are locked to the heater as illustrated. Recommended maximum hanger rod length is 6 feet (1.8M).

FIGURE 4B- Swivel Connectors to Suspend the Heater from 1\"/>

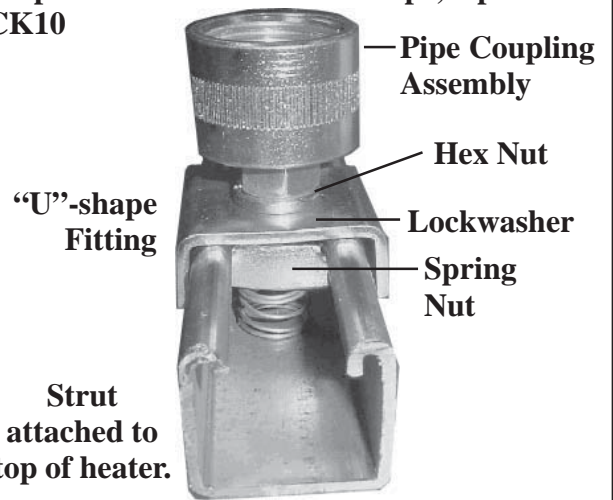

Be sure the threaded swivel connectors are locked to the heater as illustrated.

Wall Mounting

The heater may be attached to a wall. Place supports as shown in **FIGURE 5** and comply with all guidelines listed.

Guidelines for Wall Mounting Model LDAP Heaters

- Mounting is the responsibility of the installer. Verify that the supporting structure has sufficient load-carrying capacity to support the weight. (See weights, page 8.)
- Prior to installation, be sure that the method of support is in agreement with all local building codes. Check for service platform requirements.
- Maintain a minimum of 2" (51mm) clearance from the discharge air openings to structural supports. Additional clearance will be required if an optional nozzle is to be field installed.
- Determining the need for installing vibration or noise isolation is the responsibility of the installer.
- To prevent potential movement, field-supplied angles must be placed around the perimeter of the heater to anchor it to the structural supports.
- Structural supports must be placed as shown to prevent damage to the heater.
- All structural supports must be non-combustible materials.

FIGURE 5 - Wall Mounting (All structural supports and angles are field supplied.)

All dimensions are measured from centerlines of field-supplied structural supports.

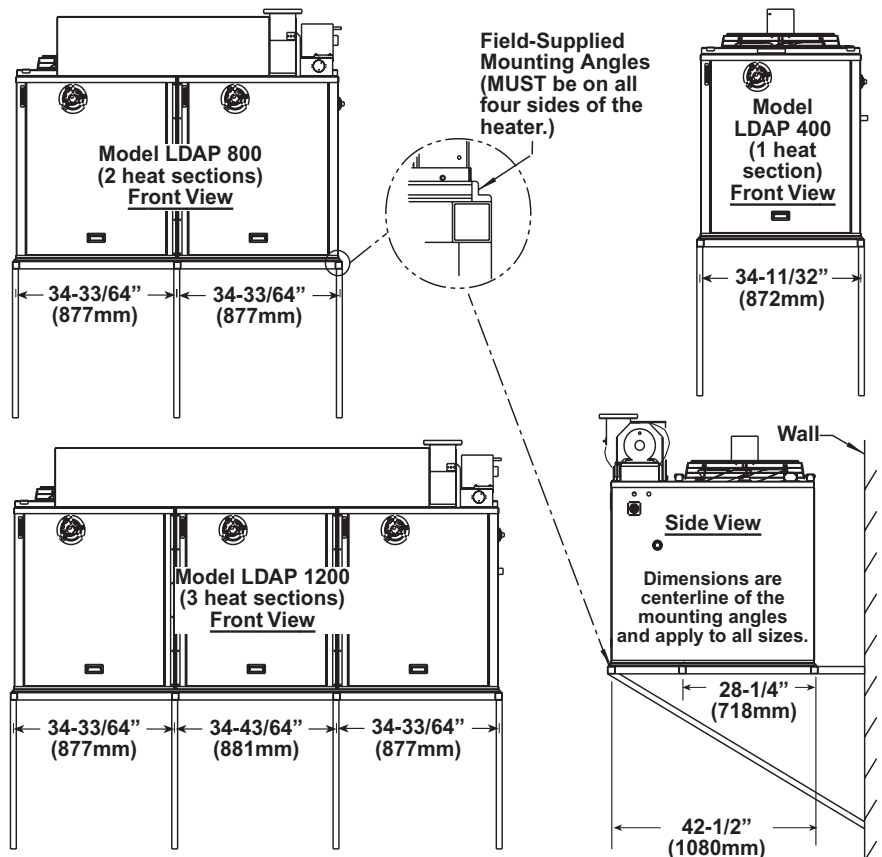

11. Installing Heater and Louvers (cont'd)

Installing Louvers

NOTE: Do not install louvers if installing a nozzle. Follow the instructions shipped with the nozzle.

FIGURE 6 - Use Compression Springs to Install Louvers in the Discharge Opening(s)

CAUTION: To avoid getting burned, adjust louvers while heater is not operating. If adjusting louvers while heater is operating, wear gloves.

After the unit is suspended/mounted, install the air directional louvers or optional nozzle. If an optional nozzle is being installed, follow the instructions included with the nozzle. If a nozzle is not being used, install the louvers in the discharge opening(s). Louvers and springs are in the hardware kit shipped with the heater.

Before actually installing the louvers, note the louver curve and determine how the louvers should be positioned to provide the optimal throw pattern. Opening is square so louvers may be installed either horizontal or vertical. Louvers may be installed with the curve all the same direction (either way) or the right half one way and left the other as illustrated in **FIGURE 6**.

Louver Installation Instructions:

- 1) With the wider section of the louver facing out of the heater, place one of the compression springs over the tab on the notched end of a louver. The end of the louver with the spring will fit in any direction in the square opening. How the louver turns depends on which end of the louver is inserted first.
- 2) Depending on the throw pattern selected, push the louver tab with the spring into a hole in the discharge opening and insert the louver tab on the other end into the corresponding hole on the opposite side.
- 3) Continue until all louvers are installed. Adjust the louvers to provide the desired throw pattern.

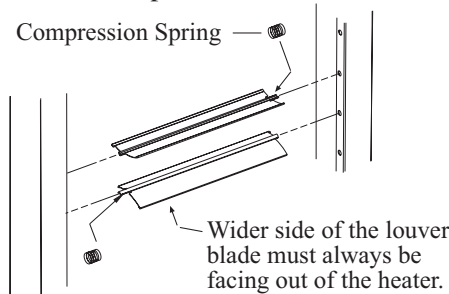

Airflow direction depends on how the louvers are installed.

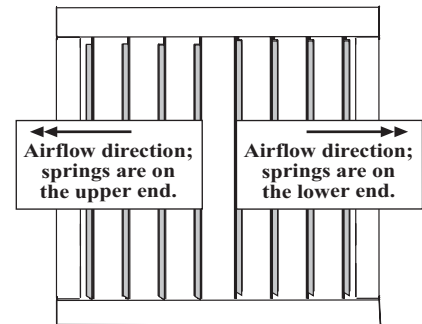

12. Gas Piping and Pressures

Sizing Gas Supply Line

WARNING: All components of a gas supply system must be leak tested prior to placing equipment in service. NEVER TEST FOR LEAKS WITH AN OPEN FLAME. Failure to comply could result in personal injury, property damage or death.

WARNING: This appliance is equipped for a maximum gas supply pressure of 1/2 psi, 3.5 kPa, or 14 inches water column. Supply pressure greater than 1/2 psi requires installation of an additional lock-up-type service regulator external to the heater.

WARNING: PRESSURE TESTING SUPPLY PIPING

Test Pressures Above 1/2 PSI: Disconnect the heater and manual valve from the gas supply line which is to be tested. Cap or plug the supply line.

Test Pressures Below 1/2 PSI: Before testing, close the manual valve on the heater.

Length of Pipe	Capacity of Piping - Cubic Feet per Hour based on 0.3" w.c. Pressure Drop									
	Specific Gravity for Natural Gas -- 0.6 (Natural Gas -- 1000 BTU/Cubic Ft)									
	Specific Gravity for Propane Gas -- 1.6 (Propane Gas -- 2550 BTU/Cubic Ft)									
	Diameter of Pipe									
	1"		1-1/4"		1-1/2"		2"		2-1/2"	
	Natural	Propane	Natural	Propane	Natural	Propane	Natural	Propane	Natural	Propane
20'	350	214	730	445	1100	671	2100	1281	3300	2013
30'	285	174	590	360	890	543	1650	1007	2700	1647
40'	245	149	500	305	760	464	1450	885	2300	1403
50'	215	131	440	268	670	409	1270	775	2000	1220
60'	195	119	400	244	610	372	1105	674	1850	1129
70'	180	110	370	226	560	342	1050	641	1700	1037
80'	170	104	350	214	530	323	990	604	1600	976
90'	160	98	320	195	490	299	930	567	1500	915
100'	150	92	305	186	460	281	870	531	1400	854
125'	130	79	275	168	410	250	780	476	1250	763
150'	120	73	250	153	380	232	710	433	1130	689
175'	110	67	225	137	350	214	650	397	1050	641
200'	100	61	210	128	320	195	610	372	980	598

Note: When sizing supply lines, consider possibilities of future expansion and increased requirements. Refer to National Fuel Gas Code for additional information on line sizing.

Gas Connection Size

Gas Connection - inches/mm

Size	Natural Gas		Propane Gas	
	inches	mm	inches	mm
400	inches	1	1	
	mm	25.4	25.4	
800	inches	1-1/4	1-1/4	
	mm	31.8	31.8	
1200	inches	1-1/4	1-1/4	
	mm	31.8	31.8	

FIGURE 7 - Gas connection is at the pipe nipple that extends outside the cabinet.

IMPORTANT: Two pipe wrenches are required when installing gas piping. The gas pipe that is supplied with the heater **MUST** be held with a pipe wrench to prevent damage to the heater.

NOTE: Gas Conversion Kits are available for changing from propane gas to natural gas or natural gas to propane gas. A factory-authorized conversion kit **MUST** be used.

Valve Outlet or Orifice Pressure Setting

WARNING: Valve outlet gas pressure must never exceed 3.5" w.c. for natural gas and 10" w.c. for propane gas.

All piping must be in accordance with requirements outlined in the National Fuel Gas Code ANSI/Z223.1a (latest edition) or CSA-B149.1 and B149.2 (See Paragraph 2). Gas supply piping installation should conform with good practice and with local codes. Support gas piping with pipe hangers, metal strapping, or other suitable material; do not rely on the heater to support the gas pipe.

The heater is orificed for operation with natural gas having a heating value of 1000 (± 50) BTUH per cubic ft or propane gas with a heating value of 2500 (± 100) BTUH per cubic ft. If the gas at the installation does not meet these specifications, consult the factory for proper orificing.

Pipe joint compounds (pipe dope) shall be resistant to the action of liquefied petroleum gas or any other chemical constituents of the gas being supplied.

Install a ground joint union and manual shutoff valve upstream of the heater control system, as shown in **FIGURE 7**. Installation of a trap with a minimum 3" (76mm) drip leg is required.

To connect the gas, the heater is equipped with a nipple that extends outside the cabinet.

Leak-test all connections by brushing on a leak-detecting solution.

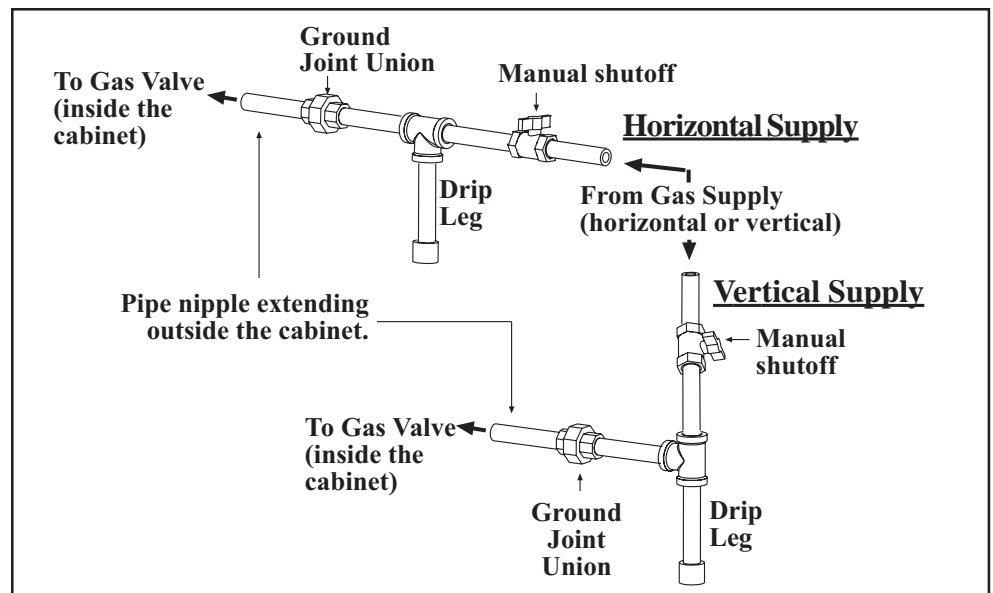

Measuring valve outlet gas pressure cannot be done until the heater is in operation. It is included in the steps of the "Check-Test-Start" procedure in Paragraph 25. The following warnings and instructions apply. Model LDAP 400 has one gas valve; Model LDAP 800 has two gas valves; and Model LDAP 1200 has three gas valves.

For Natural Gas: When the heater leaves the factory, the combination gas valve(s) is set so that the valve outlet gas pressure for a single stage valve or high fire of a two stage valve is regulated to 3.5" w.c. Low fire on a two-stage valve (Size 400 only) is set to 1.8" w.c. Inlet supply pressure to the heater for natural gas must be a minimum of 5" w.c. or as noted on the rating plate and a maximum of 14" w.c.

For Propane Gas: When the heater leaves the factory, the combination gas valve(s) is set so that the valve outlet gas pressure for a single stage valve or high fire of a two stage valve is regulated to 10" w.c. Low fire on a two-stage valve (Size 400 only) is set to 5.0" w.c. Inlet supply pressure to the heater for propane gas must be a minimum of 11" w.c. and a maximum of 14" w.c.

Before attempting to measure or adjust valve outlet gas pressure, the inlet supply pressure *must* be within the specified range both when the heater is in operation and on standby. Incorrect inlet pressure could cause excessive valve outlet gas pressure immediately or at some future time. If natural gas supply pressure is too high, install a regulator in the supply line before it reaches the heater. If natural gas supply pressure is too low, contact your gas supplier.

12. Gas Pressures (cont'd)

Check Valve Outlet Pressure (can only be done after heater is operating)

NOTE: If operating at high altitude, outlet pressure requires adjustment. Follow instructions below.

NOTES: If installation is above 6000 ft (1830M), a high altitude pressure switch is required on each heat section (all sizes). See Paragraph 5.

The main combustion air pressure switch (Sizes 800 and 1200 only) does not need to be changed for high altitude installation.

FIGURE 8 - Top View of Valves showing Outlet Pressure Tap and Adjustment Locations

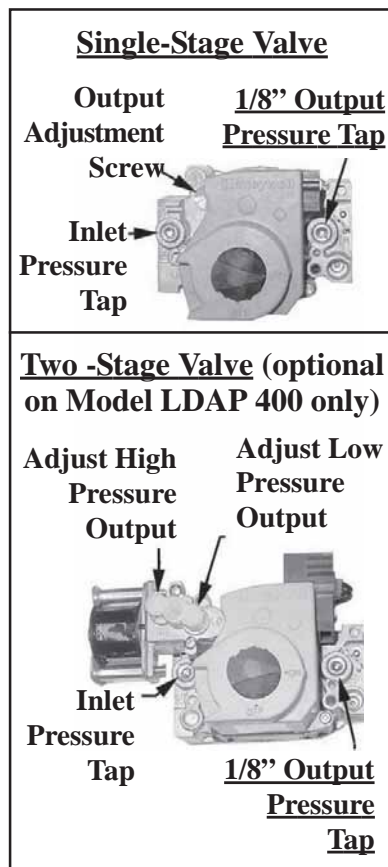

Instructions

- 1) Locate the 1/8" output pressure tap on the first valve (See **FIGURE 8**). With the manual valve turned off to prevent flow to the gas valve, connect a manometer to the 1/8" pipe outlet pressure tap in the valve. **NOTE:** A manometer (fluid-filled gauge) is recommended rather than a spring type gauge due to the difficulty of maintaining calibration of a spring type gauge.
- 2) Open the manual valve and operate the heater. Measure the outlet pressure of the gas valve. To measure low-stage pressure on a Size 400 unit equipped with a two-stage valve, disconnect the wire from the "HI" terminal on the valve. (Be sure to reconnect wire after testing.)
Normally when operating at sea level, adjustments should not be necessary to the factory setting(s). (For high altitude settings, see below.) If adjustment is necessary, remove the cap from the adjustment screw(s). Set pressure to correct settings by turning the regulator screw IN (clockwise) to increase pressure. Turn regulator screw OUT (counterclockwise) to decrease pressure.
- 3) If installing a Model LDAP 800, repeat to verify outlet pressure on second valve. If installing a Model LDAP 1200, repeat to verify outlet pressure check on second and third valve.

Derate by Valve Outlet Pressure Adjustment for High Altitude Operation

Instructions for High Altitude Derate

1. Determine the required valve outlet pressure for the elevation where the heater will be operating. If unsure of the elevation, contact the local gas supplier.

Valve Outlet Pressure Settings by Elevation

Manifold Pressure Settings by Altitude for the UNITED STATES					
Altitude		Natural Gas (inches w.c.)		Propane Gas (inches w.c.)	
Feet	Meters	Single-Stage and Two-Stage High Fire	Two-Stage Low Fire	Single-Stage and Two-Stage High Fire	Two-Stage Low Fire
0-2000	0-610	3.5	2.0	10.0	5.6
2001-3000	611-915	3.1	1.7	8.8	5.0
3001-4000	916-1220	3.0	1.7	8.5	4.8
4001-5000	1221-1525	2.8	1.6	8.1	4.6
5001-6000	1526-1830	2.7	1.5	7.7	4.4
6001-7000	1831-2135	2.6	1.5	7.4	4.2
7001-8000	2136-2440	2.5	1.4	7.1	4.0
8001-9000	2441-2745	2.4	1.3	6.7	3.8
9001-10000	2746-3045	2.4	1.3	6.7	3.6

Manifold Pressure Settings by Altitude for CANADA					
Altitude		Natural Gas (inches w.c.)		Propane Gas (inches w.c.)	
Feet	Meters	Single-Stage and Two-Stage High Fire	Two-Stage Low Fire	Single-Stage and Two-Stage High Fire	Two-Stage Low Fire
0-2000	0-610	3.5	2.0	10.0	5.6
2001-4500	611-1373	2.8	1.6	8.1	4.6

2. Locate the 1/8" output pressure tap on the first valve (See **FIGURE 8**). Turn the knob on the top of the valve to "OFF". Connect a manometer to the 1/8" pipe outlet pressure tap in the valve. Use a water column manometer that is readable to the nearest tenth of an inch.
3. **Single-Stage and Two-Stage High Fire** - Turn the knob on the top of the valve to "ON". Remove the cap from the pressure adjusting screw and adjust the gas train pressure to the pressure selected from the table above. Adjust pressure by turning the regulator screw IN (clockwise) to increase pressure or OUT (counterclockwise) to decrease pressure.
Two-Stage Low Fire - Disconnect the wire from the "HI" terminal on the gas valve and check the low fire pressure. Turn the regulator screw to adjust the low fire outlet pressure to the "Low Fire" pressure selected from the table. Reconnect the wire to the gas valve.

4. Turn up the thermostat. Cycle the burners once or twice to properly seat the adjustment spring in the valve.
Re-check the pressure(s). When the outlet pressure is right for the installation, remove the manometer and replace the cap.
Check for leak at the pressure tap fitting.
5. If installing a Model LDAP 800, repeat the adjustment at the second single-stage gas valve. If installing a Model LDAP 1200, repeat the adjustment at the second and third single-stage gas valves.
6. With the heater operating determine that the inlet pressure to the heater for natural gas is between 5 and 13.5 inches w.c. and for propane between 10 and 13.5 inches w.c. Take this reading at the inlet pressure tap of the first gas valve. If the inlet pressure is not within the specified range, the inlet pressure must be corrected and Steps 3 - 5 repeated.
7. Find the High Altitude Adjustment label in the plastic bag that contained these instructions. Using a permanent marker, fill-in the appropriate information from the "BTUH Input & Capacity by Altitude" Table, below. Select a location for the label on the outside of the heater main access panel so that it will be conspicuous to anyone operating or servicing the heater. Be sure the surface is clean and dry and adhere the label.

High Altitude Capacity Changes

The input and/or the capacity of the heater changes with the derate. The tables below list inputs and capacities at altitudes from sea level to 10,000 ft (3045M) for the U.S. and to 4500 ft (1373M) for Canada.

BTUH Inputs & Capacities by Altitude in the UNITED STATES for Model LDAP										
Altitude		Normal Input	Thermal Output Capacity	Minimum Input	Normal Input	Thermal Output Capacity	Minimum Input	Normal Input	Thermal Output Capacity	Minimum Input
Feet	Meters	Size 400			Size 800			Size 1200		
0 - 2000	0 - 610	400000	332000	300000	800000	664000	400000	1200000	996000	400000
2001 - 3000	611 - 915	376000	312080	282000	752000	624160	376000	1128000	936240	376000
3001 - 4000	916 - 1220	368000	305440	276000	736000	610880	368000	1104000	916320	368000
4001 - 5000	1221 - 1525	360000	298800	270000	720000	597600	360000	1080000	896400	360000
5001 - 6000	1526 - 1830	352000	292160	264000	704000	584320	352000	1056000	876480	352000
6001 - 7000	1831 - 2135	344000	285520	258000	688000	571040	344000	1032000	856560	344000
7001 - 8000	2136 - 2440	336000	278880	252000	672000	557760	336000	1008000	836640	336000
8001 - 9000	2441 - 2745	328000	272240	246000	656000	544480	328000	984000	816720	328000
9001 - 10000	2746 - 3045	320000	265600	240000	640000	531200	320000	960000	796800	320000

BTUH Inputs & Capacities by Altitude in the CANADA for Model LDAP										
Altitude		Normal Input	Thermal Output Capacity	Minimum Input	Normal Input	Thermal Output Capacity	Minimum Input	Normal Input	Thermal Output Capacity	Minimum Input
Feet	Meters	Size 400			Size 800			Size 1200		
0 - 2000	0 - 610	400000	332000	300000	800000	664000	400000	1200000	996000	400000
2001 - 4500	611 - 1373	360000	298800	270000	720000	597600	360000	1080000	896400	360000

13. Burners

Each heat section in this heater has a one-piece T_{CORE}²® burner assembly (U.S. Patent No. 6,889,686) designed to provide controlled flame stability without lifting or flashback with either natural or propane gas.

The burner can be removed as a unit for inspection or service; see Maintenance Section for removal instructions.

14. Electrical Supply and Connections

Supply Wiring

All electrical wiring and connections, including electrical grounding MUST be made in accordance with the National Electric Code ANSI/NFPA No. 70 (latest edition) or, in Canada, with CSA Standard C22.1. In addition, the installer should be aware of any local ordinances or gas company requirements that might apply.

Check the rating plate on the heater for the supply voltage and current requirements. A dedicated line voltage supply with disconnect switch should be run directly from the main electrical panel to the heater. All external wiring must be within approved

14. Electrical Supply and Connections (cont'd)

Supply Wiring (cont'd)

Disconnect Switch

FIGURE 9 - Built-in Disconnect Switch



24V Control Wiring Connections

15. Thermostat and Connections

conduit and have a minimum temperature rise rating of 60°C. Conduit must be run so as not to interfere with the heater access panel.

CAUTION: Route wires so that they do not contact the flue wrapper or venter housing. When running electrical conduit, be careful that it is clear of all access panels.

The heater is equipped with a built-in, non-fusible, lockable disconnect switch (FIGURE 8). If a fusible disconnect is required, it must be field supplied. The built-in disconnect switch requires copper wiring with ampacity based on 60°C maximum temperature rating at the line side terminals.

WARNING: To prevent injury or death due to electrocution or contact with moving parts, lock disconnect switch open. See Hazard Levels, page 2.

WARNING: If you turn off the power supply, turn off the gas. See Hazard Levels, page 2.

Model LDAP supply wiring enters above and connects directly to the disconnect switch (See FIGURE 1A or 1B in Paragraph 7 and FIGURE 9). A circuit board (See FIGURE 13 in Paragraph 20) is located in the control compartment of each heat section. The circuit boards are polarity sensitive. It is advisable to check the electrical supply to be certain that the black wire is the “hot” wire and that the white wire is the neutral wire. The supply connection made to “L1” on the disconnect switch **must be** the “hot” wire.

Each heat section in the heater has a terminal strip for 24-volt thermostat connections. The terminal strip is located on the outside of the cabinet at the front of each heat section (See FIGURE 1A or 1B in Paragraph 7). Wires from the terminal strip(s) are factory wired to the circuit board(s).

Use either an optional thermostat available with the heater or a field-supplied 24-volt thermostat. Install according to the thermostat manufacturer's instructions, paying particular attention to the requirements regarding the location of the thermostat.

Make sure that the heat anticipator setting on the thermostat is 0.6 amps (or in accordance with the amperage value noted on the wiring diagram of your heater).

Make thermostat connections at the terminal strip on the front of the heater. The strip has seven terminals, R, G, C, Y1, Y2, W1, and W2. Refer to the wiring diagram on the heater.

IMPORTANT: All heaters MUST be operated by a 24-volt thermostat. Never use a line voltage disconnect switch as a means of operating the heater. Operating by means other than a 24-volt thermostat may result in the high limit control tripping and may cause damage to the heater from excessive heat.

Connections for Reznor optional thermostats are shown in FIGURE 10 for LDAP 400; in FIGURE 11 for LDAP 800; and in FIGURE 12 for LDAP 1200.

- **Option CL1** - Single-Stage Thermostat, 40-80°F
- **Option CL2** - Single-Stage Thermostat with Fan Switch, 40-80°F
- **Option CL3** - Single-Stage Thermostat, 40-90°F
- **Option CL7** - Two-Stage Thermostat (for use with optional two-stage gas valve on Size 400 or for staging heat sections on Sizes 800 and 1200)
- **Option CL18** - Two-Stage Thermostat with Fan Switch (for use with optional two-stage gas valve on Size 400 or for staging heat sections on Sizes 800 and 1200)

FIGURE 10 - Thermostat Connections for Model LDAP 400 with Option CL1, CL2, CL3, CL7, or CL18

LDAP 400 THERMOSTAT WIRING

--- FIELD WIRING

NOTES:

- 1) Set the anticipator at 0.6 amps.
- 2) Set thermostat first stage anticipator at 0.6 amps and second stage anticipator at 0.2 amps.
- 3) Jumper thermostat terminals RH to RC.
- 4) Jumper thermostat terminals RH to RC and G to W1.
- 5) Set thermostat first stage anticipator at maximum amps and second stage anticipator at 0.6 amps.

LDAP 400 - Thermostat Option CL1, CL2, CL3, CL7 or CL18

WD# 189504 REV. #2

SINGLE STAGE HEATING

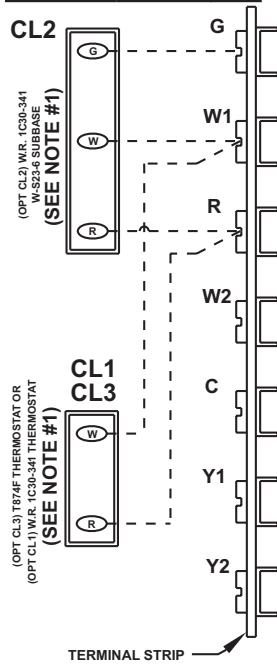

SINGLE STAGE HEATING WITH RECIRCULATION

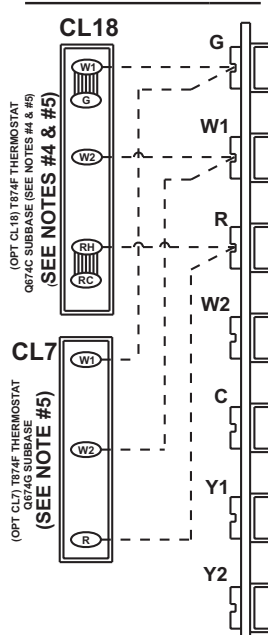

TWO STAGE HEATING

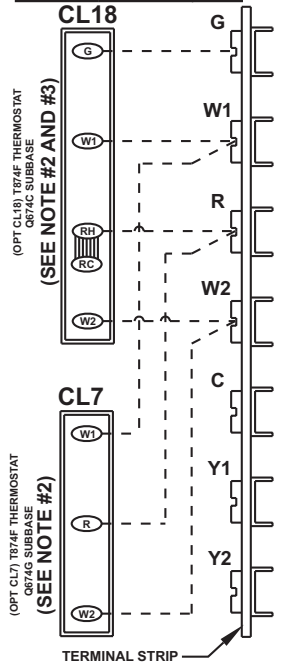

FIGURE 11 - Thermostat Connections for Model LDAP 800 with Option CL1, CL2, CL3, CL7, or CL18

LDAP 800 THERMOSTAT WIRING

--- FIELD WIRING

NOTES:

- 1) Set the anticipator at 0.6 amps.
- 2) Set thermostat first stage anticipator at 0.6 amps and second stage anticipator at 0.2 amps.
- 3) Jumper thermostat terminals RH to RC.
- 4) Jumper thermostat terminals RH to RC and G to W1.
- 5) Set thermostat first stage anticipator at maximum amps and second stage anticipator at 0.6 amps.

LDAP 800 - Thermostat Option CL1, CL2, CL3, CL7 or CL18

WD# 189505 REV. #2

SINGLE STAGE HEATING

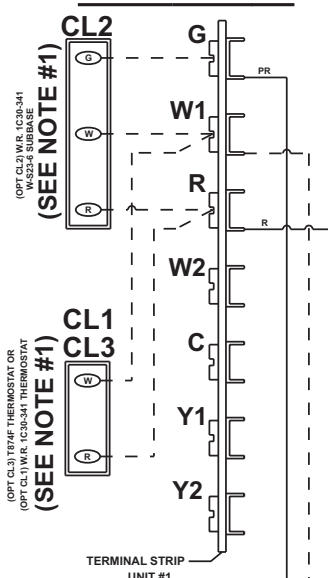

SINGLE STAGE HEATING WITH RECIRCULATION

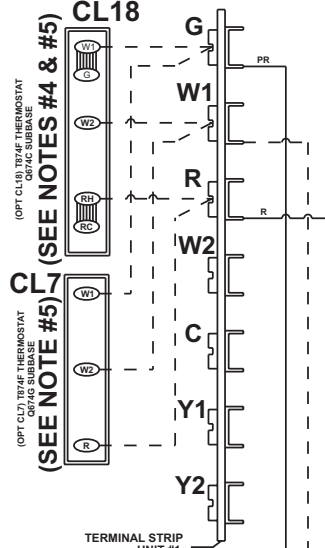

TWO STAGE HEATING

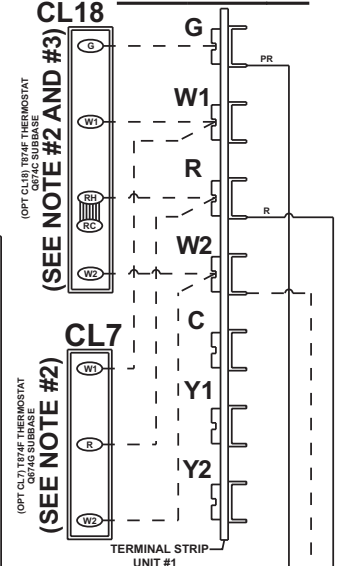

15. Thermostat and Connections (cont'd)

FIGURE 12 - Thermostat Connections for Model LDAP 1200 with Option CL1, CL2, CL3, CL7, or CL18

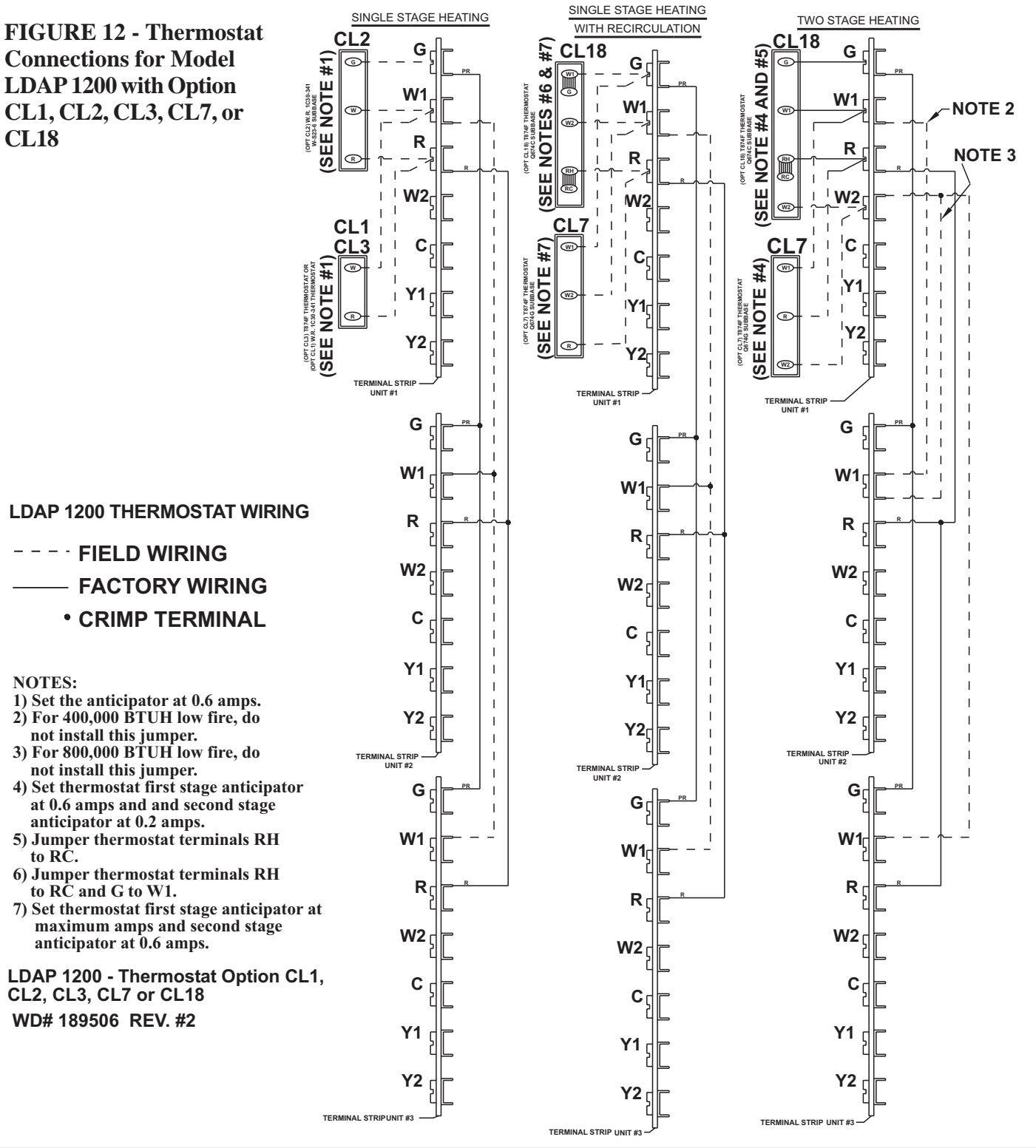

Multiple Heater Control - Option CL31 and Option CL32

If the heater was ordered with a multiple heater control option, one thermostat can be used to control multiple heaters. The option will control a maximum of six Size 400 heaters, a maximum of three Size 800 heaters, or a maximum of two Size 1200 heaters. The option includes a 40 VA transformer that replaces the standard transformer in the "master" heater and a relay assembly that attaches to the "slave" heater. Option CL31 provides for control of two heaters. If control of additional heaters is desired, Option CL32 which is the relay assembly only must be added to each of the "slave" heaters. The option packages are shipped separately and include complete instructions for installation and wiring.

16. Combustion Air Proving [Pressure Switch(es)]

NOTE: For high altitude, follow instructions in Paragraph 5 to change heat section pressure switch(es). The main combustion air pressure switch (Sizes 800 and 1200 only) does not need to be changed for a high altitude installation.

The combustion air proving switch is a pressure sensitive switch that monitors air pressure to ensure that proper combustion airflow is available. The switch is a single pole/normally open device which closes when a differential pressure is sensed between the venter housing and the flue collection box. Each section in the heater has a pressure switch. (For switch location, see **FIGURE 22**, page 33.) In addition, heaters with more than one heat section (Size 800 and Size 1200) have a main pressure switch which senses the negative pressure in the main venter housing.

On startup when the heater is cold, the sensing pressure is at the highest level, and as the heater and flue system warm up, the sensing pressure becomes less. After the system has reached equilibrium (about 20 minutes), the sensing pressure levels off.

If a restriction or excessive flue length or turns cause the sensing pressure to be outside the switch setpoint, the pressure switch will function to shutoff the burner. If the main combustion air pressure switch opens, it will interrupt the electric supply to all gas valves. If a heat section pressure switch opens, it will interrupt the electric supply to the gas valve in that heat section. The burner(s) will remain off until the system has cooled and/or the flue system resistance is reduced.

The Table below lists the approximate water column differential pressure settings of the heat section pressure switch(es) and the negative pressure readings of the main pressure switch.

Pressure Switch Settings

Sea Level Pressure Switch Settings (Applies to elevations up to 6000ft/1830M)													
Model LDAP	Main Pressure Switch						Heat Section Pressure Switch(es)						
	Start-up Cold	Equilibrium Hot	Setpoint OFF	Setpoint ON	Label Color	Switch Part No.	Qty	Start-up Cold	Equilibrium Hot	Setpoint OFF	Setpoint ON	Label Color	Switch Part No.
	Negative Pressure (in. w.c.)							Differential Pressure (in. w.c.)					
400							1	1.80 to 1.50	1.05 to 0.85	0.65	0.83	Yellow	197028
800	-1.30 to -1.00	-0.85 to -0.65	-0.15	-0.33	Gray	205445	2	1.90 to 1.60	1.10 to 0.90	0.65	0.83	Yellow	197028
1200	-1.40 to -0.90	-0.97 to -0.59	-0.15	-0.33	Gray	205445	3	2.40 to 1.90	1.55 to 1.00	0.65	0.83	Yellow	197028

High Altitude Pressure Switch Settings, Units Above 6000ft/1830M													
Model LDAP	Main Pressure Switch						Heat Section Pressure Switch(es)						
	Start-up Cold	Equilibrium Hot	Setpoint OFF	Setpoint ON	Label Color	Switch Part No.	Qty	Start-up Cold	Equilibrium Hot	Setpoint OFF	Setpoint ON	Label Color	Switch Part No.
	Negative Pressure (in. w.c.)							Differential Pressure (in. w.c.)					
400							1	1.75 to 1.45	1.00 to 0.80	0.60	0.78	Lt. Blue	197029
800	-1.25 to -0.95	-0.80 to -0.60	-0.15	-0.33	Gray	205445	2	1.85 to 1.55	1.05 to 0.85	0.60	0.78	Lt. Blue	197029
1200	-1.35 to -0.85	-0.92 to -0.54	-0.15	-0.33	Gray	205445	3	2.35 to 1.85	1.50 to 0.95	0.60	0.78	Lt. Blue	197029

DANGER: Safe operation of this heater requires proper venting flow. NEVER bypass combustion air proving switch(es) or attempt to operate the heater without the venter running and the proper flow in the vent system. Hazardous conditions could result. See Hazard Intensity Levels, page 2.

17. Limit Control

Each heat section is equipped with a temperature activated auto reset limit control. The control is factory set and is non-adjustable. If the setpoint is reached, the limit control will interrupt the electric supply to the gas valve in that heat section. This safety device provides protection in the case of motor failure or lack of airflow due to a restriction at the inlet or outlet. (For location, see **FIGURE 22**, page 33.)

CAUTION: The auto reset limit control will shut down the heater until the cause is corrected. Do not bypass the limit control; hazardous conditions could result. See Hazard Intensity Levels, page 2.

18. High Limit Control

Each heat section is equipped with a temperature activated, manually reset high limit control. The high limit control is located at the top of each heat section. It is factory set and is non-adjustable. If the setpoint is reached, the high limit control acts to interrupt the electric supply to the gas valve in that heat section. If the high limit control activates, identify and correct the cause before resetting the switch. Refer to

18. High Limit Control (cont'd)

the Maintenance Section for information on probable causes . (For location, see FIGURE 22, page 33.)

DANGER: If a manual reset high limit control activates, identify and correct the cause before resetting the switch. Never bypass the high limit control; hazardous conditions could result. See Hazard Intensity Levels, page 2.

19. Adjustable Air Destratification Fan Control

An adjustable fan control is located on top of the first heat section. It is adjacent to the circulating air fan and motor and controls the fan motors in all heat sections. The purpose of the fan control is to energize the fan motor(s) when the ambient air temperature around the heater reaches the setting on the control. The fan motor(s) will be de-energized when the fan control is satisfied. The fan(s) re-circulates the heated air near the ceiling down to the floor level (destratification) and improves heat recovery. A call for heat by the thermostat overrides the air destratification fan control.

Set the adjustable fan control for the desired temperature setting for energizing the circulating air fan(s). The fan control setting should be set 5 to 10°F higher than the wall-mounted thermostat setting. The heater is factory wired to energize the fan(s) at medium speed when energized by the adjustable fan control. For lower mounting heights it may be desirable to operate the fan(s) at low speed. Switching the blue (medium speed) and red (low speed) fan motor wires on each heat section will change the fan motor(s) speed. Refer to the wiring diagram for the wire locations.

To manually override the fan control, the heater may be tuned off at the circuit breaker in the main electrical panel, or a field-installed electrical box with a SPST switch can be located near the wall thermostat with the switch wired in series with the fan control.

The air destratification can also be a benefit in the summer time. Using the fan(s) in the summer time can improve working conditions by alleviating stagnant air conditions and creating a cooling effect for the occupants.

20. Ignition System

Each heat section in this heater is equipped with a direct spark integrated control module (circuit board). The module monitors the safety devices and controls the operation of the fan and venter motors and the gas valve between heat cycles.

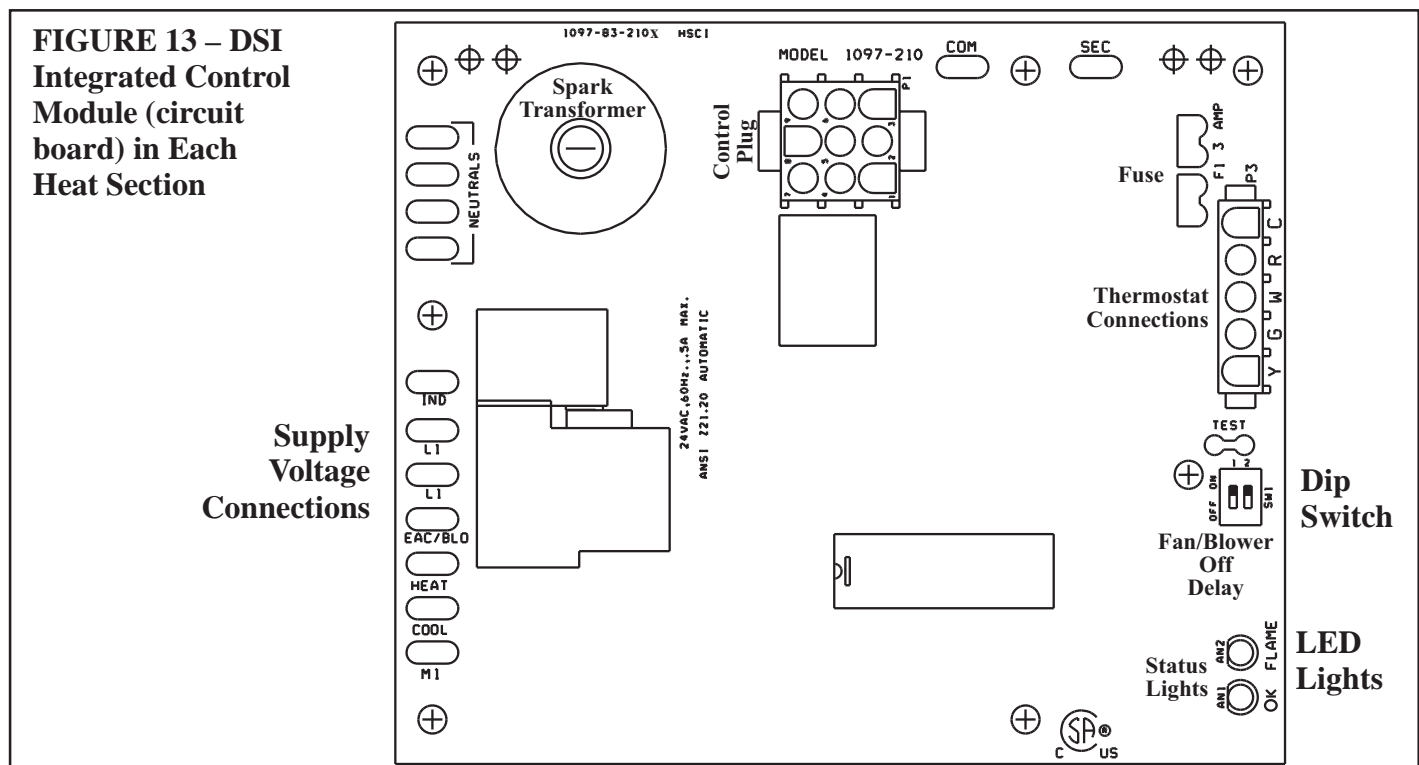

Normal Heat Cycle Operating Sequence

NOTE: All LED Flash Codes are on page 38.

1) Call for Heat - The thermostat calls for heat by energizing the “W” terminal. The control checks to see that the limit and high limit switches are closed and the heat section pressure switch is open and the main combustion air pressure switch (Sizes 800 and 1200) is open. If the limit or high limit switch is open, the control responds as defined in the “Abnormal Heat Cycle, Limit Switch Operation”. If the heat section pressure switch or main combustion air pressure switch are closed, the control will do four flashes on the green LED and wait indefinitely for the heat section pressure switch or main combustion air pressure switch to open. If the heat section pressure switch and main combustion air pressure switch are open, the control proceeds to prepurge.

2) Prepurge - The control energizes the heat section venter motor and main venter motor (Sizes 800 and 1200) and waits for the heat section pressure switch and main combustion air pressure switch to close. If the heat section pressure switch or main combustion air pressure switch does not close within 30 seconds of the heat section venter motor and main venter motor energizing, the control will do two flashes on the green LED. The control will leave the heat section venter motor and main venter motor energized indefinitely as long as the call for heat remains and the heat section pressure switch or main combustion air pressure switch is open.

When the heat section pressure switch and main combustion air pressure switch are proven closed, the control begins the prepurge time. If flame is present any time while in prepurge, the prepurge time is restarted. If flame is present long enough to cause lockout, the control responds as defined in “Fault Modes, Undesired Flame”.

The control runs the heat section venter motor and main venter motor for a 20 second prepurge time, then proceeds to the ignition trial period.

3) Ignition Trial Period - The control energizes the spark and main gas valve. The venter remains energized. If flame is sensed during the first 16 seconds, the spark is de-energized and the control proceeds to heat fan on delay. If flame has not been sensed during the first 16 seconds, the control de-energizes the spark output and keeps the gas valve energized for an additional one second flame proving period. If flame is not present after the flame proving period, the control de-energizes the gas valve and proceeds with ignition re-tries as specified in “Abnormal Heat Cycle, Ignition Re-try”. If flame is present, the control proceeds to the fan on delay.

4) Fan On Delay - The control waits for 30 seconds from the time the gas valve opened and then energizes the fan motor. The gas valve, heat section venter motor, and main venter motor remain energized. The control proceeds to steady heat mode.

5) Steady Heat - Control inputs are continuously monitored to ensure limit, high limit, heat section pressure switch, and main combustion air pressure switch are closed, flame is established, and the thermostat call for heat remains. When the thermostat call for heat is removed, the control de-energizes the gas valve and begins post-purge and fan off delay timing.

6) Post Purge - The heat section venter motor and main venter motor outputs remain on for a 45 second post-purge period after the thermostat is satisfied.

7) Fan Off Delay - The fan motor is de-energized after a fan off delay as selected by the dip switches. Timing begins when the thermostat is satisfied. Delay times are as in the table on the left. The factory default when shipped is 120 seconds.

Switch Setting Chart for Fan OFF Delay (See SW1 on W.D.)		
TIME	SW1	SW2
90 sec	OFF	ON
120 sec	OFF	OFF
160 sec	ON	OFF
45 sec	ON	ON

Abnormal Heat Cycle Functions

Interrupted Thermostat Call for Heat - If the thermostat demand for heat is removed before the flame is recognized, the control will run the heat section venter motor and main venter motor for the post purge period and de-energize all outputs.

If the thermostat demand for heat is removed after successful ignition, the control will de-energize the gas valve, run the heat section venter motor and main venter motor through post purge, and run the fan motor on heat speed for the selected delay off time.

Ignition Retry - If flame is not established on the first trial for ignition period, the control de-energizes the gas valve and the heat section venter motor and main venter motor

20. Ignition System (cont'd)

Abnormal Heat Cycle Functions (cont'd)

remain energized for an inter-purge period of 10 seconds. The spark and gas valve are then re-energized, and the control initiates another trial for ignition.

If flame is not established on the second trial for ignition, the control de-energizes the gas valve, energizes the fan motor on heat speed, and the heat section venter motor and main venter motor remain energized. The fan motor is shut off after the longest selectable fan delay time (160 seconds). When the fan motor de-energizes, the spark and gas valve are re-energized and the control initiates another trial for ignition. (This fan delay is a self-healing feature for an open auxiliary limit switch).

If flame is not established on the third trial for ignition period, the control de-energizes the gas valve, and the heat section venter motor and main venter motor remain energized for an inter-purge period of 10 seconds. The control then re-energizes the gas valve and spark and initiates another trial for ignition.

If flame is not established on the fourth trial for ignition (initial try plus 3 re-tries), the control de-energizes the gas valve and goes into lockout. The control goes to one flash on the green LED to indicate ignition failure lockout.

Limit and High Limit Switch Operation - The high limit and limit switch are ignored unless a call for heat is present (W energized). If the high limit or limit switch are open and a call for heat is present, the control de-energizes the gas valve and turns the fan motor on heat speed and runs the heat section venter motor and the main venter motor.

When the switch re-closes or the call for heat is lost, the control runs the heat section venter motor and main venter motor through post purge and runs the fan motor through the selected fan off delay. The control will return to normal operation after fan off delay is completed.

Heat Section Pressure Switch (all sizes) and Main Combustion Air Pressure Switch (Sizes 800 and 1200) - If the heat section pressure switch or main combustion air pressure switch opens before the trial for ignition period, the heat section venter motor and main venter motor will run through the heat section pressure switch and main combustion air pressure switch recognition delay (2 seconds), the gas valve will be de-energized, and the heat section venter motor and main venter motor will run through the postpurge time. The control will re-start the heat cycle at the heat section pressure switch and main combustion air pressure switch proving state if the call for heat still exists.

Heat section pressure switch or main combustion air pressure switch opening for less than 2 seconds during the trial for ignition period shall not interrupt the heat cycle. (Gas valve will de-energize while the heat section pressure switch and main combustion air pressure switch is open.)

If the heat section pressure switch or main combustion air pressure switch opens after a successful ignition, the control will de-energize the gas valve. If flame is lost before the end of the 2 second pressure switch recognition delay, the control will respond to the loss of flame. If the heat section pressure switch and main combustion air pressure switch remains open for 2 seconds and the flame remains, the control de-energizes the gas valve, the heat section venter motor and main venter motor runs through postpurge, and the fan motor runs on heat speed through the selected fan off delay. When the fan off delay is over, the fan motor is de-energized, and a heat cycle is begun if the call for heat still exists.

Continuous Fan Operation

When the thermostat calls for continuous fan (G) without a call for heat, the fan motor is energized after a .25 second delay. NOTE: This brief on delay is to allow the "G" terminal to energize slightly before "Y" and an external changeover relay to switch from "G" to "W" without causing momentary glitches in the fan motor output. The fan remains energized as long as the call for fan remains without a call for heat.

If a call for heat (W) occurs during continuous fan, the fan will de-energize.

A call for fan is ignored while in lockout.

Fault Modes

Undesired Flame - If flame is sensed longer than 20 seconds while the gas valve is de-energized, the control shall energize the heat section venter motor, the main venter motor, and the fan motor on heat speed. When flame is no longer sensed, the heat section venter motor and main venter motor will run through postpurge, and the fan motor will run through the selected heat fan off delay time. The control will do a soft lockout, but will still respond to open limit and flame. The FLAME (yellow) LED shall flash rapidly when lockout is due to undesired flame.

Gas Valve Relay Fault - If the control senses the gas valve as energized for more than one second when the control is not attempting to energize the gas valve, or the gas valve is sensed as not energized when it is supposed to be energized, then the control will lockout with the green LED off. The control assumes either the contacts of the relay driving the gas valve have welded shut, or the sensing circuit has failed. The heat section venter motor is forced off to open the heat section pressure switch to stop gas flow unless flame is present.

If the gas valve was sensed as closed when it should be open, and has not de-energized after the heat section venter motor and main venter motor was shutoff for 15 seconds, then the heat section venter motor and main venter motor are re-energized to vent the unburned gas.

Lockout

Soft Lockout - The control shall not initiate a call for heat or call for continuous fan while in lockout. The control will still respond to an open limit and undesired flame. Lockout shall automatically reset after one hour. Lockout may be manually reset by removing power from the control for more than one second or removing the thermostat call for heat for more than one and less than 20 seconds.

Hard Lockout (Green LED - steady off) - If the control detects a fault on the control board, the status LED will be de-energized, and the control will lockout as long as the fault remains. A hard lockout will automatically reset if the hardware fault clears.

Power Interruption - During a momentary power interruption or at voltage levels below the minimum operating voltage (line voltage or low voltage), the system will self-recover without lockout when voltage returns to the operating range.

Power interruptions of less than 80mS shall not cause the control to change operating states. Power interruptions greater than 80mS may cause the control to interrupt the current operating cycle and re-start. Power interruption during a heat cycle may trip the manual reset high limit switch.

21. Gas Valve(s)

- Size 400 has 1 valve.
- Size 800 has 2 valves.
- Size 1200 has 3 valves.

The main operating gas valve(s) is powered by the 24-volt control circuit through the thermostat and safety controls. The gas valve is of the diaphragm type providing regulated gas flow preset at the factory. (For location, see **FIGURE 22**, page 33.)

WARNING: The operating valve is the prime safety shutoff. All gas supply lines must be free of dirt or scale before connecting the heater to ensure positive closure. See Hazard Levels, page 2.

22 Fan Motor(s)

- Size 400 has 1 fan motor.
- Size 800 has 2 fan motors.
- Size 1200 has 3 fan motors.

Each heat section in the heater has a fan motor. Each fan motor(s) is equipped with thermal overload protection of the automatic reset type. Should the motor(s) refuse to run, it may be because of improper current characteristics. Make certain that the correct voltage is available at the motor(s).

Fan Motor Wiring

White = Neutral

Black = High (Heat Speed)

Blue = Medium (Destratification Speed, Factory Wired)

Red = Low (Optional Destratification Speed, Field Wired)

23. Wiring Diagrams

- Operating Sequence, Notes, Codes, Keys, etc. for ALL three typical wiring diagrams (FIGURES 14, 15, and 16 on pages 23, 24, and 25), pages 22-23.
- FIGURE 14 - Model LDAP 400, page 23.
- FIGURE 15 - Model LDAP 800, page 24.
- FIGURE 16 - Model LDAP 1200, page 25.

CAUTION: If any of the original wire as supplied with the appliance must be replaced, it must be replaced with wiring material having a temperature rating of at least 105°C, except for limit control, high limit control, and sensor lead wires which must be 150°C. See Hazard Levels, page 2.

Operating Sequence, Notes, Codes, Keys, etc for ALL three typical wiring diagrams (FIGURES 14, 15, and 16) on pages 23-25.

Operating Sequence

1. Set thermostat at lowest setting. With Opt CL2 or CL18, set fan switch at “AUTO” position.
2. Turn on the manual gas valve(s).
3. Turn on power to the heater.
4. Set thermostat at desired setting.
5. Thermostat calls for heat, energizing the venter motor(s).
6. Main combustion air pressure switch (Sizes 800 and 1200) and heat section pressure switch(es) close, firing heat section(s) (Unit fires at low fire when using two-stage thermostat).
7. Burner flame is sensed, and in 30 seconds the fan motor(s) is energized.
8. High stage of thermostat calls for heat, firing all heat sections at full rate (on heaters with a two-stage thermostat).
9. With Opt CL2 or CL18, set fan switch at “ON” position for continuous fan operation.
10. If the flame is extinguished during main burner operation, the integrated control system closes the main valve of that heat section and must be reset by interrupting power to the control circuit (see lighting instructions).

Wiring Diagram NOTES

1. The following controls are field-installed options: Thermostat
2. Dotted wiring installed by others.
3. **CAUTION:** If any of the original wiring as supplied with the appliance must be replaced, it must be replaced with wiring material having a temperature rating of at least 105°C, except for sensor lead wire and limit wiring which must be 150°C.
4. Use 18 gauge wire for all wiring on the heater.
5. Line and fan motor branch wire sizes should be of a size to prevent voltage drops beyond 5% of supply line voltage.
6. Size 400, see thermostat wiring diagram in **FIGURE 10**, page 15. Size 800, see thermostat wiring diagram in **FIGURE 11**, page 15. Size 1200, see thermostat wiring diagram in **FIGURE 12**, page 16.
7. The control transformer has a dual voltage primary.
For 230V heaters, the black lead goes to the “240” terminal. Cap the “208” terminal.
For 208V heaters, the black lead goes to the 208” terminal. Cap the “240” terminal.
8. When providing or replacing fuses in the fusible disconnect switch, use dual elements time delay fuses and size according to 1.25 times the maximum total input amps.
9. The line side of the lockable disconnect switch must be connected to the incoming power supply such that the voltage between Terminal L1 and Ground is the greater value.

Wiring Color Codes

Black	- BK
Brown	- BR
Red	- R
Orange	- O
Yellow	- Y
Green	- G
Blue	- BL
Purple	- PR
White	- W

Switch Setting Chart for Fan OFF Delay (See SW1 on W.D.)

TIME	SW1	SW2
90 sec	OFF	ON
120 sec	OFF	OFF
160 sec	ON	OFF
45 sec	ON	ON

Fan Motor Wiring

White = Neutral

Black = High (Heat Speed)

Blue = Medium (Destratification Speed, Factory Wired)

Red = Low (Optional Destratification Speed, Field Wired)

Key

	Terminal Block - Heat Section #1
	Terminal Block - Heat Section #2
	Terminal Block - Heat Section #3
	Factory Wiring
	Field Wiring

Field Control Wiring

Total Wire Length	Distance from Unit to Control	Minimum Recommended Wire Gauge
150 ft (46M)	75 ft (23M)	18 Gauge
250 ft (76M)	125 ft (38M)	16 Gauge
350 ft (107M)	175 ft (53M)	14 Gauge

FIGURE 14 – Typical Wiring Diagram for Model LDAP 400 (Reference W. D. 189374, Rev 2)

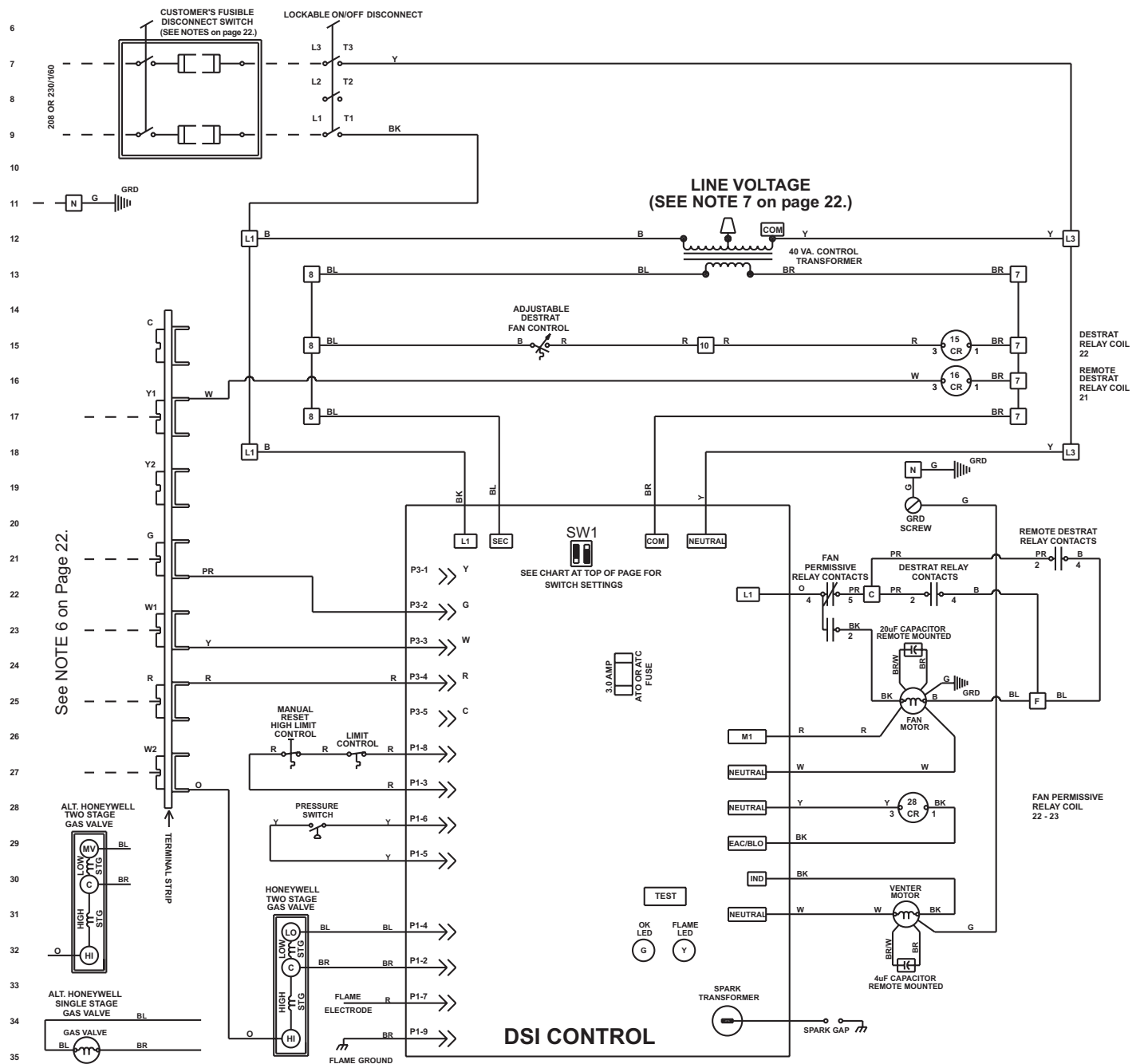

23. Wiring Diagrams (cont'd)

FIGURE 15 – Typical Wiring Diagram for Model LDAP 800 (Reference W.D. 189375, Rev 2)

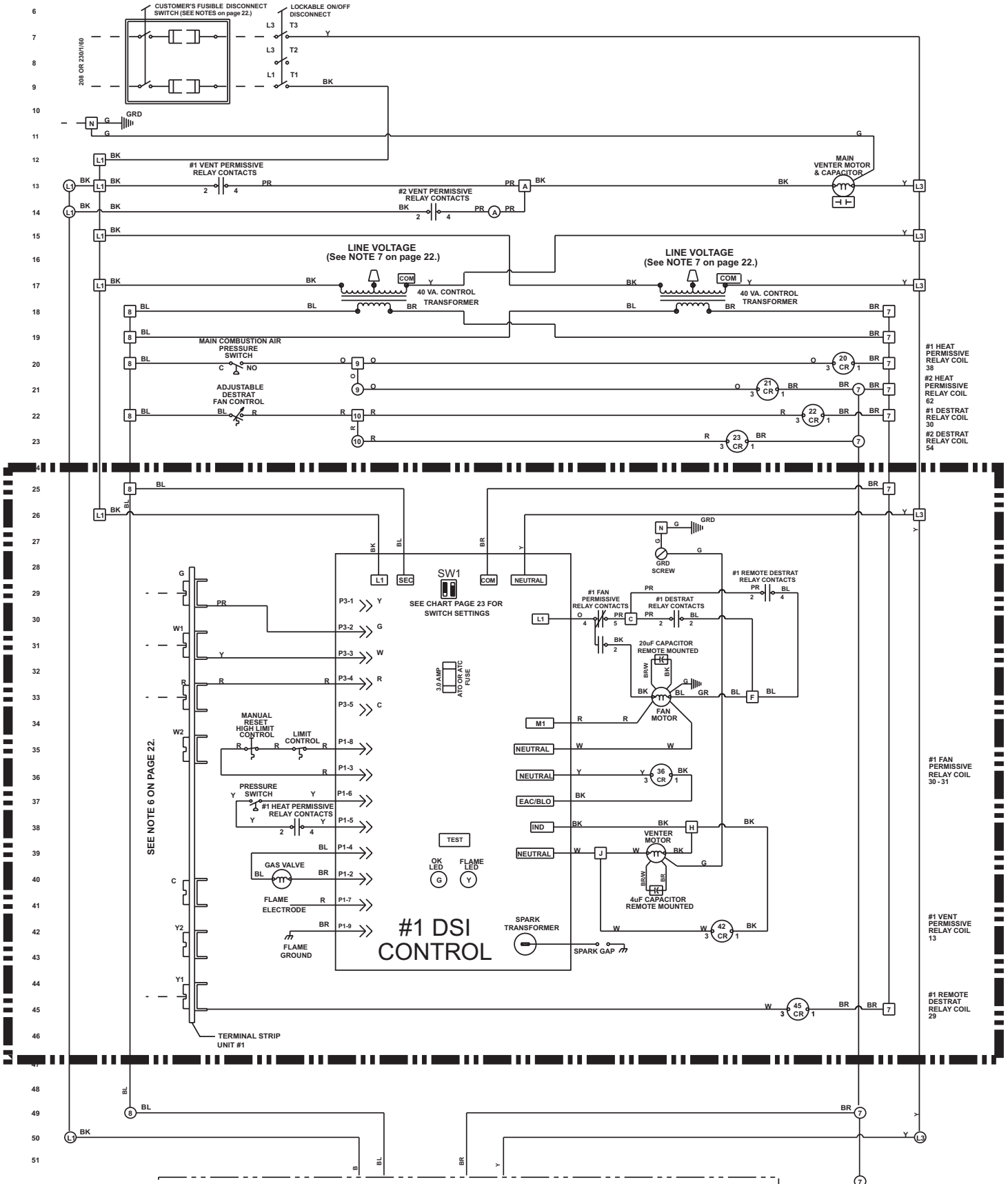
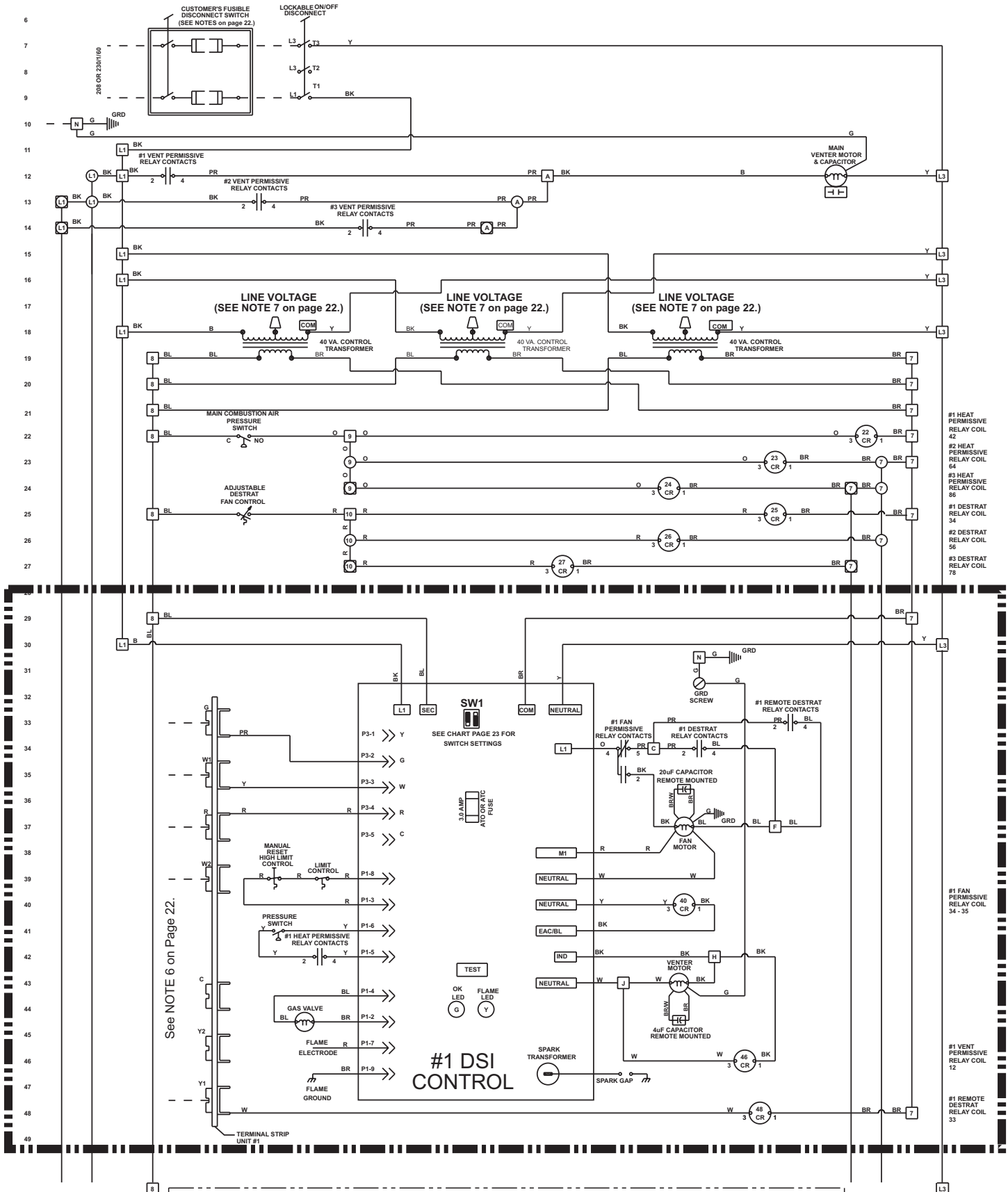

FIGURE 16 – Typical Wiring Diagram for Model LDAP 1200 (Reference W. D. 189376, Rev 2)



See Note 6 on Page 22.

The above control wiring is repeated in the second and third heat sections.

24. Venting

Model LDAP heaters are certified as Category III heaters.

WARNING: Each heater requires its own individual vent pipe run and vent cap. Manifolding of vent runs can cause recirculation of combustion products into the building. Failure to comply could result in severe personal injury or death and/or property damage.

Venting must be in accordance with local codes and the National Fuel Gas Code Z223.1 or CSA B149.1 and B149.2, Installation Code for Gas Burning Appliances and Equipment. Local requirements supersede national requirements.

These power-vented heaters are designed to operate safely and efficiently with either a horizontal or vertical vent. Comply with the specific requirements and instructions. If this heater is replacing an existing heater, be sure that the vent is sized properly for the heater being installed and that the existing vent is in good condition. A properly sized vent system is required for safe operation of the heater. An improperly sized vent system can cause unsafe conditions and/or create condensation. Do not vent into an existing gravity vent or chimney.

Installation should be done by a qualified agency in accordance with these instructions. The qualified service agency installing this system is responsible for the installation.

Venting Requirements

1) Type of Vent Pipe

The type of vent pipe is determined by whether the vent is horizontal or vertical.

Horizontal

- Vent pipe approved for a Category III appliance, **OR**
- Appropriately sealed 26-gauge or heavier galvanized steel or equivalent single-wall pipe

Vertical

- Vent pipe approved for a Category III appliance, **OR**
- Appropriately sealed 26-gauge or heavier galvanized steel or equivalent single-wall pipe

OR, if at least 75% of the equivalent length of the vent run is vertical

- Double-wall (Type B) vent pipe

2) Vent Pipe Diameter and Length

Vent pipe diameters and maximum vent lengths in the table apply to both **Horizontal and Vertical** vents. Add **all** straight sections and equivalent lengths for elbows. The total combined length must not exceed the **Maximum Vent Length**.

- Use only one diameter of vent pipe on an installation.
- Minimum vent length is 3 feet (1M).
- Minimum of 1 ft (0.3M) of vertical vent required on venter outlet before installing an elbow.

Model LDAP Size	Venter Outlet Diameter		Vent Pipe Diameter		Maximum Vent Length ¹		Equivalent Straight Length for 90° Elbow		Equivalent Straight Length for 45° Elbow		Field-Supplied Taper Type Connection Required at the Venter Outlet
	inches	mm	inches	mm	feet	M	feet	M	feet	M	
400	6	152	6	152	45	13.7	15	4.6	7.5	2.3	None
			7	178	60	18.3	8	2.4	4	1.2	6" to 7" (152 to 178mm) Increaser
800	8	203	8	203	50	15.2	15	4.6	7.5	2.3	None
			10	254	45	13.7	5	1.5	2.5	0.8	8" to 10" (203 to 254mm) Increaser
1200	8	203	8	203	50	15.2	15	4.6	7.5	2.3	None
			10	254	45	13.7	5	1.5	2.5	0.8	8" to 10" (203 to 254mm) Increaser

¹ Includes one 90° elbow at venter outlet.

3) Venter (Flue) Outlet

Venter Outlet Attachment Requirements:

Model LDAP Size	Venter Outlet Diameter	
	inches	mm
400	6	152
800	8	203
1200	8	203

Depending on the size of vent pipe as determined in Step No. 2, attach either the vent pipe directly to the venter collar or a taper-type enlarger.

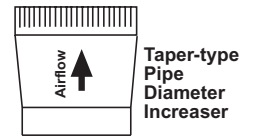

Follow instructions in Requirement No. 4. below to make the connection for the type of pipe being used.

4) Joints and Sealing

Provide field-supplied vent pipe as specified in Requirement No. 1.

- If using **single wall**, 26-gauge or heavier galvanized pipe, secure slip-fit connections using sheetmetal screws or rivets. Seal pipe joints either with tape suitable for 550°F (such as Option FA1, P/N 98266) or high-temperature silicone sealant.
- If using **Category III vent pipe**, follow pipe manufacturer's instructions for joining pipe sections. When attaching Category III pipe to the venter outlet or the vent cap, make secure, sealed joints following a procedure that best suits the style of Category III pipe being used.
- If installing a **double-wall (Type B) terminal pipe**, follow the instructions in **FIGURE 17C** to join the double-wall pipe to a single-wall or Category III vent pipe run. To attach the vent cap, follow instructions in **FIGURE 17B**.
- If using **double-wall (Type B) vent pipe** in the vent pipe run (at least 75% of the equivalent vent length must be vertical), follow the pipe manufacturer's instructions for joining pipe sections. For attaching double-wall pipe to the heater, see **FIGURE 17A**. To attach the vent cap, see **FIGURE 17B**.

FIGURE 17A - Attaching Double-Wall (Type-B) Vent Pipe to the Venter Outlet

A double-wall pipe run is allowed only if at least 75% of the vent length is vertical.

Figure 17A - STEP 1

Slide the double-wall pipe over the collar so that the collar is inside the inner pipe.



Double-Wall Pipe



Venter Collar

Figure 17A - STEP 2

To secure the connection, spaced equal distance around the pipe, drill and insert three 3/4" long sheetmetal screws through the pipe and into the collar. Do not over tighten the screws.



Fill inside the pipe, around the collar, with silicone sealant being sure there are no gaps.

FIGURE 17B - Attaching Double-Wall (Type B) Pipe to a Vent Cap

Figure 17B - STEP 1

Place a continual 3/8" bead of silicone sealant around the circumference of the vent cap collar. This will prevent any water inside the vent cap from running down the double-wall pipe.

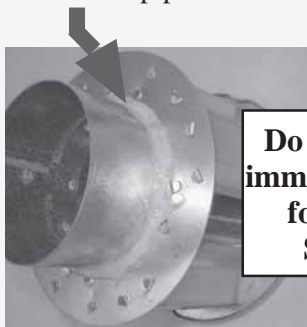

Do STEP 2 immediately following STEP 1.

Figure 17B - STEP 2

Insert the collar on the vent cap inside the inner wall of the double-wall pipe. Insert as far as possible. Add additional silicone sealant to fully close any gaps between the vent cap and the double-wall pipe. This is necessary to prevent water from entering the double-wall pipe.



Figure 17B - STEP 3

Secure the vent cap to the double-wall pipe by drilling and inserting a 3/4" long sheetmetal screw into the vent cap collar. Do not over tighten screw.



24. Venting (cont'd)

Venting Requirements (cont'd)

4) Joints and Sealing (cont'd)

FIGURE 17C - Attaching Double-Wall (Type B) Terminal Pipe to a Single Wall or Category III Vent Pipe Run

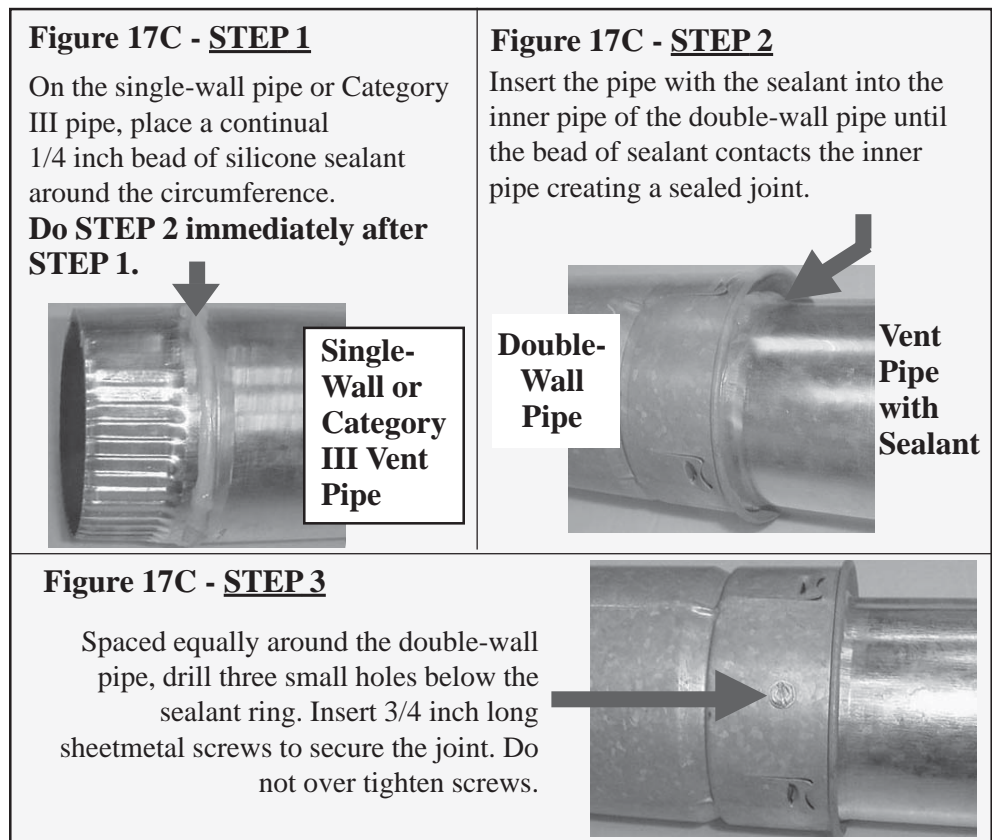

5) Vent System Support

6) Condensation

7) Vent Terminal (Pipe and Vent Cap)

Support horizontal vent runs every six feet (1.8M). Support vertical runs of Type "B" double-wall or Category III vent pipe in accordance with the requirements of the pipe manufacturer. Support single-wall pipe in accordance with accepted industry practices. Do not rely on the heater for support of either horizontal or vertical vent pipe. Use non-combustible supports on vent pipe.

Any length of single-wall vent pipe exposed to cold air or run through an unheated area or an area with an ambient temperature of 45°F or less must be insulated along its entire length with a minimum of 1/2" foil-faced fiberglass, 1-1/2# density insulation. Where extreme conditions are anticipated, install a means of condensate disposal.

The vent terminal pipe must be either Category III vent pipe or double-wall (Type B). Heaters must be equipped with a Reznor vent cap, a Type L Breidert Air-x-hauster® vent cap or equivalent. A different style vent cap could cause nuisance problems or unsafe conditions. The vent cap must be the same diameter as the vent pipe.

See the clearance table below and **FIGURE 18** for requirements of a horizontal vent terminal. See **FIGURE 19** for requirements of vertical vent termination.

Horizontal Vent Terminal Clearances

A vent cap is required. Maintain a minimum clearance of 12 inches (305mm) from the wall to the vent terminal cap for stability under wind conditions.

Products of combustion can cause discoloration of some building finishes and deterioration of masonry materials. Applying a clear silicone sealant that is normally used to protect concrete driveways can protect masonry materials. If discoloration is an esthetic problem, relocate the vent or install a vertical vent.

Structure	Minimum Clearances for Vent Termination Location (all directions unless specified)
Forced air inlet within 10 ft (3.1M)	3 ft (0.9M) above
Combustion air inlet of another appliance	6 ft (1.8M)
Door, window, or gravity air inlet (any building opening)	4 ft (1.2M) horizontally 4 ft (1.2M) below 1 ft (305mm) above
Electric meter, gas meter*, gas regulator*, and relief equipment	U.S. - 4 ft (1.2M) horizontally Canada - 6 ft (1.8M) horizontally)
Gas regulator *	U.S. - 3 ft (0.9M); Canada - 6 ft (1.8M)
Adjoining building or parapet	6 ft (1.8M)
Adjacent public walkways	7 ft (2.1M) above
Grade (ground level)	1 ft (305mm) above**
*Do not terminate the vent directly above a gas meter or service regulator. ** Consider local snow depth conditions. The vent must be at least 6" (152mm) higher than anticipated snow depth.	

FIGURE 18 - Horizontal Vent Terminal

NOTE: Read all measurements; drawing is not proportional.

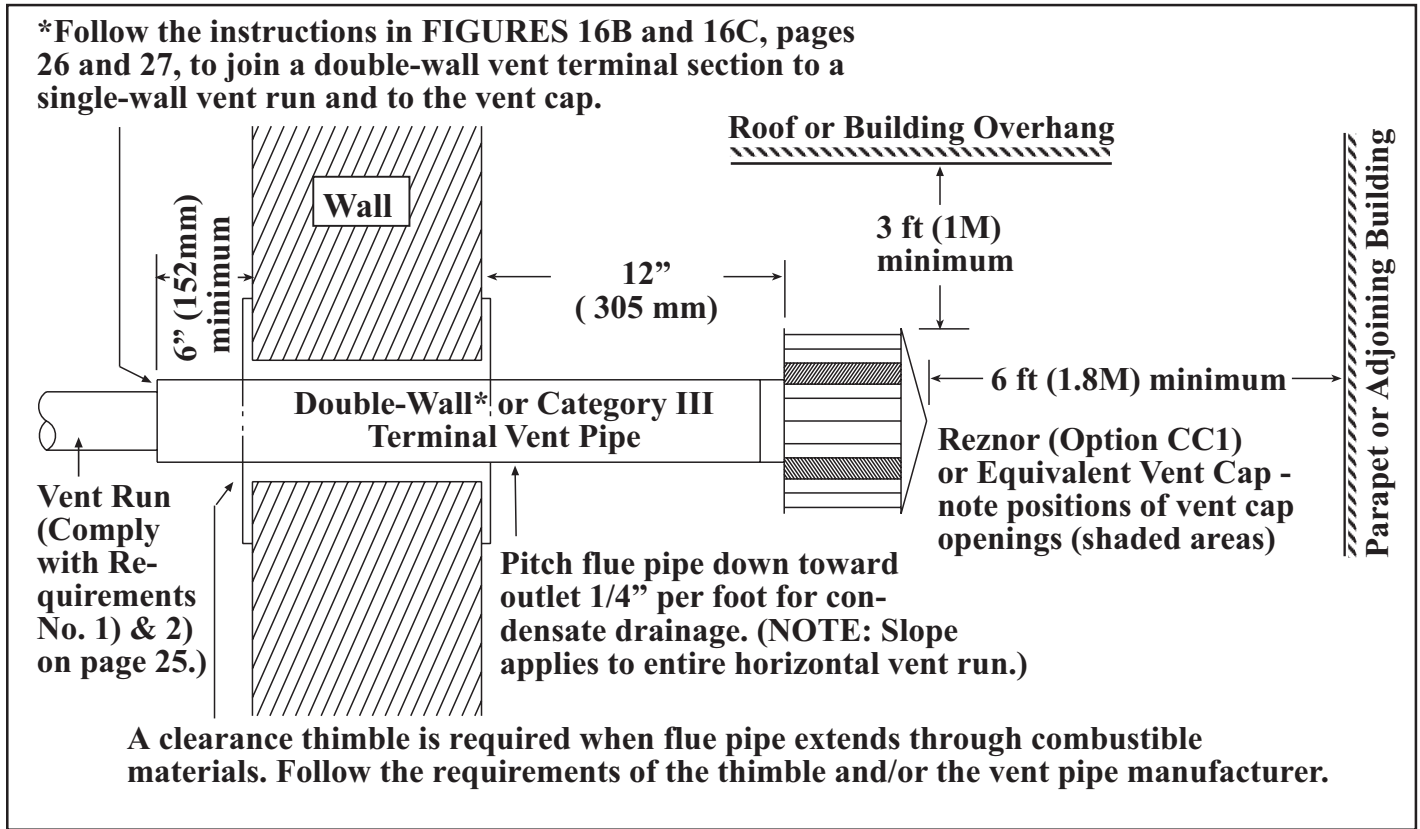
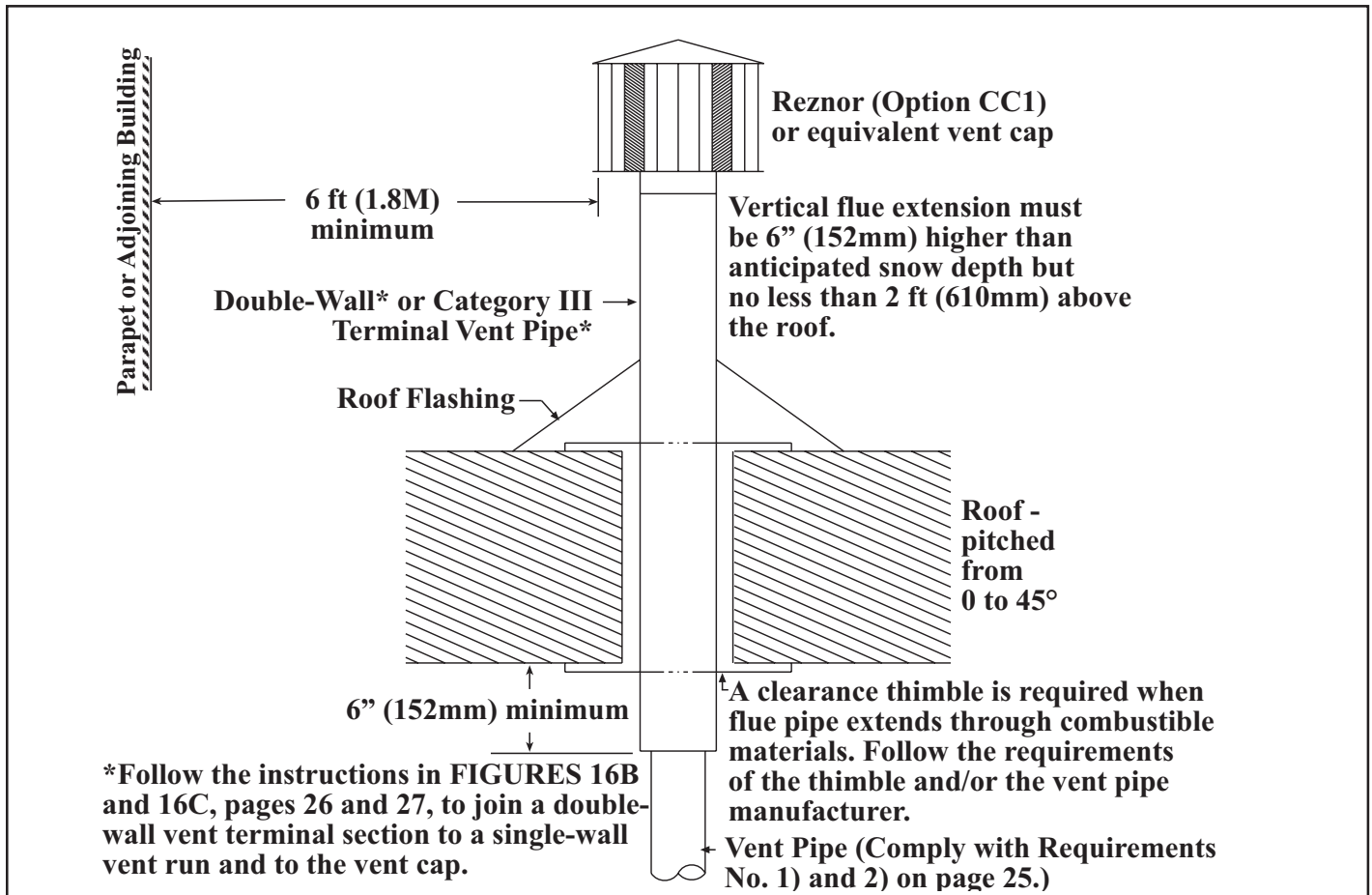

FIGURE 19 - Vertical Vent Terminal

NOTE: Read all measurements; drawing is not proportional.



25. Check Installation and Startup

Check the installation prior to startup:

Heater Startup and Warnings:

- Check to be sure that all screws used to hold shipping brackets were re-installed in the heater cabinet.
- Check suspension. Heater must be secure and level.
- Check clearances from combustibles. Requirements are in Paragraph 8.
- Check vent system to be sure that it is installed according to the instructions in Paragraph 24.
- Check piping for leaks and proper gas line pressure. Bleed gas lines of trapped air. See Paragraph 12.
- Check electrical wiring. Be sure all wire gauges are as recommended. Verify that fusing or circuit breakers are adequate for the load use.
- Check polarity. Verify that line voltage exists between the black "L1" and earth ground.
- If installed in California, verify that California Warning Label is displayed

WARNINGS: For your safety, read before operating. If you do not follow these instructions exactly, a fire or explosion may result causing property damage, personal injury, or loss of life.

- **This appliance does not have a pilot. It is equipped with an ignition device which automatically lights the burner(s). Do not try to light the burner(s) by hand.**
- **Before operating, smell all around the appliance area for gas. Be sure to smell next to the floor because some gas is heavier than air and will settle on the floor.**

WHAT TO DO IF YOU SMELL GAS

- **Open windows.**
 - **Don't touch electrical switches.**
 - **Extinguish any open flame.**
 - **Immediately call your gas supplier.**
- **Use only your hand to turn the gas control ON/OFF knob on the gas valve. Never use tools. If the valve ON/OFF knob will not turn by hand, do not try to repair it. Call a qualified service technician. Force or attempted repair may result in a fire or explosion.**
 - **Should overheating occur, or the gas supply fail to shut off, turn off the manual gas valve to the appliance before shutting off the electrical supply.**
 - **Do not use this appliance if any part has been under water. Immediately call a qualified service technician to inspect the appliance and to replace any part of the control system and any gas control which has been under water.**

Operating Instructions and Operating Sequence

-
1. Set thermostat at lowest setting.
 2. Turn off all electric power to the appliance.
 3. This appliance is equipped with an ignition device which automatically lights the burner. Do not try to light the burner by hand. Open the access door(s) and locate the gas control (ON/OFF) knob on the gas valve(s). (See **FIGURE 20**.)
 4. Turn each gas control knob(s) clockwise to "OFF".
 5. Wait five (5) minutes to clear out any gas. Then smell for gas, including near the floor. **If you smell gas, STOP!** and follow the steps in the **WARNINGS** printed above or on the Operating Label on the heater. If you do not smell gas, proceed to the next step.
 6. Turn the gas control knob(s) counterclockwise to "ON".
 7. Close the access door(s).
 8. Turn on the electric power to the heater.
 9. Set the thermostat to the desired setting.

FIGURE 20 - Gas Valve ON/OFF Control Knob

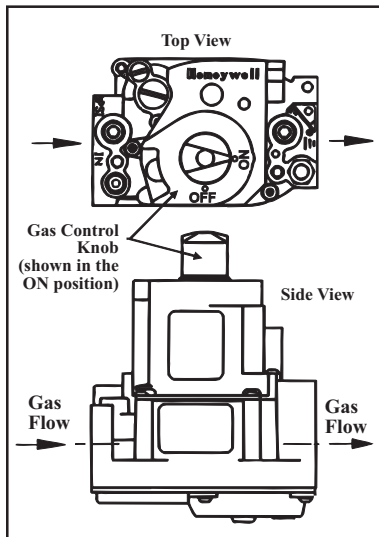

Check installation after startup:

- Place the "Owner's Envelope" containing the Limited Warranty, this booklet, and any control or optional information in an accessible location near the heater. Follow the instructions on the envelope.

NOTE: If the appliance does not operate, follow the instructions "To Turn Off Gas to Appliance" printed below (and on the Operating Label on the heater) and call your service technician.

10. Thermostat calls for heat, energizing the venter motor(s).
11. The main combustion air pressure switch (Sizes 800 and 1200) and each heat section pressure switch close, firing the heater.
12. Burner flame is sensed and in 30 seconds after the gas valve is energized, the fan motor(s) is energized.
13. If the flame is extinguished during the main burner operation, the integrated control system closes the main valve and must be reset by interrupting power to the control circuit. (See lighting instructions on the heater.)

TO TURN OFF GAS TO THE APPLIANCE

- 1) Set thermostat to lowest setting
- 2) If service is to be performed, turn off all electric power to the appliance.
- 3) Open the access door(s).
- 4) Turn the gas control knob(s) clockwise to "OFF". Do not force.
- 5) Close the access door(s).

Vent System Testing Procedure

1. Seal any unused openings in the venting system.
 2. Inspect the venting system for proper size and horizontal pitch, as required in the National Fuel Gas Code, ANSI Z223.1 or CSA B149.1 and B149.2, Installation Code for Gas Burning Appliances and Equipment, and this manual. Determine that there is no blockage or restriction, leakage, corrosion or other deficiencies that could cause an unsafe condition.
 3. In so far as practical, close all building doors and windows and all doors between the space where the heater is and other spaces of the building. Turn on exhaust fans so they shall operate at maximum speed. Do not operate a summer exhaust fan.
 4. Light the heater following the lighting instructions. Adjust the thermostat for continued operation. Verify that combustion products are venting properly. After determining that the heater vents properly, return doors, windows, and exhaust fans to their previous conditions. If improper venting is observed, the venting system must be corrected.
- With the heater in operation, measure valve outlet gas pressure. If operated at high altitude, adjust outlet gas pressure for altitude. See information and instructions in Paragraph 12.
 - Using the thermostat, turn the heater off and on, pausing two minutes between each cycle. Observe for smooth ignition.

DANGER: The gas burner in this gas-fired equipment is designed and equipped to provide safe controlled complete combustion. However, if the installation does not permit the burner to receive the proper supply of combustion air, complete combustion may not occur. The result is incomplete combustion which produces carbon monoxide, a poisonous gas that can cause death. Safe operation of indirect-fired gas burning equipment requires a properly operating vent system that vents all flue products to the outside atmosphere. FAILURE TO PROVIDE PROPER VENTING WILL RESULT IN A HEALTH HAZARD WHICH COULD CAUSE SERIOUS PERSONAL INJURY OR DEATH.

Always comply with the combustion air requirements in the installation codes and in Paragraph 9. Combustion air at the burner should be regulated only by manufacturer-provided equipment. NEVER RESTRICT OR OTHERWISE ALTER THE SUPPLY OF COMBUSTION AIR TO ANY HEATER. Heaters installed in a confined space must be supplied with air for combustion as required by Code and in Paragraph 9 of this heater installation manual. MAINTAIN THE VENT SYSTEM IN STRUCTURALLY SOUND AND PROPER OPERATING CONDITION.

OPTIONAL ACCESSORIES

26. 4-Way Discharge Louvers, Option CD32

27. Nozzles

FIGURE 21A - One heat section with Option CD58, 60° Nozzle



All Model LDAP heaters have discharge louvers but are available with additional louvers and/or nozzle discharge air options. Optional louver and discharge nozzles are shipped separately for field installation. Model LDAP 800 and 1200 heat sections have independent airflow and do not require the same discharge options. Each package includes illustrated installation instructions.

Option CD32 consists of additional louvers that are installed perpendicular to the standard individually adjustable louvers. By installing the optional perpendicular louvers, the two sets of louvers can be adjusted to direct airflow in any of the four directions, enabling the installer to select and increase or decrease the coverage area.

Option CD57 is a 30° discharge nozzle. **Option CD58** is a 60° discharge nozzle. **Option CD59** is a 30° discharge nozzle with 4-way louvers. A nozzle may be installed at each discharge air opening in any direction. **NOTE:** Do not install 4-way louvers with a 60° nozzle.

Nozzles should be attached after the unit is suspended. Follow the installation instructions in the nozzle package.

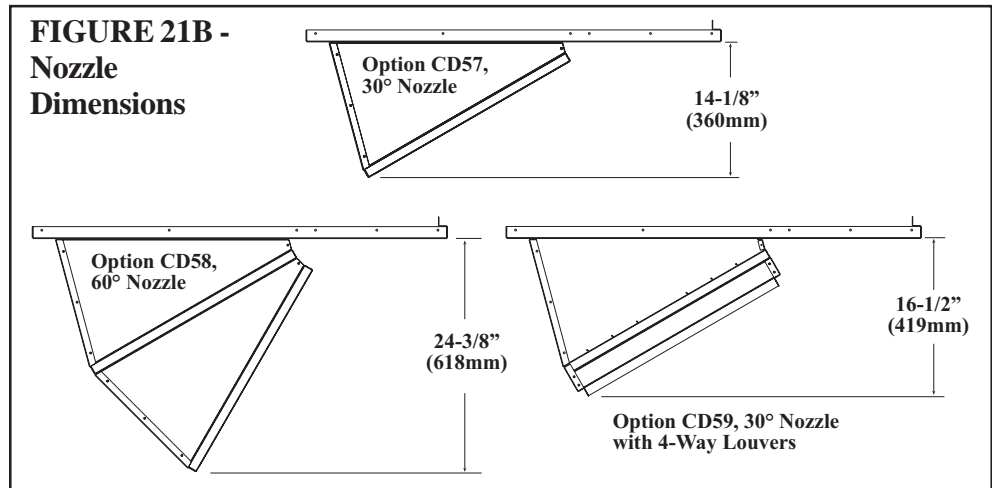

MAINTENANCE AND SERVICE

WARNING: If you turn off the power supply, turn off the gas. See Hazard Levels, page 2.

28. Maintenance Schedule

NOTE: If replacement parts are required, use only factory-authorized parts.

The material contained in the MAINTENANCE AND SERVICE Section of this manual is designed to aid a qualified service person in maintaining and servicing this equipment. This heater will operate with a minimum of maintenance. To ensure long life and satisfactory performance, a heater that is operated under normal conditions should be inspected and cleaned at the start of each heating season. If the heater is operating in an area where an unusual amount of dust or soot or other impurities are present in the air, more frequent maintenance is recommended.

When any service is completed, be careful to reassemble correctly to ensure that no unsafe conditions are created. When re-lighting, always follow the lighting instructions on the heater.

Maintenance Schedule - The following procedures should be carried out at least annually. Refer to illustrations and follow the instructions in Paragraphs 29-42.

- Clean all dirt, lint, and grease from all combustion air openings and the venter assemblies.
- Clean all dirt, lint, and grease from all fan blades, fan guards, and motors.
- Check all heat exchangers both internally and externally.
- Check all burners for scale, dust, or lint accumulation. Clean if needed.
- Check gas valve(s) to ensure that gas flow is being shutoff completely.
- Check the vent system for soundness. Clean openings. Replace any parts that do not appear sound.

- Check the wiring for any damaged wire. Replace damaged wiring. (See Paragraph 14 for replacement wiring requirements.)

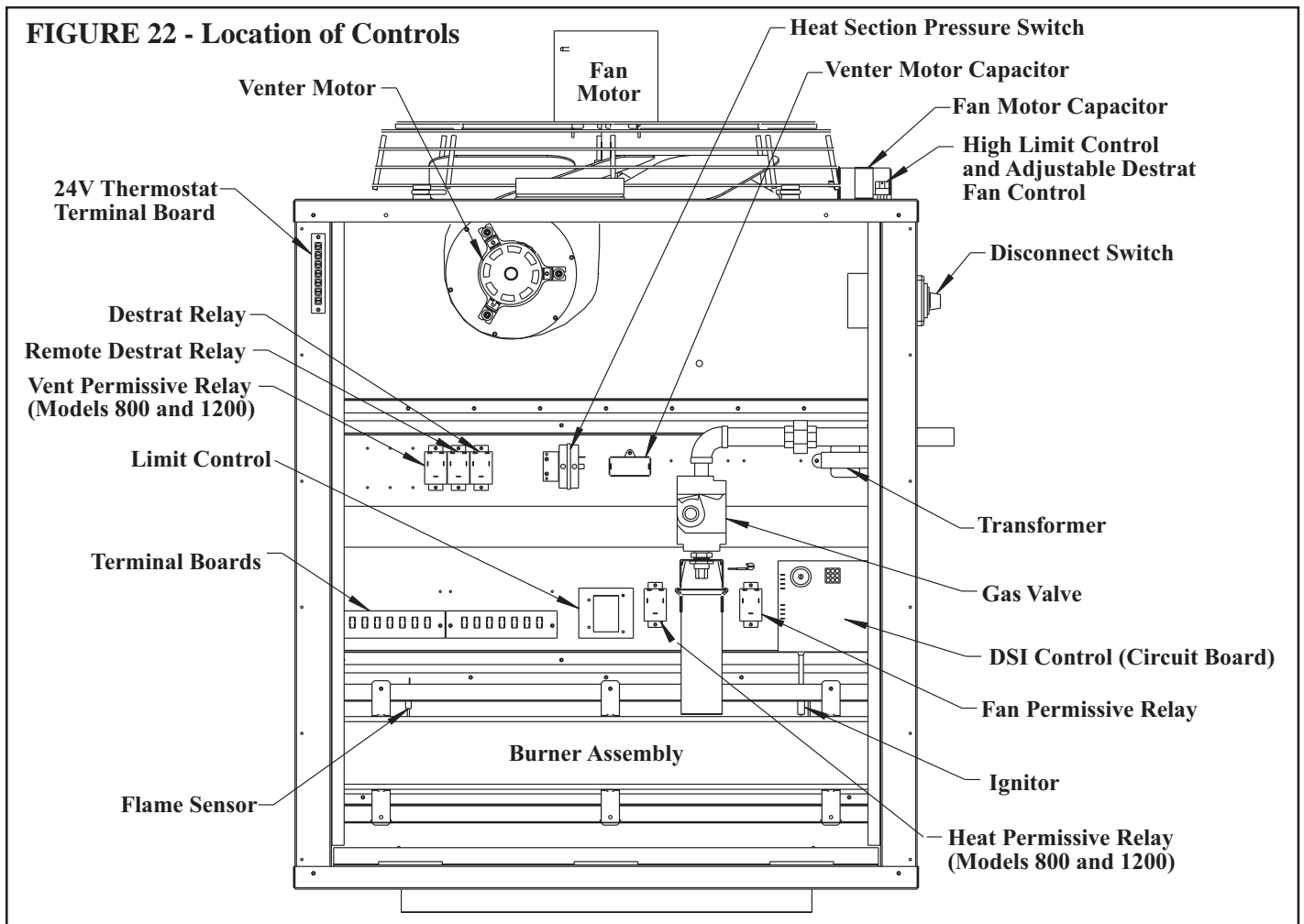

29. Heat Exchanger Maintenance

Each section of this heater is equipped with a T_{CORE}²® heat exchanger (U.S. Patent No. 6,889,686). Size 400 has one; Size 800 has two; and Size 1200 has three. Remove any external dirt or dust accumulation. Visually check each heat exchanger for cracks and holes. If a crack or hole is observed, replace the heat exchanger.

NOTE: Inspection of the lower portion of the heat exchanger is done with the burner removed. See the Burner Service section below for information on inspecting the lower portion of the heat exchanger.

30. Burner Maintenance

Each section of this heater is equipped with a T_{CORE}²® burner (U.S. Patent No. 6,889,686). Size 400 has one; Size 800 has two; and Size 1200 has three.

Inspect each burner/control compartment annually to determine if cleaning is necessary. If there is an accumulation of dirt, dust, and/or lint, clean the compartment and follow the instructions below to remove and clean the burner.

Burner Removal Instructions (Refer to FIGURE 23.)

1. Outside the cabinet, shut the gas supply off at the manual valve ahead of the union.
2. Turn off electric supply.
3. Disconnect the gas supply at the union outside of the cabinet.
4. Remove the access panel.
5. **Disconnect the Gas Train and Move It Out of the Way** - At the gas valve, mark and disconnect the wires. Disconnect the union on one or both sides of the gas line inside of the heater. Carefully remove the burner orifice and orifice adapter locking nut. Slide the orifice adapter out through the bracket on the burner.

CAUTION: Use of eye protection is recommended.

30. Burner Maintenance (cont'd)

Burner Removal Instructions (cont'd)

6. Remove Burner Assembly

- Locate the three upper burner body supports. At each support, remove the one screw that attaches it to the burner shield.
- Holding the venturi tube, slide the entire burner assembly slightly upward to disengage the burner from the supports on the bottom. Then rotate the open end of the venturi tube outward toward the access door opening. Carefully pull the burner assembly out of the cabinet.

FIGURE 23 - Burner Removal

- Size 400 has 1 burner.
- Size 800 has 2 burners.
- Size 1200 has 3 burners.

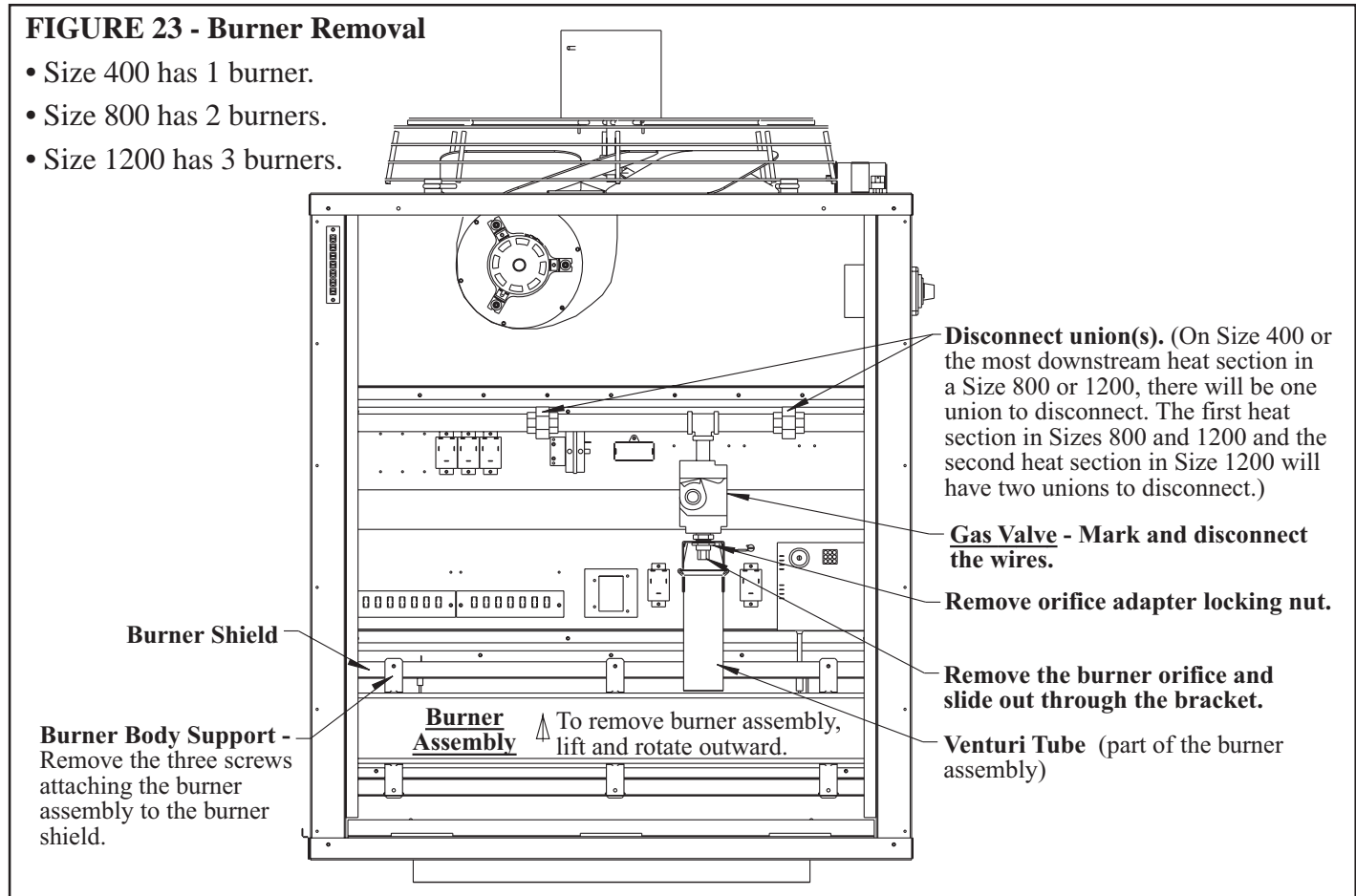

Inspect and Clean the Burner

NOTE: If any of the burner components are damaged or deteriorated, replace the burner assembly.

With the burner assembly removed, shine a flashlight on the burner ribbons. Look for carbon buildup, scale, dust, lint, and/or anything that might restrict flow through the spaces between the burner ribbons. Holding the burner assembly so that any foreign material will fall away from the burner, use a stiff bristle brush to loosen and remove any foreign material(s). If the burner is excessively dirty, remove one of the burner end caps. Remove the four screws that hold the end cap to the burner housing. Lightly tap the end cap to remove it.

Clean all foreign material from the burner and venturi. After the burner is thoroughly clean, replace the end cap making certain that it is tight against the burner housing.

At the burner flame entrance of each tube, shine a bright light into each heat exchanger section. With the light shining into the heat exchanger, observe the outside for visible light. Repeat this procedure with each heat exchanger section. If any light is observed, replace the heat exchanger.

Inspect the Lower Portion of the Heat Exchanger (with burner assembly removed)

Re-Install the Burner

Instructions to Re-Install the Burner (Refer to FIGURE 23.)

- Attach the Burner Assembly** - Holding the venturi tube, slide the entire burner assembly into position. Align the supports on the bottom with the slots in the burner shield; sliding the supports into the slots. On the top, re-attach each burner body support to the burner shield.

2. **Attach the Gas Train** - Slide the gas train so that the orifice adapter is through the bracket. Fasten the gas train to the bracket with the locking nut. Install the gas orifice. Re-connect the wires to the gas valve. Re-connect the union(s) inside of the control compartment.
3. Reconnect the gas supply at the union outside of the cabinet. Turn on the gas supply and leak test the connections with leak detecting solution.
4. Close the access panel.
5. Turn on the electric. Check for proper operation.

31. Burner Orifice(s)

A burner orifice usually only needs to be replaced when installing a gas conversion kit. If ordering replacement orifice(s) only, give BTUH content and specific gravity of gas, as well as the model and serial number of the heater. When removing or replacing a burner orifice, use two wrenches being careful not to damage the venturi tube and/or the bracket.

32. Ignition System

DSI Integrated Control Module (circuit board) - See **FIGURE 24**. The module monitors the operation of the heater including ignition. The only replaceable component is the 3 amp Type ATC or ATO fuse. If the fuse is blown, the problem is most likely an external overload. Correct the problem and replace the fuse.

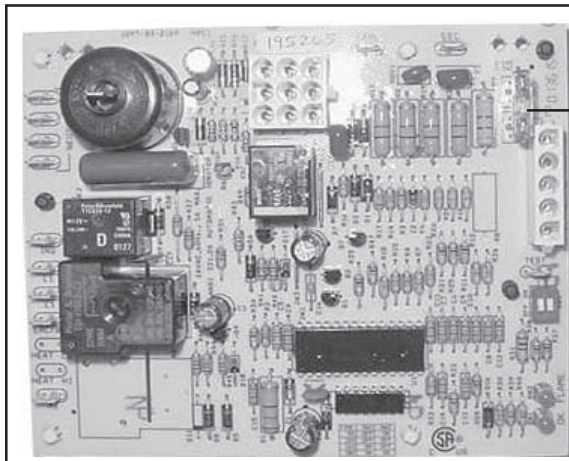

FIGURE 24 - DSI Integrated Control Module (Circuit Board)

Only replaceable part is a Type ATC or ATO 3 amp fuse (Color Code Violet), P/N 201685

Do not attempt to disassemble the control module. However, each heating season check the lead wires for insulation deterioration and good connections. Size 400 has one control module; Size 800 has two control modules; and Size 1200 has three control modules.

Proper operation of the direct spark ignition system requires a minimum flame signal of 1.0 microamps as measured by a microammeter. For further information and check out procedure on the direct spark ignition system, refer to Paragraph 19 and the Troubleshooting Flow Chart in Paragraph 43.

CAUTION: Due to high voltage on the spark wire and electrode, do not touch when energized. See Hazard Levels, page 2.

Ignitor - Refer to **FIGURE 22** and locate the ignitor. Disconnect the wire; remove the screw and the ignitor. Clean the ignitor assembly with an emery cloth. Spark gap must be maintained to 1/8". See **FIGURE 25**.

FIGURE 25 - Ignitor showing required Spark Gap measurement

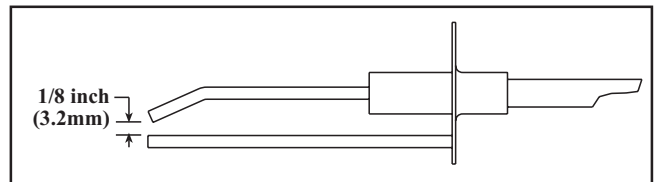

IMPORTANT: When re-assembling, the brown ground wire must remain attached to the ignitor.

CAUTION: Due to high voltage on the spark wire and electrode, do not touch when energized. See Hazard Levels, page 2.

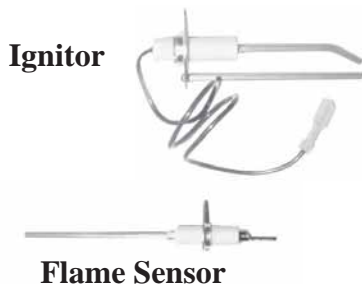

Flame Sensor

Flame Sensor - Refer to **FIGURE 22** and locate the flame sensor. Disconnect the wire; remove the screw and the flame sensor. Clean with an emery cloth.

33. Heat Section Venter Motor and Wheel

Remove dirt and grease from the motor casing, the venter housing, and the venter wheel. Venter motor bearings are permanently lubricated. Follow these instructions for replacement of the venter motor and wheel assembly. Keep all hardware removed to be used in re-assembling and installing the replacement parts.

33. Heat Section Venter Motor and Wheel (cont'd)

FIGURE 26 - Venter Wheel Position on Shaft - applies to all heat section venter assemblies

Replacement Instructions

1. Turn off the gas and disconnect the electric power.
2. Open the burner/control compartment access panel.
3. Disconnect the three venter motor wires at the DSI control, capacitor wires at the capacitor, and ground screw (located on the control panel).
4. Holding the venter motor, remove the six screws that attach the venter motor mounting plate to the venter housing. Remove the motor and wheel assembly from the heater.
5. Re-assemble with the replacement venter motor and wheel assembly. See **FIGURE 26**.
6. Follow the wiring diagram to connect the venter wires.
7. Replace the access panel. Restore power to the heater and turn on the gas. Light, following the instructions on the lighting instruction plate. Check for proper operation.

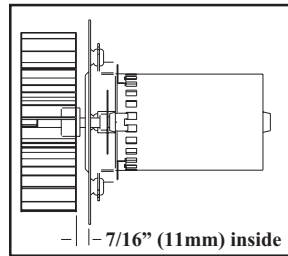

34. Main Venter Motor and Wheel (Models 800 and 1200 only)

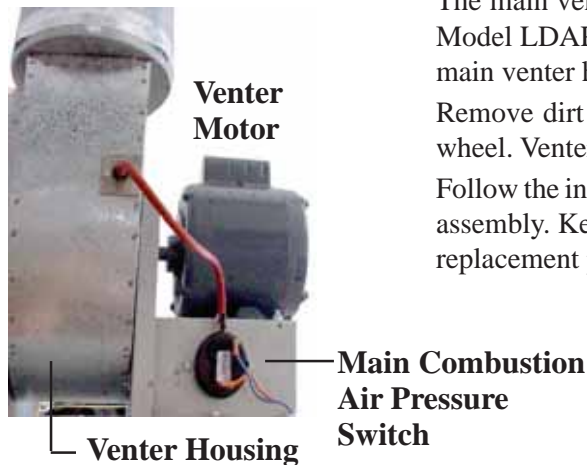

The main venter motor and wheel is located on the top of the first heat section of a Model LDAP 800 and 1200. The vent system attaches to the collar on the top of the main venter housing.

Remove dirt and grease from the motor casing, the venter housing, and the venter wheel. Venter motor bearings are permanently lubricated.

Follow the instructions in Paragraph 33 for replacement of the venter motor and wheel assembly. Keep all hardware removed to be used in re-assembling and installing the replacement parts. See **FIGURE 27** for venter wheel and motor spacing.

FIGURE 27- Venter Motor and Wheel Spacing on Main Venter (Size 800 and 1200)

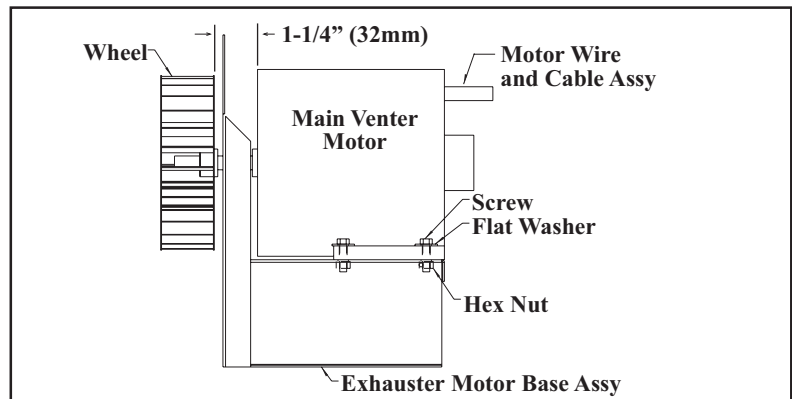

35. Fan Motor(s), Fan Blades, and Guard(s)

FIGURE 28- Fan Blade Position on the Shaft

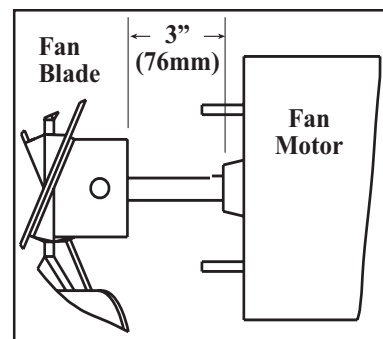

Remove dirt and grease from each motor, fan guard, and blades. Use care when cleaning the fan blades to prevent causing misalignment or imbalance. Check that the hub of the fan blades is secure to the shaft.

Follow these instructions for replacement of the fan guard, fan motor and/or fan blades. Repeat the procedure for each heater section.

1. If the heater is installed, turn off the gas and disconnect the electric power.
2. Open the access door and disconnect the fan motor wires, capacitor wires at the capacitor, and ground screw.
3. Remove the assembled parts (the fan guard, the motor and the fan blade).
4. Disassemble and replace whatever parts are needed and reassemble using whatever part(s) are being replaced and the original parts.

Be sure the fan blade is in the proper position on the shaft; refer to the illustration in **FIGURE 28**.

Position the assembly on the heater. Attach the fan guard.

Rotate the fan blade to check for adequate clearance. If adjustment is required, loosen the mounting screws, re-position the fan guard, and tighten the screws.

Rotate the fan blade and re-check for adequate clearance. Repeat this procedure until the assembly is positioned properly.

5. Reconnect the fan motor wires according to the wiring diagram and close the access panel.
6. When finished with all sections, restore power to the heater and turn on the gas. Light, following the instructions on the lighting instruction plate. Check for proper operation.

36. Operating Gas Valve(s)

WARNING: The operating valve is the prime safety shutoff. All gas supply lines must be free of dirt or scale before connecting to the heater to ensure positive closure. See Hazard Levels, page 2.

NOTE: Operational pressure settings and instructions for checking pressure settings are in Paragraph 12.

Carefully remove external dirt accumulation and check the wiring connections. Size 400 has one valve; Size 800 has two valves; Size 1200 has three valves.

The combination gas valve must be checked annually to ensure that the valve is shutting off gas flow completely.

Instructions:

- 1) Locate the 1/8" NPT pressure tap on the combination valve.

FIGURE 29 - Pressure Tap for Checking Gas Flow Shutoff

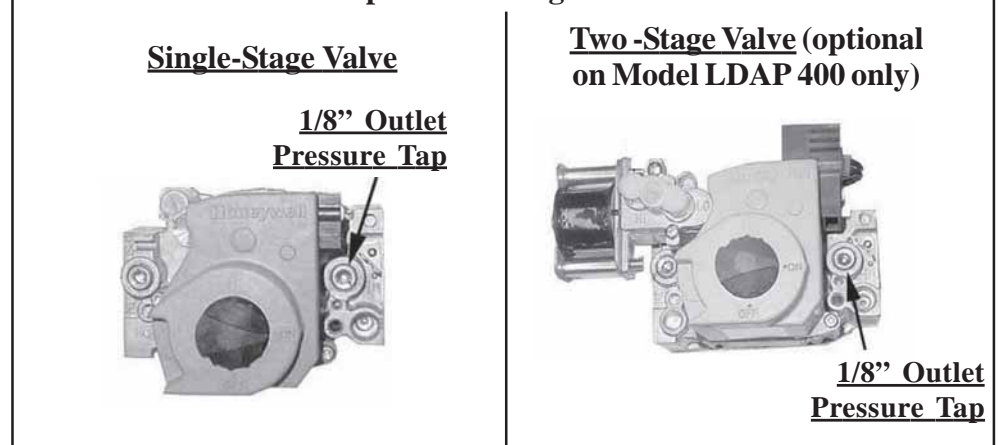

- 2) With the manual valve turned off to prevent flow to the gas valve, connect a manometer to the 1/8" outlet pressure tap in the valve. NOTE: A manometer (fluid-filled gauge) is recommended.
- 3) Turn the manual valve to the ON position and the heater OFF. Use your finger to fully block the main burner orifice for several seconds. Observe the manometer with the orifice blocked, and if any pressure is indicated, the gas valve is leaking. A leaking gas valve must be replaced before the heater is placed back in operation.

37. Combustion Air Pressure Switch(es)



Main Combustion Air Pressure Switch - Models 800 and 1200



Heat Section Pressure Switch

See FIGURE 22, page 34, for location of the heat section pressure switch. If it is determined that a pressure switch needs replacing, use only the factory-authorized replacement part that is designed for the model and size of heater being serviced.

Size 400 has one pressure switch; Size 800 has two heat section pressure switches and a main combustion air pressure switch; and Size 1200 has three heat section pressure switches and a main combustion air pressure switch. The main combustion air pressure switch is located on the top of the first heat section (see the illustration in Paragraph 34, page 36).

NOTE: A heater operating above 6000 ft elevation requires high altitude heat section pressure switch(es). See Paragraph 5.

38. Limit Control



If it is determined that the automatic reset limit control needs replacing, use only a factory-authorized replacement part that is designed for the size of heater.

For approximate limit location, see **FIGURE 22**, page 34.

39. High Limit Control



A manual reset high limit control is located at the top of each heat section. Do not reset high limit control without correcting the problem. If it is determined that the limit control needs replacing, use only a factory-authorized replacement part that is designed for the size of heater.

40. Transformer



See **FIGURE 22**, page 34, for location. Use a voltmeter to verify that there are 24 volts output from the transformer. If the transformer is not functioning, it must be replaced. Use a replacement transformer identical to the factory-installed model.

41. Adjustable Fan Control



See **FIGURE 22**, page 34, for location. Check the wiring connections and the adjustment knob.

If it is determined that the destratification fan control needs replacing, use only a factory-authorized replacement part that is designed for the heater.

42. Vent System

Check the complete vent system at least once a year. Inspection should include all joints, seams, and the vent terminal cap. Clean openings. Replace any defective parts.

43. Troubleshooting

Check the Lights on the DSI Integrated Control Module (Circuit Board)

IMPORTANT: When using a multimeter to troubleshoot the 24 volt circuit, place the meter's test leads into the 5 or 9 pin connectors located on the ignition control. Do not remove connectors or terminals from the electrical components. Doing so can result in misinterpreted readings due to the ignition control board's fault mode monitoring circuits.

The integrated circuit board monitors the operation of the heater and includes two LED signal lights that indicate normal operation and various abnormal conditions. If the heater fails to operate properly, check this signal to determine the cause and/or to eliminate certain causes. See operating sequence in Paragraph 19.

Do not attempt to repair the DSI integrated control module; the only field replaceable component is the fuse.

Control Status - GREEN LED Codes		Flame Status - YELLOW LED Codes	
Steady On	Normal Operation - No call for heat.	Steady On	Flame is sensed.
Fast Flash	Normal Operation - Call for heat.	Slow Flash	Weak flame (current below 1.0 microamps \pm 50%)
1 Flash	System Lockout (failed to detect or sustain flame)	Fast Flash	Undesired flame (valve open and no call for heat).
2 Flash	Main combustion air pressure switch or heat section pressure switch does not close with 30 seconds of venter being energized.		
3 Flash	Limit or high limit switch open.		
4 Flash	Main combustion air pressure switch or heat section pressure switch is closed before venter is energized.		
Steady Off	Blown fuse; No power; or Defective board		

DSI Integrated Control Module (Circuit Board) Trial Troubleshooting Flowchart

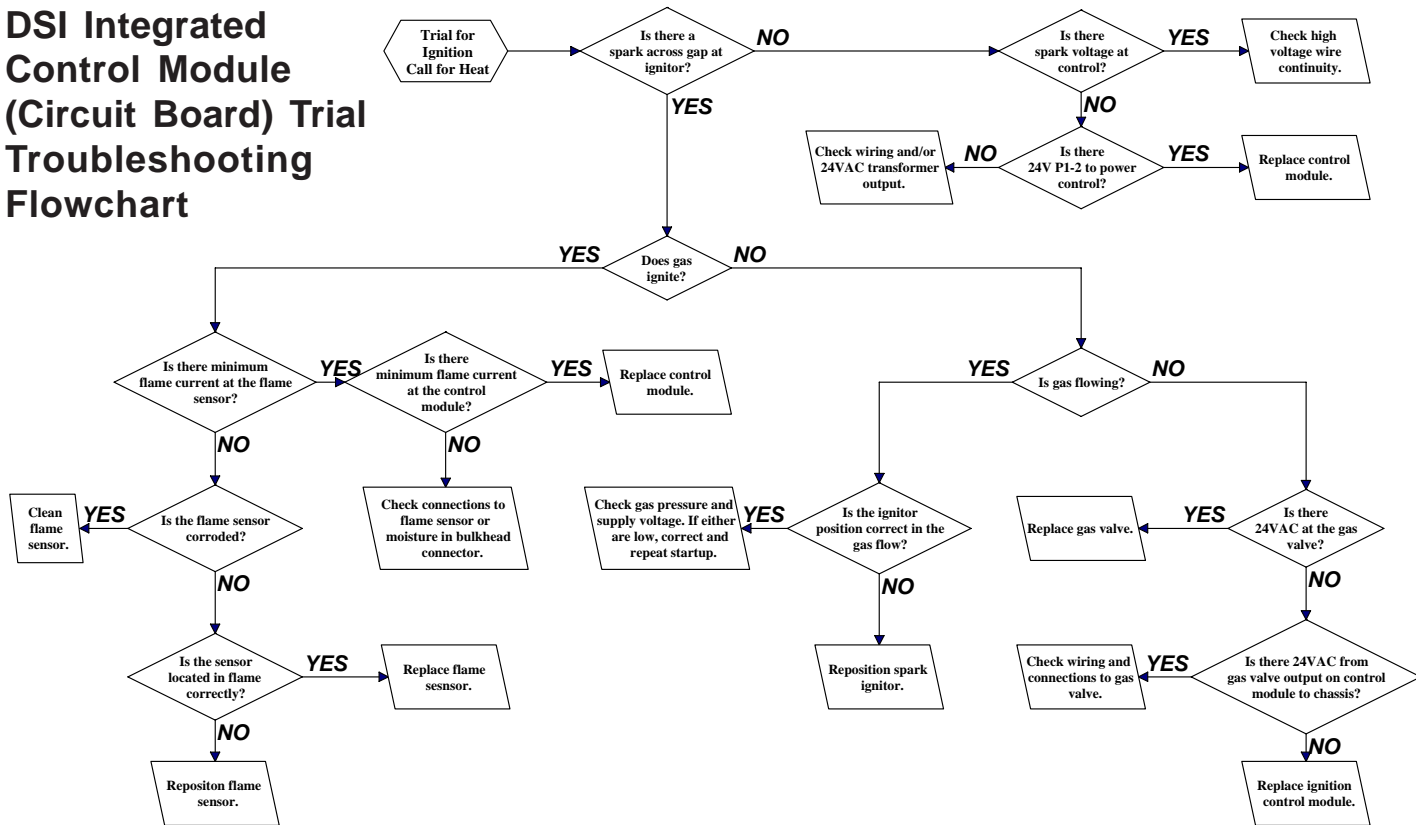

General Troubleshooting

PROBLEM	PROBABLE CAUSE	REMEDY
Venter motor will not start	1. No power to unit.	1. Turn on power; check supply fuses or main circuit breaker.
	2. No 24 volt power to integrated circuit board.	2. Turn up thermostat; check control transformer output.
	3. Integrated circuit board fuse blown.	3. Correct cause. Replace fuse (type ATC or ATO, 32VDC, 3A).
	4. No power to venter motor.	4. Tighten connections at circuit board and/or motor terminals.
	5. Integrated circuit board defective.	5. Replace intergrated circuit board.
	6. Defective venter motor.	6. Replace venter motor. See Paragraph 32.
Burner will not light	1. Manual valve not open.	1. Open manual valve.
	2. Air in the gas line.	2. Bleed gas line (initial startup only).
	3. Gas pressure too high or too low.	3. Supply pressure should be 5" - 14" w.c. for natural gas or 11" - 14" w.c. for propane gas.
	4. No Spark: a) Loose wire connections. b) Transformer failure. c) Incorrect spark gap. d) Spark cable shorted to ground. e) Spark electrode shorted to ground. f) Burner not grounded. g) Circuit board not grounded. h.) Unit not properly grounded.	4. a) Be certain all wire connections are solid. b) Be sure 24 volts is available. c) Maintain spark gap at 1/8". d) Replace worn or grounded spark cable. e) Replace if ceramic spark electrode is cracked or grounded. f) Make certain integrated circuit board is grounded to ignitor. g) Make certain integrated circuit board is grounded to furnace chassis. h.) Make certain unit is properly field grounded to earth ground and properly phased (L1 to hot lead L2 to neutral).
	i) Integrated circuit board fuse blown. j.) Faulty intergrated circuit board.	i) Correct cause. Replace fuse (type ATC or ATO, 32VDC, 3A). j) If 24 volt is available to the integrated circuit board and all other causes have been eliminated, replace board.
	5. Lockout device interrupting control circuit by above causes.	5. Reset lockout by interrupting control at the thermostat or main power.
	6. Combustion air proving switch not closing.	6. a) Make sure unit is properly vented. b) Remove obstructions from vent. c) Replace faulty tubing to pressure switch.
	7. Faulty combustion air proving switch.	7. Replace combustion air proving switch.
	8. Main valve not operating. a) Defective valve.	8. a) If 24 volt is measured at the valve connections and valve remains closed, replace valve. b) Check and tighten all wiring connections.
	b) Loose wire connections	
	9. Integrated circuit board does not power main valve. a) Loose wire connections. b) Flame sensor grounded.	9. a) Check and tighten all wiring connections. b) Be certain flame sensor lead is not grounded or insulation or ceramic is not cracked. Replace as required.
	c) Incorrect gas pressure.	c) Supply pressure should be 5" - 14" w.c. for natural gas or 11" - 14" w.c. for propane gas.
	d) Cracked ceramic at sensor.	d) Replace sensor.

General Troubleshooting (cont'd)

PROBLEM (cont'd)	PROBABLE CAUSE (cont'd)	REMEDY (cont'd)
Burner cycle on and off	1. Gas pressure too high or too low.	1. Supply pressure should be 5" - 14" w.c. for natural gas or 11" - 14" w.c. for propane gas.
	2. Burner not grounded	2. Make certain integrated circuit board is grounded to ignitor.
	3. Circuit board not grounded.	3. Make certain integrated circuit board is grounded to furnace chassis.
	4. Faulty integrated circuit board	4. If 24 volt is available to the integrated circuit board and all other causes have been eliminated, replace board.
	5. Combustion air proving switch(es) not closing.	5. a) Make sure unit is properly vented. b) Remove obstructions from vent. c) Replace faulty tubing to pressure switch.
	6. Faulty combustion air proving switch.	6. Replace combustion air proving switch.
	7. Flame sensor grounded.	7. Be certain flame sensor lead is not grounded or insulation or ceramic is not cracked. Replace as required.
	8. Cracked ceramic at sensor.	8. Replace sensor.
	9. Incorrect polarity.	9. Reverse line volt leads to integrated circuit board.
No heat (Heater Operating)	1. Incorrect valve outlet pressure or orifice.	1. Check valve outlet pressure. See Rating plate for manifold pressure.
	2. Cycling on limit control.	2. Check air throughput.
	3. Improper thermostat location or adjustment.	3. See thermostat manufacturer's instructions.
Fan or venter motor will not run	1. Circuit open.	1. Check wiring and connections.
	2. Defective integrated circuit board.	2. Replace board.
	3. Defective motor.	3. Replace motor.
Fan or venter motor turns on and off while burner is operating	1. Motor overload device cycling on and off.	1. Check motor load against motor rating plate. Replace motor if needed.
Fan or venter motor cuts out on overload	1. Low or high voltage supply.	1. Correct electric supply.
	2. Defective motor.	2. Replace motor.
	3. Poor airflow.	3. Clean motor, fan, fan guard, filter, and coils.
	4. Defective bearing or lubrication.	4. Lubricate bearings (motor permitting) or replace motor.

FOR SERVICE OR REPAIR, FOLLOW THESE STEPS IN ORDER:

FIRST: **Contact the Installer**
 Name _____
 Address _____

 Phone _____

SECOND: **Contact the nearest distributor** (See Yellow Pages). If no listing, contact Authorized Factory Representative, 1-800-695-1901 (Press 1).

THIRD: **Contact** REZNOR®/ Thomas & Betts Corporation
 150 McKinley Avenue
 Mercer, PA 16137
 Phone: (724) 662-4400

Model No. _____
Heater Serial No. _____
Date of Installation _____

Free Manuals Download Website

<http://myh66.com>

<http://usermanuals.us>

<http://www.somanuals.com>

<http://www.4manuals.cc>

<http://www.manual-lib.com>

<http://www.404manual.com>

<http://www.luxmanual.com>

<http://aubethermostatmanual.com>

Golf course search by state

<http://golfingnear.com>

Email search by domain

<http://emailbydomain.com>

Auto manuals search

<http://auto.somanuals.com>

TV manuals search

<http://tv.somanuals.com>