

Thule System Kit 262

FORD Taurus 4-dr, 96-
MERCURY Sable 4-dr, 96-

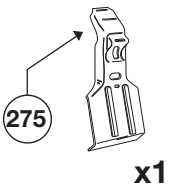

Front	Rear
1005 mm / 39 5/8 inch	980 mm / 38 5/8 inch

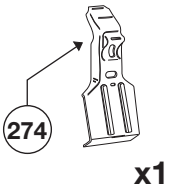
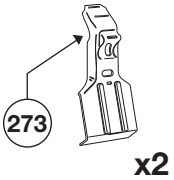
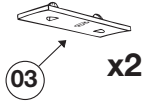
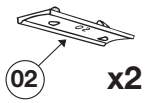
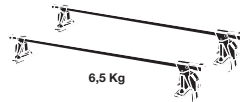
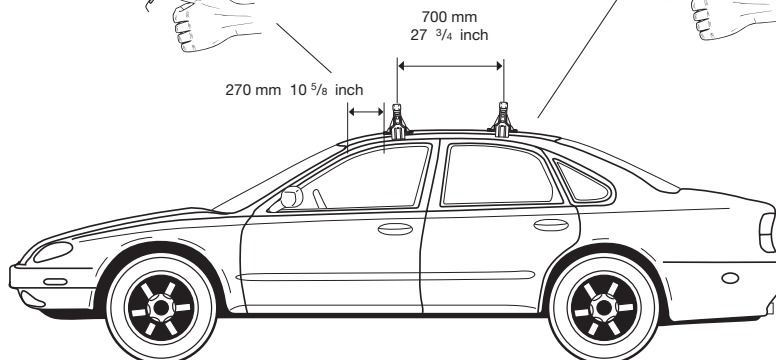
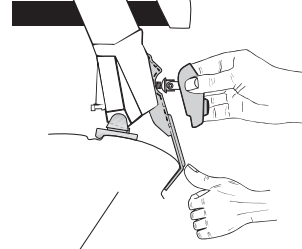
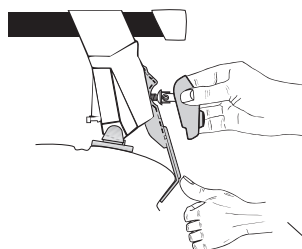
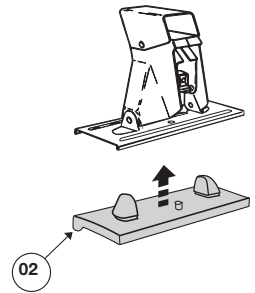
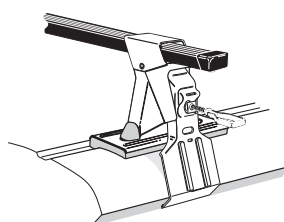
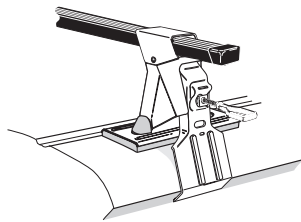
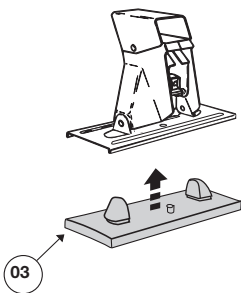
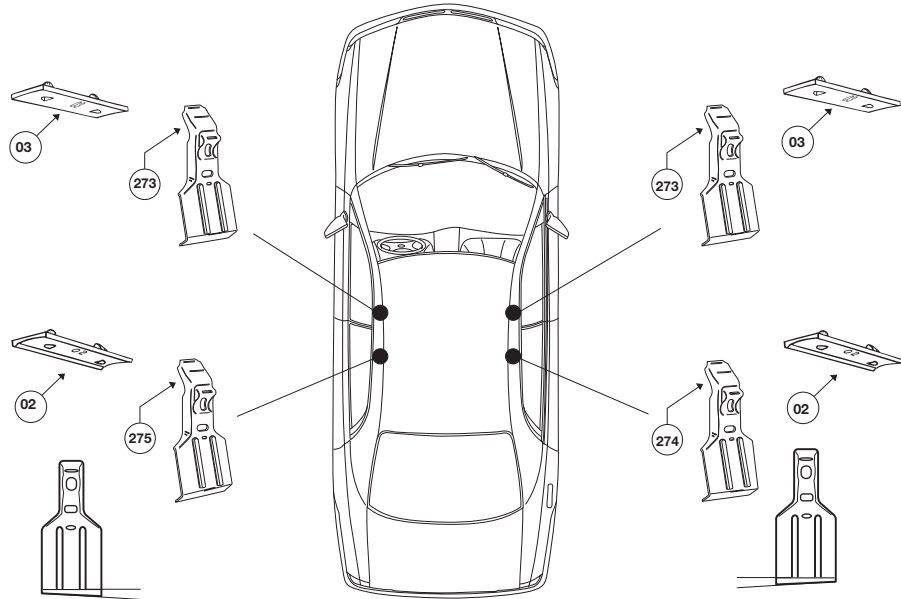

546•4DF/501-0262

Free Manuals Download Website

<http://myh66.com>

<http://usermanuals.us>

<http://www.somanuals.com>

<http://www.4manuals.cc>

<http://www.manual-lib.com>

<http://www.404manual.com>

<http://www.luxmanual.com>

<http://aubethermostatmanual.com>

Golf course search by state

<http://golfingnear.com>

Email search by domain

<http://emailbydomain.com>

Auto manuals search

<http://auto.somanuals.com>

TV manuals search

<http://tv.somanuals.com>