



**CP-66**

# Functions and Operating Instructions

TOA Corporation

# Contents

---

Introduction to the "Functions and Operating Instructions" for stations for EXES-6000 .....	1
---	---

## Chapter 1. Basic Functions, Their Operating Procedures and All Functions

1. Stations .....	2	4. Station Operation (NP Type)	
2. Speech Functions .....	3	1) Handset Master Station (TL-600M/610M/660M) ...	11
3. Station Operation (PV Type)		2) Handset Substation (TL-600S) .....	11
1) Handset Master Station (TL-600M/610M/620M) ...	4	3) Hands-free Master Station (HF210M/210MB/670M/HS-670) .....	12
2) Handset Substation (TL-600S) .....	4	4) Hands-free Substation .....	13
3) Hands-free Master Station (HF-210M/210MB/670M/HS-670).....	5	5) Hands-free/Handset Master Station (HF-200M/200MB/250M) .....	14
4) Hands-free Substation .....	6	6) Hands-free/Handset Substation .....	15
5) Hands-free/Handset Master Station (HF-200M/200MB/250M) .....	7	7) Hands-free/Handset Master Station with Auto-dialer (HF-250M) .....	16
6) Hands-free/Handset Substation .....	8	8) Door Station (HF-640S) .....	17
7) Hands-free/Handset Master Station with Auto-dialer (HF-250M) .....	9	9) Talk-back unit (TK-20) .....	17
8) Door Station (HF-640S) .....	11	5. Functions: EXES-6000 CP-66 .....	18
9) Talk-back unit (TK-20) .....	11		

## Chapter 2. Functions and Operating Procedures of Single Exchange System

1. EXES-6000 CP-66 Summary of Dial Operations (For Single Exchange) .....	20	24) How to Select the Paging Area and Make the Paging Call .....	44
2. Description of Each Function		25) All-Call Paging and Individual Zone Paging .....	45
1) Camp-On-Busy .....	24	26) Combination Paging .....	46
2) Busy Call Back .....	24	27) Emergency All-Call Paging .....	48
3) Privacy (PV Type) .....	25	28) Priority Station Paging .....	49
4) Camp-On-Privacy (PV Type) .....	26	29) Personal Number Paging .....	50
5) Press-To-Talk .....	26	30) Selectable First Station Number .....	51
6) Mic Off (PV Type/NP Type) .....	27	31) Programmable Station Numbering .....	51
7) Press-To-Talk Control .....	27	32) Group Blocking .....	52
8) Single Digit Dialing .....	28	33) Programmable Restricted Access for Stations .....	53
9) Master Sub Relationship .....	29	34) Selectable Calling Tone .....	54
10) Automatic Access To Paging .....	29	35) Selectable Paging Pre-paging Tone Duration .....	54
11) Personal Number Call .....	30	36) Time-Out of Conversation .....	54
12) Continuous Calling Tone .....	31	37) Time-Out of Paging Call .....	54
13) Remote Response .....	32	38) In/Out Annunciation .....	55
14) Call Transfer, Paging during Normal Call .....	33	39) Destination Annunciation Indication .....	56
15) Group Hunting .....	34	40) Calling Party Indication [Lamp Type] .....	57
16) Secretary Transfer (PV Type/NP Type) .....	35	41) Calling Party Indication [Numerical Type] .....	58
17) Call Forwarding .....	38	42) Conversation Partner Indication [Lamp Type] .....	59
18) Priority .....	39	43) Pocket Pager .....	60
19) Executive Priority .....	39	44) General Purpose Control .....	61
20) Highest Executive Priority .....	40	45) Simplified Paging .....	62
21) Conference .....	41	46) Clear Entry and Conversation Over .....	62
22) Paging .....	42		
23) Other Paging Modes .....	43		

**Chapter 3. Functions and Operating Procedures of Tie-Line System**

1. Tie-Line Connections of Exchanges . . . . .	63	17) Paging . . . . .	83
2. Restrictions Resulting from Tie-Line Connection . .	65	18) How to Select the Paging Area and Make the Paging Call . . . . .	84
3. EXES-6000 CP-66 Summary of Dial Operations (For Tie-Line System) . . . . .	66	19) All-Call Paging and Individual Zone Paging . . . .	85
4. Description of Each Function		20) Selectable First Station Number of Each Exchange . . . . .	86
1) Camp-On-Busy . . . . .	68	21) Programmable Station Numbering . . . . .	87
2) Busy Call Back . . . . .	68	22) Group Blocking . . . . .	88
3) Privacy (PV Type) . . . . .	69	23) Programmable Restricted Access for Stations . . .	90
4) Camp-On-Privacy (PV Type) . . . . .	70	24) Selectable Calling Tone . . . . .	91
5) Press-To-Talk . . . . .	70	25) Selectable Paging Pre-paging Tone Duration . . . . .	91
6) Single Digit Dialing . . . . .	71	26) Time-Out of Conversation . . . . .	91
7) Master Sub Relationship . . . . .	72	27) Time-Out of Paging Call . . . . .	91
8) Automatic Access To Paging . . . . .	72	28) In/Out Annunciation . . . . .	92
9) Personal Number Call . . . . .	73	29) Calling Party Indication [Lamp Type] . . . . .	93
10) Continuous Calling Tone . . . . .	74	30) Conversation Partner Indication [Lamp Type] . .	94
11) Remote Response . . . . .	75	31) Pocket Pager . . . . .	95
12) Call Transfer, Paging during Normal Calls . . . . .	76	32) General Purpose Control . . . . .	96
13) Group Hunting . . . . .	77	33) Simplified Paging . . . . .	98
14) Secretary Transfer (PV Type/NP Type) . . . . .	78	34) Clear Entry and Conversation Over . . . . .	98
15) Highest Executive Priority . . . . .	81		
16) Conference . . . . .	82		

**Chapter 4. Functions and Operating Procedures of External Interface System**

1. Description of Each Function		5) Tie-Line Interface . . . . .	103
1) External Interface . . . . .	99	6) Selectable Paging . . . . .	106
2) OD Interface . . . . .	100	7) Speech Message . . . . .	111
3) LD Interface . . . . .	100	8) Background music (BGM) . . . . .	113
4) CB Interface . . . . .	101	9) Alarm . . . . .	114
		10) Time signal . . . . .	114

# Introduction to the "Functions and Operating Instructions" for stations for EXES-6000

This handbook explains the functions and operating procedures of stations for TOA's EXES-6000 Intercom System.

**This handbook is comprised of the following 4 chapters:**

**Chapter 1. Basic functions, their operating procedures and all functions.**

**Chapter 2. Functions and operating procedures of single exchange system.**

**Chapter 3. Functions and operating procedures of tie-line system.**

**Chapter 4. Functions and Operating procedures of External Interface system.**

**Refer to Chapters 1, 2 and 4 for single exchange system and to Chapters 1, 3 and 4 for tie-line system.**

Please note that performances of some functions are restricted in the tie-line system.

You need not read all the instructions given in this handbook but it is necessary to read the instructions on those functions employed in your system. The following guidelines will help you select the pages that you should read.

### Selecting different functions made available by placing the Privacy Switch in the "ON" position

The EXES-6000 System is designed to allow either "PV" type operation (the system having Privacy function) or "NP" type (without Privacy function) to be selected by turning on or off a switch inside the exchange. It is impossible to make one station the "NP" type and another the "PV" type in the same system.

The function provided when the Privacy switch is in the ON position is different between the "PV" and the "NP" type. Therefore, read the page marked **PV Type** if your system is of the "PV" type and the Page **NP Type** if it is of the "NP" type.

### "PV" Type and "NP" Type

Type	Definition	Description
PV Type	System having Privacy function	1. Privacy tone With the Privacy switch in the ON position, a brief Privacy tone sounds and *1 any incoming call is refused.
NP Type	System having no Privacy function	1. Continuous calling tone A station with the Privacy switch may be called by the continuous calling tone when its Privacy switch is placed in the ON position. One touch dialing any key (1 through 9, *, 0, #) other than the PTT key or picking up the handset stops the calling tone and the stations is made ready to initiate the response to the call. *2 2. The Handset Master station without Privacy switch may be called by the continuous calling tone. Picking up the handset stops the calling tone and allows the conversation.

#### Note.

- \*1. Before you use a PV-type handset station, it is necessary that you first register that station by station No.200 programming.
- \*2. By programming, the continuous calling tone function may be made available to specific stations with the Privacy switch in the OFF position. In this event, touch dialing any key (1 through 9, \*, 0, #, #) other than the PTT key stops the calling tone and permits conversation. This feature may be employed in the industrial type of station (Model HF 670M) or in the "PV" type system that needs to be continuously called.

## Chapter 1

Basic functions, their operating procedures and all functions

# 1. Stations

**(1) HF-200M/HF-200MB**

Desk/surface-mounted handsfree/handset master station

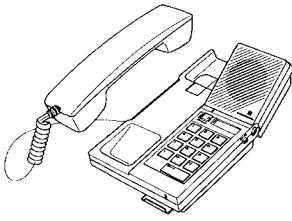

**(2) HF-210M/HF-210MB**

Desk/surface-mounted handsfree master station



**(3) TL-600M**

Desk/surface-mounted handset operated master station

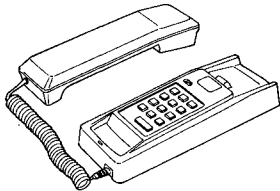

**(4) TL-600S**

Desk/surface-mounted handset operated substation

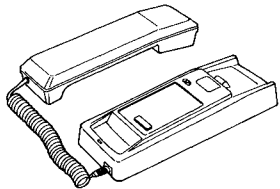

**(5) TL-610M**

Desk-top type handset operated master station

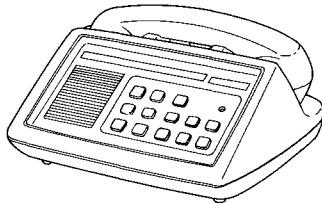

**(6) TL-620M**

Surface-mounted handset operated master station

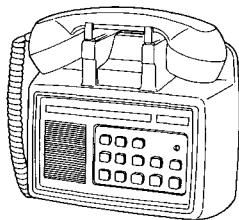

**(7) HF-640S**

Door station

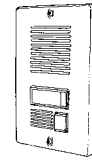

**(8) HF-670M/HS-670**

HF-670M  
Industrial-use handsfree  
master station

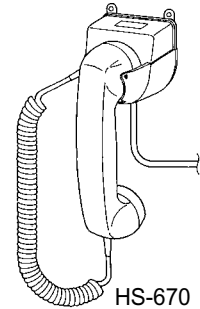
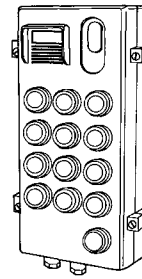

HS-670  
Handset unit for HF-670M

**(9) HF-250M**

Desk/surface-mounted handsfree/handset master station

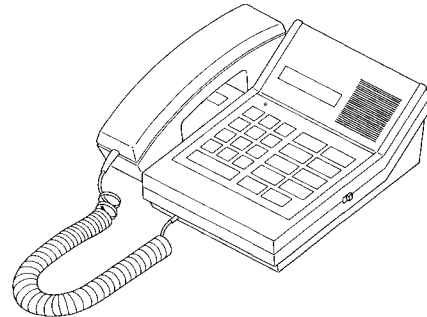

**(10) TK-20**

Talk-back unit

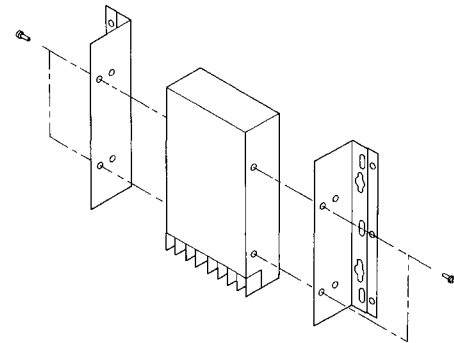

## 2. Speech functions

Either "PV" Type (the system with Privacy function) or "NP" Type (without Privacy function) mode should be selected for the whole intercom system.  
When Privacy Switch (SW) of station is turned ON, privacy tone is available in "PV" Type system, while continuous calling tone is available in "NP" Type system.

	Functions	System types		Descriptions	Stations *2		Privacy SW
		PV	NP		Without Privacy SW	With Privacy SW	
Calling	Dialing	<input type="radio"/>	<input type="radio"/>	Calls are made by touching dial key. Even when the Privacy SW is on, calling is possible.	HF-670M	HF-250M HF-200M, 200MB HF-210M, 210MB	ON/OFF
	One-Touch Dialing	<input type="radio"/>	<input type="radio"/>	Substations can make a call to designated master stations by one-touch dialing. Calling is possible even when the Privacy SW is on.	HF-640S	—	ON/OFF
	Dialing after picking up handset and confirming dial tone	<input type="radio"/>	<input type="radio"/>	*2 Calls can be made by touching dial key after picking up handset, and confirming dial tone is heard.	TL-610M TL-620M TL-600M	HF-250M HF-200M, 200MB	ON
	Calling by picking up handset	<input type="radio"/>	<input type="radio"/>	*2 Substations can make a call to designated master stations by simply picking up the handset.	TL-600S	—	ON
Voice	Voice Calling	<input type="radio"/>	<input type="radio"/>	When called by continuous calling tone or privacy tone, voice can be sent by pressing (PTT) bar.	All stations except HF-640S		ON/OFF
Receiving	Hands-free calling and conversation	<input type="radio"/>	<input type="radio"/>	By one-touch dialing keys, after a brief calling tone hands-free conversation can get started.	HF-640S HF-670M	HF-250M HF-200M, 200MB HF-210M, 210MB	OFF
	Continuous calling tone response by one-touch dialing (No. 200 programming) *1	<input type="radio"/>	<input type="radio"/>	One-touch dialing keys transmits a continuous calling tone. Hands-free Conversation can get started when called party depresses, the [□]~[□], [□] or [□] key.	HF-640S HF-670M	HF-250M HF-200M, 200MB HF-210M, 210MB	OFF
	Privacy	<input type="radio"/>	<input checked="" type="radio"/>	When calls are unwanted, turn ON Privacy SW. Then a brief privacy tone sounds when called. By turning off Privacy SW or touching any key ([□]~[□], [□], [□]key) or by picking up a handset, conversation becomes possible.	—	HF-250M HF-200M, 200MB HF-210M, 210MB	ON
	Continuous calling tone picking up response (in Privacy mode)	<input type="radio"/>	<input type="radio"/>	*2 When called by continuous calling tone, conversation is possible by picking up handset.	TL-610M TL-620M TL-600M/S	HF-250M HF-200M, 200MB	ON
	Continuous calling tone one-touch response (in Privacy mode)	<input type="radio"/>	<input type="radio"/>	*2 Calls can be answered by dialing the [□]~[□], [□] or [□] key without picking up handset when called by continuous calling tone.	—	HF-250M HF-200M, 200MB HF-210M, 210MB	—
Speech Methods	Voice switch conversation	<input type="radio"/>	<input type="radio"/>	Two-way conversation is achieved automatically when two parties speak in hands-free mode.	HF-640S HF-670M	HF-250M HF-200M, 200MB HF-210M, 210MB	ON/OFF
	Simplex conversation by press-to-talk key	<input type="radio"/>	<input type="radio"/>	One-way conversation is made by a party who presses (PTT). Releasing the (PTT) bar will reverse the one-way conversation flow.	HF-640S HF-670M	HF-250M HF-200M, 200MB HF-210M, 210MB	ON/OFF
	Fully duplex conversation	<input type="radio"/>	<input type="radio"/>	Fully duplex conversation is made when at least either party uses a handset.	TL-610M TL-620M TL-600M/S HF-640S HF-670M	HF-250M HF-200M, 200MB HF-210M, 210MB	ON/OFF

\*1 This function may be employed for the industrial type of station (Model HF-670M) or in the "PV" system that needs to be continuously called.

\*2 Before you use a PV-type handset station, it is necessary that you first register that station by station No. 200 programming.

### 3. Station Operation (PV Type)

PV Type

#### 1) Handset Master Station

Model TL-600M/610M/620M

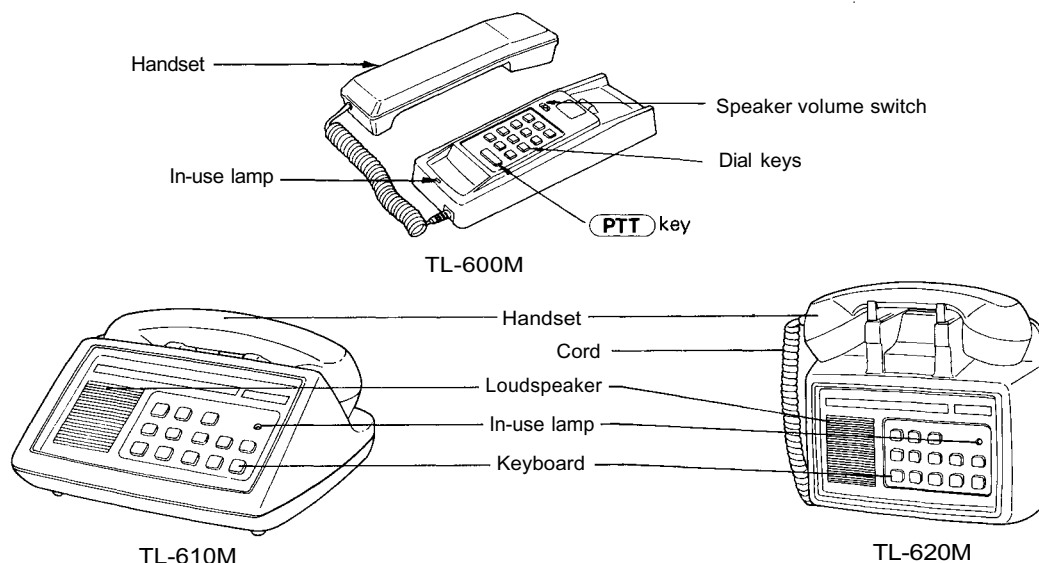

#### < Making a call >

1. Pick up the handset and dial the desired station number after hearing a dial tone.
2. Start conversation after the calling tone stops.
3. When you hear a busy tone that indicates the party you call is on another line, you can camp on the line by simply waiting without hanging up the handset. As soon as the line becomes free, your call is automatically connected.
4. While the continuous calling tone is sent, you can break in on the calling tone by continuously depressing the **PTT** key to make a voice call through the station speaker of the called party.

5. Hang up the handset or depress the  key to terminate the conversation.

#### < Responding to a call >

6. When you are called by the continuous calling tone or paged through your station speaker, respond to the call by picking up the handset.

#### Note.

1. The sound volume of the calling tone may be adjusted by means of a 2-stage volume selector. (SP. VOL) switch.
2. When using this function in the PV type system having the Privacy function, No. 200 programming is required.

#### 2) Handset Substation

Model TL-600S

PV Type

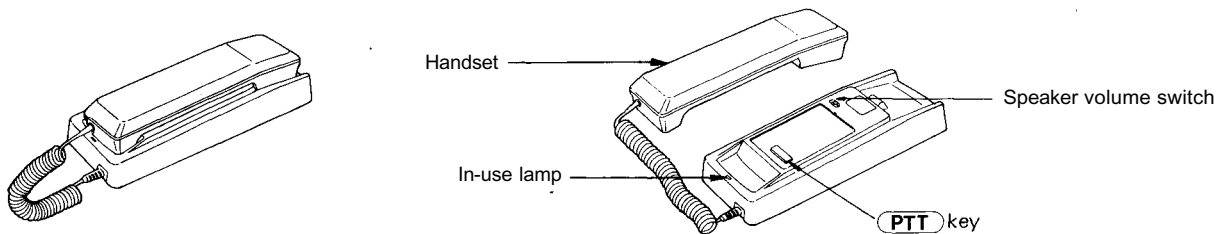

#### < Making a call >

1. Picking up the handset makes a call to the designated station.
2. Start conversation after the calling tone stops.
3. When you hear a busy tone that indicates the party you call is on another line, you can camp on the line by simply waiting without hanging up the handset. As soon as the line becomes free, your call is automatically connected.
4. While the continuous calling tone is sent, you can break in on the calling tone by continuously depressing the **PTT** key to make a voice call through the station speaker of the called party.

5. Hang up the handset to terminate the conversation.

#### < Responding to a call >

6. When you are called by the continuous calling tone or paged through your station speaker, respond to the call by picking up the handset.

#### Note.

1. The sound volume of the calling tone may be adjusted by means of a 2-stage volume selector. (SP. VOL) switch.
2. When using this function in the PV type system having the Privacy function, No. 200 programming is required.



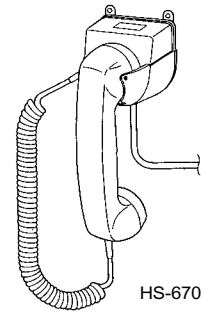
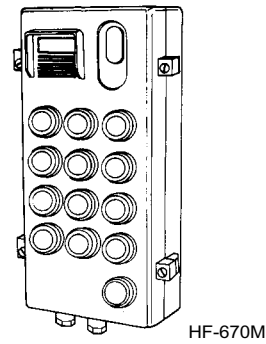
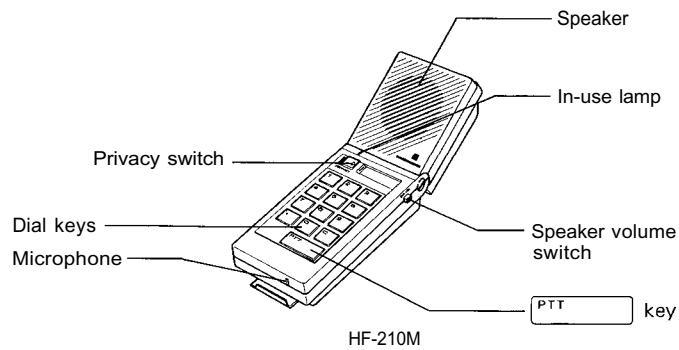

## &lt; Making a call &gt;

1. Dial the desired station number regardless of whether the Privacy switch of your station is in the ON position or OFF position.
2. Start conversation after the calling tone stops.
3. When the line is busy, a busy tone is heard and you can camp on the line by simply waiting. As soon as the line becomes free, your call is automatically connected.
4. While a continuous calling tone or Privacy tone is being sounded, you can make a voice call by continuously depressing the **PTT** key.
5. When the party you call is in a high noise level area, your continuously depressing the **PTT** key allows one-way conversation to that party. As long as you depress the **PTT** key, your voice has dominance and releasing the **PTT** key will reverse the one-way conversation from that party to you.
6. To terminate the conversation, depress the **□** key.

## &lt; Responding to a call &gt;

[Privacy switch is OFF.]

7. Respond to the call after the calling tone stops.

[Privacy switch is ON.]

8. A brief Privacy tone sounds from your station each time there is an incoming call and all incoming calls are refused.  
To respond touch dial any key (1~9, \*, 0, #) other than the **PTT** key while the line is connected between you and the calling party.

**Note.**

1. The sound volume of the speaker may be adjusted by means of the 2-stage volume selector (VOL) switch.
2. With no speaker built inside, the HF-670M needs to be connected to an external speaker. Also, the HF-650M is fitted with no Privacy switch.
3. When the HF-670M is connected to the handset unit HS-670, lifting up the handset responds to call.

#### 4) Hands-free Substation

PV Type

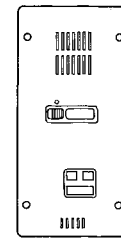
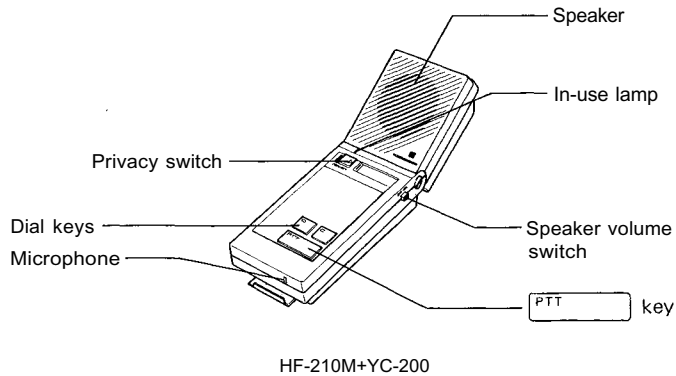

##### < Making a call >

1. Touching the key makes a call to the designated station regardless of whether the Privacy switch on the calling station is in the ON position or OFF position.
2. Start conversation after the calling tone stops.
3. When the line is busy, a busy tone is heard and you can camp on the line by simply waiting. As soon as the line becomes free, your call is automatically connected.
4. While a continuous calling tone or Privacy tone is being sounded, you can make a voice call by continuously depressing the key.
5. When the party you call is in a high noise level area, your continuously depressing the key allows one-way conversation to that party. As long as you depress the key, your voice has dominance and releasing the key will reverse the one-way conversation from that party to you.
6. To terminate the conversation, depress the key.

##### < Responding to a call >

- [Privacy switch is in the OFF.]
7. Respond to the call after the calling tone stops.  
[Privacy switch is in the ON.]
  8. A brief Privacy tone sounds from your station each time there is an incoming call, and all incoming calls are refused.  
To respond, touch dial the or key while the line is connected between you and the calling party.

##### Note.

1. The sound volume of the speaker may be adjusted by means of the 2-stage volume selector (VOL) switch.
2. The No.200 programming (Master/Sub relationship) must be performed in the exchange to call a specified master station.

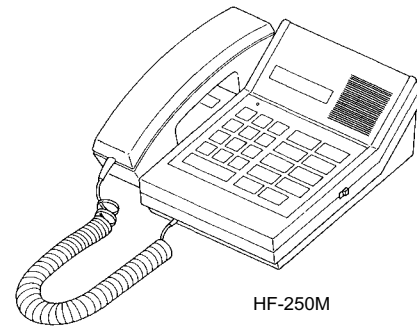
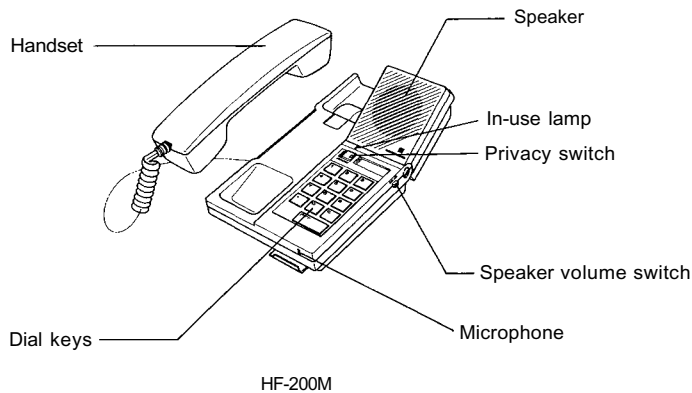

### < Making a call >

- Hands-free conversation may be made by simply touch dialing the station number you wish to call.
- When you wish to use the handset, pick it up, then touch dial the station number you wish to call, or reverse the order.
- Start conversation after the calling tone stops.
- When you hear a busy tone that indicates the party you call is on another line, you can camp on the line by simply waiting. As soon as the line becomes free, your call is automatically connected.
- In the event that the party you are calling does not respond and the continuous calling tone is still heard from your station, or when the station of that party is in the Privacy mode and the Privacy tone is sounded, you can break in on the calling tone by continuously depressing the **PTT** key to make a voice call through the station speaker of the called party.
- During hands-free conversation, when the person you are talking to is in a high noise level area,
  - Pick up the handset to talk or
  - depress the **PTT** key continuously for one-way conversation to that party. As long as the **PTT** key is depressed, your voice has dominance, and releasing the **PTT** key will reverse the one-way conversation from that party to you.
- To terminate the conversation, hang up the handset or depress the **□** key.

### < Responding to a call >

[Privacy switch is in the OFF.]

- Respond to call after the calling tone stops.

[Privacy switch is in the ON.]



- A brief Privacy tone will sound from the called station each time it receives an incoming call and all incoming calls are refused. To respond, depress any key (**1** ~ **9**, **□**, **□**, **□**) other than the **PTT** key or pick up the handset while the line is still connected between the called and the calling stations. These stations are, however, automatically disconnected from the speech path after approximately 10 seconds from call establishment if no response is made the called party.

#### Note.

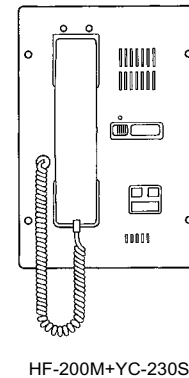
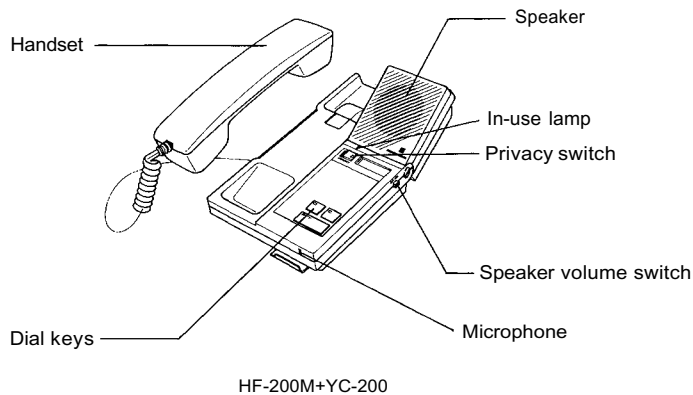
The sound volume of the loud speaker may be adjusted by means of the 2-stage volume selector (VOL) switch.



## &lt; Making a call &gt;



1. For hands-free conversation, touching the  key makes a call to the designated station regardless of whether the Privacy switch on your station is in the ON position or OFF position.
2. When you wish to use the handset, pick it up, then touch dial the  key to make a call or reverse the order.
3. Start conversation after the calling tone stops.
4. When you hear a busy tone that indicates the party you call is on another line, you can camp on the line by simply waiting. As soon as the line becomes free, your call is automatically connected.
5. In the event that the party you are calling does not respond and the continuous calling tone is still heard from your station, or when the station of that party is in the Privacy mode and the Privacy tone is sounded, you can break in on the calling tone by continuously depressing the **(PTT)** key to make a voice call through the station speaker of the called party.
6. During hands-free conversation, when the person you are talking to is in a high noise level area,
  - (1) Pick up the handset to talk or (2) depress the **(PTT)** key continuously for one-way conversation to that party. As long as the **(PTT)** key is depressed, your voice has dominance, and releasing the **(PTT)** key will reverse the one-way conversation from that party to you.
7. To terminate the conversation, hang up the handset or depress the  key.

## &lt; Responding to a call &gt;

[Privacy switch is in the OFF.]

8. Respond to call after the calling tone stops.

[Privacy switch is in the ON.]

9. A brief Privacy tone will sound from your station each time it receives an incoming call and all incoming calls are refused. To respond, depress the  or  key or pick-up the handset while the line is still connected between your station and the station calling. These 2 stations are, however, automatically disconnected from the speech path after approximately 10 seconds from call establishment if no response is made by you.

**Note.**

1. The sound volume of the load speaker may be adjusted by means of the 2-stage volume selector (VOL) switch.
2. The No.200 programming (Master/Sub relationship) must be performed in the exchange to call a specified master station.

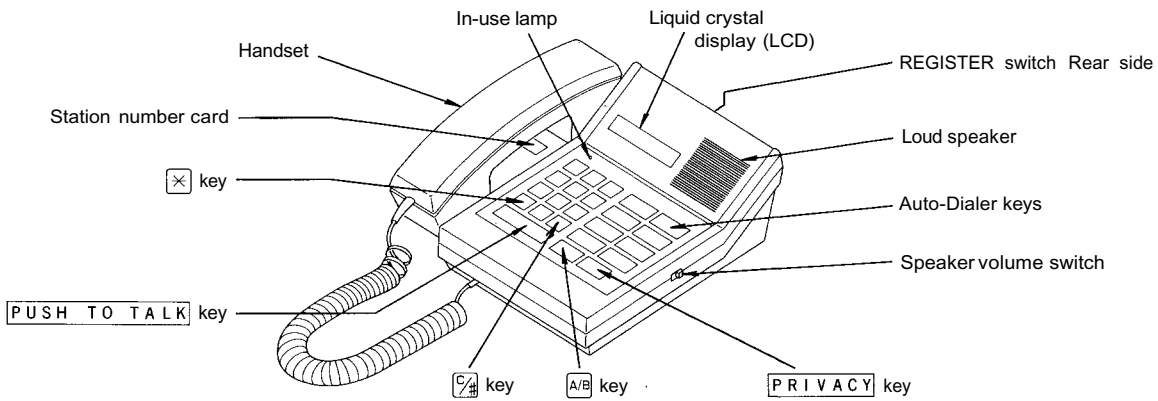

< Making a call >

1. Place the auto-dialer registration (REGISTER) switch in the OFF position.
2. 16 registrations are possible with 8 keys by changing over the A/B page selection key. You can call any one of pre-registered stations by touch-dialing the auto-dialer key.
3. For making a call and responding to a call without using the auto-dialer, refer to "5) Hands-free/Handset Master Station HF-200M/200MB/250M (With Auto-Dialer)".

< Auto-dialer registration >

Two station numbers can be registered by each auto-dialer key.

Operation

1. Switch the (REGISTER) switch ON.

Indication on the liquid crystal display

With DT - E 7 0 or  
W / o DT - E 7 0

2. Press the (PTT) key until PROGRAM - dial is appeared on the LCD display. Press it three times for With DT - E70 and twice for W/o DT - E70
3. Press the auto-dialer key (A<sub>1</sub> ~ A<sub>8</sub>, B<sub>1</sub> ~ B<sub>8</sub>) to select the station number to be registered.

Indication on the liquid crystal display.

A 1 :  
B 1 :

4. Press the A/B page selector key to select either A or B page.
5. Station numbers can be consecutively registered by maximum 50 digits using the dial keys.

Indication on the liquid crystal display.

A 1 : 1 2 3 4 5 6 7 8 9

6. Press the (PTT) key, and the dialled numbers are memorized.
7. Repeat steps (3) through (6) to register other station numbers.
8. Switch the (REGISTER) switch OFF after completing registration.

< Liquid crystal display >

- A. Indication on the liquid crystal display in conjunction with the DT-E70 is changed with three status.

1. When waiting  
Privacy mode status, page selection and time indication

P V A 1 0 : 3 6 a m

Displays "PV" status when the privacy key is set to ON.  
Displays either A or B page of the autodialer.

2. When dialling for paging

Dial monitor indication

\* 8 0 0

3. When responding to a call

2 3 5 : 2 3 6 1

Calling station number  
Waiting station number  
Number of waiting stations

Note. For detailed indication mode, refer to "Calling Party Indication (Numerical Type)"

- B. Indication on the liquid crystal display is changed into two status when the HF-250M is used solely.

P V A 2 0 1

His-own-station number

1. When waiting  
Privacy mode status, page selection and his-own-station number

2. When dialling for paging

Dial monitor indication

\* 8 0 0

Note. For registration to use the liquid crystal display, refer to "Operating Instructions of the HF-250M and DT-E70".

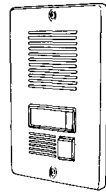

HF-640S

**< Making a call >**

1. Pressing a button calls the specified master station.
2. Speak when a calling tone stops.
3. When a busy tone is heard, simply wait. You are put through the master station as soon as its line is freed.
4. If there is no response even after a calling tone has stopped, press the button again and again. The calling tone is sounded each time the button is pressed.
5. Conversation or continuous calling tone is terminated unless the button is pressed every 30 seconds.

**Note.**

1. Making a call from the door station to the master station having its Privacy switch in ON transmits a brief calling tone to the door station only twice, while transmitting a continuous calling tone to the master station.
2. The No.200 programming (Master/Sub relationship) must be performed in the exchange to call a specified master station.

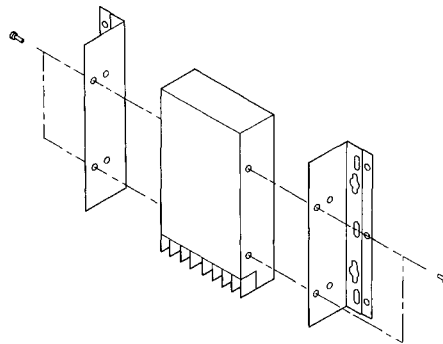
**9) Talk-back unit Model TK-20****< Making a call >****[When calling with the audio trigger function]**

When the sound into the speaker exceeds the preset volume, the specified master station is called.

**[When calling with the call switch]**

1. Pressing the talk-back station call switch calls the specified master station.
2. Talk to the specified master station after a calling tone is terminated.
3. Simply wait after a busy tone (intermittent single tone) is heard.  
As soon as the called station's line becomes free, your call is automatically connected.

**Note.** Be sure to set the audio trigger selector switch on the talk-back unit to ON.

**<Response>**

1. Talk to the specified master station after a calling tone is terminated.

**Note.** The No.200 programming (Master/Sub relationship) must be performed in the exchange to call a specified master station.

## 4. Station Operation (NP Type)

### 1) Handset Master Station

Model TL-600M/610M/620M

NP Type

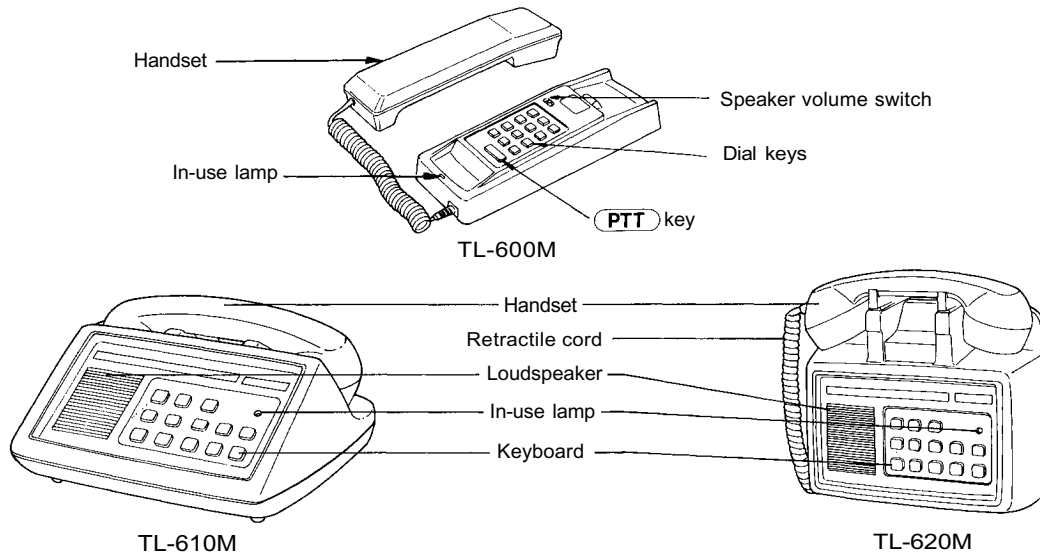

#### < Making a call >

1. Pick up the handset and dial the desired station number after hearing dial tone.
2. Start conversation after the calling tone stops.
3. When you hear a busy tone that indicates the party you call is on another line, you can camp on the line by simply waiting without hanging up the handset. As soon as the line becomes free, your call is automatically connected.
4. While the continuous calling tone is sent, you can break in on the calling tone by continuously depressing the **PTT** key to make a voice call through the station speaker of the called party.

5. Hang up the handset or depress the **□** key to terminate the conversation.

#### < Responding to a call >

6. When you are called by the continuous calling tone or paged through your station speaker, respond to the call by picking up the handset.

#### Note.

The sound volume of the calling tone may be adjusted by means of a 2-stage volume selector (SP. VOL) switch.

### 2) Handset Substation

Model TL-600S

NP Type

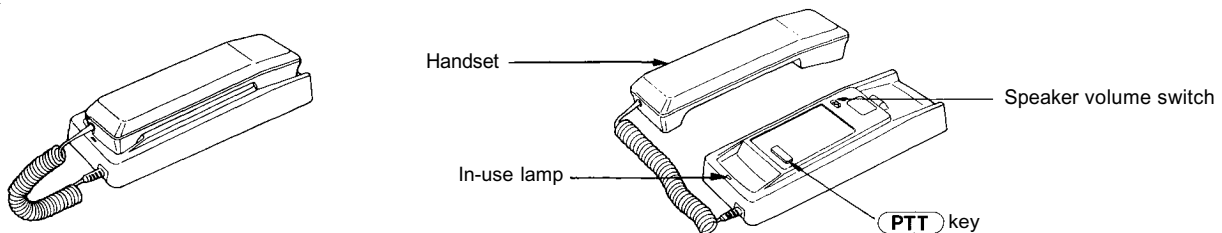

#### < Making a call >

1. Picking up the handset makes a call to the designated station.
2. Start conversation after the calling tone stops.
3. When you hear a busy tone that indicates the party you call is on another line, you can camp on the line by simply waiting without hanging up the handset. As soon as the line becomes free, your call is automatically connected.
4. While the continuous calling tone is sent, you can break in on the calling tone by continuously depressing the **PTT** key to make a voice call through the station speaker of the called party.

5. Hang up the handset to terminate the conversation.

#### < Responding to a call >

6. When you are called by the continuous calling tone or paged through your station speaker, respond to the call by picking up the handset.

#### Note.

The sound volume of the calling tone may be adjusted by means of a 2-stage volume selector (SP. VOL) switch.

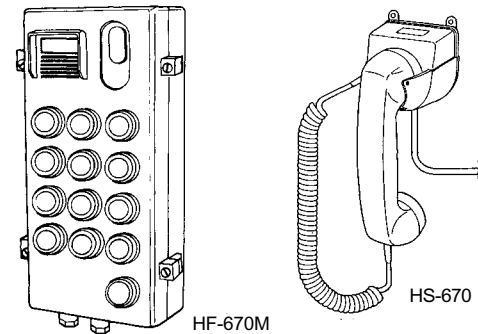
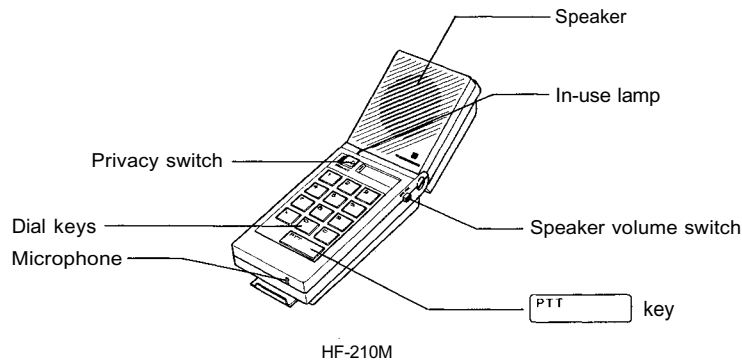
**< Making a call >**

1. Touch dial the station number you wish to call, regardless of whether the Privacy switch of your station is in the ON position or OFF position.
2. Start conversation after the calling tone stops.
3. When the line is busy, a busy tone is heard and you can camp on the line by simply waiting. As soon as the line becomes free, your call is automatically connected.
4. During a call attempt made by means of the continuous calling tone, you can break in on the calling tone by continuously depressing the **PTT** key to make a voice call through the station speaker of the called party.
5. When the party you call is in a high noise level area, your continuously depressing the **PTT** key allows one-way conversation to that party. As long as you depress the **PTT** key, your voice has dominance and releasing the **PTT** key will reverse the one-way conversation from that party to you.
6. To terminate the conversation, depress the **□** key.

**< Responding to a call >**

[Privacy switch is in the OFF.]

7. Respond to the call after the calling tone stops.

[Privacy switch is in the ON.]

8. The continuous calling tone function is made available to any station if its Privacy switch is placed in the ON position. Depressing any key ( **1**~**9**, **□**, **□**, **□** ) other than the **PTT** key causes the continuous calling tone to stop and puts the station in the conversation mode.

**Note.**

1. The sound volume of the speaker may be adjusted by means of the 2-stage volume selector (VOL) switch.
2. With no speaker built inside, the HF-670M needs to be connected to an external speaker. Also, the HF-670M is fitted with no Privacy switch.
3. When the HF-670M is connected to the handset unit HS-670, lifting up the handset responds to call.



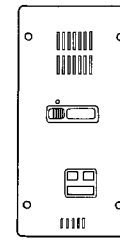
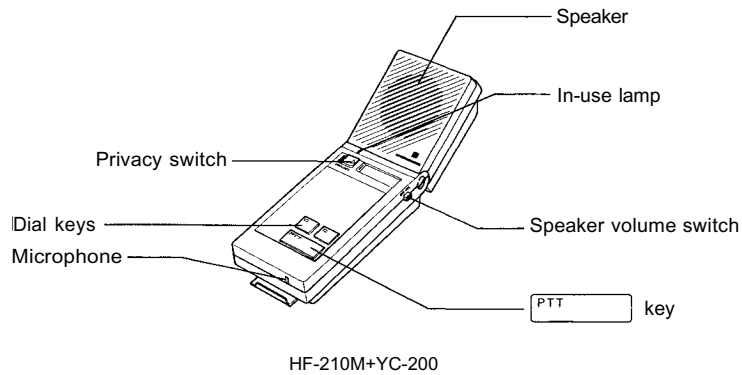

## &lt; Making a call &gt;

1. Touching the  key makes a call to the designated other station whether the Privacy switch on your station is in the ON position or OFF position.
2. Start conversation after the calling tone stops.
3. When the line is busy, a busy tone is heard and you can camp on the line by simply waiting. As soon as the line becomes free, your call is automatically connected.
4. During a call attempt made by means of the continuous calling tone, you can break in on the calling tone by continuously depressing the  key to make a voice call through the station speaker of the called party.
5. When the party you call is in a high noise level area, your continuously depressing the  key allows one-way conversation to that party. As long as you depress the  key, your voice has dominance and releasing the  key will reverse the one-way conversation from that party to you.
6. To terminate the conversation, depress the  key.

## &lt; Responding to a call &gt;

[Privacy switch is in the OFF.]

7. Respond to the call after the calling tone stops.

[Privacy switch is in the ON.]

8. The continuous calling tone function is made available to any station when its Privacy switch is in the ON position. Depressing the  or  key causes the continuous calling tone to stop and puts the station in the conversation mode.

**Note.**

1. The sound volume of the speaker may be adjusted by means of the 2-stage volume selector (VOL) switch.
2. The No.200 programming (Master/Sub relationship) must be performed in the exchange to call a specified master station.

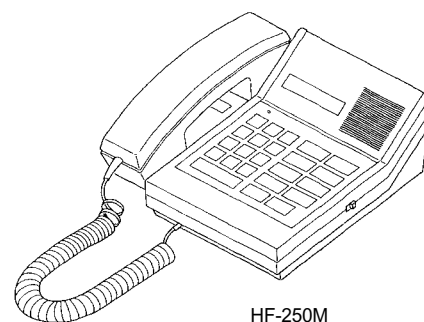
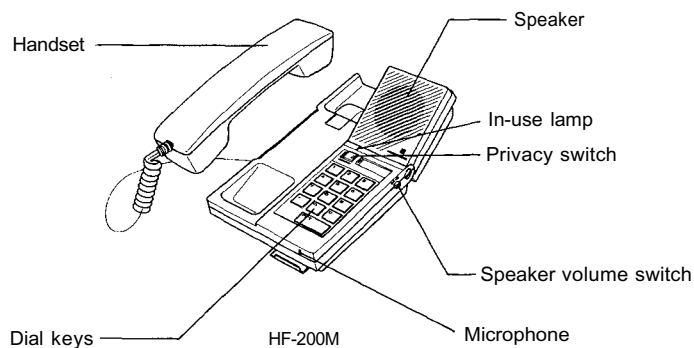

### < Making a call >

1. Hands-free conversation may be made by simply touch dialing the station number you wish to call.
2. When you wish to use the handset, pick it up, then touch dial the station number you wish to call, or reverse the order.
3. Start conversation after the calling tone stops.
4. When you hear a busy tone that indicates the party you call is on another line, you can camp on the line by simply waiting. As soon as the line becomes free, your call is automatically connected.
5. In the event that the party you are calling does not respond and the continuous calling tone is still heard from your station, you can break in on the calling tone by continuously depressing the **(PTT)** key to make a voice call through the station speaker of the called party.
6. During hands-free conversation, when the person you are talking to is in a high noise level area,
  - (1) Pick up the handset to talk or (2) depress the **(PTT)** key continuously for one-way conversation to that party. As long as the **(PTT)** key is depressed, your voice has dominance, and releasing the **(PTT)** key will reverse the one-way conversation from that party to you.
7. To terminate the conversation, hang up the handset or depress the **(□)** key.

### < Responding to a call >

- [Privacy switch is in the OFF.]
8. Respond to call after the calling tone stops.  
[Privacy switch is in the ON.]
  9. The continuous calling tone function is made available to any station when its Privacy switch is in the ON position. Depressing any key ( **(1~9)** , **(□)** , **(□)** or **(□)** ) other than the **(PTT)** key or picking up the handset of the station called causes the continuous calling tone to stop and puts the station in the conversation mode.

#### Note.

The sound volume of the loud speaker may be adjusted by means of the 2-stage volume selector (VOL) switch.

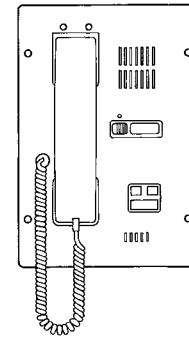
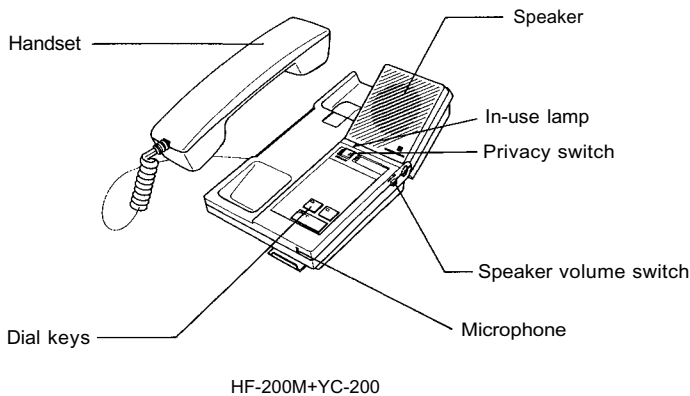
**< Making a call >**

1. For hands-free conversation, touching the  key makes a call to the designated other station regardless of whether the Privacy switch on your station is in the ON position or OFF position.

[Privacy switch is in the OFF.]

2. When you wish to use the handset, pick it up, then touch dial the  key to make a call or reverse the order.

[Privacy switch is in the ON.]



3. Picking up the handset makes a call to the designated other station.
4. Start conversation after the calling tone stops.
5. When you hear a busy tone that indicates the party you call is on another line, you can camp on the line by simply waiting. As soon as the line becomes free, your call is automatically connected.
6. In the event that the party you are calling does not respond and the continuous calling tone is still heard from your station, you can break in on the calling tone by continuously depressing the **PTT** key to make a voice call through the station speaker of the called party.
7. During hands-free conversation, when the person you are talking to is in a high noise level area,
  - (1) Pick up the handset to talk or (2) depress the **PTT** key continuously for one-way conversation to that party. As long as the **PTT** key is depressed, your voice has dominance, and releasing the **PTT** key will reverse the one-way conversation from that party to you.
8. To terminate the conversation, hang up the handset or depress the  key.

**< Responding to a call >**

[Privacy switch is in the OFF.]

9. Respond to call after the calling tone stops.

[Privacy switch is in the ON.]

10. The continuous calling tone function is made available to any station when its Privacy switch is in the ON position. Depressing the  or  key or picking up the handset of the station called causes the continuous calling tone to stop and puts the station in the conversation mode.

**Note.**

1. The sound volume of the loud speaker may be adjusted by means of the 2-stage volume selector (VOL) switch.
2. The No.200 programming (Master/Sub relationship) must be performed in the exchange to call a specified master station.

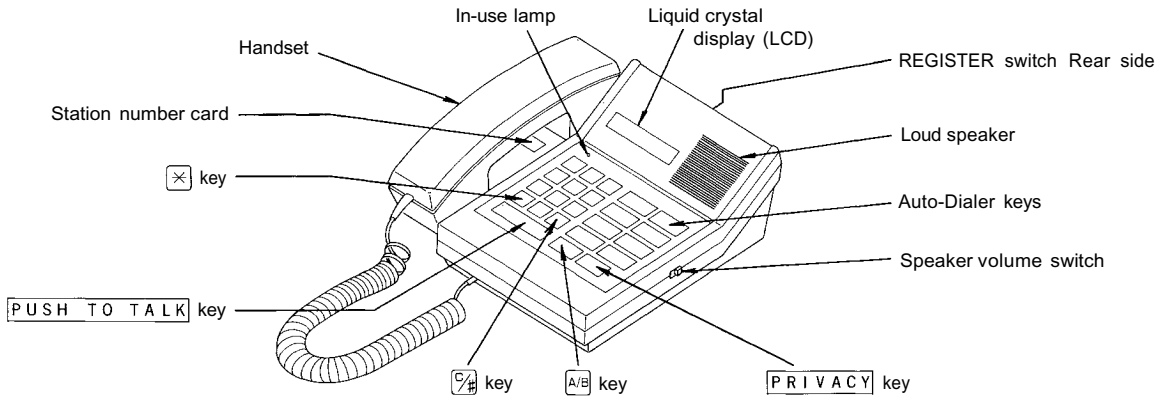

**< Making a call >**

1. Place the auto-dialer registration (REGISTER) switch in the OFF position.
2. 16 registrations are possible with 8 keys by changing over the A/B page selection key. You can call any one of pre-registered stations by touch-dialing the auto-dialer key.
3. For making a call and responding to a call without using the auto-dialer, refer to "5) Hands-free/Handset Master Station HF-200M/200MB/250M (With Auto-Dialer)"

**< Auto-dialer registration >**

Two station numbers can be registered by each auto-dialer key.

Operation

1. Switch the (REGISTER) switch ON.

**Indication on the liquid crystal display**

With DT - E70 or  
W/o DT - E70

2. Press the (PTT) key until PROGRAM - dial is appeared on the LCD display. Press it three times for With DT - E70 and twice for W/o DT - E70
3. Press the auto-dialer key (A<sub>1</sub> ~ A<sub>8</sub>, B<sub>1</sub> ~ B<sub>8</sub>) to select the station number to be registered.

**Indication on the liquid crystal display.**

A 1 :  
B 1 :

4. Press the A/B page selector key to select either A or B page.
5. Station numbers can be consecutively registered by maximum 50 digits using the dial keys.

**Indication on the liquid crystal display.**

A 1 : 1 2 3 4 5 6 7 8 9

6. Press the (PTT) key, and the dialled numbers are memorized.
7. Repeat steps (3) through (6) to register other station numbers.
8. Switch the (REGISTER) switch OFF after completing registration.

**< Liquid crystal display >**

- A. Indication on the liquid crystal display in conjunction with the DT-E70 is changed with three status.

1. When waiting  
Privacy mode status, page selection and time indication

P V A 1 0 : 3 6 a m

Displays "PV" status when the privacy key is set to ON.  
Displays either A or B page of the autodialer.

2. When dialling for paging

Dial monitor indication

\* 8 0 0

3. When responding to a call

2 3 5 : 2 3 ' 6 1

Calling station number  
Waiting station number  
Number of waiting stations

Note. For detailed indication mode, refer to "Calling Party Indication (Numerical Type)"

- B. Indication on the liquid crystal display is changed into two status when the HF-250M is used solely.

P V A 2 0 1

His-own-station number

1. When waiting  
Privacy mode status, page selection and his-own-station number

2. When dialling for paging

Dial monitor indication

\* 8 0 0

Note. For registration to use the liquid crystal display, refer to "Operating Instructions of the HF-250M and DT-E70".

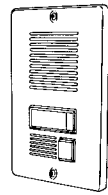

HF-640S

**< Making a call >**

1. Pressing a button calls the specified master station.
2. Speak when a calling tone stops.
3. When a busy tone is heard, simply wait. You are put through the master station as soon as its line is freed.
4. If there is no response even after a calling tone has stopped, press the button again and again. The calling tone is sounded each time the button is pressed.
5. Conversation or continuous calling tone is terminated unless the button is pressed every 30 seconds.

**Note.**

1. Making a call from the door station to the master station having its Privacy switch in ON transmits a brief calling tone to the door station only twice, while transmitting a continuous calling tone to the master station.
2. The No.200 programming (Master/Sub relationship) must be performed in the exchange to call a specified master station.

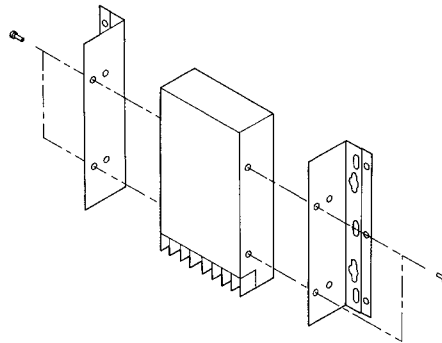
**9) Talk-back unit Model TK-20****< Making a call >****[When calling with the audio trigger function]**

When the sound into the speaker exceeds the preset volume, the specified master station is called.

**[When calling with the call switch]**

1. Pressing the talk-back station call switch calls the specified master station.
2. Talk to the specified master station after a calling tone is terminated.
3. Simply wait after a busy tone (intermittent single tone) is heard.  
As soon as the called station's line becomes free, your call is automatically connected.

**Note.** Be sure to set the audio trigger selector switch on the talk-back unit to ON.

**<Responding to a call>**

1. Talk to the specified master station after a calling tone is terminated.

**Note.** The No.200 programming (Master/Sub relationship) must be performed in the exchange to call a specified master station.

# Functions: EXES-6000 CP-66

No.	Classification	Function	Standard Function	Selectable Function		Optional Function	Single Exchange	Tie-line			
				By DIP Switch	By No. 200 Programming			Own Exchange	Outside Exchange	TI-600 Exchange	
1		Camp-On-Busy	○				○	○	○	○	
2		Busy call back	○				○	○	○	×	
3		Mic-Off	○				○	×	×	○	
4	Single Digit	Single Digit Dialing	○				○	○	○	○	
5		Automatic Access to Paging			○		○	○	○	○	
6		Master/Sub Relationship			○		○	○	×	×	
7	Continuous Calling Tone	Privacy-Camp-On-Privacy/Continuous Calling Tone at Privacy Mode *1		○			○	○	○	○	
8		Continuous Calling Tone-One-touch Response *2			○		○	○	○	○	
9	PTT	Press-To-Talk	○				○	○	○	○	
10		Press-To-Talk Control			○*3		○	○	×	×	
11	Personal Number	Personal Number Call			○*4		○	○	○	○	
12		Personal Number Paging			○		○	○	×	×	
13	Transfer	Remote Response	○				○	○	×	—	
14		Call Transfer-Paging during Normal call			○		(○)*5	○	○	×	
15		Group Hunting				○		○	○	×	
16		Secretary Transfer				○		○	○	×	
17		Call Forwarding			○			○	×	×	
18	Priority	Priority					○	×	×	○	
19		Executive Priority			○	○		○*6	×	×	
20		Highest Executive Priority						○*6	○	○	
21	Conference	Conference			○		○	○	○	○	
22	Paging and Response	PA Paging-Station Paging *7			○	(○)*5	○	○	○	○	
23		Combination Paging				○	○	○	×	×	
24		Emergency All-Call			○		○	○	×	×	
25		Paging Priority			○	○	○	○	×	×	
26	Selection of Dial Operation	Selectable numbering digit			○	○	○	○	○	—	
27		Selectable First Station Number of Each Exchange			○	○	○	○	○	○	
28		Output Capacity of Paging Zone			○			○	—	—	
29		Selectable Dial Operation for Paging Response			○			○	○	○*9	
30		Output Capacity of General Purpose Control			○			○	○	×	
31		Programmable Station Numbering				○		○	○	○*10	
32	Restricted Access Group	Selectable function operation			○		○	—	—	—	
33		Group Blocking (Restricted Dialing)				○		○	○	○	
		Restricted Access to All-Call Paging				○		○	○	○	
		Zone paging				○		○	○	○	
		Restricted Access to Conference				○		○	○	○	
		Restricted Access to General Purpose Control	One-shot make output			○					
			Make/break output				○				
	8 selectable one-shot make output 8 selectable make output/Decimal output 4 decimal digits output					○		○	○	×	
34	Selection	Calling Tone-paging Pre-paging Tone Duration *11				○	○	○	○	○	
35		Time out of Conversation and Paging Call				○		○	○	○	
36	Interface	IN/OUT Annunciation				○*4		○	○	○	
37		Destination Annunciation Indication					○	○	×	×	
38		Calling Party Indication (Lamp type) (with/without memory)			○*12	○		○	○	×	
39		Calling Party Indication (Numerical type)						○	×	×	
40		Station called indicator (Lamp Type)			○		○	○	○	×	
41		Pager			○	○	○	○	○	×	
42	General Purpose Control	One-shot make output									
		Make/break output									
		8 selectable one-shot make output			○			○	○	×	
		8 selectable make output/Decimal output									
		4 decimal digits output									
43		Speech message				○	○	○	○	○	
44		Pager calling and responding				○	○	○	○	—	
45		BGM				○	○	○	—	—	
46		Alarm and time signal				○	○	○	—	—	
47		Selectable paging			○		○	○	○	○	

## Functions: EXES-6000 CP-66

### Notes.

1. XX/YY indicates to select either XX (Function) or YY (Function).
2. Not all circles (○) in The Switch Selection table correspond to the DIP switches of the CP unit.
- \*1: "PV" (system with Privacy function) Type: with the Privacy switch in the ON position, a brief Privacy Tone sounds.  
"NP" (system without Privacy function) Type: A station may be called by the continuous calling tone when the Privacy switch is placed in the ON position.
- \*2: When a hands-free station without handset is called by the continuous calling tone, conversation may start by touching any key (☐~☐, ☐ or ☐).
- \*3: Using the Press-to-talk control function reduces the maximum number of paging zone to All call + 23 zones (7 zones).
- \*4: This function may not be used if numbers 100 through 199 are used in the Station Numbering Schedule. Either "Personal number call" or "Personal number paging" may be selected.
- \*5: Additional equipment is required for paging.
- \*6: Either "Executive Priority" or "Highest Executive Priority" may be selected.
- \*7: Each zone of paging provides Station paging and/or PA paging.
- \*8: It is necessary to respond only by dialing ☐ ☐ (with-out zone No.).
- \*9: It is possible to make a paging call and its response between the local exchange and the remote extension exchange. However, a response to the zone paging is possible only from a station connected to the exchange having the paged zone.
- \*10: Station numbers of each exchange can be changed freely within the range of "Selectable numbering schedule of each exchange".
- \*11: Calling tone: 0.3 sec (Trill note tone)/0.2 sec (Single note tone)/none.  
Paging pre-paging tone: 2 sec/1 sec/none.
- \*12: Selects whether or not the indication of the calling party station continuously lights up, after the calling party has cancelled the call to a line which is busy or in the privacy mode.

## Chapter 2

Functions and operating procedures of single exchange system



## EXES-6000 CP-66 — Summary of Dialing Operations (single exchange system)

### 1. Selecting dial operations

The EXES-6000 Intercom system allows digit-dialing operations to be minimized depending on the number of stations and their functions. Four types of dialing operations (Type 1, Type 2, Type 3, and Type 4) are available. Select the most suitable type by changing the setting of the internal switch at the exchange. The following explanations describe the dialing operation when the switch is set for Type 2. For other types, check the dial operation while referring to the attached lists.

#### [Four types of dialing operations]

Type	Feature	Numbering plan
Type 1	Three-digit dialing Standard type Maximum of 128 stations (without paging) Maximum of 120 stations (with all station call + 7-zone paging)	Standard type No. 200 ~ 327 No. 100 ~ 227) Station number conversion No. 200 ~ 399 (No. 100 ~ 399)
Type 2	Three-digit dialing Station number conversion Maximum of 256 stations	Standard type No. 200 ~ 455 (No. 100 ~ 355) Station number conversion No. 200 ~ 999 (No. 100 ~ 999)
Type 3	Two-digit dialing Full paging function Maximum of 70 stations (with/without paging)	Standard/station number conversion No. 20 ~ 79 (No. 10 ~ 79)
Type 4	Two-digit dialing Maximum of 90 stations (with/without paging)	Standard/station conversion No. 20 ~ 99 (No. 10 ~ 99)

Classification	(Type 1) Three-digit dialing, standard type, 128 stations (No. 200 through 327, No. 100 through 227)		(Type 2) Three-digit dialing, station number conversion, 256 stations (No. 200 through 999, No. 100 through 999)		(Type 3) Two-digit dialing, full paging function, 60 stations (No. 20 through 79, No. 10 through 79)		(Type 4) Two-digit dialing, 60 stations (No. 20 through 99, No. 10 through 99)	
	Function	Dialing operation	Number assignment	Dialing operation	Number assignment	Dialing operation	Number assignment	Dialing operation
Press-to-talk	<input type="checkbox"/> PTT One-way conversation <input checked="" type="checkbox"/> Two-way conversation		<input type="checkbox"/> PTT One-way conversation <input checked="" type="checkbox"/> Two-way conversation		<input type="checkbox"/> PTT One-way conversation <input checked="" type="checkbox"/> Two-way conversation		<input type="checkbox"/> PTT One-way conversation <input checked="" type="checkbox"/> Two-way conversation	
Remote response			<input type="checkbox"/> PTT					
Remote response registration	<input checked="" type="checkbox"/> PTT <input type="checkbox"/> <input type="checkbox"/> <input type="checkbox"/> Confirmation tone <input type="checkbox"/> <input type="checkbox"/> <input type="checkbox"/> : Station No.	<input checked="" type="checkbox"/> PTT <input type="checkbox"/> <input type="checkbox"/> <input type="checkbox"/> Confirmation tone <input type="checkbox"/> <input type="checkbox"/> <input type="checkbox"/> : Station No.	<input checked="" type="checkbox"/> PTT <input type="checkbox"/> <input type="checkbox"/> <input type="checkbox"/> Confirmation tone <input type="checkbox"/> <input type="checkbox"/> <input type="checkbox"/> : Station No.	<input checked="" type="checkbox"/> PTT <input type="checkbox"/> <input type="checkbox"/> <input type="checkbox"/> Confirmation tone <input type="checkbox"/> <input type="checkbox"/> <input type="checkbox"/> : Station No.	<input checked="" type="checkbox"/> PTT <input type="checkbox"/> <input type="checkbox"/> <input type="checkbox"/> Confirmation tone <input type="checkbox"/> <input type="checkbox"/> <input type="checkbox"/> : Station No.	<input checked="" type="checkbox"/> PTT <input type="checkbox"/> <input type="checkbox"/> <input type="checkbox"/> Confirmation tone <input type="checkbox"/> <input type="checkbox"/> <input type="checkbox"/> : Station No.	<input checked="" type="checkbox"/> PTT <input type="checkbox"/> <input type="checkbox"/> <input type="checkbox"/> Confirmation tone <input type="checkbox"/> <input type="checkbox"/> <input type="checkbox"/> : Station No.	<input checked="" type="checkbox"/> PTT <input type="checkbox"/> <input type="checkbox"/> <input type="checkbox"/> Confirmation tone <input type="checkbox"/> <input type="checkbox"/> <input type="checkbox"/> : Station No.
Continuous calling tone			<input type="checkbox"/> 1~9, <input type="checkbox"/> 0, <input type="checkbox"/> *, or <input type="checkbox"/> #					
Privacy			PRIVACY <input type="checkbox"/> ON Privacy OFF <input type="checkbox"/> ON					
Secretary transfer			PRIVACY <input type="checkbox"/> ON Secretary transfer OFF <input type="checkbox"/> ON					
Single-digit registration	<input type="checkbox"/> <input type="checkbox"/> <input type="checkbox"/> • • <input type="checkbox"/> ( PTT ) Confirmation tone Registration dial (maximum 6digits)	<input type="checkbox"/> <input type="checkbox"/> <input type="checkbox"/> • • <input type="checkbox"/> ( PTT ) Confirmation tone Registration dial (maximum 6digits)	<input type="checkbox"/> <input type="checkbox"/> <input type="checkbox"/> • • <input type="checkbox"/> ( PTT ) Confirmation tone Registration dial (maximum 6digits)	<input type="checkbox"/> <input type="checkbox"/> <input type="checkbox"/> • • <input type="checkbox"/> ( PTT ) Confirmation tone Registration dial (maximum 6digits)	<input type="checkbox"/> <input type="checkbox"/> <input type="checkbox"/> • • <input type="checkbox"/> ( PTT ) Confirmation tone Registration dial (maximum 6digits)	<input type="checkbox"/> <input type="checkbox"/> <input type="checkbox"/> • • <input type="checkbox"/> ( PTT ) Confirmation tone Registration dial (maximum 6digits)	<input type="checkbox"/> <input type="checkbox"/> <input type="checkbox"/> • • <input type="checkbox"/> ( PTT ) Confirmation tone Registration dial (maximum 6digits)	<input type="checkbox"/> <input type="checkbox"/> <input type="checkbox"/> • • <input type="checkbox"/> ( PTT ) Confirmation tone Registration dial (maximum 6digits)
Single-digit dialing			<input type="checkbox"/>					
Personal number cancellation In/out indicator lamp ON	<input checked="" type="checkbox"/> 1 <input type="checkbox"/> <input type="checkbox"/> <input type="checkbox"/> <input type="checkbox"/> Confirmation tone Personal No.	<input type="checkbox"/> <input type="checkbox"/> <input type="checkbox"/> <input type="checkbox"/> : 1000 ~1999	<input checked="" type="checkbox"/> 1 <input type="checkbox"/> <input type="checkbox"/> <input type="checkbox"/> <input type="checkbox"/> Confirmation tone Personal No.	<input checked="" type="checkbox"/> 1 <input type="checkbox"/> <input type="checkbox"/> <input type="checkbox"/> <input type="checkbox"/> Confirmation tone Personal No.	<input checked="" type="checkbox"/> 1 <input type="checkbox"/> <input type="checkbox"/> <input type="checkbox"/> <input type="checkbox"/> Confirmation tone Personal No.	<input checked="" type="checkbox"/> 1 <input type="checkbox"/> <input type="checkbox"/> <input type="checkbox"/> <input type="checkbox"/> Confirmation tone Personal No.	<input checked="" type="checkbox"/> 1 <input type="checkbox"/> <input type="checkbox"/> <input type="checkbox"/> <input type="checkbox"/> Confirmation tone Personal No.	<input checked="" type="checkbox"/> 1 <input type="checkbox"/> <input type="checkbox"/> <input type="checkbox"/> <input type="checkbox"/> Confirmation tone Personal No.
Personal number cancellation In/out indicator lamp OFF			<input checked="" type="checkbox"/> 1 <input type="checkbox"/> <input type="checkbox"/> <input type="checkbox"/> <input type="checkbox"/> Confirmation tone Personal No.				<input type="checkbox"/> <input type="checkbox"/> <input type="checkbox"/> <input type="checkbox"/> : 1000 ~1999	
Personal number call Personal number paging			<input type="checkbox"/> <input type="checkbox"/> <input type="checkbox"/> <input type="checkbox"/> Personal No.					
Conference	<input type="checkbox"/> <input type="checkbox"/> <input type="checkbox"/> <input type="checkbox"/> Calling <input type="checkbox"/> <input type="checkbox"/> <input type="checkbox"/> Calling	<input type="checkbox"/> <input type="checkbox"/> <input type="checkbox"/> : Station No., Personal No., Single-digit No.	<input checked="" type="checkbox"/> <input type="checkbox"/> <input type="checkbox"/> <input type="checkbox"/> Calling <input type="checkbox"/> <input type="checkbox"/> <input type="checkbox"/> Calling	<input type="checkbox"/> <input type="checkbox"/> <input type="checkbox"/> : Station No., Personal No., Single-digit No.	<input checked="" type="checkbox"/> <input type="checkbox"/> <input type="checkbox"/> <input type="checkbox"/> Calling <input type="checkbox"/> <input type="checkbox"/> <input type="checkbox"/> Calling	<input type="checkbox"/> <input type="checkbox"/> <input type="checkbox"/> : Station No., Personal No., Single-digit No.	<input type="checkbox"/> <input type="checkbox"/> <input type="checkbox"/> : Station No., Personal No., Single-digit No.	
Call forwarding registration	<input checked="" type="checkbox"/> <input type="checkbox"/> <input type="checkbox"/> <input type="checkbox"/> Confirmation tone Confirmation tone	<input type="checkbox"/> <input type="checkbox"/> <input type="checkbox"/> : Station receiving transferred message	<input checked="" type="checkbox"/> <input type="checkbox"/> <input type="checkbox"/> <input type="checkbox"/> Confirmation tone Confirmation tone	<input type="checkbox"/> <input type="checkbox"/> <input type="checkbox"/> : Station receiving transferred message	<input checked="" type="checkbox"/> <input type="checkbox"/> <input type="checkbox"/> <input type="checkbox"/> Confirmation tone Confirmation tone	<input type="checkbox"/> <input type="checkbox"/> <input type="checkbox"/> : Station receiving transferred message	<input type="checkbox"/> <input type="checkbox"/> <input type="checkbox"/> : Station receiving transferred message	

Classification	(Type 1) Three-digit dialing, standard type, 128 stations (No. 200 through 327, No. 100 through 227)		(Type 2) Three-digit dialing, station number conversion, 256 stations (No. 200 through 999, No. 100 through 999)		(Type 3) Two-digit dial, full paging function, 60 stations (No. 20 through 79, No. 10 through 79)		(Type 4) Two-digit dialing, 60 stations (No. 20 through 99, No. 10 through 99)			
	Function	Dialing operation	Number assignment	Dialing operation	Number assignment	Dialing operation	Number assignment	Dialing operation	Number assignment	
Call	Conference clear	□ □								
	Mic. off	□		□ □						
	Busy call back registration	□ □ □ Busy tone □ Confirmation tone			□ □ □ : Station No., Personal No. Single-digit No.		□ □ Busy tone □ Confirmation tone		□ □ : Station No. Personal No. Single-digit No.	
	Busy call-back response	Busy call-back tone □ □ □ or □ □ □								
	Priority/priority response	□ □ □ Busy tone □ Interrupting tone Called station □			□ □ □ : Station No. Personal No. Single-digit No.		□ □ Busy tone □ Interrupting tone Called station □		□ □ : Station No. Personal No. Single-digit No.	
	Executive priority	Interrupting tone □								
	Highest executive priority	Interruption tone □								
	Call transfer	□ □ □ Call/conversation → □ Transfer → □ □ Conversation with original station			□ □ □ : Station No. Personal No. Single-digit No.		□ □ Call/conversation → □ Transfer → □ □ Conversation with original station		□ □ : Station No. Personal No. Single-digit No.	
Paging	All call + 7-zone paging	□ □	□ : 0 All station calls 1 through 7 (zones)	□ □ □	□ : 0 All station calls 1 through 7 (zones)	□ □	□ : 0 All station calls 1 through 7 (zones)	□ □ □	□ : 0 All station calls 1 through 7 (zones)	
	All call + 31-zone paging	□ □ □	□ □ : 00 All station calls 01 through 31 (zones)	□ □ □ □	□ □ : 00 All station calls 01 through 31 (zones)	□ □ □	□ □ : 00 All station calls 01 through 31 (zones)	□ □ □ □	□ □ : 00 All station calls 01 through 31 (zones)	
	Combination paging	□ □ □	□ □ : 80~99 Zone combination: 20	□ □ □ □	□ □ : 80~99 Zone combination: 20	□ □ □	□ □ : 80~99 Zone combination: 20	□ □ □ □	□ □ : 80~99 Zone combination: 20	
	All call paging response	□ □ or □ □ □ □								
	Zone paging response	□ or □ □ □	□ : 1~7 □ □ : 01~31 80~99	□ □ or □ □ □ □	□ : 1~7 □ □ : 01~31 80~99	□ or □ □ □	□ : 1~7 □ □ : 01~31 80~99	□ □ or □ □ □ □	□ : 1~7 □ □ : 01~31 80~99	
Paging transfer	Conversation □ □ Paging ⇒ Conversation after answer □ Transfer □ □ Conversation with original station	□ : 0~7 (00~31) 80~99	Conversation □ □ □ Paging ⇒ Conversation after answer □ Transfer □ □ Conversation with original station	□ : 0~7 (00~31) 80~99	Conversation □ □ Paging ⇒ Conversation after answer □ Transfer □ □ Conversation with original station	□ : 0~7 (00~31) 80~99	Conversation □ □ □ Paging ⇒ Conversation after answer □ Transfer □ □ Conversation with original station	□ : 0~7 (00~31) 80~99		

Classification	(Type 1) Three-digit dialing, standard type, 128 stations (No. 200 through 327, No. 100 through 227)		(Type 2) Three-digit dialing, station number conversion, 256 stations (No. 200 through 999, No. 100 through 999)		(Type 3) Two-digit dialing, full paging function, 60 stations (No. 20 through 79, No. 10 through 79)		(Type 4) Two-digit dialing, 60 stations (No. 20 through 99, No. 10 through 99)			
	Function	Dialing operation	Number assignment	Dialing operation	Number assignment	Dialing operation	Number assignment	Dialing operation	Number assignment	
Display and Control (Data transmitting and receiving unit)	One-shot, relay-connection output	□ 3 (X) X X							X X : 00~49 X X X : 000~499	
	Relay connection/ disconnection output	□ 3 5 (X) X X    Confirmation tone □ 3 6 (X) X X    Confirmation tone							X X : 00~99 X X X : 000~511	
	8-selectable, one-shot, relay connection output	□ 3 7 X Y    Confirmation tone							X : 1 ~ 9 Y : 1 ~ 8	
	8-selectable output (Decimal output)	□ 3 8 (X) X Y    Confirmation tone							X : 1 ~ 9 X X : 01~64 Y : 1~8, 0 (Clear) (X X : 01~99) (Y : 0 ~ 9)	
	4-digit decimal output	□ 3 9 X Y Y Y Y    Confirmation tone							X : 1 ~ 9 Y Y Y Y : 0000 ~ 9999	
	Pager call	7 (X X) X X	X X : 00~99 X X X : 000~999 X X X X : 0000 ~ 9999 X X X : Station No.	□ 7 (X X) X X					X X : 00~99 X X X : 000~999 X X X X : 0000 ~ 9999 X X X : Station No.	
	Pager response	4 (X X) X X	X X : 00~99 X X X : 000~999 X X X X : 0000 ~ 9999	□ 4 (X X) X X					X X : 00~99 X X X : 000~999 X X X X : 0000 ~ 9999	
	Calling station selection	9 X X X	X X X : Station No.	□ 9 X X X	X X X : Station No.	□ 9 X X		X X : Station No.		
	Message recording	□ □ 2 (8 sec) □ □ 3 (16 sec) □ □ 4 (32 sec)								
	Message check	□ □ 3								
Message playback	PRIVACY Ⓜ ON or □ □ 4									
Message cancellation	□ □ 6 Confirmation tone									
Remote message playback	□ □ 5 X X X		X X X : Station No.		□ □ 5 X X X		X X : Station No.			
Clearing calling party indication	□ □									
BGM	□ 2 X							X : Channel select		

## Camp-On-Busy

When the party you are calling is on another line, by simply waiting you automatically "Camp-On" the line. (Busy tone sounds continuously.) As soon as the line is freed, you will be automatically connected.

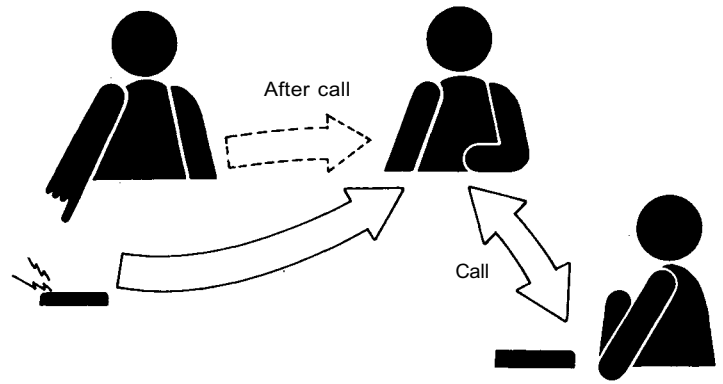

## Busy Call Back

When the called station is busy, dialing

**6**

permits this function to be registered and terminates the call after a confirmation tone. As soon as the line is freed, the calling party is called by the distinctive "busy-call-back" tone that sounds for 10 seconds. By one-touch dialing any one of **1**~**9**, **\*** or **#** key during the 10-second period, the calling party can be connected to the called party.

The disadvantage of the camp-on-busy function is that a link is occupied and busy tone is heard from your station all the way while you are waiting. This problem can be avoided by using the busy call back function that can improve the availability of speech paths as well as enables you to wait without being annoyed by "noisy" busy tone.

A maximum of 15 stations can be registered for this function. Once the function has been programmed into your station, you are put in the simple "busy waiting" mode even when you depress **6** in an attempt to register other busy stations for this function.

It is possible to make or receive other calls while waiting after this function has been programmed. However, if you are still using your station for conversation with the third party when the busy station registered for this function is freed, the registered busy call back function will be cancelled.

Camp-on-busy is prior to busy call back.

### • Registration

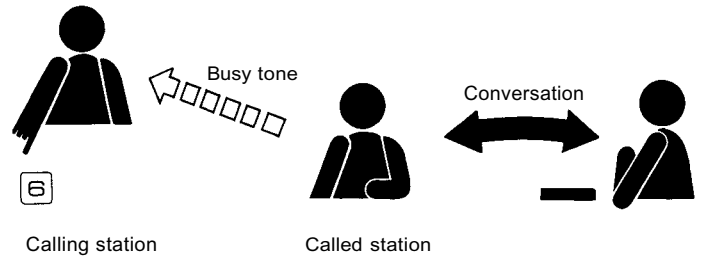

### • Line has been freed.

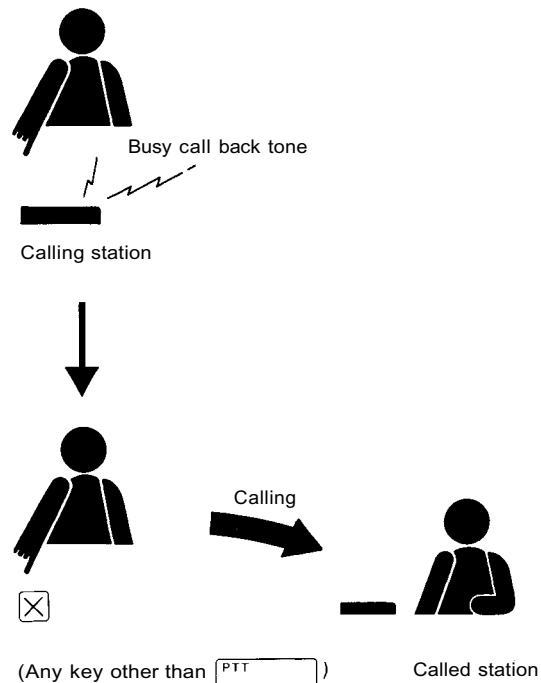

Shift Privacy Switch to ON.



When a party does not wish to accept incoming calls, this function may be employed to refuse them. With the Privacy switch in the ON position, a continuous privacy tone will be sounded in the station making the call, and at the same time, a brief Privacy tone will sound in the station called, indicating a call attempt is being made.

It is possible to call the other party from the station in the Privacy mode but Remote Response (PTT) is impossible from that station.

Shift Privacy Switch back to the left.



To restore a station in the "Privacy" mode to a normal condition, and thus ready to receive calls.

- Note:
1. A call received while the station is in the Privacy mode may be accepted if the Privacy function is immediately cancelled (see Camp-On Privacy)
  2. In the even of the station registered for the Secretary Transfer function, the Privacy switch is used on and off operation of the Secretary Transfer function. (see Secretary Transfer)
  3. During the above "Privacy" mode, while the calling station has the (PTT) bar is released, the privacy tone stops are the caller and transmit a one way message.  
When the (PTT) bar is released, the normal "Privacy" mode to be resumed.

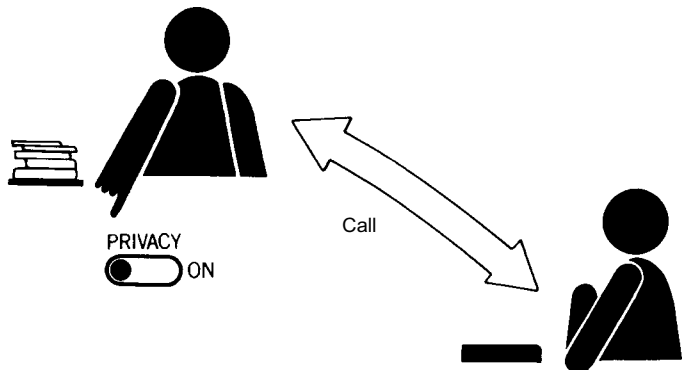
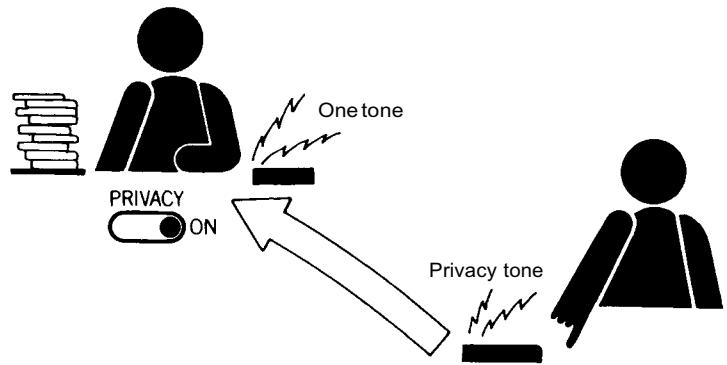

When the party you are calling has his station on Privacy mode, by simply waiting you will automatically "Camp-On" the line. (Privacy tone sounds continuously.) As soon as the Privacy mode is released, or as soon as he one-touch dials any of the keys (1~9, \*, #), or as soon as he picks up a handset of his station, you will be automatically connected.

This function is cancelled automatically if the station in the privacy mode may not accept the call within approximately 10 seconds.

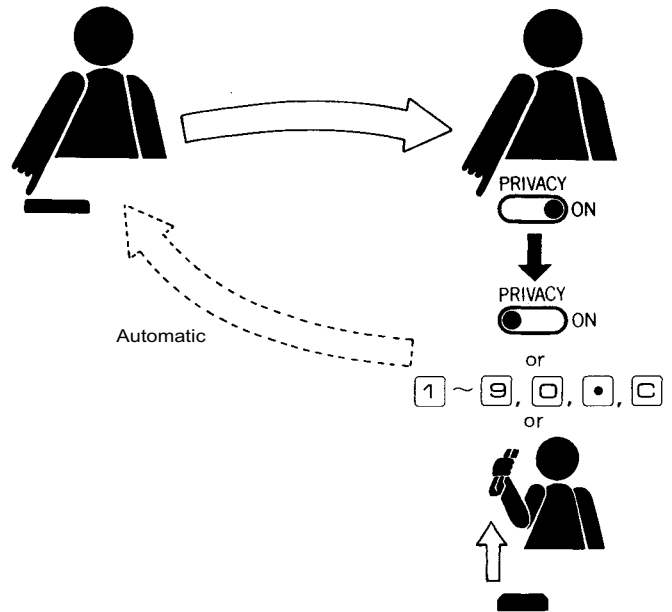

## Press-To-Talk

This function is activated when the

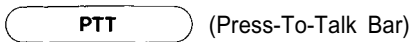

is continuously depressed after dial tone confirmation or during hands-free conversation. This allows one-way conversation from the party depressing the function key. When the key is released, one-way conversation is reversed.

Employ when a person in a high noise level area is called by a person in a quiet area, or when no particular response is required, or when simple announcements are made. In such cases, one-way conversation flow can be used.

One-way conversation is activated while the Press-To-Talk bar is continuously depressed.

As long as the Press-To-Talk bar is depressed by either party, the voice of the party using this function has dominance. When the key is released, the other party has dominance.

One-way conversation is reversed when the Press-To-Talk bar is released.

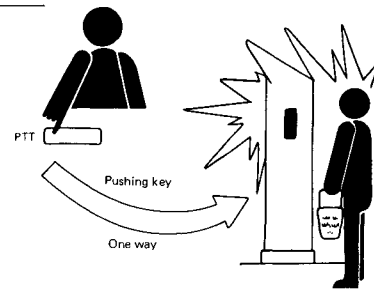

If both parties depress the Press-To-Talk bar, the voice of the party who depresses the bar last will have dominance.

Depress the



to return to ordinary hands-free 2-way conversation .....

### Note.

One-way conversation is impossible even if the **PTT** bar is depressed unless either party or both parties involved pick up a handset.

## Mic Off

Touch dialing of



during a conversation turns off that station's microphone.

This function is used when for one reason or another it is desirable to stop a conversation temporarily. With this function in use, the conversation is interrupted. A party on hold can use the Press-To-Talk function even during the Mic-off. Releasing the **PTT** key cause the Mic-off to be resumed.

Touch dialing



again cancels the Mic-Off function, and the conversation can be resumed.

When it is desirable to resume the conversation interrupted with the Mic-Off function, the function may be cancelled by the Party who operates the Mic-Off.

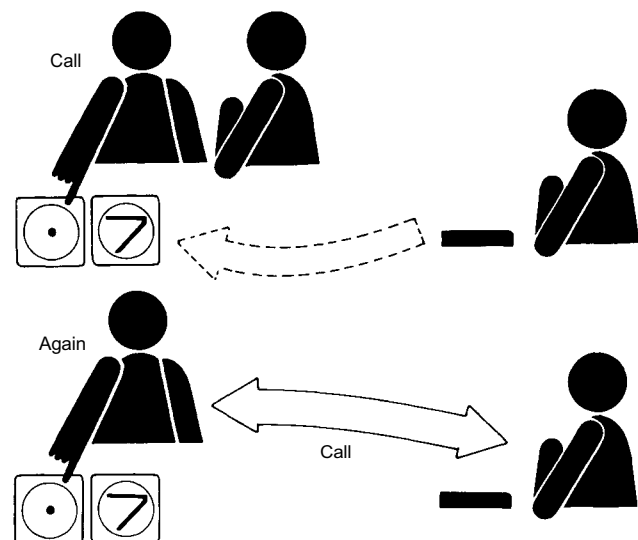

Touch dialing of  during a conversation turns off that station's microphone, and a holding tone is heard at both stations involved.

This function is used when for one reason or another it is desirable to stop a conversation temporarily. With this function in use, a holding tone is transmitted to both the calling and the called station while the conversation is interrupted.

Touch dialing  again cancels the Mic-Off function, and the conversation can be resumed.

When it is desirable to resume the conversation interrupted with the Mic-Off function, the function may be cancelled by the Party who operates the Mic-Off.

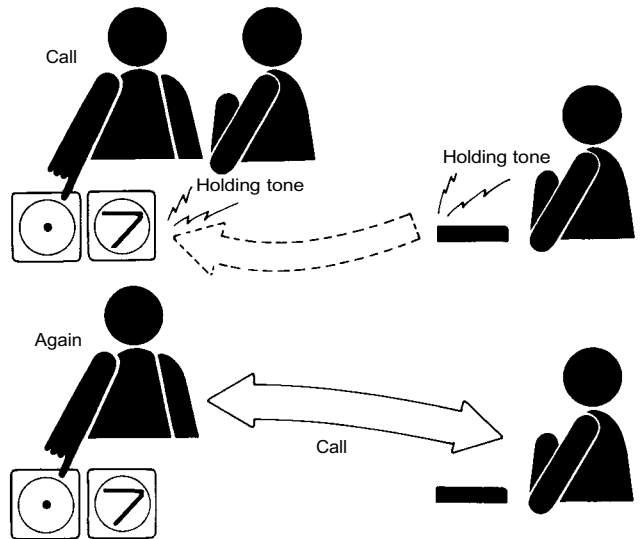

### Press-To-Talk Control

Touch dialing the specific station number. One way conversation is activated while the Press-To-Talk bar is continuously depressed, same as the Press-To-Talk (selected simplex) function, and a relay is activated with continuous make-contact. One way conversation is reversed when the Press-To-Talk bar is released, and the relay is activated with break-contact.

- Note.**
1. Stations No.200 through No.207 (8 stations) are the specific stations.
  2. It is possible to use a relay make output for Door Remote or for controlling Radio Transmitting/Receiving Equipment through user provided interface.
  3. The relay output of the Paging Interface Unit PI-62 is used for this purpose.
- Adaption of this function permits the paging of only all-call plus 23 zones (the paging of all-call + 31 zones is impossible.)

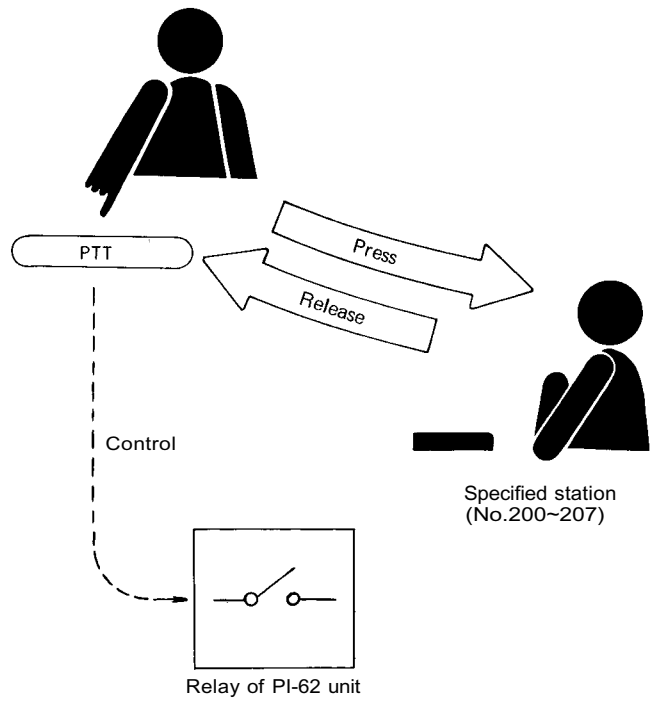



# Single Digit Dialing

## Single digit registration

Register in advance as follows:

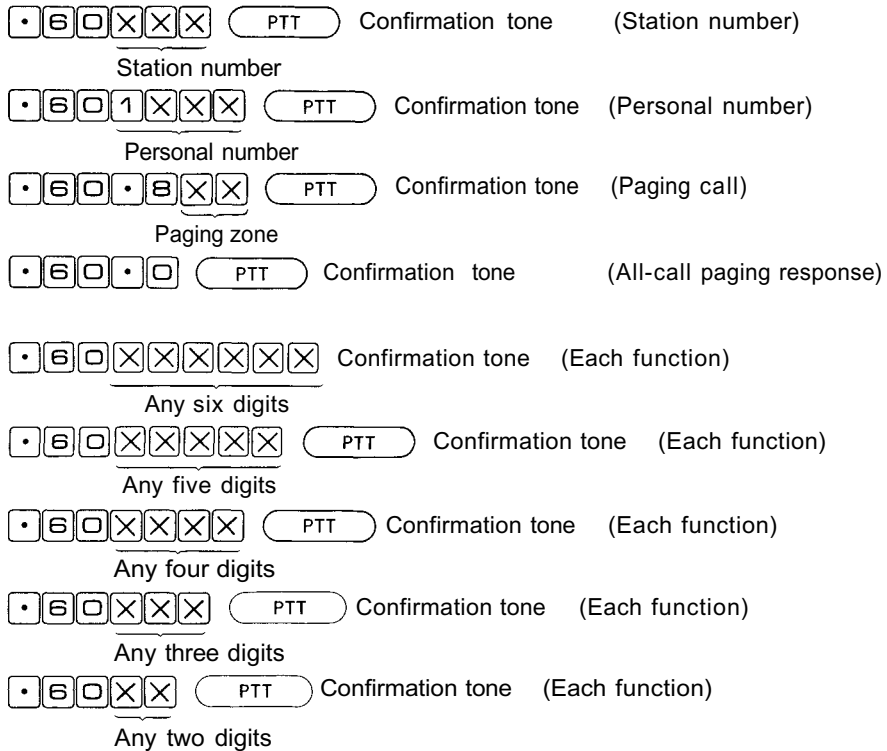

< Single digit dialing >

When required, dial



and the registered number will be called automatically.

- Note: 1. To cancel the registration, dial the station number of the station at which this functions has been registered.  
 2. It is also possible to use this function to shorten the long dial operation.

### Example

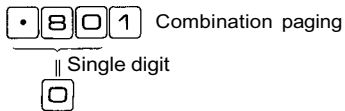

Simply dialing 0 1 makes the combination paging instead of dialing • 8 0 1 .

3. Single digit registration is not available from any substation programmed by No.200 programming, even if its line is connected with master station.

# Master Sub Relationship

Master/Substation associations are set up by using station #200 as the programming station. Once these relationships have been established, substations can then contact their designated master stations by simply touch dialing



If TL-600S Handset substation is used, it can be connected to its designated master stations by simply picking up a handset.

With respect to this function, the stations in the system are divided into two categories; master stations and substations. Any master station can be connected to any other station in the system. However, substations can initiate calls only to specific master stations. This is done by single touch dialing, and will only connect the substation to one specific master.

Also, one master station can have 2 or more substations.

To register this function, dial

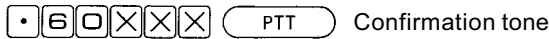

Substation No. paired off with the master

at the master station. This allows the master station to be connected to the substation when  is pressed.

**Note.**

Once a certain station number has been designated as a substation by No.200 programming, the single digit dialing is impossible even when the master station is connected to that number.

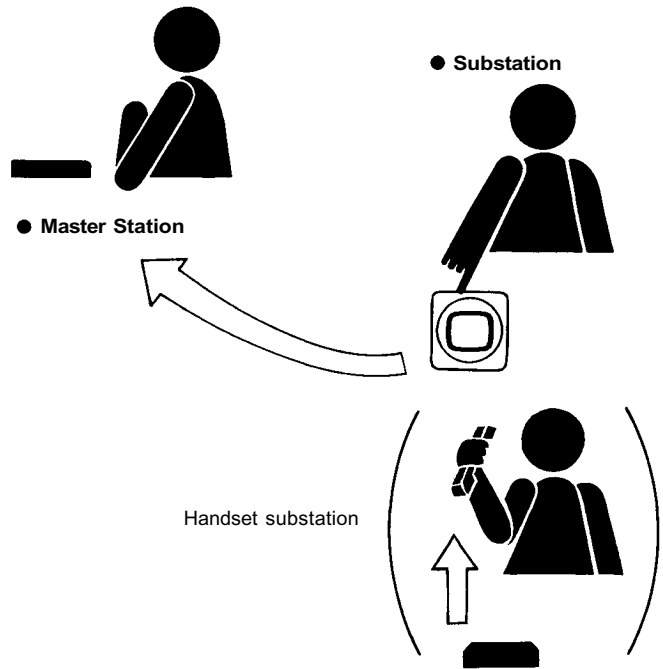

● Single Digit Registration of Substation

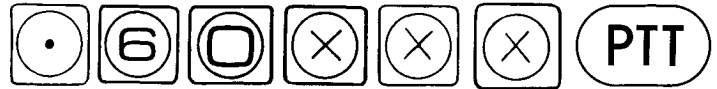

● Master Station

Substation Number

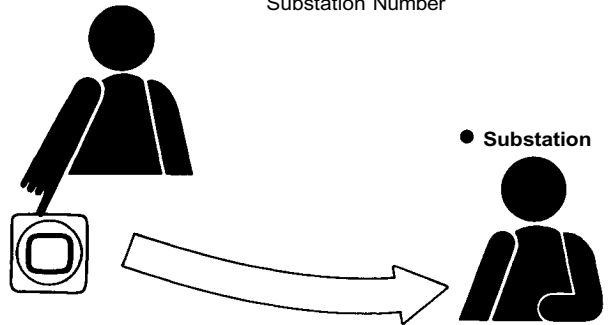

# Automatic Access To Paging

This function requires "single digit dialing registration for handset station" as well as No.200 programming at time of installation.

A paging call can be placed over the specified zone by simply lifting the handset.

A paging response is possible by simply lifting the handset.

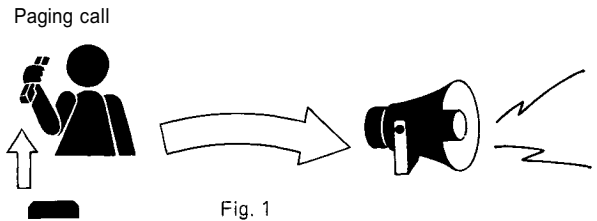

Fig. 1

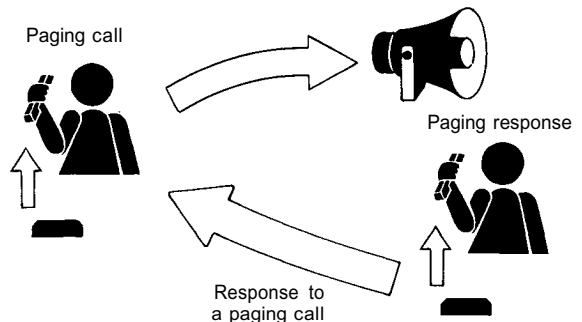

Fig. 2

# Personal Number Call

A personal number may be registered at any master station which the person to whom the number is assigned expects to be. A party wishing to receive personal number calls at a specific station may register his number at that station by touch dialing

• 6 1 X X X Confirmation tone

Personal Number.

Those who are frequently away from their assigned station, as well as those who share a single station may be assigned a "Personal" 4-digit number which may be programmed to any master station in the system. This personal number, which is completely independent of station numbers, may be programmed at any master station, and any previous programming of that same number at any other station is automatically cancelled. When the party calling has dialed the number to which he wishes to speak, the call is then routed to the station at which the Personal Number was last registered. The numbers which may be assigned in this group are 1000 through 1999.

Personal number program cancellation can be done at any station by merely dialing:

• • 1 X X X Confirmation tone

Personal Number

When anyone having a personal number leaves the office, he merely cancels the programming of his personal number. With the personal number cancelled, any incoming calls to that number will be answered by a dial tone, indicating that he is not available.

**Note.**

The maximum number of the Personal Number remains same even if the number of exchange to be connected is increased to 2 or 3.

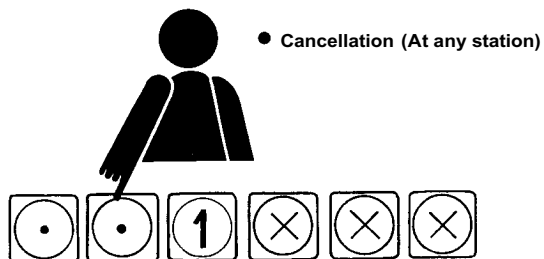
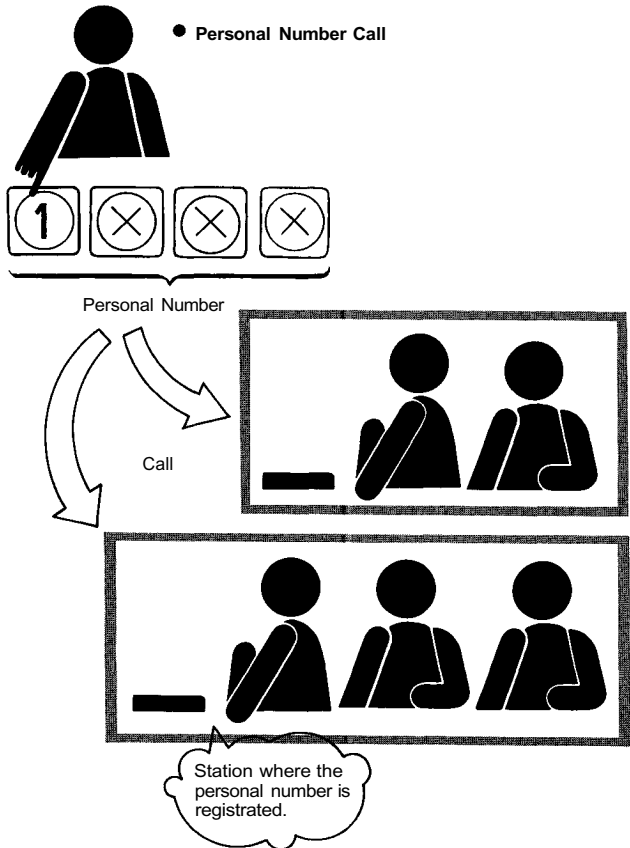
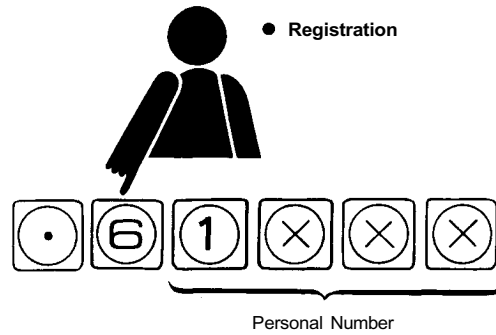

# Continuous Calling Tone

When there is an incoming call to the specified station, a calling tone is sounded continuously at the called station. The continuous calling tone stops if the called party presses

1 ~ 9, 0, \*, or # (Except PTT key)

1. Use this function when it is difficult to hear a brief single tone due to high background noise. Any station can be so made as to be called by the continuous calling tone, but No. 200 programming is required for such a station (refer to Installation Handbook for EXES-6000 CP-66).
2. If the calling party presses the PTT key while the continuous calling tone is being sounded, the continuous calling tone stops to allow the caller's voice call to go through. Releasing the PTT key restores the continuous calling tone.
3. If either party continuously presses the PTT key during the normal two-way conversation, this makes a one-way conversation from the party who pressed the PTT key. Releasing the PTT key reverses the one-way conversation flow and the other party has a dominance (Press-to-Talk).

### Notes.

1. In the NP type system that has no Privacy function, the station can be called by the continuous calling tone if its Privacy switch is set to ON. This function by No. 200 programming is, therefore, used in the PV type system having the Privacy function or for the HF-670M industrial type station equipped with no Privacy switch.
2. The following stations can be called by the continuous calling tone:
  - (1) Stations in the "NP" type system or specified substations in the "PV" type system.
  - (2) Stations registered for continuous calling tone by No. 200 programming.

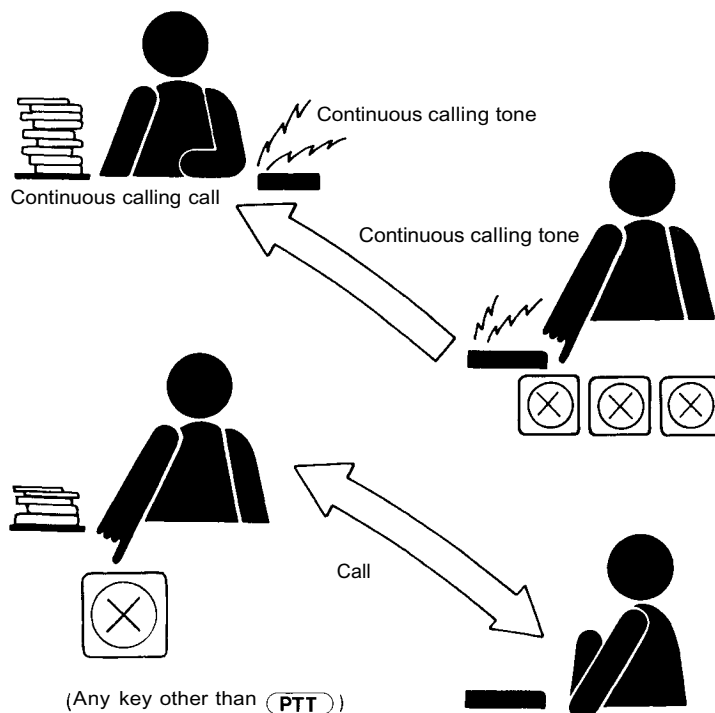

### < Station vs. calling tone >

Type of system	Type of station (Specific station provided with "continuous calling tone" function by station No.200 programming)	Type of calling tone	
		Privacy switch in OFF position	Privacy switch in ON position
"PV" Type	Non-programmed station (standard)	Single "trill" calling tone (Call is put through immediately after calling tone)	Privacy tone
	Programmed station	Continuous calling tone	Privacy tone
	Handset programmed station	—	Continuous calling tone
"NP" Type	Non-programmed station (standard)	Single "trill" calling tone (Call is put through immediately after calling tone)	Continuous calling tone
	Programmed station	Continuous calling tone	Continuous calling tone
Responding to a call made by continuous calling tone		Depress any dial key other than PTT key.	1. Depress only dial key other than PTT key. 2. Pick up a handset. 3. Shift Privacy switch to OFF.

# Remote Response

A call to a certain station can be remotely responded to from the other station by simply depressing **PTT** while a continuous call tone is ringing or within 5 seconds after a brief call tone has stopped ringing.

**Notes.**

1. The Remote Response is only possible among stations programmed for this function.
2. When making the remote response from the station having its Privacy switch in ON position, shift the switch back to OFF or lift its handset before depressing **PTT**.

◆ **Programming the remote response group**

Establish the remote response group of stations and designate a specific station within the group as a temporary "Master station" and the rest as "Substations".

Set up the "Master station" by dialing.

• **6** **PTT** **X****X****X** Confirmation tone  
 Station No. to become "Master station".

Register the "Master station" No. at the "Substation" by dialing

• **6** **PTT** **X****X****X** Confirmation tone  
 Master's number

**Note.**

Be sure to register the station No. that becomes the "Master station" at the "Master stations".

◆ **Cancelling remote response programming**

Touch dialing at each "Substation"

• **6** **PTT** **X****X****X** Confirmation tone  
 His own Substation number  
 cancels the Remote response program.

● **Dial operation for Remote response**

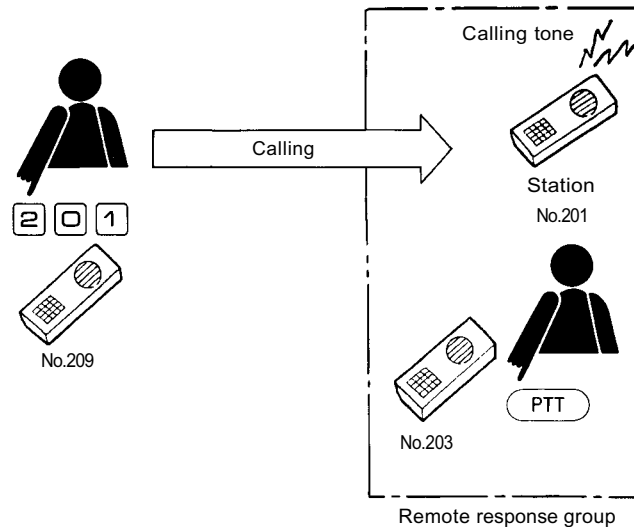

● **Conversation after Remote response**

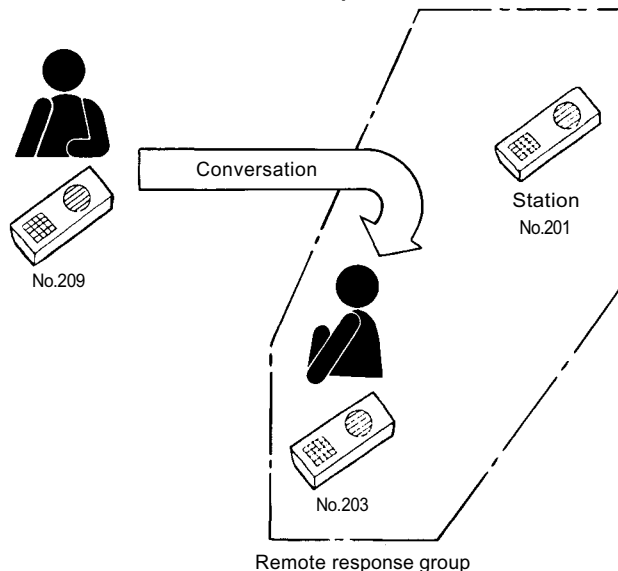

● **Programming the remote response group (Example)**

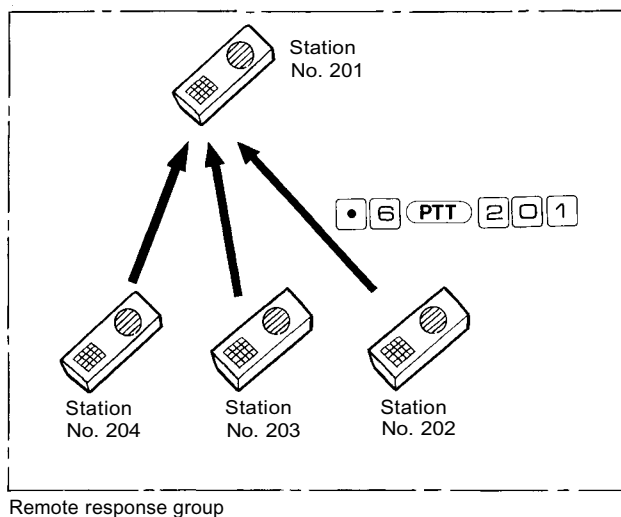

# Call Transfer

## Call Transfer from Called Station

During the conversation, first dial



(the Station Number of the person the call is to be transferred to).

The original call is then held and the holding tone is transmitted to the other party, while the third party is called and asked whether he will accept the call. If he agrees to accept the call, dial  or hang up a handset,

and the transfer will be completed.

This function allows called party to transfer that call to another station. The party to whom the call is to be transferred, may be called using either the Station Number, the Personal Number or through Single Digit Dialing.

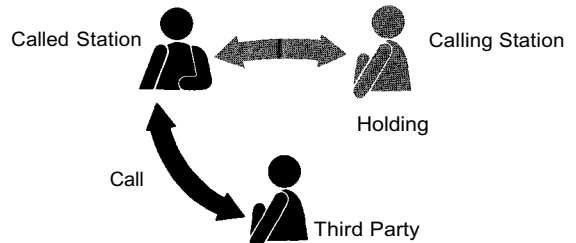
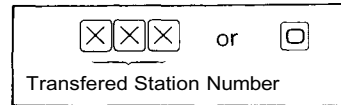
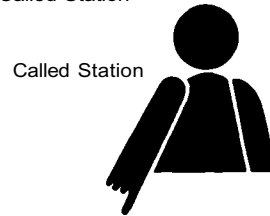
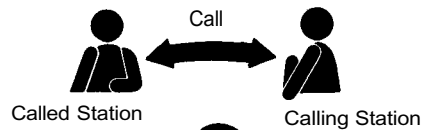

## Call Hold and Call Back from Calling or Called Station

During the conversation, first dial

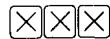

(Station No. of the third party.)

The other party is then placed on hold while the third party is called. Upon completion of the conversation with the third party, dial



or the third party dials



or replaces his station handset.

This allows the original conversation to resume.

The Transfer function is combined with the Call Holding function.

When two parties are talking, either one can be temporarily placed on hold to permit the call to another station. When the conversation with the third party is over, the original conversation can be resumed.

The third party can be called using either the Station Number, his Personal Number or through Single Digit Dialing.

### ● Transfer

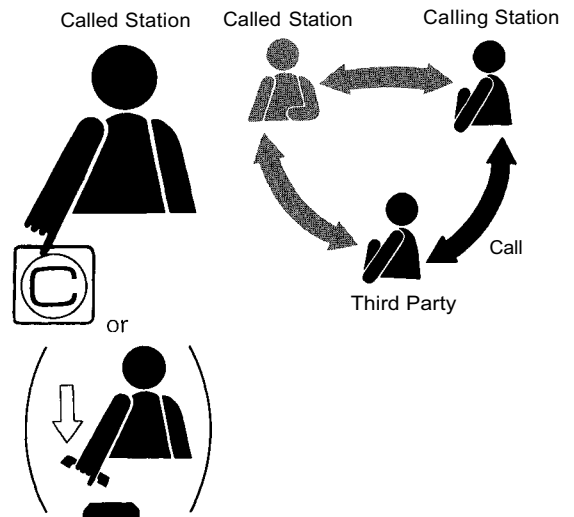

### ● Call Back

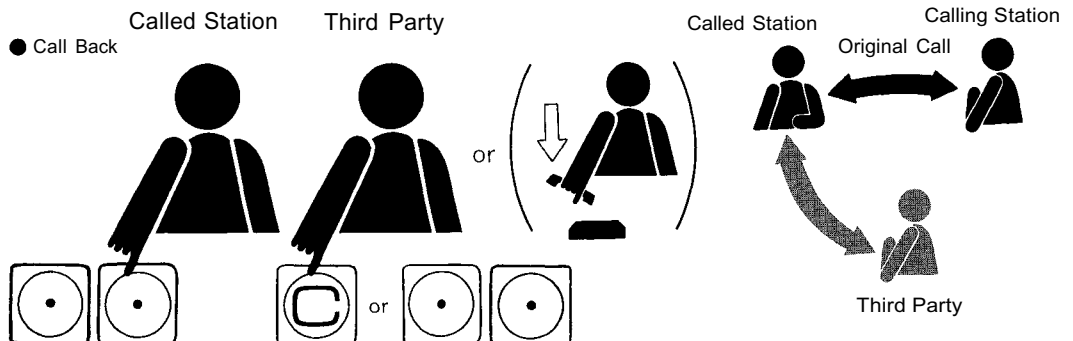

# Paging during Normal Calls

This function allows a paging call to be made during the conversation to call the third party and ask him if he accepts the call, while holding the original conversation. The original call, if he accepts, is transferred to the third party.

When it is desirable to call the third party during the conversation, press **[2][3]** plus the desired paging zone. (0~7, 00~31, \*00~15). This place the conversation on hold and allows a paging call to be made.

Wait for a paging response by pressing **[2][2]**. (The original conversation is restored.) When there is the paging response, the conversation is interrupted and the paging party is automatically connected to the third party, while transmitting a holding tone to the conversation partner.

Dial **[2][2]** again when coming back to the original conversation. To transfer the original call to the third party, press **[2]** or replace the handset.

\* When the exchange in use is EX-610 or EX-620.

**Note.**

This function can be operated when both "Call Transfer" and "Paging" functions are employed.

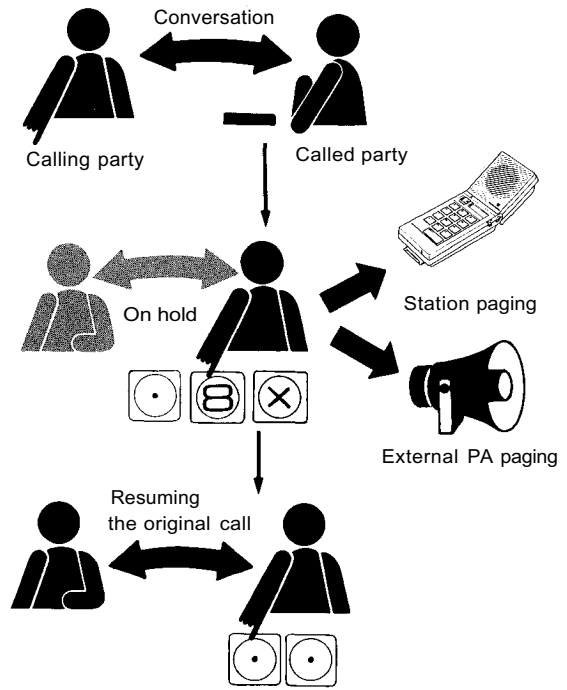

# Group Hunting

When the called is busy, the call is automatically rerouted to the pre-programmed. When that station is also busy, the call is further rerouted to the other pre-programmed station.

**Notes.**

1. To use this function, No.200 programing must be established for station a call is to be rerouted to. Also set the DIP switch for Group Hunting to ON.
2. If all stations are registered for this function by No.200 programing so that an imcoming call may make a loop in the group, any incoming call is automatically transferred to an idle station.

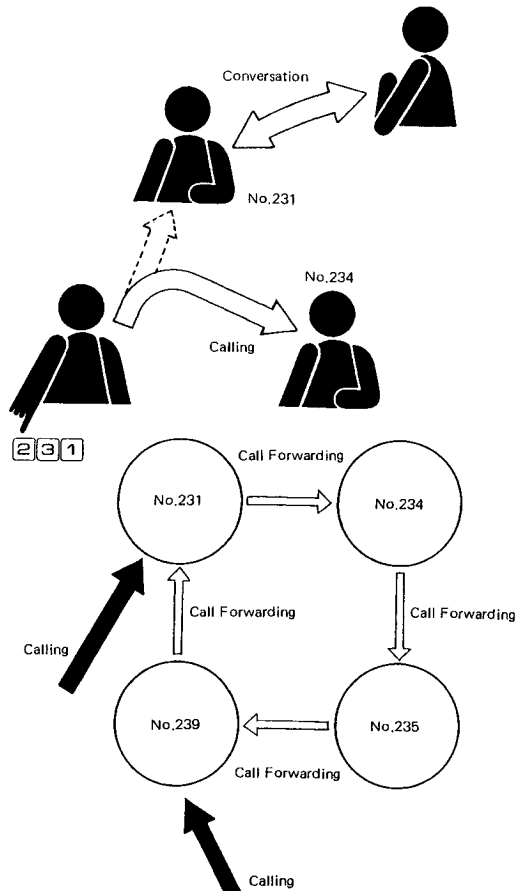

## Secretary Transfer

This function is only available when a specified station is programmed for this purpose with use of Station #200 in the programming mode. Automatic transfer of incoming calls by an executive to his secretary is accomplished by placing the Privacy Switch on his station in the ON position.



This function allows a secretary to accept all incoming calls placed to an executive.

For the executive to accept calls directed to his station once the automatic secretary function has been programmed by station #200, he simply moves the privacy switch to the left, or OFF position.



It is also possible for the executive to accept calls at his station.

There is no limit to the number of Executive/Secretary pairings except by the number of available number combinations within a given system.

When a secretary who is already programmed for this function wishes another secretary to accept all incoming calls directed to an executive, station No. 200 programming of another secretary should be set up in the exchange. Then, the calls can be rerouted to another secretary if the executive and the secretary first registered place their Privacy switches in the ON position. It is also possible to transfer the call in a daisy chain method.

### Note.

When 2 or 3 exchanges are connected by tie-line, set up a Secretary/Executive association within a group of stations connected to the same exchange.

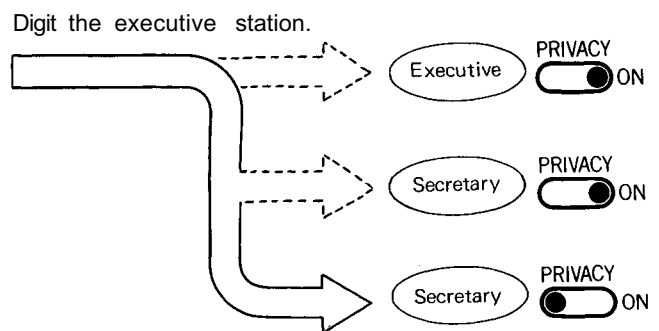
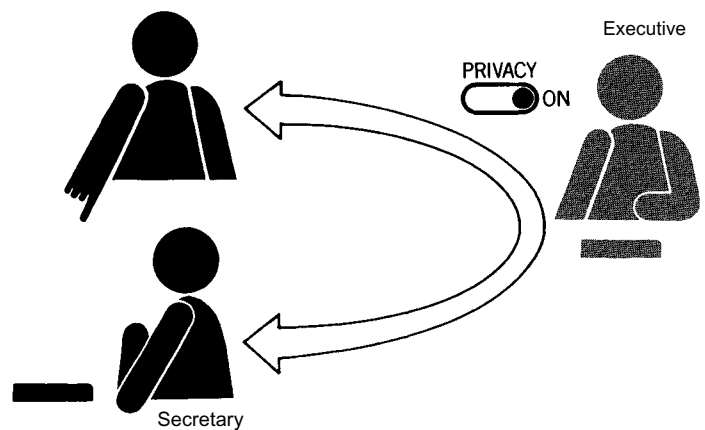











# Secretary Transfer and Call Transfer











PV Type

Combination of the secretary transfer and call transfer allows rerouting of the call transferred to the secretary back to the executive's station.

When the secretary answering a call touch dials  Executive's station number the privacy tone sounds continuously at both stations, while the call is held. The holding tone is transmitted to the calling station. If the executive shifts the privacy switch to the left position, or if he depresses any of the keys other than the (PTT) key ( ~ , , , , , or picks up a handset he can talk with the secretary. If the call held is to then be transferred back to the executive's station, the secretary is to touch dial , or to hang up a handset, and the original calling station will be connected to the executive's station.

## Secretary Transfer and Call Transfer using Single Digit Dialing

Combination of "Secretary Transfer", "Call Transfer" and "Single Digit Dialing" allows simple retransfer of the call transferred to the secretary back to the executive's station.

Touch dial       (PTT) Confirmation tone Executive's station number at the secretary's station in advance. When the call transferred to the secretary has to be transferred back to the executive, the secretary simply touch dials  at her station. This sends the continuous Privacy tone to both stations while the call is held. If the call is to be transferred back to the executive's station, the secretary touch dials  or hangs up a handset. The calling station will then be connected to the executive's station. If there is no answer from the executive, the secretary touch dials   and the original call is resumed.

Unless the executive sets his station Privacy switch to OFF within 10 seconds after the Privacy tone has sounded, the call attempt to the executive is cancelled for automatic return to the original conversation.

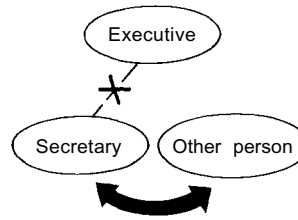
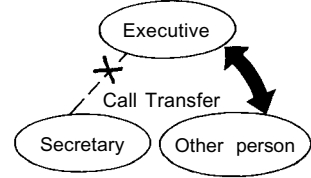
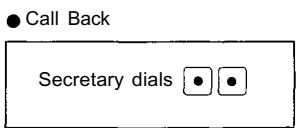
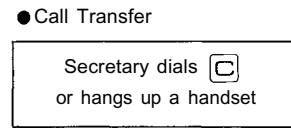
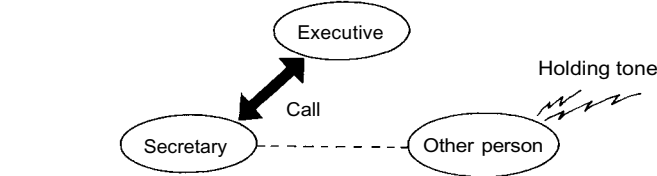
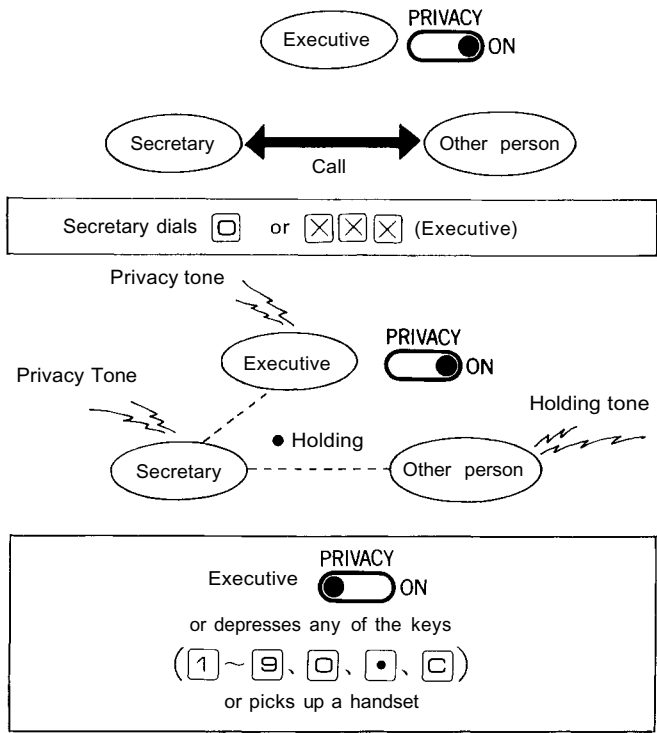

Adoption of the selective function "Transfer" allows rerouting of the call transferred to the secretary back to the executive's station.

When the secretary answering a call touch dials



Executive's station number

the continuous calling tone sounds at both stations, while the call is held. The call holding tone is transmitted to the calling station. If the executive shifts the privacy switch to the left position, or if he depresses any of the keys other than the (PTT) key (□~□, □, □, □), or picks up a handset he can talk with the secretary. If the call held is to then be transferred back to the executive's station, the secretary is to touch dial □, or to hang up a handset, and the original calling station will be connected to the executive's station.

### Secretary Transfer and Call Transfer using Single Digit Dialing

Adoption of the selective functions "Transfer" and "Single Digit Dialing" allows simple retransfer of the call transferred to the secretary back to the executive's station.

Touch dial

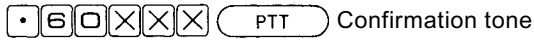

Executive's station number

at the secretary's station in advance. When the call transferred to the secretary has to be transferred back to the executive, the secretary simply touch dials



at her station. This sends the continuous calling tone to both stations, while the call is held. If the call is to be transferred back to the executive's station, the secretary touch dials □ or hangs up a handset.

The calling station will then be connected to the executive's station.

If there is no answer from the executive, the secretary touch dials



and the original call is resumed.

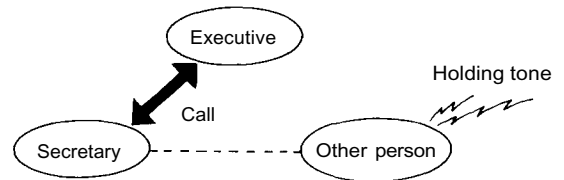
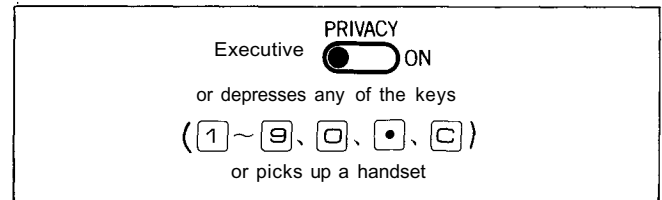
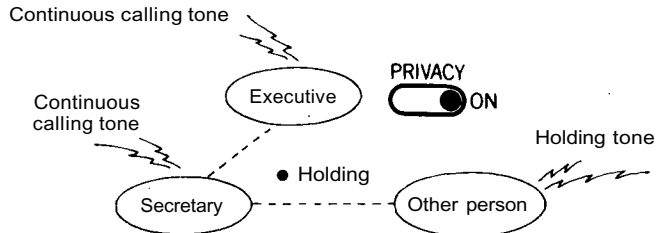
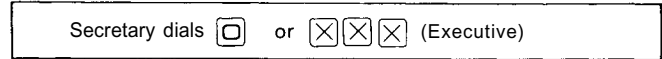
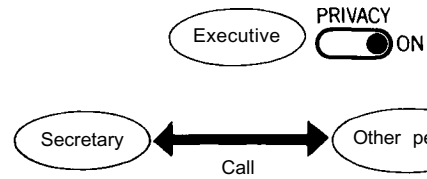

• Call Transfer

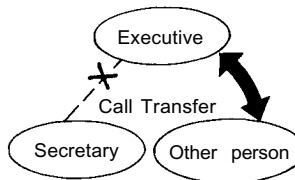
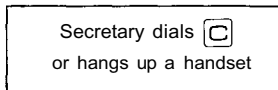

• Call Back

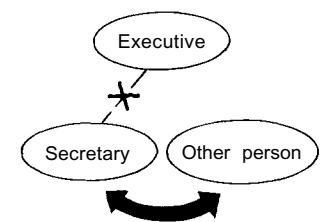
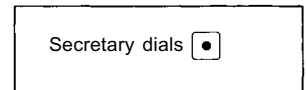

# Call Forwarding

When you will be away from your station and wish all incoming calls to be rerouted to a different destination you are going to move to, you can do so by registering that station number before you leave.

## ◆ Registering Call Forwarding function

To program this function, touch dial  plus the station number of the destination you are going to move to (confirmation tone is heard). This function may only be registered at the originally assigned station and any previous programming made for this function is automatically cancelled each time the new destination is registered.

## ◆ Cancelling Call Forwarding function

Touch dial

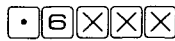

Original assigned station No.

## Notes.

1. Call made in the following instances are directly put through to the original station, independently whether or not this even if call forwarding function has been programmed.
  1. Calls from the registered destination station to the original station.
  2. Calls by a personal number.
2. Before a call is automatically rerouted to the registered station, a brief confirmation tone sounds at the original station, indicating that the incoming call is put through to the registered station.
3. This function is available only between stations within the same group when the system employs Group Blocking function. Even when it is possible to make a call between stations of different groups, Call Forwarding function cannot be registered between them.

## ● Registration of Call Forwarding

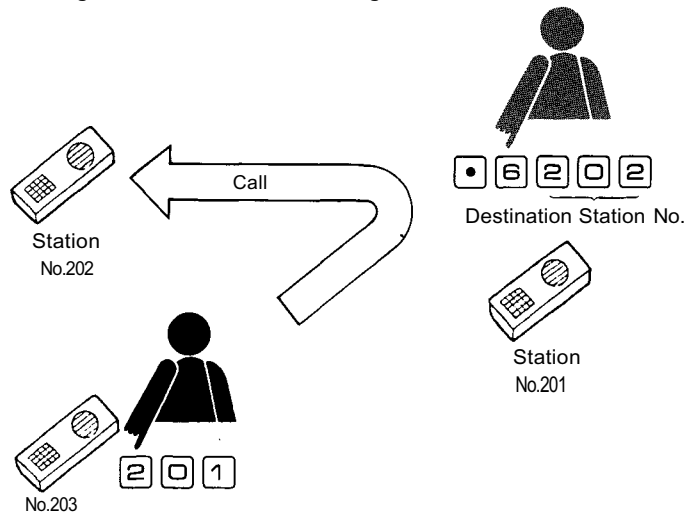

## ● Cancellation of Call Forwarding

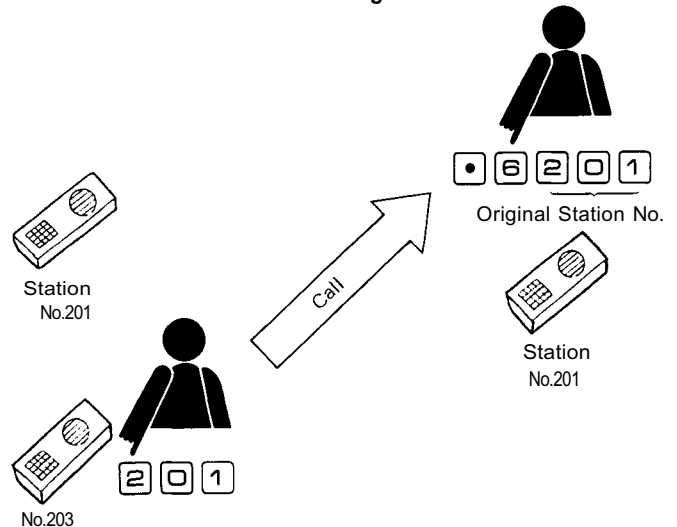

## Priority

When the party called is on the line, as indicated by the busy tone, dialing

**9**\*

transmits a priority tone to the called party. The same tone is audible at the calling station. The call is connected if the called party also responds by dialing

**9**

In this event, the original conversation partner of the party called is temporarily placed on hold and the holding tone is transmitted to his station.

Upon completion of the priority conversation, the party who placed the priority conversation dials

**C** or **••** or replaces the handset.

This allows the interrupted conversation to resume.

When the called party is already on the line, the party calling, if he deems it necessary, can send a Priority signal to the called party. After a response from the party called, the urgent call is allowed to take priority and go through.

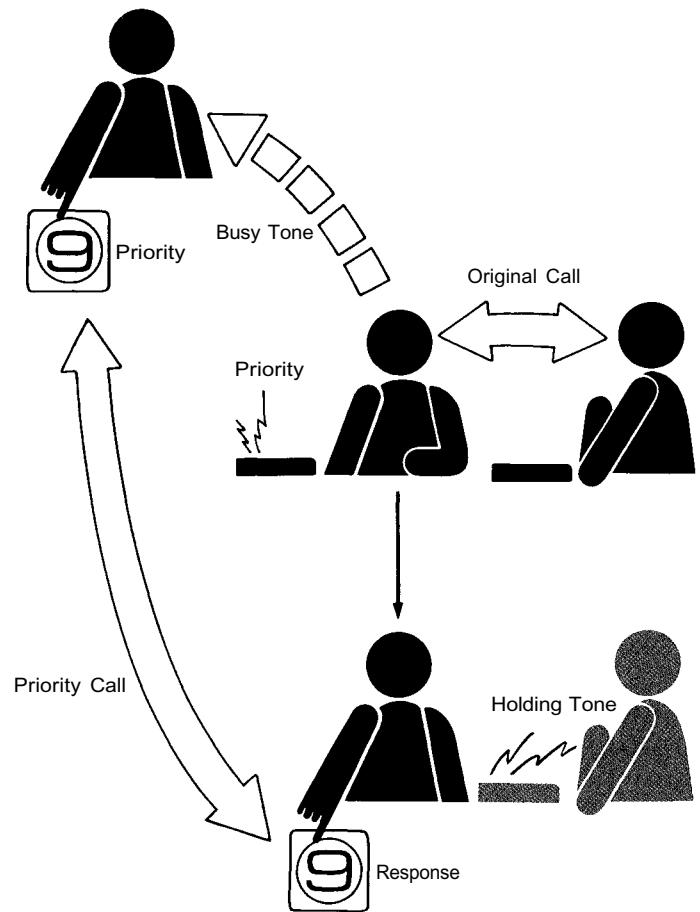

## Executive Priority

This function is available only for those stations specifically programmed for this function, with programmed station #200. When the station called is busy or in the Privacy mode, as indicated by the busy or privacy tone, dialing

**99**\*

sends a priority tone. This priority tone is transmitted for a few seconds and then the call is put through.

In this event, the original conversation partner of the party called is put on hold and a holding tone is transmitted to his station.

Upon completion of the priority conversation, the party placing the priority call dials **C** or **••** or replaces the handset.

The original conversation can be resumed.

When the called station is busy or in the "Privacy" mode, this function allows forced interruption for priority conversation.

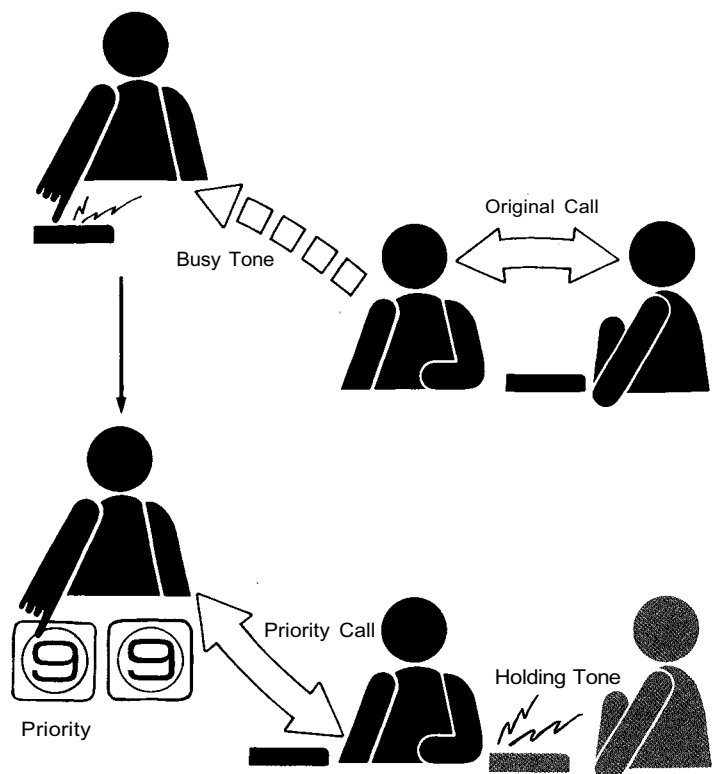

# Highest Executive Priority

This function is available only for those stations specifically programmed for this function, with programming station No. 200. When the station called is busy, as indicated by the busy or privacy tone, dialing

99\*

sends a priority tone. This priority tone is transmitted for a few seconds and then the call is put through, terminating the original conversation.

When the called station is busy or in the Conference mode or during a paging call, this function allows forced interruption for priority conversation.

### Note.

Either Executive Priority function or Highest Executive Priority function may be employed.

\* When the party called through the conference function is busy and it is desirable to interrupt his conversation, dial

999.

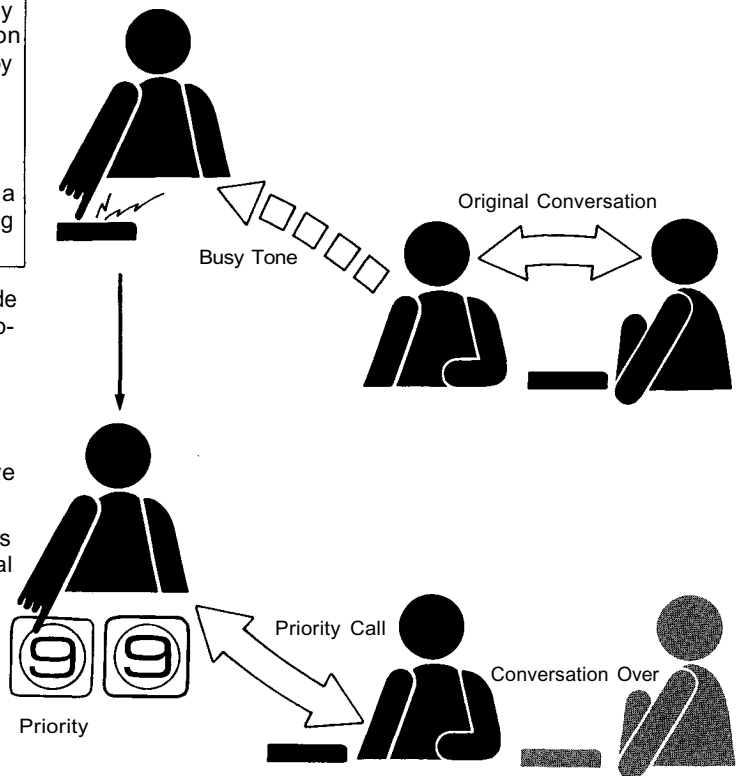

# Conference

A "Hands-Free" conference call can be made with up to 4 persons. For a conference under this function the other participants may be called either through their station number, personal number or by Single Digit Dialing. Addition of stations or personal numbers (total of only 4) may be added by anyone already connected.

The person who proposes the conference may dial  
 5  X  X  X  
(Station Number of the 1st of the participants)  
After receiving 2nd person's consent, he may then dial  
 X  X  X  
(2nd participant)  
After receiving 3rd person's consent, he may now dial  
 X  X  X  
(the last participant)

At this point, the 4-man conference may begin. It is also possible for any of the 4 participants to call up any of the other participants.

Both the 2nd and the 3rd persons can be called up in one dial operation without obtaining their consents.

A person wishing to drop out of the conference should dial  
 C or hangs up a handset  
at his station.

Any of the participants who wish to drop out during the conference may do so as long as it's not the party who originated the conference.

The function is cancelled and the normal mode is restored when the person who arranged the conference dials  
 .  .

In the event that the calls made by the person arranging the conference are not answered or that there has been a dialing error, the function can be cancelled for restoration to the normal mode.

The conference is terminated when the party who arranged the conference dials  
 C or hangs up a handset

When the conference has been terminated by the party who originated it, the other participants cannot continue the conference.

Either of the parties in conversation is to dial  
 5  X  X  X  
(the Station Number of the third party).

It is possible for persons in normal conversation to change to the Conference mode without interruption.

● A "Hands-Free" conference call can be made with up to 4 persons.

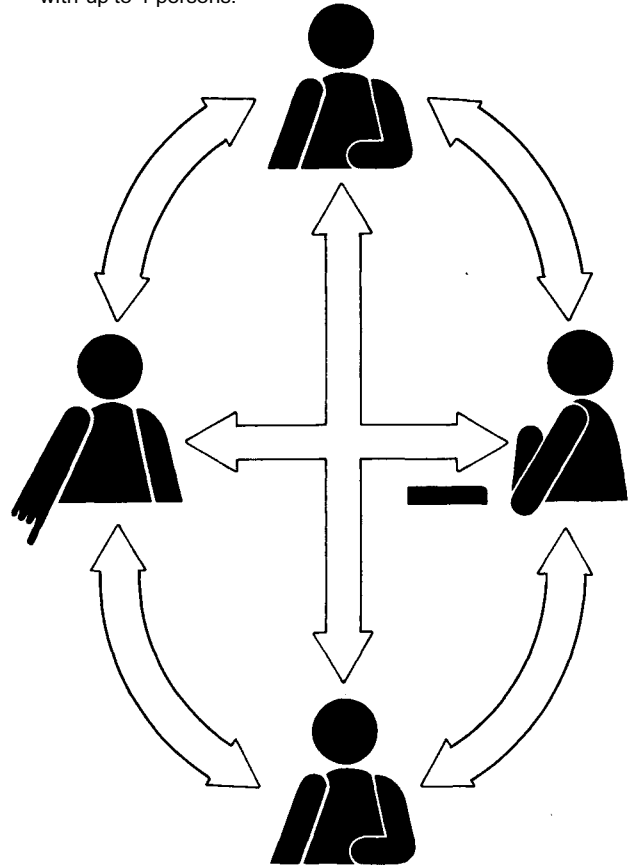

● Dialing of conference member.

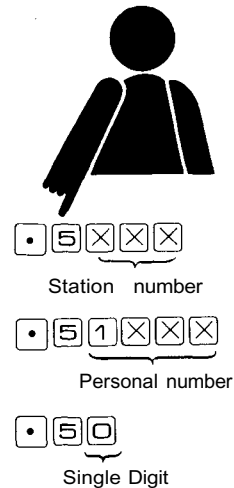

# Paging

A variety of paging modes allows paging over a wide area from any master station. The paged party may respond from the nearest master station.

Paging modes include external PA systems and/or Station paging and Zone paging is for calling a limited area, and All-call paging is for calling over the entire area.

Response to a paging call may be made by means of Automatic response or Zone number dialing.

## 1. External PA paging and Station paging

### A. External PA paging

1. Paging through external speakers is possible from any master station, with the paged party able to respond from the nearest master station.
2. External PA paging zones and all-call paging are possible up to a maximum number of 31 zones.

### B. Station paging

1. Paging from any master station to all stations within a certain area is possible through the station speakers. But the page will not be heard at stations in use in the area.
2. Station zone paging and all-call paging are possible only within zone 1 through 31.

## 2. Zone paging and All-call paging

### A. Zone paging (Individual zone paging).

Paging and Paging response are possible through Zone paging. To page a specific zone, press  $\square \square$  and the zone number. To respond to a zone page, press simply  $\square \square$  or  $\square \square$  plus the zone number.

Paging to zones 1 through 31 may be made through external PA paging using the external amplifiers and speakers, and/or through station paging using the station speakers.

### B. All-call paging

Paging and Paging response for External PA and/or station paging is possible through All-call paging. To make an all-call page, press  $\square \square \square$  (maximum of 7 zones) or  $\square \square \square \square$  (maximum of 31 zones). To respond, press  $\square \square$  or  $\square \square (\square) \square$ .

This does not necessarily mean that All-call station paging must reach all the stations.

### C. Maximum paging zones

Exchange	Station paging	Public address paging
EX-610/620	All call +7 zones	All call +15 zones
EX -630	All call +31 zones	All call +31 zones

## 3. Responding to a paging call

### A. Automatic response

#### 1. Zone paging response

Touch dialing  $\square \square$  at the station within the paged zone permits a response to the party who placed a paging call.

In this event, No.200 registration of the stations (consecutive station numbers) within each zone must be made.

#### 2. All-call paging response

Touch dial  $\square \square$  at any station and the paged party is put through to the party calling.

### B. Zone number dialing

#### 1. Zone paging response

The paged party is connected to the party calling by depressing.

$\square \square (\square) \square$  (Zone number)

at any station.

#### 2. All-call paging response

Depressing  $\square \square (\square) \square$  or  $\square \square$  permits a response to the party calling.

# Other Paging Modes

## 1. Combination paging

Combination paging is used when several zones must be paged simultaneously through External PA or Station paging. A special paging area can be created wherever the paging ranges overlap by combining several zones. A maximum of 20 combinations can be created in this way from a maximum of 31 individual zones.

## 2. Emergency all-call paging

Emergency external PA or station all-call paging can be made either from the specified station (No.247) or by an external input signal connected to line No.247. All normal calls and pages are interrupted for the duration of the emergency All-call page, returning to normal when the page is terminated.

## 3. Paging priority

In normal station paging, the page is not heard at any station already in use. By using the paging priority function, the call can be interrupted to allow the page to go through. A holding tone sounds at the other party's station, and the call is restored when the page is terminated.

### Note.

Dial operation of Combination paging

- Paging call

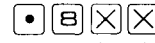

Combination zone No.  
(80 ~ 99)

- Paging response



Combination zone No.  
(80 ~ 99)

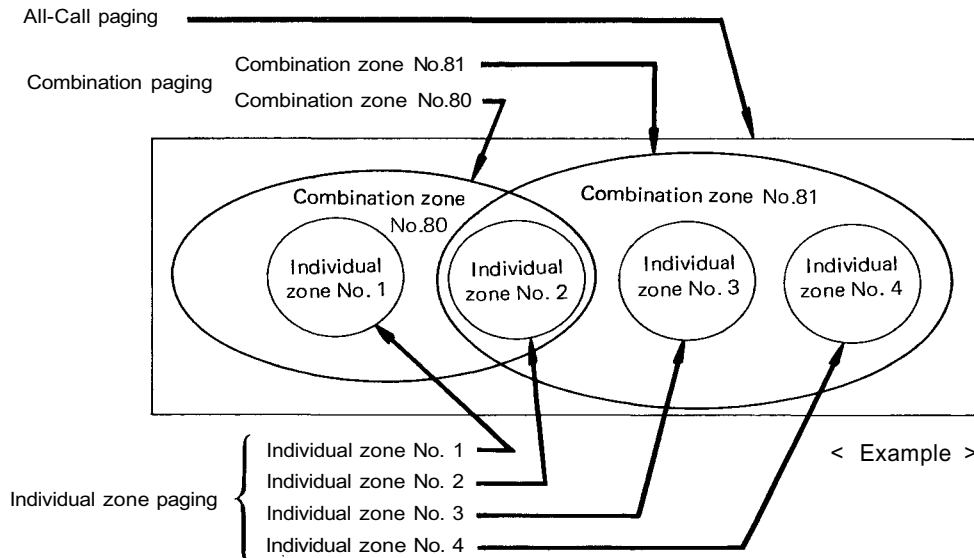

### Note: Priority of Paging

Emergency all-call paging > All-call paging > Combination paging = (Individual) zone paging

1. The higher priority page overrides the lower priority one. The lower priority page will be restored when the higher priority page is terminated.
2. Individual zone pages made while a Combination paging is in progress will result in Camp-On-Busy.



# How to select the paging area and make the paging call.

Paging functions may include both external PA and stations, depending on the zone being used. The paging area is limited to individual zone, Combination paging and All-call paging depending on the call range.

Paging area	Dialing operation				
	No.	Paging call		Response	
		All-call and maximum of 9-zone paging.	All-call and maximum of 15-zone paging.	Automatic response	Zone number dialing
All-call paging	0	• 8 0	• 8 0 0	• 0	• 0 or • 9 (0) 0
Zone paging up to 31 zones Maximum of 15 zones	1 } 31 (15) *	• 8 X Individual zones (1~7)	• 8 X X Individual zones (01 ~ 15) (01 ~ 31) *	• 9	• 9 (X) X Individual or Combination zones
Combination paging of up to 20 zones	80 } 99	• 8 X X Combination zone (80~99)			

\*When EX-610 or 620 is used.

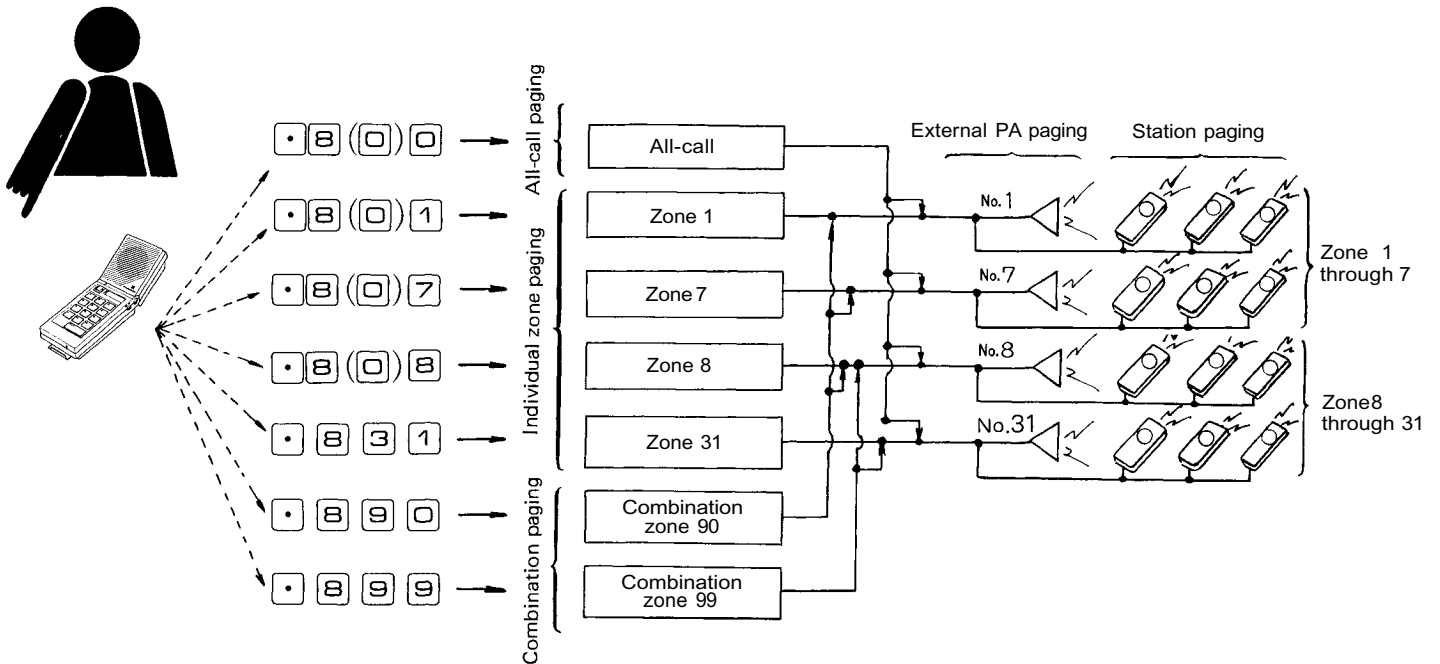

< Example >

# All-Call Paging and Individual Zone Paging

## ◆ Paging call

External PA paging to a specific zone is possible from any master station by pressing

or     ('0' or '00' = all-call)  
1 ~ 7 (00 ~ 31) (01 ~ 15)\*

and the desired zone number ('0' = all-call). It is possible to wait for a response in this mode, but anything said will be broadcasted over the entire zone. It is best to end the paging call by pressing

or hanging up a handset

and waiting for a response.

\* When EX-610 or 620 is used.

Paging to zones 1 through 31 may be made through external PA paging using the external amplifiers and speakers, and/or through station paging using the station speakers. When EX610 or 620 is used, the maximum number of stations for public address paging and station paging are 15 zones and 7 zones respectively. All zones are paged at the same time by all-call paging.

## ◆ Paging response

### 1. Automatic response

To respond to a paging call, go to the nearest master station and press either

(All-call paging response)

or

(Zone paging response).

### 2. Zone number dialing

To respond to a All-call paging, go to the nearest master station and press

(  )  or

To respond to a Zone paging call, press

(  )

Zone No. 1 ~ 9 (01 ~ 31)

at the nearest station.

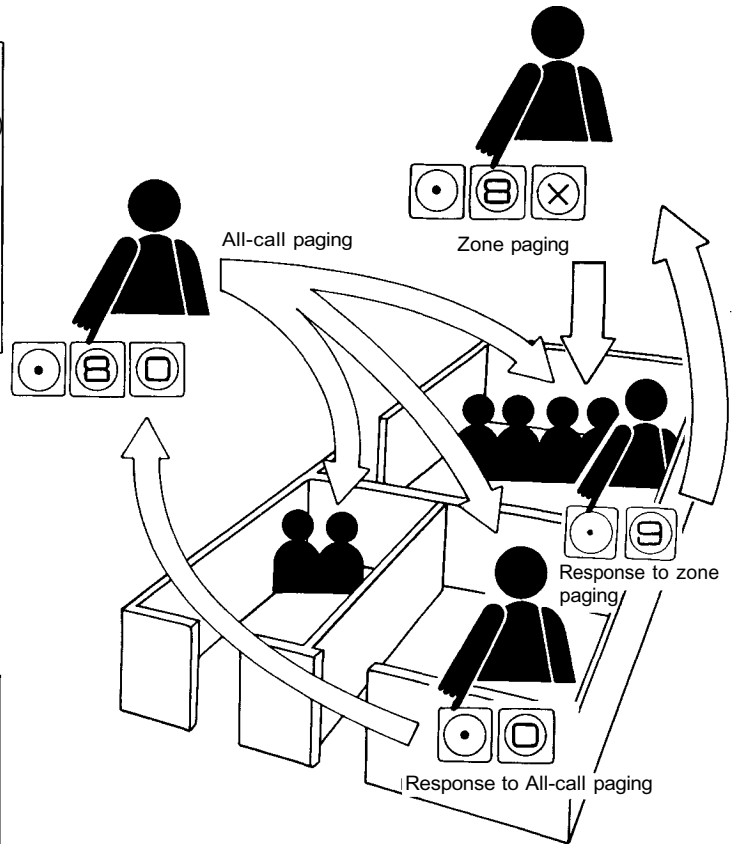

Table of stations used for individual zone paging. (Example)

Zone numbers	First station number	Last station number
1	2 0 1	2 0 3
2	2 0 5	2 0 7
3	2 1 0	2 1 9
4		
5		
6		
7		
8		
9		
1 0		
1 1		
1 2		
1 3		
1 4		
1 5		
1 6		
1 7		
3 0		
3 1		

Note 1: When all-call paging is initiated during zone paging, the Zone paging is interrupted and restored after the all-call paging is finished.

Note 2: To respond to Zone paging by pressing   , No.200 registration of the stations (consecutive station numbers) within each zone must be made. Such registration is required for both external and station paging. For further details, please refer to Installation Hand Book for EXES-6000 CP unit.

# Combination Paging

Several zones can be called simultaneously using external PA paging and station paging. This is combination paging and is initiated by pressing

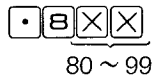

Paging will be broadcast to predetermined zones. It is possible to wait for a response in this mode, but it is usually preferable to terminate the paging call and wait for a response. The paged party can respond by pressing

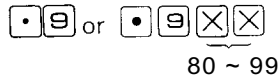

at the nearest station. Refer to Example 1.

## Priority of paging

All call paging > combination paging = individual zone paging

1. When some stations are already receiving another combination paging, the second paging call will be put on camp-on-busy. Refer to Example 2.
2. When some stations are receiving individual zone paging, a combination paging call will be put on camp-on-busy.

Likewise, when a combination paging call is being received, individual zone paging calls will be put on camp-on-busy. Refer to Example 3.

## Responding to combination paging and zone paging

1. Automatic response

To respond to zone paging or combination paging, press



When the same zone is called via both zone paging and combination paging, responses will be put through to the station calling last. Refer to Example 4.

2. Zone number dialing

To respond to the (individual) zone paging call, depress

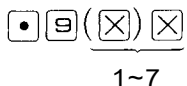

(01~31)(\*01~15)

Depressing

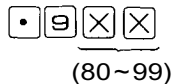

permits the response to the combination paging call.

\* When EX-610 or 620 is used.

## < Example 1 > Combination of individual zones

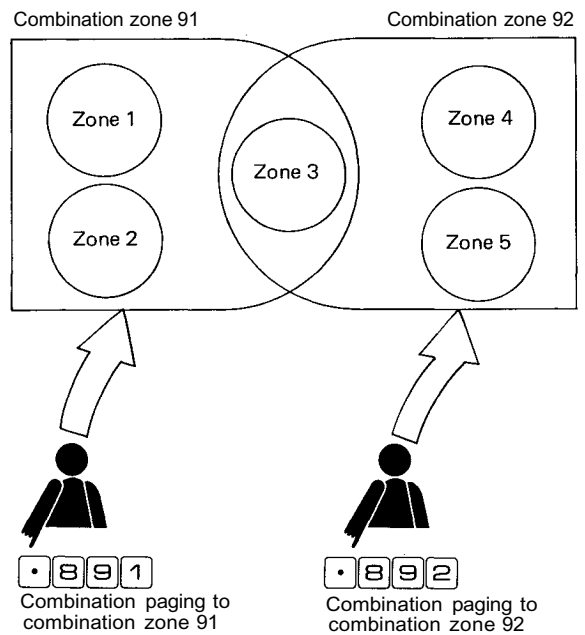

## < Example 2 >

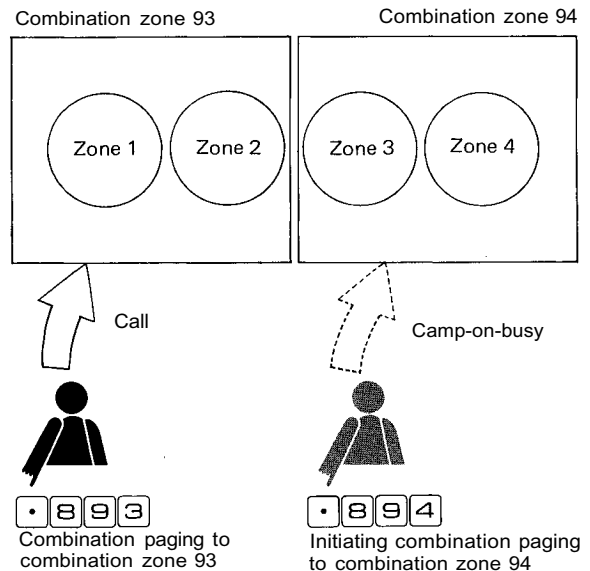

## < Example 3 >

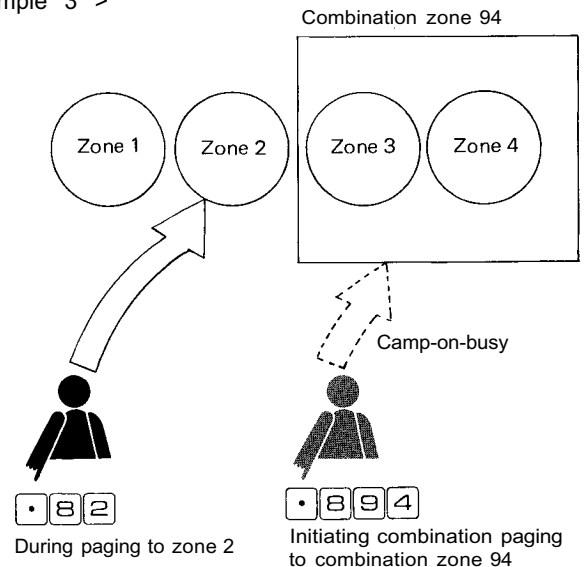

< Example 4 >

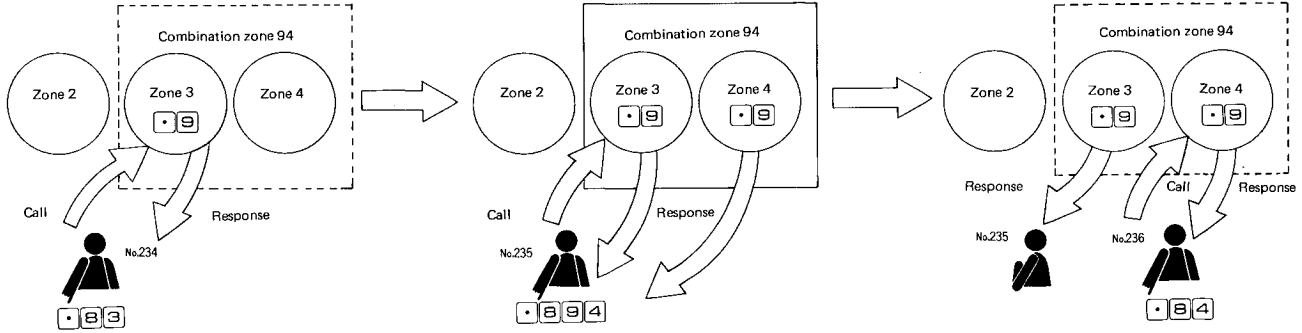

To use the combination paging, Programming must be established for each individual paging zone included in each combined zone.

For further details, refer to Installation Hand Book for EXES-6000 CP unit.

Programming for Example 1.

Combination zone	Dialing Individual zone	Individual zone																																
		1	2	3	4	5	6	7	8	9	10	11	12	13	14	15	16	17	18	19	20	21	22	23	24	25	26	27	28	29	30	31		
80	• 8 8 0																																	
81	• 8 8 1																																	
82	• 8 8 2																																	
83	• 8 8 3																																	
84	• 8 8 4																																	
85	• 8 8 5																																	
86	• 8 8 6																																	
87	• 8 8 7																																	
88	• 8 8 8																																	
89	• 8 8 9																																	
90	• 8 9 0																																	
91	• 8 9 1	○	○	○																														
92	• 8 9 2			○	○	○																												
93	• 8 9 3																																	
94	• 8 9 4																																	
95	• 8 9 5																																	
96	• 8 9 6																																	
97	• 8 9 7																																	
98	• 8 9 8																																	
99	• 8 9 9																																	

## Emergency All-Call Paging

Handset substation TL-600S should normally be used for the emergency all-call station, No. 247.

To broadcast emergency all-call paging, pick up a handset.

The highest priority all-call paging can be broadcast to all zones without a paging pre-announcement tone. During emergency all-call paging, all other paging calls and normal calls are interrupted until the handset is replaced to finish the emergency message.

1. This function may be used to announce emergency instructions from the specified station No.247. It may also be used to provide the signal tones such as chime or alarm signals when the signal sources are fed to No.247 circuit.
2. To make emergency all-call paging from the specified station No.247 using Hands-free type of station, move the privacy switch from "ON" to "OFF" position.

< Emergency all-call paging is made >

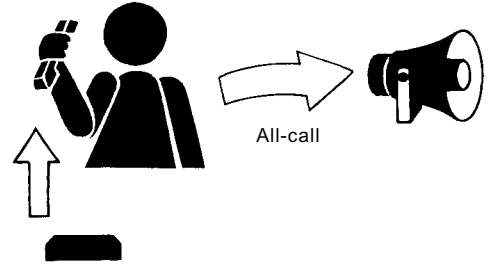

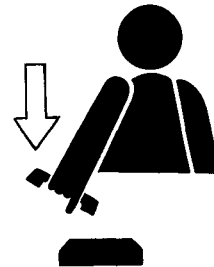

< Emergency all-call paging is finished >









# Priority Station Paging

Normal station paging calls are not audible at the busy stations, but the Priority Station Paging can break in on such busy stations.

1. Dial   
 (zones: 1 ~ 7, all-call: 0),  
  
 (zones: 01 ~ 31, all-call: 00), or  
 (\*01~15)  
  
 (combination zones: 80 ~ 99).



If there is a busy station, the conversation is interrupted and the paging call is allowed to go through, while transmitting a holding tone to the conversation partner placed on hold.

2. The conversation is restored when the paging is finished. (\*)

3. To respond to the paging call during the conversation, first terminate it by depressing  or by replacing a station handset and then dial  or  (Zone No.) (Zone paging or combination paging response) or  or  ( ) (All-call response).

- \* When the EX-610 or EX-610 is used.
- \* The conversation is not restored if the Privacy switch is set to ON. (In the EX-6000 system, it is possible to page or respond to a paging call even when the Privacy switch is ON.)

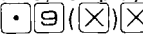
**Notes.**

- (1) Dialling keys while receiving a station paging call makes the call inaudible at that station and connects that station to the called station.
- (2) When the called station is being paged, a busy tone is transmitted to a calling party and he can "camp-on". Refer to Example 2.
- (3) When a paged zone (Zone 1) has a station placing a paging call over the other zone (Zone 2), a party who has paged the zone 1 is put in the "Camp-on-busy" mode. Refer to Example 3.
- (4) For the Priority Station Paging function, stations (consecutive numbers) in each paging zone, which can be interrupted during conversation, must be programmed at the station No.200. This is also required to programme the zones for automatic paging response (see Note 2 of Paging) and station groups having access to incoming telephone calls.
- (5) Even when the Priority Station Paging function has been adopted, by establishing the station No.200 programming (Function Code 39) desired stations can be made to refuse a priority paging call when they are busy.
- (6) When the system incorporates Station paging and PA paging at the same time, employ the Zone number dialing method () for the paging response. Also, set up "Station No.200 programming" for Priority Station paging. If the Automatic reponensing method () is employed, then "No.200 programming" need to be set up for every station and conversation is interrupted each time the external PA paging is made.

< Example 1 >

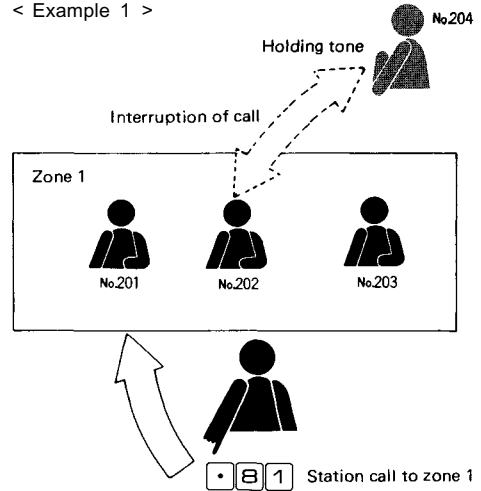

< Example 2 >

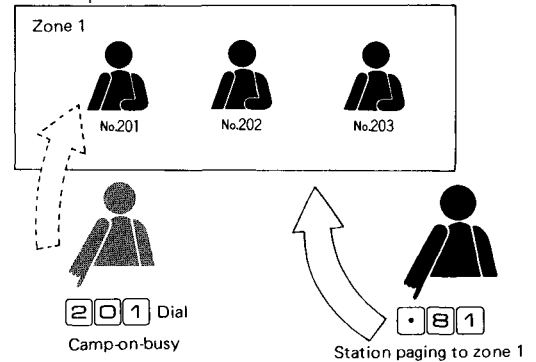

< Example 3 >

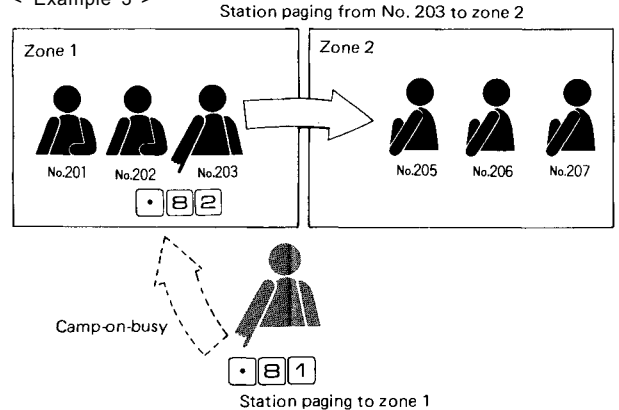

Programming for Example 1, 2 and 3

Zone numbers	First station number	Last station number
1	2 0 1	2 0 3
2	2 0 5	2 0 7
3	2 1 0	2 1 9
4		
5		
6		
7		
8		
9		
1 0		
1 1		
1 2		
1 3		
1 4		
1 5		
1 6		
1 7		
3 0		
3 1		

# Personal Number Paging

If you wish to receive personal number paging call, register your personal number at any station in the desired paging zone by dialing

• 6 1 X X X confirmation tone is heard.

Personal number

A calling party can page you automatically in that zone if he dials.

1 X X X

Personal number

To respond to a paging call, press • 9 on the nearest master station.

This function allows those who are frequently away from their original station to be paged automatically in the area where they are available, if personal number registration is done.

When you move from that registered area to another, make the same programming again.

When you leave the office, cancel the personal number registration, which may be done from any station by dialing

• • 1 X X X confirmation tone is heard.

Personal number

With your personal number cancelled, any incoming call to your number will be answered by a dial tone, indicating that you are not available.

### Note.

1. There is no limit to the number of personal numbers that may be registered at any single station, but the personal numbers which are used in this function are No.1000 through 1999.
2. Either the personal number call function or the personal number paging function is selectable.
3. No.200 programming must be established for stations of each paging zone.
4. In the systems where the zone number must be pressed to respond to a paging call, dial • 9 (X) X for paging response.

### ● Registering a Personal Number

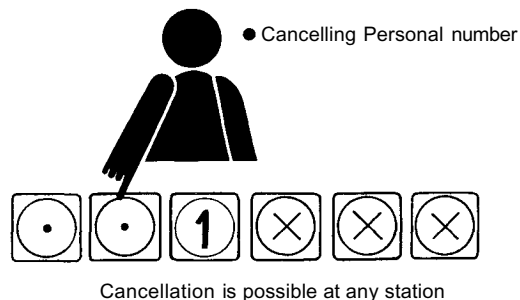
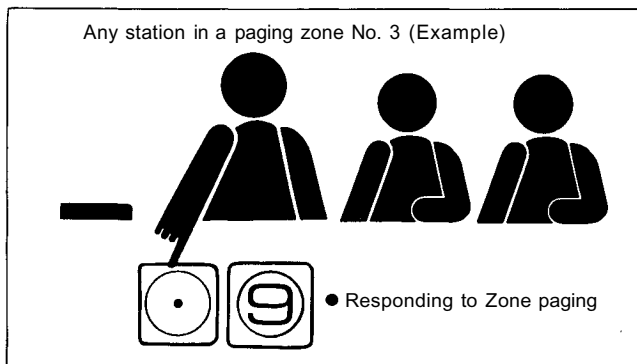
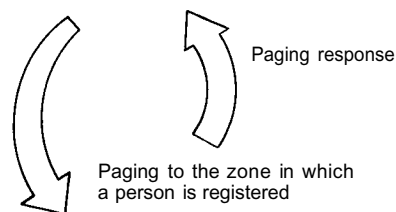
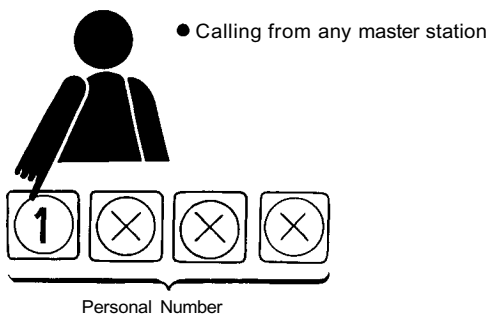
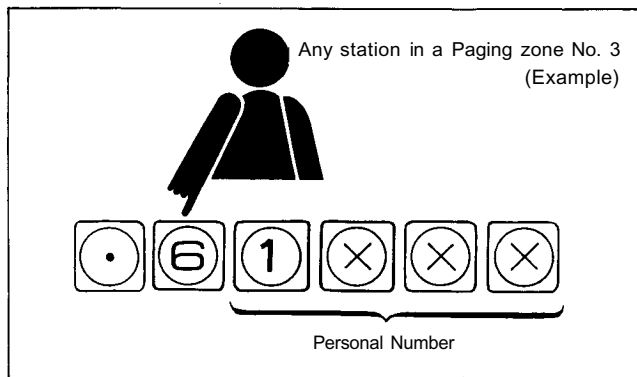

## Selectable First Station Number

The first station number of the system may be selected from any of the following numbers (Hardwired station number): 100/200/300/400/500/600/700/800/900.

The system with Personal Numbers can't use No. 100 ~ 199.

Note.

Station No. 200 programming is required when any other numbering schedules than standard (No. 200 ~) are used.

## Programmable Station Numbering

This function allows the system to have "Programmable station numbers", other than the "Hardwired station numbers" by programming.

The unprogrammed stations are used as original hardwired station numbers.

Type of dial operation	Hardwired station number	Programmable station number
With Personal number	No.200 ~ 455	No.200 ~ 999
Without Personal number	No.100 ~ 355	No.100 ~ 999

1. Numbering schedules can be changed easily by programming in stead of rewiring.
2. Such numbering schedules as 200's, 300's and 900's can be grouped together for each individual office.
3. Hardwired stations of each paging zone must have consecutive numbers. To make the programmable station numbers inconsecutive, use this function.
4. This function requires No.200 programming. See Installation Instructions for EXES-6000 CP unit.

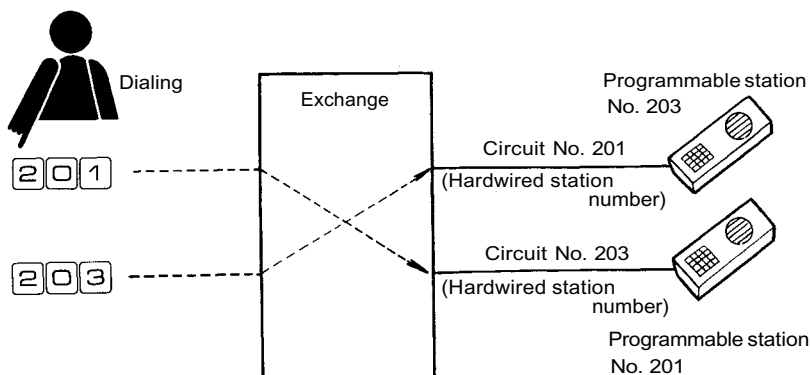

5. People operating the intercom stations need not worry about the Hardwired station numbers. Note, however, that the hardwired station numbers are used to program all the setup data of each function into the exchange through No.200 programming.

< Example >

Hardwired station number	Programmable station number	
2 0 1	2 0 1	} Department 1
2 0 2	2 0 2	
2 0 3		
2 0 4	3 0 1	} Department 2
2 0 5	3 0 2	

Hardwired station number	Programmable station number	
2 0 1	2 0 1	} Station paging zone
2 0 2	2 3 1	
2 0 3	2 4 1	

Hardwired station number	Programmable station number
2 0 0	→
2 0 1	2 0 3
2 0 2	→
2 0 3	2 0 1
3 2 6	→
3 2 7	→





# Programmable Restricted Access for Stations

Stations at which the following 7 specified functions can be restricted.

1. All-call paging	<input type="checkbox"/> 8 ( <input type="checkbox"/> ) <input type="checkbox"/>
2. Zone paging.	<input type="checkbox"/> 8 ( <input checked="" type="checkbox"/> ) <input checked="" type="checkbox"/>
3. Conference	<input type="checkbox"/> 5 <input checked="" type="checkbox"/> <input checked="" type="checkbox"/> <input checked="" type="checkbox"/> Station number
4. General purpose control Mode 1 (One-shot make output)	<input type="checkbox"/> 3 ( <input checked="" type="checkbox"/> ) <input checked="" type="checkbox"/> <input checked="" type="checkbox"/> 00 ~ 49 000 ~ 499
5. General purpose control Mode 2 (Make/break output)	<input type="checkbox"/> 3 5 ( <input checked="" type="checkbox"/> ) <input checked="" type="checkbox"/> <input checked="" type="checkbox"/> 00 ~ 99 000 ~ 511 <input type="checkbox"/> 3 6 ( <input checked="" type="checkbox"/> ) <input checked="" type="checkbox"/> <input checked="" type="checkbox"/> 00 ~ 99 000 ~ 511
6. General purpose control Mode 3 (8 selectable one-shot make output)	<input type="checkbox"/> 3 7 <input checked="" type="checkbox"/> <input checked="" type="checkbox"/> 1 ~ 9      1 ~ 8 Unit No.    Condition No.
General purpose control Mode 4 (8 selectable output or decimal output)	<input type="checkbox"/> 3 8 ( <input checked="" type="checkbox"/> ) <input checked="" type="checkbox"/> <input checked="" type="checkbox"/> <input checked="" type="checkbox"/> 01 ~ 64    1 ~ 8, 0 (clear) (01 ~ 99)    (0 ~ 9) Unit No.    Condition No.
7. General purpose control Mode 5 (4 decimal digits output)	<input type="checkbox"/> 3 9 <input checked="" type="checkbox"/> <input checked="" type="checkbox"/> <input checked="" type="checkbox"/> <input checked="" type="checkbox"/> 1 ~ 9      0000 ~ 9999 (Unit No.)    (4-digits)

1. For conference, only the specified stations (one or more) can make a call, but any station can be called.
2. No.200 programming must be established for the specified stations.

## Selectable Calling Tone

---

The duration of the calling tone can be set for either 0.2 second (single note tone) or 0.3 second (warble tone). It is also possible to have the station without any calling tone.

**Note.**

1. The duration of the continuous calling tone is impossible to change.
2. It is impossible to use different calling tone modes in one same system.

## Selectable Paging Pre-paging Tone Duration

---

Paging pre-paging tone can be chosen from "2 seconds", "1 second" and nothing.

## Time-Out of Conversation

---

It is possible to limit the conversation duration to one through ninety-nine minutes in the unit of one minute in order to improve speech path availability. A hurry-up tone is sounded in both the calling and called stations approximately 10 seconds before the busy stations are automatically disconnected from the speech path.

## Time-Out of Paging Call

---

This function is employed to prevent the unnecessary line occupation as a result of a paging party's failure to depress the  key after a paging call establishment. The paging call is automatically cancelled after a certain period of time, which may be set at one through ninety-nine minutes in the unit of one minute, with a hurry-up tone transmitted to the paging station approximately 10 seconds prior to the automatic disconnection. When the paged party responds, the conversation is automatically cut off after the duration set by the Time-out of conversation function.

# In/Out Annunciation

The in/out annunciation indicators can be turned on or off from any master station by using the personal number registering procedure.

When a personal number registration is made at a station, by dialing

• 6 1 X X X Confirmation tone  
 1000~1999 (personal number)

the personal number is registered at that station and the personal number lamp on the in/out indication panel is turned on.

### Personal number call

By dialing

1 X X X  
 1000~1999 (personal number)

from any station, the call is put through to the station registered with the personal number.

### Cancelling personal number and turning off in/out annunciation.

By dialing

• • 1 X X X Confirmation tone  
 1000~1999 (personal number)

from any station, the personal number is cancelled and the personal number lamp on the in/out indication panel is turned off.

1. The maximum number of in/out annunciation windows is 1000.  
 This maximum number remains the same even when the number of exchanges to be connected is increased to 2 or 3.
2. The in/out indication panel must be used with the Data Transmitting and Receiving Units (DT-E60 and DR-B61).

In/out indication panel

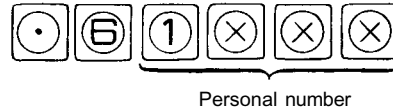
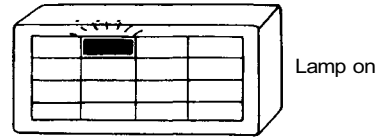

In/out indication panel

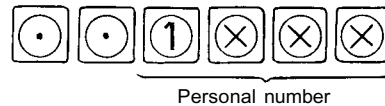
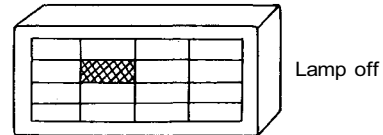

# Destination Annunciation Indication

When a personal number is registered at the station of the destination a person has moved to, the corresponding lamp on the destination indication panel comes on, indicating where he is.

Dial

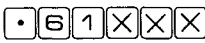
 Confirmation tone  
 1000 ~ 1031 (personal No.)

at any station (No.201~No.232), and the personal number is registered at that station and the corresponding station number is indicated by lamp. The personal number from 1032 to 1999 can be registered at the station but the corresponding station lamp does not come on. Registering the same personal number at another station causes the original station's lamp to extinguish and the new station's lamp to come on.

**Personal number call**  
By dialing

  
 1000 ~ 1999 (personal No.)

from any station, the call is put through to the station registered with the personal number.

**Cancelling Personal number registration and turning off Destination indication**  
By dialing

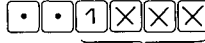
 Confirmation tone  
 1000 ~ 1031 (personal No.)

from any station, the personal number program is cancelled and the registered station's lamp on the destination indication panel goes out.

- Note.**
1. The personal numbers which may be assigned to this function are from No. 1000 to 1031.
  2. The station numbers which may be assigned to this function are No. 201 through 232. Registration of the personal number at any other station than these specified stations while the corresponding lamp is on causes that lamps to go out.
  3. The destination indication panel must be made using use of the Data Transmitting and Receiving units. For further details, please refer to instruction manuals for the DT-E70 and the DR-B61.

The lamp on the Destination panel is turned on

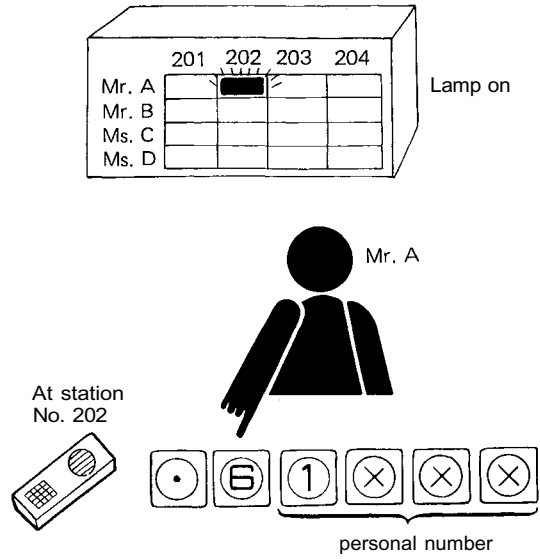

The lamp on the Destination panel is turned off

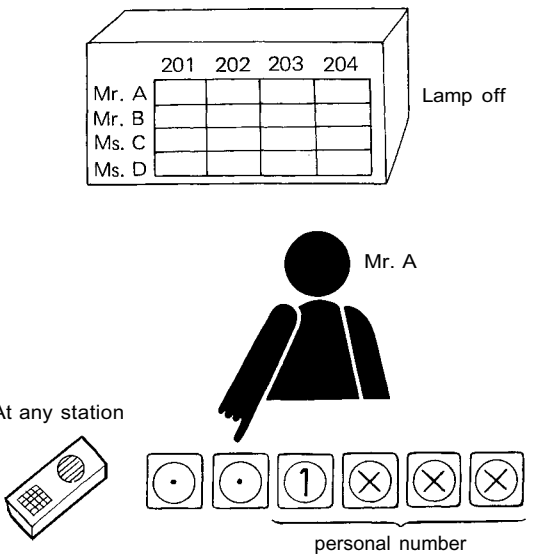

# Calling Party Indication (Lamp Type)

A one station/one lamp type calling party indication panel can be provided for certain specified stations (eight stations or eight groups of stations)

The system can also be divided into a maximum of 8 groups of stations (consecutive station numbers) so that each group may have the calling party indication panels which are common within the group. The party making the call is indicated even if the call is made to any station in the group.

Indication panel at station No. 239

<input type="radio"/> 200	<input checked="" type="radio"/> 208	<input type="radio"/> 216	<input type="radio"/> 320
<input checked="" type="radio"/> 201	<input type="radio"/> 209	<input type="radio"/> 217	<input type="radio"/> 321
<input type="radio"/> 202	<input type="radio"/> 210	<input type="radio"/> 218	<input type="radio"/> 322
<input type="radio"/> 203	<input type="radio"/> 211	<input type="radio"/> 219	<input type="radio"/> 323
<input type="radio"/> 204	<input type="radio"/> 212	<input type="radio"/> 220	<input type="radio"/> 324
<input type="radio"/> 205	<input type="radio"/> 213	<input type="radio"/> 221	<input type="radio"/> 325
<input type="radio"/> 206	<input type="radio"/> 214	<input type="radio"/> 222	<input type="radio"/> 326
<input type="radio"/> 207	<input type="radio"/> 215	<input type="radio"/> 223	<input type="radio"/> 327

### <Calling station memory>

It is also possible to equip the system with the "Calling station Memory" function. With this function, the calling party's lamp remains lit on the indication panel even if he cancels the call when the called party is on another line or in Privacy mode.

### < Indication mode without calling station memory >

1. A lamp of the calling station comes on and goes out when the conversation is over.
2. When the call is made during conversation or privacy mode, a lamp of the calling station comes on and goes out when the calling station cancels the call.

### < Indication mode with calling station memory >

1. The lamp at the station receiving the call comes on when a call is made and goes out when the conversation is completed.
2. When a call (camp-on-busy) is made to the busy or the privacy station (with the privacy switch on), the lamp of calling station comes on. The lamp will not go out even if the original call is cancelled.
3. The lamp goes out after the conversation is cancelled.
4. Dialing



without placing a call causes all lights to go out. \*1

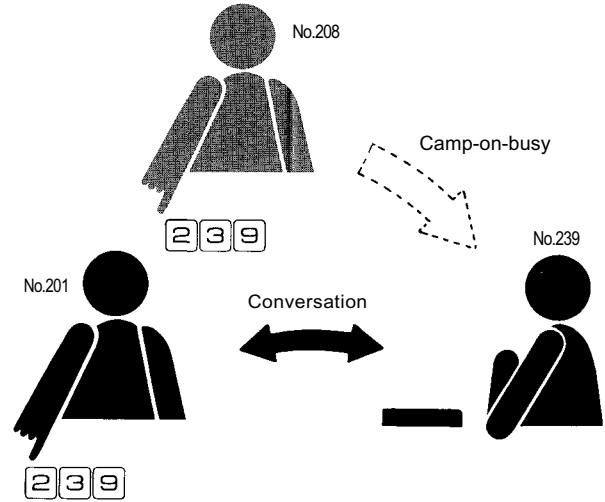

### Note.

- \*1. In the case of Handset Master station TL-600M, lift a station handset and confirm that a dial tone is heard. Press after cancelling the dial tone by pressing .

1. The maximum number of calling stations is 256. When 2 or 3 exchanges are connected by tie-lines, the party who is calling through the remote extension exchange is not indicated.
2. The indication panel must be used with the Data Transmitting and Receiving Units.
3. No.200 programming must be established in exchange "A" for stations or station groups to have the indication panel. Similarly, No.470 programming must be established in exchange "B" and No.740 programming in exchange "C".
4. If the lamp type calling party indication function is used, this makes it impossible to use the lamp type conversation partner indication function.

### Example of registration

Indication panel	First station number	Last station number
1		
2	239	239
3		
4		
5	251	255
6		
7		
8		

1. Station No. 239 has the indication panel No.2.
2. The group of stations No. 251-255 is provided with the indication panel No. 5.

**<Response to indicated calling party>**

If, during the conversation, the called party wishes to respond the calling party indicated on the panel, he can do so by pressing either.

1. (calling party's No.) (the conversation is terminated) or
2. (calling party's No.) (the conversation is placed on hold temporarily).

Indication panel at station No. 239

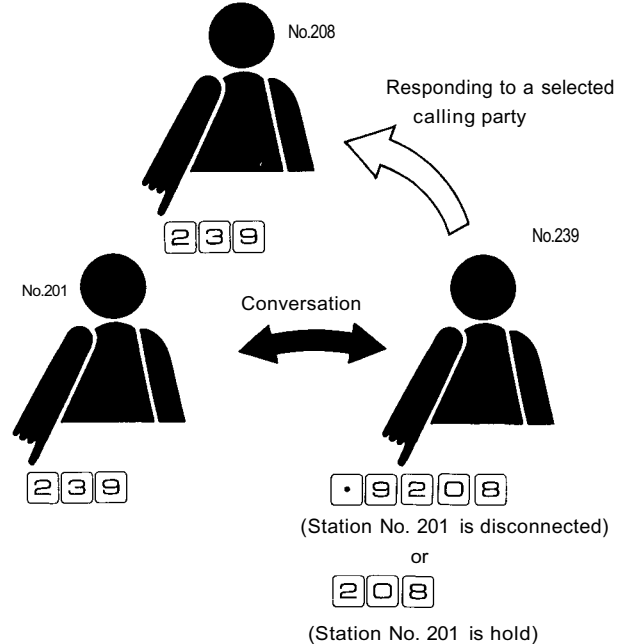
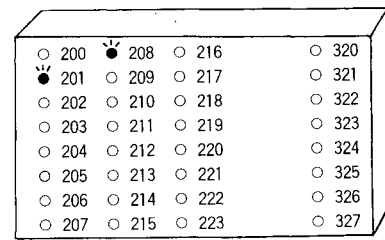

**Calling Party Indication ( Numerical Type )**

A maximum of 32 stations (No.201~No.232) can have a numerical type calling party indication panel.

1. The first conversation partner (regardless of whether he is a calling or called party) is indicated at the "Conversation partner number" with 7 segment display.
2. When there is an incoming call during the conversation or to the station having its Privacy in ON position, the calling station number is indicated at the "Waiting station number", with the "Number of waiting stations" showing 1. If there are other stations waiting, the station numbers are stored but not indicated. A maximum of 8 waiting stations can be indicated. Even if a call is cancelled by a waiting station, the indication is not cancelled.
3. When a call is placed to a station in the waiting station mode, the next waiting station is indicated.
4. If a call is finished, the indication is turned off.
5. To cancel the waiting station without responding, dial and the next waiting station is indicated. \*1

Indication panel at station No. 231

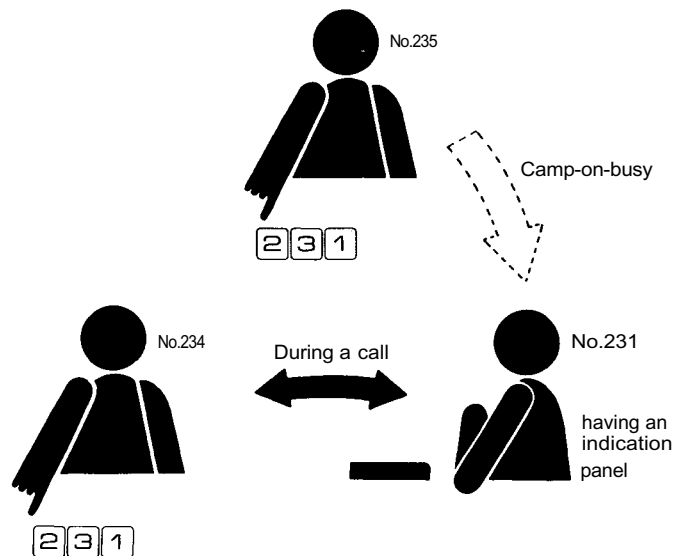
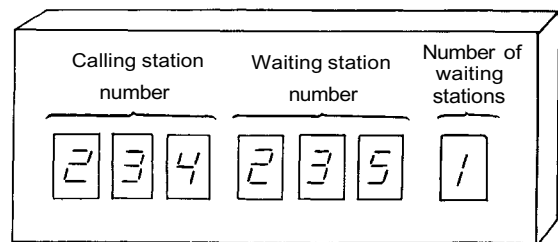

**Note.**

- \*1. In the case of Handset Master station TL-600M, lift a station handset and confirm that a dial tone is heard. Press after cancelling the dial tone by pressing .
1. If the number of waiting stations exceeds 8, the indication for the station that has been waiting for the longest period of time is cancelled and the next station moves into that place.
2. Produce the indication panel using the Data Transmitting and Receiving Units or use the master station HF-250M with liquid crystal display. For further details, refer to "Installation hand Book for CP Unit and Operation Instructions for the DT-E70, DR-B61 and HF-250M".

## Conversation Partner Indication (Lamp Type)

A one station/one lamp type Conversation partner indication panel can be provided for specific stations (eight stations or eight groups of stations). The system can be divided into max. 8 groups of stations (consecutive station numbers) so that each group may have the Conversation partner Indication panels which are common within the group. The party making the call and the party receiving the call are indicated whenever the calls are made to and made from any station in the group.

1. When a station having the Indication Panel makes a call, a lamp of the called station lights on until the conversation is cancelled.
2. When a station having the Indication Panel receives a call, a lamp of the calling station lights on until the conversation is cancelled.

### Note.

- The waiting station making a call to the station (Camp-on-busy, privacy on) is not displayed on the Indication Panel.
- Group assignment for this function should be equal to "Conversation Partner Indication" group assignment.
- Indication panel should be used with the Data Transmitting and Receiving Units.

Indication panel at station No. 239

<input type="radio"/> 200	<input type="radio"/> 208	<input type="radio"/> 216	<input type="radio"/> 320
<input checked="" type="radio"/> 201	<input type="radio"/> 209	<input type="radio"/> 217	<input type="radio"/> 321
<input type="radio"/> 202	<input type="radio"/> 210	<input type="radio"/> 218	<input type="radio"/> 322
<input type="radio"/> 203	<input type="radio"/> 211	<input type="radio"/> 219	<input type="radio"/> 323
<input type="radio"/> 204	<input type="radio"/> 212	<input type="radio"/> 220	<input type="radio"/> 324
<input type="radio"/> 205	<input type="radio"/> 213	<input type="radio"/> 221	<input type="radio"/> 325
<input type="radio"/> 206	<input type="radio"/> 214	<input type="radio"/> 222	<input type="radio"/> 326
<input type="radio"/> 207	<input type="radio"/> 215	<input type="radio"/> 223	<input type="radio"/> 327

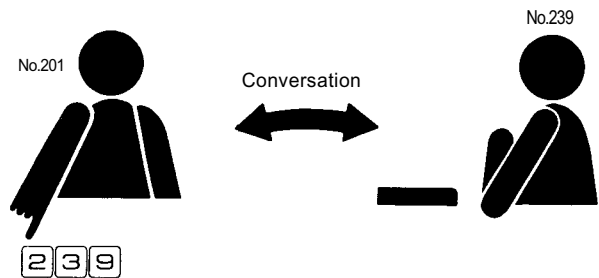



# Pocket Pager

## • Pager call and response

The system can call a maximum of 10,000 pager receivers and the party called can answer the call via the nearest station.

It is also possible to call those pager receivers having voice or display functions.

### 1. Paging

#### (1) Tone-only pager

The following two methods are available for calling tone-only pagers.

- When there is no response from the called party to the call made by dialing the station number or personal number, further dial as follows without terminating the call:

Confirmation tone is heard.

and the call is connected to the called party's pager receiver.

- To call the receiver directly, dial

(   ) Confirmation tone

Pager No.

The calling station, while waiting for a response from the pager, can receive other incoming calls.

**Table showing paging operation 1 and output digits for pager calls**

Pager digit	Two-digit dialing	Three-digit dialing	Four-digit dialing
2 digits	Station No.	Station No.	Station No.
3 digits	—	Station No.	Station No.
4 digits	Personal No.	Personal No.	Station No. Personal No.

#### (2) Pager with speech or display function

First dial   and then both the pager and function code numbers according to the pager operating instructions.

(   )  . . .

Pager No.

After all operations are completed, dial  or replace the handset.

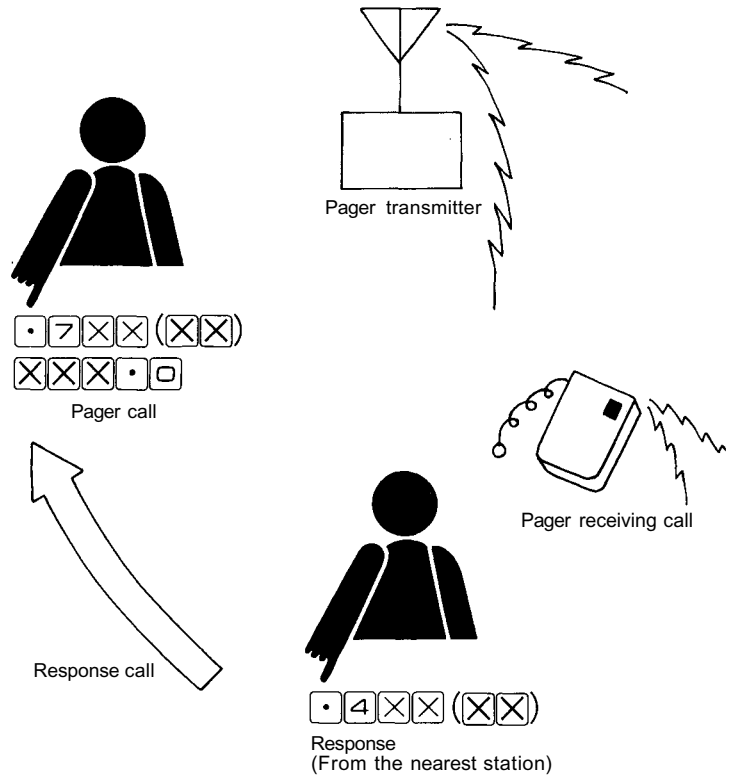

### 2. Answering

To respond to the pager call, go to the nearest station and dial:

(   )

Pager No.

### 3. Automatic pager call

Register the station for this function using No.200 programming. When the station receive a station or personal number call, that call is automatically connected to the pager.

#### Notes.

- No.200 programming must be established to register a pager output digit.
- A maximum of 16 pager receivers can be called at a time.
- A person called by pager has to respond quickly from the nearest station. Otherwise he cannot receive other calls during 3 minutes after the pager call has been made.

# General Purpose Control

Station may be restricted from access to this function. This function can control other equipments by employing the Data Transmitting and Receiving Units.

Select the required type of output.

## (Mode 1) One-shot make output (500/50 contacts)

Dial

• 3 (X) X X

0 ~ 49  
(000 ~ 499)

and the relay output is made for 1 to 2 seconds.

Example: Door remote and VTR control

Note: Operation performed even when all link circuits are occupied.

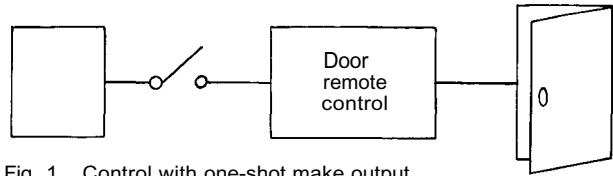

Fig. 1 Control with one-shot make output

## (Mode 2) Make/break output (512/100 contacts)

Dial

• 3 5 (X) X X

00 ~ 99  
(000 ~ 511)

and the make output is sent out.

Dial

• 3 6 (X) X X

00 ~ 99  
(000 ~ 511)

and the break output sent out.

Example: In/out annunciation, Prescription annunciation.

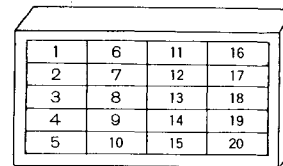

Fig. 2 Lamp on/off indication panel

## (Mode 3) 8-selectable one-shot make output (9 units)

Dial

• 3 7 X Y

1 ~ 9      1 ~ 8  
Unit No.    Contact No.

and one contact out of 8 selectable make outputs is obtained for about 1 or 2 seconds.

Example: VTR control

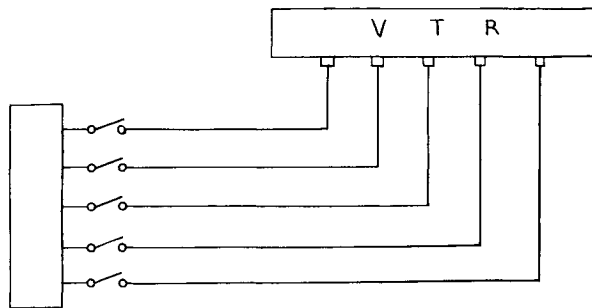

Fig. 3 VTR control with 8-selectable one-shot make output

## (Mode 4) 8 selectable make output and/or decimal output

(A) 8 selectable make output (64/9 units)

Dial

• 3 8 (X) X Y

1 ~ 9      1 ~ 8, 0 (Clear)  
(01 ~ 64)    Condition No.  
Unit No.

and one of the 8 relay outputs is made. "Clear" operation makes all 8 relays break.

Example: Destination indication, room condition indication, ITV control

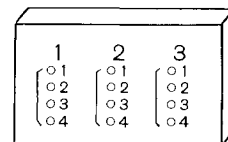

Fig. 4 8 selectable output type indication panel

## (B) Decimal output

Dial

• 3 8 (X) X Y

1 ~ 9      0 ~ 9  
(01 ~ 64)    Condition No.  
Unit No.

and the condition is indicated numerically.

Example: Destination indication, room condition

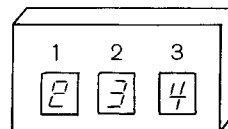

Fig. 5 Decimal output type indication panel

## (Mode 5) 4 decimal digits output

Dial

• 3 9 X Y Y Y Y

1 ~ 9      0000 ~ 9999  
Unit No.    4 decimal digits

and 4 decimal digits are indicated.

Example: Prescription annunciation

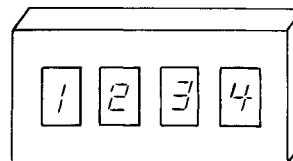

Fig. 6 4 decimal digits type indication panel

## Simplified Paging

---

If an external speaker is connected instead of a station, simplified paging can be made without the PA amplifier when the caller dials that station number and makes a paging call.

**Note.**

For further details, refer to "Installation Handbook for Exchange"

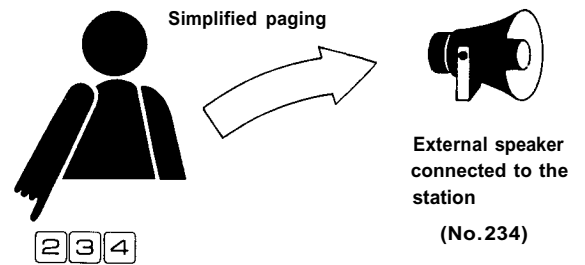

## Clear Entry and Conversation Over

---

**1. Clear entry**

In the event that an error has been made when dialing for Transfer or Conference, at the start of or during the conversation, dial



This will restore the condition before the error was made, allowing the caller to make a correction without interrupting the call.

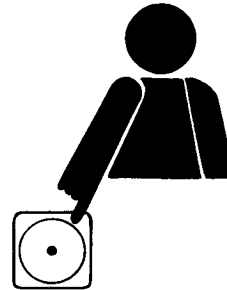

**2. Conversation over**

To terminate conversation dial  or hang up a handset.

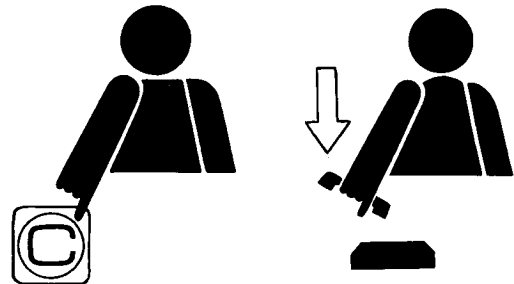

## Chapter 3

Functions and operating procedures of tie-line system

## 1. Purpose of tie-line connection

The EXES-6000 system incorporating the CP-66 central processing unit permits the use of a single exchange as well as the tie-line connection of 2 or 3 exchanges.

The tie-line connection is used when

- 1) connecting 2 or 3 exchanges installed in locations which are remote from each other (Maximum distance: About 2km. Cable: 0.65mm in diameter).
- 2) one more exchange, in addition to the existing exchange, is required for system expansion.

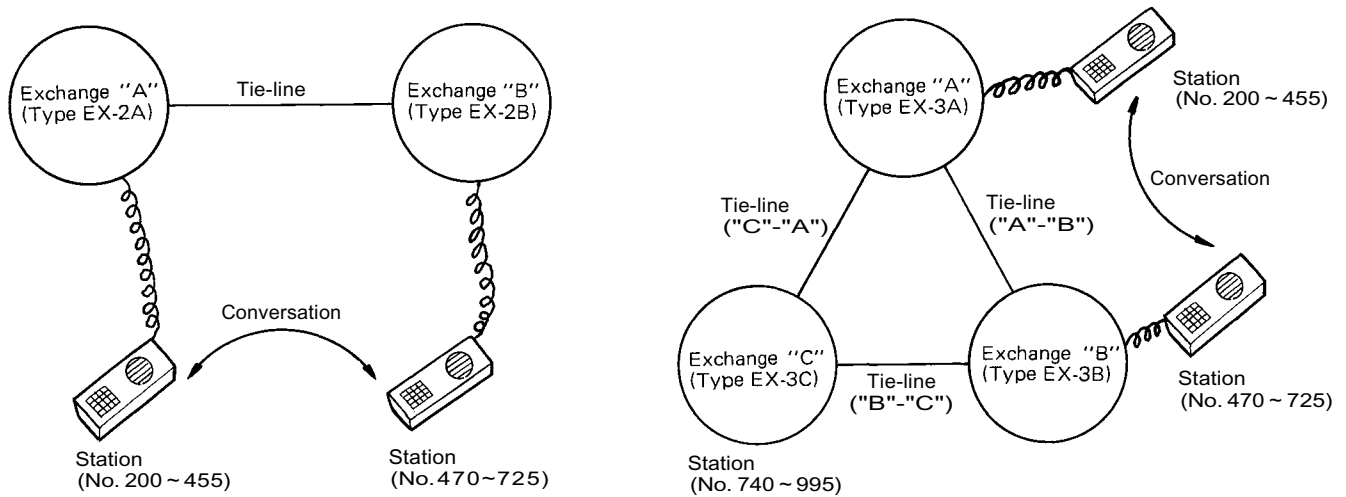

## 2. Number of stations, paging zones and links

Composition of exchange		Maximum number of links within one's own exchange	Number of links between Tie-lined exchanges	Number of exchanges	Maximum number of paging zones	Maximum number of stations in each exchange	
						Without paging	With paging
Without Tie-line Single exchange EX-1	EX-610	12	—	1	All station calls + 7 zones	56	48
	EX-620	16	—	1	All station calls + 7 zones	120	112
	EX-630	16	—	1	All station calls + 31 zones	256	256
2 exchanges Tie-lines Exchange A — Exchange B EX-2A EX-2B	EX-610	12 <sup>*1</sup>	8	2	All station calls + 14 zones <sup>*4</sup>	112	96
	EX-620	16 <sup>*1</sup>	8	2	All station calls + 14 zones <sup>*4</sup>	240	224
	EX-630	16 <sup>*1</sup>	16 <sup>*2</sup>	2	All station calls + 30 zones <sup>*4</sup>	512	512
3 exchanges Tie-line EX-3A Exchange A Exchange B — Exchange C EX-3B EX-3C	EX-610	12 <sup>*1</sup>	4 per Tie line	3	All stations calls + 21 zones <sup>*4</sup>	168	144
	EX-620	16 <sup>*1</sup>	4 per Tie line	3	All stations calls + 21 zones <sup>*4</sup>	360	336
	EX-630	16 <sup>*1</sup>	8 per Tie line <sup>*3</sup>	3	All stations calls + 45 zones <sup>*4</sup>	768	768

\*1 Speech links of the local exchange are also used for communication between exchanges.

\*2 One (8 links) or two tie-line interface (TI-62) are required per exchange.

\*3 Two tie-line interface (TI-62) are required per exchange.

\*4 All-call paging from one exchange is placed over the whole area of all exchanges connected.

\*5 Different types of exchanges (EX-610/620/630) can be combined for tie-line connection.

### 3. Numbering Schedule for Stations and Paging Zones

① Standard schedule (when personal Nos. are provided)

Type of exchange	System	Numbering for stations		Numbering for paging zones	
		Without paging	With paging	Paging zones/exchange	
				All station calls	Zones
EX-1 (Single)	EX-610	200~263	200~255 (247)* <sup>1</sup>	00	01-07 (15)* <sup>1</sup>
	EX-620	200~327	200~319 (311)* <sup>1</sup>		01-07 (15)* <sup>1</sup>
	EX-630	200~455	200~455		01-07 (31)* <sup>1</sup>
A EX-2A/EX-3A	EX-610	200~247, 256~263	200~247		01~07
	EX-620	200~311, 320~327	200~311		01~07
	EX-630	200~455	200~455		01~15
B EX-2B/EX-3B	EX-610	470~517, 526~533	470~517		08~14 (16~22)* <sup>2</sup>
	EX-620	470~581, 590~597	470~581		08~14 (16~22)* <sup>2</sup>
	EX-630	470~725	470~725		16~30
C EX-3C	EX-610	740~787, 796~803	740~787		15~21 (31~37)* <sup>2</sup>
	EX-620	740~851, 860~867	740~851	15~21 (31~37)* <sup>2</sup>	
	EX-630	740~995	740~995	31~45	

\*1 When the paging dial operations is set for

\*2 When the EX-610 or EX-620 is connected to the EX-630 by tie-line.

② When no personal Nos. are provided

Type of exchange	System	Numbering for stations		Numbering for paging zones	
		Without paging	With paging	Paging zones/exchange	
				All station calls	Zones
EX-1 (Single)	EX-610	100~163	100~155 (147)* <sup>1</sup>	00	01-07 (15)* <sup>1</sup>
	EX-620	100~227	100~219 (211)* <sup>1</sup>		01-07 (15)* <sup>1</sup>
	EX-630	100~355	100~355		01-07 (31)* <sup>1</sup>
A EX-2A/EX-3A	EX-610	100~147, 156~163	100~47		01~07
	EX-620	100~211, 220~227	100~211		01~07
	EX-630	100~355	100~355		01~15
B EX-2B/EX-3B	EX-610	400~447, 456~463	400~447		08~14 (16~22)* <sup>2</sup>
	EX-620	400~511, 520~527	400~511		08~14(16~22)* <sup>2</sup>
	EX-630	400~655	400~655		16~30
C EX-3C	EX-610	700~747, 756~763	700~747		15~21 (31~37)* <sup>2</sup>
	EX-620	700~811, 820~827	700~811	15~21 (31~37)* <sup>2</sup>	
	EX-630	700~955	700~955	31~45	

\*1 When the paging dial operations is set for

\*2 When the EX-610 or EX-620 is connected to the EX-630 by tie-line.

## 1. Paging

- 1) Paging is possible for up to 15 zones per exchange.
- 2) The whole area of all exchanges can be called by all-call paging.
- 3) It is possible to make an all-call paging and an individual zone paging from any master station.
- 4) It is possible to respond to all-call paging from any master station.
- 5) A response to the individual zone paging is only possible from the station connected to the exchange corresponding to that paging zone. If the Automatic Paging Response (  ) is employed, a response to the zone paging is only possible from the station (consecutive number) which belongs to that zone.
- 6) Paging assignment is impossible beyond the local exchange.

## 2. Programmable Station Numbering

It is possible to change station numbers of each exchange within the limit specified in "Selectable numbering schedule of each exchange".

## 3. Group Blocking

- 1) The system can be divided into a maximum of 6 groups per exchange.
- 2) It is possible to set up the calling and called groups as desired within the same exchange.
- 3) Only one pair of stations can call each other between exchanged connected by tie-line.
- 4) Arbitrary station groups can be restricted to access all-call and individual zone paging.
- 5) Calling and called groups must be set up to make a paging response possible. The paging response is possible from the called group to the calling group (reverse direction of call restriction).

## 4. Below are functions that can be operated for the same exchange but cannot be operated extending over more than one exchange connected by tie-line.

- 1) Remote Response
- 2) Master/Sub Relationship
- 3) Call Transfer
- 4) Paging during Normal Calls
- 5) Group Hunting
- 6) Secretary Transfer
- 7) General Purpose Control (One-shot Make Output, Make/Break Output, 8 Selectable Make Output, Decimal Output, 4 Decimal Digits Output). Even when dialed correctly, different indications result or unintended control equipment are operated if the function extends over more than one exchange.
- 8) Calling Party Indication (Lamp Type)
- 9) Pager Call

Function	Dialing operation	Number assignment
Press-to-talk	(PTT) One-way conversation    [PTT] Two-way conversation	
Remote response	(PTT)	
Remote response registration	[PTT][X][X][X] Confirmation tone	[X][X][X]: Station No.
Answering continuous calling tone	[1]~[9], [0], [•] or [C]	
Privacy	PRIVACY [ON] ON  PRIVACY Privacy off [ON] ON	
Secretary transfer	PRIVACY [ON] ON  PRIVACY Secretary transfer [ON] ON	
Single-digit registration	[•][6][0][X] • • [X] (PTT) Registration dials (maximum 6-digits)	
Single-digit dialing	[0]	
Personal number registration In/out indicator lamp ON	[•][6][1][X][X][X] Confirmation tone Personal No.	[1][X][X][X] : 1000~1999
Personal number cancellation In/out indicator lamp OFF	[•][1][X][X][X] Confirmation tone Personal No.	
Personal number call	[1][X][X][X] Personal No.	
Conference	[•][6][X][X][X] Calling [X][X][X] Calling [X][X][X] Calling [X][X][X] Calling	[X][X][X]: Station No.  Personal No.  Single-digit No.
Conference clear	[•][•]	
Busy call back registration	[X][X][X] Busy tone [6] Confirmation tone	[X][X][X]: Station No. Personal No. Single-digit No.
Busy call-back response	Busy call-back tone [0]~[9], [0], [•] or [C]	
Highest executive priority	[X][X][X] Busy tone [9][9]	[X][X][X]: Station No. Personal No. Single-digit No.
Call transfer	[X][X][X] Call/conversation → [C] Transfer → [•][•] Conversation with original station	[X][X][X]: Station No. Personal. Single-digit No.
All call + 45-zone paging	[•][6][X][X]	[X][X] : 00 (All station call) 01 through 45 (zones)
All call paging response	[•][0] or [•][9][0][0]	
Zone paging response	[•][9] or [•][9][X][X]	[X][X] : 01~45
Paging transfer	Conversation [•][6][X][X] Paging Conversation after answer → [C] → [•][•] Conversation with original station	[X][X] : 00~45



Function	Dialing operation	Number assignment
One-shot, relay-make output	☐☐ (X) ☐☐	☐☐ : 00~49 ☐☐☐☐ : 000~499
Relay make-break output	☐☐☐ (X) ☐☐ Confirmation tone ☐☐☐ (X) ☐☐ Confirmation tone	☐☐ : 00~99 ☐☐☐☐ : 000~511
8-selectable, one-shot, relay make output	☐☐☐☐ Y Confirmation tone	☐ : 1~9 Y : 1~8
8-selectable output (Decimal output)	☐☐☐ (X) ☐☐ Y Confirmation tone	☐ : 1~9 ☐☐ : 01~64 Y : 1~8, 0 (Clear) (☐☐) : 01~99 ( Y ) : 0~9
4-digit decimal output	☐☐☐☐ X Y Y Y Y Confirmation tone	☐ : 1~9 Y Y Y Y : 0000~9999
Pager call	☐☐ (X) ☐☐☐☐ ☐☐☐☐☐☐	☐☐ : 00~99 ☐☐☐☐ : 000~999 ☐☐☐☐☐☐ : 0000~9999 ☐☐☐☐ : Station No.
Pager response	☐☐ (X) ☐☐☐☐	☐☐ : 00~99 ☐☐☐☐ : 000~999 ☐☐☐☐☐☐ : 0000~9999
Calling station selection	☐☐☐☐☐	☐☐☐☐ : Station No.
Message recording	☐☐☐ (8 sec) ☐☐☐ (16 sec) ☐☐☐ (32 sec)	
Message check	☐☐☐	
Message playback	PRIVACY ON or ☐☐☐☐	
Message cancellation	☐☐☐ (Confirmation tone)	
Remote message playback	☐☐☐☐☐☐☐☐	☐☐☐☐ : Station No.
Clearing calling party indication	☐☐	
BGM	☐☐ PTT ☐	☐ : Channel select

When the party you are calling is on another line, by simply waiting you automatically "Camp-On" the line. (Busy tone sounds continuously.) As soon as the line is freed, you will be automatically connected.

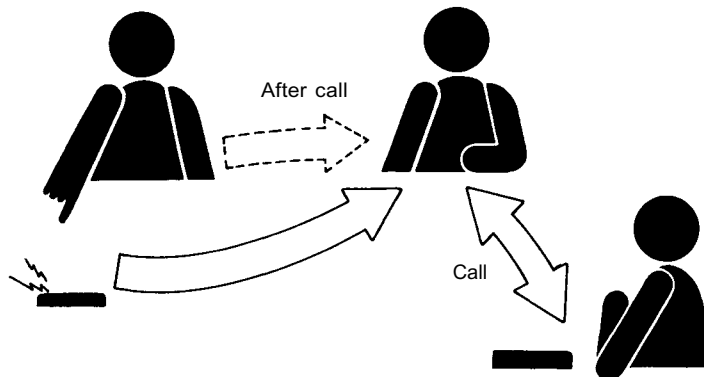

## Busy Call Back

When the called station is busy, dialing  permits this function to be registered and terminates the call after a confirmation tone. As soon as the line is freed, the calling party is called by the distinctive "busy-call-back" tone that sounds for 10 seconds. By one-touch dialing any one of  ~ , , , or  key during the 10-second period, the calling party can be connected to the called party.

### • Registration

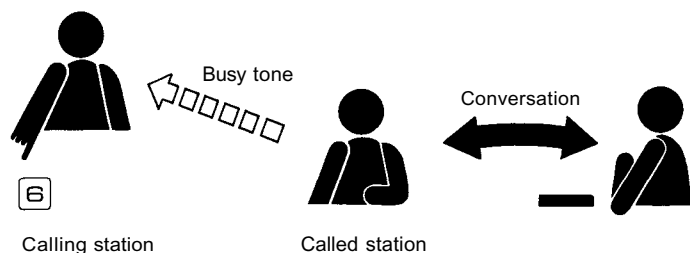

The disadvantage of the camp-on-busy function is that a link is occupied and busy tone is heard from your station all the way while you are waiting. This problem can be avoided by using the busy call back function that can improve the availability of speech paths as well as enables you to wait without being annoyed by "noisy" busy tone.

A maximum of 15 stations can be registered for this function. Once the function has been programmed into your station, you are put in the simple "busy waiting" mode even when you depress 6 in an attempt to register other busy stations for this function.

It is possible to make or receive other calls while waiting after this function has been programmed. However, if you are still using your station for conversation with the third party when the busy station registered for this function is freed, the registered busy call back function will be cancelled.

Camp-on-busy is prior to busy call back.

### • Line has been freed.

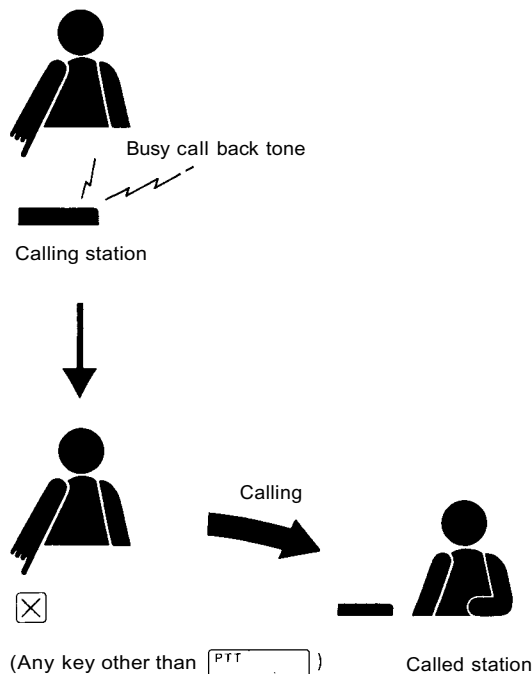

Shift Privacy Switch to ON.



When a party does not wish to accept incoming calls, this function may be employed to refuse them. With the Privacy switch in the ON position, a continuous privacy tone will be sounded in the station making the call, and at the same time, a brief Privacy tone will sound in the station called, indicating a call attempt is being made.

It is possible to call the other party from the station in the Privacy mode but Remote Response (PTT) is impossible from that station.

Shift Privacy Switch back to the left.



To restore a station in the "Privacy" mode to a normal condition, and thus ready to receive calls.

- Note: 1. A call received while the station is in the Privacy mode may be accepted if the Privacy function is immediately cancelled. (see Camp-On Privacy)
2. In the event of the station registered for the Secretary Transfer function, the Privacy switch is used on and off operation of the Secretary Transfer function. (see Secretary Transfer)
3. During the above "Privacy" mode, while the calling station has the (PTT) bar depressed, the privacy tone stops and the caller can transmit a one way message.
- When the (PTT) bar is released, the normal "Privacy" mode to be resumed.

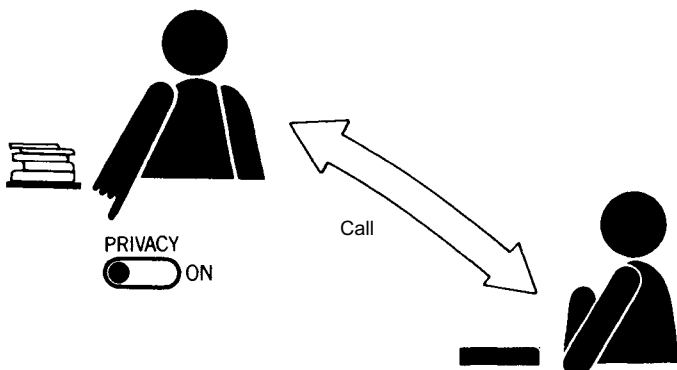
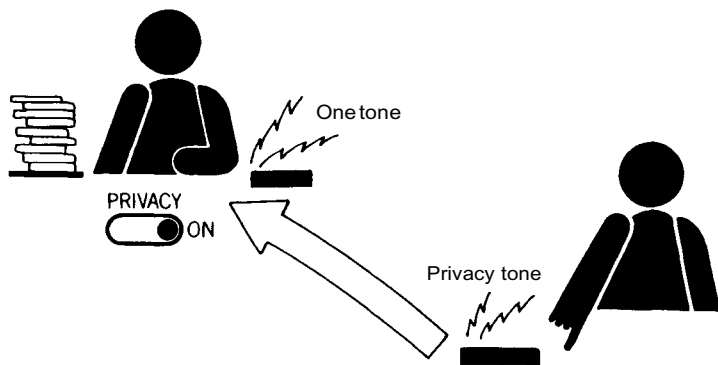

When the party you are calling has his station on Privacy mode, by simply waiting you will automatically "Camp-On" the line. (Privacy tone sounds continuously.) As soon as the Privacy mode is released, or as soon as he one-touch dials any of the keys (1~9, \*, #), or as soon as he picks up a handset of his station, you will be automatically connected.

This function is cancelled automatically if the station in the privacy mode may not accept the call within approximately 10 seconds.

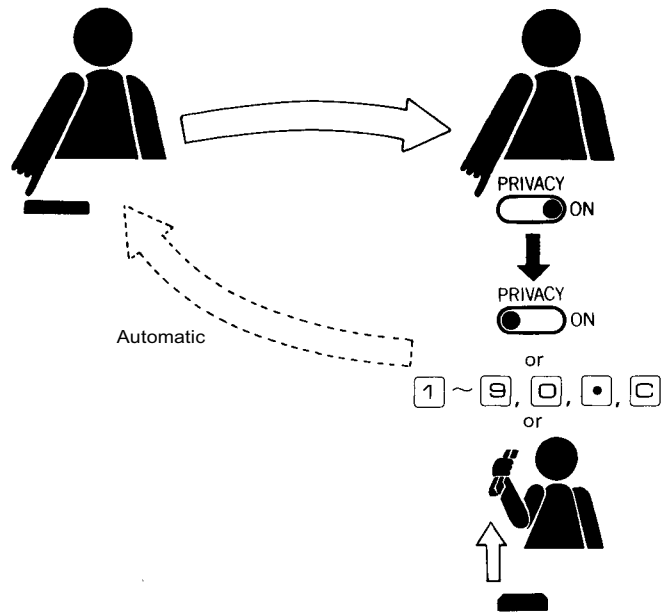

## Press-To-Talk

This function is activated when the

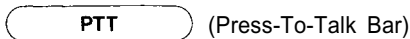

is continuously depressed after dial tone confirmation or during hands-free conversation. This allows one-way conversation from the party depressing the function key. When the key is released, one-way conversation is reversed.

Employ when a person in a high noise level area is called by a person in a quiet area, or when no particular response is required, or when simple announcements are made. In such cases, one-way conversation flow can be used.

One-way conversation is activated while the Press-To-Talk bar is continuously depressed.

As long as the Press-To-Talk bar is depressed by either party, the voice of the party using this function has dominance. When the key is released, the other party has dominance.

One-way conversation is reversed when the Press-To-Talk bar is released.

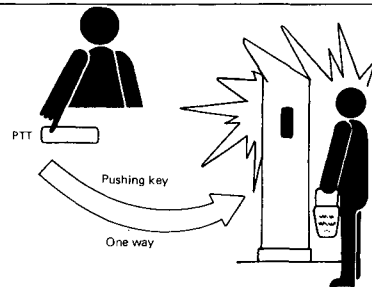

If both parties depress the Press-To-Talk bar, the voice of the party who depresses the bar last will have dominance.

Depress the



to return to ordinary hands-free 2-way conversation .....

### Note.

One-way conversation is impossible even if the **PTT** bar is depressed unless either party or both parties involved pick up a handset.

## Single digit registration

Register in advance as follows:

- Confirmation tone (Station number)

Station number
- Confirmation tone (Personal number)

Personal number
- Confirmation tone (Paging call)

Paging zone
- Confirmation tone (All-call paging response)
- Confirmation tone (Each function)

Any six digits
- Confirmation tone (Each function)

Any five digits
- Confirmation tone (Each function)

Any four digits
- Confirmation tone (Each function)

Any three digits
- Confirmation tone (Each function)

Any two digits

< Single digit dialing >

When required, dial



and the registered number will be called automatically.

- Note:**
- To cancel the registration, dial the station number of the station at which this function has been registered.
  - It is also possible to use this function to shorten the long dial operation.

Example.

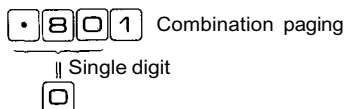

Simply dialing   makes the combination paging instead of dialing   .

- Single digit registration is not available from any substation programmed by No.200 programming, even if its line is connected with master station.

Master/Substation associations are set up by using station #200 as the programming station. Once these relationships have been established, substations can then contact their designated master stations by simply touch dialing



If TL-600S Handset substation is used, it can be connected to its designated master station by simply picking up a handset.

With respect to this function, the stations in the system are divided into two categories; master stations and substations. Any master station can be connected to any other station in the system. However, substations can initiate calls only to specific master stations. This is done by single touch dialing, and will only connect the substation to one specific master.

Also, one master station can have 2 or more substations.

To register this function, dial

• 6 0 X X X PTT Confirmation tone

Substation No. paired off with the master

at the master station. This allows the master station to be connected to the substation when  is pressed.

**Note.**

Once a certain station number has been designation as a substation by No. 200 programming, the single digit dialing is impossible even when the master station is connected to that number.

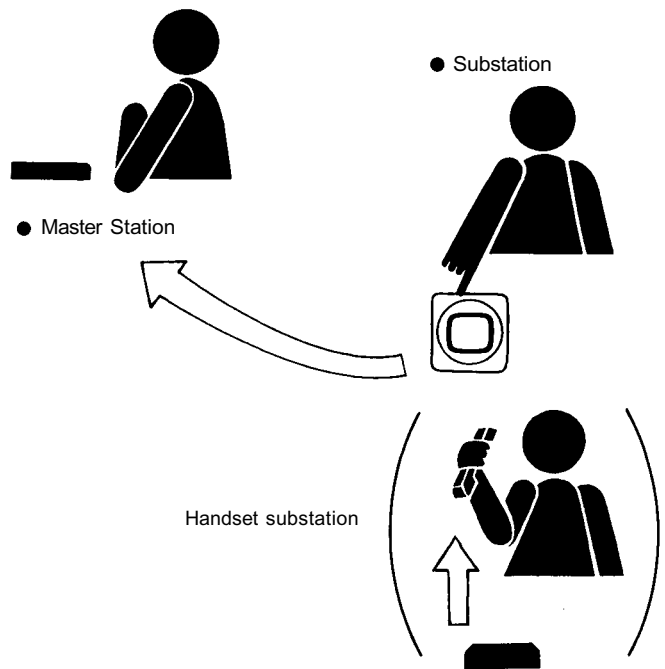

• Single Digit Registration of Substation

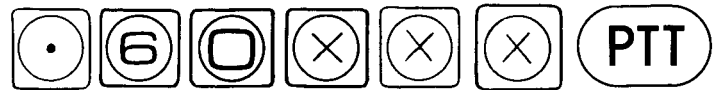

• Master Station

Substation Number

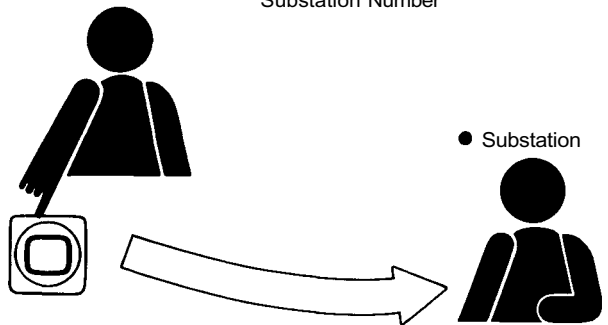

## Automatic Access To Paging

This function requires "single digit dialing registration for handset station" as well as No.200 programming at time of installation.

A paging call can be placed over the specified zone by simply lifting the handset.

A paging response is possible by simply lifting the handset.

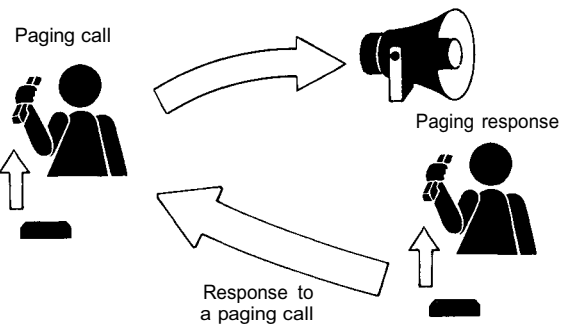
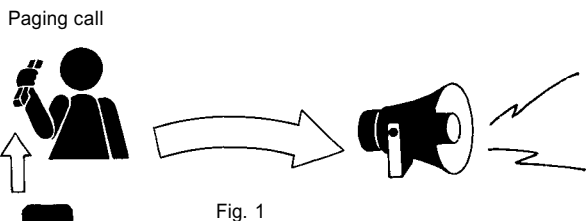

A personal number may be registered at any master station which the person to whom the number is assigned expects to be. A party wishing to receive personal number calls at a specific station may register his number at that station by touch dialing

• 6 1 X X X Confirmation tone

Personal Number.

Those who are frequently away from their assigned station, as well as those who share a single station may be assigned a "Personal" 4-digit number which may be programmed to any master station in the system. This personal number, which is completely independent of station numbers, may be programmed at any master station, and any previous programming of that same number at any other station is automatically cancelled. When the party calling has dialed the number to which he wishes to speak, the call is then routed to the station at which the Personal Number was last registered. The numbers which may be assigned in this group are 1000 through 1999.

Personal number program cancellation can be done at any station by merely dialing:

• • 1 X X X Confirmation tone

Personal Number

When anyone having a personal number leaves the office, he merely cancels the programming of his personal number. With the personal number cancelled, any incoming calls to that number will be answered by a dial tone, indicating that he is not available.

**Note.**

The maximum number of the Personal Number remains same even if the number of exchange to be connected is increased to 2 or 3.

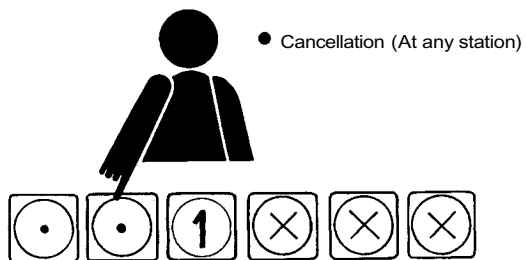
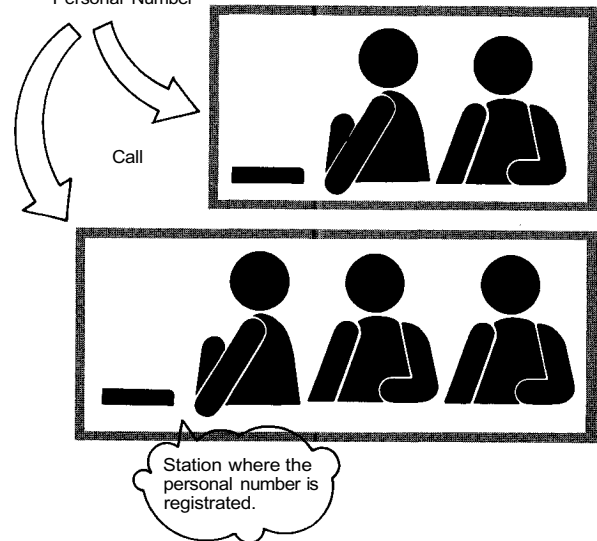
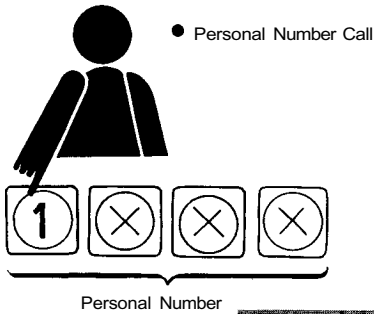
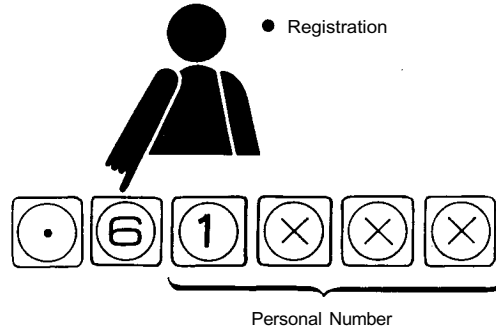

When there is an incoming call to the specified station, a calling tone is sounded continuously at the called station. The continuous calling tone stops if the called party presses

1~9, \*, or #  
(except **PTT** key)

1. Use this function when it is difficult to hear a brief single tone due to high background noise. Any station can be so made as to be called by the continuous calling tone, but No.200 programming is required for such a station (refer to Installation Handbook for EXES-6000 CP-66).
2. If the calling party presses the **PTT** key while the continuous calling tone is being sounded, the continuous calling tone stops to allow the caller's voice call to go through. Releasing the **PTT** key restores the continuous calling tone.
3. If either party continuously presses the **PTT** key during the normal two-way conversation, this makes a one-way conversation from the party who pressed the **PTT** key. Releasing the **PTT** key reverses the one-way conversation flow and the other party has a dominance (Press-to-Talk).

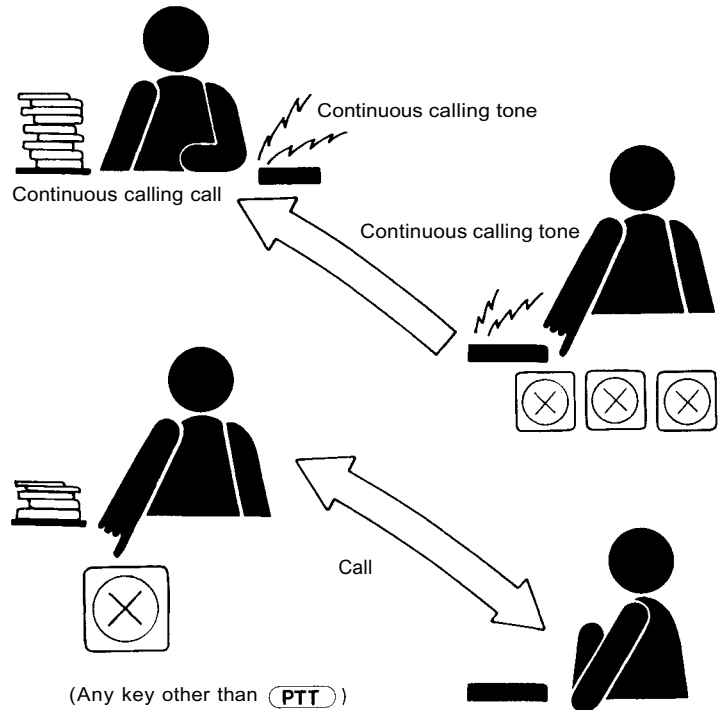

**Notes.**

1. In the NP type system that has no Privacy function, the station can be called by the continuous calling tone if its Privacy switch is set to ON. This function by No.200 programming is, therefore, used in the PV type system having the Privacy function or for the HF-670M industrial type station equipped with no Privacy switch.
2. The following stations can be called by the continuous calling tone:
  - (1) Stations in the "NP" type system or specified substations in the "PV" type system.
  - (2) Stations registered for continuous calling tone by No.200 programming.

< Station vs. calling tone >

Type of system	Type of station (Specific station provided with "continuous calling tone" function by station No.200 programming)	Type of calling tone	
		Privacy switch in OFF position	Privacy switch in ON position
"PV" Type	Non-programmed station (standard)	Single "trill" calling tone (Call is put through immediately after calling tone)	Privacy tone
	Programmed station	Continuous calling tone	Privacy tone
	Handset programmed station	—	Continuous calling tone
"NP" Type	Non-programmed station (standard)	Single "trill" calling tone (Call is put through immediately after calling tone)	Continuous calling tone
	Programmed station	Continuous calling tone	Continuous calling tone
Responding to a call made by continuous calling tone		Depress any dial key other than <b>PTT</b> key.	1. Depress only dial key other than <b>PTT</b> key. 2. Pick up a handset. 3. Shift Privacy switch to OFF.



A call to a certain station can be remotely responded to from the other station by simply depressing **(PTT)** while a continuous call tone is ringing or within 5 seconds after a brief call tone has stopped ringing.

**Notes.**

1. The Remote Response is only possible among stations programmed for this function.
2. When making the remote response from the station having its Privacy switch in ON position, shift the switch back to OFF or lift its handset before depressing **(PTT)**.

◆ **Programming the remote response group**

Establish the remote response group of stations and designate a specific station within the group as a temporary "Master station" and the rest as "Substations".

Set up the "Master station" by dialing.

**6** **(PTT)**    Confirmation tone  
 Station No. to become "Master station".

Register the "Master station" No. at the "Substation" by dialing

**6** **(PTT)**    Confirmation tone  
 Master's number

**Note.**

Be sure to register the station No. that becomes the "Master station" at the "Master stations".

◆ **Cancelling remote response programming**

Touch dialing at each "Substation"

**6** **(PTT)**    Confirmation tone  
 His own Substation number  
 cancels the Remote response program.

**Note.**

When 2 or 3 exchanges are connected by tie-line, select the Remote response group within the stations connected to the same exchange.

● **Dial operation for Remote response**

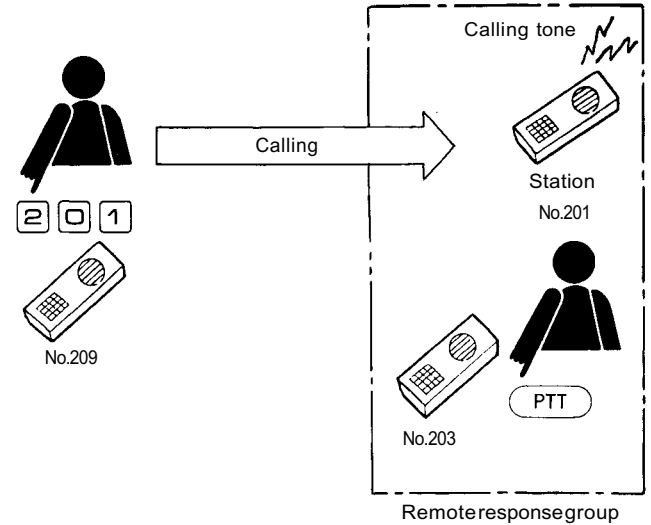

● **Conversation after Remote response**

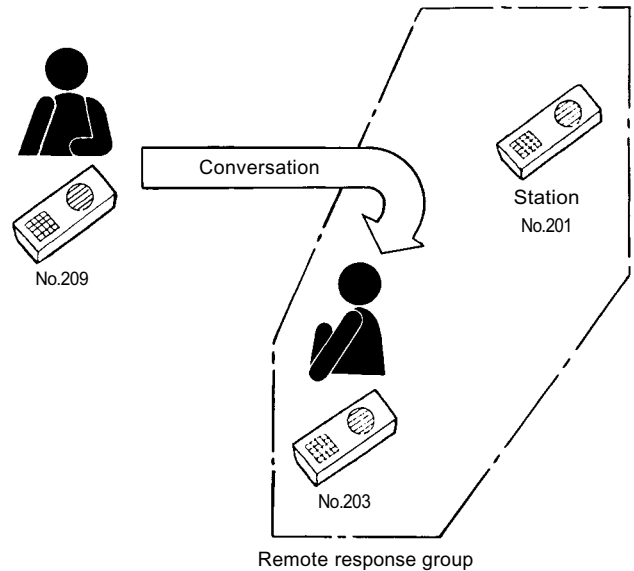

● **Programming the remote response group (Example)**

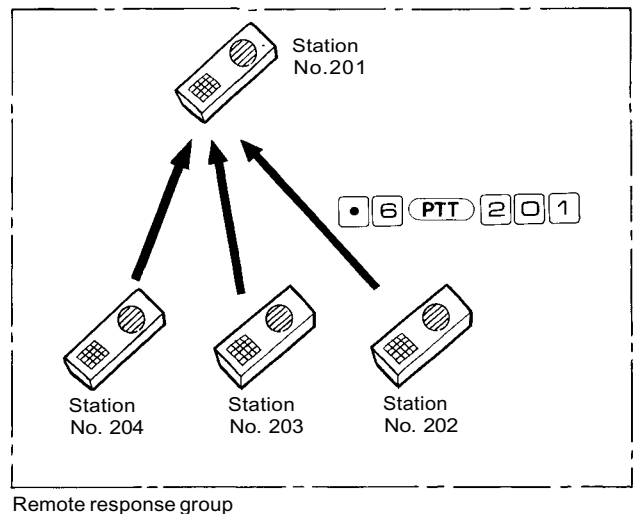

## Call Transfer from Called Station

During the conversation, first dial



(the Station Number of the person the call is to be transferred to).

The original call is then held and the holding tone is transmitted to the other party, while the third party is called and asked whether he will accept the call. If he agrees to accept the call, dial  or hang up a handset,

and the transfer will be completed.

This function allows called party to transfer that call to another station. The party to whom the call is to be transferred, may be called using either the Station Number, the Personal Number or through Single Digit Dialing.

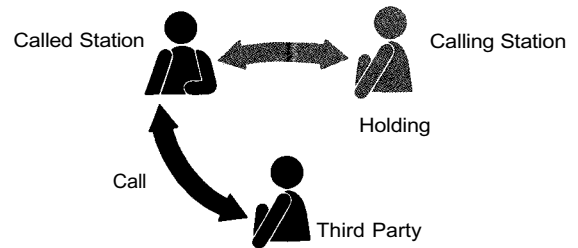
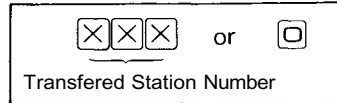
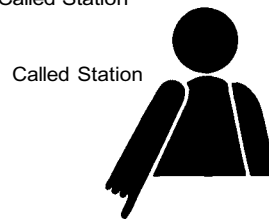
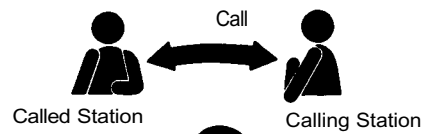

## Call Hold and Call Back from Calling or Called Station

During the conversation, first dial



(Station Number of the third party.)

The other party is then placed on hold while the third party is called. Upon completion of the conversation with the third party,

dial



or the third party dials

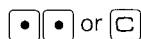

or the third party replaces a handset.

This allows the original conversation to resume.

The Transfer function is combined with the Call Holding function.

When two parties are talking, either one can be temporarily placed on hold to permit the call to another station. When the conversation with the third party is over, the original conversation can be resumed.

The third party can be called using either the Station Number, his Personal Number or through Single Digit Dialing.

● Transfer

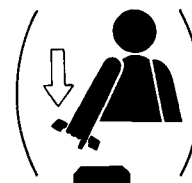
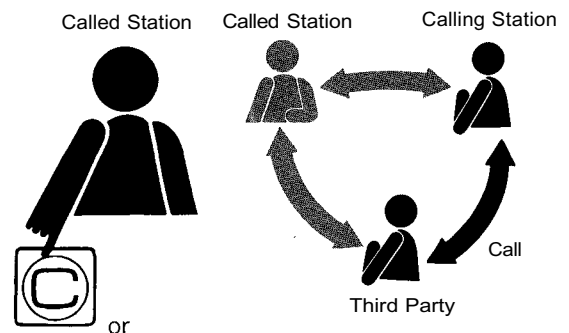

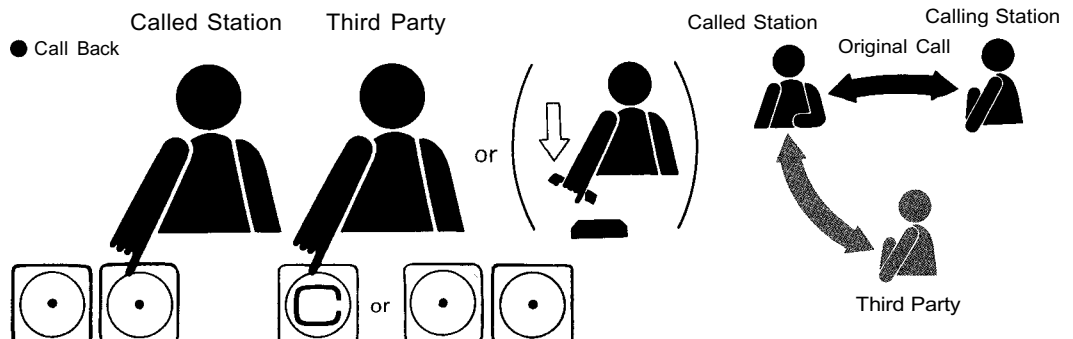

### Note.

When 2 or 3 exchanges are connected by tie-line, an original call can be transferred only to the third party who shares the same exchange with the party who transfers the call.



A paging call can be made by a called party of an existing call to a third party, the third party's response accepted while the original call is on hold, and the original call resumed when the response call has ended.

Press  and the desired zone number. This puts the original call on hold and makes the External PA and or Station paging call. Then, press



to restore the original call, and wait for the response to the paging call. When the response is received, press



or replace the handset and the original call goes back on hold allowing the second call to be taken. When the second call is completed, press



and the original call can be resumed.

•When EX-610 or EX-620 is used.

**Note.**

1. With adoption of the selective functions "Call Transfer" and "Paging", this function is allowed to activate.
2. When 2 or 3 exchanges are connected by tie-line, paging during a normal call is only possible within the paging zones allocated to the exchange to which a station making the paging is connected. An All-call paging during a normal call is impossible.

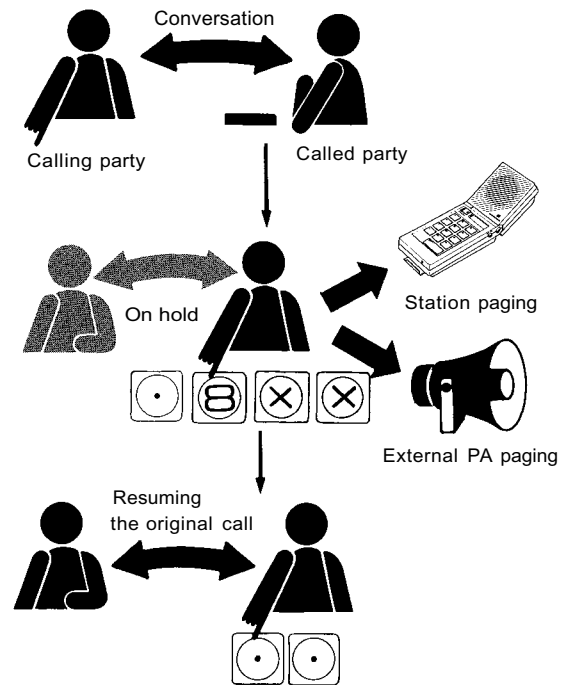

## Group Hunting

When the party you are calling is on another line, your call is automatically rerouted to another station which is programmed from the beginning. When the party to whom the call is rerouted is also on another line, the call can further be rerouted to the other station by programming.

**Note.**

1. To use this function, station No.200 programming of the station number(s) to which the call is to be transferred must be set up in the exchange. Place a DIP switch for Group Hunting in the ON position and make Group Hunting programming, so that this function can be programmed.
2. The combined use of this function with the "Secretary Transfer" function makes the system more functional. When "Secretary Transfer" function is employed, setting the Privacy switch to the ON position allows any incoming call to be automatically transferred to the other stations even when one is absent.
3. If station No. 200 programming is made so that the call can be rerouted to the station which is called first when the other stations registered are busy, then any call can be transferred automatically to another station. Similarly, the original call can be rerouted one after another in the "Secretary Transfer".
4. When 2 or 3 exchanges are connected by tie-line, select the station to which the call is to be transferred within the same exchange group.

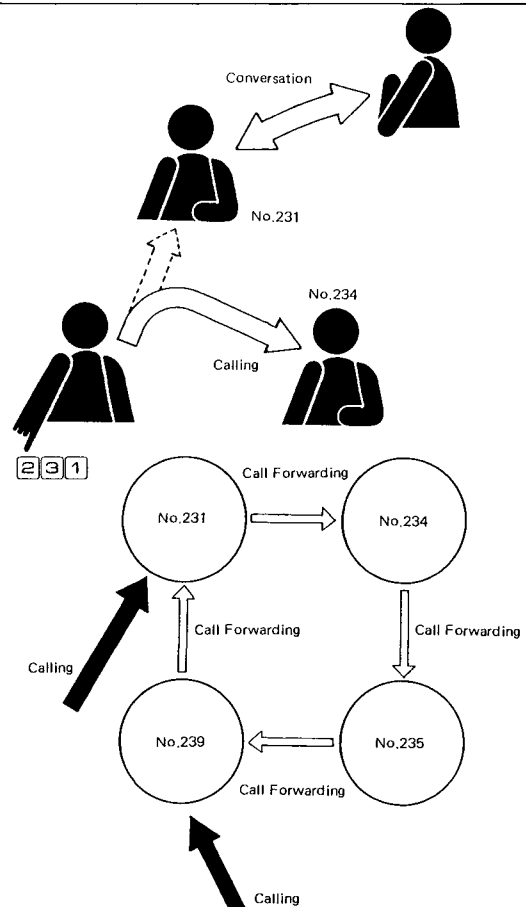

# Secretary Transfer

This function is only available when a specified station is programmed for this purpose with use of Station #200 in the programming mode. Automatic transfer of incoming calls by an executive to his secretary is accomplished by placing the Privacy Switch on his station in the ON position.

PRIVACY  

This function allows a secretary to accept all incoming calls placed to an executive.

For the executive to accept calls directed to his station once the automatic secretary function has been programmed by station #200, he simply moves the privacy switch to the left, or OFF position.

PRIVACY  

It is also possible for the executive to accept calls at his station.

There is no limit to the number of Executive/Secretary pairings except by the number of available number combinations within a given system.

When a secretary who is already programmed for this function wishes another secretary to accept all incoming calls directed to an executive, station No. 200 programming of another secretary should be set up in the exchange. Then, the calls can be rerouted to another secretary if the executive and the secretary first registered place their Privacy switches in the ON position. It is also possible to transfer the call in a daisy chain method.

**Note.**

When 2 or 3 exchanges are connected by tie-line, set up a Secretary/Executive association within a group of stations connected to the same exchange.

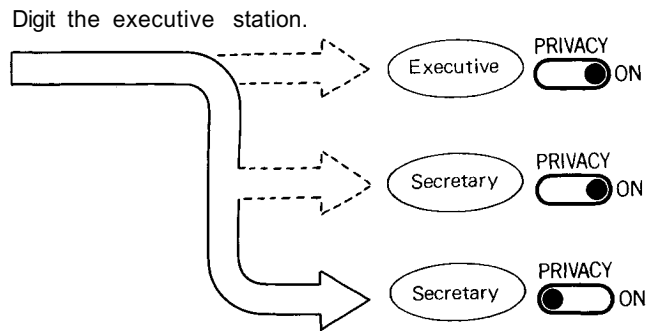
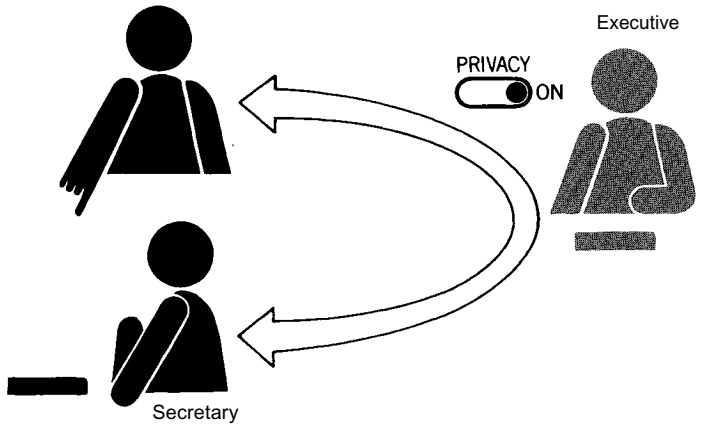

# Secretary Transfer and Call Transfer

Combination of the secretary transfer and call transfer allows rerouting of the call transferred to the secretary back to the executive's station.

When the secretary answering a call touch dials

Executive's station number

the privacy tone sounds continuously at both stations, while the call is held. The holding tone is transmitted to the calling station. If the executive shifts the privacy switch to the left position, or if he depresses any of the keys other than the (PTT) key (~, , , , ), or picks up a handset he can talk with the secretary. If the call held is to then be transferred back to the executive's station, the secretary is to touch dial , or to hang up a handset, and the original calling station will be connected to the executive's station.

## Secretary Transfer and Call Transfer using Single Digit Dialing

Combination of "Secretary Transfer", "Call Transfer" and "Single Digit Dialing" allows simple retransfer of the call transferred to the secretary back to the executive's station.

Touch dial

(PTT) Confirmation tone

Executive's station number

at the secretary's station in advance. When the call transferred to the secretary has to be transferred back to the executive, the secretary simply touch dials

at her station. This sends the continuous Privacy tone to both stations while the call is held. If the call is to be transferred back to the executive's station, the secretary touch dials  or hangs up a handset.

The calling station will then be connected to the executive's station.

If there is no answer from the executive, the secretary touch dials

and the original call is resumed.

Unless the executive sets his station Privacy switch to OFF within 10 seconds after the Privacy tone has sounded, the call attempt to the executive is cancelled for automatic return to the original conversation.

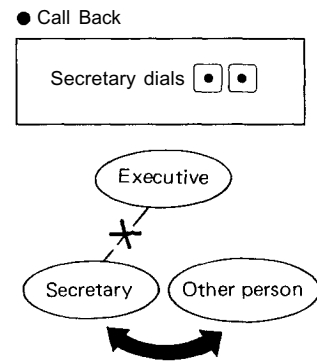
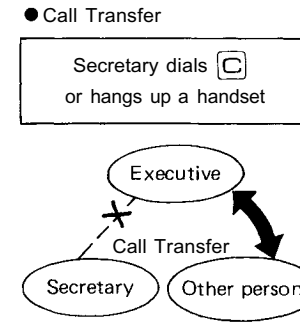
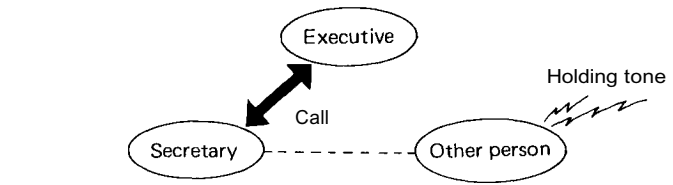
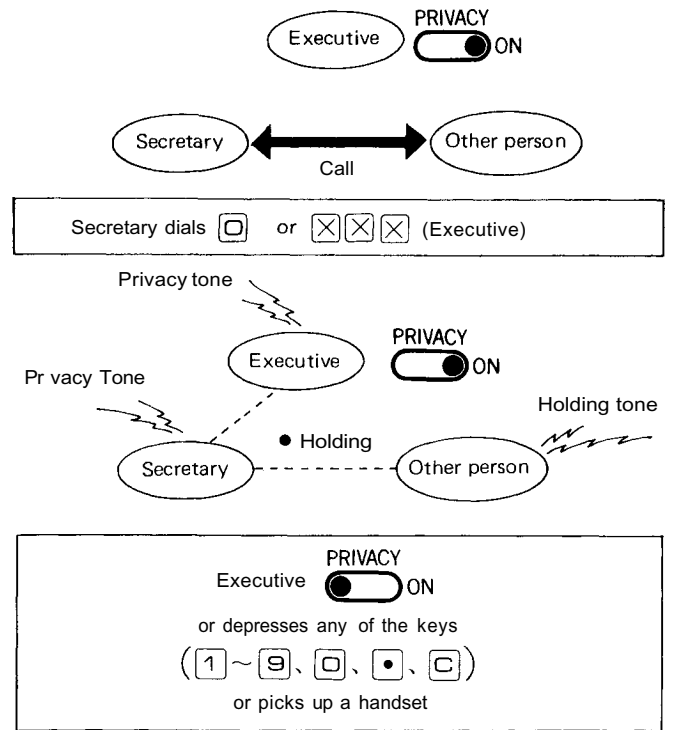

Adoption of the selective function "Transfer" allows rerouting of the call transferred to the secretary back to the executive's station.

When the secretary answering a call touch dials



Executive's station number

the continuous calling tone sounds at both stations, while the call is held. The call holding tone is transmitted to the calling station. If the executive shifts the privacy switch to the left position, or if he depresses any of the keys other than the PTT key (□~□, □, •, □), or picks up a handset he can talk with the secretary. If the call held is to then be transferred back to the executive's station, the secretary is to touch dial □, or to hang up a handset, and the original calling station will be connected to the executive's station.

### Secretary Transfer and Call Transfer using Single Digit Dialing

Adoption of the selective functions "Transfer" and "Single Digit Dialing" allows simple retransfer of the call transferred to the secretary back to the executive's station.

Touch dial

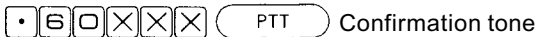

Executive's station number

at the secretary's station in advance. When the call transferred to the secretary has to be transferred back to the executive, the secretary simply touch dials



at her station. This sends the continuous calling tone to both stations, while the call is held. If the call is to be transferred back to the executive's station, the secretary touch dials □ or hangs up a handset.

The calling station will then be connected to the executive's station.

If there is no answer from the executive, the secretary touch dials



and the original call is resumed.

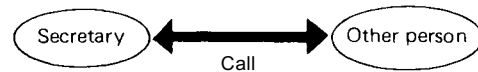
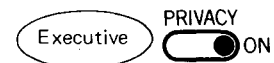

Secretary dials □ or XX (Executive)

Continuous calling tone

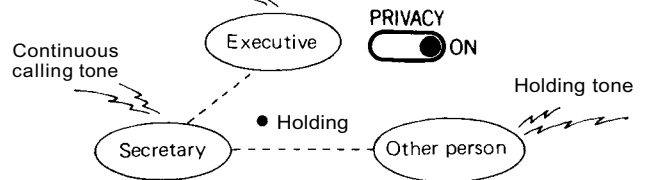

or depresses any of the keys (1~9, 0, •, □) or picks up a handset

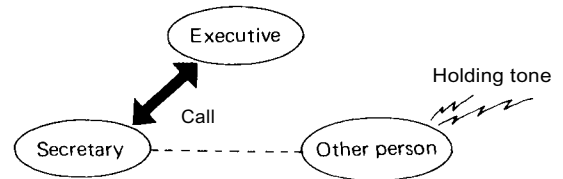

#### ● Call Transfer

Secretary dials □ or hangs up a handset

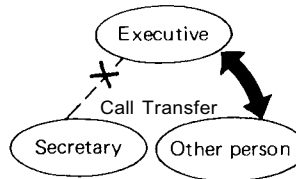

#### ● Call Back

Secretary dials •

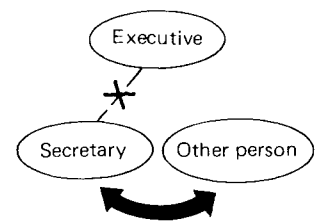

This function is available only for those stations specifically programmed for this function, with programming station No. 200. When the station called is busy, as indicated by the busy or privacy tone, dialing

99\*

sends a priority tone. This priority tone is transmitted for a few seconds and then the call is put through, terminating the original conversation.

When the called station is busy or in the Conference mode or during a paging call, this function allows forced interruption for priority conversation.

\* When the party called through the conference function is busy and it desirable to interrupt his conversation, dial

99

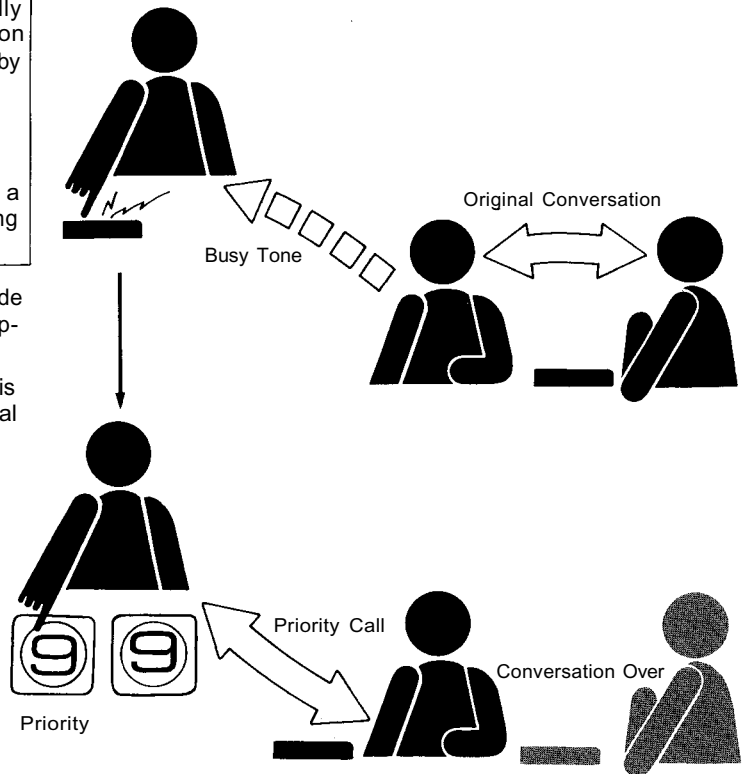

A "Hands-Free" conference call can be made with up to 4 persons. For a conference under this function the other participants may be called either through their station number, personal number or by Single Digit Dialing. Addition of stations or personal numbers (total of only 4) may be added by anyone already connected.

The person who proposes the conference may dial  
       
 (Station Number of the 1st of the participants)  
 After receiving 2nd person's consent, he may then dial  
    
 (2nd participant)  
 After receiving 3rd person's consent, he may now dial  
    
 (the last participant)

At this point, the 4-man conference may begin. It is also possible for any of the 4 participants to call up any of the other participants.  
 Both the 2nd and the 3rd persons can be called up in one dial operation without obtaining their consents.

A person wishing to drop out of the conference should dial  
 or hangs up a handset  
 at his station.

Any of the participants who wish to drop out during the conference may do so as long as it's not the party who originated the conference.

The function is cancelled and the normal mode is restored when the person who arranged the conference dials

In the event that the calls made by the person arranging the conference are not answered or that there has been a dialing error, the function can be cancelled for restoration to the normal mode.

The conference is terminated when the party who arranged the conference dials  
 or hangs up a handset

When the conference has been terminated by the party who originated it, the other participants cannot continue the conference.

● A "Hands-Free" conference call can be made with up to 4 persons.

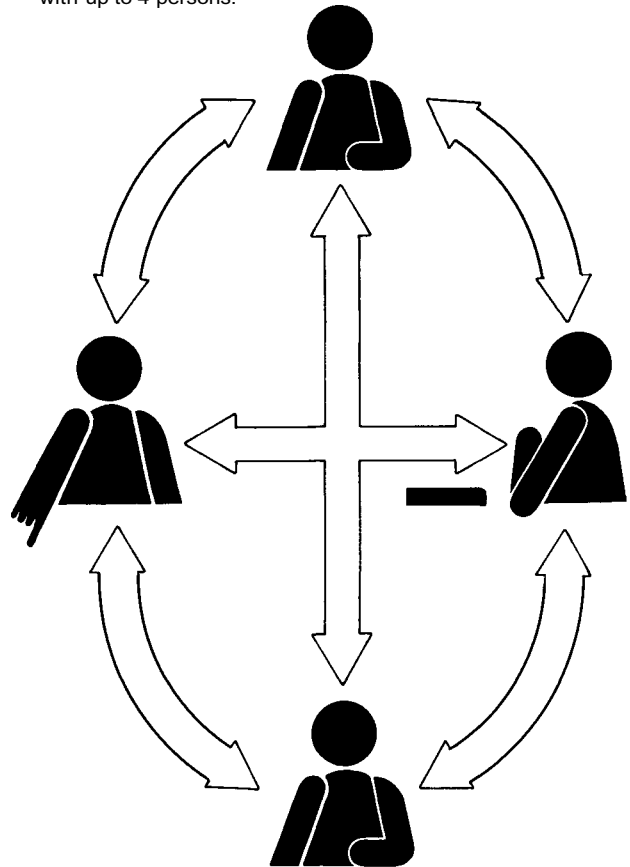

● Dialing of conference member.

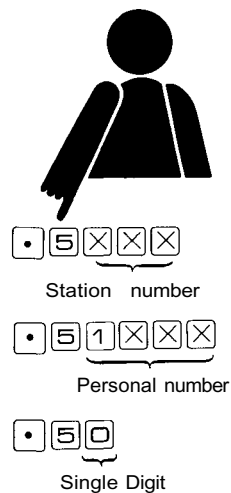



A variety of paging modes allows paging over a wide area from any master station. The paged party may respond from the nearest master station.

Paging modes include external PA systems and/or Station paging, and Zone paging is for calling a limited area and All-call paging is for calling over the entire area.

Response to a paging call may be made by means of Automatic response or Zone number dialing.

### 1. External PA paging and Station paging

#### A. External PA paging

1. Paging through external speakers is possible from any master station, with the paged party able to respond from the nearest master station.
2. External PA paging zones and all-call paging are possible up to a maximum number of 15 zones per exchange.
3. A maximum of 30 zones can be connected when 2 exchanges are tie-lined and 45 zones for 3 exchanges.

#### B. Station paging

1. Paging from any master station to all stations within a certain area is possible through the station speakers. But the page will not be heard at stations in use in the area.
2. Zone paging and all-call paging are possible up to a maximum number of 15 zones per exchange.
3. A maximum of 30 zones can be connected when 2 exchanges are tie-lined and 45 zones for 3 exchanges.

### 2. Zone paging and All-call paging

#### A. Zone paging (Individual zone paging).

Paging and Paging response are possible through Zone paging. The same paging zones (Exchange A: No. 1 ~ 15, B: No. 16 ~ 30, C: No. 31 ~ 45) are used for PA paging and Station paging. Therefore, both PA and Station paging calls are possible in the specific zone connected for the both paging functions.

To page, depress



Zone No. (01 ~ 45)

To respond to a zone paging, depress



Zone No. (01 ~ 45)

#### B. All-call paging

Paging and Paging response for External PA or station paging is possible through All-call paging. All-call paging is possible over the zones (No. 1 through 45) connected for PA or Station paging, and it is possible to make the paging response from any station. However, the station not connected to any of the paging zones is not paged. This does not necessarily mean that All-call station paging must reach all the stations.

To make a all-call paging, depress



To respond, depress



### C. Maximum paging zones

No. of Exchanger	Kind of Exchanger	Station paging	Public address paging
(1)	EX-610/620	All station calls +7 zones	All station calls +7 zones
	EX -630	All station calls +15 zones	All station calls +15 zones
(2)	EX-610/620 : EX-610/620	All station calls +14 zones	All station calls +14 zones
	EX-610/620 : EX-630	All station calls +22 zones	All station calls +22 zones
	EX -630 : EX -630	All station calls +30 zones	All station calls +30 zones
(3)	EX-610/620 : EX-610/620 : EX-610/620	All station calls +21 zones	All station calls +21 zones
	EX-610/620 : EX-610/620 : EX-630	All station calls +29 zones	All station calls +29 zones
	EX-610/620 : EX-630 : EX -630	All station calls +37 zones	All station calls +37 zones
	EX-630 : EX -630 : EX -630	All station calls +45 zones	All station calls +45 zones

### 3. Responding to a paging call

#### A. Automatic response

##### 1. Zone paging response

Touch dialing



at the station within the paged zone permits a response to the party who placed a paging call. In this event, No. 200 registration of the stations (consecutive station numbers) within each zone must be made.

##### 2. All-call paging response

Touch dial



at any station and the paged party is put through to the party calling.

#### B. Zone number dialing

##### 1. Zone paging response

The paged party is connected to the party calling by depressing



Zone No. (01 ~45)

at any station.

A response to the zone paging is possible only from a station connected to the exchange that includes the paged zone.

##### 2. All-call paging response

Depressing



permits a response to the party calling.

- If the EX-630 is included in the tie-line exchanges.

Paging area	No.	Dialing operation		
		Paging call	Response	
			Automatic response	Zone number dialing
All-call paging over the entire zones of exchanges "A", "B" and "C" *1	0	● 8 0 0	● 0	● 0 or ● 9 0 0
Zone paging to the zone of exchange "A"	1 } 15	● 8 X X Zone No. (01 ~ 15)	● 9	● 9 X X Zone No. (01 ~ 15) *3
Zone paging to the zone of exchange "B"	16 } 30	● 8 X X Zone No. (16 ~ 30)		● 9 X X Zone No. (16 ~ 30) *4
Zone paging to the zone of exchange "C"	31 } 45	● 8 X X Zone No. (31 ~ 45)		● 9 X X Zone No. (31 ~ 45) *5

- If the tie-line exchanges are the EX-610 and/or EX-620.

Paging area	No.	Dialing operation		
		Paging call	Response	
			Automatic response	Zone number dialing
All-call paging over the entire zones of exchanges "A", "B" and "C" *1	0	● 8 0 0	● 0	● 0 or ● 9 0 0
Zone paging to the zone of exchange "A"	1 } 7	● 8 X X Zone No. (01~07)	● 9	● 9 X X Zone No. (01~07) *3
Zone paging to the zone of exchange "B"	8 } 14	● 8 X X Zone No. (08~14)		● 9 X X Zone No. (08~14) *4
Zone paging to the zone of exchange "C"	15 } 21	● 8 X X Zone No. (15~21)		● 9 X X Zone No. (15~21) *5

**Note.**

- \*1 When 2 or 3 exchanges are connected by tie-line but 1 or 2 of them have no built-in Paging unit (PI), All-call paging is made only over the area of the exchange(s) having the PI.
- \*2 A paging response is possible only from the station in the paged zone.
- \*3 A paging response is possible only from the station connected to the exchange "A" (station No.200 ~ 455)
- \*4 A paging response is possible only from the station connected to the exchange "B" (station No.470~ 725)
- \*5 A paging response is possible only from the station connected to the exchange "C" (station No.740~ 995)

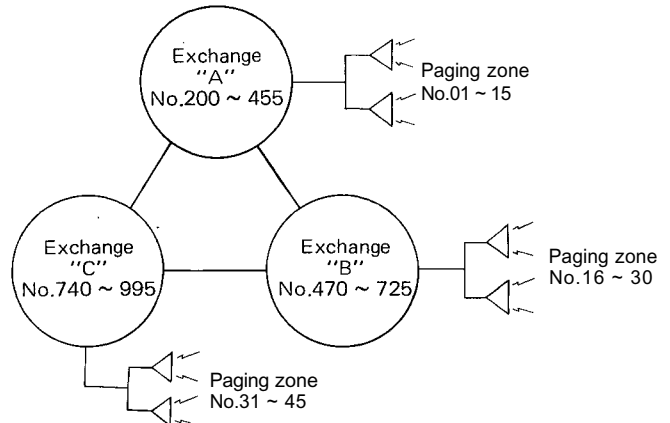

## ◆ Paging call

External PA paging to a specific zone is possible from any master station by pressing after picking up a handset.

("00" = all-call)  
 (01 ~ 45) (\*01 ~ 21)

It is possible to wait for a response in this mode, but anything said will be broadcasted over the entire zone. It is best to end the paging call by pressing

or hanging up a handset

and waiting for a response.

\* When the tie-line system is using the EX-610 and EX-620.

All-call paging of zones 1 through 45 can be done in both the External PA paging mode through an external amplifiers and speakers, and the station paging mode through the station speakers. In the event of All-call paging, the paging is done over the entire zones.

When all-call paging is initiated during zone paging, the zone paging is interrupted and restored after the all-call paging is finished.

## ◆ Paging response

### 1. Automatic response

To respond to a paging call, go to the nearest master station and press either

(All-call paging response)

or

(Zone paging response)

A paging response is possible only from the station in the paged zone.

A response to All-call paging is possible from any station.

To respond to Zone paging by pressing   , No. 200 registration of the stations (consecutive station numbers) within each zone must be made. Such registration is required for both external and station paging.

### 2. Zone number dialing

To respond to a All-call paging, go to the nearest master station and press

or

To respond to a Zone paging call, press

Zone No. 01 ~ 45

at the nearest station.

A response to the zone paging is possible only from a station connected to the exchange that includes the paged zone (Exchange "A": Zone No. 1 ~ 15, "B": No. 16 ~ 30, "C": No. 31 ~ 45). It is not impossible to respond from the station connected to the other exchange.

A response to All-call paging is possible from any station.

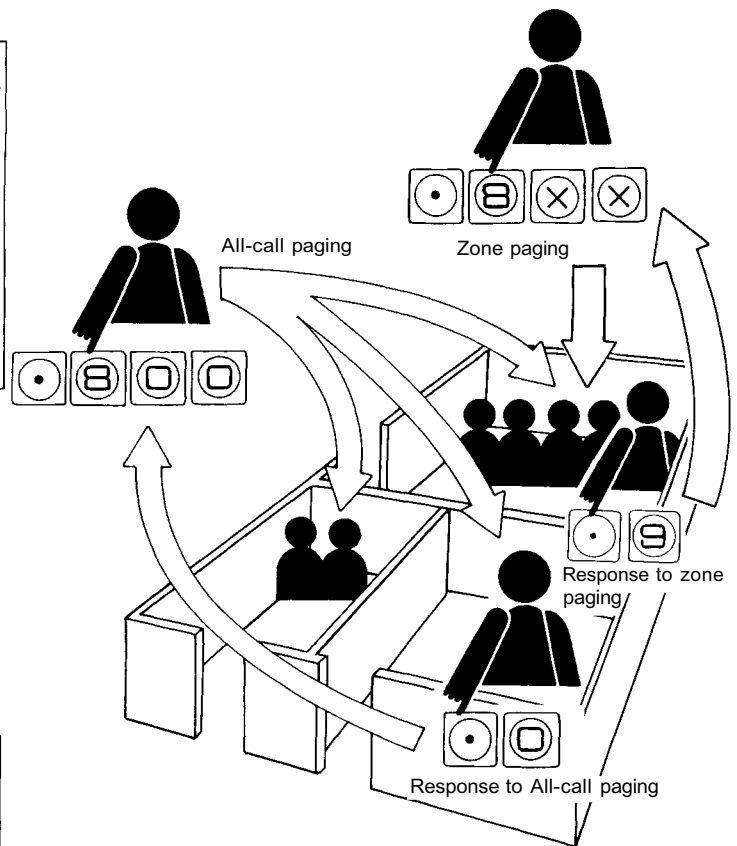

Table of stations used for individual zone paging (Example)  
(In the case of "Automatic response")

	Zone numbers	First station number	Last station number
Exchange A	1	2 0 1	2 0 3
	2	2 0 5	2 0 7
	3	2 1 0	2 1 9
	4		
Exchange B	1 4		
	1 5		
	1 6		
	1 7		
	1 8		
	1 9		
Exchange C	2 9		
	3 0		
	3 1		
	3 2		
	3 3		
	3 4		
	4 4		
4 5			

# Selectable First Station Number of Each Exchange

Tie-line

1. Standard station numbering schedules of exchanges A, B and C are as follows:

< Standard station numbering >

Type of Exchange	A	B	C
With Personal Number (Standard)	200 ~ 455	470 ~ 725	740 ~ 995

2. If other numbering schedules are preferred, it is possible to choose the head number of each exchange from 100/200/300/400/500/600/700/800/900 in order of exchange A, B and C. (Stations of each exchange must have the consecutive numbers.)

< Example >

Type of Exchange	A	B	C
Example 1 With Personal Number	<u>3</u> 00~	<u>5</u> 00~	<u>7</u> 00~
Example 2 Without Personal Number	<u>1</u> 00~	<u>6</u> 00~	<u>9</u> 00~

1. This function allows the system to have "Programmable station numbers", other than the "Hardwired station numbers" by programming.  
The stations not registered for "Programmable Station Numbers" remain in the original "Hardwired Station Number".
2. Each station number can be programmed in the station number series of the exchanges A, B and C that have been determined by the function of the Selectable First Station Number.

1. Numbering schedules can be changed easily by programming in stead of rewiring.
2. Such numbering schedules as 200's, 300's and 900's can be grouped together for each individual office. (Refer to Fig. 1)

<Fig. 1>

Hardwired station number	Programmed station number	
2 0 1	2 0 1	} Department 1
2 0 2	2 0 2	
2 0 3		
2 0 4	3 0 1	} Department 2
2 0 5	3 0 2	

3. Hardwired stations of each paging zone must have consecutive numbers. To make the programmable station numbers inconsecutive, use this function. (Refer to Fig. 2)

<Fig. 2>

Hardwired station number	Programmed station number	
2 0 1	2 0 1	} Station paging zone
2 0 2	2 3 1	
2 0 3	2 4 1	

4. This function requires No.200 programming. See Installation Instructions for EXES-6000 CP unit.

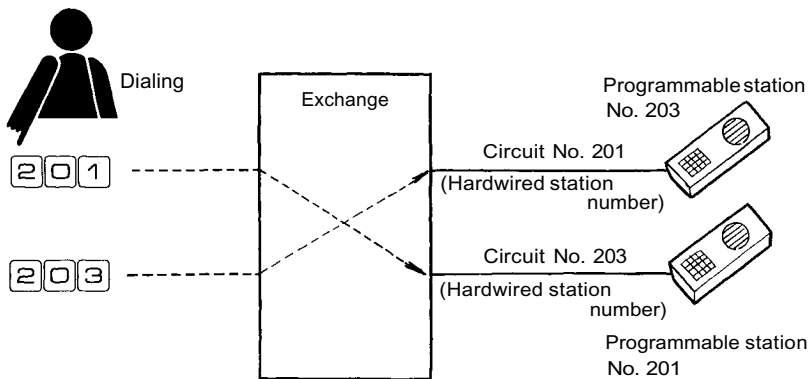

<Fig. 3>

Hardwired station number	Programmed station number
2 0 0	→
2 0 1	2 0 3
2 0 2	→
2 0 3	2 0 1
3 2 6	→
3 2 7	→

5. "Programmable station number" series for each exchange

<Example 1> With Personal Number

<Example 2> Without Personal Number

<Example 3>

Exchange	Hardwired station number	Programmed station number
A	200 ~ 455	200 ~ 469
B	470 ~ 725	470 ~ 739
C	740 ~ 995	740 ~ 999

Exchange	Hardwired station number	Programmed station number
A	100 ~ 355	100 ~ 399
B	400 ~ 655	400 ~ 699
C	700 ~ 955	700 ~ 999

Exchange	Hardwired station number	Programmed station number
A	200 ~ 399	200 ~ 499
B	500 ~ 755	500 ~ 799
C	800 ~ 999	800 ~ 999

(Standard)

6. People operating the intercom stations need not worry about the Hardwired station numbers. Note, however, that the hardwired station numbers are used to program all the setup data of each function into the exchange through No.200 programming.

## Function (A)

The system can be grouped or divided into a maximum of 6 groups of stations with consecutive station numbers by exchanges "A", "B" and "C". Different station groups cannot call each another.

### [Example 1]

< Exchange "A" >

Fig. 1

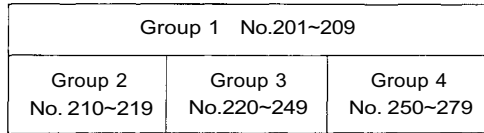

< Exchange "B" >

Fig. 2

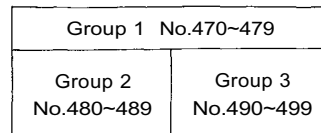

< Exchange "C" >

Fig. 3

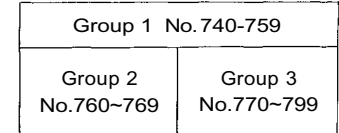

## Function (B)-1

The group connected to the same exchange can call and/or be called by any other group(s) within the same exchange area.

[Example 2-1] Fig. 4

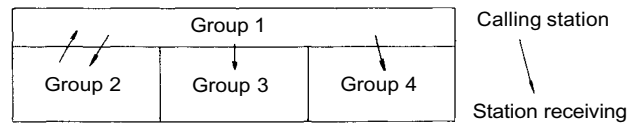

## Function (B)-2

Only one pair of groups can call each other across the tie-lined exchange. The tie-line link of each exchange (4 links) forms a group (T<sub>L</sub> and T<sub>H</sub>) like stations. The groups No.1 through 6 connected to the same exchange can call exchange by programming in tie-line links T<sub>L</sub> (group No. 7) and T<sub>H</sub> (group No. 8).

[Example 2-2] < 2 exchanges tie-lined > Fig. 5

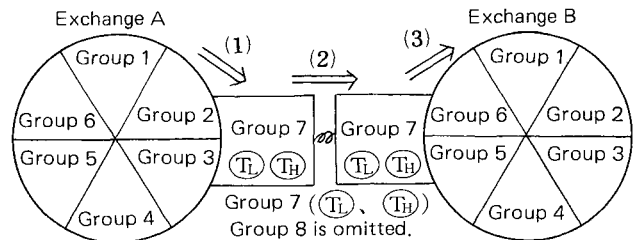

< 3 exchanges tie-lined > Fig. 6

### Explanation of < 3 exchanges tie-lined > (Fig. 6)

- 1) The call can be made from Group No. 2 of exchange "A" to tie-line links T<sub>L</sub> of exchange "A". (1)
- 2) Connect tie-line links T<sub>L</sub> of exchange "A" to tie-line links T<sub>H</sub> of exchange "B". (2)
- 3) The call can be made from tie-line links T<sub>H</sub> of exchange "B" to group No. 1 of exchange "B". (3)
- 4) Thus, the call is allowed to go through from Group No.2 of exchange "A" to Group No. 1 of exchange "B".

## Function (C)

The paging zone number (All-call, individual zones No.1 ~ 30 for 2 exchanges and No.1 ~ 45 for 3 exchanges) which each group of each exchange can call is programmable. (No distinction is made between external PA and Station paging.)  
Paging to the paging zones of the other exchange is also programmable.

### Note.

When the paging call is made, the group of stations to which the response is made is restricted by Function B. Function B permits the normal station call in the direction of the arrows. Its paging response can be made in the opposite direction of the arrows. (Refer to Fig. 4 and Fig. 8)

### < Example of Paging response >

When the programming is set up for the normal station call as is shown in Fig. 4, the paging response is only possible in the direction of the arrows of Fig. 8.

[Example 3] Fig. 7

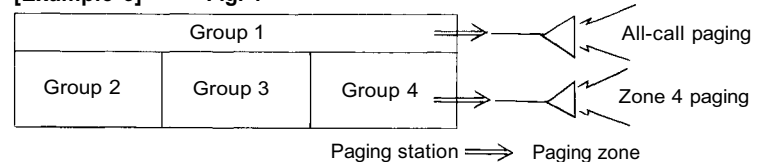

[Example 4] Fig. 8

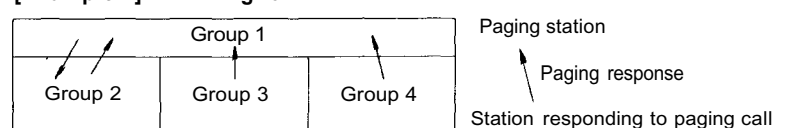

**Example of Group Blocking registration**

Tie-line

To use this function, station No. 200 programming (No.470 programming or No.740 programming) of the allocated station number, group, paging zone, etc., must be set up in the exchange.

**1. Example of conversation and paging**

To make this example of Group Blocking available for the system, the following programming at steps 2 through 4 must be set up in each exchange.

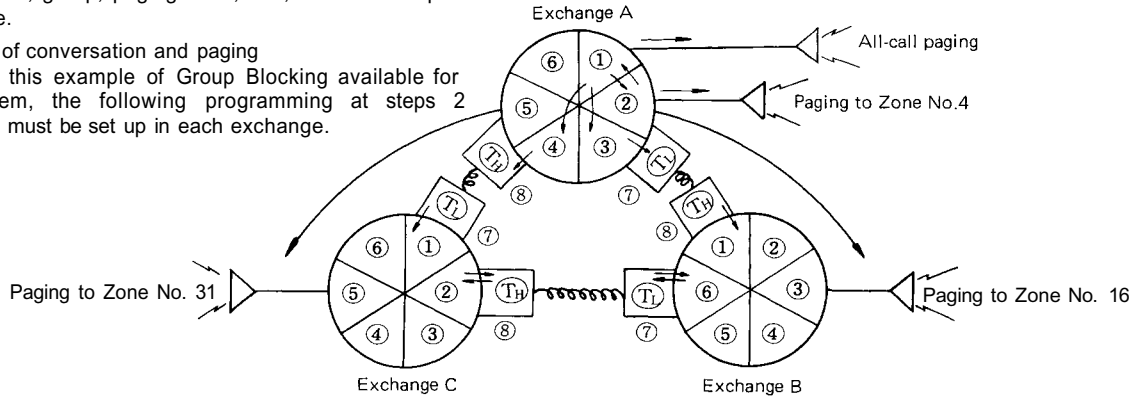

**2. "No. 200 programming" in Exchange A**

Function registration (A)		Function registration (B)								Function registration (C)																																												
Station for each group Group No. of calling station		Group No. of station receiving call								Paging zone of station receiving call																																												
										All-call	Zone No.																																											
First station No.	Last station No.	1	2	3	4	5	6	7	8	X	00	01	02	03	04	14	15	16	17	18	19	29	30	31	32	33	34	44	45																									
2 0 1	2 0 9	⊙	⊙	⊙						⊙	⊙	⊙																																										
2 1 0	2 1 9	⊙	⊙							⊙					⊙																																							
2 2 0	2 4 9			⊙						⊙																																												
2 5 0	2 7 9				⊙					⊙																																												
Tie-line links (TL) A → B																																																						
Tie-line links (TL) A → C																																																						
Station not in group		X	⊙	⊙	⊙	⊙	⊙	⊙	⊙	⊙	⊙	⊙	⊙	⊙	⊙	⊙	⊙	⊙	⊙	⊙	⊙	⊙	⊙	⊙	⊙	⊙	⊙	⊙	⊙	⊙	⊙	⊙	⊙	⊙	⊙	⊙	⊙	⊙	⊙	⊙	⊙	⊙	⊙	⊙	⊙									

**3. "No.470 programming" in Exchange B**

Function registration (A)		Function registration (B)								Function registration (C)																																												
Station for each group Group No. of calling station		Group No. of station receiving call								Paging zone of station receiving call																																												
										All-call	Zone No.																																											
First station No.	Last station No.	1	2	3	4	5	6	7	8	X	00	01	02	03	04	14	15	16	17	18	19	29	30	31	32	33	34	44	45																									
4 7 0	4 7 9	⊙								⊙																																												
4 8 0	4 8 9		⊙							⊙																																												
4 9 0	4 9 9			⊙						⊙																																												
Tie-line links (TL) B → C																																																						
Tie-line links (TL) B → A																																																						
Station not in group		X	⊙	⊙	⊙	⊙	⊙	⊙	⊙	⊙	⊙	⊙	⊙	⊙	⊙	⊙	⊙	⊙	⊙	⊙	⊙	⊙	⊙	⊙	⊙	⊙	⊙	⊙	⊙	⊙	⊙	⊙	⊙	⊙	⊙	⊙	⊙	⊙	⊙	⊙	⊙	⊙	⊙	⊙	⊙									

**4. "No. 740 programming" in Exchange C**

Function registration (A)		Function registration (B)								Function registration (C)																																												
Station for each group Group No. of calling station		Group No. of station receiving call								Paging zone of station receiving call																																												
										All-call	Zone No.																																											
First station No.	Last station No.	1	2	3	4	5	6	7	8	X	00	01	02	03	04	14	15	16	17	18	19	29	30	31	32	33	34	44	45																									
7 4 0	7 5 9	⊙								⊙																																												
7 6 0	7 6 9		⊙							⊙																																												
7 7 0	7 9 9			⊙						⊙																																												
Tie-line links (TL) C → A																																																						
Tie-line links (TL) C → B																																																						
Station not in group		X	⊙	⊙	⊙	⊙	⊙	⊙	⊙	⊙	⊙	⊙	⊙	⊙	⊙	⊙	⊙	⊙	⊙	⊙	⊙	⊙	⊙	⊙	⊙	⊙	⊙	⊙	⊙	⊙	⊙	⊙	⊙	⊙	⊙	⊙	⊙	⊙	⊙	⊙	⊙	⊙	⊙	⊙	⊙									

**Note.**  
 ⊙ Stations capable of being called without registration.  
 X Stations not belonging to the group.

Stations at which the following 7 specified functions can be restricted.

1. All-call paging  
 8 0 0

2. Zone paging  
 8 X X

3. Conference  
 5 X X X  
 Station number

4. General purpose control  
 Mode 1 (One-shot make output)  
 3 (X) X X  
 00~49  
 000 ~ 499

5. General purpose control  
 Mode 2 (Make/break output)  
 3 5 (X) X X  
 00~99  
 000 ~ 511  
 3 6 (X) X X  
 00~99  
 000~511

6. General purpose control  
 Mode 3 (8 selectable one-shot make output)  
 3 7 X Y  
 1 ~ 9    1 ~ 8  
 Unit No.    Condition No.

General purpose control  
 Mode 4 (8 selectable output or decimal output)  
 3 8 (X) X Y  
 01~64    1~8,0 (clear)  
 (01~99)    (0~9)  
 Unit No.    Condition No.

7. General purpose control  
 Mode 5 (4 decimal digits output)  
 3 9 X Y Y Y Y  
 1 ~ 9    0000 ~ 9999  
 (Unit No.)    (4-digits)

1. For conference, only the specified stations (one or more) can make a call, but any station can be called.
2. No.200 programming must be established for the specified stations.



The duration of the calling tone can be set for either 0.2 second (single note tone) or 0.3 second (warble tone). It is also possible to have the station without any calling tone.

**Note.**

1. The duration of the continuous calling tone is impossible to change.
2. It is impossible to use different calling tone modes in one same system.

## Selectable Paging Pre-paging Tone Duration

Paging pre-paging tone can be chosen from "2 seconds", "1 second" and nothing.

## Time-Out of Conversation

It is possible to limit the conversation duration to one through ninety-nine minutes in the unit of one minute in order to improve speech path availability. A hurry-up tone is sounded in both the calling and called stations approximately 10 seconds before the busy stations are automatically disconnected from the speech path.

## Time-Out of Paging Call

This function is employed to prevent the unnecessary line occupation as a result of a paging party's failure to depress the  key after a paging call establishment. The paging call is automatically cancelled after a certain period of time, which may be set at one through ninety-nine minutes in the unit of one minute, with a hurry-up tone transmitted to the paging station approximately 10 seconds prior to the automatic disconnection. When the paged party responds, the conversation is automatically cut off after the duration set by the Time-out of conversation function.

The in/out annunciation indicators can be turned on or off from any master station by using the personal number registering procedure.

When a personal number registration is made at a station, by dialing

• 6 1 X X X Confirmation tone  
 1000~1999 (personal number)

the personal number is registered at that station and the personal number lamp on the in/out indication panel is turned on.

**Personal number call**

By dialing

1 X X X  
 1000~1999 (personal number)

from any station, the call is put through to the station registered with the personal number.

**Cancelling personal number and turning off in/out annunciation.**

By dialing

• • 1 X X X Confirmation tone  
 1000~1999 (personal number)

from any station, the personal number is cancelled and the personal number lamp on the in/out indication panel is turned off.

1. The maximum number of in/out annunciation windows is 1000. This maximum number remains the same even when the number of exchanges to be connected is increased to 2 or 3.
2. Produce the indication panel using the Data Transmitting and Receiving Units. For further details, refer to "Installation Hand Book for CP Unite and Operating Instructions for the DT-E70 and DR-B61".

In/out indication panel

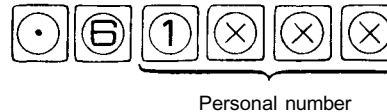
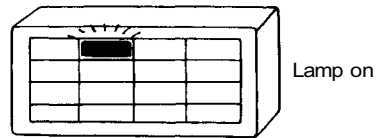

In/out indication panel

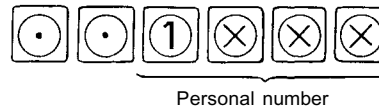
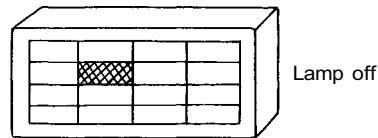

A one station/one lamp type calling party indication panel can be provided for certain specified stations (eight stations or eight groups of stations)

The system can also be divided into a maximum of 8 groups of stations (consecutive station numbers) so that each group may have the calling party indication panels which are common within the group. The party making the call is indicated even if the call is made to any station in the group.

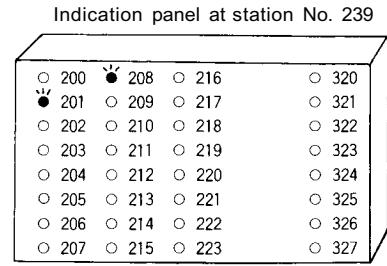

**<Calling station memory>**

It is also possible to equip the system with the "Calling station Memory" function. With this function the calling party's lamp remains lit on the indication panel to keep on lighting even if he cancels the call when the called party is on another line or in Privacy mode.

**< Indication mode without calling station memory >**

1. A lamp of the calling station comes on and goes out when the conversation is over.
2. When the call is made during conversation or privacy mode, a lamp of the calling station comes on and goes out when the calling station cancels the call.

**< Indication mode with calling station memory >**

1. The lamp at the station receiving the call comes on when a call is made and goes out when the conversation is completed.
2. When a call (camp-on-busy) is made to the busy or the privacy station (with the privacy switch on), the lamp of calling station comes on. The lamp will not go out even if the original call is cancelled.
3. The lamp goes out after the conversation is cancelled.
4. Dialing



without placing a call causes all lights to go out. \*1

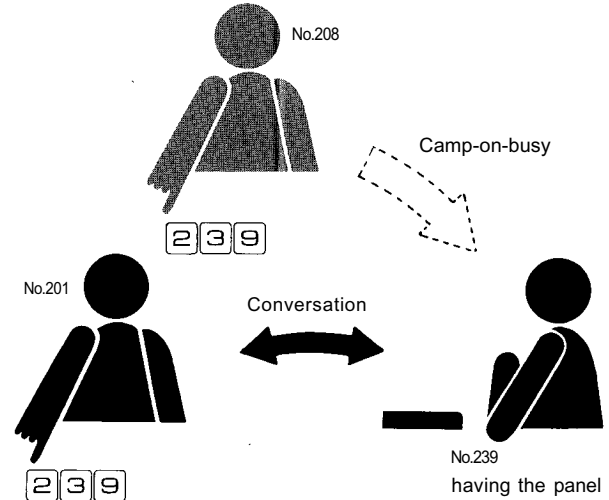

**Note.**

\*1. In the case of Handset Master station TL-600M, lift a station handset and confirm that a dial tone is heard. Press after cancelling the dial tone by pressing .

1. The maximum number of calling stations is 256. When 2 or 3 exchanges are connected by tie-lines, the party who is calling through the remote extension exchange is not indicated.
2. The indication panel must be used with the Data Transmitting and Receiving Units.
3. No.200 programming must be established in exchange "A" for stations or station groups to have the indication panel. Similarly, No.470 programming must be established in exchange "B" and No.740 programming in exchange "C".
4. If the lamp type calling party indication function is used, this makes it impossible to use the lamp type conversation partner indication function.

**Example of registration**

Indication panel	First station number	Last station number
1		
2	239	239
3		
4		
5	251	255
6		
7		
8		

1. Station No. 239 has the indication panel No.2.
2. The group of stations No. 251-255 is provided with the indication panel No. 5.

**< Response to indicated calling party >**

If, during the conversation, the called party wishes to respond the calling party indicated on the panel, he can do so by pressing either

1.      (calling party's No.) (the conversation is terminated), or
2.    (calling party's No.) (the conversation is placed on hold temporarily).

Indication panel at station No. 239

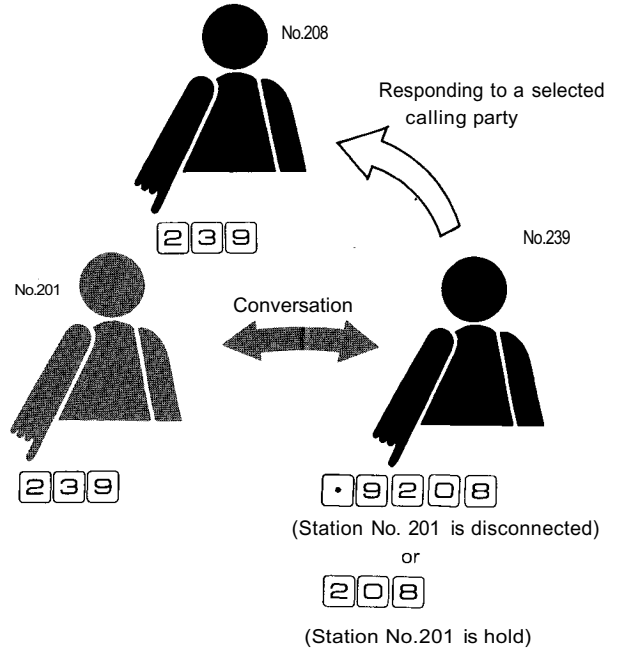
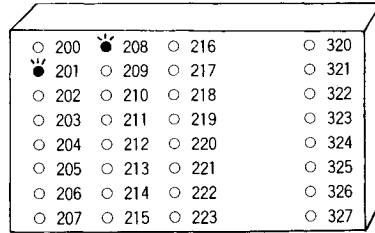

**Conversation Partner Indication (Lamp Type)**

A one station/one lamp type Conversation Partner indication panel can be provided for specific stations (eight stations or eight groups of stations). The system can be divided into max. 8 groups of stations (consecutive station numbers) so that each group may have the Conversation Partner Indication panels which are common within the group. The party making the call and the party receiving the call are indicated whenever the calls are made to and made from any station in the group.

1. When a station having the Indication Panel makes a call, a lamp of the called station lights on until the conversation is cancelled.
2. When a station having the Indication Panel receives a call, a lamp of the calling station lights on until the conversation is cancelled.

**Note.**

- The waiting station making a call to the station (Camp-on-busy, privacy on) is not displayed on the Indication Panel.
- Group assignment for this function should be equal to "Conversation Partner Indication" group assignment.
- Indication panel should be used with the Data Transmitting and Receiving Units.

Indication panel at station No. 239

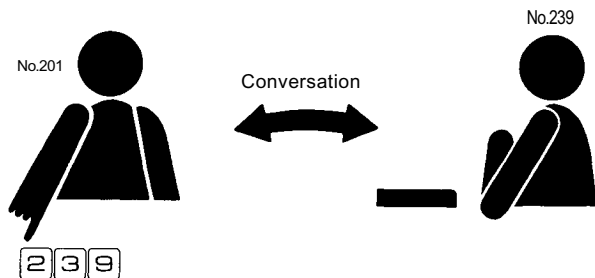
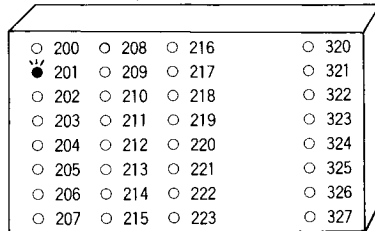

## • Pager call and response

The system can call a maximum of 10,000 pager receivers and the party called can answer the call via the nearest station.

It is also possible to call those pager receivers having voice or display functions.

### 1. Paging

#### (1) Tone-only pager

The following two methods are available for calling tone-only pagers.

- When there is no response from the called party to the call made by dialing the station number or personal number, further dial as follows without terminating the call:

Confirmation tone is heard.

and the call is connected to the called party's pager receiver.

- To call the receiver directly, dial

(   ) Confirmation tone  
 Pager No.

The calling station, while waiting for a response from the pager, can receive other incoming calls.

**Table showing paging operation 1 and output digits for pager calls**

Pager digit	Two-digit dialing	Three-digit dialing	Four-digit dialing
2 digits	Station No.	Station No.	Station No.
3 digits	—	Station No.	Station No.
4 digits	Personal No.	Personal No.	Station No. Personal No.

#### (2) Pager with speech or display function

First dial   and then both the pager and function code numbers according to the pager operating instructions.

(   )  . .   
 Pager No.

After all operations are completed, dial  or replace the handset.

### 2. Answering

To respond to the pager call, go to the nearest station and dial:

(   )  
 Pager No.

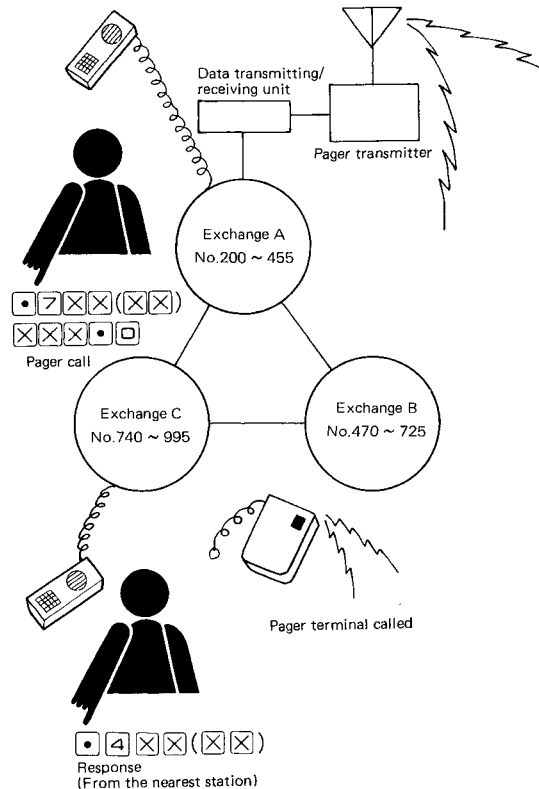
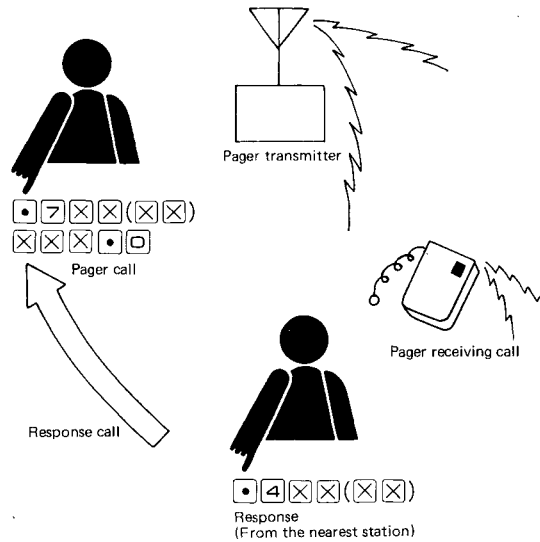

### 3. Automatic pager call

Register the station for this function using No.200 programming. When the station receive a station or personal number call, that call is automatically connected to the pager.

#### Notes.

- No.200 programming must be established to register a pager output digit.
- A maximum of 16 pager receivers can be called at a time.
- A person called by pager has to respond quickly from the nearest station. Otherwise he cannot receive other calls during 3 minutes after the pager call has been made.

Station may be restricted from access to this function. This function can control other equipments by employing the Data Transmitting and Receiving Units.

Select the required type of output.

### (Mode 1) One-shot make output (500/50 contacts)

Dial

• 3 (5) X X

00 ~ 49  
(000 ~ 499)

and the relay output is made for 1 to 2 seconds.

Example: Door remote and VTR control

Note: Operation performed even when all link circuits are occupied.

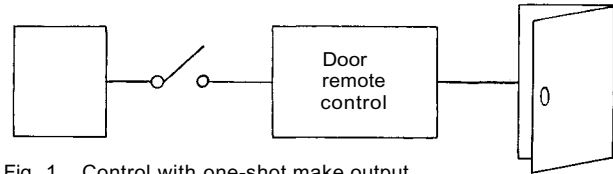

Fig. 1 Control with one-shot make output

### (Mode 2) Make/break output (512/100 contacts)

Dial

• 3 5 (X) X X

00 ~ 99  
(000 ~ 511)

and the make output is sent out.

Dial

• 3 6 (X) X X

00 ~ 99  
(000 ~ 511)

and the break output sent out.

Example: In/out annunciation, Prescription annunciation.

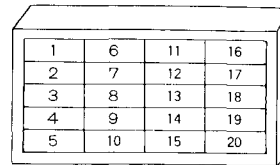

Fig. 2 Lamp on/off indication panel

### (Mode 3) 8-selectable one-shot make output (9 units)

Dial

• 3 7 X Y

1~9      1~8  
Unit No.    Contact No.

and one contact out of 8 selectable make outputs is obtained for about 1 or 2 seconds.

Example: VTR control

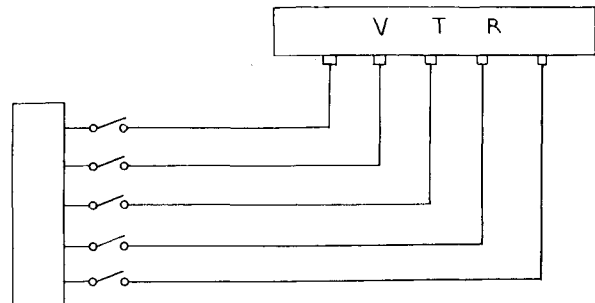

Fig. 3 VTR control with 8-selectable one-shot make output

### (Mode 4) 8 selectable make output and/or decimal output

(A) 8 selectable make output (64/9 units)

Dial

• 3 8 (X) X Y

1~9      1~8, 0 (Clear)  
(01~64)    Condition No.  
Unit No.

and one of the 8 relay outputs is made. "Clear" operation makes all 8 relays break.

Example: Destination indication, room condition indication, ITV control

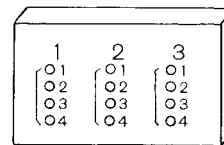

Fig. 4 8 selectable output type indication panel

### (B) Decimal output

Dial

• 3 8 (X) X Y

1~9      0~9  
(01~64)    Condition No.  
Unit No.

and the condition is indicated numerically.

Example: Destination indication, room condition

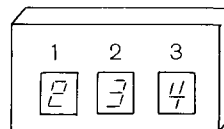

Fig. 5 Decimal output type indication panel

### (Mode 5) 4 decimal digits output

Dial

• 3 9 X Y Y Y Y

1 ~ 9      0000 ~ 9999  
Unit No.    4 decimal digits

and 4 decimal digits are indicated.

Example: Prescription annunciation

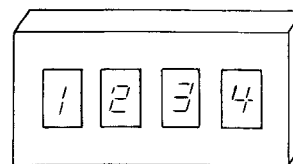
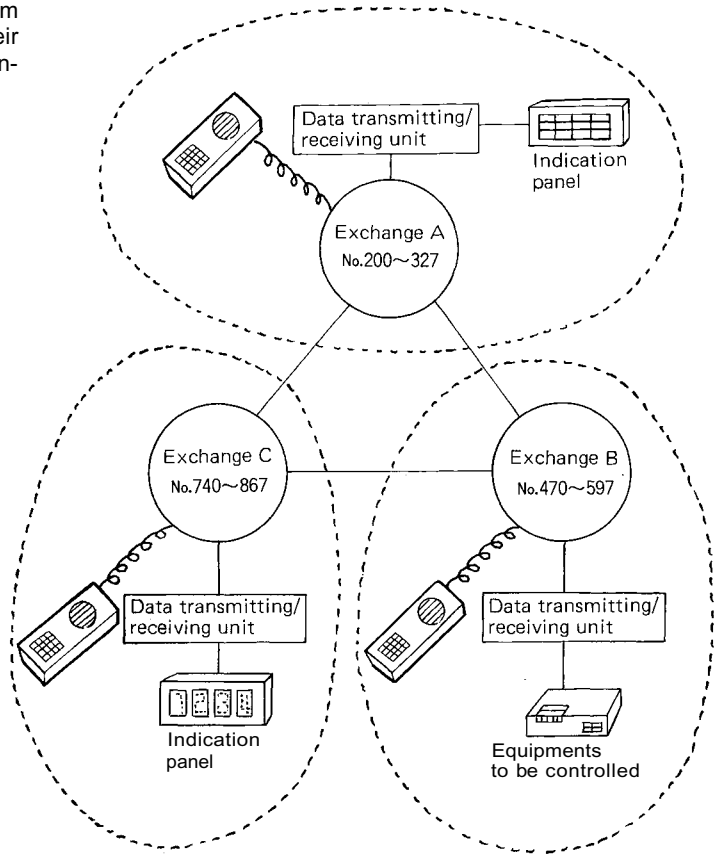

Fig. 6 4 decimal digits type indication panel

**Note.**

When 2 or 3 exchanges are connected by tie-lines, Data Transmitting and Receiving Units can be operated from the stations which share the same exchange but their operation is impossible from the stations which are connected to the other exchange.



Control of Data Transmitting and Receiving Units of each exchange is only possible from the stations sharing the same exchange and within the same areas circled in dotted lines.

If an external speaker is connected instead of a station, simplified paging can be made without the PA amplifier when the caller dials that station number and makes a paging call.

**Note.**

For further details, refer to "Installation Handbook for Exchange".

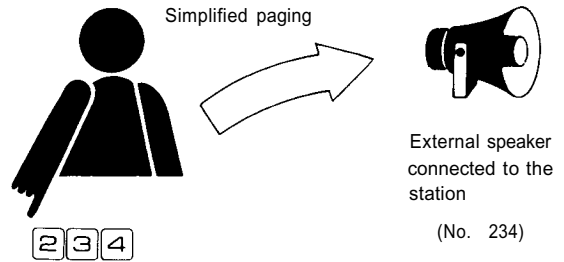

## Clear Entry and Conversation Over

**1. Clear entry**

In the event that an error has been made when dialing for Transfer or Conference, at the start of or during the conversation, dial



This will restore the condition before the error was made, allowing the caller to make a correction without interrupting the call.

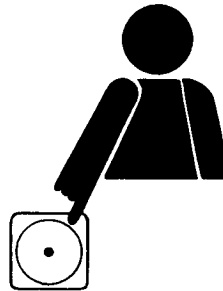

**2. Conversation over**

To terminate conversation, dial  or hang up a handset.

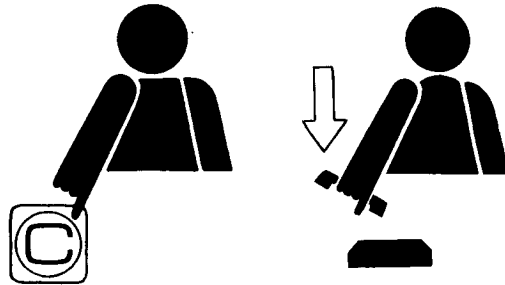



## Chapter 4

### Functions and Operating Procedures of External Interface System

# External interfaces

## 1. Types of external interfaces

External interfaces are classified into four types: OD interface, LD interface, CB interface, and Tie-line interface (depending on their external equipment).

- (1) The OD interface connects the intercom system to the external PBX via 4-wire rented lines.
- (2) The LD interface connects the intercom system to the internal PBX via 2-wire rented lines.
- (3) The CB interface connects the intercom system to the external and internal lines of the PBX.
- (4) The tie-line interface connects two or more exchanges.

## 2. Descriptions of each interface

### (1) OD interface

This interface, when connected to the PBX in the remote area via the EXES-6000 exchange, permits normal calls, paging calls, etc. to be made between the intercom station and the PBX extension telephone.

### (2) LD interface

This interface, when connected to the internal PBX via the EXES-6000 exchange, permits normal calls, paging calls, etc. to be made between the intercom station and the PBX extension telephone.

### (3) CB interface

This interface, when directly connected to the PBX extension line or to the telephone line via the EXES-6000 system, permits the intercom station to make and receive an external telephone call. The CB-600 lines can also be used for interfacing with an in-house pager system, a city pager system, etc.

### (4) Tie-line interface

This interface connects two or more EXES-6000 exchange via the rented lines for normal calls, paging calls, etc. between stations that are remote from each other.

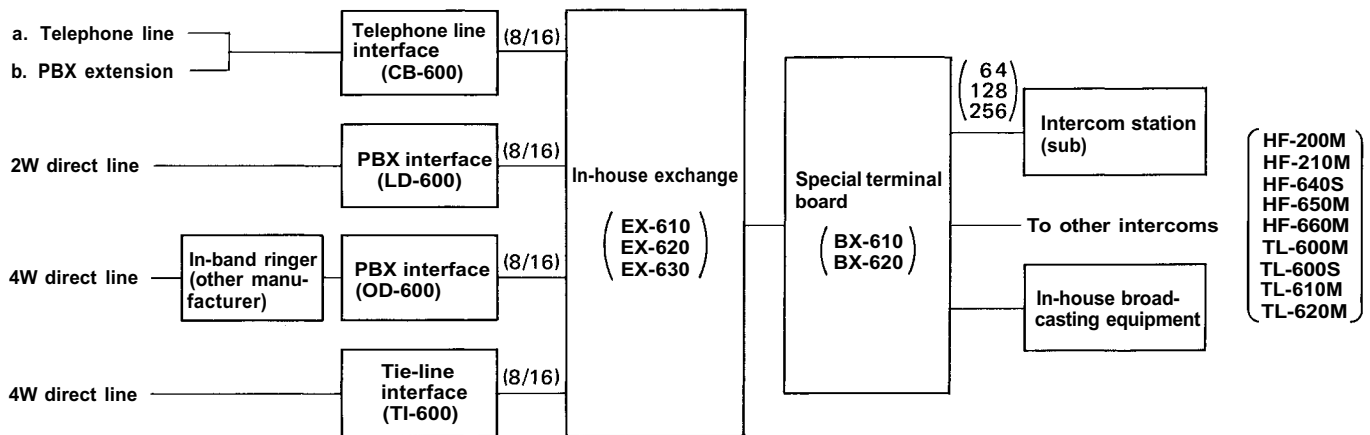

## 3. Numbering schedule of external interfaces

Before the external interfaces can function, the access number (selective number) for each interface must first be registered through No.200 programming. (For details, refer to the Installation Manual for the CP-66).

### (1) OD interface

Register the access numbers to use for seizing the OD lines according to the OD-600 line registration (Function Code No.23 of No.200 programming). If it is desirable to connect the intercom system to two or more PBX's installed in different locations, this can be accomplished by dividing the OD lines and registering the access number of each split line.

### (2) LD interface

Register the access number to use for seizing the LD lines according to the LD-600 line registration (Function Code No.24 of No.200 programming). By dividing the LD lines into several groups and registering their respective access numbers, the lines can be connected to more than one PBX.

### (3) CB interface

Register the access numbers to use for seizing the CB lines as well as for picking up an incoming telephone call according to the CB-600 line registration (Function Code NO.25 of NO.200 programming). Also register the calling tone mode for receiving telephone calls, and the group numbers of stations capable of call response.

### (4) Tie-line interface

Register the access numbers to use for seizing the TI lines according to the TI-600 line registration (Function Code No.26 of No.200 programming). By dividing the lines into two or more groups and registering their respective access numbers, more than one intercom system can be connected to each other.

## • OD interface

### 1. Calls from the intercom station to the PBX extension telephone

First dial **Y** (OD interface access No.). After confirming a dial tone from the PBX, dial **X X X** (extension No.).

### 2. Calls from the PBX to the intercom station

Dial **Y** (intercom access No.). After confirming a dial tone from the intercom system, dial **X X X** (station No.), and the call is put through to the station, transmitting an intermittent calling tone.

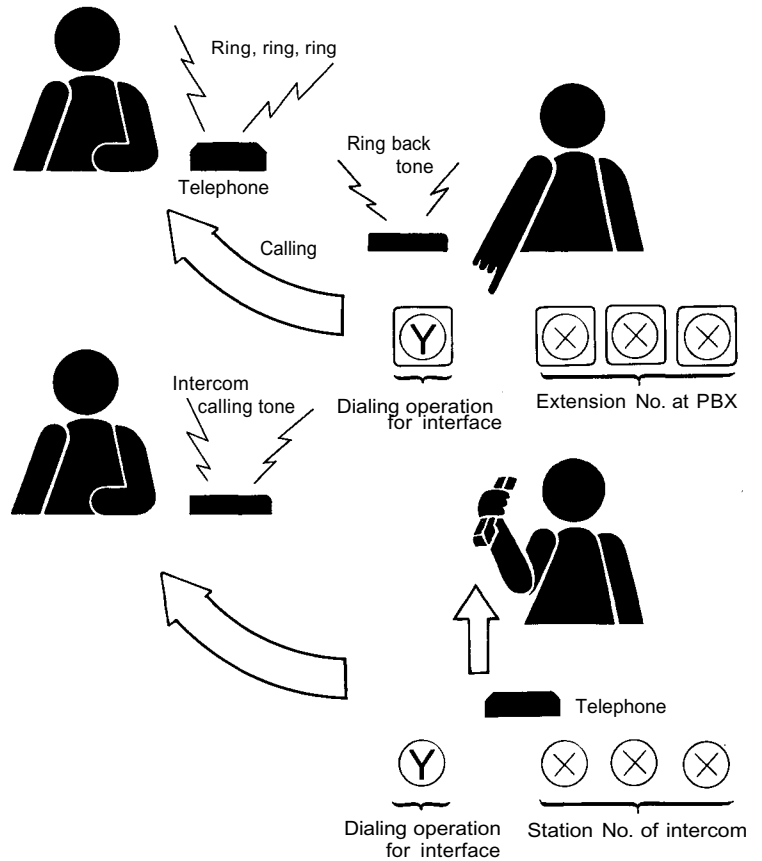

## • LD interface

### 1. Calls from the intercom station to the PBX extension telephone

Dial **Y** (LD interface access No.). After confirming a dial tone from the PBX, dial **X X X** (extension No.).

### 2. Calls from the PBX to the intercom station

Dial **Y** (intercom access No.). After confirming a dial tone from the intercom system, dial **X X X** (station No.), and the call is put through to the station, transmitting an intermittent calling tone.

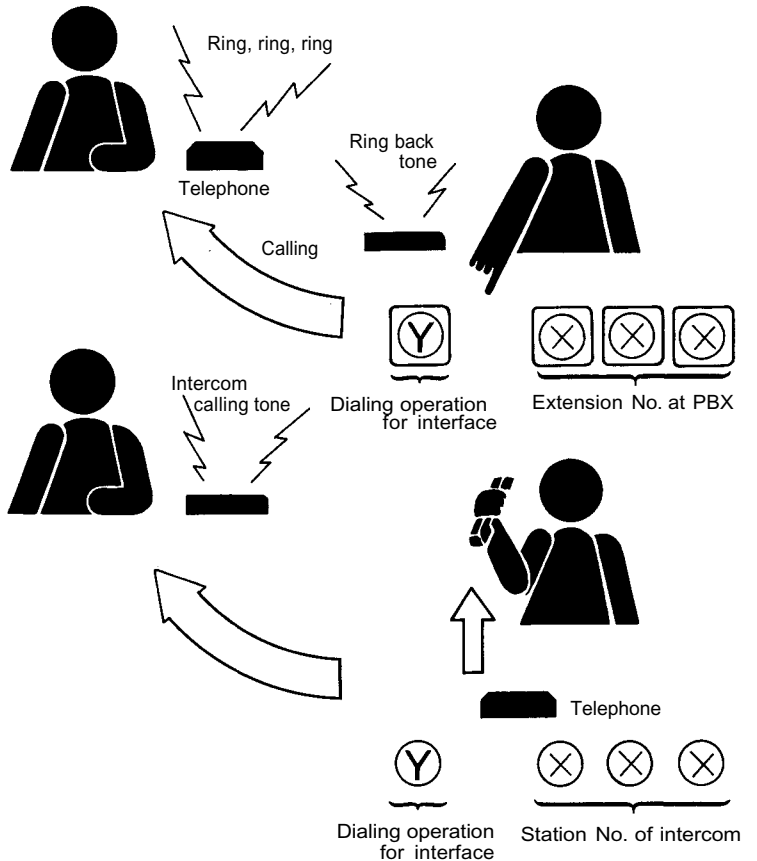

## ● CB interface

### 1. Making outgoing telephone calls from the intercom station

- (1) If the CB-600 is connected to PBX extension lines.

Dial  (CB interface access No.). After confirming a dial tone from the PBX, dial  (dialing for external calling) to gain access to the telephone line. Then, dial the desired telephone number.

- (2) If the CB-600 is connected directly to a telephone line.

Dial  (CB interface access No.) to gain access to the telephone line. Then, dial the desired telephone number.

**(Note 1)**

It is possible to dial a call with the handset replaced. As soon as the called party answers the call, lift the handset and begin conversation.

**(Note 2)**

When registering the telephone numbers into the auto-dialer (HF-660M or AK-024) or for single digit dialing, press  (pause key) immediately after  (CB access No.).

### 2. Picking up on incoming telephone call from the intercom station when CB-600 lines are directly connected to the telephone line.

When you hear the telephone ringing tone (ringing tone from an external speaker, or a short intermittent calling tone from the station speaker), lift the handset and dial  (access No. for call pickup) at any station within the called group. You can then answer the call.

### 3. Other functions of CB interface

- (1) Connection of the pager interface to the CB-600 lines allows a pager with both voice call and indication functions to be called. (For details, refer to the section on pager call and response.)



Specified No.

7 9 7 7 1 2 2 1 1

Outgoing telephone call initiation No.

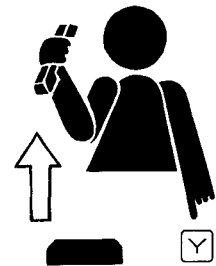
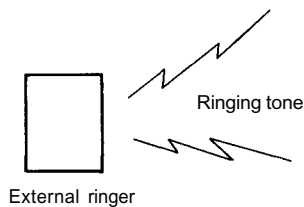

Specified No.

- (2) One of the CB-600 lines can be used to call a city pager. (For details of the registration procedure, refer to the function code 28 of No.200 programming.)

[Operation for calling city pagers]  
 Dial  $\boxed{Y}$  (CB interface access No.) to gain access to the telephone line. Then, dial the desired city pager No.  
 [Dialing to answer a pager call]  
 To communicate with the party who made a call, dial the specified telephone number at the nearest telephone.

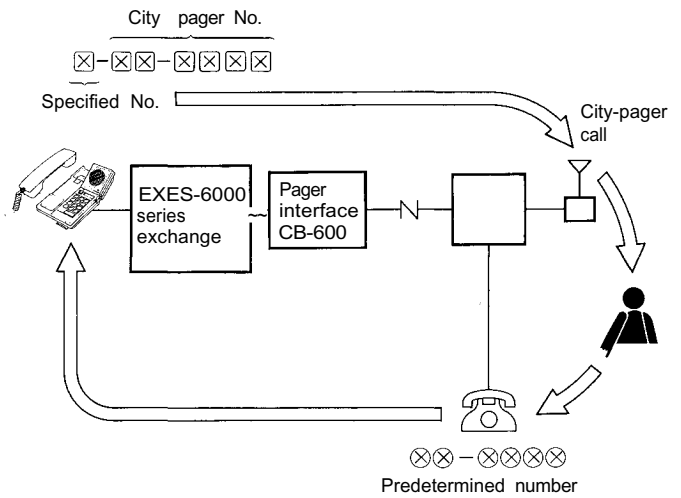

- (3) It is possible to register up to 10 telephone numbers (maximum of 40 digits in length) for speed dialing (2 digits) per exchange. Once the registration has been made, the registered telephone number can be called by dialing 2 digits from the station.

- (4) You can register which stations can be connected to telephone lines. (For details of the registration procedure, refer to function codes 31 and 32 of station No. 200.)

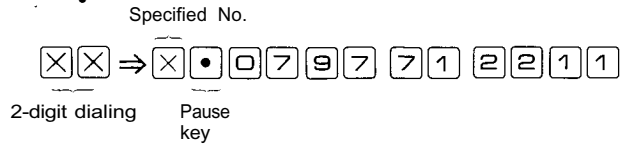

## • Tie-line interface

### 1. Calling an intercom station of remote extension exchange

Dial  Y (access No. for Tie-line interface). After confirming a dial tone from the remote extension exchange, dial the station number as follows:

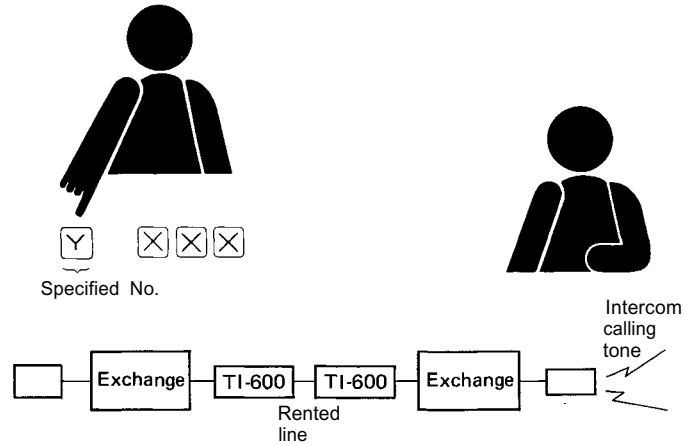

### 2. Making a paging call over the area of remote extension exchange

Dial  Y (access No. for Tie-line interface). After confirming a dial tone from the remote extension exchange, dial as follows:

(paging zone No.)

Then, paging is performed at the other exchange. Hold the line and wait for a response.

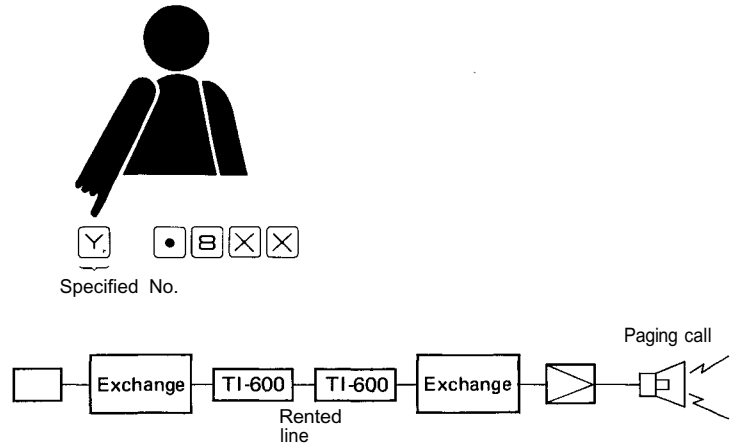

### 3. Paging extending over 2 or more exchanges

By using the Selectable Paging function, a paging can be placed over the area of 2 or more exchanges. (For details, refer to the section describing Selectable Paging.)

### 4. If 4-digit dialing is employed, all the exchanges connected by tie-line can have the numbering schedule of 4 digits in length.

EXES-6000, CP-66 Summary of Dial Operations (4-digit dialing)(Example of single exchange system)

Function	Dialing operation	Number assignment
Press-to-talk	<input type="checkbox"/> PTT One-way conversation <input type="checkbox"/> <input type="checkbox"/> Two-way conversation	
Remote response	<input type="checkbox"/> PTT	
Remote response registration	<input type="checkbox"/> <input type="checkbox"/> PTT <input type="checkbox"/> <input type="checkbox"/> <input type="checkbox"/> <input type="checkbox"/> Confirmation tone	<input type="checkbox"/> <input type="checkbox"/> <input type="checkbox"/> <input type="checkbox"/> : Station No.
Answering continuous calling tone	<input type="checkbox"/> 1~ <input type="checkbox"/> 9, <input type="checkbox"/> 0, <input type="checkbox"/> * or <input type="checkbox"/> #	
Privacy	PRIVACY <input type="checkbox"/> ON  PRIVACY Privacy off <input type="checkbox"/> ON	
Secretary transfer	PRIVACY <input type="checkbox"/> ON  PRIVACY Secretary transfer off <input type="checkbox"/> ON	
Single-digit registration	<input type="checkbox"/> <input type="checkbox"/> <input type="checkbox"/> <input type="checkbox"/> • • <input type="checkbox"/> PTT Registration dials (maximum 6-digits)	
Single-digit dialing	<input type="checkbox"/> 0	
Personal number registration In/out indicator lamp ON	<input type="checkbox"/> <input type="checkbox"/> 1 <input type="checkbox"/> <input type="checkbox"/> <input type="checkbox"/> <input type="checkbox"/> Confirmation tone Personal No.	<input type="checkbox"/> <input type="checkbox"/> <input type="checkbox"/> <input type="checkbox"/> : 1000~1999
Personal number cancellation In/out indicator lamp OFF	<input type="checkbox"/> <input type="checkbox"/> 1 <input type="checkbox"/> <input type="checkbox"/> <input type="checkbox"/> <input type="checkbox"/> Confirmation tone Personal No.	
Personal number call Personal number paging	<input type="checkbox"/> 1 <input type="checkbox"/> <input type="checkbox"/> <input type="checkbox"/> <input type="checkbox"/> Personal No.	
Conference	<input type="checkbox"/> <input type="checkbox"/> <input type="checkbox"/> <input type="checkbox"/> <input type="checkbox"/> <input type="checkbox"/> Calling <input type="checkbox"/> <input type="checkbox"/> <input type="checkbox"/> <input type="checkbox"/> <input type="checkbox"/> Calling <input type="checkbox"/> <input type="checkbox"/> <input type="checkbox"/> <input type="checkbox"/> <input type="checkbox"/> Calling <input type="checkbox"/> <input type="checkbox"/> <input type="checkbox"/> <input type="checkbox"/> <input type="checkbox"/> Calling	<input type="checkbox"/> <input type="checkbox"/> <input type="checkbox"/> <input type="checkbox"/> : Station No., Personal No., Single-digit No.
Call forwarding registration	<input type="checkbox"/> <input type="checkbox"/> <input type="checkbox"/> <input type="checkbox"/> <input type="checkbox"/> <input type="checkbox"/> Confirmation tone	<input type="checkbox"/> <input type="checkbox"/> <input type="checkbox"/> <input type="checkbox"/> : Station receiving transferred message
Conference clear	<input type="checkbox"/> <input type="checkbox"/> <input type="checkbox"/> <input type="checkbox"/> <input type="checkbox"/> <input type="checkbox"/>	
Mic. off	<input type="checkbox"/> <input type="checkbox"/> 7	
Busy call back registration	<input type="checkbox"/> <input type="checkbox"/> <input type="checkbox"/> <input type="checkbox"/> <input type="checkbox"/> Busy tone <input type="checkbox"/> Confirmation tone	<input type="checkbox"/> <input type="checkbox"/> <input type="checkbox"/> <input type="checkbox"/> : Station No., Personal No., Single-digit No.
Busy call-back response	Busy call-back tone <input type="checkbox"/> 0~ <input type="checkbox"/> 9, <input type="checkbox"/> *, <input type="checkbox"/> # or <input type="checkbox"/> #	
Priority/priority response	<input type="checkbox"/> <input type="checkbox"/> <input type="checkbox"/> <input type="checkbox"/> <input type="checkbox"/> Busy tone <input type="checkbox"/> Interrupting tone → Called station <input type="checkbox"/> #	<input type="checkbox"/> <input type="checkbox"/> <input type="checkbox"/> <input type="checkbox"/> : Station No., Personal No., single-digit No.
Executive priority	Interrupting tone <input type="checkbox"/> #	
Highest executive priority	Interrupting tone <input type="checkbox"/> #	
Call transfer	<input type="checkbox"/> <input type="checkbox"/> <input type="checkbox"/> <input type="checkbox"/> <input type="checkbox"/> Call/conversation → <input type="checkbox"/> # Transfer → <input type="checkbox"/> * <input type="checkbox"/> # Conversation with original station	<input type="checkbox"/> <input type="checkbox"/> <input type="checkbox"/> <input type="checkbox"/> : Station No., Personal., Single-digit No.

Function	Dialing operation	Number assignment
All call + 7-zone paging	• 0 7	0 : (All station call) 1 through 7 (zones)
All call + 31-zone paging	• 0 31	00 : (All station call) 01 through 31 (zones)
Combination paging	• 0 7 7	80~99 (Zone combination: 20)
All call paging response	0 0 or • 0 0 0 0	
Zone paging response	• 0 7 or • 0 7 (X) X	1~7 01~31 80~99
Paging transfer	Conversation • 0 7 Conversation after answer → 0 Transfer → • 0 • Conversation with original station	0~7 (00~31) 80~99
One-shot, relay-make output	• 0 7 (X) X X	00~49 000~499
Relay make/break output	• 0 7 7 (X) X X Confirmation tone • 0 7 7 (X) X X Confirmation tone	00~99 000~511
8-selectable, one-shot, relay make output	• 0 7 7 X Y Confirmation tone	1~9 1~8
8-selectable output (Decimal output)	• 0 7 7 (X) X Y Confirmation tone	1~9 01~64 1~8, 0 (Clear) 01~99 0~9
4-digit decimal output	• 0 7 7 X Y Y Y Y Confirmation tone	1~9 0000~9999
Pager call	• 7 (X) X X X X X X • 0	00~99 000~999 0000~9999 Station No.
Pager response	• 4 (X) X X	00~99 000~999 0000~9999
Calling station selection	• 0 7 X X	Station No.
Message recording	• • 2 (8 sec) • • 8 (16 sec) • • 9 (32 sec)	
Message check	• • 3	
Message playback	PRIVACY ON or • • 4	
Message cancellation	• • 6 (Confirmation tone)	
Remote message playback	• • 6 X X X X	Station No.
Clearing calling party indication	0 0	
BGM	• 2 X	Channel select





### 3. Selected rented-line station paging and response

#### [Paging]

First dial

and then  . . .

(Access Nos. of the remote extension system/station Nos.).

After dialing station Nos., press **PTT**.

A maximum of 20 zones can be paged simultaneously. However, the number decreases depending on the number of available links. When any one station in a paged group is busy, this function cannot be used.

#### [Response]

To respond, dial

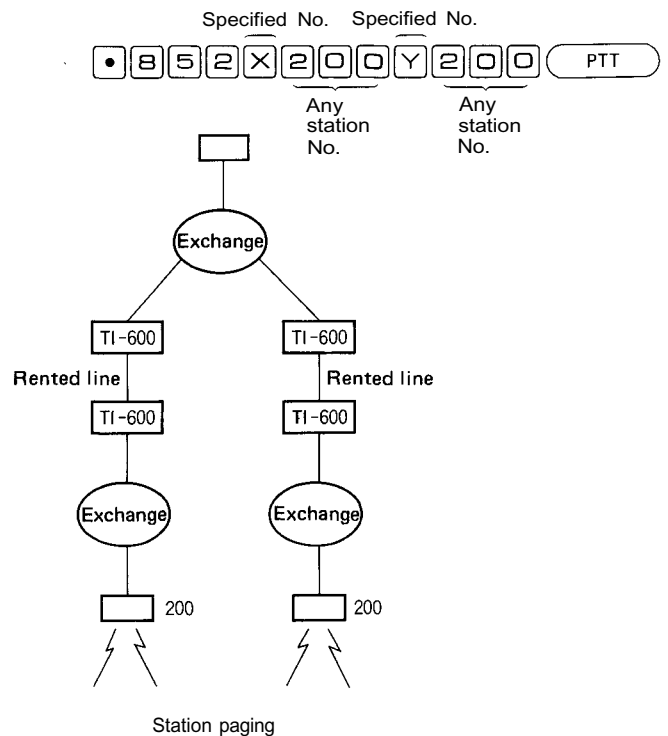

### 4. Selected rented-line zone paging and response

#### [Paging]

First dial

and then  . . .

(Access Nos. of the remote extension system/zone Nos.).

After dialing zone Nos., press **PTT**.

A maximum of 20 zones can be paged simultaneously. However, the number decreases depending on the number of available links. When any in-use zone in a paged group is included, this function cannot be used.

#### [Response]

To respond, dial

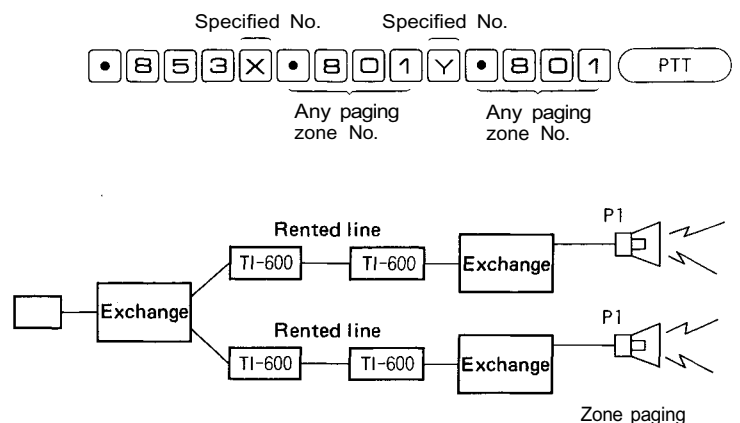

### 5. Selected global all-call paging and response

#### [Paging]

First dial

and then  • • •

(Access Nos. of the remote extension system).

After dialing completion, press .

Same all-call paging is provided over all selected systems as well as the entire system having the operating station.

#### [Response]

To respond, dial

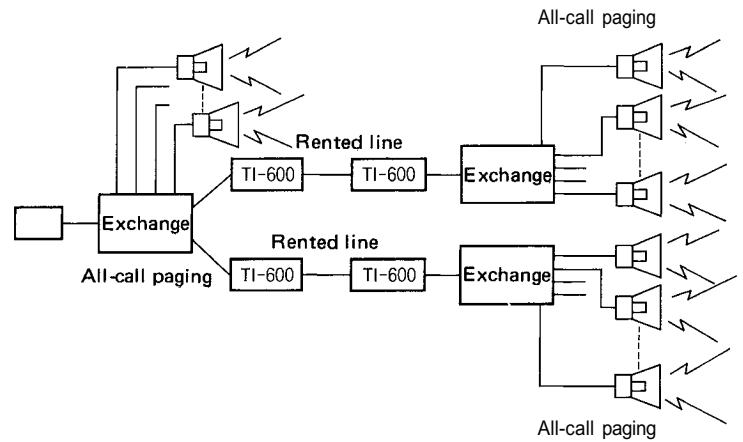
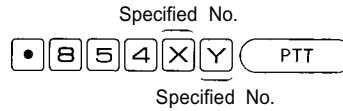

### 6. Selected external all-call paging and response

#### [Paging]

First dial

and then  • • •

(Access Nos. of the remote extension system).

After dialing completion, press .

Same all-call paging is provided over all selected exchange systems. (The system having an operating station is not paged.)

#### [Response]

To respond, dial

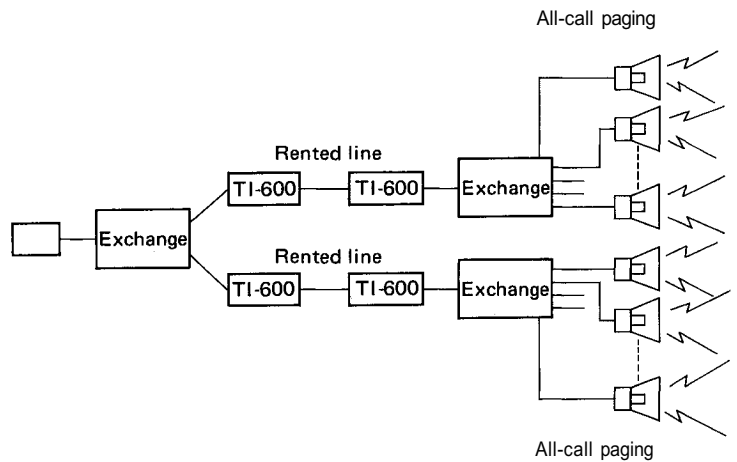
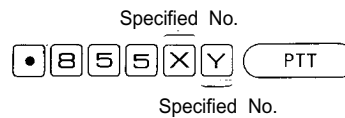

**B. Matrix Selected Paging**

- A maximum of four station or zone numbers can be registered at a time.
- If any one station or zone in a paged group is busy, this function cannot be used.
- The maximum number of stations, zones and rented lines decreases depending on the number of available links.

**(1) Global matrix station paging and response**  
[Paging]

First dial

and then    (system access No.)

Dial    • • •    (station No.)

After station No. entry completion, press **PTT**. Same number station paging is provided over all selected exchange systems as well as the entire system having an operating station.

The maximum number of rented lines that can be used simultaneously for this function is 12 lines even if the system has 16 rented lines.

[Response]

To respond, dial

**(2) External matrix station paging and response**  
[Paging]

First dial

and then    (system access No.)

Dial    • • •    (station No.)

After station No. entry completion, press **PTT**. Same number station paging is provided over all selected exchange system. (The system having an operating station is not paged.)

[Response]

To respond, dial

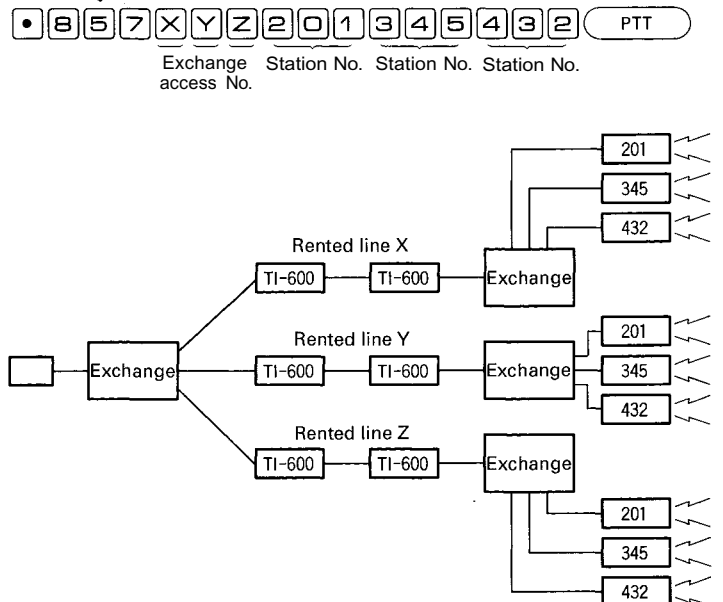
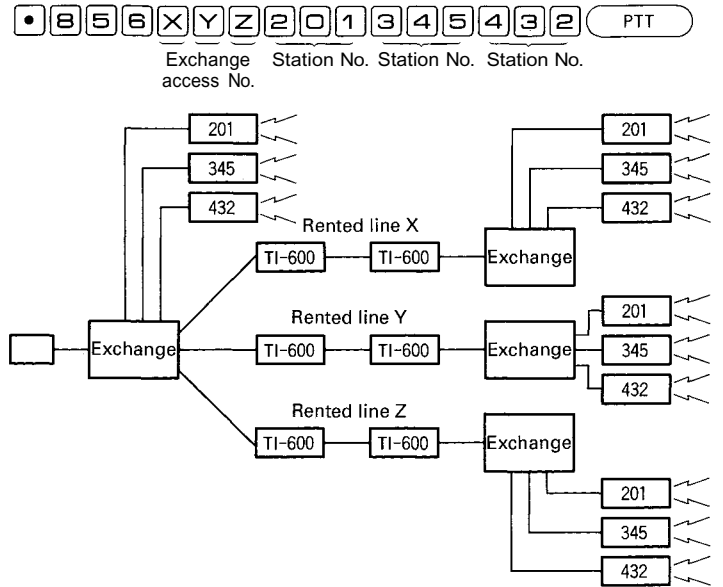

(3) Global matrix zone paging and response  
[Paging]

First dial

and then  (system access No.)

Dial  (zone No.)

After zone No. entry completion, press **PTT**. Same number zone paging is provided over all selected exchange systems as well as the entire system having the operating station.

The maximum number of rented lines that can be used simultaneously for this function is 12 lines even if the system has 16 rented lines.

[Response]

To respond, dial

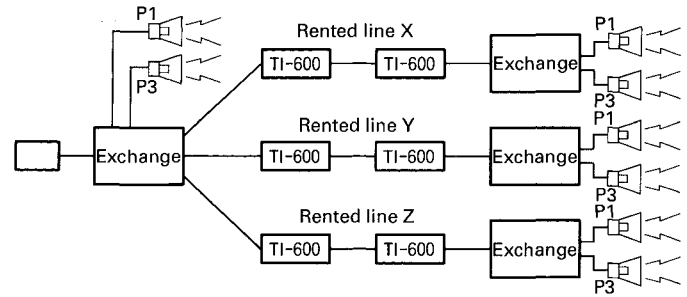
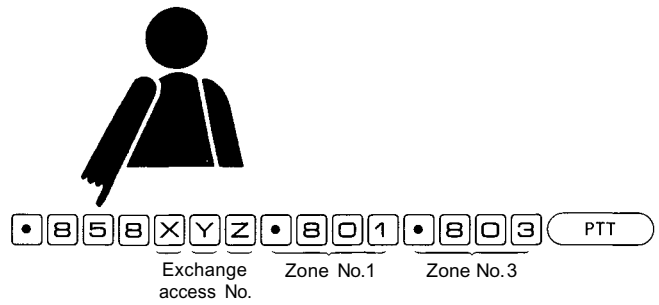

(4) External matrix zone paging and response  
[Paging]

First dial

and then  (system access No.)

Dial  (zone No.)

After zone No. entry completion, press **PTT**. Same number zone paging is provided over all selected exchange systems. (The system having an operating station is not paged.)

[Response]

To respond, dial

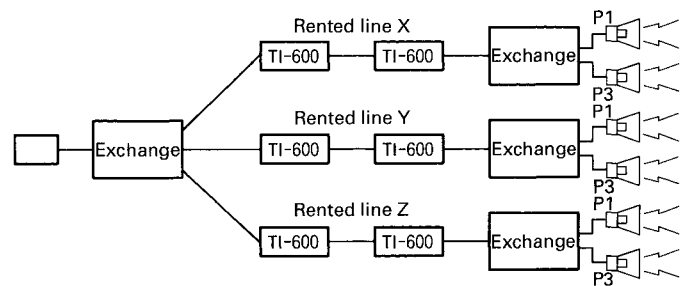
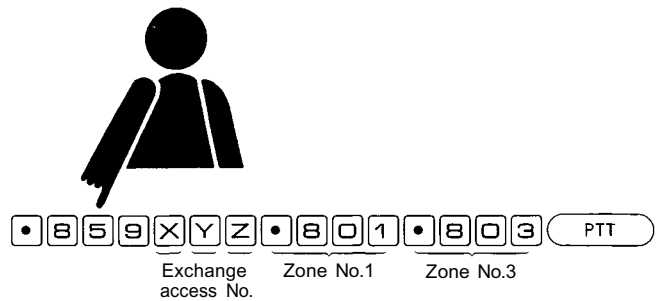

## • Speech message

To make this function available, both the SI-62 interface and SM-600 speech message unit must be connected to the EXES-6000 exchange. The capacity of a voice mailbox is up to 128 x 8-second message.

Functions include

- (1) Absence-mailing. When the user is absent, he can leave his personal message and an incoming call can be recorded into the voice mailbox.
- (2) Message mailing. When the called party is absent or his line is busy, the calling party can leave his personal message in the called station.
- (3) Remote message pickup. The user can retrieve information deposited in the voice mailbox from any master station.

### 1. Absence mailing.

#### 1) Recording a message for the caller

Dial

2 (8 second recording)  
   8 (16 second recording)  
   9 (32 second recording)

and you can record your message. To check the recorded contents (playback), press    3 .

Setting the Privacy switch to ON

ON  
 automatically transmits the recorded message to the caller.

At the end of each selected recording time, a confirmation tone sounds to terminate the recording. If the recording has been finished before the end of the selected recording time, press  . When you wish to change the recording, dial    6 . A confirmation tone is heard and the previous recording is erased, allowing you to make the new recording.

#### 2) How the caller records his message in the called station in the Absence Mailing mode

After hearing the called party's absence message, listen to the entire message or press  . And then dial

- 2 ( 8 second recording)  
   8 (16 second recording)  
   9 (32 second recording)

and begin the recording. The recording can be played back for confirmation by dialing    3 . To change the message, dial    6 , and the previous recording is erased and the new recording can be made.

When, during conversation, either party places the other party on hold to call the third party and the absence message is heard from that third party's station, the original conversation is automatically restored as soon as the absence message is finished.

If you hear a busy tone or dial tone during a recording operation, this indicates that the voice mailbox is full. In such a case, either press  or replace the station handset.

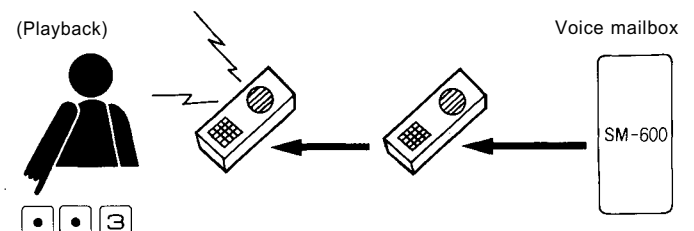
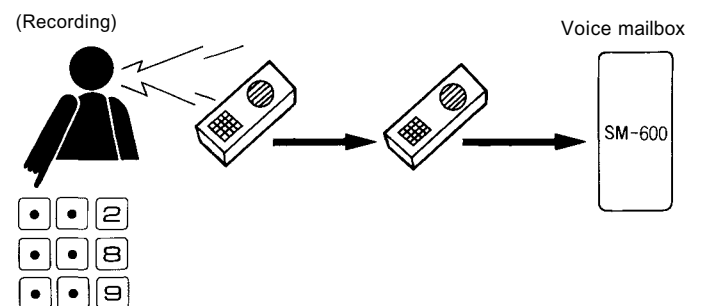
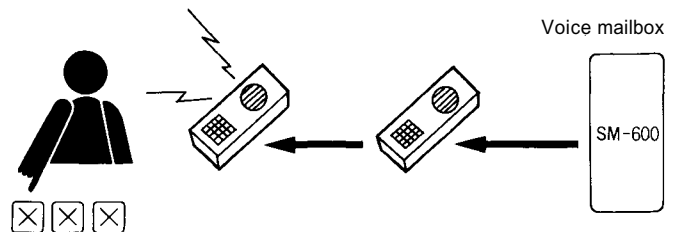
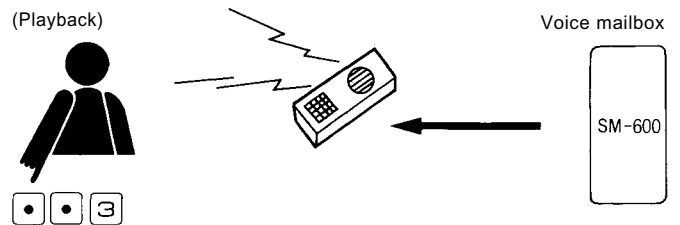
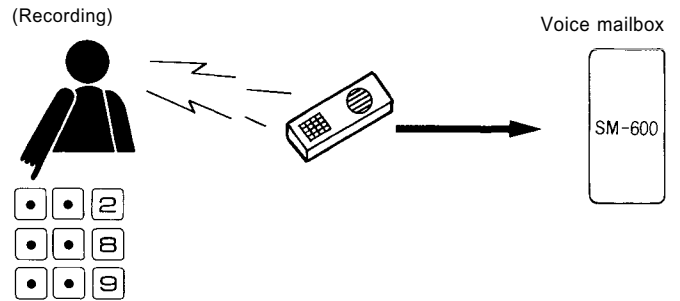

### 3) Cancelling the Absence message

Shifting the Privacy switch back to OFF erases the absence message but allows all incoming calls stored in the voice mailbox to be heard. To hear the recorded message again, dial

••4

Once the Privacy switch has been set to OFF, the recorded Absence message is cancelled.

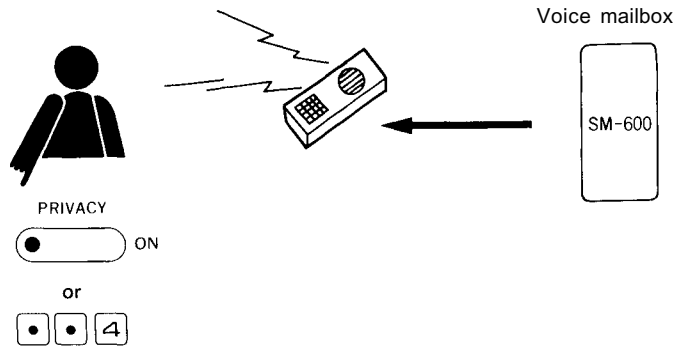

## 2. Message mailing

### 1) Recording

When a person you are calling is absent or his line is busy, you can leave your personal message. Dial

••2 (8-second recording)

••8 (16-second recording)

••9 (32-second recording)

and record your message. The message can be played back for confirmation by dialing ••3. To change the recording, dial ••8, and a confirmation tone is heard and the previous recording is erased.

When, during conversation, either party places the other party on hold to call the third party and the absence message is heard from that third party's station, the original conversation is automatically restored as soon as the absence message is finished.

If you hear a busy tone or dial tone during a recording operation, this indicates that the voice mailbox is full. In such a case, either press ☐ or replace the station handset.

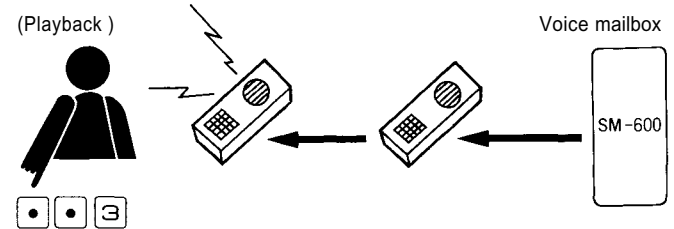
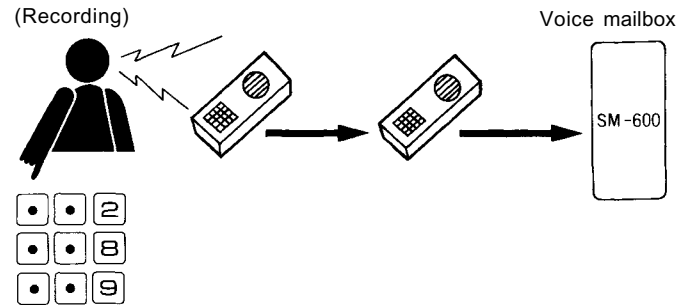

### 2) Playback of recorded messages

Dial ••4 at the station at which the message has been recorded. The message received and recorded during the conversation is automatically played back as soon as the conversation is finished. If you do not wish to listen to the entire message, press ☐.

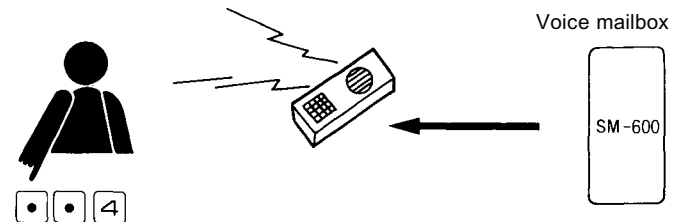

## 3. Remote message pickup

You can get information stored in your station from any other station by dialing

••5☒☒☒

(Your station No.)

To terminate the message halfway, press •.

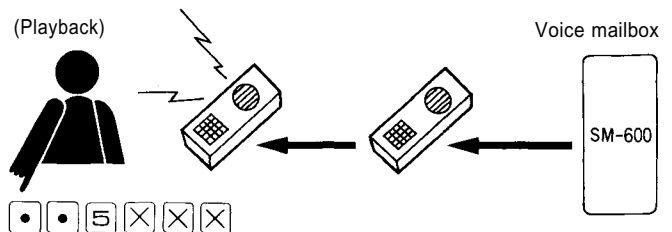

## 4. Other functions

1. It is possible to transmit a "Hurry-up" tone 2 seconds before the selected recording time ends to remind the user to finish the recording quickly.
2. A brief message tone is transmitted every one minute from the station where incoming calls have been recorded, indicating the message has been recorded.

## • Background music (BGM)

Eight (8) different BGM channels are available for selection.

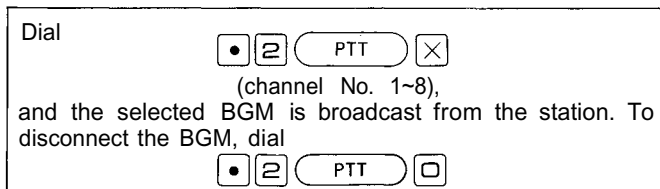

### Notes.

- 1) It is possible to make or receive a call even when the BGM is on. In this event, the call automatically takes over the BGM. The interrupted BGM is automatically restored as soon as the call is finished.
- 2) Even when all speech paths are occupied, the desired BGM channel can be selected.
- 3) If it is desirable to hear other sounds than BGM, this can be accomplished by connecting such external equipment as an air-monitor microphone or radio equipment instead of the BGM equipment.
- 4) The following equipment is required to have the BGM function in the system.
  - ① CP-66 central processing unit (version 1.20/2.10)
  - ② LM-65C line modem unit
  - ③ anyone frame of FR-610A, FR-620A, FR-630A or FR-630A/FR-631A
  - ④ BOX-08 terminal box
  - ⑤ external BGM equipment
- 5) If the LM-62C and/or the LM-62A are mixed up with the LM-65C in the system, the stations connected to the LM-65C only can be heard the BGM.

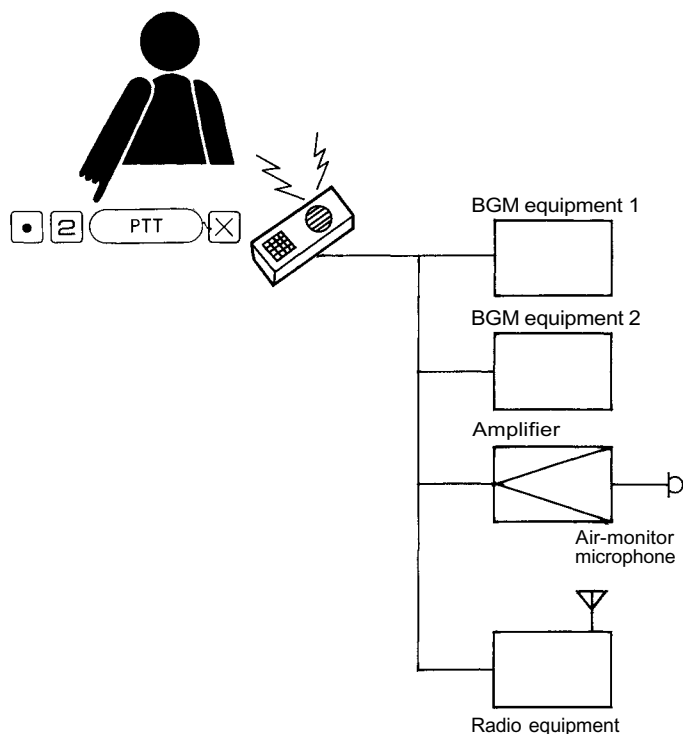
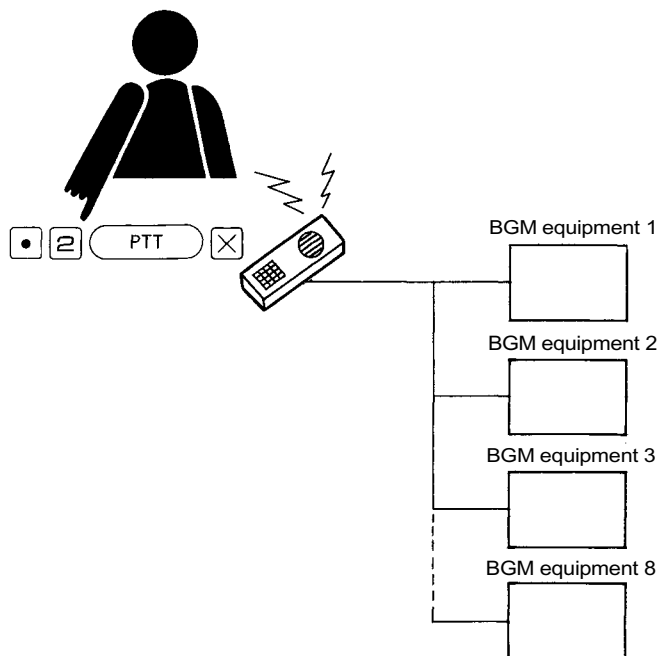



## ● Alarm

---

Operation of this function not only terminates every conversation and paging call, but also temporarily stops BGM and time signal broadcasts, allowing the alarm call to go through all the stations. The interrupted broadcasts are automatically restored as soon as the alarm call is finished.

### Notes.

- 1) No dialing can be accomplished during the alarm call.
- 2) The following equipment is required to have the alarm function in the system.
  - ① LM-65C line modem unit
  - ② any one frame of FR-610A, FR-620A, FR-630A or FR-630A/FR-631A
  - ③ BOX-08 terminal box
  - ④ external equipment for the input of alarm drive
  - ⑤ external equipment for the input of alarm
- 3) If the LM-62C and/or the LM-62A are mixed up with the LM-65C in the system, the stations connected to the LM-65C only can be heard the alarm.

## ● Time Signal

---

Time signal is sounded at the stations not used for the conversation or paging call, interrupting BGM. The interrupted BGM is automatically restored as soon as the time signal stops.

### Notes.

- 1) It is possible to make or receive a call even while the time signal is being sounded.
- 2) The interrupted time signal is restored as soon as the call is finished.
- 3) The following equipment is required to have the time signal function in the system.
  - ① LM-65C line modem unit
  - ② any one frame of FR-610A, FR-620A, FR-630A or FR-630A/FR-631A
  - ③ BOX-08 terminal box
  - ④ external equipment for the input of time signal drive
  - ⑤ external equipment for the input of time signal
- 4) If the LM-62C and/or the LM-62A are mixed up with the LM-65C in the system, the stations connected to the LM-65C only can be heard the time signal.



**E 2.0**

Printed in Japan  
133-06-156-7B

## Free Manuals Download Website

<http://myh66.com>

<http://usermanuals.us>

<http://www.somanuals.com>

<http://www.4manuals.cc>

<http://www.manual-lib.com>

<http://www.404manual.com>

<http://www.luxmanual.com>

<http://aubethermostatmanual.com>

Golf course search by state

<http://golfingnear.com>

Email search by domain

<http://emailbydomain.com>

Auto manuals search

<http://auto.somanuals.com>

TV manuals search

<http://tv.somanuals.com>