



STEREO MIXER

M-243

	CAUTION <small>RISK OF ELECTRIC SHOCK DO NOT OPEN</small>	
<p>CAUTION</p> <p>TO REDUCE THE RISK OF ELECTRICAL SHOCK, DO NOT REMOVE COVER. NO USER SERVICEABLE PARTS INSIDE. REFER SERVICING TO QUALIFIED SERVICE PERSONNEL.</p>		

 THE LIGHTNING FLASH WITH ARROWHEAD WITHIN A TRIANGLE IS INTENDED TO TELL THE USER THAT PARTS INSIDE THE PRODUCT ARE A RISK OF ELECTRIC SHOCK TO PERSONS.

 THE EXCLAMATION POINT WITHIN A TRIANGLE IS INTENDED TO TELL THE USER THAT IMPORTANT OPERATING AND SERVICING INSTRUCTIONS ARE IN THE PAPERS WITH THE APPLIANCE.

TABLE OF CONTENTS	
HANDLING PRECAUTIONS	2
GENERAL DESCRIPTION	2
FEATURES	2
NOMENCLATURE AND FUNCTIONS	3,4
INTERNAL SWITCH SETTINGS	5
BLOCK AND LEVEL DIAGRAM	6
DIMENSIONAL DIAGRAM	6
SPECIFICATIONS	7

Please follow the instructions in this manual to obtain the optimum results from this unit. We also recommend that you keep this manual handy for future reference.

1. HANDLING PRECAUTIONS

- Operating voltage range is AC mains $\pm 10\%$ (50/60Hz).
- Keep corrosive chemicals and beverages away from the unit as they may be spilt.
- When any irregularity is found, be sure to contact your nearest TOA dealer. Make no further attempt to use the unit to avoid electrical shocks.

2. GENERAL DESCRIPTION

The TOA M-243 is a 19" rack mountable (1 unit size) stereo mixer that comes with two monaural inputs, four stereo inputs, one stereo output and two monaural outputs.

3. FEATURES

- Two monaural inputs, four stereo inputs, one stereo output, and two monaural outputs. Each input signal can be assigned to three outputs.
- Sub-input for each bus line to the stereo output and two monaural outputs.
- Microphone input or line input selectable for monaural input depending on the signal level. Internal limiter minimizes signal distortion due to excessive input. Internal switches operate a high-pass filter function in the input circuit, and a pad (20dB) function in the microphone input.
- Signal clip indicator.
- Automatic muting function (can be switched on and off) detects the monaural input signal and automatically mutes the stereo output signal.
- Stereo output has a recording output and equalizers for high and low frequencies.
- Two monaural outputs also function as stereo sum outputs by internal switch setting.
- Assign button cover serves as a writing block.
- Knobs supplied in different colors for easy association with their respective controls.

4. NOMENCLATURE AND FUNCTIONS

[Front Panel]

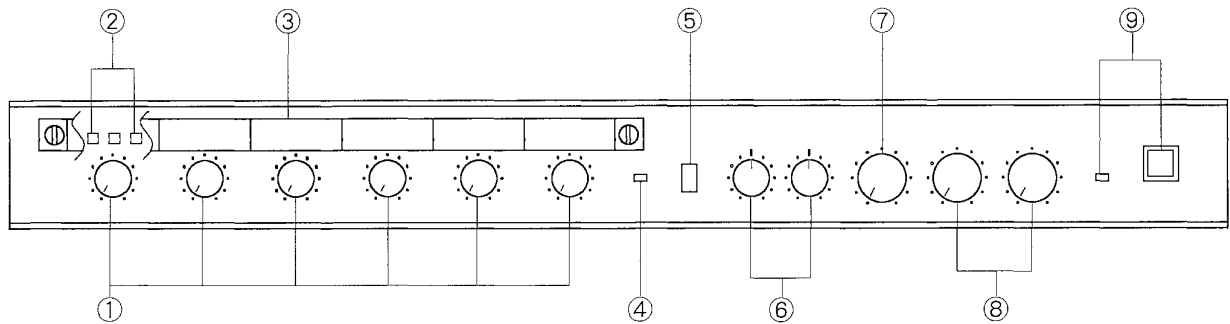

① Input level controls [1-6] (1-2 : Monaural input, 3-6 : Stereo input)
These controls adjust the input level of each channel.

② Assign buttons [ST, 1, 2]
These buttons select the output to which the post-input level control signals are delivered.

ST : Stereo output
1 : MONO 1 output
2 : MONO 2 output

③ Assign button cover
This cover protects the assign switch setting from accidental change. It can also be used as a writing block.

④ Clip indicator [PEAK]
This lamp lights when the signal reaches 3dB below clipping. Adjust the signal level using individual input level controls so that this lamp lights only accidentally.

⑤ Mute ON/OFF button [AUTO MUTE]
This button turns on the muting facility when pressed. (The muting indicator will light.) By detecting the signal assigned to the stereo output from channel 1 or 2, the signal assigned to stereo outputs from channel 3 through channel 6 is muted. (The signal assigned to the monaural output is not muted.)

⑥ Equalizer controls [EQ : LOW, HIGH]
These controls adjust stereo output signal tone.

LOW : Low frequency adjustment
(20Hz, ± 15 dB shelving)
HIGH : High frequency adjustment
(20kHz, ± 15 dB shelving)

⑦ Stereo output level control [STEREO]
This control adjusts a stereo output level.

⑧ Monaural output level controls [MONO 1, 2]
These controls adjust each monaural output level.

⑨ Power button and power lamp [POWER]
This button switches power on (the power lamp lights) and off (the lamp is extinguished).

[Rear Panel]

For technical details of each input and output, refer to the section "8. SPECIFICATIONS".

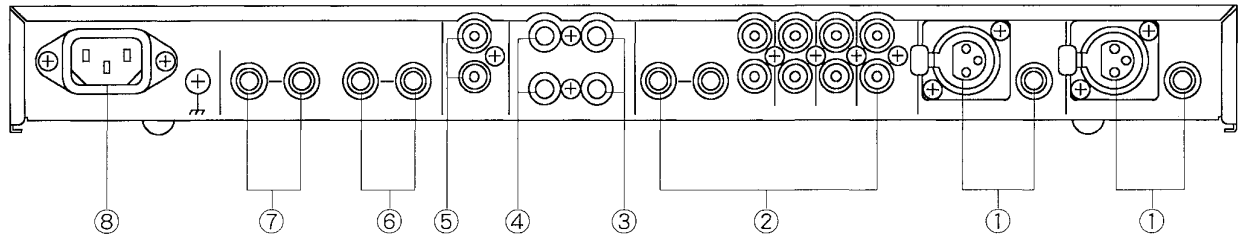

- ① Monaural input terminals (1,2) [MIC, LINE]
Select either MIC or LINE for connection. If both are connected, LINE input takes precedence.
- ② Stereo input jacks (3-6) [L , R]
Only CH6 RCA jacks are connected in parallel with phone jacks.
- ③ Stereo sub-input terminals [SUB IN STEREO L / M, R]
Signals from these terminals are assigned to stereo output buses that go to the stereo output. Connecting only "L" will input to both "L" and "R".
- ④ Monaural sub-input terminals [SUB IN MONO 1,2]
Signals from these terminals are assigned to monaural output buses that go to monaural output 1 and 2.
- ⑤ Recording output jacks [REC L , R]
These stereo recording jacks output the signal from the stereo output bus.
- ⑥ Stereo output jacks [STEREO OUT L , R]
- ⑦ Monaural output jacks [MONO OUT 1, 2]
These jacks also function as stereo sum outputs by internal switch setting. (Refer to the section "5. INTERNAL SWITCH SETTINGS".)
- ⑧ AC inlet
Connect the supplied power cord to this inlet.

5. INTERNAL SWITCH SETTINGS

[CAUTION]

THESE SERVICING INSTRUCTIONS ARE FOR USE BY QUALIFIED PERSONNEL ONLY. TO AVOID ELECTRIC SHOCK DO NOT PERFORM ANY SERVICING OTHER THAN THAT CONTAINED IN THE OPERATING INSTRUCTIONS UNLESS YOU ARE QUALIFIED TO DO SO. REFER ALL SERVICING TO QUALIFIED SERVICE PERSONNEL

The M-243 mixer enables the following functions by setting internal switches.

(1) [PAD switch]

Setting this switch to IN position will place a pad (20dB) in the monaural input (MIC input). [→ IN]

(2) [HPF switch]

Setting this switch to IN position will place a high-pass filter (300Hz, -6dB/oct) in the monaural input. [→ IN]

(3) [GND switch]

Setting this switch to LIFT position will cut a ground loop which generates noise. [→ LIFT]

(4) [MONO1] and [MONO 2] switches

Setting each switch to ST SUM position will change each monaural output to stereo sum output. [→ ST SUM]

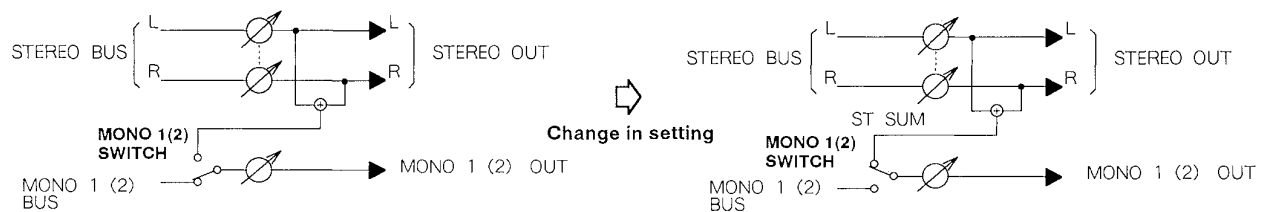

How to open the mixer case

1. Set the power switch to OFF and unplug the power cord from a wall outlet.
2. Remove case fixing screws (10 places).
 - 4 each at left and right mounting brackets = 8
 - 1 each at both sides (back of side panel) = 2
3. Remove the case.
4. Replace the case after setting change completion.

<Switch location>

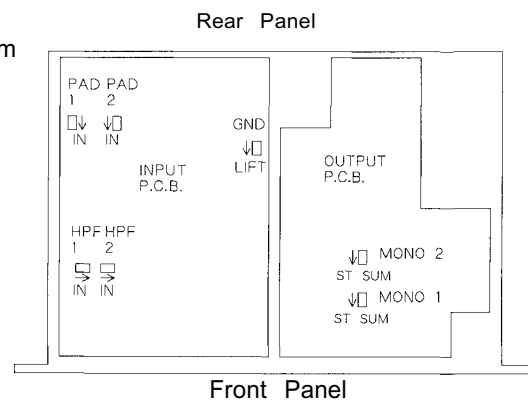

[Precautions]

To avoid electrical shocks and equipment failures, do not touch the internal components other than switches. Each internal switch is factory-preset to the reverse direction of that which is indicated above by the arrow.

6. BLOCK AND LEVEL DIAGRAM

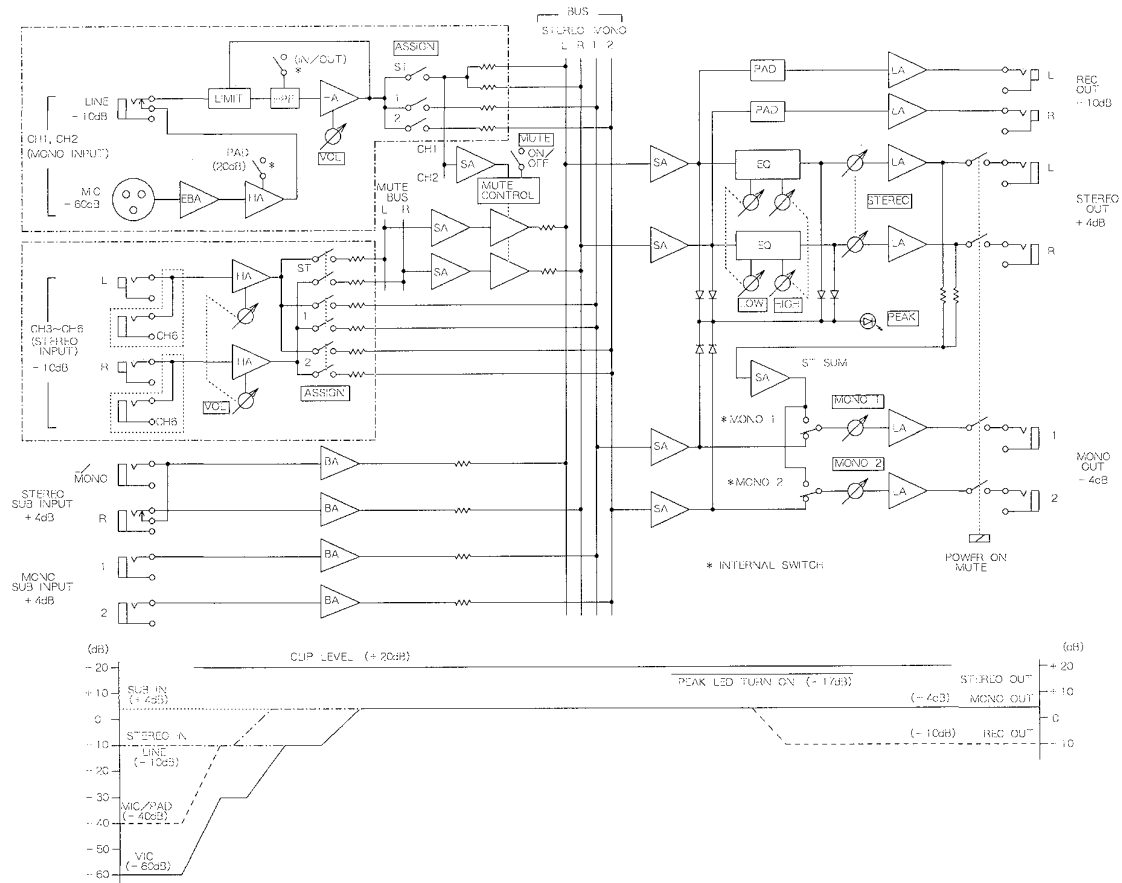

7. DIMENSIONAL DIAGRAM

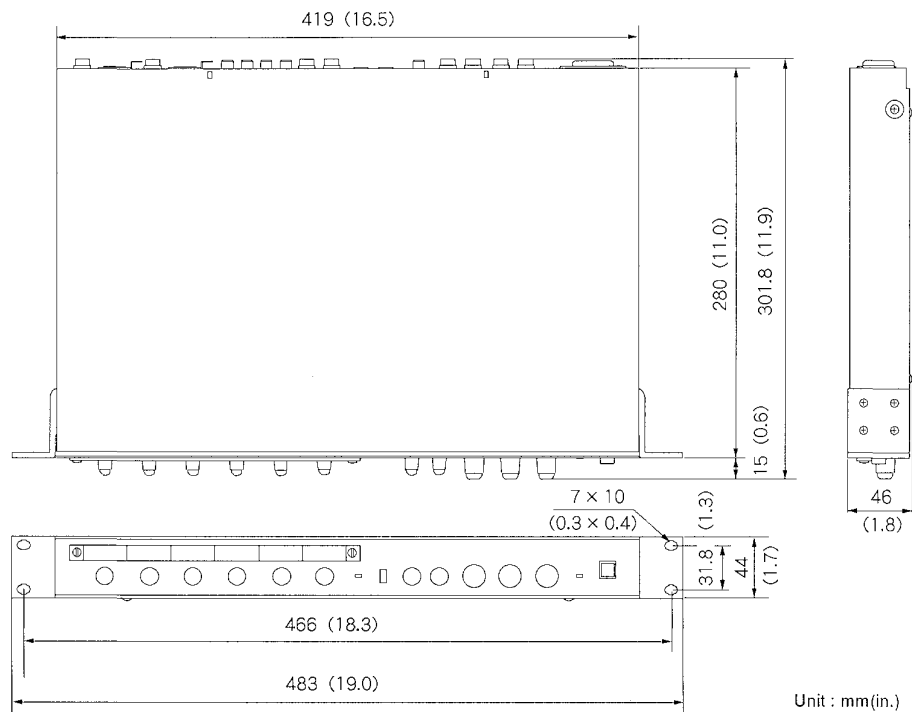

Unit : mm(in.)

8. SPECIFICATIONS

● Inputs and Outputs

Nomenclature		Rated level	Maximum level	Impedance	Connector type
CH1, CH2 (MONO INPUT)	MIC	-60dB*	-30dB*	1 kΩ	XLR TYPE ①: GND ②: COLD ③: HOT (ELECTRICAL BAL)
	MIC (PAD)	-40dB*	-10dB*		
	LINE	-10dB*	—	10 kΩ	PHONE (UNBAL)
CH3~CH6 (STEREO INPUT L, R)		-10dB*	—	10 kΩ	RCA PIN (UNBAL) (CH6••••& PHONE)
SUB INPUT	STEREO (L/M, R)	+4dB*	+20 dB*	50 kΩ	PHONE (UNBAL)
	MONO (1,2)	+4dB*	+20 dB*	50 kΩ	PHONE (UNBAL)
STEREO OUTPUT (L,R)		+4dB*	+20 dB*	1 kΩ	PHONE (UNBAL)
MONO OUTPUT (1,2)		+4dB*	+20 dB*	1 kΩ	PHONE (UNBAL)
REC OUTPUT (L,R)		-10dB*	+6dB*	1 kΩ	RCA PIN (UNBAL)

* 0dB=0.775Vrms

● General Specifications

Frequency Response	20 Hz - 20 kHz (+1, -2dB)			
Total Harmonic Distortion	Less than 0.01% (1 kHz, rated input/output)			
Noise Level (A-Weighted)	ALL MIN. STEREO OUT (L, R) : - 105 dB or less MONO OUT (1,2) : - 98 dB or less			
	STEREO, MONO 1, 2 MAX. STEREO OUT (L, R) : - 94 dB or less MONO OUT (1,2) : - 95 dB or less			
Power Requirement	AC mains			
Power Consumption	120 V version : 10 W, 220-240 V version : 12 W			
Dimensions	482.6 (W) x 44.0 (H) x 301.8 (D) mm 19 (W) x 1.73 (H) x 11.88 (D) in.			
Weight	3.8kg (8.38 lb.)			
Finish	Black			
Standard Accessories	Rack-mounting screw	4	Knob(blue, small)	2
	Rubber foot	4	Knob(red, small)	2
	Operating instructions	1	Knob(blue, large)	2
			Knob(red, large)	2

*0 dB=0.775 V rms

Specifications are subject to change without notice.

Free Manuals Download Website

<http://myh66.com>

<http://usermanuals.us>

<http://www.somanuals.com>

<http://www.4manuals.cc>

<http://www.manual-lib.com>

<http://www.404manual.com>

<http://www.luxmanual.com>

<http://aubethermostatmanual.com>

Golf course search by state

<http://golfingnear.com>

Email search by domain

<http://emailbydomain.com>

Auto manuals search

<http://auto.somanuals.com>

TV manuals search

<http://tv.somanuals.com>