

READ AND SAVE THESE INSTRUCTIONS

WARNING: A risk of fire and electrical shock exists in all electrical appliances and may cause personal injury or death. Please follow all safety instructions.



ToasterMaster®

Steam and Dry Iron Use and Care Guide Model 3310X

IMPORTANT SAFETY INSTRUCTIONS

When using electrical appliances, basic safety precautions should always be followed to reduce the risk of fire, electric shock and injury to persons, including the following:

- Read all instructions before using appliance.
- Close supervision is necessary when appliance is used near children.
- This appliance is not for use by children.
- Do not operate any damaged appliance. Do not operate with a damaged cord or plug, or after the appliance malfunctions or has been dropped or damaged in any manner. Return appliance to the nearest authorized service facility for examination, repair or mechanical adjustment.
- Do not immerse the iron in water or other liquid. See instructions for cleaning.
- Do not use outdoors or while standing in damp area.
- Use iron only for its intended use.
- The iron should be turned to MIN before plugging or unplugging from outlet. Never yank cord to disconnect from outlet; instead grasp plug and pull to disconnect.
- Do not allow cord to touch hot surfaces. Let iron cool completely before putting away. Loop cord loosely around iron when storing.
- Always disconnect iron from electrical outlet when filling with water or emptying and when not in use.
- Burns can occur from touching hot metal parts, hot water or steam. Use caution when you turn a steam iron upside down — there may be hot water in the reservoir.
- Do not leave iron unattended while hot or connected or on an ironing board.
- Position iron carefully on ironing board to avoid it from being knocked over.

SPECIAL INSTRUCTIONS

- This is a high wattage appliance. To avoid a circuit overload, do not operate another high wattage appliance on the same circuit.
- If an extension cord is absolutely necessary, a 13 ampere cord should be used. Cords rated for less amperage may overheat.
- Care should be taken to arrange the cord so that it cannot be pulled or tripped over.
- This appliance has a polarized plug (one blade is wider than the other). As a safety feature, this plug will fit in a polarized outlet only one way. If the plug does not fit fully in the outlet, reverse the plug. If it still does not fit, contact a qualified electrician. Do not attempt to defeat this safety feature.

SAVE THESE INSTRUCTIONS

FEATURES DIAGRAM 1

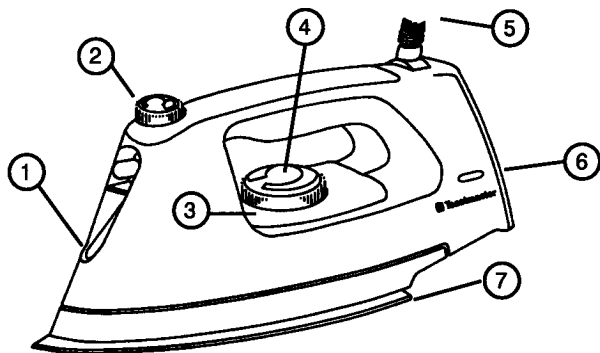





- | | |
|--|---|
| <ul style="list-style-type: none"> 1. Water fill hole 2. Variable steam dial 3. See-through water reservoir | <ul style="list-style-type: none"> 4. Temperature control dial 5. Pivot cord 6. Power on/ready light 7. Polished aluminum soleplate |
|--|---|

USING YOUR IRON



Note: Before you use your iron for the first time, you should flush the soleplate steam vents to ensure that no stain is transferred onto fabric from residue possibly left in the vents from the manufacturing process. To do this, see SELF-CLEANING/FLUSHING.

TEMPERATURE AND STEAM GUIDE

Fabric	Temperature/Steam
Delicates Nylon Acetate Silk	Low 
Polyester Wool	Medium 
Cotton Linen	High  

For best results, check garment labels for the temperature and steam setting recommended by the fabric manufacturer, or consult the enclosed garment care tips pamphlet for additional information.

To prevent damaging garments from too hot of an iron, it is best to first iron garments that require a low temperature. If you should need to switch from a high

setting to a lower temperature, for example  Cotton/Linen to  Nylon, allow the iron about 5 minutes to reach the lower temperature.

Tips: If you are unsure of a garment's fabric content, start on a low setting and test the iron on an area of the garment that does not show, such as a seam. Gradually increase the heat setting until wrinkles remove without damaging the fabric.

To freshen up garments made of velvet, felt, suede or velour, hold the steaming iron horizontally 2 inches above the fabric for a gentle steaming. Make sure the iron does not come in contact with the fabric.

To prevent shine, iron dark garments or those made of silk, acetate or rayon inside out.

DIAGRAM 2

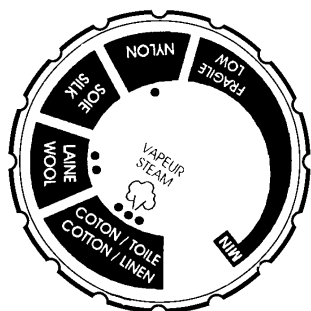
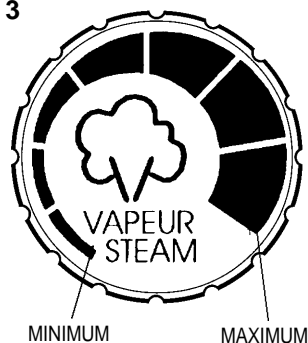

DIAGRAM 3



USING AS A DRY IRON

The iron can be used on the dry setting with or without water in the tank, however it is best to avoid having the tank too full of water while dry ironing.

1. Position temperature control dial to MIN, lowest setting. **Diagram 2.**
2. Turn the variable steam dial to the lowest setting. **Diagram 3.**
3. Stand the iron on its heel in an upright position on an iron-safe surface and plug it in.
4. Turn the temperature control dial to the desired setting. **Diagram 2.**
5. When the ready light turns off, the iron has reached the desired temperature.
6. When finished, turn temperature control dial to MIN, and unplug. Allow the iron to cool before cleaning the exterior or storing.

NOTE: During ironing, the ready light may turn on again which indicates that the iron is heating up to maintain the proper temperature.

CAUTION: If the iron has been used for a long time and is hot, DO NOT fill it with water.

USING AS A STEAM IRON

When using as a steam iron, be sure the temperature setting on the control dial is within the STEAM range to avoid water spotting on a garment.

1. Position temperature control dial to MIN, lowest setting. **Diagram 2.**
2. Position the variable steam dial to lowest setting. **Diagram 3.**
3. With the unit UNPLUGGED, fill the iron with water. (See FILLING THE WATER TANK instructions.)
4. Stand the iron on its heel in an upright position on an iron-safe surface and plug in.

SELF-CLEANING/FLUSHING

Flushing the iron is advised after every 5 usages to prevent harmful mineral build-up that can clog the iron and prevent it from heating and steaming properly. To flush the iron:

1. Position temperature control dial to MIN, lowest setting. **Diagram 2.**
2. Turn variable steam dial to the lowest setting. **Diagram 3.**
3. Fill the iron's water tank to its maximum fill line. **Diagram 5.**
4. Plug the iron in and set the temperature control dial to its highest setting or cotton/linen. Let it heat for 2 minutes. 
5. Turn the variable steam dial to the highest setting.
6. Place a hand towel over the ironing surface.
7. Hold the iron horizontally 2 inches above the towel allowing steam to flow through the vents until the water tank is emptied.
8. Pass the iron over a damp cloth to clean the soleplate.
9. When finished, turn temperature control dial to MIN, lowest setting, and variable steam dial to lowest setting, and unplug. Allow iron to cool before cleaning the exterior of the iron or storing. Use a cloth to wipe off exterior of iron before storing.

DIAGRAM 6



STORING THE IRON

Remove the cord from the outlet by grasping the plug rather than pulling the cord, and allow iron to cool. **EMPTY** the water tank after each use, then wrap the cord around the cooled iron as shown. **Diagram 6.** Allow the iron to **COOL COMPLETELY** before putting it away. To protect the soleplate, place the iron in an upright position on its heel.

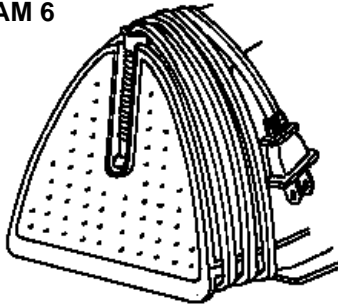
CLEANING AND CARE

CAUTION: Unplug the iron from the electrical outlet before cleaning the exterior of the iron and storing. Never immerse an appliance in water.

To protect the soleplate from scratching, avoid ironing over snaps, zippers, metal buttons, etc. Also, do not place the iron on metal or rough surfaces. If starch or other residues cling to the soleplate, use hot iron cleaner according to directions. Hot Iron Cleaner is available at mass merchandise, discount or hardware stores.

A "home remedy" for cleaning starch or other material buildup on the soleplate is as follows:

1. Unplug the iron and allow to cool completely.

2. Mix together 4 tablespoons baking soda and 1 tablespoon water.
3. Apply mixture to the soleplate with a soft cloth.
4. Clean mixture off with a water dampened clean cloth, dry thoroughly.

Note: DO NOT put any chemical cleaning agents or solvents in the water tank.

IMPORTANT: Any servicing that requires disassembly must be performed by an authorized service center.

SERVICE INFORMATION

Please refer to warranty statement to determine if in-warranty service applies.

This appliance must be serviced by a Toastmaster authorized service center. Unauthorized service will void warranty. Consult your phone directory under "Appliances-Household-Small-Service and Repair," or call 1-800-947-3744 in the U.S. and Canada, 52-5-397-2848 in Mexico.

If an authorized service center is not available locally, your appliance may be returned postage prepaid to our National Service Center at the address shown in the warranty statement.

Products must be adequately protected to avoid shipping damage. Surround your appliance with three inches of protective padding and include a copy of your dated sales receipt and a note explaining the problem you have experienced. We recommend insuring your package. No CODs accepted.

ONE YEAR LIMITED WARRANTY

Toastmaster Inc. warrants this product, to original purchaser, for one year from purchase date to be free of defects in material and workmanship.

This warranty is the only written or express warranty given by Toastmaster Inc. This warranty gives you specific legal rights. You may have other rights which vary from state to state. ANY OTHER RIGHT WHICH YOU MAY HAVE, INCLUDING ANY IMPLIED WARRANTY OF MERCHANTABILITY OR FITNESS FOR A PARTICULAR PURPOSE IS LIMITED IN DURATION TO THE DURATION OF THIS WARRANTY.

Defective product may be brought or sent (freight prepaid) to an authorized service center listed in the phone book, or to Service Department, Toastmaster Inc., 708 South Missouri St., Macon, MO 63552, for free repair or replacement at our option. Your remedy does not include: cost of inconvenience, damage due to product failure, transportation damages, misuse, abuse, accident or the like, or commercial use. IN NO EVENT SHALL TOASTMASTER INC. BE LIABLE FOR INCIDENTAL OR CONSEQUENTIAL DAMAGES.

Some states do not allow limitations on how long an implied warranty lasts, or allow the exclusion or limitation of incidental or consequential damages, so the above limitations or exclusions may not apply to you.

For information, write Consumer Claims Manager, at the Macon address. Send name, address, zip, telephone area code and daytime number, model, serial number, and purchase date.

KEEP DATED SALES RECEIPT FOR WARRANTY SERVICE.

Keep this booklet. Record the following for reference:

Date purchased _____

Model number (stamped on bottom) _____

Toastmaster Inc.

National Service Center
708 South Missouri
Macon, MO 63552

In USA and Canada call:

Consumer Service 1-800-947-3744
Consumer Parts 1-800-947-3745
Hours: 8:00 a.m.- 4:30 p.m. CST

Aux E.-U. et au Canada, veuillez appeler

Service consommateur : 1-800-947-3744

Pièces détachées consommateur : 1-800-947-3745

Heures ouvrables : 8 h - 16 h 30 Heure Centrale

En México - 52-5-397-2848

Horario: 8:00 a.m. hasta 4:30 p.m., hora del Centro

Toastmaster de México, SA de CV
Cerrada de Recursos
Hidráulicos Numero 6
La Loma Industrial
Tlalneantla de Baz, C.P. 54060
Estado de México

CONTACT US/APPELEZ

 **1-800-947-3744**

 **www.toastmaster.com**

 **consumer_relations@toastmaster.com**

PART NO. 33491P01

ESPECIFICACIONES TÉCNICAS

Potencia nominal (Watts)	1232 W
Tensión de alimentación o tensión nominal (Volts)	127 V ~
Frecuencia de operación o frecuencia nominal (Hertz)	60 Hz

Free Manuals Download Website

<http://myh66.com>

<http://usermanuals.us>

<http://www.somanuals.com>

<http://www.4manuals.cc>

<http://www.manual-lib.com>

<http://www.404manual.com>

<http://www.luxmanual.com>

<http://aubethermostatmanual.com>

Golf course search by state

<http://golfingnear.com>

Email search by domain

<http://emailbydomain.com>

Auto manuals search

<http://auto.somanuals.com>

TV manuals search

<http://tv.somanuals.com>