

MODEL MC1860

MCCULLOCH



Steam Vacuum

Top Innovations, Inc.

6655 Troost Ave.
Kansas City, MO 64131
Tel: (800) 711-6617
(816) 584-9700
www.steamfast.com
customerservice@topinnovations.com

Printed in China

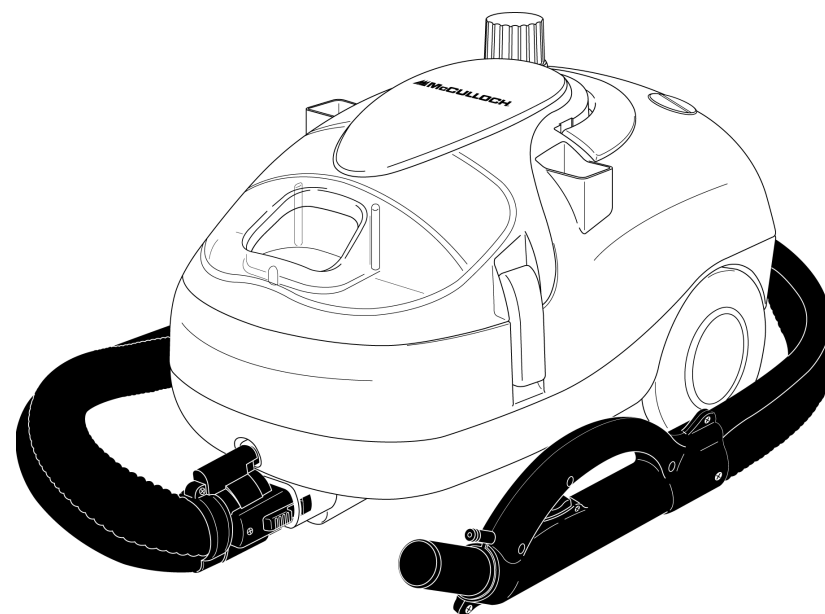

by Top Innovations, Inc.

PRODUCT SERIAL NUMBER

For your convenience, you may write down the serial number of your unit (located on the back or bottom of the unit) here for easy reference when contacting our Customer Service Department.

_____ - _____

**Please read all instructions before use.
Mail in your warranty registration card.**

V050817

Dear Valued Customer,

Congratulations on purchasing your new **MC1860 Steam Vacuum**. This exciting new product combines the natural cleaning ability of steam with a powerful vacuum to clean your workshop, tools and automobiles like never before!

The **Steam Vacuum** offers three modes of cleaning. Use hot penetrating steam to blast away dirt and grime naturally, with no need for harmful chemicals. Or, use the powerful vacuum function to clean floor mats, workbenches and more. Finally, combine the two modes for a potent cleaning combination - use steam to loosen dirt and materials while simultaneously removing them with the vacuum. This powerful versatility, along with other features such as a unique water-filtration system, a convenient carry handle, a variety of sturdy and useful accessories and much more, ensures that the **Steam Vacuum** will quickly become your number one solution for making your home cleaning experience faster and more effective.

Top Innovations, Inc. would like to invite you to visit our Customer Support Web site at:

www.topinnovations.com

On this Web site you will find additional information about many other exciting products that are available, helpful tips on ways in which you can utilize your **Steam Vacuum**, and other useful information to assist you in maximizing the power of steam!

Enjoy your new **MC1860 Steam Vacuum**!



Benny Lee
Chairman and CEO
Top Innovations, Inc.

ONE YEAR LIMITED WARRANTY

(If outside USA, additional shipping charges may apply)

Top Innovations, Inc. warrants this product to be free from defects in material and workmanship for a period of one (1) year from the date of purchase. This warranty does not cover damage caused by misuse, negligence, use by improper current or voltage, commercial use, use contrary to operating instructions or disassembly, repair or alteration by any person other than Top Innovations, Inc. Warranty Service Department.

Top Innovations, Inc. will repair or replace, at its option. This warranty gives you specific legal rights and may have other rights, which may vary from state to state.

Performance of any obligation under this warranty may be obtained by:

1. Call (800) 711-6617 for Return Authorization Number before returning for repair. Failure to obtain a Return Authorization Number will cause a delay in warranty and out-of-warranty service requests.
2. Include copy of purchase or gift receipt.
3. Include your name, address, telephone number, and Return Authorization Number on returned package.

Please send product postage-prepaid to:

**TOP INNOVATIONS, INC.
WARRANTY SERVICE DEPARTMENT
6655 TROOST AVE.
KANSAS CITY, MO 64131**

Should there be any missing or defective parts or accessories, please contact Customer Support. In most cases, it is not necessary to return the entire unit. We can ship most parts directly to your door.

Upon expiration of 1 year limited warranty, you will be advised of the cost of repair before any servicing is done, unless you enclose a note indicating that you would like us to proceed with repairs.

If you need to request warranty service, or have any questions about coverage under this warranty, please visit the Warranty Service Request page on our Web site **www.topinnovations.com**. You may also contact the Warranty Service Department by telephone at (800) 711-6617 or (816) 584-9700, or e-mail **customerservice@topinnovations.com**.

Please have your product serial number ready before contacting Warranty Service Department. The serial number is located on the back or bottom of your unit.

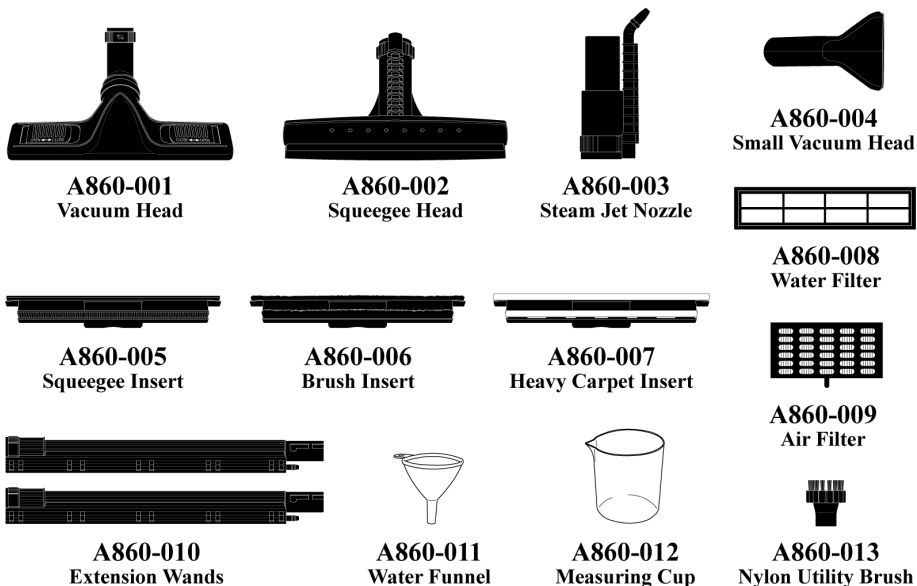

ONLINE ORDERING
To order replacement accessories online, visit our Web site:
www.topinnovations.com
Once there, click on Products at the top of the screen, then click on Accessories in the left side column. Then simply fill out the online forms and we will ship your accessories to you as soon as we process your order.

TELEPHONE ORDERING
To order replacement accessories by telephone, call toll-free:
1-800-711-6617 or (816) 584-9700 (local)
Our Customer Service representatives will be available to take your order during standard business hours (8 a.m. - 5 p.m. Central Time), Monday through Friday.

CUSTOMER SUPPORT
For problems with your Steam Vacuum, please refer to the Troubleshooting Guide located on page 13 of this manual. Additional inquiries should be directed to our Customer Service department through our Web site, www.topinnovations.com, on the Service Request Web page.
If you do not have internet access, you may also contact our Customer Service department by telephone, at (800) 711-6617 or (816) 584-9700.
NOTE: In order for our customer service representatives to help you as quickly and efficiently as possible, please have the following information ready before calling:
- Purchase information (where and when you purchased this product)
- Product Serial Number

IMPORTANT SAFEGUARDS



WARNING: To reduce the risk of fire, electrical shock, or injury, the following basic safety precautions should always be followed when using an electrical appliance.

READ ALL INSTRUCTIONS BEFORE USING YOUR FABRIC STEAMER

1. **DO NOT fill unit with more than 20 oz. of water.** Overfilling may result in burns from spilling water, or possible electrical shock.
2. **DO NOT leave your MC1860 Steam Vacuum unattended when plugged in or not in use.** Use only for its intended purpose as indicated in this manual.
3. **⚠ This unit is not a toy. Close supervision is required when using unit near children, pets, and plants. Steam produced by unit is hot and pressurized. Care must be taken to avoid burns or other injuries. Never point nozzle at people or pets.**
4. To reduce the risk of contact with hot water emitting from steam nozzle, hold nozzle away from body and check for signs of condensation or leakage.
5. **DO NOT use this unit if electrical cord or outlet is damaged. DO NOT use unit if it is not working properly or has been dropped, damaged or left outdoors.** If such damage occurs, **DO NOT disassemble or attempt repairs - take unit to a qualified service person for examination and repair.** Incorrect reassembly or repair could cause a risk of fire, electrical shock, or injury to persons when steamer is used.
6. To reduce risk of electrical shock, **DO NOT immerse in water or other liquids. DO NOT use electrical cord or hose as a handle. DO NOT allow cord or hose to be crimped by closing it in doors. DO NOT pull or stretch hose or cord around sharp corners or edges.**
7. Do not allow cord to touch hot surfaces. Let appliance cool for 30 minutes before putting away. Loop cord loosely around appliance when storing.
8. **DO NOT use this unit with extension cords or electrical outlets that have inadequate current capacity. A three-prong outlet or a properly grounded adapter is necessary when using MC1860 Steam Vacuum.**
9. In order to unplug MC1860 Steam Vacuum, grasp plug and pull smoothly and firmly from outlet. **DO NOT attempt to unplug unit by pulling or tugging on cord.**

SAVE THESE INSTRUCTIONS!
FOR HOUSEHOLD USE ONLY



WARNING: To reduce the risk of electric shock, this appliance has a three-pronged plug. This plug will fit in a polarized wall outlet only one way. If the plug does not fit fully in the outlet, contact a licensed electrician to install a proper outlet. **DO NOT** attempt to modify the plug or defeat this safety feature.

10. MC1860 Steam Vacuum is only meant to collect small amounts of moisture, such as that produced during the steaming process. **DO NOT** use it to vacuum wet surfaces, or any volume of liquid.
11. Burns could occur from touching hot metal parts, hot water or steam. Use care when you turn a steam appliance upside down - there may be hot water in water reservoir.
12. Steam hose may become hot during use. Use caution when handling to avoid burns or other injury.
13. MC1860 Steam Vacuum is only meant to be used with recommended MC1860 accessories. Other types of attachments are not to be used with Steam Vacuum. Doing so may cause injuries or damage to unit.
14. Nozzle and attachments become hot during use. To avoid injuries, **DO NOT** touch nozzle while using this appliance. **DO NOT** attempt to change attachments while unit is emitting steam.
15. When filling your Steam Vacuum with water, **DO NOT** fill water reservoir with more than 20 oz. of water. Only water should be used in unit. Other cleaning agents will damage unit and can cause injuries.
16. Always disconnect appliance from electrical outlet when filling with water or emptying, and when not in use.
17. **DO NOT** operate unit if steam opening is blocked. Should this occur, immediately cease usage and unplug from electrical outlet.
18. Store your MC1860 Steam Vacuum in a cool, dry place.

PROBLEM	POSSIBLE CAUSE	SOLUTION
Unit fails to operate.	Unit is not plugged in.	Plug into electrical outlet.
	Household Circuit Breaker / Ground Fault Interrupter has tripped or blown a fuse.	Reset Circuit Breaker / Ground Fault Interrupter, or replace fuse. If you need assistance, contact a licensed electrician.
Unit fails to steam, but Vacuum Mode functions correctly.	Water reservoir is empty.	Refill water reservoir using procedures on page 9 of this manual.
	Mineral build-up in unit.	Follow Removing Mineral Build-Up procedure on page 12 of this manual.
	Boiler has not yet completely heated.	Wait for the green steam ready light to illuminate before attempting to steam.
Steam output is intermittent.	Mineral build-up in unit.	It is normal for unit to periodically stop steaming for a few seconds. If steam stays off for longer periods, follow Removing Mineral Build-Up procedure on page 12 of this manual.
Unit is emitting excess water.	Water condensation in Hose.	Point Steam Nozzle towards sink, tub or ground and shake while depressing Steam Trigger. Continue until excess water is released.
Vacuum suction strength is weak or non-functional	Blockage in Hose.	Attempt to dislodge blockage if you can see it. If not, contact our Customer Service Department.
	Water Filtration Chamber is full / overflow lock has engaged.	Empty Water Filtration Chamber.

SAVE THESE INSTRUCTIONS!
FOR HOUSEHOLD USE ONLY

PROPER STORAGE

Preparing your Steam Vacuum for storage is quick and simple. When you have finished your cleaning tasks, follow the steps listed below.

1. Set Steam-Vac Switch and Main Control Switch to “Off” position and unplug power cord from electrical outlet.
2. Allow unit to cool for at least 30 minutes.
3. Remove all attachments from unit.
4. Remove and empty Water Filtration Chamber, then replace.
5. Drain any remaining water in water reservoir into a sink or tub to prevent over-filling during your next use.
6. Store attachments safely away, preferably near Steam Vacuum.
7. Store Steam Vacuum in a cool, dry location.

REMOVING MINERAL BUILD-UP

One common problem with steam appliances is mineral build-up caused by high mineral content in many municipal water supplies. **The best way to avoid this is to use de-mineralized or distilled water in unit.** If you are unable to use de-mineralized or distilled water, we recommend you use this procedure monthly to help avoid mineral build-up:

1. Switch Steam-Vac Switch and Main Control Switch to “Off” position and unplug power cord from electrical outlet. Allow unit to cool for at least 30 minutes.
2. Remove all attachments from unit.
3. Remove Water Reservoir Cap.
4. Drain water reservoir into sink or tub.
5. Using Measuring Cup, make a mixture of 5 oz. vinegar and 5 oz. water.
6. Slowly pour water-vinegar solution into water reservoir, using Water Funnel to prevent spilling water.
7. Allow to stand for 40 minutes.
8. Drain water-vinegar solution from water reservoir.
9. Rinse water reservoir with fresh water and drain until vinegar odor dissipates.
10. Replace Water Reservoir Cap.

REMOVING/REPLACING AIR FILTER

The MC1860 Steam Vacuum incorporates an air filter, in addition to the water filtration system. This air filter purifies the air that is released by the unit during vacuuming, helping to make the air in your home cleaner and safer to breath. After several uses, we recommend removing and cleaning this filter to keep it functioning optimally. Also, we recommend replacing the filter with a new one after approximately 6 months of regular use.

To remove the air filter, grasp the small tab on the bottom of the filter faceplate, pull outward, and the faceplate will release. You can now clean the filter on the back side of the faceplate, as well as the sponge filter inside of air filtration outlet. Rinse with warm water, and allow to air-dry completely before placing back into unit.

For information on obtaining replacement air filters, refer to page 14 of this manual.

The following features and accessories are included with your Steam Vacuum. Carefully inspect packaging material as some parts are shipped inside Styrofoam packaging. To obtain possible missing parts, refer to the **Customer Support** section on page 14 of this manual.

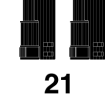
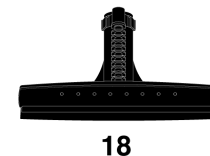
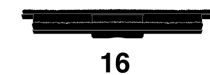
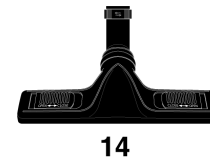
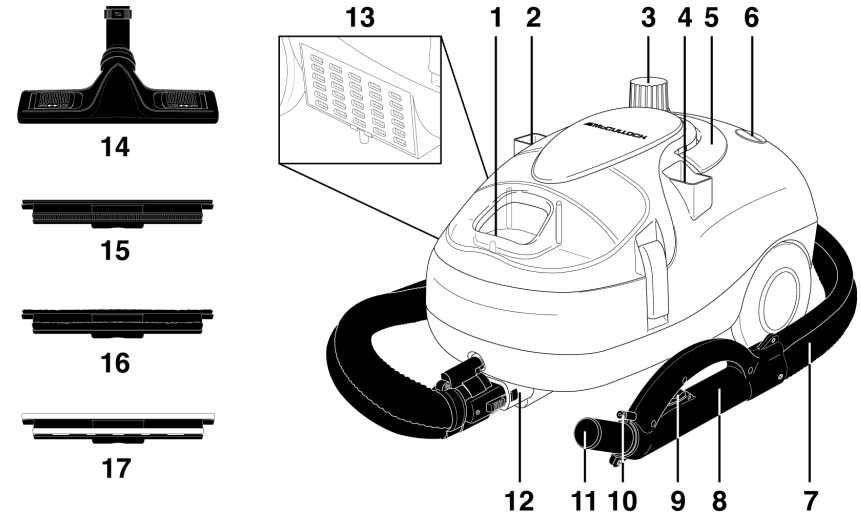

UNIT FEATURES & ACCESSORIES	
1.	Water Filtration Chamber
2.	Steam-Vac Switch
3.	Water Reservoir Cap
4.	Main Control Switch
5.	Carry Handle
6.	Steam Ready Indicator
7.	Hose
8.	Handle
9.	Steam Trigger
10.	Steam Nozzle
11.	Vacuum Nozzle
12.	Hose Connection Base
13.	Air Filter
14.	Vacuum Head
15.	Squeegee Insert
16.	Brush Insert
17.	Heavy Carpet Insert
18.	Squeegee Head
19.	Steam Jet Nozzle
20.	Small Vacuum Head
21.	Extension Wands
22.	Nylon Utility Brush
23.	Water Funnel
24.	Measuring Cup

- The *Water Filtration Chamber* (1) is where dirt and other vacuumed materials are collected. A minimum of 10 oz. of water should be poured into the *Water Filtration Chamber* in order to collect dust and other small particles that are picked up by the unit, preventing them from being released back into the air.
- The *Steam-Vac Switch* (2) is switched on in order to allow the unit to emit steam while simultaneously vacuuming.
- The *Water Reservoir Cap* (3) must be removed in order to pour water into the water reservoir. The *Water Reservoir Cap* includes a safety feature that will vent steam if pressure in boiler becomes too great.
- The *Main Control Switch* (4) is used to turn the unit off, as well as toggle between the unit's vacuum mode and steam mode. Steam mode uses the *Steam Indicator* (6) to indicate when the unit's boiler is on and when it is ready to begin steaming.
- The *Carry Handle* (5) is useful for carrying the unit up stairs and over obstacles.
- The *Hose* (7) is the conduit through which vacuumed materials travel to the *Water Filtration Chamber*. It also safely channels the flow of steam from the unit's boiler to the *Steam Nozzle*.
- The *Handle* (8) is designed to stay cool while providing the optimum amount of safety and user comfort.
- The *Steam Trigger* (9) is depressed in order to release a spray of steam from the *Steam Nozzle*.
- The *Steam Nozzle* (10) releases a spray of hot, penetrating steam when the *Steam Trigger* is pressed. The unit must be set to steam mode or steam-vac mode in order for the *Steam Nozzle* to function.
- The *Vacuum Nozzle* (11) uses suction to collect dirt and other materials. The unit must be set to vacuum mode or steam-vac mode in order for the *Vacuum Nozzle* to function.
- The *Hose Connection Base* (12) is the point at which the *Hose* connects to the main unit.
- The *Air Filter* (13) works to purify the air that is released by the unit during the vacuuming process, making the air in your home cleaner and safer to breathe.
- The *Vacuum Head* (14) serves multiple functions, depending on which insert is used with it. The *Squeegee Insert* (15) allows you to clean mirrors, windows and other hard surfaces while simultaneously vacuuming loosened materials. The *Brush Insert* (16) is useful for vacuuming carpet, tile or hardwood floors. The *Heavy Carpet Insert* (17) is used to more easily vacuum very thick, plush carpeting.
- The *Squeegee Head* (18) is useful for cleaning mirrors, windows and other hard surfaces.
- The *Steam Jet Nozzle* (19) connects to the *Vacuum/Steam Nozzles* and serves to focus the spray of steam for cleaning tough spots and stains.
- The *Small Vacuum Head* (20) connects to the *Vacuum Nozzle* and is useful for vacuuming in small corners or crevices that may be otherwise difficult to reach.
- The *Extension Wands* (21) connect to the *Vacuum/Steam Nozzles*, allowing easy cleaning of floors and other hard-to-reach places.
- The *Nylon Utility Brush* (22) connects to the *Steam Jet Nozzle*, and is useful for working stains out of fabrics and carpet.
- The *Water Funnel* (23) and *Measuring Cup* (24) are provided to assist you in easily and consistently filling the *Water Reservoir* with the optimum amount of water (20 oz.).

STEAM MODE

1. When set to steam mode, boiler light (amber) on Steam Indicator will light. This simply shows that the boiler is on and heating.
2. After approximately 6 1/2 minutes, steam ready light (green) on Steam Indicator will light. This indicates that you are ready to begin steaming.

NOTE: During use the steam ready light may intermittently turn off as steam pressure in the boiler builds back up. You may continue to steam during this time.

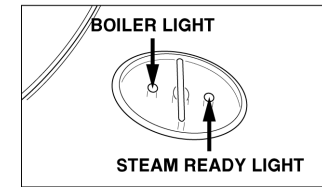

FIGURE 9

3. Direct Steam Nozzle towards surface you wish to steam, and press Steam Trigger. Steam Nozzle will emit a spray of steam for as long as you hold Steam Trigger.

CAUTION: Always be sure that Steam Nozzle and any attachments are pointed in a safe direction (away from yourself, other people, pets, and plants) before pressing Steam Trigger.

4. Using a slight back-and-forth motion over the area you are steaming will further enhance the cleaning process. Wipe steamed areas with a clean cloth to remove loosened dirt and grime. Wiping the area while it is still wet is recommended, but use caution when wiping surfaces such as metal that may still be hot.

STEAM-VAC MODE

1. Set Main Control Switch to vacuum mode, then set Steam-Vac Switch to "On" position. Steam-Vac Switch will illuminate to indicate steam-vac mode is active.
2. Allow boiler approximately 6 1/2 minutes to heat.

NOTE: Steam Indicator will not illuminate at all during Steam-Vac mode. Track the heating time manually, then press Steam Trigger to see if Steam Nozzle begins emitting steam.

3. Once boiler is heated, you may press Steam Trigger at any time to emit a burst of steam while vacuuming. Steam will not be as powerful as during steam mode; it is meant only to freshen surfaces and weaken small stains while you vacuum.

NOTE: It is recommended that for very stubborn stains, you use steam mode to loosen materials before switching to steam-vac mode, as steam is more powerful in steam mode.

Once cleaning tasks are complete, refer to page 12 of this manual and follow steps under **Proper Storage** procedure to clean and store your MC1860 Steam Vacuum.

OPERATING STEAM VACUUM

NOTE: Be sure that water reservoir and Water Filtration Chamber have already been filled and that all desired accessories are connected before following these steps.

1. Plug power cord into a convenient electrical outlet (make sure to first remove plastic cover that protects plugs during shipping).

CAUTION: This unit uses a grounded (3-prong) electrical plug. Use only in properly installed 3-prong electrical outlets. Do not attempt to alter plug or circumvent this safety feature in any way.

2. Set Main Control Switch to desired mode (vacuum mode or steam mode) (FIGURE 7).

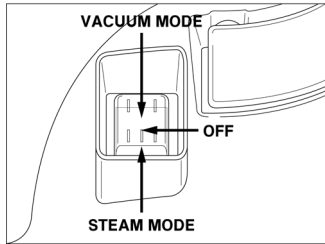

FIGURE 7

VACUUM MODE

1. When set to vacuum mode, unit suction will begin automatically. You are immediately ready to begin your vacuuming tasks.
2. While vacuuming, it is possible to alter the force of suction, by using switch on top of Handle. Move it forward to increase suction power, and move it backwards to decrease suction power. This is useful for when vacuuming rugs or other materials on which you may not want to use maximum.
3. As you vacuum, it may become necessary to stop and empty Water Filtration Chamber. Simply follow these steps:
 - Unhook locks and remove Water Filtration Chamber cover,
 - Remove Water Filtration Chamber (there are no locks holding it in place; simply pull it out),
 - Remove filter
 - Empty Water Filtration Chamber into toilet (for dirty water) or trash can
 - Replace filter and refill Water Filtration Chamber with water (10 oz.)
 - Set Water Filtration Chamber back in place
 - Replace Water Filtration Chamber cover and re-latch locks

NOTE: It is recommended that you remove and clean filter in Water Filtration Chamber after several uses. Simply remove it and rinse thoroughly with warm water, then replace it. After approximately 6 months of regular use, you may wish to replace this filter to maintain optimum filtration. Refer to page 14 of this manual for information on obtaining replacement filters.

CONNECTING / DISCONNECTING HOSE

1. Align connector end of Hose with Hose Connection Base as shown (FIGURE 1), and insert it. Press in until two locking tabs on Hose snap through two holes on sides of Hose Connection Base.
2. To remove Hose from Hose Connection Base, press in on two locking tabs and firmly pull Hose out of Hose Connection Base.

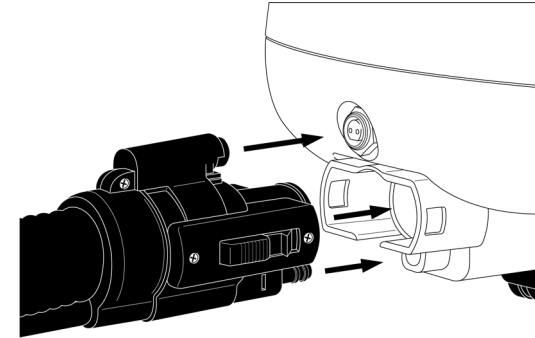

FIGURE 1

CONNECTING ATTACHMENTS TO VACUUM / STEAM NOZZLES

1. Slide Open/Close lock on Squeegee Head, Steam Jet Nozzle or Vacuum Head to "Open" position.
2. Align Squeegee Head, Steam Jet Nozzle, Vacuum Head or Small Vacuum Head with Vacuum/Steam Nozzles as shown (FIGURE 2), and press firmly onto Vacuum/Steam Nozzles. Note that Small Vacuum Head only fits onto Vacuum Nozzle, and does not have an Open/Close lock.
3. Slide Open/Close lock on Squeegee Head, Steam Jet Nozzle or Vacuum Head to "Close" position.

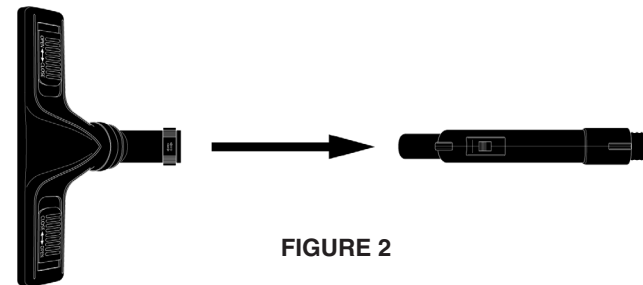

FIGURE 2

CONNECTING OTHER ATTACHMENTS

INSERTS

1. Slide two locks on top of Vacuum Head to “Open” position (FIGURE 3-A).
2. Select desired insert, and place it into Vacuum Head as shown (FIGURE 3-B).
3. While continuing to press insert firmly into Vacuum Head, slide both locks to “Close” position to lock insert securely into place.

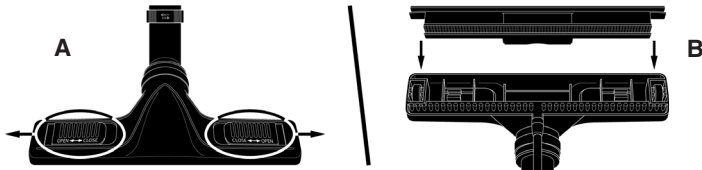

FIGURE 3

NYLON UTILITY BRUSH

1. Slide Nylon Utility Brush onto Steam Jet Nozzle as shown (FIGURE 4). Firmly press it on until it fits securely in place.

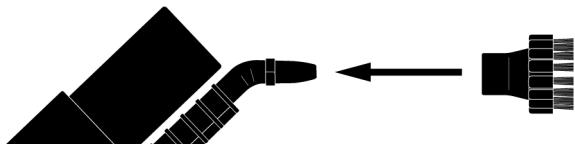

FIGURE 4

EXTENSION WANDS

1. Slide Open/Close lock on Extension Wand to “Open” position. Align Extension Wand with Vacuum/Steam Nozzles, and firmly press it on. Slide Open/Close lock to “Close” position.
2. Repeat Step 1 for second Extension Wand, connecting it to the end of first Extension Wand.
3. Select desired attachment (Squeegee Head, Steam Jet Nozzle, Vacuum Head or Small Vacuum Head), and connect it to end of second Extension Wand in the same way as you would connect it to Vacuum/Steam Nozzles (refer to **Connecting Attachments to Vacuum/Steam Nozzles** section on page 7 of this manual).

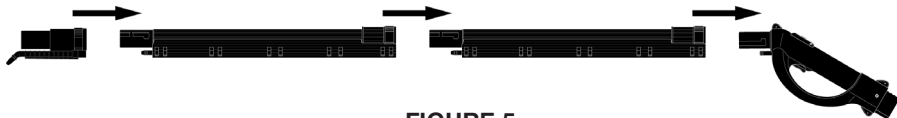

FIGURE 5

FILLING WATER RESERVOIR WITH WATER

1. Place Steam Vacuum on a flat, level surface.
2. Make sure Main Control Switch is set to “Off” (0) position and power cord is unplugged from electrical outlet.
3. Press and hold Steam Trigger to ensure that any remaining steam has been emitted from unit.
4. If unit has been in use, allow at least 30 minutes for boiler to cool.
5. Cautiously unscrew and remove Water Reservoir Cap.
6. Water reservoir should always be emptied after each use. If it was not emptied after the last use, empty it now. This will prevent over-filling.
7. Fill Measuring Cup to maximum fill line (10 oz.) with water.

NOTE: To prolong the lifetime of your Steam Vacuum, we recommend using distilled or de-mineralized water.

8. Carefully pour water from Measuring Cup into water reservoir through fill hole, using Water Funnel to prevent spilling water.

WARNING: Extreme caution should be used when pouring water into the water reservoir. Do not look directly down into fill hole when filling. Keep your free hand and any children or pets at a safe distance.

9. Repeat steps 7 & 8 in order to have 20 oz. of water in water reservoir.
10. Replace Water Reservoir Cap, ensuring that it is screwed on tightly to prevent hot steam from escaping and causing injury.

FILLING WATER FILTRATION CHAMBER WITH WATER

1. Place Steam Vacuum on a flat, level surface.
2. Make sure Main Control Switch is set to “Off” (0) position and power cord is unplugged from electrical outlet.
3. Unhook two locks that hold Water Filtration Chamber cover (FIGURE 6), and remove cover.
4. Fill Measuring Cup to maximum fill line (10 oz.) with water.
5. Carefully pour water from Measuring Cup into Water Filtration Chamber. It does not matter which side of the chamber water is poured into.
6. Replace Water Filtration Chamber cover, and re-latch two locks.

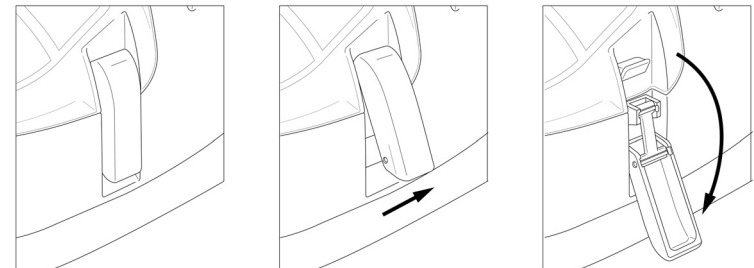

FIGURE 6

Free Manuals Download Website

<http://myh66.com>

<http://usermanuals.us>

<http://www.somanuals.com>

<http://www.4manuals.cc>

<http://www.manual-lib.com>

<http://www.404manual.com>

<http://www.luxmanual.com>

<http://aubethermostatmanual.com>

Golf course search by state

<http://golfingnear.com>

Email search by domain

<http://emailbydomain.com>

Auto manuals search

<http://auto.somanuals.com>

TV manuals search

<http://tv.somanuals.com>