

TOPCOM[®]

ORBIT



USER GUIDE
1.1



Before Initial use

Thank you for purchasing this new digital cordless telephone

Intended Purpose:

This product is intended to be connected indoor to a analogue telephone line. You have acquired a Orbit, which is a product made in accordance with the Digital Enhanced Cordless Telecommunications (DECT). DECT technology is characterized by high-security protection against interceptions as well as high-quality digital transmission. This telephone was designed for a wide range of applications. For example, this telephone can be used within a network of base units and handsets, constituting a telephone system which:

- Operates up to 5 handsets at one base unit.
- Allows an intercom between 2 handsets.
- Allows the operation of a handset at up to 4 base units.

Caller ID is a network provider service. After subscribing to Caller ID, this phone will display the caller's phone number.

Important

To use 'Caller ID' (display caller), this service has to be activated on your phone line. Normally you need a separate subscription from your telephone company to activate this function. If you don't have the Caller ID function on your phone line, the incoming telephone numbers will NOT be shown on the display of your telephone.

The CE symbol indicates that the unit complies with the essential requirements of the R&TTE directive.

The features described in this manual are published with reservation to modifications.

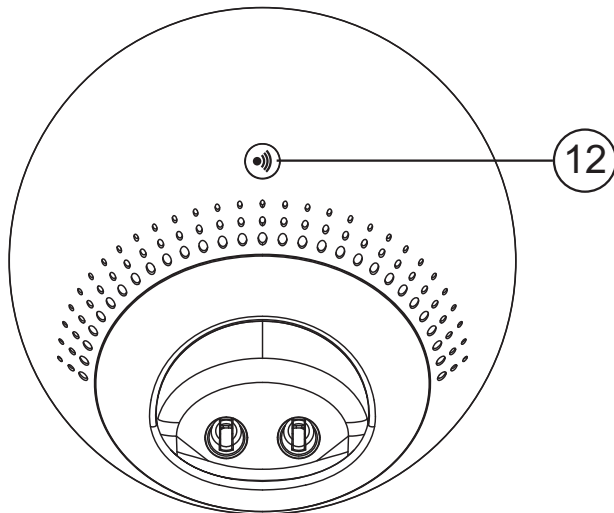
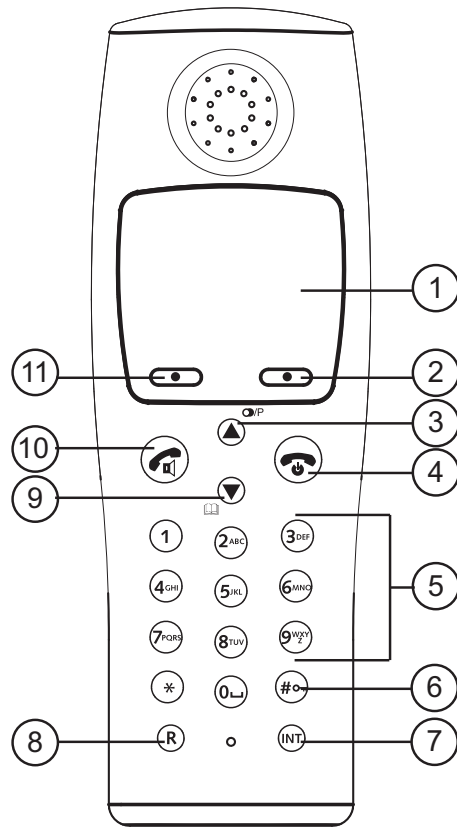

1	Safety advice	4
2	Getting started	5
2.1	How to use this user guide	5
2.2	Installing the base	5
2.3	Installing the handset	6
2.4	Wall mounting	7
2.5	Keys/Led	8
2.6	Symbols	9
2.7	Display keys	9
2.8	Navigating the menu	9
2.9	Menu overview	10
3	Using the telephone	10
3.1	Switching the handset ON/OFF	10
3.2	Changing the menu language	10
3.3	Setting the date and time	11
3.4	Setting the time format	11
3.5	Making a normal telephone call	11
3.6	Receiving a telephone call	12
3.7	Handsfree mode	12
3.8	Adjust earpiece/handsfree volume	12
3.9	Secrecy function (Mute function)	13
3.10	Locating a handset (Paging function)	13
3.11	Keypad Lock	13
3.12	Using the alphanumerical keypad	13
4	Phonebook	13
4.1	To access and search in the phonebook	13
4.2	To add an entry	14
4.3	To dial an entry	14
4.4	Show Details	14
4.5	Delete an entry	14
4.6	Delete all entries	14
4.7	Edit Entry	15
4.8	Copy a phonebook entry or all entries to another handset	15
4.9	Memory status	16
4.10	Change the ringtone	16
5	Caller Identification	16
5.1	Call Waiting	16
6	Calls List	17
6.1	New calls Alert	17
6.2	To view new missed calls	17
6.3	View and dial from the Calls list	17
6.4	Copy a Calls list number into the phonebook	17
6.5	Send a text message to a Calls list number	18
6.6	Delete an entry	18
6.7	Delete all entries	18

7	Personalise the handset	18
7.1	Ringtone and volume	18
7.2	Handset name	19
7.3	Keypad beeps	19
7.4	Wallpaper	19
7.5	Menu color	20
7.6	Setting the contrast	20
7.7	Setting the light timeout	20
7.8	Setting the screensaver	20
7.9	Autotalk	20
7.10	PABX Access code	21
7.11	Redial length	21
7.12	Receiving Volume	21
7.13	Using the alarm feature	21
8	Base settings	22
8.1	Ringtone	22
8.2	Ringer Volume	22
8.3	Dial Mode	23
8.4	Recall (Flash)	23
8.5	System PIN	23
8.6	Ring Priority	24
8.7	First ring On/Off	24
9	Factory Reset	24
10	Agenda	25
11	SMS	26
11.1	How to write an SMS	26
11.2	Sending an SMS	26
11.3	Read and view the list of received messages (Inbox)	27
11.4	Reading and sending the saved message (Draft folder)	28
11.5	Using the outbox	28
11.6	Template messages	28
11.7	Delete messages	29
11.8	SMS Settings	29
11.9	User Areas	30
12	Additional handsets and base stations	32
12.1	Adding a new handset	32
12.2	Removing a handset	32
12.3	Select a base	32
12.4	Using the intercom feature	33
13	Troubleshooting	34
14	Technical data	34
15	Warranty	35
15.1	Warranty period	35
15.2	Warranty handling	35
15.3	Warranty exclusions	35
16	Disposal of the device (environment)	35
17	Cleaning	35

1 Safety advice

The following safety advice must always be followed before using electrical equipment. Please read carefully through the following information concerning safety and proper use. Make yourself familiar with all the functions of the equipment. Be careful to keep these advice notes and if necessary pass them on to a third party.

Electrical safety and protection:

- Do not operate the equipment if the mains plug, cable or the equipment itself is damaged.
- If the equipment is dropped, then it must be checked by an electrician before further use.
- Dangerous voltages are present inside the equipment. Never open the housing or insert objects through the ventilation holes.
- Do not allow liquids to get into the equipment. In case of emergency, pull out the plug from the socket.
- Similarly, if a fault develops during use or before you start to clean the equipment, pull the plug out if the socket.
- Do not touch the charger and plug contacts with sharp or metal objects.
- Do not carry out any modifications or repairs to the equipment yourself. Have repairs done to the equipment or the mains cable only by a specialist service centre. Unsatisfactory repairs can lead to considerable danger for the user.
- Children frequently underestimate the dangers associated with electrical equipment. Therefore you must never leave children unsupervised in the vicinity of electrical equipment.
- The equipment is not to be used in a damp room (e.g. bathrooms) or rooms where there is a lot of dust.
- Equipment connected to the mains during a thunderstorm can be damaged by lightning. Therefore you should pull the plug out of the mains socket during a storm.
- To completely disconnect the equipment from the electricity supply, the plug must be removed from the socket. When doing this always pull on the plug itself and never on the cable.
- Protect the mains cable from hot surfaces or other sources of damage and do not allow it to become constrained.
- Check the mains cable regularly for any damage.
- Unwind the mains cable completely before use.
- Make sure that the mains cable does not represent a trip hazard.
- The operation of some medical devices may be affected.
- The handset may cause an unpleasant buzzing sound in hearing aids.

Fire safety:

- The heat accumulated inside the equipment can lead to the defect and/or to the fire of the equipment. Do not expose this equipment therefore to extreme temperature like:
 1. direct sun exposure and heater warmth
 2. ventilation holes may not be covered

Danger of explosion:

- Never throw batteries in fire.

Poisoning danger:

- Keep batteries away from small children.

Note:

- Only use the charger plug supplied. Do not use other chargers, as this may damage the batteries cells.
- The wall outlet for the power supply must be close and accessible.
- Only use rechargeable batteries of the same type. Place the batteries with correct polarity inside the battery compartment (polarity is marked inside the handset). Never use normal un rechargeable batteries!



As this telephone cannot be used in case of a power cut, you should use a mains-independent telephone for emergency calls, e.g. a mobile phone.

2 Getting started

2.1 How to use this user guide

In this user guide, following method is used to clarify the instructions:



Text....."display".



Text that appears on the display of the phone

Key to press. This key can be a soft key. When the soft key is a symbol, it is shown in the left column. When the soft key is text, the left or right soft key is shown in the left column and the text is shown in the right column between quotation marks.

2.2 Installing the base

For installation, do the following:

- 1 Plug one end of the adaptor into the outlet and the other end into the adaptor jack on the bottom of the base.
- 2 Connect one end of the telephone cord with the wall phone jack and the other end to the bottom of the base.
- 3 Put the telephone- and AC power line cord in the base guides as shown on picture 2A.

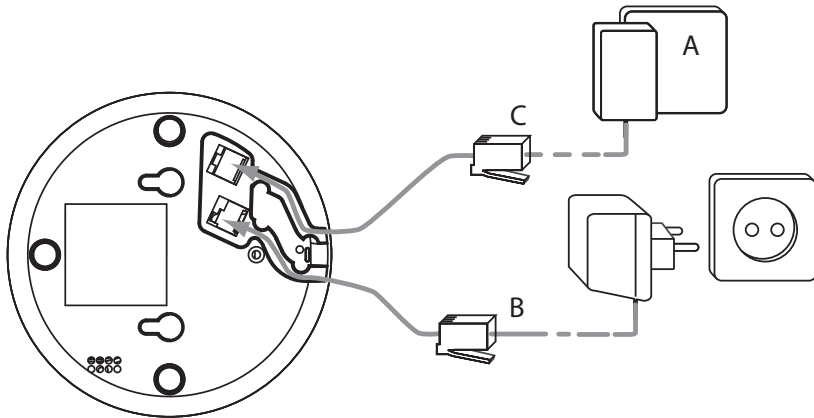

- 2A Back view of base -

- A. Telephone wall outlet
- B. Power cable
- C. Telephone cord

2.3 Installing the handset

- 1 Open the battery compartment as shown on picture 2B.
- 2 Insert the batteries respecting the polarity (+ and -).
- 3 Close the battery compartment.
- 4 Leave the handset on the base unit for 20 hours.

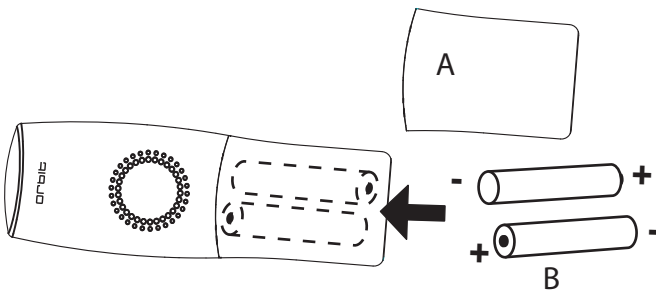

- 2B Back view of handset -

- A. Cover
- B. Rechargeable batteries



Before you use the telephone for the first time, you must first make sure the battery is charged for 20 hours. If you do not do this, the telephone will not work optimally.

2.4 Wall mounting

You can hang the base against the wall by turning the cradle inside the base as shown below:

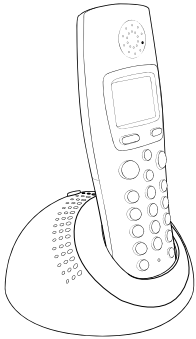

Desk Mode

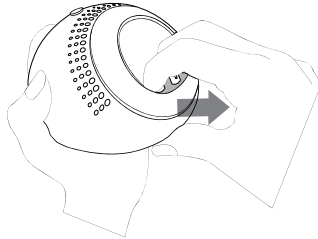

1. Lift Cradle

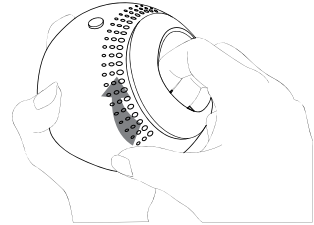

2. Rotate 180° Clockwise

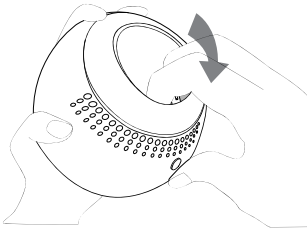

3. Release in Position

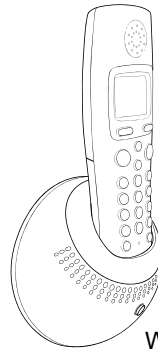

Wall Mount Mode

- 2C Wall mounting -

Use the template at the back side of the manual to drill the holes in the wall 5 cm apart horizontally.

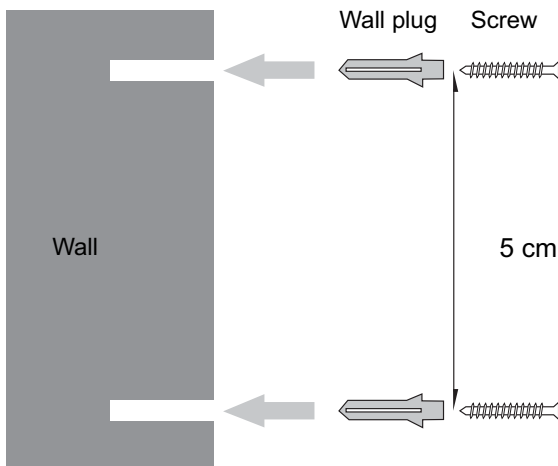

- 2D Wall mounting -

2.5 Keys/Led

Handset

1. Display
2. Right soft menu key
3. Up / Redial / Pause key
4. On-hook / ON-OFF key
5. Alphanumeric keys
6. Keypad lock
7. INT key
8. Flash key
9. Down / Phonebook key
10. Off-hook / Handsfree key
11. Left soft menu key

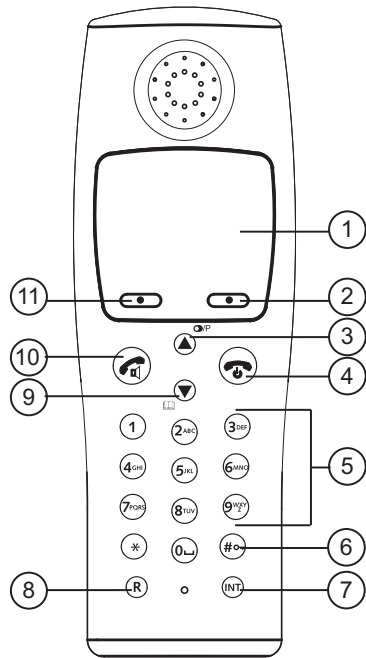

- 2E Handset -





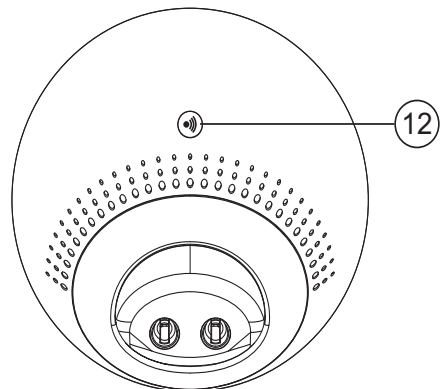







Base

12. Paging key



- 2F Base -

2.6 Symbols

	Keypad lock		Handset within base range (Flashes if you are out of range)
	Alarm set		Handsfree
	Handset ringer volume is off		Battery full
	You have SMS messages		Battery medium
	You have missed calls		Battery low
	You have new voice mail		Battery is almost discharged

2.7 Display keys

Display-keys (softkeys) are located directly under the display. The function of these 2 keys changes depending on the operation mode. The actual function is displayed as icon or text directly above the 2 display keys.

2.8 Navigating the menu

The Orbit has a menu system which is easy to use. Each menu leads to a list of options. The menu map is shown on the following paragraph.



- 1 When the handset is switched on and in standby, press the left soft menu key (Key 11 - Picture 2E) "Menu" to open the main menu.
- 2 Scroll to the desired menu option.
- 3 Press the soft menu key to view further options or to confirm the setting displayed.







To exit or to go back one level in the menu



To go to the previous level in the menu, press the soft menu key "Back".

To cancel and return to standby at any time, press the on-hook key.

2.9 Menu overview

	Menu	Submenu items
	Text Messaging	Write Message Inbox Drafts Outbox Templates Delete messages Text Settings
	Calls Lists	Missed Calls Received Calls Dialled Calls Delete Calls
	Agenda	Add Event (when there are no Events)
	Clock & Alarm	Date & Time Alarm Time Format
	Settings	Set Handset Set Base
	Registration	Register Handset Select Base De-register

3 Using the telephone

3.1 Switching the handset ON/OFF



- 1 Press and hold the On-Off key to switch the handset off.
- 2 Press the On-Off key or place the handset in the base to switch the handset back on.

3.2 Changing the menu language



- 1 Enter the menu.
- 2 Select "Settings" and confirm.
- 3 Select "Set Handset" and confirm.
- 4 Select "Language" and confirm.
- 5 Select a language and confirm.
The screen displays "Saved".
- 6 Press the on-hook key to return to standby.



The  or  arrows indicate that further options are available in the menu.

3.3 Setting the date and time



- The date and time is kept inside the base and send to all handsets, so you only have to set the date/time ones when using more then one handset.
- The date/time can be set by the Caller ID (Clip) information, or manually as mentioned below.



- 1** Enter the menu.
- 2** Select "Clock & Alarm" and confirm.
- 3** Select "Date & Time" and confirm.
- 4** Enter day, month, year, time and minutes and select "Save" to confirm.
- 5** Press "Back" to go to the previous menu.

3.4 Setting the time format



The time format can be set differently for each handset.



- 1** Enter the menu.
- 2** Select "Clock & Alarm" and confirm.
- 3** Select "Time Format" and confirm.
- 4** Select "12 Hour" or "24 Hour" and confirm.
- 5** Press "Back" to go to the previous menu.

3.5 Making a normal telephone call

Direct dialling



- 1** Press the off-hook key to start the call.
- 2** Dial the telephone number.
- 3** Press the on-hook key to hang up or put the handset back on the base.

Pre-dialling

With the pre-dialling feature, you can enter and modify a number before making the call.



- 1** Dial a number of up to 32 digits.
Press and hold the Pause-key to insert a pause. The screen displays a "P".
- 2** Press the soft menu key "Clear" to correct.
- 3** Press the off-hook key to start the call or select "Options".
- 4** If you selected "Options", scroll and select:
"Save": to store the number into the phonebook;
"Send Message": to send a message.
- 5** Press the on-hook key to hang up or put the handset back on the base.

Redial a number from the dialled call list

You can redial up to 20 of the last numbers called. If you have stored a name in the phonebook to go with the number, the name will be displayed instead.



- 1** Press the redial key.
- 2** Select a number. If the number is in the phonebook, the name will be shown.
- 3** Press the off-hook key to start the call or select "Options".
- 4** If you selected "Options", scroll and select:
 - "Show Details": To show the details;
 - "Save Number": to store the number into the phonebook;
 - "Send Message": to send a message;
 - "Delete Call": to remove the number from the call list.
- 5** Confirm selection.
- 6** Press the on-hook key to return to standby.



See also "7.11 Redial length".

3.6 Receiving a telephone call

When you receive an external call, the screen displays "External Call". To take the call:



- 1** Press the off-hook key.
OR
Lift the handset off its base if you have activated "Auto Talk".
(See "7.9 Autotalk")
The call duration is displayed after 15 seconds.



- 2** Press the on-hook key to hang up or put the handset back on the base.



You can turn the ring volume off during incoming call by selecting "Silence".

3.7 Handsfree mode

Handsfree lets you talk to your caller without holding the handset. It also enables other people in the room to listen to both sides of your conversation.



- 1** To switch any call to handsfree, press the handsfree key during the call.

3.8 Adjust earpiece/handsfree volume



- 1** Press up or down to select volume 1-8 during a normal or handsfree call.



You cannot set the earpiece/handsfree volume independently.

3.9 Secrecy function (Mute function)

To turn off the microphone so the person on the other side of the line will not hear you.



1 During a conversation, press the soft menu key “Secrecy” to deactivate the microphone.

“Secrecy On” appears on the display.



2 Select “Off” to activate the microphone again.

3.10 Locating a handset (Paging function)



1 Press the paging key on the base.

All handsets registered with the base will ring for 30 seconds.



2 Press “Stop” or any key on the handset to stop the paging.

3.11 Keypad Lock

To lock the keypad to prevent accidental dialling while carrying the handset around.



3 Press and hold the keypad locked key (key 6 - Picture 2E) until “Keypad Locked” and the keypad locked icon  appears on the display.



4 To unlock, select “Unlock”, followed by the keypad locked key #.

3.12 Using the alphanumerical keypad

With your telephone, you can also enter alphanumerical characters. This is useful for entering a name into the phonebook, giving a name to the handset, ...

To select a letter, press the corresponding key as many times as necessary.

For example, to select an ‘A’, press ‘2’ once. To select a ‘B’, press ‘2’ twice and so on.

To select ‘A’ and then ‘B’ consecutively, press ‘2’ once, wait until the cursor moves on to the next character, then press ‘2’ twice.

When names are entered, the first character is upper case and then the case switches to lower. You can manually change the case as below mentioned.



Press ‘0’ to select a space.



Press the #-key to switch between small letters, capitals or numeric input.



Press the soft menu key “Clear” to correct.

4 Phonebook

Each handset can store up to 250 names and numbers. Names can be up to 12 characters long and numbers up to 24 digits. You can also select different ring tones for each entry.

4.1 To access and search in the phonebook

There are two ways to access the name list of your phonebook:



1 Press the right soft menu key “Names” and select “Search”.
OR



2 Press the Down/Phonebook key.



3 Scroll to the name you want or enter the first characters of the name.



If the phonebook is empty "Phonebook Empty" will be shown shortly.

4.2 To add an entry



- 1** Press the right soft menu key "Names".
- 2** Select "Add Entry".
- 3** Use the keypad to enter the name, then select "OK".
- 4** Use the keypad to enter the number, then select "Save".
- 5** Select the desired ring melody and press "Select".
Select "Default melody" if you don't want to have another ring melody for this entry.
- 6** Return to standby.

4.3 To dial an entry



- 1** Press the Down/Phonebook key.
- 2** Select the desired name or use the keypad to enter the first letter of the name.
- 3** Press the off-hook key to start the call.
- 4** Return to standby.

4.4 Show Details



- 1** Press the Down/Phonebook key.
- 2** Select the desired name or use the keypad to enter the first letter of the name.
- 3** Select "Options".
- 4** Select "Show Details".
The name, number and ring melody you have assigned to the entry appear on the display.
- 5** Press "Dial" to dial out the number or "Back" to go back.
- 6** Return to standby.

4.5 Delete an entry













- 1** Press the Down/Phonebook key.
- 2** Select the desired name or use the keypad to enter the first letter of the name.
- 3** Select "Options".
- 4** Select "Delete Entry" and confirm.

4.6 Delete all entries



- 1** Press the right soft menu key "Names".
- 2** Select "Delete Phonebook" and confirm.

4.7 Edit Entry













- | | | |
|---|----------|--|
|  | 1 | Press the Down/Phonebook key. |
|  | 2 | Select the desired name or use the keypad to enter the first letter of the name. |
|  | 3 | Select "Options". |
|   | 4 | Select "Edit Entry" and confirm. |
|  | 5 | Press the soft menu key "Clear" to delete and use the keypad to change the name. |
|  | 6 | Select "OK". |
|  | 7 | Edit the number and select "Save". |
|   | 8 | Select the desired ring melody and press "Select". |
|  | 9 | Return to standby. |

4.8 Copy a phonebook entry or all entries to another handset







- The copy process can be interrupted when there is an incoming call.
- When other handset is not available (out of range) or memory is full, the display will show "Copy unsuccessful".
- When only one handset is registered, "Not available" will be shown for 2 seconds.

Copy an entry to another handset

- | | | |
|---|----------|---|
|  | 1 | Press the Down/Phonebook key. |
|  | 2 | Select the desired name or use the keypad to enter the first letter of the name. |
|  | 3 | Select "Options". |
|   | 4 | Select "Copy Entry". |
|   | 5 | Select "To Handset". |
|   | 6 | Select the desired handset and confirm.
"Please wait..." appears on the display.
"Copy phonebook?" appears on the display of the destination handset. |
|  | 7 | On the destination handset, press the left menu key to confirm or the right menu key to cancel the transfer. |
|  | 8 | Return to standby. |
|  | | |

Copy all phonebook entries to another handset

- | | | |
|---|----------|--|
|  | 1 | Press the right soft menu key "Names". |
|   | 2 | Select "Copy Phonebook". |
|   | 3 | Select "To Handset". |



The available handsets (all the handsets that are registered on the base) are shown.

4 Select the desired handset and confirm.

“Please wait...” appears on the display.

“Copy phonebook?” appears on the display of the destination handset.



5 On the destination handset, press the left menu key to confirm or the right menu key to cancel the transfer.

6 Return to standby.

4.9 Memory status



1 Press the right soft menu key “Names”.

2 Select “Copy Phonebook”.

3 Select “Memory Status”.

The amount of entries in the phonebook are shown + amount of free entries.



4 Return to standby.

4.10 Change the ringtone



1 Press the Down/Phonebook key.

2 Select the desired name or use the keypad to enter the first letter of the name.

3 Select “Options”.

4 Select “Ringtone”.

5 Select the desired ring melody and press “Select”.

6 Return to standby.

5 Caller Identification



This service only works when you have a Caller ID/Clip subscription. Please contact your telephone company.

When you receive a call from your fixed telephone line, the telephone number of the caller appears on the handset display. You can also see his or her name if it is transmitted by the network. If the name is programmed in the phonebook, the name in the phonebook is displayed!

5.1 Call Waiting



This service only works when you have Caller ID / Call Waiting subscription.

During a call, you hear a beep (knocking tone) when a second call comes in (through the earpiece). The number (or name) will be shown on the display. If no number/name is available the phone will show “Call Waiting”.

6 Calls List

Each handset can store 30 calls in the Call List (received and missed) that can be reviewed later.

Also the last 20 dialled calls are stored in the Call list. When the memory is full, the new calls automatically replace the oldest calls in the memory.

6.1 New calls Alert



0123456789

Missed calls are indicated by a text "You have xx new missed call(s)" or by an Icon on the idle screen.

New unanswered/Missed calls are shown in the list with a blue dot ● behind the telephone number or callers name.

6.2 To view new missed calls



1 Press the left soft menu key "View". Only the Missed/unanswered calls are shown in the Missed calls list.

OR



2 Press right soft menu key "Back" to view at a later stage.

6.3 View and dial from the Calls list



1 Enter the menu.



2 Select "Calls List".



3 Select "Missed Calls, Received Calls or Dialed Calls".



4 Scroll through the list and select "Options".



5 Select "Show Details" to see the callers number, date and time.



6 Select "Dial" to call the number.



7 Select "Back" to return to previous menu.

6.4 Copy a Calls list number into the phonebook



1 Enter the menu.



2 Select "Calls List".



3 Select "Missed Calls, Received Calls or Dialed Calls".



4 Scroll through the list and select "Options".



5 Select "Save Number".



6 Enter the name and press "Save" to confirm.

















7 Select the ringtone and press "Select".













8 Select "Back" to return to previous menu.









6.5 Send a text message to a Calls list number

- | | |
|---|---|
|  | 1 Enter the menu. |
|   | 2 Select "Calls List". |
|   | 3 Select "Missed Calls, Received Calls or Dialed Calls". |
|   | 4 Scroll through the list and select "Options". |
|   | 5 Select "Send Message". |
|   | 6 Enter the message and press "Options". |
|   | 7 Select "Send" (you can save, insert a symbol, emoticon or template). |
|  | 8 The number is pre-entered on the screen, press "Send" to send the message. |
|  | 9 Select "Back" to return to previous menu. |

6.6 Delete an entry

- | | |
|---|---|
|  | 1 Enter the menu. |
|   | 2 Select "Calls List". |
|   | 3 Select "Missed Calls, Received Calls or Dialed Calls". |
|   | 4 Scroll through the list and select "Options". |
|   | 5 Select "Delete Call". |
|  | 6 Select "Back" to return to previous menu. |

6.7 Delete all entries













- | | |
|---|--|
|  | 1 Enter the menu. |
|   | 2 Select "Calls List". |
|   | 3 Select "Delete Calls". |
|   | 4 Scroll through the list and select "Missed Calls", "Received Calls", "Dialed Calls" or "All Calls". |
|  | 5 Select "Yes" to confirm or "No" to cancel. |
|  | 6 Select "Back" to return to previous menu. |

7 Personalise the handset

7.1 Ringtone and volume

Ringtone

You can choose from 10 different ringer melodies for internal and external calls.

- | | |
|---|---|
|  | 1 Enter the menu. |
|   | 2 Select "Settings". |
|   | 3 Select "Set Handset". |
|   | 4 Select "Ringtone". |
|   | 5 Select "External Call" for external calls or select "Internal Calls" for internal calls and confirm. |
|   | 6 Select the desired melody and confirm.
During scrolling the melody is played. |
|  | 7 Return to standby. |

Ringer volume

You can choose from 5 handset ringer volume levels and off.



- 1** Enter the menu.
- 2** Select "Settings".
- 3** Select "Set Handset".
- 4** Select "Ringer volume".

The current setting is displayed.

- 5** Press the up key to increase the volume.
- 6** Press the down key to decrease the volume.
- 7** Select "Save" to confirm.
- 8** Return to standby.



When you change the ringing volume to "Off", the idle screen will show the ringer Off  icon.

7.2 Handset name

You can change the name displayed on the handset during standby (max. 10 characters).



- 1** Enter the menu.
- 2** Select "Settings".
- 3** Select "Set Handset".
- 4** Select "Handset name".
- 5** Enter the name you want.
- 6** Press the soft menu key "Clear" to correct.
- 7** Select "Save" to confirm.
- 8** Return to standby.

7.3 Keypad beeps



- 1** Enter the menu.
- 2** Select "Settings".
- 3** Select "Set Handset".
- 4** Select "Key Beep".
- 5** Select "On" or "Off".
- 6** Return to standby.





7.4 Wallpaper

You can choose from 3 different wallpaper pictures which appear in the background during standby.













- 1** Enter the menu.
 - 2** Select "Settings".
 - 3** Select "Set Handset".
 - 4** Select "Wallpaper".
 - 5** Select the picture you want and confirm.
- During scrolling press "View" to show the picture.
- 6** Return to standby.











7.5 Menu color

- | | | |
|---|----------|--|
|  | 1 | Enter the menu. |
|   | 2 | Select "Settings". |
|   | 3 | Select "Set Handset". |
|   | 4 | Select "Menu colour". |
|   | 5 | Select "Blue", "Orange" or "Pink" and confirm. |
|  | 6 | Return to standby. |











7.6 Setting the contrast

- | | | |
|---|----------|--|
|  | 1 | Enter the menu. |
|   | 2 | Select "Settings". |
|   | 3 | Select "Set Handset". |
|   | 4 | Select "Display Contrast". |
|   | 5 | Select the contrast you want (low, Mid or high). |
|  | 6 | Return to standby. |

7.7 Setting the light timeout











- | | | |
|---|----------|--|
|  | 1 | Enter the menu. |
|   | 2 | Select "Settings". |
|   | 3 | Select "Set Handset". |
|   | 4 | Select "Light Timeout". |
|   | 5 | Select the timeout you want (15,30 or 45 seconds). |
|  | 6 | Return to standby. |

7.8 Setting the screensaver

- | | | |
|---|----------|---|
|  | 1 | Enter the menu. |
|   | 2 | Select "Settings". |
|   | 3 | Select "Set Handset". |
|   | 4 | Select "Screensaver". |
|   | 5 | Select "Clock" or "No" screensaver and confirm. |
|  | 6 | Return to standby. |









7.9 Autotalk

When there is an incoming call and the handset is on the base, the phone automatically takes the line when lifted from the base. This function can be turned on or off.

- | | | |
|---|----------|-----------------------|
|  | 1 | Enter the menu. |
|   | 2 | Select "Settings". |
|   | 3 | Select "Set Handset". |
|   | 4 | Select "Autotalk". |
|   | 5 | Select "On" or "Off". |
|  | 6 | Return to standby. |

7.10 PABX Access code

It is possible to use your telephone with a prefix number. When dialling from the call list or phonebook, this prefix will be dialled automatically before the number.





- | | |
|---|--|
|  | 1 Enter the menu. |
|  | 2 Select "Settings". |
|  | 3 Select "Set Handset". |
|  | 4 Select "PABX Access Code". |
|  | 5 Select "Set code". |
|  | 6 Enter the prefix code, e.g. '0' (1 digit only) and select "Save". |
| | OR |
|  | 7 Select "On" or "Off". |
|  | 8 Return to standby. |



When dialling manually a number, this prefix will not be dialled but has to be entered manually.







7.11 Redial length

It's possible to set the redial length of 32 digits to 17 digits. By doing this you can prevent to store for example your phone banking access data into the phones memory.

- | | |
|---|--|
|  | 1 Enter the menu. |
|  | 2 Select "Settings" and confirm. |
|  | 3 Select "Set Handset" and confirm. |
|  | 4 Select "Long" for 32 digits or "Short" for 17 digits and confirm. |
|  | 5 Return to standby. |

7.12 Receiving Volume













This sets the standard volume level for the handset earpiece.

- | | |
|---|---|
|  | 1 Enter the menu. |
|  | 2 Select "Settings". |
|  | 3 Select "Set Handset". |
|  | 4 Select "Receiving volume". |
|  | 5 Select the desired volume (1-8) and confirm. |
|  | 6 Return to standby. |

7.13 Using the alarm feature

You can have different alarm setting for each handset registered to your base. The alarm rings only at the handset, not at the base or any other handset. When an alarm is set, the  icon will appear on the top of the display.

Set the alarm

- | | |
|---|---|
|  | 1 Enter the menu. |
|   | 2 Select "Clock & Alarm". |
|   | 3 Select "Alarm". |
|   | 4 Select "On". |
|   | 5 Select "Once", "On daily", or "Mon to Fri" and confirm.
If you have selected "Once", "On daily" or "Mon to Fri", the display will show:
Enter Time:
00:00 |
|   | 6 To deactivate the alarm, select "Off" and confirm. |
|  | 7 Press "Back" to go to the previous menu. |













If the alarm is set on daily or Mon-Fri the  icon will remain on the screen.

8 Base settings











8.1 Ringtone

You can choose from 5 different ringer melodies.

- | | |
|---|---|
|  | 1 Enter the menu. |
|   | 2 Select "Settings". |
|   | 3 Select "Set Base". |
|   | 4 Select "Ringtone". |
|   | 5 Select the desired melody and confirm.
During scrolling a sample is played. |
|  | 6 Return to standby. |

8.2 Ringer Volume

You can choose from 5 handset ringer volume levels.







- | | |
|---|---|
|  | 1 Enter the menu. |
|   | 2 Select "Settings". |
|   | 3 Select "Set Base". |
|   | 4 Select "Ringer Volume".
The current setting is displayed. |
|  | 5 Press the up key to increase the volume. |
|  | 6 Press the down key to decrease the volume. |
|  | 7 Press "Select" to confirm. |
|  | 8 Return to standby. |

8.3 Dial Mode

There are 2 types of dialling mode:

- DTMF/Tone dialling (most common used)
- Pulse dialling (for older installations)







To change the dialling mode:

- | | | |
|---|----------|---------------------------|
|  | 1 | Enter the menu. |
|  | 2 | Select "Settings". |
|  | 3 | Select "Set Base". |
|  | 4 | Select "Dialling mode". |
|  | 5 | Select "Tone" or "Pulse". |
|  | 6 | Return to standby. |

8.4 Recall (Flash)







Press the Flash key "R" (Key 8 - Picture 2E) to use certain services on your external line such as "call waiting" (if your phone company offers this feature); or to transfer calls if you use a telephone exchange (PABX). The Flash key "R" is a brief interruption of the line.

You can set the flash time to 100ms or 250ms.

- | | | |
|---|----------|---|
|  | 1 | Enter the menu. |
|  | 2 | Select "Settings". |
|  | 3 | Select "Set Base". |
|  | 4 | Select "Recall Mode". |
|  | 5 | Select "Recall 1" for short flash time (100ms) or "Recall 2" for long flash time (250ms). |
|  | 6 | Return to standby. |















8.5 System PIN

The System PIN is used for registering and deregistering handsets and some other optional settings. The default System PIN is 0000.

- | | | |
|---|----------|--|
|  | 1 | Enter the menu. |
|  | 2 | Select "Settings". |
|  | 3 | Select "Set Base". |
|  | 4 | Select "System PIN". |
|  | 5 | Enter the old PIN (0000 by default) and select "OK". |
|  | 6 | Enter the new PIN, select "OK" and repeat this. |
|  | 7 | Return to standby. |











8.6 Ring Priority

If you have more than one handset registered, you can choose which handset should ring first before the others start to ring. You can also set the amount of rings (2, 4 or 6) after the others start to ring.

- | | | |
|---|----------|---|
|  | 1 | Enter the menu. |
|   | 2 | Select "Settings". |
|   | 3 | Select "Set Base". |
|   | 4 | Select "Ring Priority". |
|   | 5 | Select "All Handset" or "Select Handset".
If "Select Handset" is selected: |
|   | 6 | Select the handset that should ring first. |
|   | 7 | Set the ring delay to 2, 4 or 6 rings and confirm. |
|  | 8 | Return to standby. |

8.7 First ring On/Off

If you have Caller ID service, your phone will not ring until the caller information has been received. You can make your handsets to ring without waiting for the caller information by turning the first ring On:











- | | | |
|---|----------|-----------------------------------|
|  | 1 | Enter the menu. |
|   | 2 | Select "Settings". |
|   | 3 | Select "Set Base". |
|   | 4 | Select "First Ring". |
|   | 5 | Select "On" or "Off" and confirm. |
|  | 6 | Return to standby. |



When turning On the first ring you will hear the default ring tone first. This will change to the selected ring tone ones the caller information is displayed.

9 Factory Reset

You can restore your phone back to default (original) settings. This doesn't effect the phonebook, call list, user data or registrations of handsets.

- | | | |
|---|----------|--|
|  | 1 | Enter the menu. |
|   | 2 | Select "Settings". |
|   | 3 | Select "Set Base". |
|   | 4 | Select "Master Reset". |
|   | 5 | Select "Yes" to confirm or "No" to cancel. |
|  | 6 | Return to standby. |

10 Agenda

You can set 5 event (appointments or reminders) which you can give a name and an alarm by date and time. The event can be shown as a text message with our without alarm. The events are stored inside the handset so each handset can have it's own events. When a reminder is On, the event name is show together with the alarm  icon for 1 minute.



1 Enter the menu.

2 Select "Agenda" and confirm.

3 Select one of the 5 appointments and select "Option".

To add an appointment:

4 Select "Add Entry".

5 Enter a name for the event (max. 24 characters) and confirm.

6 Enter the date and time and confirm.

7 Select "Silent" if you only want a visual indication or "Alarm" if you want to have visual and audible warning.

8 If you have set "Alarm" the phone will ask you to have it "Ones" or "Annually (for birthdays).

9 If you have set it "Ones" you can choose to have it "At event time" or "30 min before".

To edit the appointment:

10 Select "Edit Event" and confirm.

11 Edit the name of the event and select "Save".

12 Enter the date and time of the event and select "Save".

13 Select "Silent" or "Alarm" and confirm.

To delete the appointment:

14 Select "Delete Event" and confirm.

15 Press "Yes" to confirm or "No" to go back.

16 Return to standby.

To delete all events:

17 Select "Delete All Event" and confirm.

18 Press "Yes" to confirm or "No" to go back.

To show details:

19 Select "Show Details" and confirm.

20 Press "Yes" to confirm or "No" to go back.

To send as text:

21 Select "Send as Text" and confirm.

22 The Event will be shown as a text message which you can edit.

23 Select "Option"

24 Select "Send"

25 Enter the telephone number or select "Search".

26 Select "Save" to send the event as an SMS.

27 Return to standby.

The caller's details are always stored (answered or not) in the Calls list. When the list is full and a new call is received, the oldest will be removed.

11 SMS



This service only works when you have Caller ID/SMS subscription!

You can send and receive SMS with your telephone. This section tells you how to use the SMS feature.

The phone keeps the messages which are received in the Inbox. You can store a total of 50 SMS messages across all handsets Outboxes, Draft and inbox.

Messages which are ready to be send out to the SMS-server are stored in the Outbox. Messages which are saved are stored in the Draft box.



Before sending and receiving SMS text messages you need to set the telephone number of your Network's SMS Centre for outgoing and incoming messages (see "SMS Service center numbers")

11.1 How to write an SMS

The method is the same as entering a name in the phonebook ("4 Phonebook").

To enter a space press '0' and to change from capital to small character or numeric input, press '#'. The remaining amount of characters per message is shown on the upper right corner of the screen.

11.2 Sending an SMS



1 Enter the menu.



2 Select "Text Messaging".



3 Select "Write Message".



4 Start writing the message.



5 Select "Options".

To save the message in the Draft folder so you can send it later:



6 Select "Save message".

To add an emoticon:



7 Select "Insert Emoticon".



8 Choose one of the emoticons and select "Insert".

To add one of the template text:



9 Select "Use Template".



10 Choose one of the template text and select "Insert".

To add a symbol:



11 Select "Insert Symbol".



12 Choose one of the symbols and select "Insert".

To Send the message:



13 Select "Send".



14 Enter the telephone number and select "Send".



Instead of entering a number with the numerical keypad, you can select a number out of the phonebook by pressing the left soft key "Search".

11.3 Read and view the list of received messages (Inbox)

Your telephone display indicates if there are new messages received. The icon  will be shown along with "You have X new messages".

When there are new message:



1 Press left soft key "Read".

The Inbox list appears on the display. This is a combination of new and read messages. Messages which are new are indicated with a blue dot  icon.



2 Scroll through the list and select "Read" to read the message.



3 Select "Option".

To delete this message:



4 Select "Delete" and confirm with "Yes". To cancel press "No".

To Reply this message:



5 Select "Reply".



6 Write your message and select "Options". Same as writing a new message you have to possibility to send, Save and to use a template etc ...



7 Select "Send".

To forward this message to another number:



8 Select "Forward".



9 Edit the message if needed and select "Option". Same as writing a new message you have to possibility to send, Save and to use a template etc.



10 Select "Send".

To dial this number:



11 Select "Use Number" and confirm. The number will be dialled automatically.

To store this number into the phonebook:



12 Select "Save Number".



13 Enter the name and select "Save".



14 Edit the telephone number if needed and select "Save".

To see the message details:



15 Select "Message Details".



16 The sender's number is displayed. Press "Dial" if you want to call the number.

Read the inbox by the menu:



1 Enter the menu.



2 Select "Text Messaging".











3 Select "Inbox".

11.4 Reading and sending the saved message (Draft folder)

If you save a message to complete or send later it will be stored in the Draft box. You can write a message and send it later by saving it into the Draft box. Only one message can be stored in each user's draft box.

Edit or Send texts in the draft folder:

















- | | |
|---|--|
|  | 1 Enter the menu. |
|   | 2 Select "Text Messaging". |
|   | 3 Select "Drafts". |
|   | 4 Select "Edit" to edit your message content. |
|  | 5 Select "Options". |

You have now the same options as reading the inbox.

11.5 Using the outbox

The outbox contains all messages which are ready to send or failed to be send. The outbox can store up to 5 messages. In case more then 5 messages are send, the oldest message successfully send will be removed.











Read the Outbox:

- | | |
|---|--|
|  | 1 Enter the menu. |
|   | 2 Select "SMS Message". |
|   | 3 Select "Outbox". |
|   | 4 Select the message and select "Read". |
|  | 5 Select "Options". |
| To forward this message to another number: | |
|   | 6 Select "Forward". |
|   | 7 Edit the message if needed and select "Options". Same as writing a new message you have to possibility to Send, Save and to use a template etc. |
|   | 8 Select "Send". |
| To delete this message: | |
|   | 9 Select "Delete" and confirm with "Yes". To cancel press "No". |









11.6 Template messages

You can edit you own template messages to use when writing a message. The phone can store up to 3 templates of maximum 32 characters. Default the templates are empty:

To Edit your own messages:

- | | |
|---|--|
|  | 1 Enter the menu. |
|   | 2 Select "Text Messaging". |
|   | 3 Select "Templates". |
|   | 4 Select the template message and select "Options". |
| To edit the message: | |
|   | 5 Select "Edit" to edit and select "Save" to store. |
| To delete the message: | |
|   | 6 Select "Delete" and confirm. |

11.7 Delete messages

- | | |
|---|--|
|  | 1 Enter the menu. |
|   | 2 Select "Text Messaging". |
|   | 3 Select "Delete Messages". |
|   | 4 Select "Inbox, Draft, Outbox, or All Messages". |
|  | 5 Confirm with "Yes" or press "No" to cancel. |











11.8 SMS Settings

SMS Service center numbers

To send and receive SMS text messages you need the telephone number of your Network's SMS Centre. These numbers have been pre-loaded into the phone. If you accidentally delete the SEND or RECEIVE SMS Service Centre numbers you will need to re-enter them in order for your SMS Service to work.

The Orbit can store 2 SMS Service center numbers, one incoming and one outgoing. This sending SMS service number will be dialed out by the phone whenever you send out a SMS.









To set the SMS Center numbers

- | | |
|---|--|
|  | 1 Enter the menu. |
|   | 2 Select "Text Messaging". |
|   | 3 Select "Text Settings". |
|  | 4 Select "Service Centres". |
|  | 5 Select "Receiving Centres" or "Send Centres". |
|  | 6 Select "Centre 1". |
|   | 7 Enter the number for the centre and press "Save". |

If there is an incoming call with a number matching with one of these SMS center numbers, the phone knows it's a call from the SMS center and will take the line automatically to receive the messages.



Message alert tone









When you receive a text message, the message alert tone will sound. These beeps can be switched on or off:

- | | |
|---|-----------------------------------|
|  | 1 Enter the menu. |
|   | 2 Select "Text Messaging". |
|   | 3 Select "Text Settings". |
|   | 4 Select "Message Alert". |
|  | 5 Select "Yes" or "No". |

Set Message size

A standard text message is 160 characters long. You can set a message to be up to 612 characters and the message will be sent as 4 messages of 160 characters long:

- | | |
|---|-----------------------------------|
|  | 1 Enter the menu. |
|   | 2 Select "Text Messaging". |

-    **3** Select "Text Settings".
-    **4** Select "Message Size".
-    **5** Select "160 Characters" or "612 Characters".

11.9 User Areas

If you have more than one SMS terminal device on the same telephone line you must create different User Areas. Each user can have his own Inbox and outbox which are only accessible by a pin code. By giving each user different sub addresses, they can receive their own private messages.

In order to receive personal SMS messages, you must give your correspondents the sub address Number that they need to add to your standard telephone number (See below).

You correspondents will need to add your sub address to your telephone number when they want to send personal SMS.































E.g. If your personal sub address is "1" and your telephone number is 123456789, your correspondents should send their SMS messages to:1234567891! This is the number you need to remember and give to your correspondents.

If no sub address is add to you telephone number or '0', all devices will receive these messages.

You can change the sub address number to another one but only from 0-9:





Add a User mailbox



-  **1** Enter the menu.
-    **2** Select "Text Messaging".
-    **3** Select "Text Settings".
-    **4** Select "Users".
-    **5** Select one of the users and press "Options".
-    **6** Select "Edit".
-    **7** Enter the user name (max. 8 characters) and press "Save".
-    **8** Use the sub address shown or enter you own sub address (0-9).
-  **9** Press "Save".
-    **10** Enter the 4-digit mailbox PIN and press "Save".
-    **11** Enter the PIN code again and press "Save".

Open and read your own mailbox content













Once a mailbox is set and you enter the "Text Messaging" menu, the mailboxes in use will be displayed. You can open the "General User" mailbox without PIN code, the others will be PIN protected.

When there are new message:











-  **1** Press left soft key "Read".
The mailboxes are displayed. Mailboxes with new messages are marked with blue dots ●.
-    **2** Scroll through the list and select the mailbox you want.

-  **3** Enter the mailbox PIN code and press OK.
-  **4** Select the message you want and press "Read".





Edit a user mailbox

-  **1** Enter the menu.
-  **2** Select "Text Messaging".
-  **3** Scroll to the mailbox you want to edit and press "Select".
-  **4** Enter the 4 PIN password and press OK.
-  **5** Select "Text Settings".
-  **6** Select "Users".
-  **7** Scroll to the user mailbox you want to edit and press "Options".
-  **8** Select "Edit".
-  **9** Enter the 4 PIN password and press OK.
-  **10** Edit the name and press "Save".
-  **11** Enter the new sub-address and press "Save".
-  **12** Enter the new 4 PIN password and press "Save".
-  **13** Re-Enter the PIN password and press "Save".

Delete a user mailbox

-  **1** Enter the menu.
-  **2** Select "Text Messaging".
-  **3** Scroll to the mailbox you want to edit and press "Select".
-  **4** Enter the 4 PIN password and press OK.
-  **5** Select "Text Settings".
-  **6** Select "Users".
-  **7** Scroll to the user mailbox you want to edit and press "Options".
-  **8** Select "Delete".
-  **9** Confirm with "Yes" or press "No" to cancel.
-  **10** Enter the 4 PIN password and press OK.

Set the Common mailbox sub address

-  **1** Enter the menu.
-  **2** Select "Text Messaging".
-  **3** Select "Text Settings".
-  **4** Select "Mailbox Number".
-  **5** Enter the new sub-address and press "Save".



If you enter a number already in use, you hear an error beep. Enter a different number to avoid this.

12 Additional handsets and base stations

You can subscribe up to 5 handsets on a base. Each handset can register up to 4 base stations and the user can select the base he wants to use.

12.1 Adding a new handset



Only needed when you have deregistered a handset or when you bought a new one.

To put the base into registration mode:



- 1 Press and hold the paging key on the base for 3 seconds. During 60 seconds the base is ready to register.

On the handset:



- 1 If the handset is new "Please Register" is shown. Press "Menu" and select "Registration".
OR
- 2 Enter the menu.
- 3 Select "Registration".
- 4 Select "Register handset".
- 5 Select the number of the base to be associated with the handset (1-4) and confirm.
- 6 Enter the system PIN (0000 by default) and confirm.
- 7 Return to standby.

12.2 Removing a handset

This procedure needs to be carried out on a different handset than the one you want to remove.



- 1 Enter the menu.
- 2 Select "Registration".
- 3 Select "De-Register".
- 4 Enter the system PIN (0000 by default) and confirm.
- 5 Scroll to the handset that needs to be removed and confirm.
- 6 Press "Yes" to confirm or "No" to cancel.
- 7 Return to standby.

12.3 Select a base

You can switch your handset between bases. The handset must first be registered with each base individually.



- 1 Enter the menu.
- 2 Select "Registration".
- 3 Select "Select Base".
- 4 Scroll to the base you want to use and confirm. The base currently in-use is marked with "In-use".

12.4 Using the intercom feature

Calling an internal handset



- 1 Press the INT-Key.

The screen displays "Internal Call".



- 2 Enter the internal number of the handset you want to call (1-5).



- 3 Press "OK" to dial.



- 4 Press the on-hook key to hang up or put the handset back on the base.

Transfer an external call to another handset

During an external call:



- 1 Press the INT-Key.

Your external correspondent is placed on hold.

The screen displays "Internal Call".



- 2 Enter the internal number of the handset you want to call (1-5).



- 3 Press "OK" to dial.



- 4 When the internal correspondent answers, press the on-hook key to transfer the call.

OR



- 3 If the internal correspondent doesn't answer, press the INT key to retrieve the external correspondent or to go from one to the other.



- 4 Press the on-hook key to hang up or put the handset back on the base.

Conference call

You can talk between 2 handsets and an external line at the same time.

During an external call:



- 1 Press the INT-Key.

Your external correspondent is placed on hold.

The screen displays "Internal Call".



- 2 Enter the internal number of the handset you want to call (1-5).



- 3 Press "OK" to dial.



- 4 When the internal correspondent answers, select "Join".

"Conference Call" is shown on the display.



- 5 Press the on-hook key to hang up or put the handset back on the base.

Taking an external call during an internal communication

When you are on intercom with another handset, you can still pick up outside calls.

To take an incoming call:



- 1 Press the on-hook key. The internal communication is now interrupted.



- 2 Press the off-hook key. You are now in communication with the outside caller.

13 Troubleshooting

Symptom	Possible cause	Solution
No display	Batteries uncharged	Check the position of the batteries
		Recharge the batteries
	Handset turned OFF	Turn ON the handset
No tone	Telephone cord badly connected	Check the telephone cord connection
	The line is occupied by another handset	Wait until the other handset hangs up
The icon  flashes	Handset out of range	Bring the handset closer to the base
	The base has no power supply	Check the mains connection to the base
	The handset is not registered on the base	Register the handset on the base
Base or handset do not ring	The ringing volume is off or low	Adjust the ringing volume
Not possible to transfer a call on PABX	The Flash Time is too short or too long	Change the Flash Time
Telephone does not react to pressing the keys	Manipulation error	Remove the batteries and put them back in place

14 Technical data Technical characteristics

Standard	DECT (Digital Enhanced Cordless Telecommunications) GAP (Generic Access Profile)
Frequency range	1880 MHz to 1900 MHz
Number of channels	120 duplex channels
Modulation	GFSK
Speech coding	32 kbit/s
Emission power	10 mW (average power per channel)
Range	300m in open space /50m maximum in-house
Number of handsets	Up to 5
Base power supply	230V / 50 Hz / 6,5V DC 300mA
Handset Batteries:	2 rechargeable batteries AAA, NiMh 1,2V, 750mA
Handset autonomy	110 hours in standby
Handset talk time	11 hours
Normal conditions of use	+5 °C to +45 °C
Dialling mode	Pulse / Tone
Flash time	100 or 250 ms
Measurements base	ca. 112mm x 112mm x 64mm (L x B x H)
Measurements handset	ca. 34mm x 52,5mm x 154mm (L x B x H)
Weight base with adaptor	ca. 319g
Weight base without adaptor	ca. 135g
Weight handset with batteries	ca. 124g

15 Warranty

15.1 Warranty period

The Topcom units have a 24-month warranty period. The warranty period starts on the day the new unit is purchased. The warranty on batteries is limited to 6 months after purchase. Consumables or defects causing a negligible effect on operation or value of the equipment are not covered.

The warranty has to be proven by presentation of the original purchase receipt, on which the date of purchase and the unit-model are indicated.

15.2 Warranty handling

A faulty unit needs to be returned to a Topcom service centre including a valid purchase note. If the unit develops a fault during the warranty period, Topcom or its officially appointed service centre will repair any defects caused by material or manufacturing faults free of charge.

Topcom will at its discretion fulfil its warranty obligations by either repairing or exchanging the faulty units or parts of the faulty units. In case of replacement, colour and model can be different from the original purchased unit.

The initial purchase date shall determine the start of the warranty period. The warranty period is not extended if the unit is exchanged or repaired by Topcom or its appointed service centres.

15.3 Warranty exclusions

Damage or defects caused by incorrect treatment or operation and damage resulting from use of non-original parts or accessories not recommended by Topcom are not covered by the warranty.

Topcom cordless phones are designed to work with rechargeable batteries only. The damage caused by the use of non-rechargeable batteries is not covered under warranty. The warranty does not cover damage caused by outside factors, such as lightning, water and fire, nor any damage caused during transportation. No warranty can be claimed if the serial number on the units has been changed, removed or rendered illegible.

Any warranty claims will be invalid if the unit has been repaired, altered or modified by the buyer or by unqualified, non-officially appointed Topcom service centres.

16 Disposal of the device (environment)



At the end of the product lifecycle, you should not throw this product into the normal household garbage but bring the product to a collection point for the recycling of electrical and electronic equipments. The symbol on the product, user guide and/or box indicate this.

Some of the product materials can be re-used if you bring them to a recycling point. By re-using some parts or raw materials from used products you make an important contribution to the protection of the environment. Please contact your local authorities in case you need more information on the collection points in your area.

17 Cleaning

Clean the telephone with a slightly damp cloth or with an anti-static cloth. Never use cleaning agents or abrasive solvents.



SERVICE RETURN CARD - RÜCKSENDEKARTE -
CARTE DE RETOUR SERVICE - RETOURFICHE

RETURN WITH YOUR DEFECT PRODUCT

Name/Vorname/Prénom/Naam:

Surname/Familiename/Nom/Familienaam:

Street/Straße/Rue/Straat:

Nr./N°:

Box/Postfach/Boîte/Postbus:

Location/Ort./Lieu/Plaats:

Post code/Postleitzahl/Code Postal/Postcode:

Country/Land/Pays/Land:

Tel./Tél.:

E-mail:

Model name/Modellbezeichnung/Nom du modèle/Modelnaam:

Serial Nr/Seriennummer/N° série/Seriennummer:

Purchase date/Kaufdatum/Date d'achat/Aankoopdatum:

 - - (DD/MM/YYYY) - (TT/MM/JJJJ)

Fault description/Beschreibung des Defekts/Description de la panne/Beschrijving defect:

(Original Proof of Purchase has to be attached to this return card to be valid for warranty)

----- ✂ ----- ✂ -----
Model name/Modellbezeichnung/Nom du modèle/Modelnaam:

Serial Nr/Seriennummer/N° série/Seriennummer:

Purchase date/Kaufdatum/Date d'achat/Aankoopdatum:

 - - (DD/MM/YYYY) - (TT/MM/JJJJ)

Fault description/Beschreibung des Defekts/Description de la panne/Beschrijving defect:

TOPCOM[®]

ORBIT

visit our website
www.topcom.net

MD2500171

Free Manuals Download Website

<http://myh66.com>

<http://usermanuals.us>

<http://www.somanuals.com>

<http://www.4manuals.cc>

<http://www.manual-lib.com>

<http://www.404manual.com>

<http://www.luxmanual.com>

<http://aubethermostatmanual.com>

Golf course search by state

<http://golfingnear.com>

Email search by domain

<http://emailbydomain.com>

Auto manuals search

<http://auto.somanuals.com>

TV manuals search

<http://tv.somanuals.com>