

TOPCOM®

HB 8M00



USER GUIDE

V 1.0, 09/08



UK The CE symbol indicates that the unit complies with the essential requirements of the directive 89/336/EEC.

UK The features described in this manual are published with reservation to modifications.

This product is in compliance with the essential requirements and other relevant provisions of the R&TTE directive 89/336/EEC.
The Declaration of conformity can be found on :

<http://www.topcom.be/cedeclarations.asp>



1 INTRODUCTION

Congratulations on your purchase of the HB 8M00. We hope that you will enjoy using the Heart Meter and the benefits of the wireless transmission to send/receive data to/from the controller or to PC. In exercise or sports, your heart naturally speeds up in pumping blood to the body in accordance with the increased energy level. The Heart Meter can calculate this increase expressed as the number of beats per minute (bpm) to determine a target heart rate safe for each individual.



More information about the target heart rate zone, maximum heart rate etc... can be found on:
www.topcom.net/sports/heartbeat.asp

With the data stored on your PC, you can transfer it to programs like SportTracks, Perfect Session, ...

2 SAFETY NOTES

Using a Heart Monitor is NOT a substitute for professional medical attention. If you suffer from heart disorder, illness or have recently taken up fitness training, it is advisable that you seek a doctor or talk to your trainer and work out a fitness plan that suits you.

The watch should only be used as a guide in maintaining a safe heart beat rate for exercises. It should NOT be relied upon as a medical heart rate monitor. If you are uncertain about how your exercise program will impact on your heart, please consult a physician.

3 CARE AND MAINTENANCE

DO NOT expose the watch to extreme weather conditions or cleaning agents and solvents. Avoid dropping or rough handling of the watch. Avoid fastening the strap too tightly. Clean the watch with a dry soft cloth or a soft cloth moistened with water and mild detergent. Store the watch in a dry place when not in use.

4 CHANGING THE BATTERY

If you are not confident with electronics, let the battery be changed by a professional. Do not open the watch yourself.

4.1 WATCH



THIS WATCH HAS ALREADY A BATTERY INSIDE, so no need to place this battery when you just bought it. To turn the watch on see "5 Power save mode".

- Remove the back cover of the watch with a small screwdriver.
- Remove the old battery.
- Install the new 3V (CR2032) battery with the positive (+) pole facing up and replace the cover.



4.2 CHEST BELT

- Remove the battery cover from the bottom of the belt using a small coin.
- Remove the old battery.
- Install the new 3V (CR2032) battery with the positive (+) pole facing the battery cover and replace the battery cover.

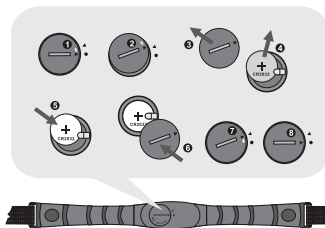

5 POWER SAVE MODE

This watch is sold with a power save function so that the battery can last longer. To turn this watch (display) ON, press an key.

To activate the power save mode press the LAP/RESET key [▼] for 5 seconds in time mode.



6 BUTTONS

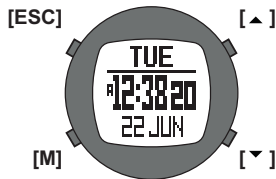

Mode Button [M] (MODE/SET)

- To select the current function or menu.
- Hold down to select setting mode. In setting mode: To select among the setting items.

Escape Button [ESC] (LIGHT/ESC)

- To select between timekeeping and sensor mode.
- To exit from setting mode.
- To go back to previous screen or function level.
- Hold down to turn on the backlight for a few seconds.

Up Button [↖] (ST./STP.)

- To scroll the menu upward.
- To activate the 'start' or 'stop' function under chronograph, timer, pacer mode.
- To increase the setting value during setting.

Down Button [↘] (LAP/RESET)

- To scroll the menu downward.
- To activate the lap function during chronograph mode and reset function during chronograph (hold down), timer and pacer (hold down) mode.
- To decrease the setting value during setting.

6.1 MASTER RESET

Press and hold [M], [↖] and [↘] simultaneously to reset the watch.
All set information will be lost, also the time!

6.2 BACK LIGHT

Press and hold the [ESC] key to activate the back light of the display for 3 seconds.



7 TO SET THE GENERAL ITEMS

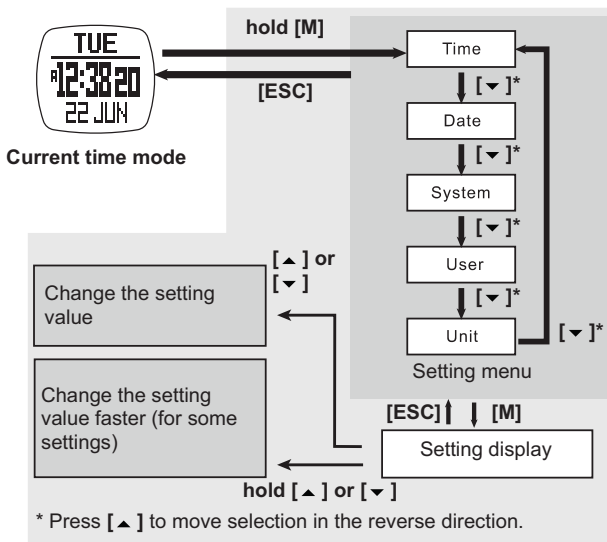

Note:

- **Time**: setting the **Second, Minute, Hour** and **Hour Format**.
- **Date**: setting the **Year, Month** and **Day**
- **System**: setting the **LCD** (contrast), **Sound** (key tone and chime), **Light** (normal, night and off), **Pair** (pair the chest strap with the watch).
- **User**: setting the **Gender, Birthday, Height** and **Weight**.



When **Light** is set to night mode, every key press will turn on the backlight.



7.1 TO PAIR THE WATCH WITH THE CHEST BELT

The chest belt is normally paired with the watch when bought. If battery is replaced or after a reset the chest belt has to be paired again.

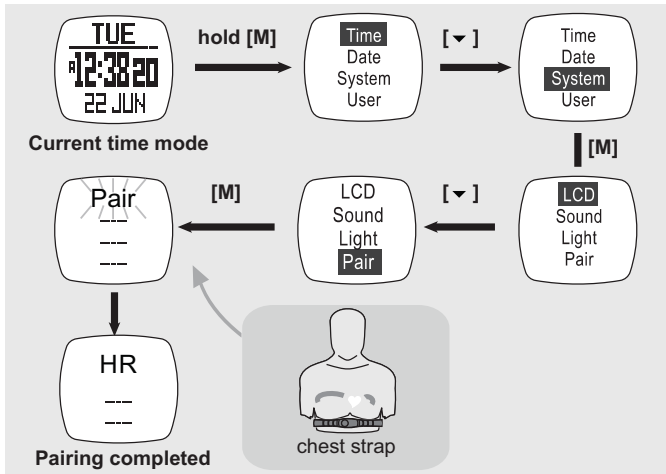

During the pairing:

The heart rate chest strap **MUST** be worn on the chest or press the two contacts (i.e. heart rate signal is sampling).



8 TIMEKEEPING - HEART RATE MODE MAIN MENU

There are 2 menu's you can enter by briefly pressing the **[ESC]** key: timekeeping menu and heart rate (sensor) menu. To scroll between both menu's press the **[ESC]** key.

Once you are in the selected menu you can scroll with the up/down **[▲]**/**[▼]** keys between the other modes.

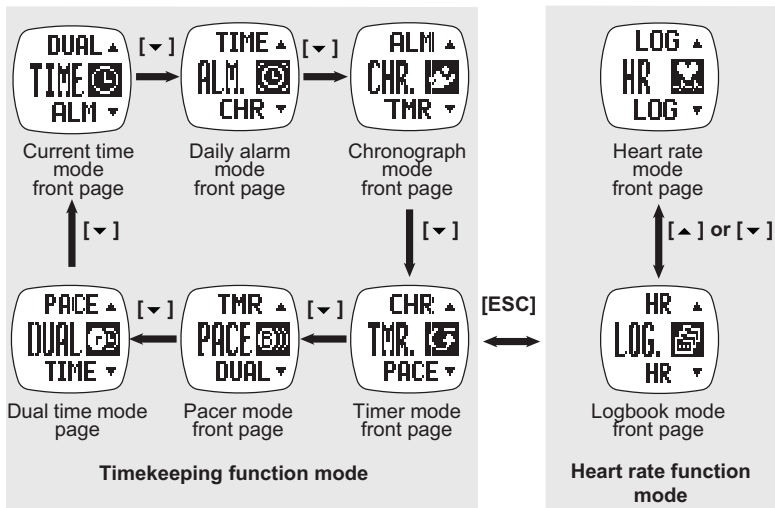

Note:

- The corresponding operation mode will show after 3 seconds or press **[M]** to show the operation mode immediately.
- Press **[▲]** to move the selection in the reverse direction.



8.1 TIMEKEEPING MENU ITEMS

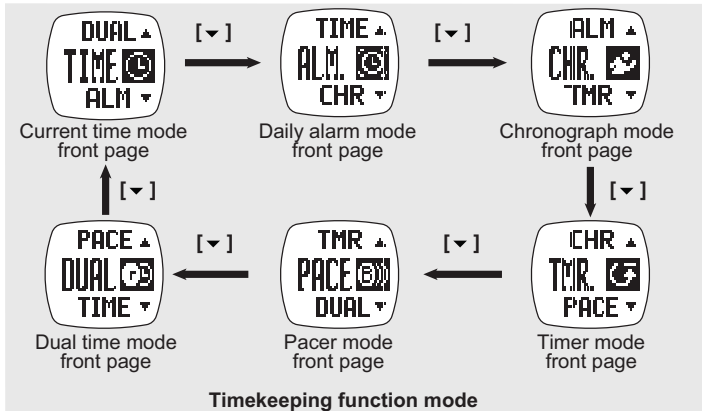

8.1.1 Daily or weekly alarm mode on/off

This watch includes 2 alarms for home time.

When the daily alarm is on, the watch will beep for 30s at the alarm time every day. When the weekly alarm is on, the watch will beep for 30s at the alarm time on the set day. When the alarm beeps, press any button to stop the alarm.

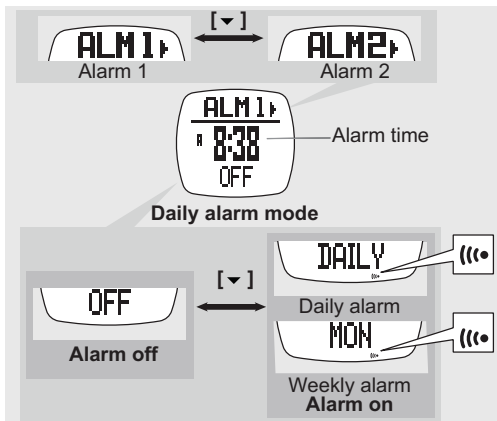

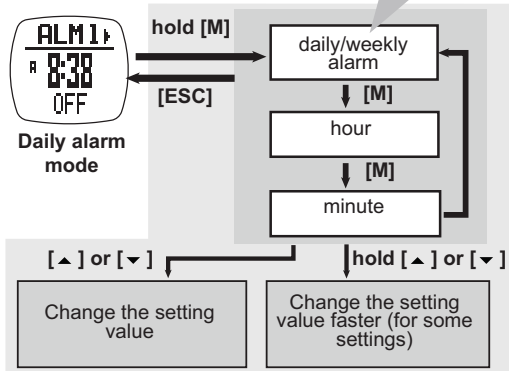
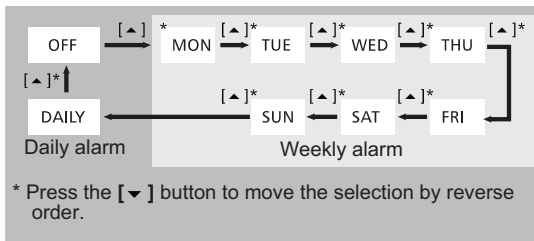
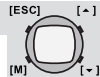

8.1.2 Use the chronograph



- The chronograph counts up to 99 hours, 59 minutes and 59 seconds and has a memory of 50 laps.
- Chronograph logs, e.g. lap time, maximum/average/minimum lap time, etc can be uploaded to PC for review. See "10.3.1 Download /analyse from watch" for more details.



To start and stop the chronograph

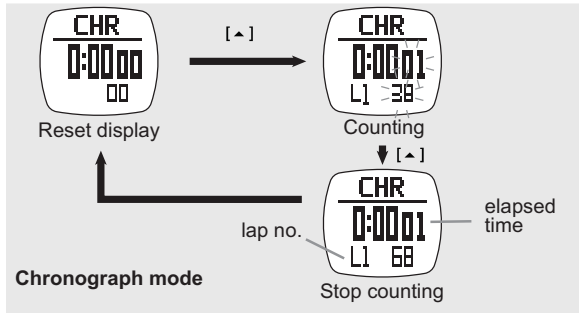

To take and recall lap times

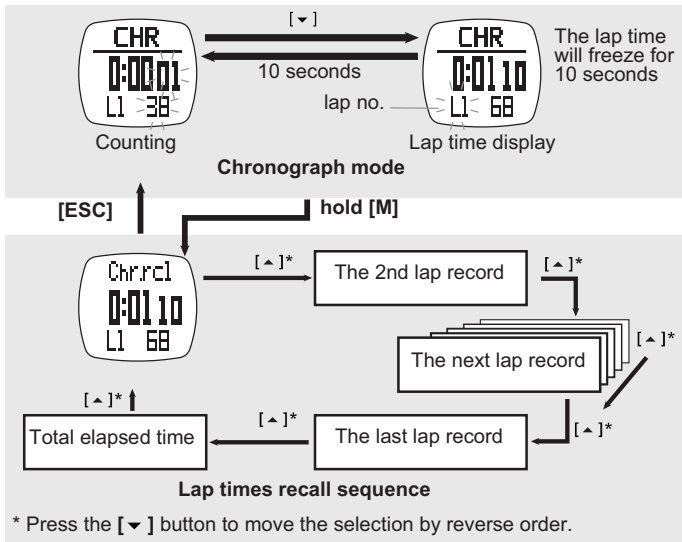



8.1.3 Use the count down timer



The maximum counting down time is 99 hours, 59 and minutes 59 seconds. You can set your own count down time (max. 99:59:59) or use one of the preset values (3, 5, 10, 15 or 45 minutes).

To set and use the preset values (3, 5, 10, 15 or 45 minutes)

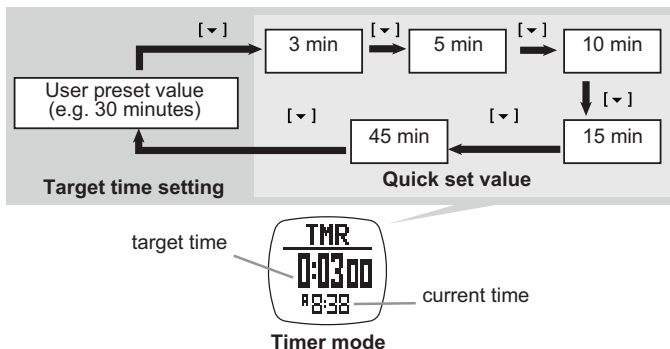

To set your own count down time

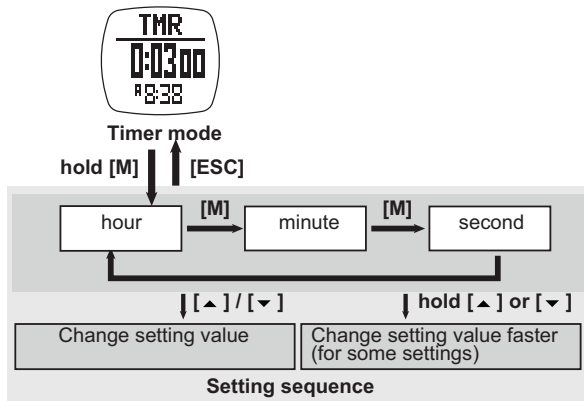



To start stop the count down timer

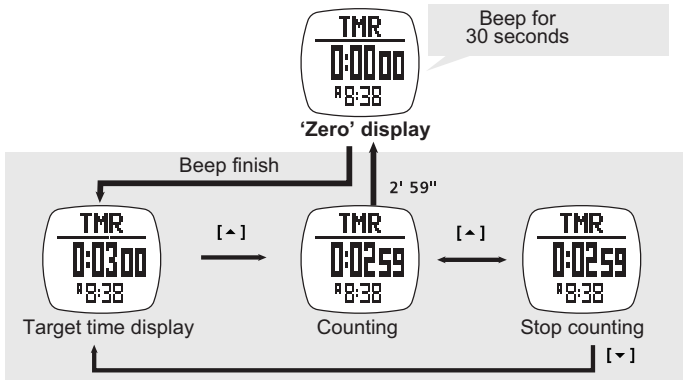

8.1.4 To use the pacer

A pacer is a kind of metronome that can be used to give a certain rhythm when you exercise. It can be set in beeps per minute (B/M). You can also see the counter of the beeps on the screen:

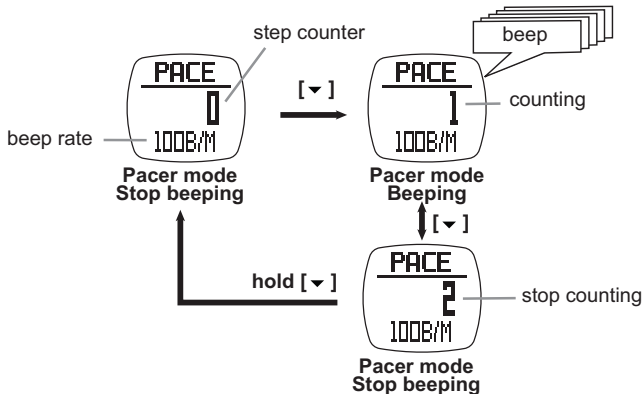



To set the pacer

The pacer can be set in steps of 5 beeps per minute (30,35,...):

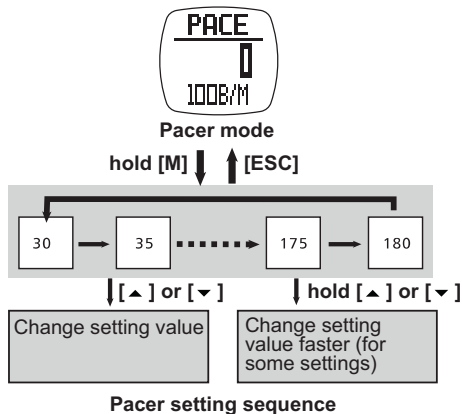

The pacer can also be used in chronograph mode:

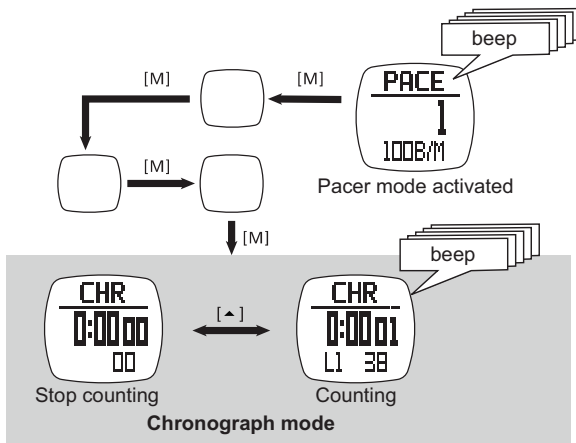



8.1.5 Dual time mode

When you need to keep track of the time elsewhere in the world.

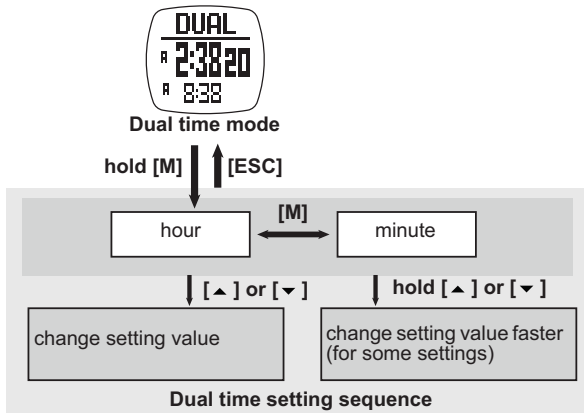

8.2 HEART RATE MODE OVERVIEW

8.2.1 Heartbeat measurement

See “8 Timekeeping - heart rate mode main menu” how to enter the heart beat measurement menu (HR).

PRECAUTIONS

- Avoid fastening the strap too tight.
- Do not bend or fold the chest belt for preventing damage.
- Wetting the skin, where there is contact with the conductive area of the chest belt, will improve the conduction and get a more stable signal.
- The physical condition of an individual might effect the intensity of measured signal.
- Avoid using the heart rate monitor close to a trolley car, a tram stop, transformer, electric substation and high-tension distribution lines etc. The radio signal will be affected under influence of the environment from high voltage and strong electromagnetic fields.

8.2.2 Using the transmitter belt.



THE CHEST STRAP MUST BE PAIRED WITH THE WATCH. SEE "7.1 To Pair the watch with THE chest belt" FOR DETAILED PAIRING OPERATION!

Fasten the fastener at one end. Try the chest belt on your chest and loosen the stretch band if necessary.



Adjust the length of the stretch band until it feels conformable. The stretch band must cling to the chest. Fasten the fastener at the other end. Adjust the sensor to the center of your chest and be sure the backside of the sensor clings to your chest and touches the skin.

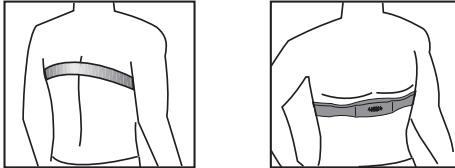

The chest belt has to be worn while using the heart rate function.



Moisten the chest belt conductive pads with saliva or ECG-gel (available at your local pharmacy) in order to ensure good contact with the skin at all time.

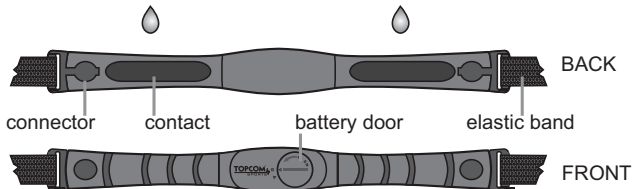

8.2.3 To get the heart rate measurement

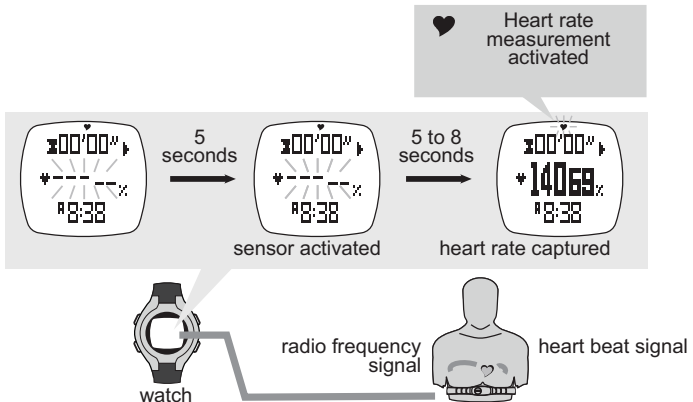

Note:

- When entering the heart rate mode, the heart rate function (sensor) will be activated automatically after 5 seconds. Which can be activated manually too, see “8.2.8 To start/stop the sensor, timer and log-book” for the detailed operations.
- When the heart rate function (sensor) is activated, the watch will aggregate the readings of the exercise into the current ‘session’.
- The data of the current session can be saved (into the ‘daily record’) / reviewed by the heart rate mode function menu, see “8.2.10 Heart rate mode function menu” under “MENU 1: Save” for the detailed operations.
- The ‘daily record’ can be reviewed by the heart rate mode function menu too. The watch can store up to 10 daily records.
- See “8.2.8 To start/stop the sensor, timer and logbook” to reset the current session.



8.2.4 Heart rate function displays

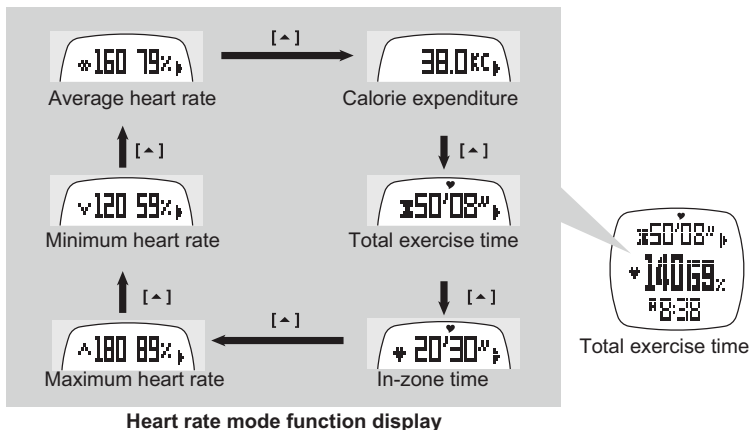

Note:

- The exercise timer is counting independently. Switching off to sensor or changing the screen to another mode will not affect the counting.
- The calorie expenditure is calculated by heart rate, changing the screen to another mode will not affect the calculation unless the sensor is switched off.

8.2.5 EMHR and %EMHR

Estimated Maximum Heart Rate (EMHR)

EMHR = 220 - age of the user

Percentage of Estimated Maximum Heart Rate (%EMHR)

%EMHR = acquired heart rate / EMHR x 100%

An example of %EMHR:



Estimated Maximum Heart Rate (EMHR)

EMHR = 220 - 30 (user's age) = 190 bpm



Percentage of Estimated Maximum Heart Rate (%EMHR)

acquired heart rate = 131 (by measurement)

$$\%EMHR = 131 / 190 \times 100\% = 69\%$$

8.2.6 Heart rate zones

Exercise zones are established by setting the Upper and Lower Heart Rate Limits. You can use the fitness (preset limits = 65% and 85% of the EMHR) or your own customized limits.

Use the following Heart Rate Zone Chart to select the zone you wish to exercise in.

You should consult a medical professional when selecting a training zone, especially if you have a heart condition.

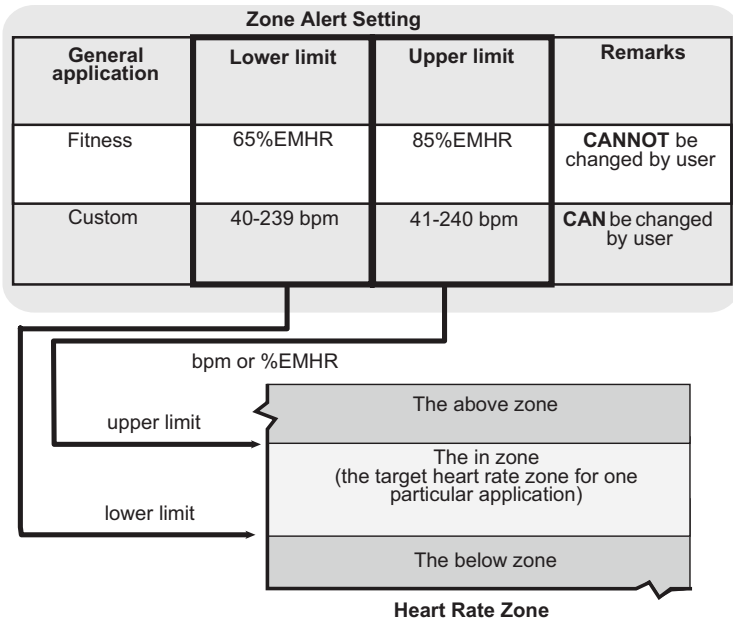

To set the zone upper or lower limits see “8.2.10 Heart rate mode function menu” under “ MENU 4: Zone”.



8.2.7 To turn on/off the zone alert

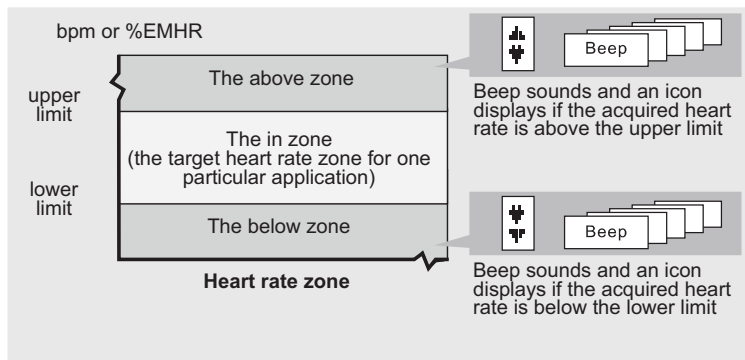

Zone alert off



Zone alert on

8.2.8 To start/stop the sensor, timer and logbook

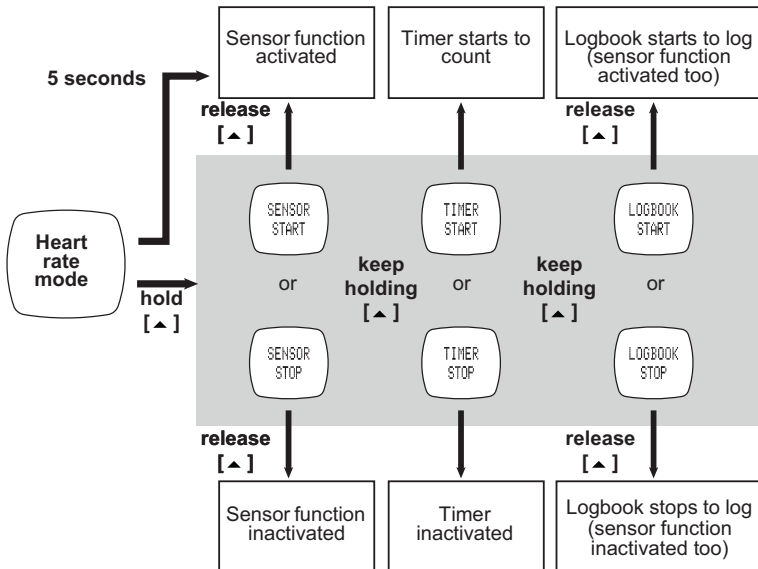

- When the heart rate mode is selected, the sensor function will be activated automatically after 5 seconds.
- The watch includes a count-up timer for timing the accumulative exercise time. If the timer is started, it will count-up continuously until it is stopped.
- When the sensor function is activated, the logbook will be started too if the 'AUTO' feature is set 'ON' (See "8.2.11 Logbook functions menu" under "MENU 5: Auto" for details)
- While the **LOG** function is started, a **LOG** indicator starts flashing on the screen.

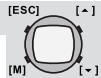

8.2.9 To reset the screen, session and timer

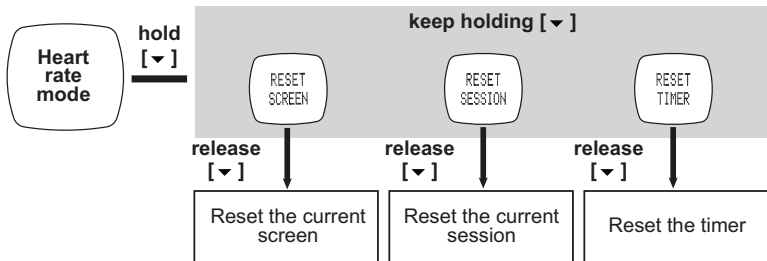

8.2.10 Heart rate mode function menu

During heart rate measurement you can enter the heart rate mode function menu to:

- Menu 1: **Save** To save the current session into today's record.
- Menu 2: **Session** To review the statical data of the current session.
- Menu 3: **Daily records** To review the daily records for the last 10 days.
- Menu 4: **Zone** To set upper and lower limits for the Zone Alert.

To enter the hear rate mode function menu press and hold **[M]**:

MENU 1: Save

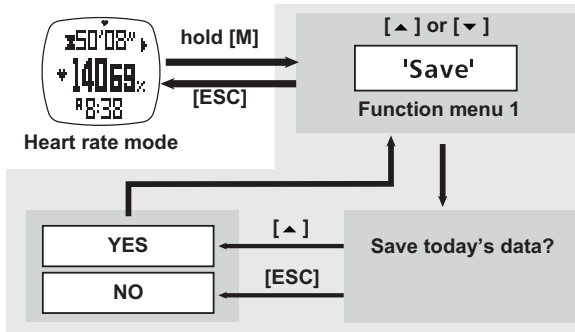



MENU 2: Session

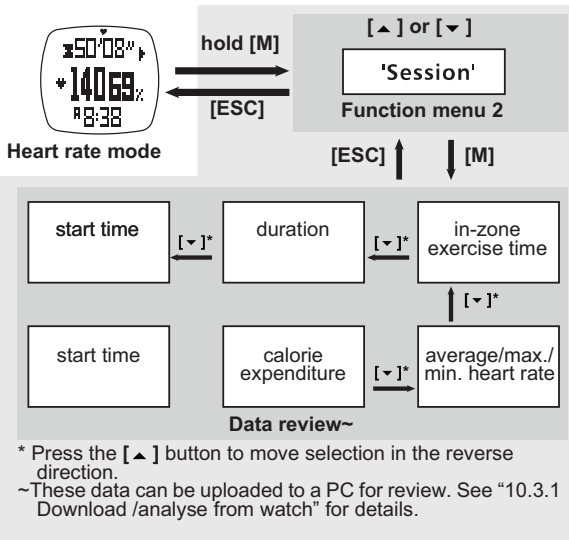

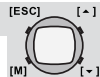

MENU 3: Daily Rd

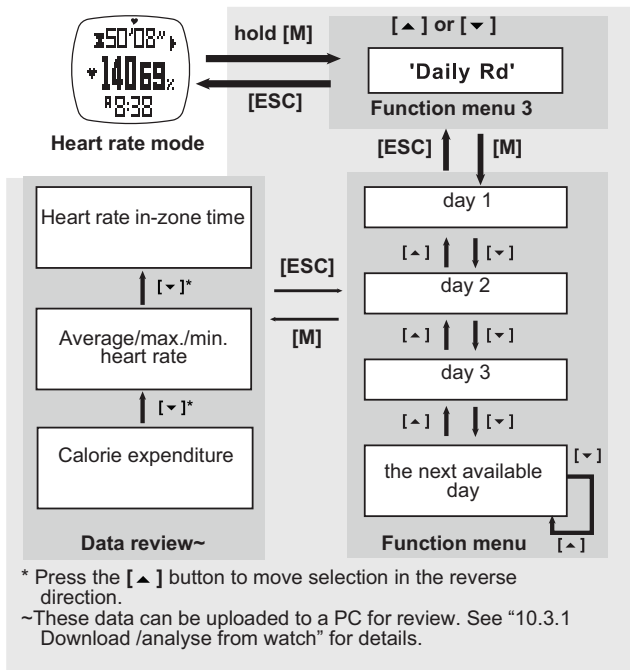



MENU 4: Zone

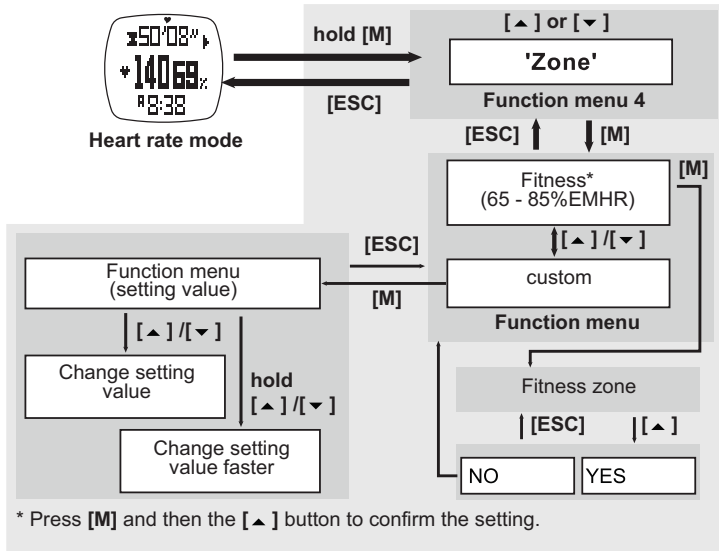

8.2.11 Logbook functions menu

To enter the log menu (**LOG**) the watch has to be in Heart rate mode (See also “8.1 Timekeeping menu items” how to enter this mode.

- Menu 1: **View** To recall the details of the logged session.
- Menu 2: **Start/Stop** To start or stop the data logging function.
- Menu 3: **PC-link** To pair the watch with the ‘Wireless Data Manager’ program and to upload data from the watch to PC. See “10.2 Pairing the watch and chest with the dongle” and “10.3 Download/analyse and save data from watch”.
- Menu 4: **Log Rate** To set the sampling rate for the data logging.
- Menu 5: **Auto** To set the auto-start log function.
- Menu 6: **Erase** To erase the logged session.
- Menu 7: **Mem** To view the free memory capacity.

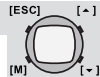

Press and hold the **[M]** key to enter the **LOG** menu:

MENU 1: View

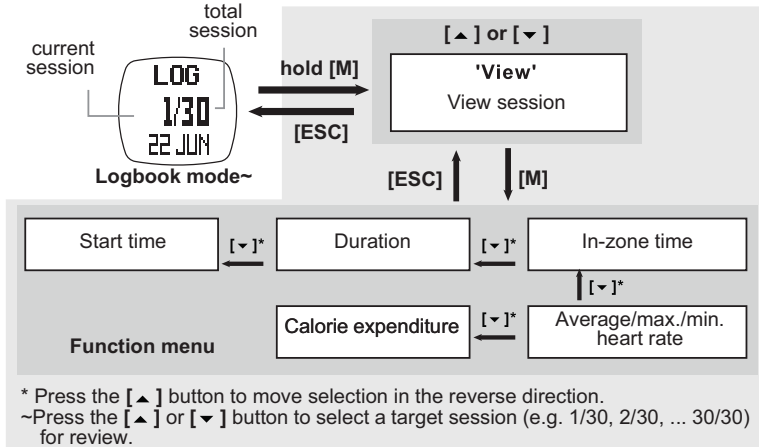

MENU 2: Start/stop (Start/stop the log book)

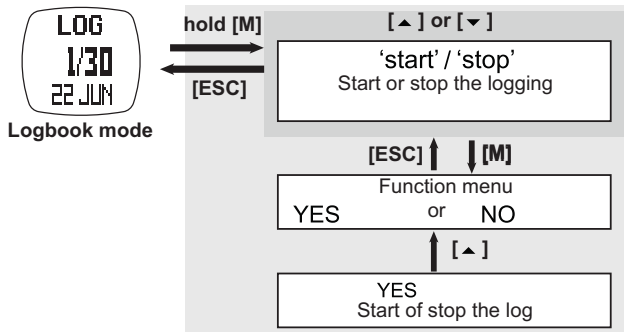



MENU 3: PC-Link

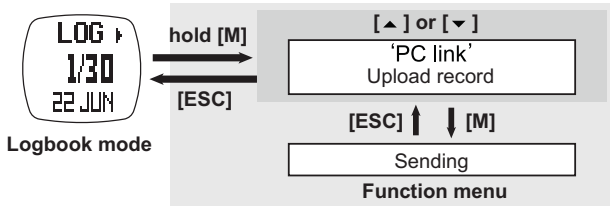

See also “10.3.1 Download /analyse from watch”.

MENU 4: Log Rate

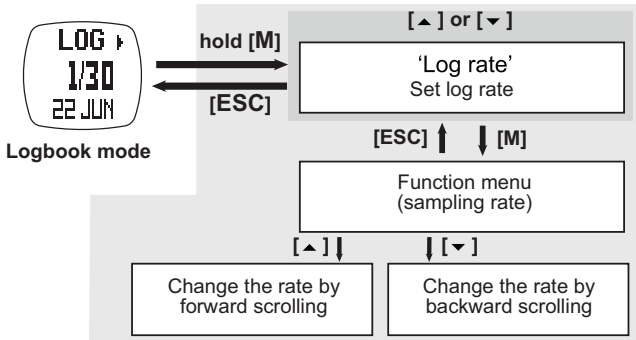

MENU 5: Auto

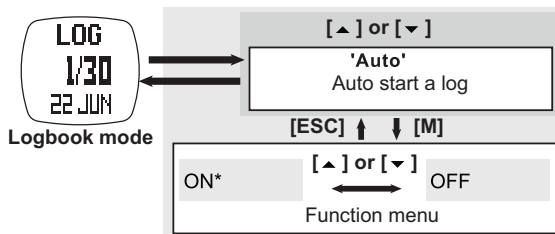

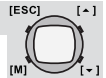

MENU 6: Erase (Erase one/all session(s))

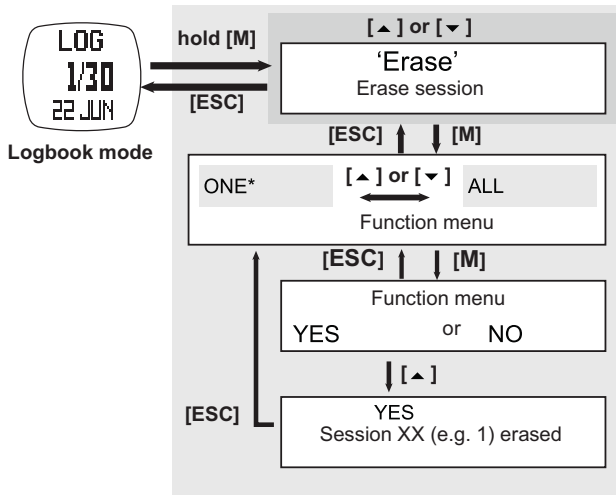

MENU 7: Mem (View free memory)

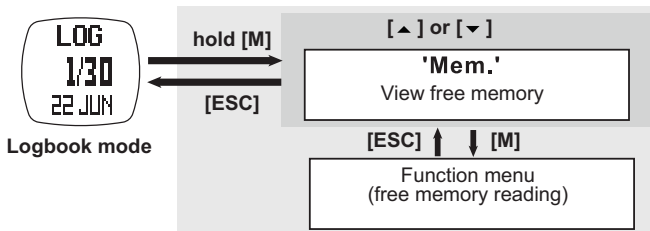



9 BATTERY LOW INDICATION



See “4 Changing the battery”.

10 WIRELESS DATA MANAGER

With the wireless data manager program you can download the daily record and session data from the watch to the PC or from the chest belt directly to the PC. With the data stored on the PC, you can transfer it to programs like SportTracks, Perfect Session, ...

10.1 INSTALLING THE SOFTWARE

1. Insert the bundled CD into the CD drive of the target PC. The menu will show automatically. If not, open the CD folder and double click '**CD_start.exe**'.

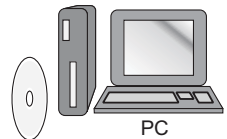

2. Click the '**Install Software**' button from the side menu.

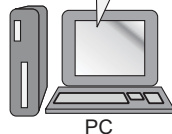

3. Follow the instructions to install the program into the target PC.



4. Reboot your PC after installation and plug-in the USB dongle into a free USB port.

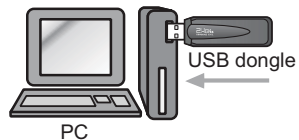

5. After rebooting, Windows will install the proper USB device for the USB dongle.



10.2 PAIRING THE WATCH AND CHEST WITH THE DONGLE

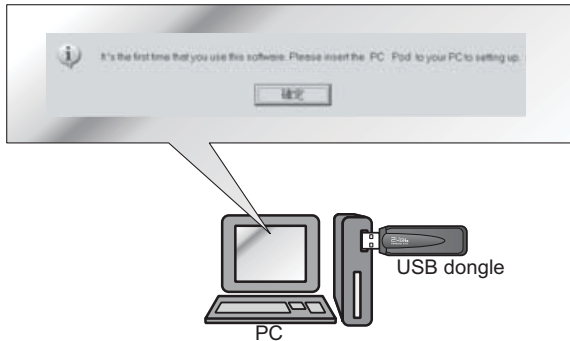

Note:

- The watch **MUST** be switched to '**PC-Link**' display of the logbook mode, and activate the PC-link function.
 - The chest strap **MUST** be worn on the chest or press the two contacts. (See "8.2.11 Logbook functions menu" under "MENU 3: PC-Link".)
1. When the installation is completed. Execute the 'Wireless Data Manager' program from the Windows program menu bar.
 2. The wizard will guide you to pair the watch, chest strap with the program.
 3. When the pairing is done the ID of the watch, chest strap will be saved into the program.



For some instance, the watch and the chest strap can be paired with the program again under the '**Option**' top menu and the '**Setting**' option.

10.3 DOWNLOAD/ANALYSE AND SAVE DATA FROM WATCH



The watch and chest belt must be within 4 meter from the dongle, otherwise the PC dongle may not receive data from the device.

10.3.1 Download /analyse from watch



Note:

- The watch **MUST** be switched to '**PC-Link**' display of the logbook mode, and activate the PC-link function. (See "8.2.11 Logbook functions menu" under "MENU 3: PC-Link".)
1. Click the '**Watch**' icon from the side menu to pop the 'Watch' page.
 2. Select the '**Chronograph**', '**Logbook**' or '**Daily Stat**' page from the top menu.
 3. Click '**Download**' button to download the data from the watch through the corresponding page. The respective data will be shown on the screen after a while.
 4. Analyze the data on the PC by the options provided by the program. Save the data into PC for further analysis.

10.3.2 Real-time data from the chest strap

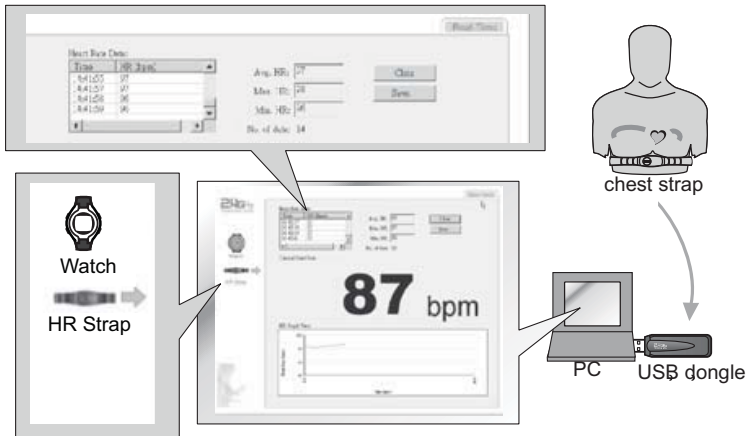

Note:

- This is functioned with the chest strap.
- The heart rate chest strap **MUST** be worn on the chest (i.e. heart rate signal is sampling).

1. Click the '**HR Strap**' icon from the side menu to pop the '**Chest Strap**' page.
2. The real-time heart rate readings will be shown on that page.
3. Analyze the data on the PC by the options provided by the program.
4. Save the data into PC for further analysis.

11 SPECIFICATIONS

Time

- Normal Time with month, day, day of week, hour, minute and second display
- 12/24 hour format selectable
- Calendar range: 2000 to 2099
- Hourly Chime



Alarm

- Two independent alarms with daily and weekly selection.
- 30 seconds alarm duration

Chronograph

- Up to 99H59M59.99S, 1/100s resolution
- 50 laps with recall function

Count Down Timer

- Count down timer up to 99H59M59S, 1 second resolution
- Five pre-defined value (3/5/10/15/45 min)
- One user-defined value from 00:00:00 to 99:59:59

Pacer

- Range: 30 to 180 bpm (beep per minute)
- 5 bpm per step
- Maximum count up to 999999

2.4 GHz Wireless Communication

- Wireless communication using 2.4 GHz ISM band
- Carrier: 2.45 GHz
- Modulation: FSK
- Comply with EN300440, EN301489 and FCC Part 15
- Communication Distance: > 4 meters in open area, direct line of sight

2.4 GHz Heart Rate Measurement

- Measuring Range: 40 to 240 BPM
- Heart rate alert
- Heart Rate In-zone timer 00:00:00 to 23:59:59
- 1 Exercise Timer
- 2 Heart rate zone limit selection
- Calorie Expenditure range: 0-99999 kcal

Daily Records and Logbook

- 10 statistical daily records
- Logbook up to 100 sessions, ~ 30000 records

Others

- Full matrix (~ 32 x 46 dot) LCD
- LCD level adjustable: 16 contrast level adjustments
- Electro-Luminescent (EL) back light



System requirement PC

- Pentium II 300MHz or higher
- 128MB free memory
- 20MB hard disk space or more
- Window XP/Vista operation system
- CD-ROM drive
- USB port

12 TOPCOM WARRANTY

12.1 WARRANTY PERIOD

The Topcom units have a 24-month warranty period. The warranty period starts on the day the new unit is purchased. There is no warranty on standard or rechargeable batteries (AA/AAA type). Consumables or defects causing a negligible effect on operation or value of the equipment are not covered. The warranty has to be proven by presentation of the original or copy of the purchase receipt, on which the date of purchase and the unit-model are indicated.

12.2 WARRANTY HANDLING

A faulty unit needs to be returned to a Topcom service centre including a valid purchase note and a filled in service return card. If the unit develops a fault during the warranty period, Topcom or its officially appointed service center will repair any defects caused by material or manufacturing faults free of charge, by either repairing or exchanging the faulty units or parts of the faulty units. In case of replacement, colour and model can be different from the original purchased unit. The initial purchase date shall determine the start of the warranty period. The warranty period is not extended if the unit is exchanged or repaired by Topcom or its appointed service centre.

12.3 WARRANTY EXCLUSIONS

Damage or defects caused by incorrect treatment or operation and damage resulting from use of non-original parts or accessories are not covered by the warranty. The warranty does not cover damage caused by outside factors, such as lightning, water and fire, nor any damage caused during transportation. No warranty can be claimed if the serial number on the units has been changed, removed or rendered illegible. Any warranty claims will be invalid if the unit has been repaired, altered or modified by the buyer.

SERVICE RETURN CARD - RÜCKSENDEKARTE -
CARTE DE RETOUR SERVICE - RETOURFICHE

RETURN WITH YOUR DEFECT PRODUCT

Name/Vorname/Prénom/Naam:

Surname/Familiennaam/Nom/Familiennaam:

Street/Straße/Rue/Straat:

Nr./N°:

Box/Postfach/Boîte/Postbus:

Location/Ort./Lieu/Plaats:

Post code/Postleitzahl/Code Postal/Postcode:

Country/Land/Pays/Land:

Tel./Tél.:

E-mail:

Model name/Modellbezeichnung/Nom du modèle/Modelnaam:

Serial Nr./Seriennummer/N° série/Seriennummer:

Purchase date/Kaufdatum/Date d'achat/Aankoopdatum:

 (DD/MM/YYYY) - (TT/MM/JJJJ)

Fault description/Beschreibung des Defekts/Description de la panne/Beschrijving defect:

(Original Proof of Purchase has to be attached to this return card to be valid for warranty)

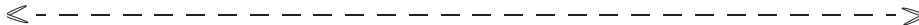

Model name/Modellbezeichnung/Nom du modèle/Modelnaam:

Serial Nr./Seriennummer/N° série/Seriennummer:

Purchase date/Kaufdatum/Date d'achat/Aankoopdatum:

 (DD/MM/YYYY) - (TT/MM/JJJJ)

Fault description/Beschreibung des Defekts/Description de la panne/Beschrijving defect:

TOPCOM[®]

**visit our website
www.topcom.net**

Free Manuals Download Website

<http://myh66.com>

<http://usermanuals.us>

<http://www.somanuals.com>

<http://www.4manuals.cc>

<http://www.manual-lib.com>

<http://www.404manual.com>

<http://www.luxmanual.com>

<http://aubethermostatmanual.com>

Golf course search by state

<http://golfingnear.com>

Email search by domain

<http://emailbydomain.com>

Auto manuals search

<http://auto.somanuals.com>

TV manuals search

<http://tv.somanuals.com>