

# TOSHIBA

FILE NO. A11-016

## SERVICE MANUAL

# AIR-CONDITIONER (SPLIT TYPE)

**OUTDOOR UNIT**  
< DIGITAL INVERTER >

# ***RAV-SM1103AT-E1***

# ***RAV-SM1403AT-E1***

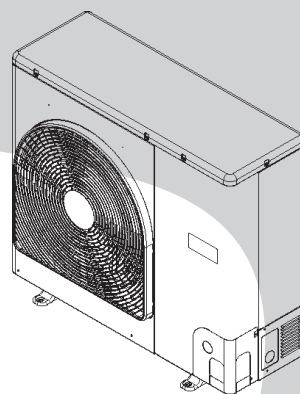

PRINTED IN JAPAN, Jan., 2012 

# CONTENTS

|   |    |
|---|----|
| Precaution for Safety .....                                       | 6  |
| New Refrigerant (R410A) .....                                     | 11 |
| 1. SPECIFICATIONS .....   | 13 |
| 1-1. Outdoor Unit .....   | 13 |
| 1-2. Characteristic Curve .....                                   | 14 |
| 2. CONSTRUCTION VIEWS (EXTERNAL VIEWS) .....                      | 15 |
| 3. REFRIGERATING CYCLE DIAGRAM .....                              | 17 |
| 4. WIRING DIAGRAM .....   | 19 |
| 5. SPECIFICATIONS OF ELECTRICAL PARTS .....                       | 20 |
| 6. REFRIGERANT R410A .....  | 21 |
| 6-1. Safety During Installation/Serviceing .....                  | 21 |
| 6-2. Refrigerant Piping Installation .....                        | 21 |
| 6-3. Tools .....  | 25 |
| 6-4. Recharging of Refrigerant .....                              | 25 |
| 6-5. Brazing of Pipes .....                                       | 26 |
| 6-6. Instructions for Re-use Piping of R22 or R407C .....         | 28 |
| 7. CIRCUIT CONFIGURATION AND CONTROL SPECIFICATIONS .....         | 31 |
| 7-1. Outdoor Unit Control .....                                   | 31 |
| 7-2. Outline of Main Controls .....                               | 32 |
| 8. TROUBLESHOOTING .....  | 37 |
| 8-1. Summary of Troubleshooting .....                             | 37 |
| 8-2. Troubleshooting .....  | 39 |
| 9. SETUP AT LOCAL SITE AND OTHERS .....                           | 63 |
| 9-1. Calling of Error History .....                               | 63 |
| 9-2. Group Control Operation .....                                | 63 |
| 9-3. Outdoor Unit .....   | 65 |
| 9-4. Applicable Control of Outdoor Unit .....                     | 72 |
| 10. ADDRESS SETUP .....   | 73 |
| 10-1. Address Setup Procedure .....                               | 73 |
| 10-2. Address Setup & Group Control .....                         | 74 |
| 10-3. Remote Controller Wiring .....                              | 77 |
| 10-4. Address Setup (Manual setting from remote controller) ..... | 77 |
| 10-5. Confirmation of Indoor Unit No. Position .....              | 78 |
| 11. REPLACEMENT OF THE SERVICE P.C. BOARD MCC-1630 .....          | 80 |
| 12. HOW TO EXCHANGE COMPRESSOR .....                              | 81 |
| 12-1. Exchanging Procedure of Compressor (Outline) .....          | 81 |
| 12-2. Exchange of Compressor .....                                | 81 |
| 13. DETACHMENTS .....   | 82 |
| 14. EXPLODED VIEWS AND PARTS LIST .....                           | 90 |

# Original instruction

Please read carefully through these instructions that contain important information which complies with the “Machinery” Directive (Directive 2006/42/EC), and ensure that you understand them.

## Generic Denomination: Air Conditioner

### Definition of Qualified Installer or Qualified Service Person

The air conditioner must be installed, maintained, repaired and removed by a qualified installer or qualified service person.

When any of these jobs is to be done, ask a qualified installer or qualified service person to do them for you.

A qualified installer or qualified service person is an agent who has the qualifications and knowledge described in the table below.

| Agent                         | Qualifications and knowledge which the agent must have   |
|-------------------------------|--|
| Qualified installer (*1)      | <ul style="list-style-type: none"> <li>• The qualified installer is a person who installs, maintains, relocates and removes the air conditioners made by Toshiba Carrier Corporation.<br/>He or she has been trained to install, maintain, relocate and remove the air conditioners made by Toshiba Carrier Corporation or, alternatively, he or she has been instructed in such operations by an individual or individuals who have been trained and is thus thoroughly acquainted with the knowledge related to these operations.</li> <li>• The qualified installer who is allowed to do the electrical work involved in installation, relocation and removal has the qualifications pertaining to this electrical work as stipulated by the local laws and regulations, and he or she is a person who has been trained in matters relating to electrical work on the air conditioners made by Toshiba Carrier Corporation or, alternatively, he or she has been instructed in such matters by an individual or individuals who have been trained and is thus thoroughly acquainted with the knowledge related to this work.</li> <li>• The qualified installer who is allowed to do the refrigerant handling and piping work involved in installation, relocation and removal has the qualifications pertaining to this refrigerant handling and piping work as stipulated by the local laws and regulations, and he or she is a person who has been trained in matters relating to refrigerant handling and piping work on the air conditioners made by Toshiba Carrier Corporation or, alternatively, he or she has been instructed in such matters by an individual or individuals who have been trained and is thus thoroughly acquainted with the knowledge related to this work.</li> <li>• The qualified installer who is allowed to work at heights has been trained in matters relating to working at heights with the air conditioners made by Toshiba Carrier Corporation or, alternatively, he or she has been instructed in such matters by an individual or individuals who have been trained and is thus thoroughly acquainted with the knowledge related to this work.</li> </ul>  |
| Qualified service person (*1) | <ul style="list-style-type: none"> <li>• The qualified service person is a person who installs, repairs, maintains, relocates and removes the air conditioners made by Toshiba Carrier Corporation. He or she has been trained to install, repair, maintain, relocate and remove the air conditioners made by Toshiba Carrier Corporation or, alternatively, he or she has been instructed in such operations by an individual or individuals who have been trained and is thus thoroughly acquainted with the knowledge related to these operations.</li> <li>• The qualified service person who is allowed to do the electrical work involved in installation, repair, relocation and removal has the qualifications pertaining to this electrical work as stipulated by the local laws and regulations, and he or she is a person who has been trained in matters relating to electrical work on the air conditioners made by Toshiba Carrier Corporation or, alternatively, he or she has been instructed in such matters by an individual or individuals who have been trained and is thus thoroughly acquainted with the knowledge related to this work.</li> <li>• The qualified service person who is allowed to do the refrigerant handling and piping work involved in installation, repair, relocation and removal has the qualifications pertaining to this refrigerant handling and piping work as stipulated by the local laws and regulations, and he or she is a person who has been trained in matters relating to refrigerant handling and piping work on the air conditioners made by Toshiba Carrier Corporation or, alternatively, he or she has been instructed in such matters by an individual or individuals who have been trained and is thus thoroughly acquainted with the knowledge related to this work.</li> <li>• The qualified service person who is allowed to work at heights has been trained in matters relating to working at heights with the air conditioners made by Toshiba Carrier Corporation or, alternatively, he or she has been instructed in such matters by an individual or individuals who have been trained and is thus thoroughly acquainted with the knowledge related to this work.</li> </ul> |

## Definition of Protective Gear

When the air conditioner is to be transported, installed, maintained, repaired or removed, wear protective gloves and 'safety' work clothing.



In addition to such normal protective gear, wear the protective gear described below when undertaking the special work detailed in the table below.

Failure to wear the proper protective gear is dangerous because you will be more susceptible to injury, burns, electric shocks and other injuries.

| Work undertaken                      | Protective gear worn  |
|--------------------------------------|---|
| All types of work                    | Protective gloves<br>"Safety" working clothing  |
| Electrical-related work              | Gloves to provide protection for electricians and from heat<br>Insulating shoes<br>Clothing to provide protection from electric shock |
| Work done at heights (50 cm or more) | Helmets for use in industry   |
| Transportation of heavy objects      | Shoes with additional protective toe cap  |
| Repair of outdoor unit               | Gloves to provide protection for electricians and from heat   |



The important contents concerned to the safety are described on the product itself and on this Service Manual. Please read this Service Manual after understanding the described items thoroughly in the following contents (Indications/Illustrated marks), and keep them.

### [Explanation of indications]

| Indication   | Explanation   |
|--|---|
|  <b>DANGER</b>  | Indicates contents assumed that an imminent danger causing a death or serious injury of the repair engineers and the third parties when an incorrect work has been executed.  |
|  <b>WARNING</b> | Indicates possibilities assumed that a danger causing a death or serious injury of the repair engineers, the third parties, and the users due to troubles of the product after work when an incorrect work has been executed. |
|  <b>CAUTION</b> | Indicates contents assumed that an injury or property damage (*) may be caused on the repair engineers, the third parties, and the users due to troubles of the product after work when an incorrect work has been executed.  |

\* Property damage : Enlarged damage concerned to property, furniture, and domestic animal/pet





### [Explanation of illustrated marks]

| Mark  | Explanation  |
|---|--|
|  | Indicates prohibited items (Forbidden items to do)<br>The sentences near an illustrated mark describe the concrete prohibited contents.                |
|  | Indicates mandatory items (Compulsory items to do)<br>The sentences near an illustrated mark describe the concrete mandatory contents.                 |
|  | Indicates cautions (Including danger/warning)<br>The sentences or illustration near or in an illustrated mark describe the concrete cautious contents. |

# Warning Indications on the Air Conditioner Unit

## [Confirmation of warning label on the main unit]





Confirm that labels are indicated on the specified positions  
 If removing the label during parts replace, stick it as the original.

| Warning indication  | Description    |  |  |
|---|----------------|--|--|
|  <table border="1" data-bbox="169 461 823 701"> <tr> <td data-bbox="309 461 823 546" style="text-align: center;"><b>WARNING</b></td> </tr> <tr> <td data-bbox="309 551 823 701"> <b>ELECTRICAL SHOCK HAZARD</b><br/>                     Disconnect all remote electric power supplies before servicing.                 </td> </tr> </table>  | <b>WARNING</b> | <b>ELECTRICAL SHOCK HAZARD</b><br>Disconnect all remote electric power supplies before servicing.        | <b>WARNING</b><br>ELECTRICAL SHOCK HAZARD<br>Disconnect all remote electric power supplies before servicing.               |
| <b>WARNING</b>  |                |  |  |
| <b>ELECTRICAL SHOCK HAZARD</b><br>Disconnect all remote electric power supplies before servicing.   |                |  |  |
|  <table border="1" data-bbox="169 815 823 1032"> <tr> <td data-bbox="309 815 823 900" style="text-align: center;"><b>WARNING</b></td> </tr> <tr> <td data-bbox="309 904 823 1032">                     Moving parts.<br/>                     Do not operate unit with grille removed.<br/>                     Stop the unit before the servicing.                 </td> </tr> </table> | <b>WARNING</b> | Moving parts.<br>Do not operate unit with grille removed.<br>Stop the unit before the servicing.         | <b>WARNING</b><br>Moving parts.<br>Do not operate unit with grille removed.<br>Stop the unit before the servicing.         |
| <b>WARNING</b>  |                |  |  |
| Moving parts.<br>Do not operate unit with grille removed.<br>Stop the unit before the servicing.  |                |  |  |
|  <table border="1" data-bbox="169 1155 823 1373"> <tr> <td data-bbox="309 1155 823 1240" style="text-align: center;"><b>CAUTION</b></td> </tr> <tr> <td data-bbox="309 1245 823 1373">                     High temperature parts.<br/>                     You might get burned when removing this panel.                 </td> </tr> </table>  | <b>CAUTION</b> | High temperature parts.<br>You might get burned when removing this panel.                                | <b>CAUTION</b><br>High temperature parts.<br>You might get burned when removing this panel.                                |
| <b>CAUTION</b>  |                |  |  |
| High temperature parts.<br>You might get burned when removing this panel.   |                |  |  |
|  <table border="1" data-bbox="169 1476 823 1666"> <tr> <td data-bbox="309 1476 823 1561" style="text-align: center;"><b>CAUTION</b></td> </tr> <tr> <td data-bbox="309 1565 823 1666">                     Do not touch the aluminum fins of the unit.<br/>                     Doing so may result in injury.                 </td> </tr> </table>                                    | <b>CAUTION</b> | Do not touch the aluminum fins of the unit.<br>Doing so may result in injury.                            | <b>CAUTION</b><br>Do not touch the aluminum fins of the unit.<br>Doing so may result in injury.                            |
| <b>CAUTION</b>  |                |  |  |
| Do not touch the aluminum fins of the unit.<br>Doing so may result in injury.   |                |  |  |
|  <table border="1" data-bbox="169 1783 823 2040"> <tr> <td data-bbox="309 1783 823 1868" style="text-align: center;"><b>CAUTION</b></td> </tr> <tr> <td data-bbox="309 1872 823 2040"> <b>BURST HAZARD</b><br/>                     Open the service valves before the operation, otherwise there might be the burst.                 </td> </tr> </table>                             | <b>CAUTION</b> | <b>BURST HAZARD</b><br>Open the service valves before the operation, otherwise there might be the burst. | <b>CAUTION</b><br><b>BURST HAZARD</b><br>Open the service valves before the operation, otherwise there might be the burst. |
| <b>CAUTION</b>  |                |  |  |
| <b>BURST HAZARD</b><br>Open the service valves before the operation, otherwise there might be the burst.  |                |  |  |

# Precaution for Safety

The manufacturer shall not assume any liability for the damage caused by not observing the description of this manual.







## DANGER





|   |   |
|---|---|
| <br>Turn off breaker.                      | <p>Before carrying out the installation, maintenance, repair or removal work, be sure to set the circuit breaker to the OFF position. Otherwise, electric shocks may result.</p>  |
|   | <p>Before opening the intake grille of the indoor unit or service panel of the outdoor unit, set the circuit breaker to the OFF position. Failure to set the circuit breaker to the OFF position may result in electric shocks through contact with the interior parts. Only a qualified installer (*1) or qualified service person (*1) is allowed to remove the intake grille of the indoor unit or service panel of the outdoor unit and do the work required.</p>   |
|   | <p>Before starting to repair the outdoor unit fan or fan guard, be absolutely sure to set the circuit breaker to the OFF position, and place a "Work in progress" sign on the circuit breaker before proceeding with the work.</p>  |
|   | <p>When cleaning the filter or other parts of the indoor unit, set the circuit breaker to OFF without fail, and place a "Work in progress" sign near the circuit breaker before proceeding with the work.</p>   |
| <br>Electric shock hazard                  | <p>When you access inside of the service panel to repair electric parts, wait for about five minutes after turning off the breaker. Do not start repairing immediately. Otherwise you may get electric shock by touching terminals of high-voltage capacitors. Natural discharge of the capacitor takes about five minutes.</p>   |
|   | <p>Before operating the air conditioner after having completed the work, check that the electrical parts box cover of the indoor unit and service panel of the outdoor unit are closed, and set the circuit breaker to the ON position. You may receive an electric shock etc. if the power is turned on without first conducting these checks.</p>   |
| <br>Execute discharge between terminals. | <p>Even if the circuit breaker has been set to the OFF position before the service panel is removed and the electrical parts are repaired, you will still risk receiving an electric shock. For this reason, short-circuit the high-voltage capacitor terminals to discharge the voltage before proceeding with the repair work. For details on the short-circuiting procedure, refer to the Service Manual. You may receive an electric shock if the voltage stored in the capacitors has not been sufficiently discharged.</p>  |
| <br>Prohibition                          | <p>Place a "Work in progress" sign near the circuit breaker while the installation, maintenance, repair or removal work is being carried out. There is a danger of electric shocks if the circuit breaker is set to ON by mistake.</p>  |
|   | <p>When checking the electric parts, removing the cover of the electric parts box of Indoor Unit and/or front panel of Outdoor Unit inevitably to determine the failure, put a sign "Do not enter" around the site before the work. Failure to do this may result in third person getting electric shock.</p>   |
| <br>Stay on protection                   | <p>If, in the course of carrying out repairs, it becomes absolutely necessary to check out the electrical parts with the electrical parts box cover of one or more of the indoor units and the service panel of the outdoor unit removed in order to find out exactly where the trouble lies, wear insulated heat-resistant gloves, insulated boots and insulated work overalls, and take care to avoid touching any live parts. You may receive an electric shock if you fail to heed this warning. Only qualified service person (*1) is allowed to do this kind of work.</p> |

## WARNING





|  |  |
|--|--|
| <br>General | <p>Before starting to repair the air conditioner, read carefully through the Service Manual, and repair the air conditioner by following its instructions.</p>   |
|  | <p>Only qualified service person (*1) is allowed to repair the air conditioner. Repair of the air conditioner by unqualified person may give rise to a fire, electric shocks, injury, water leaks and/or other problems.</p>   |
|  | <p>Only a qualified installer (*1) or qualified service person (*1) is allowed to carry out the electrical work of the air conditioner. Under no circumstances must this work be done by an unqualified individual since failure to carry out the work properly may result in electric shocks and/or electrical leaks.</p> |
|  | <p>Wear protective gloves and safety work clothing during installation, servicing and removal.</p>   |
|  | <p>Use wiring that meets the specifications in the Installation Manual and the stipulations in the local regulations and laws. Use of wiring which does not meet the specifications may give rise to electric shocks, electrical leakage, smoking and/or a fire.</p>   |

## WARNING

|   |  |
|---|--|
| <br>General  | The appliance shall be installed in accordance with national wiring regulations. Capacity shortages of the power circuit or an incomplete installation may cause an electric shock or fire.  |
|   | Only a qualified installer (*1) or qualified service person (*1) is allowed to undertake work at heights using a stand of 50 cm or more or to remove the intake grille of the indoor unit to undertake work.   |
|   | When working at heights, use a ladder which complies with the ISO 14122 standard, and follow the procedure in the ladder's instructions. Also wear a helmet for use in industry as protective gear to undertake the work.  |
|   | When working at heights, put a sign in place so that no-one will approach the work location, before proceeding with the work. Parts and other objects may fall from above, possibly injuring a person below.   |
|   | Do not touch the aluminum fin of the outdoor unit. You may injure yourself if you do so. If the fin must be touched for some reason, first put on protective gloves and safety work clothing, and then proceed.  |
|   | Use forklift to carry in the air conditioner units and use winch or hoist at installation of them.   |
|   | Do not climb onto or place objects on top of the outdoor unit. You may fall or the objects may fall off of the outdoor unit and result in injury.  |
|   | When transporting the air conditioner, wear shoes with additional protective toe caps.   |
|   | When transporting the air conditioner, do not take hold of the bands around the packing carton. You may injure yourself if the bands should break.   |
|   | When transporting the air conditioner, use a forklift and when moving the air conditioner by hand, move the unit with 4 people.  |
| Do not customize the product. Doing so may result in electric shock or other failure.   |  |
| This air conditioner has passed the pressure test as specified in IEC 60335-2-40 Annex EE.  |  |
| <br>Check earth wires.                            | Before troubleshooting or repair work, check the earth wire is connected to the earth terminals of the main unit, otherwise an electric shock is caused when a leak occurs. If the earth wire is not correctly connected, contact an electric engineer for rework.   |
|   | After completing the repair or relocation work, check that the ground wires are connected properly.  |
|   | Be sure to connect earth wire. (Grounding work) Incomplete grounding causes an electric shock. Do not connect ground wires to gas pipes, water pipes, and lightning rods or ground wires for telephone wires.  |
| <br>Prohibition of modification.                 | Do not modify the products. Do not also disassemble or modify the parts. It may cause a fire, electric shock or injury.  |
| <br>Use specified parts.                         | When any of the electrical parts are to be replaced, ensure that the replacement parts satisfy the specifications given in the Service Manual (or use the parts contained on the parts list in the Service Manual). Use of any parts which do not satisfy the required specifications may give rise to electric shocks, smoking and/or a fire.   |
| <br>Do not bring a child close to the equipment. | If, in the course of carrying out repairs, it becomes absolutely necessary to check out the electrical parts with the electrical parts box cover of one or more of the indoor units and the service panel of the outdoor unit removed in order to find out exactly where the trouble lies, place "Keep out" signs around the work site before proceeding. Third-party individuals may enter the work site and receive electric shocks if this warning is not heeded.   |
| <br>Insulating measures                          | Connect the cut-off lead wires with crimp contact, etc, put the closed end side upward and then apply a water-cut method, otherwise a leak or production of fire is caused at the users' side.   |
| <br>No fire                                      | <p>When performing repairs using a gas burner, replace the refrigerant with nitrogen gas because the oil that coats the pipes may otherwise burn. When repairing the refrigerating cycle, take the following measures.</p> <ol style="list-style-type: none"> <li>1) Be attentive to fire around the cycle.<br/>When using a gas stove, etc, be sure to put out fire before work; otherwise the oil mixed with refrigerant gas may catch fire.</li> <li>2) Do not use a welder in the closed room. When using it without ventilation, carbon monoxide poisoning may be caused.</li> <li>3) Do not bring inflammables close to the refrigerant cycle, otherwise fire of the welder may catch the inflammables.</li> </ol> |

|  |   |
|--|---|
| <br><b>Refrigerant</b>            | <p>The refrigerant used by this air conditioner is the R410A.</p>   |
|  | <p>Check the used refrigerant name and use tools and materials of the parts which match with it. For the products which use R410A refrigerant, the refrigerant name is indicated at a position on the outdoor unit where is easy to see. To prevent miss-charging, the route of the service port is changed from one of the former R22.</p>   |
|  | <p>Do not use any refrigerant different from the one specified for complement or replacement. Otherwise, abnormally high pressure may be generated in the refrigeration cycle, which may result in a failure or explosion of the product or an injury to your body.</p>   |
|  | <p>For an air conditioner which uses R410A, never use other refrigerant than R410A.<br/>For an air conditioner which uses other refrigerant (R22, etc.), never use R410A.<br/>If different types of refrigerant are mixed, abnormal high pressure generates in the refrigerating cycle and an injury due to breakage may be caused.</p>   |
|  | <p>Do not charge refrigerant additionally. If charging refrigerant additionally when refrigerant gas leaks, the refrigerant composition in the refrigerating cycle changes resulted in change of air conditioner characteristics or refrigerant over the specified standard amount is charged and an abnormal high pressure is applied to the inside of the refrigerating cycle resulted in cause of breakage or injury. Therefore if the refrigerant gas leaks, recover the refrigerant in the air conditioner, execute vacuuming, and then newly recharge the specified amount of liquid refrigerant. In this time, never charge the refrigerant over the specified amount.</p>   |
|  | <p>When recharging the refrigerant in the refrigerating cycle, do not mix the refrigerant or air other than R410A into the specified refrigerant. If air or others is mixed with the refrigerant, abnormal high pressure generates in the refrigerating cycle resulted in cause of injury due to breakage.</p>  |
|  | <p>After installation work, check the refrigerant gas does not leak. If the refrigerant gas leaks in the room, poisonous gas generates when gas touches to fire such as fan heater, stove or cooking stove though the refrigerant gas itself is innocuous.</p> <p>Never recover the refrigerant into the outdoor unit. When the equipment is moved or repaired, be sure to recover the refrigerant with recovering device. The refrigerant cannot be recovered in the outdoor unit; otherwise a serious accident such as breakage or injury is caused.</p>  |
| <br><b>Assembly/<br/>Cabling</b> | <p>After repair work, surely assemble the disassembled parts, and connect and lead the removed wires as before. Perform the work so that the cabinet or panel does not catch the inner wires. If incorrect assembly or incorrect wire connection was done, a disaster such as a leak or fire is caused at user's side.</p>  |
| <br><b>Insulator check</b>      | <p>After the work has finished, be sure to use an insulation tester set (500V Megger) to check the resistance is 1MΩ or more between the charge section and the non-charge metal section (Earth position). If the resistance value is low, a disaster such as a leak or electric shock is caused at user's side.</p>  |
| <br><b>Ventilation</b>          | <p>When the refrigerant gas leaks during work, execute ventilation. If the refrigerant gas touches to a fire, poisonous gas generates. A case of leakage of the refrigerant and the closed room full with gas is dangerous because a shortage of oxygen occurs. Be sure to execute ventilation.</p>   |
|  | <p>If refrigerant gas has leaked during the installation work, ventilate the room immediately. If the leaked refrigerant gas comes in contact with fire, noxious gas may be generated.</p>  |
|  | <p>After the installation or servicing work, confirm that refrigerant gas does not leak. If refrigerant gas leaks into the room and flows near a fire source, such as a cooking range, noxious gas may be generated.</p>  |
| <br><b>Compulsion</b>           | <p>When the refrigerant gas leaks, find up the leaked position and repair it surely. If the leaked position cannot be found up and the repair work is interrupted, pump-down and tighten the service valve, otherwise the refrigerant gas may leak into the room. The poisonous gas generates when gas touches to fire such as fan heater, stove or cooking stove though the refrigerant gas itself is innocuous. When installing equipment which includes a large amount of charged refrigerant such as a multi air conditioner in a sub-room, it is necessary that the density does not the limit even if the refrigerant leaks. If the refrigerant leaks and exceeds the limit density, an accident of shortage of oxygen is caused.</p> |
|  | <p>Tighten the flare nut with a torque wrench in the specified manner. Excessive tighten of the flare nut may cause a crack in the flare nut after a long period, which may result in refrigerant leakage.</p>  |
|  | <p>Nitrogen gas must be used for the airtight test.</p>   |
|  | <p>The charge hose must be connected in such a way that it is not slack.</p> <p>For the installation/moving/reinstallation work, follow to the Installation Manual. If an incorrect installation is done, a trouble of the refrigerating cycle, water leak, electric shock or fire is caused.</p>   |



|  |   |
|--|---|
| <br>Check after repair  | Once the repair work has been completed, check for refrigerant leaks, and check the insulation resistance and water drainage. Then perform a trial run to check that the air conditioner is running properly.   |
|  | After repair work has finished, check there is no trouble. If check is not executed, a fire, electric shock or injury may be caused. For a check, turn off the power breaker.   |
|  | After repair work (installation of front panel and cabinet) has finished, execute a test run to check there is no generation of smoke or abnormal sound. If check is not executed, a fire or an electric shock is caused. Before test run, install the front panel and cabinet.   |
| <br>Do not operate the unit with the valve closed.                        | Check the following matters before a test run after repairing piping. <ul style="list-style-type: none"> <li>• Connect the pipes surely and there is no leak of refrigerant.</li> <li>• The valve is opened.</li> </ul> Running the compressor under condition that the valve closes causes an abnormal high pressure resulted in damage of the parts of the compressor and etc. and moreover if there is leak of refrigerant at connecting section of pipes, the air is suctioned and causes further abnormal high pressure resulted in burst or injury.   |
| <br>Check after reinstallation  | Only a qualified installer (*1) or qualified service person (*1) is allowed to relocate the air conditioner. It is dangerous for the air conditioner to be relocated by an unqualified individual since a fire, electric shocks, injury, water leakage, noise and/or vibration may result.  |
|  | Check the following items after reinstallation. <ol style="list-style-type: none"> <li>1) The earth wire is correctly connected.</li> <li>2) The power cord is not caught in the product.</li> <li>3) There is no inclination or unsteadiness and the installation is stable.</li> </ol> If check is not executed, a fire, an electric shock or an injury is caused.  |
| <br>Cooling check   | When carrying out the pump-down work shut down the compressor before disconnecting the refrigerant pipe. Disconnecting the refrigerant pipe with the service valve left open and the compressor still operating will cause air, etc. to be sucked in, raising the pressure inside the refrigeration cycle to an abnormally high level, and possibly resulting in reputeing, injury, etc.  |
|  | When the service panel of the outdoor unit is to be opened in order for the compressor or the area around this part to be repaired immediately after the air conditioner has been shut down, set the circuit breaker to the OFF position, and then wait at least 10 minutes before opening the service panel. If you fail to heed this warning, you will run the risk of burning yourself because the compressor pipes and other parts will be very hot to the touch. In addition, before proceeding with the repair work, wear the heat-resistant gloves.  |
| <br>Installation  | When the service panel of the outdoor unit is to be opened in order for the fan motor, reactor, inverter or the areas around these parts to be repaired immediately after the air conditioner has been shut down, set the circuit breaker to the OFF position, and then wait at least 10 minutes before opening the service panel. If you fail to heed this warning, you will run the risk of burning yourself because the fan motor, reactor, inverter heat sink and other parts will be very hot to the touch. In addition, before proceeding with the repair work, wear the heat-resistant gloves. |
|  | Only a qualified installer (*1) or qualified service person (*1) is allowed to install the air conditioner. If the air conditioner is installed by an unqualified individual, a fire, electric shocks, injury, water leakage, noise and/or vibration may result.  |
|  | Before starting to install the air conditioner, read carefully through the Installation Manual, and follow its instructions to install the air conditioner.   |
|  | Do not install the air conditioner in a location that may be subject to a risk of expire to a combustible gas. If a combustible gas leaks and becomes concentrated around the unit, a fire may occur.   |
|  | Install the indoor unit at least 2.5 m above the floor level since otherwise the users may injure themselves or receive electric shocks if they poke their fingers or other objects into the indoor unit while the air conditioner is running.  |
|  | Install a circuit breaker that meets the specifications in the installation manual and the stipulations in the local regulations and laws.  |
| Install the circuit breaker where it can be easily accessed by the agent.  |   |
| Do not place any combustion appliance in a place where it is directly exposed to the wind of air conditioner, otherwise it may cause imperfect combustion. |   |

## Explanations given to user

- If you have discovered that the fan grille is damaged, do not approach the outdoor unit but set the circuit breaker to the OFF position, and contact a qualified service person to have the repairs done.  
Do not set the circuit breaker to the ON position until the repairs are completed.

## Relocation

- Only a qualified installer (\*1) or qualified service person (\*1) is allowed to relocate the air conditioner.  
It is dangerous for the air conditioner to be relocated by an unqualified individual since a fire, electric shocks, injury, water leakage, noise and/or vibration may result.
- When carrying out the pump-down work shut down the compressor before disconnecting the refrigerant pipe.  
Disconnecting the refrigerant pipe with the service valve left open and the compressor still operating will cause air, etc. to be sucked in, raising the pressure inside the refrigeration cycle to an abnormally high level, and possibly resulting in reputing, injury, etc.

(\*1) Refer to the "Definition of Qualified Installer or Qualified Service Person."

## Declaration of Conformity

Manufacturer: Toshiba Carrier Corporation  
336 Tadehara, Fuji-shi, Shizuoka-ken 416-8521 JAPAN

Authorized Nick Ball

Representative/TCF holder: Toshiba EMEA Engineering Director  
Toshiba Carrier UK Ltd.  
Porsham Close, Belliver Industrial Estate,  
PLYMOUTH, Devon, PL6 7DB.  
United Kingdom

Hereby declares that the machinery described below:

Generic Denomination: Air Conditioner

Model/type: RAV-SM1103AT-E1 RAV-SM1403AT-E1

Commercial name: Digital Inverter Series Air Conditioner

Complies with the provisions of the "Machinery" Directive (Directive 2006/42/EC) and the regulations transposing into national law.

Complies with the provisions of the following harmonized standard:  
EN 378-2: 2008 + A1:2009

**Note:** This declaration becomes invalid if technical or operational modifications are introduced without the manufacturer's consent.

## Disposal

How to dispose of air conditioners with a rating of 12 kW and below in accordance with the 2002/96/EC Directive WEEE (Waste Electrical and Electronic Equipment) is provided in the Installation Manual supplied with your product. For disposal of the product above 12 kW in rating you should use a registered company in accordance with any national or EU legislation.

### <Model names with a rating of 12 kW and below (outdoor units)>

#### DI series

RAV-SM563AT-E RAV-SM803AT-E RAV-SM1103AT-E, RAV-SM1103AT-E1

#### SDI series

|                  |                   |                    |
|------------------|-------------------|--------------------|
| RAV-SP404AT-E    | RAV-SP404ATZ-E    | RAV-SP404ATZG-E    |
| RAV-SP454AT-E    | RAV-SP454ATZ-E    | RAV-SP454ATZG-E    |
| RAV-SP564AT-E    | RAV-SP564ATZ-E    | RAV-SP564ATZG-E    |
| RAV-SP804AT-E    | RAV-SP804ATZ-E    | RAV-SP804ATZG-E    |
| RAV-SP1104AT-E   | RAV-SP1104ATZ-E   | RAV-SP1104ATZG-E   |
| RAV-SP1104AT8-E  | RAV-SP1104AT8Z-E  | RAV-SP1104AT8ZG-E  |
| RAV-SP1104AT8-TR | RAV-SP1104AT8Z-TR | RAV-SP1104AT8ZG-TR |

# New Refrigerant (R410A)

This air conditioner adopts a new HFC type refrigerant (R410A) which does not deplete the ozone layer.

## 1. Safety Caution Concerned to New Refrigerant

The pressure of R410A is high 1.6 times of that of the former refrigerant (R22).

Accompanied with change of refrigerant, the refrigerating oil has been also changed.

Therefore, be sure that water, dust, the former refrigerant or the former refrigerating oil is not mixed into the refrigerating cycle of the air conditioner with new refrigerant during installation work or service work.

If an incorrect work or incorrect service is performed, there is a possibility to cause a serious accident.

Use the tools and materials exclusive to R410A to purpose a safe work.

## 2. Cautions on Installation/Service

- 1) Do not mix the other refrigerant or refrigerating oil.

For the tools exclusive to R410A, shapes of all the joints including the service port differ from those of the former refrigerant in order to prevent mixture of them.

- 2) As the use pressure of the new refrigerant is high, use material thickness of the pipe and tools which are specified for R410A.

- 3) In the installation time, use clean pipe materials and work with great attention so that water and others do not mix in because pipes are affected by impurities such as water, oxide scales, oil, etc.

Use the clean pipes.

Be sure to brazing with flowing nitrogen gas. (Never use gas other than nitrogen gas.)

- 4) For the earth protection, use a vacuum pump for air purge.

- 5) R410A refrigerant is azeotropic mixture type refrigerant.

Therefore use liquid type to charge the refrigerant. (If using gas for charging, composition of the refrigerant changes and then characteristics of the air conditioner change.)

## 3. Pipe Materials

For the refrigerant pipes, copper pipe and joints are mainly used.

It is necessary to select the most appropriate pipes to conform to the standard.

Use clean material in which impurities adhere inside of pipe or joint to a minimum.

### 1) Copper pipe

#### <Piping>

The pipe thickness, flare finishing size, flare nut and others differ according to a refrigerant type.

When using a long copper pipe for R410A, it is recommended to select "Copper or copper-base pipe without seam" and one with bonded oil amount 40mg/10m or less.

Also do not use crushed, deformed, discolored (especially inside) pipes.

(Impurities cause clogging of expansion valves and capillary tubes.)

#### <Flare nut>

Use the flare nuts which are attached to the air conditioner unit.

### 2) Joint

The flare joint and socket joint are used for joints of the copper pipe.

The joints are rarely used for installation of the air conditioner.

However clear impurities when using them.

## 4. Tools

### 1. Required Tools for R410A

Mixing of different types of oil may cause a trouble such as generation of sludge, clogging of capillary, etc. Accordingly, the tools to be used are classified into the following three types.

- 1) Tools exclusive for R410A (Those which cannot be used for conventional refrigerant (R22))
- 2) Tools exclusive for R410A, but can be also used for conventional refrigerant (R22)
- 3) Tools commonly used for R410A and for conventional refrigerant (R22)

The table below shows the tools exclusive for R410A and their interchangeability.

#### Tools exclusive for R410A (The following tools for R410A are required.)

Tools whose specifications are changed for R410A and their interchangeability

| No. | Used tool   | Usage  | R410A<br>air conditioner installation      |   | Conventional air<br>conditioner installation     |
|-----|---|--|--|---|--|
|     |   |  | Existence of<br>new equipment<br>for R410A | Whether conventional<br>equipment can be used | Whether<br>conventional equipment<br>can be used |
| ①   | Flare tool  | Pipe flaring                                       | Yes  | * (Note)                                      | Yes  |
| ②   | Copper pipe gauge<br>for adjusting<br>projection margin | Flaring by<br>conventional flare tool              | Yes  | * (Note)                                      | * (Note)   |
| ③   | Torque wrench   | Tightening of flare nut                            | Yes  | No  | No   |
| ④   | Gauge manifold  | Evacuating, refrigerant<br>charge, run check, etc. | Yes  | No  | No   |
| ⑤   | Charge hose   |  |  |   |  |
| ⑥   | Vacuum pump adapter                                     | Vacuum evacuating                                  | Yes  | No  | Yes  |
| ⑦   | Electronic balance for<br>refrigerant charging          | Refrigerant charge                                 | Yes  | Yes   | Yes  |
| ⑧   | Refrigerant cylinder                                    | Refrigerant charge                                 | Yes  | No  | No   |
| ⑨   | Leakage detector  | Gas leakage check                                  | Yes  | No  | Yes  |

**(Note)** When flaring is carried out for R410A using the conventional flare tools, adjustment of projection margin is necessary. For this adjustment, a copper pipe gauge, etc. are necessary.

#### General tools (Conventional tools can be used.)

In addition to the above exclusive tools, the following equipments which serve also for R22 are necessary as the general tools.

- |   |   |
|---|---|
| <ol style="list-style-type: none"> <li>1) Vacuum pump. Use vacuum pump by attaching vacuum pump adapter.</li> <li>2) Torque wrench</li> <li>3) Pipe cutter</li> <li>4) Reamer</li> <li>5) Pipe bender</li> <li>6) Level vial</li> </ol> | <ol style="list-style-type: none"> <li>7) Screwdriver (+, -)</li> <li>8) Spanner or Monkey wrench</li> <li>9) Hole core drill</li> <li>10) Hexagon wrench (Opposite side 4mm)</li> <li>11) Tape measure</li> <li>12) Metal saw</li> </ol> |
|---|---|

Also prepare the following equipments for other installation method and run check.

- |  |  |
|--|--|
| <ol style="list-style-type: none"> <li>1) Clamp meter</li> <li>2) Thermometer</li> </ol> | <ol style="list-style-type: none"> <li>3) Insulation resistance tester (Megger)</li> <li>4) Electroscop</li> </ol> |
|--|--|

# 1. SPECIFICATIONS

## 1-1. Outdoor Unit

### <Digital Inverter>

| Model name                       |   | Outdoor unit    | RAV-  | SM1103AT-E1           | SM1403AT-E1           |
|----------------------------------|---|-----------------|---|-----------------------|-----------------------|
| Power supply                     |   |                 | 1 phase 230V (220 – 240V) 50Hz<br>(Power exclusive to outdoor is required.) |                       |                       |
| Compressor                       | Type  |                 | Hermetic compressor   |                       |                       |
|                                  | Motor   |                 | (kW)  | 2.5                   | 3.0                   |
|                                  | Pole  |                 |   | 4                     | 4                     |
| Refrigerant charged              |   |                 | (kg)  | 2.8                   | 2.8                   |
| Refrigerant control              |   |                 | Pulse motor valve   |                       |                       |
| Inter connecting pipe            | Standard length   |                 | (m)   | 7.5                   | 7.5                   |
|                                  | Min. length   |                 | (m)   | 5.0                   | 5.0                   |
|                                  | Max. total length   |                 | (m)   | 50                    | 50                    |
|                                  | Additional refrigerant charge under long piping connector |                 |   | 40g/m<br>(31m to 50m) | 40g/m<br>(31m to 50m) |
|                                  | Height difference   | Outdoor lower   | (m)   | 30                    | 30                    |
| Outdoor higher                   |   | (m)             | 30  | 30                    |                       |
| Outer dimension                  | Height  |                 | (mm)  | 795                   | 795                   |
|                                  | Width   |                 | (mm)  | 900                   | 900                   |
|                                  | Depth   |                 | (mm)  | 320                   | 320                   |
| Appearance                       |   |                 | Silky shade (Muncel 1Y 8.5/0.5)   |                       |                       |
| Total weight                     |   |                 | (kg)  | 76                    | 76                    |
| Heat exchanger                   |   |                 | Finned tube   |                       |                       |
| Fan unit                         | Fan   |                 | Propeller fan   |                       |                       |
|                                  | Standard air flow   |                 | (m <sup>3</sup> /h.)  | 75                    | 75                    |
|                                  | Motor   |                 | (W)   | 100                   | 100                   |
| Connecting pipe                  | Gas side  |                 | (mm)  | 15.9                  | 15.9                  |
|                                  | Liquid side   |                 | (mm)  | 9.5                   | 9.5                   |
| Sound pressure level             |   | Cooling/Heating | (dB•A)  | 53 / 54               | 54 / 54               |
| Sound power level                |   | Cooling/Heating | (dB•A)  | 70 / 71               | 70 / 71               |
| Outside air temperature, Cooling |   |                 | (°C)  | 43 to – 15            |                       |
| Outside air temperature, Heating |   |                 | (°C)  | 15 to – 15            |                       |

## 1-2. Operation Characteristic Curve

### • Operation Characteristic Curve <Digital Inverter>

RAV-SM1103AT-E1,RAV-SM1403AT-E1

#### <Cooling>

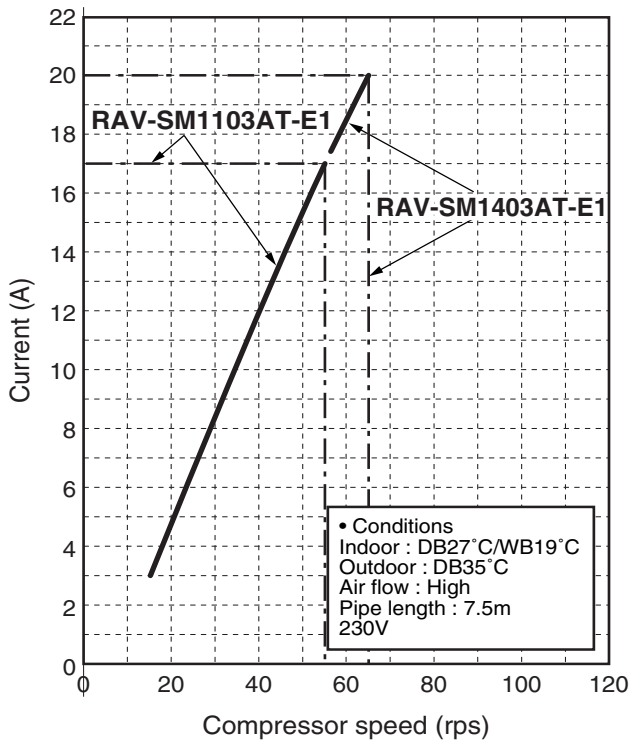

#### <Heating>

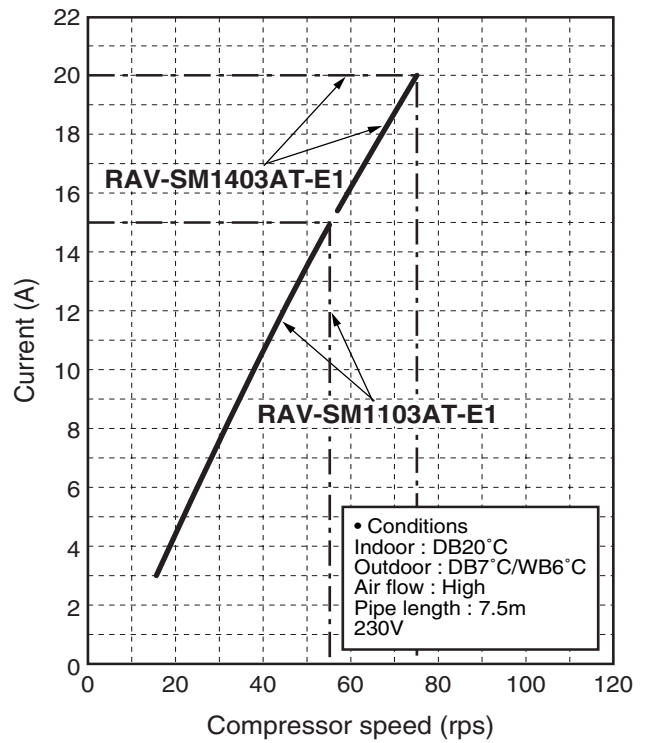

### • Capacity variation ratio according to temperature

RAV-SM1103AT-E1,RAVSM1403AT-E1

#### <Cooling>

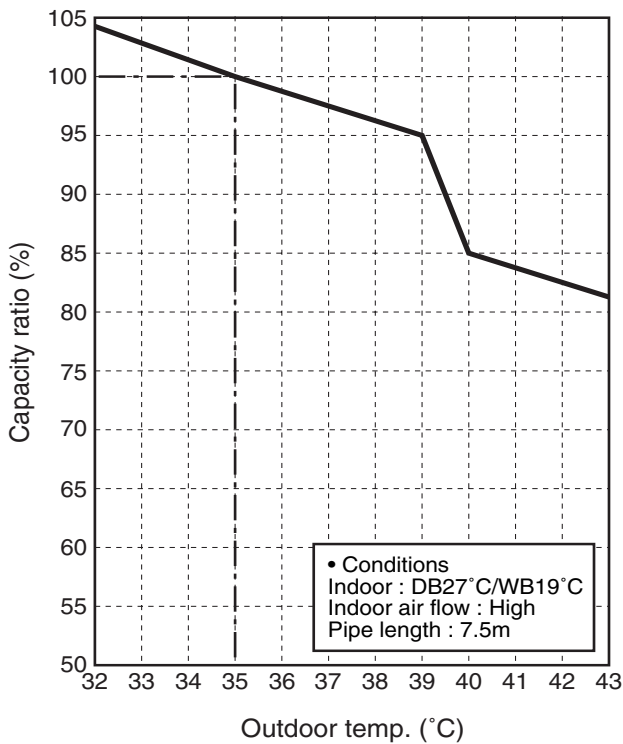

#### <Heating>

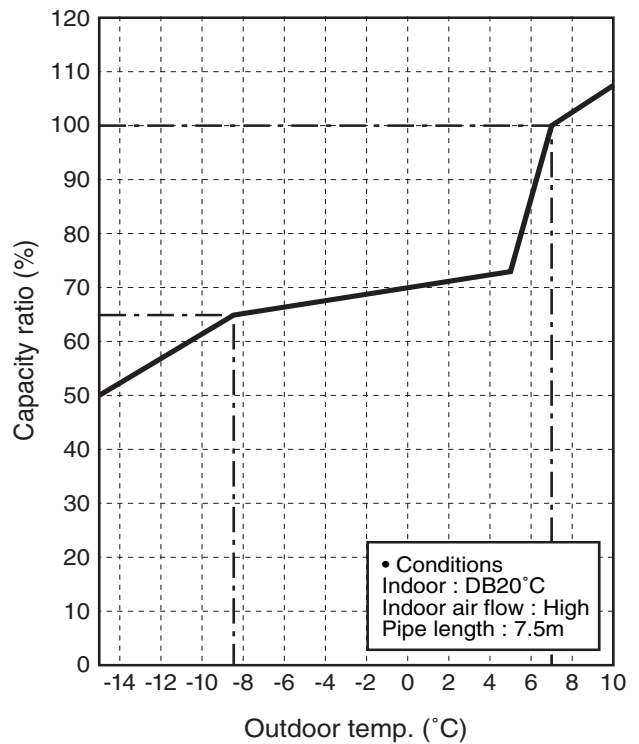

## 2 . CONSTRUCTION VIEWS (EXTERNAL VIEWS)

RAV-SM1103AT-E1, RAV-SM1403AT-E1

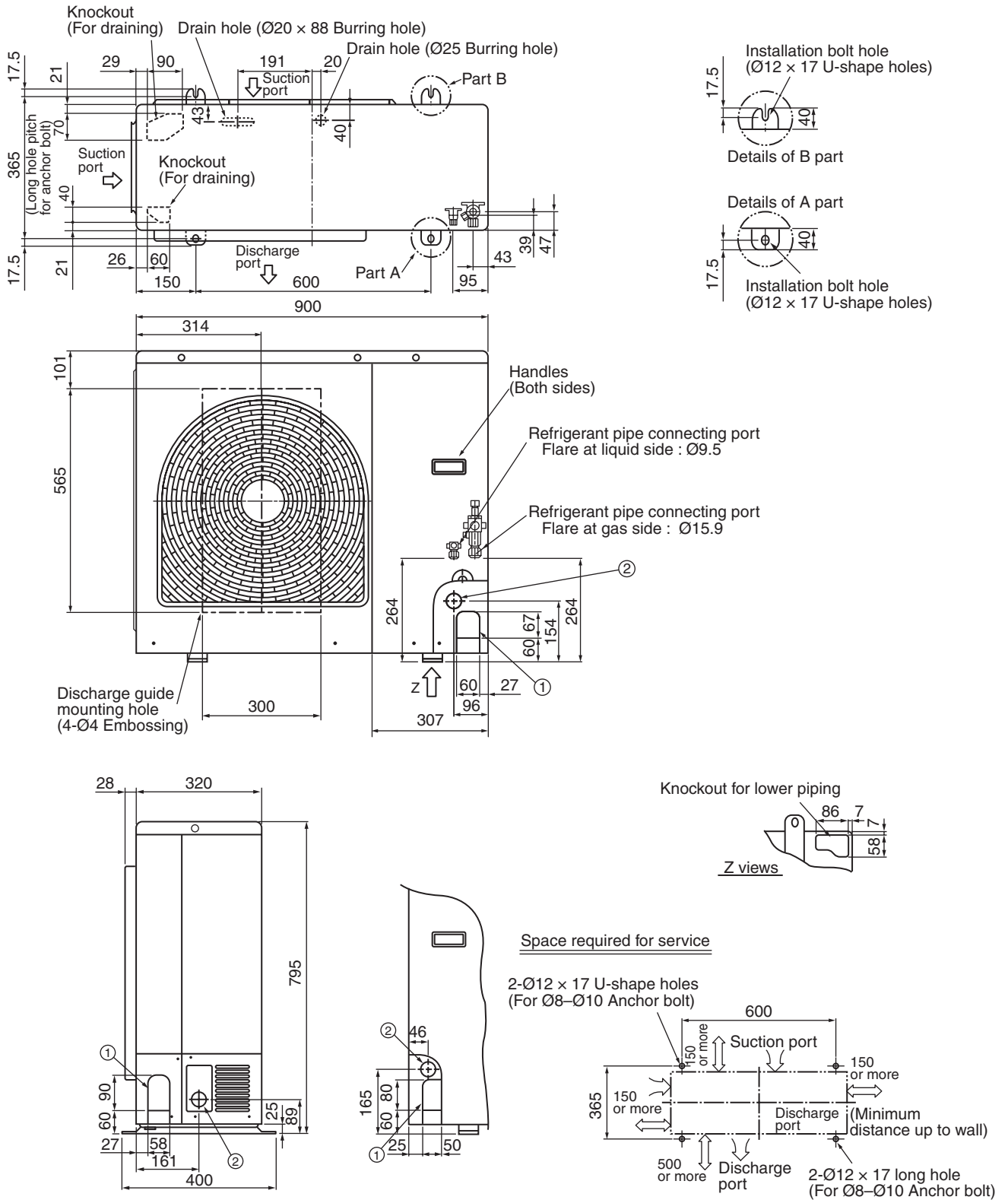

**RBC-TWP30E2, RBC-TWP50E2 (Simultaneous Twin)**

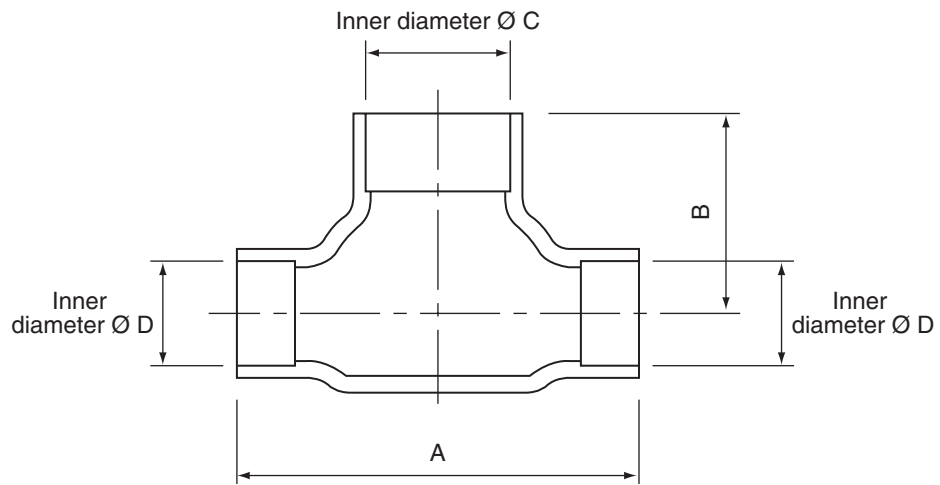

| Model (RBC-)   |             | A  | B  | C     | D     |
|----------------|-------------|----|----|-------|-------|
| <b>TWP30E2</b> | Liquid side | 36 | 14 | Ø9.5  | Ø6.4  |
|                | Gas side    | 43 | 23 | Ø15.9 | Ø12.7 |
| <b>TWP50E2</b> | Liquid side | 34 | 14 | Ø9.5  | Ø9.5  |
|                | Gas side    | 44 | 21 | Ø15.9 | Ø15.9 |



### 3 . REFRIGERATING CYCLE DIAGRAM

RAV-SM1103AT-E1, RAV-SM1403AT-E1

| Outer diameter of refrigerant pipe |                |
|------------------------------------|----------------|
| Gas side ØA                        | Liquid side ØB |
| 15.9mm                             | 9.5mm          |

| Height difference (m)      |                            |
|----------------------------|----------------------------|
| Outdoor unit at upper side | Outdoor unit at lower side |
| 30                         | 30                         |

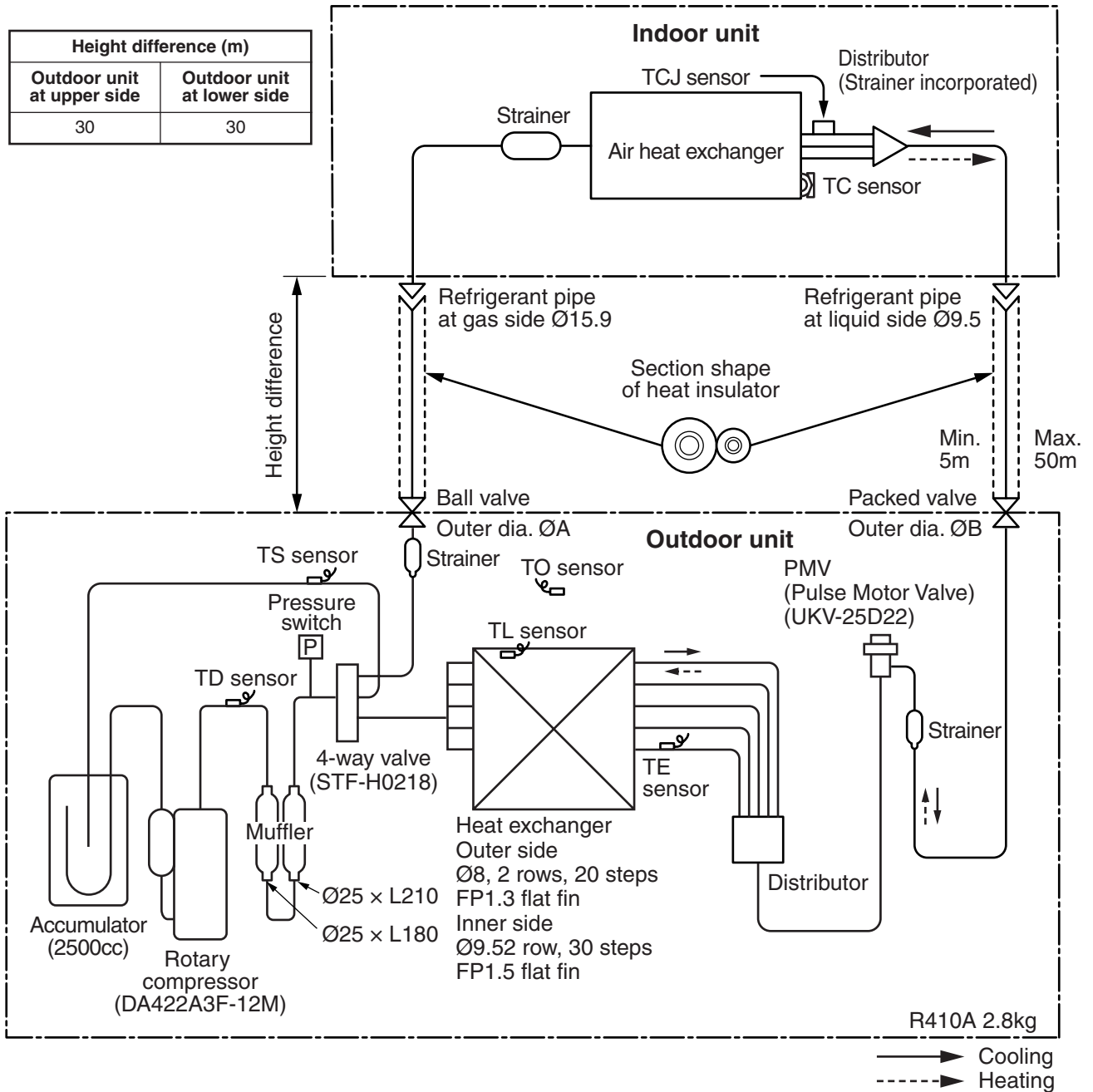

**RAV-SM1103AT-E1**

|         |          | Pressure |      |                        |      | Pipe surface temp. |     |    |     |     | *<br>Comp.<br>Hz | Fan  | Temp    |          |
|---------|----------|----------|------|------------------------|------|--------------------|-----|----|-----|-----|------------------|------|---------|----------|
|         |          | (MPa)    |      | (kg/cm <sup>2</sup> G) |      | TD                 | TS  | TC | TL  | TE  |                  |      | In      | Out      |
|         |          | Pd       | Ps   | Pd                     | Ps   |                    |     |    |     |     |                  |      |         |          |
| Cooling | Standard | 3.44     | 0.92 | 35.1                   | 9.4  | 82                 | 8   | 10 | 56  | 39  | 47               | HIGH | 27/19   | 35/-     |
|         | Overload | 3.73     | 1.18 | 38.1                   | 12.0 | 82                 | 15  | 17 | 59  | 48  | 42               | HIGH | 32/24   | 43/-     |
|         | Low load | 1.49     | 0.70 | 15.2                   | 7.1  | 39                 | 8   | 3  | 23  | 22  | 30               | LOW  | 18/15.5 | -5/-     |
| Heating | Standard | 2.80     | 0.61 | 28.6                   | 6.2  | 80                 | 0   | 46 | 7   | 1   | 48               | HIGH | 20/-    | 7/6      |
|         | Overload | 3.43     | 1.08 | 35.0                   | 11.0 | 82                 | 14  | 55 | 12  | 13  | 24               | LOW  | 30/-    | 24/18    |
|         | Low load | 2.20     | 0.25 | 22.4                   | 2.6  | 76                 | -19 | 36 | -16 | -16 | 55               | HIGH | 15/-    | -10(70%) |

**RAV-SM1403AT-E1**

|         |          | Pressure |      |                        |      | Pipe surface temp. |     |    |     |     | *<br>Comp.<br>Hz | Fan  | Temp    |          |
|---------|----------|----------|------|------------------------|------|--------------------|-----|----|-----|-----|------------------|------|---------|----------|
|         |          | (MPa)    |      | (kg/cm <sup>2</sup> G) |      | TD                 | TS  | TC | TL  | TE  |                  |      | In      | Out      |
|         |          | Pd       | Ps   | Pd                     | Ps   |                    |     |    |     |     |                  |      |         |          |
| Cooling | Standard | 3.52     | 0.85 | 35.9                   | 8.7  | 87                 | 8   | 9  | 57  | 39  | 54               | HIGH | 27/19   | 35/-     |
|         | Overload | 3.78     | 1.12 | 38.6                   | 11.4 | 84                 | 15  | 17 | 59  | 47  | 45               | HIGH | 32/24   | 43/-     |
|         | Low load | 1.51     | 0.71 | 15.4                   | 7.2  | 40                 | 7   | 3  | 23  | 23  | 30               | LOW  | 18/15.5 | -5/-     |
| Heating | Standard | 2.88     | 0.60 | 29.4                   | 6.1  | 85                 | 1   | 47 | 6   | 1   | 61               | HIGH | 20/-    | 7/6      |
|         | Overload | 3.41     | 1.08 | 34.8                   | 11.0 | 81                 | 14  | 54 | 13  | 13  | 24               | LOW  | 30/-    | 24/18    |
|         | Low load | 2.35     | 0.24 | 24.0                   | 2.4  | 80                 | -19 | 40 | -16 | -16 | 73               | HIGH | 15/-    | -10(70%) |

\* 4 poles are provided to this compressor.

The compressor frequency (Hz) measured with a clamp meter is 2 times of revolutions (rps) of the compressor.

# 4. WIRING DIAGRAM

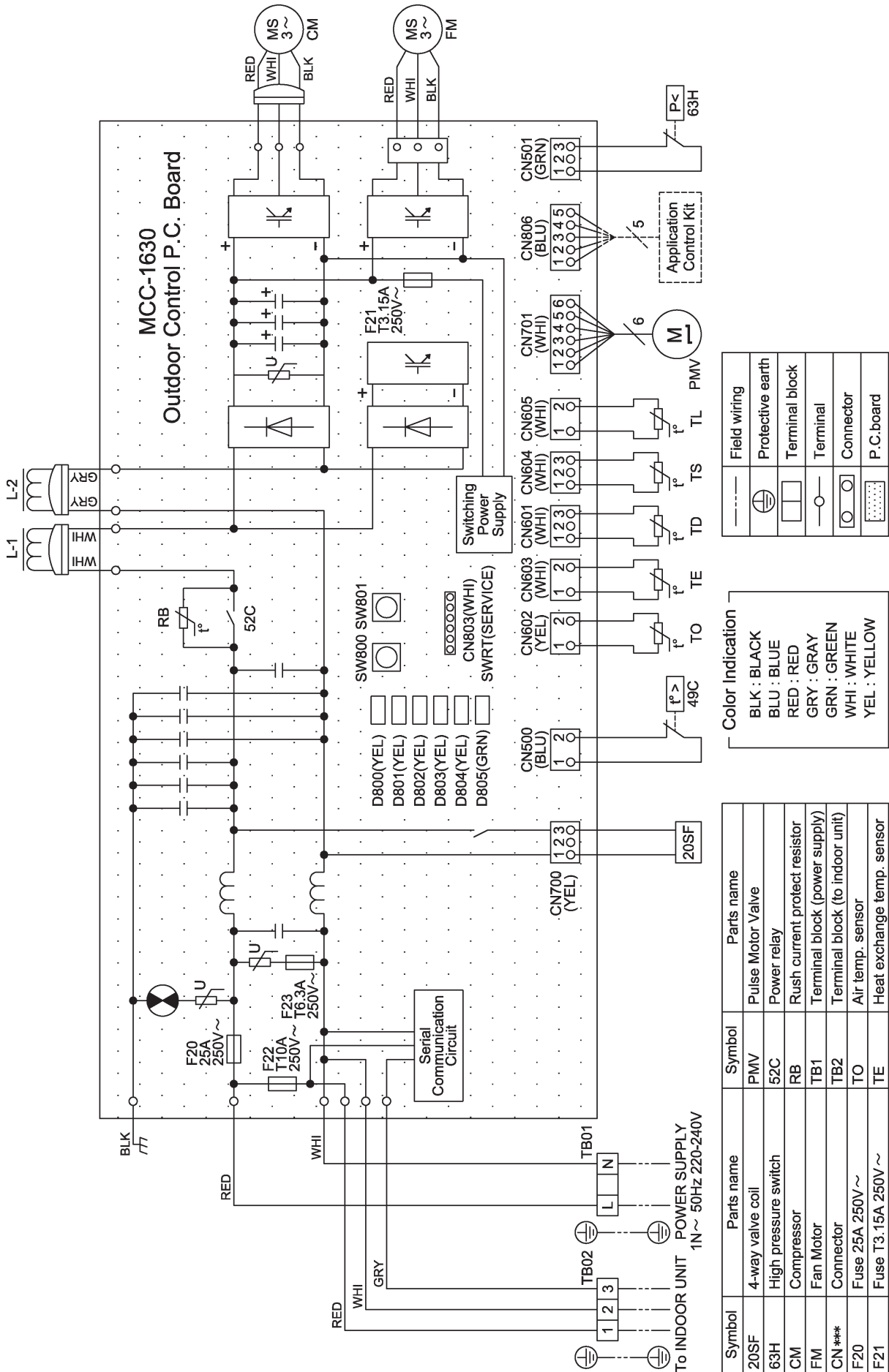

1. For D800 ~ D805 and SW800 ~ SW801, refer to the installation manual.

## 5. SPECIFICATIONS OF ELECTRIC PARTS

| Part name              | Type                                   | Specifications                                     |
|------------------------|--|--|
| Compressor             | DA422A3F-12M                           |  |
| Outdoor fan motor      | WDF-340-A100-1                         | Output 100W  |
| Reactor                | CH62-2Z-T                              | 6mH, 18.5A   |
| 4-way valve coil       | STF-H01AJ1949A1                        | AC230V   |
| High-pressure SW       | ACB-4UB83W                             | OFF: 4.15MPa                                       |
| PMV coil               | UKV-A039                               | DC12V  |
| P.C. board             | MCC-1630                               | 1Ø AC220V/230V/240V±10%, 50/60HZ                   |
| Fuse                   | GDT 250V25A                            | AC250V, 25A  |
| Fuse                   | 50T (P) 063HF                          | AC250V, 6.3A                                       |
| Fuse                   | SCT3.15A                               | AC250V, 3.15A                                      |
| Surge absorber         | DA38-362MT or<br>DA38-302MT            | Discharge voltage 3600V<br>Discharge voltage 3000V |
| Rectifier              | D25XB60                                | DC600V, 25A  |
| Electrolytic condenser | LLQ2G761KHUATF or<br>ECST401LIN761KA58 | DC400V, 760µF                                      |
| Power relay            | DW12D1                                 | AC250V, 20A x 2                                    |
| Relay                  | G5NB or<br>DQ12D1 or<br>RPG-12         | AC250V, 3A<br>AC250V, 5A<br>AC250V, 3A             |
| Switching transformer  | SWT-91                                 | Input: DC240 to 390V<br>Output: DC7V, DC13V, DC17V |
| Fuse                   | 50T100H                                | AC250V, 10A  |

## 6. REFRIGERANT R410A

This air conditioner adopts the new refrigerant HFC (R410A) which does not damage the ozone layer.

The working pressure of the new refrigerant R410A is 1.6 times higher than conventional refrigerant (R22). The refrigerating oil is also changed in accordance with change of refrigerant, so be careful that water, dust, and existing refrigerant or refrigerating oil are not entered in the refrigerant cycle of the air conditioner using the new refrigerant during installation work or servicing time.

The next section describes the precautions for air conditioner using the new refrigerant.

Conforming to contents of the next section together with the general cautions included in this manual, perform the correct and safe work.

### 6-1. Safety During Installation/Serviceing

As R410A's pressure is about 1.6 times higher than that of R22, improper installation/servicing may cause a serious trouble. By using tools and materials exclusive for R410A, it is necessary to carry out installation/servicing safely while taking the following precautions into consideration.

1. Never use refrigerant other than R410A in an air conditioner which is designed to operate with R410A.

If other refrigerant than R410A is mixed, pressure in the refrigeration cycle becomes abnormally high, and it may cause personal injury, etc. by a rupture.

2. Confirm the used refrigerant name, and use tools and materials exclusive for the refrigerant R410A.

The refrigerant name R410A is indicated on the visible place of the outdoor unit of the air conditioner using R410A as refrigerant.

To prevent mischarging, the diameter of the service port differs from that of R22.

3. If a refrigeration gas leakage occurs during installation/servicing, be sure to ventilate fully.  
If the refrigerant gas comes into contact with fire, a poisonous gas may occur.
4. When installing or removing an air conditioner, do not allow air or moisture to remain in the refrigeration cycle.  
Otherwise, pressure in the refrigeration cycle may become abnormally high so that a rupture or personal injury may be caused.
5. After completion of installation work, check to make sure that there is no refrigeration gas leakage.  
If the refrigerant gas leaks into the room, coming into contact with fire in the fan-driven heater, space heater, etc., a poisonous gas may occur.

6. When an air conditioning system charged with a large volume of refrigerant is installed in a small room, it is necessary to exercise care so that, even when refrigerant leaks, its concentration does not exceed the marginal level.

If the refrigerant gas leakage occurs and its concentration exceeds the marginal level, an oxygen starvation accident may result.

7. Be sure to carry out installation or removal according to the installation manual.  
Improper installation may cause refrigeration trouble, water leakage, electric shock, fire, etc.
8. Unauthorized modifications to the air conditioner may be dangerous. If a breakdown occurs please call a qualified air conditioner technician or electrician.  
Improper repair may result in water leakage, electric shock and fire, etc.

### 6-2. Refrigerant Piping Installation

#### 6-2-1. Piping Materials and Joints Used

For the refrigerant piping installation, copper pipes and joints are mainly used.

Copper pipes and joints suitable for the refrigerant must be chosen and installed.

Furthermore, it is necessary to use clean copper pipes and joints whose interior surfaces are less affected by contaminants.

#### 1. Copper Pipes

It is necessary to use seamless copper pipes which are made of either copper or copper alloy and it is desirable that the amount of residual oil is less than 40 mg/10 m.

Do not use copper pipes having a collapsed, deformed or discolored portion (especially on the interior surface).

Otherwise, the expansion valve or capillary tube may become blocked with contaminants.

As an air conditioner using R410A incurs pressure higher than when using R22, it is necessary to choose adequate materials.

Thicknesses of copper pipes used with R410A are as shown in Table 6-2-1. Never use copper pipes thinner than 0.8mm even when it is available on the market.

#### NOTE

---

Refer to the "6-6. Instructions for Re-use Piping of R22 or R407C".

---

**Table 6-2-1 Thicknesses of annealed copper pipes**

|                  |                     | Thickness (mm) |      |
|------------------|---------------------|----------------|------|
| Nominal diameter | Outer diameter (mm) | R410A          | R22  |
| 1/4              | 6.4                 | 0.80           | 0.80 |
| 3/8              | 9.5                 | 0.80           | 0.80 |
| 1/2              | 12.7                | 0.80           | 0.80 |
| 5/8              | 15.9                | 1.00           | 1.00 |

**1. Joints**

For copper pipes, flare joints or socket joints are used. Prior to use, be sure to remove all contaminants.

## a) Flare Joints

Flare joints used to connect the copper pipes cannot be used for pipings whose outer diameter exceeds 20 mm. In such a case, socket joints can be used.

Sizes of flare pipe ends, flare joint ends and flare nuts are as shown in Tables 6-2-3 to 6-2-5 below.

## b) Socket Joints

Socket joints are such that they are brazed for connections, and used mainly for thick pipings whose diameter is larger than 20 mm. Thicknesses of socket joints are as shown in Table 6-2-2.

**Table 6-2-2 Minimum thicknesses of socket joints**

| Nominal diameter | Reference outer diameter of copper pipe jointed (mm) | Minimum joint thickness (mm) |
|------------------|--|------------------------------|
| 1/4              | 6.4  | 0.50                         |
| 3/8              | 9.5  | 0.60                         |
| 1/2              | 12.7   | 0.70                         |
| 5/8              | 15.9   | 0.80                         |

**6-2-2. Processing of Piping Materials**

When performing the refrigerant piping installation, care should be taken to ensure that water or dust does not enter the pipe interior, that no other oil other than lubricating oils used in the installed air conditioner is used, and that refrigerant does not leak.

When using lubricating oils in the piping processing, use such lubricating oils whose water content has been removed. When stored, be sure to seal the container with an airtight cap or any other cover.

**1. Flare Processing Procedures and Precautions**

## a) Cutting the Pipe

By means of a pipe cutter, slowly cut the pipe so that it is not deformed.

## b) Removing Burrs and Chips

If the flared section has chips or burrs, refrigerant leakage may occur.

Carefully remove all burrs and clean the cut surface before installation.

c) Insertion of Flare Nut

d) Flare Processing

Make certain that a clamp bar and copper pipe have been cleaned.

By means of the clamp bar, perform the flare processing correctly.

Use either a flare tool for R410A or conventional flare tool.

Flare processing dimensions differ according to the type of flare tool.

When using a conventional flare tool, be sure to secure "dimension A" by using a gauge for size adjustment.

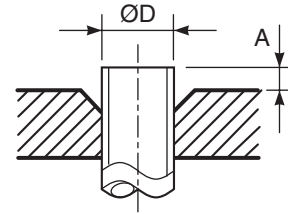

Fig. 6-2-1 Flare processing dimensions

Table 6-2-3 Dimensions related to flare processing for R410A / R22

| Nominal diameter | Outer diameter (mm) | Thickness (mm) | A (mm)                                |                                 |               |                               |               |
|------------------|---------------------|----------------|---------------------------------------|---------------------------------|---------------|-------------------------------|---------------|
|                  |                     |                | Flare tool for R410A, R22 clutch type | Conventional flare tool (R410A) |               | Conventional flare tool (R22) |               |
|                  |                     |                |                                       | Clutch type                     | Wing nut type | Clutch type                   | Wing nut type |
| 1/4              | 6.4                 | 0.8            | 0 to 0.5                              | 1.0 to 1.5                      | 1.5 to 2.0    | 0.5 to 1.0                    | 1.0 to 1.5    |
| 3/8              | 9.5                 | 0.8            | 0 to 0.5                              | 1.0 to 1.5                      | 1.5 to 2.0    | 0.5 to 1.0                    | 1.0 to 1.5    |
| 1/2              | 12.7                | 0.8            | 0 to 0.5                              | 1.0 to 1.5                      | 2.0 to 2.5    | 0.5 to 1.0                    | 1.5 to 2.0    |
| 5/8              | 15.9                | 1.0            | 0 to 0.5                              | 1.0 to 1.5                      | 2.0 to 2.5    | 0.5 to 1.0                    | 1.5 to 2.0    |
| 3/4              | 19.1                | 1.2            | 0 to 0.5                              | 1.0 to 1.5                      | 2.0 to 2.5    | —                             | —             |

Table 6-2-4 Flare and flare nut dimensions for R410A

| Nominal diameter | Outer diameter (mm) | Thickness (mm) | Dimension (mm) |      |      |    | Flare nut width (mm) |
|------------------|---------------------|----------------|----------------|------|------|----|----------------------|
|                  |                     |                | A              | B    | C    | D  |                      |
| 1/4              | 6.4                 | 0.8            | 9.1            | 9.2  | 6.5  | 13 | 17                   |
| 3/8              | 9.5                 | 0.8            | 13.2           | 13.5 | 9.7  | 20 | 22                   |
| 1/2              | 12.7                | 0.8            | 16.6           | 16.0 | 12.9 | 23 | 26                   |
| 5/8              | 15.9                | 1.0            | 19.7           | 19.0 | 16.0 | 25 | 29                   |
| 3/4              | 19.1                | 1.2            | 24.0           | —    | 19.2 | 28 | 36                   |

Table 6-2-5 Flare and flare nut dimensions for R22

| Nominal diameter | Outer diameter (mm) | Thickness (mm) | Dimension (mm) |      |      |    | Flare nut width (mm) |
|------------------|---------------------|----------------|----------------|------|------|----|----------------------|
|                  |                     |                | A              | B    | C    | D  |                      |
| 1/4              | 6.4                 | 0.8            | 9.1            | 9.2  | 6.5  | 13 | 17                   |
| 3/8              | 9.5                 | 0.8            | 13.0           | 13.5 | 9.7  | 20 | 22                   |
| 1/2              | 12.7                | 0.8            | 16.2           | 16.0 | 12.9 | 20 | 24                   |
| 5/8              | 15.9                | 1.0            | 19.4           | 19.0 | 16.0 | 23 | 27                   |
| 3/4              | 19.1                | 1.0            | 23.3           | 24.0 | 19.2 | 34 | 36                   |

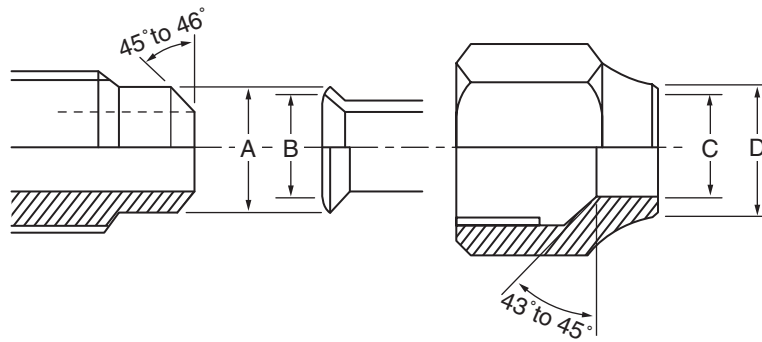

**Fig. 6-2-2 Relations between flare nut and flare seal surface**

## 2. Flare Connecting Procedures and Precautions

- Make sure that the flare and union portions do not have any scar or dust, etc.
- Correctly align the processed flare surface with the union axis.
- Tighten the flare with designated torque by means of a torque wrench.

The tightening torque for R410A is the same as that for conventional R22.

Incidentally, when the torque is weak, the gas leakage may occur.

When it is strong, the flare nut may crack and may be made non-removable.

When choosing the tightening torque, comply with values designated by manufacturers.

Table 6-2-6 shows reference values.

### NOTE

When applying oil to the flare surface, be sure to use oil designated by the manufacturer.

If any other oil is used, the lubricating oils may deteriorate and cause the compressor to burn out.

**Table 6-2-6 Tightening torque of flare for R410A [Reference values]**

| Nominal diameter | Outer diameter (mm) | Tightening torque N·m (kgf·m) | Tightening torque of torque wrenches available on the market N·m (kgf·m) |
|------------------|---------------------|-------------------------------|--|
| 1/4              | 6.4                 | 14 to 18 (1.4 to 1.8)         | 16 (1.6), 18 (1.8)   |
| 3/8              | 9.5                 | 33 to 42 (3.3 to 4.2)         | 42 (4.2)   |
| 1/2              | 12.7                | 50 to 62 (5.0 to 6.2)         | 55 (5.5)   |
| 5/8              | 15.9                | 63 to 77 (6.3 to 7.7)         | 65 (6.5)   |
| 3/4              | 19.1                | 100 to 120 (10.0 to 12.0)     | —  |



## 6-3. Tools

### 6-3-1. Required Tools

Refer to the "4. Tools"

## 6-4. Recharging of Refrigerant

When it is necessary to recharge refrigerant, charge the specified amount of new refrigerant according to the following steps.

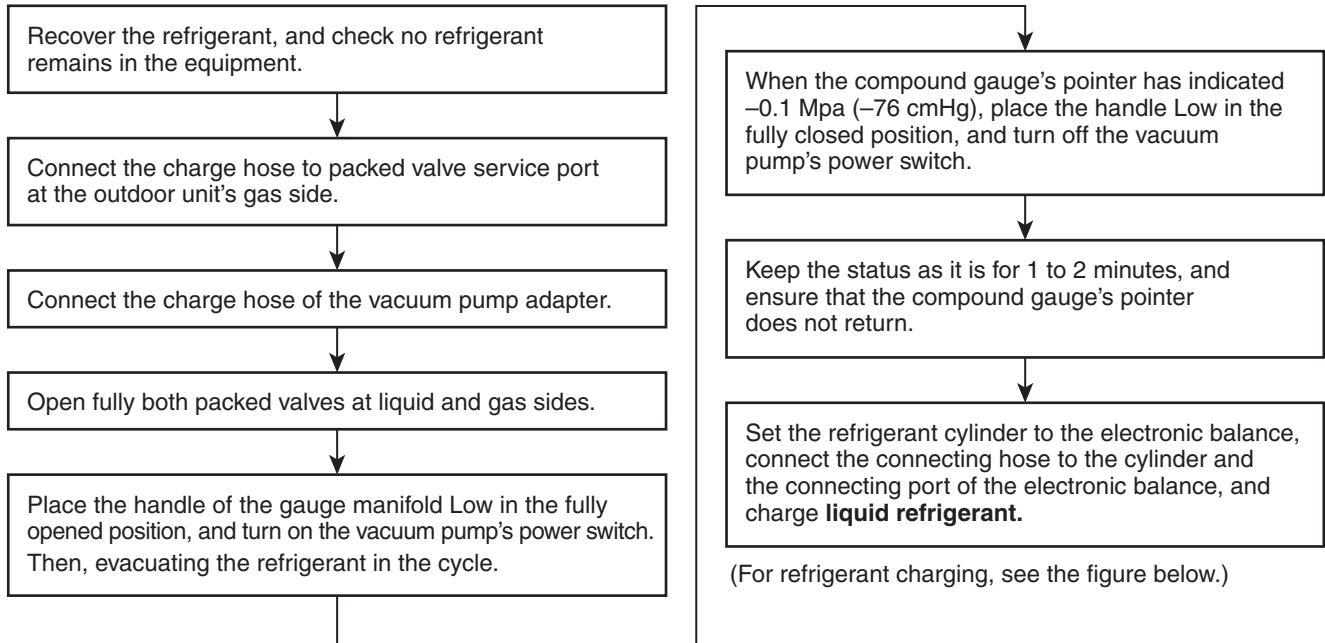

- 1) Never charge refrigerant exceeding the specified amount.
- 2) If the specified amount of refrigerant cannot be charged, charge refrigerant **bit by bit** in COOL mode.
- 3) Do not carry out additional charging.

When additional charging is carried out if refrigerant leaks, the refrigerant composition changes in the refrigeration cycle, that is characteristics of the air conditioner changes, refrigerant exceeding the specified amount is charged, and working pressure in the refrigeration cycle becomes abnormally high pressure, and may cause a rupture or personal injury.

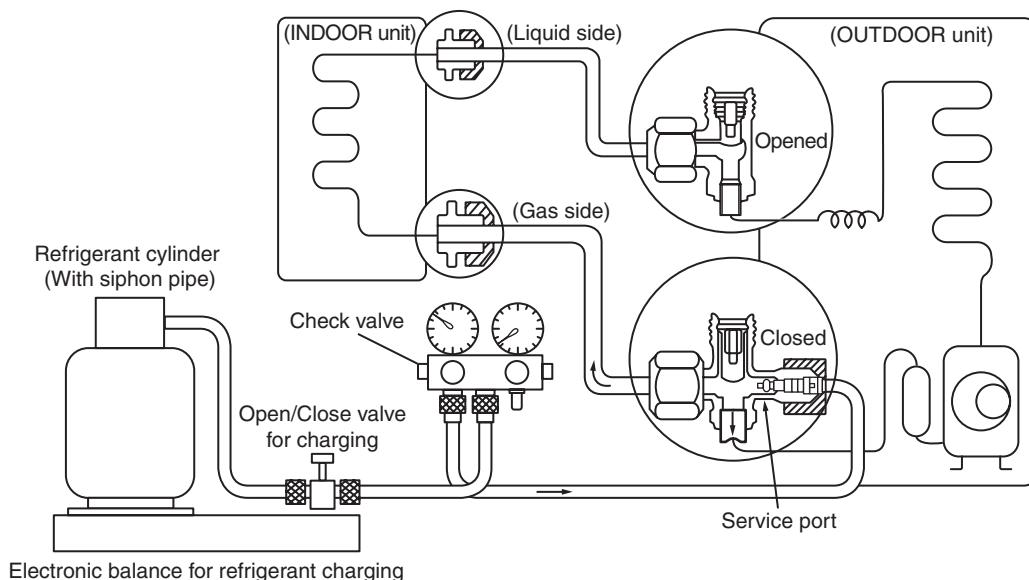
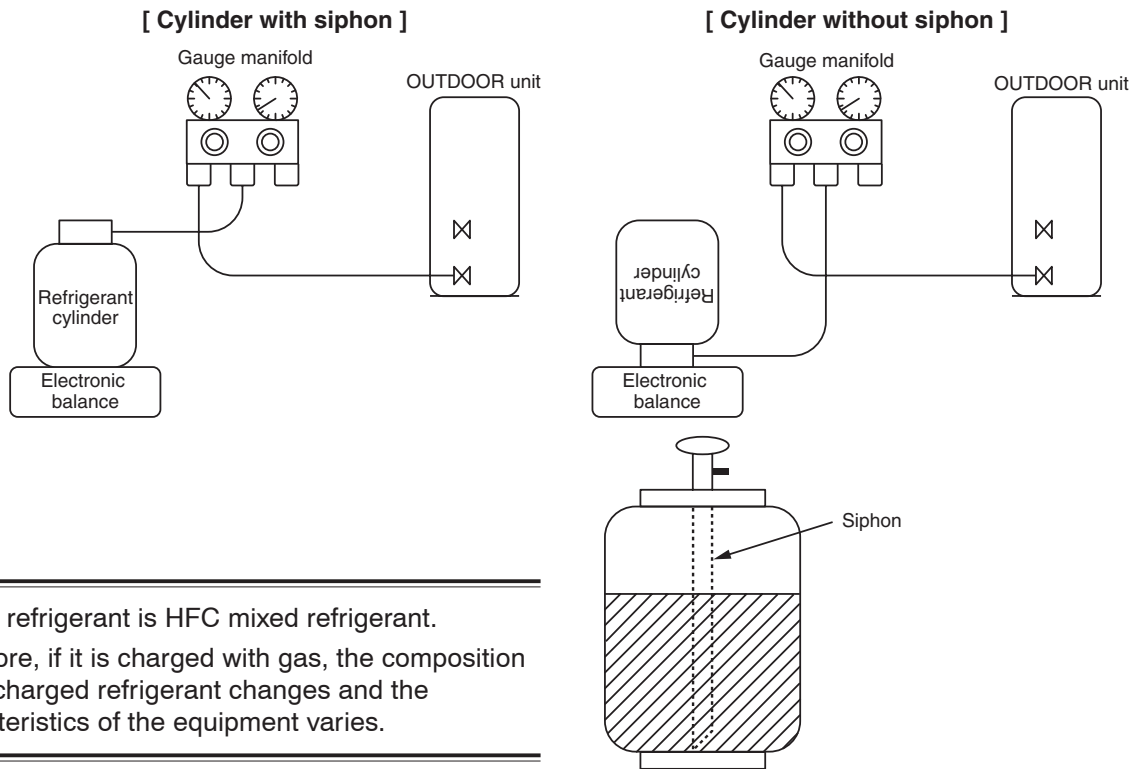

Fig. 6-4-1 Configuration of refrigerant charging

- 1) Be sure to make setting so that **liquid** can be charged.
- 2) When using a cylinder equipped with a siphon, liquid can be charged without turning it upside down.

It is necessary for charging refrigerant under condition of liquid because R410A is mixed type of refrigerant. Accordingly, when charging refrigerant from the refrigerant cylinder to the equipment, charge it turning the cylinder upside down if cylinder is not equipped with siphon.



R410A refrigerant is HFC mixed refrigerant. Therefore, if it is charged with gas, the composition of the charged refrigerant changes and the characteristics of the equipment varies.

Fig. 6-4-2

## 6-5. Brazing of Pipes

### 6-5-1. Materials for Brazing

#### 1. Silver brazing filler

Silver brazing filler is an alloy mainly composed of silver and copper.

It is used to join iron, copper or copper alloy, and is relatively expensive though it excels in solderability.

#### 2. Phosphor bronze brazing filler

Phosphor bronze brazing filler is generally used to join copper or copper alloy.

#### 3. Low temperature brazing filler

Low temperature brazing filler is generally called solder, and is an alloy of tin and lead.

Since it is weak in adhesive strength, do not use it for refrigerant pipes.

- 1) Phosphor bronze brazing filler tends to react with sulfur and produce a fragile compound water solution, which may cause a gas leakage. Therefore, use any other type of brazing filler at a hot spring resort, etc., and coat the surface with a paint.
- 2) When performing brazing again at time of servicing, use the same type of brazing filler.

### 6-5-2. Flux

#### 1. Reason why flux is necessary

- By removing the oxide film and any foreign matter on the metal surface, it assists the flow of brazing filler.
- In the brazing process, it prevents the metal surface from being oxidized.
- By reducing the brazing filler's surface tension, the brazing filler adheres better to the treated metal.

## 2. Characteristics required for flux

- Activated temperature of flux coincides with the brazing temperature.
- Due to a wide effective temperature range, flux is hard to carbonize.
- It is easy to remove slag after brazing.
- The corrosive action to the treated metal and brazing filler is minimum.
- It excels in coating performance and is harmless to the human body.

As the flux works in a complicated manner as described above, it is necessary to select an adequate type of flux according to the type and shape of treated metal, type of brazing filler and brazing method, etc.

## 3. Types of flux

### • Noncorrosive flux

Generally, it is a compound of borax and boric acid.

It is effective in case where the brazing temperature is higher than 800°C.

### • Activated flux

Most of fluxes generally used for silver brazing are this type.

It features an increased oxide film removing capability due to the addition of compounds such as potassium fluoride, potassium chloride and sodium fluoride to the borax-boric acid compound.

## 4. Piping materials for brazing and used brazing filler/flux

| Piping material | Used brazing filler | Used flux  |
|-----------------|---------------------|------------|
| Copper - Copper | Phosphor copper     | Do not use |
| Copper - Iron   | Silver              | Paste flux |
| Iron - Iron     | Silver              | Vapor flux |

- 1) Do not enter flux into the refrigeration cycle.
- 2) When chlorine contained in the flux remains within the pipe, the lubricating oil deteriorates. Therefore, use a flux which does not contain chlorine.
- 3) When adding water to the flux, use water which does not contain chlorine (e.g. distilled water or ion-exchange water).
- 4) Remove the flux after brazing.

## 6-5-3. Brazing

As brazing work requires sophisticated techniques, experiences based upon a theoretical knowledge, it must be performed by a person qualified.

In order to prevent the oxide film from occurring in the pipe interior during brazing, it is effective to proceed with brazing while letting dry Nitrogen gas flow.

**Never use gas other than Nitrogen gas.**

### 1. Brazing method to prevent oxidation

- 1) Attach a reducing valve and a flow-meter to the Nitrogen gas cylinder.
- 2) Use a copper pipe to direct the piping material, and attach a flow-meter to the cylinder.
- 3) Apply a seal onto the clearance between the piping material and inserted copper pipe for Nitrogen in order to prevent backflow of the Nitrogen gas.
- 4) When the Nitrogen gas is flowing, be sure to keep the piping end open.
- 5) Adjust the flow rate of Nitrogen gas so that it is lower than 0.05 m<sup>3</sup>/Hr or 0.02 MPa (0.2kgf/cm<sup>2</sup>) by means of the reducing valve.
- 6) After performing the steps above, keep the Nitrogen gas flowing until the pipe cools down to a certain extent (temperature at which pipes are touchable with hands).
- 7) Remove the flux completely after brazing.

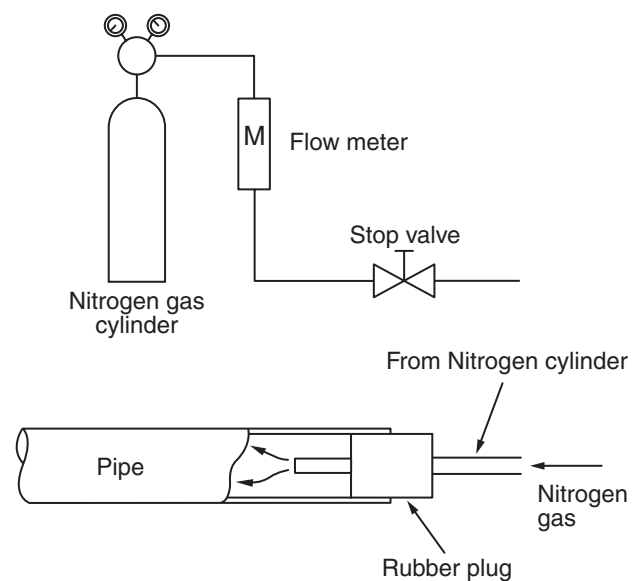

**Fig. 6-5-1**  
**Prevention of oxidation during brazing**

## 6-6. Instructions for Re-use Piping of R22 or R407C

### Instruction of Works:

The existing R22 and R407C piping can be reused for our digital inverter R410A products installations.

#### NOTE)

Confirmation of existence of scratch or dent of the former pipes to be applied and also confirmation of reliability of the pipe strength are conventionally referred to the local site.

If the definite conditions can be cleared, it is possible to update the existing R22 and R407C pipes to those for R410A models.

### 6-6-1. Basic Conditions Needed to Reuse the Existing Pipe

Check and observe three conditions of the refrigerant piping works.

1. Dry (There is no moisture inside of the pipes.)
2. Clean (There is no dust inside of the pipes.)
3. Tight (There is no refrigerant leak.)

### 6-6-2. Restricted Items to Use the Existing Pipes

In the following cases, the existing pipes cannot be reused as they are. Clean the existing pipes or exchange them with new pipes.

1. When a scratch or dent is heavy, be sure to use the new pipes for the works.
2. When the thickness of the existing pipe is thinner than the specified "Pipe diameter and thickness" be sure to use the new pipes for the works.
  - The operating pressure of R410A is high (1.6 times of R22 and R407C). If there is a scratch or dent on the pipe or thinner pipe is used, the pressure strength is poor and may cause break-age of the pipe at the worst.

#### \* Pipe diameter and thickness (mm)

| Pipe outer diameter |             | Ø6.4 | Ø9.5 | Ø12.7 | Ø15.9 | Ø19.0 |
|---------------------|-------------|------|------|-------|-------|-------|
| Thickness           | R410A       | 0.8  | 0.8  | 0.8   | 1.0   | 1.0   |
|                     | R22 (R407C) |      |      |       |       |       |

- In case that the pipe diameter is Ø12.7 mm or less and the thickness is less than 0.7 mm, be sure to use the new pipes for works.
3. The pipes are left as coming out or gas leaks. (Poor refrigerant)
    - There is possibility that rain water or air including moisture enters in the pipe.
  4. Refrigerant recovery is impossible. (Refrigerant recovery by the pump-down operation on the existing air conditioner)
    - There is possibility that a large quantity of poor oil or moisture remains inside of the pipe.
  5. A dryer on the market is attached to the existing pipes.
    - There is possibility that copper green rust generated.

6. Check the oil when the existing air conditioner was removed after refrigerant had been recovered. In this case, if the oil is judged as clearly different compared with normal oil
  - The refrigerator oil is copper rust green : There is possibility that moisture is mixed with the oil and rust generates inside of the pipe.
  - There is discolored oil, a large quantity of the remains, or bad smell.
  - A large quantity of sparkle remained wear-out powder is observed in the refrigerator oil.
7. The air conditioner which compressor was exchanged due to a faulty compressor. When the discolored oil, a large quantity of the remains, mixture of foreign matter, or a large quantity of sparkle remained wear-out powder is observed, the cause of trouble will occur.
8. Installation and removal of the air conditioner are repeated with temporary installation by lease and etc.
9. In case that type of the refrigerator oil of the existing air conditioner is other than the following oil (Mineral oil), Suniso, Freol-S, MS (Synthetic oil), alkyl benzene (HAB, Barrel-freeze), ester series, PVE only of ether series.
  - Winding-insulation of the compressor may become inferior.

#### NOTE)

The above descriptions are results of confirmation by our company and they are views on our air conditioners, but they do not guarantee the use of the existing pipes of the air conditioner that adopted R410A in other companies.

### 6-6-3. Branching Pipe for Simultaneous Operation System

- In the concurrent twin system, when TOSHIBA-specified branching pipe is used, it can be reused. Branching pipe model name: RBC-TWP30E2, RBC-TWP50E2  
On the existing air conditioner for simultaneous operation system (twin system), there is a case of using branch pipe that has insufficient compressive strength. In this case please change it to the branch pipe for R410A.

### 6-6-4. Curing of Pipes

When removing and opening the indoor unit or outdoor unit for a long time, cure the pipes as follows:

- Otherwise rust may generate when moisture or foreign matter due to dewing enters in the pipes.
- The rust cannot be removed by cleaning, and a new piping work is necessary.

| Place position | Term              | Curing manner      |
|----------------|-------------------|--------------------|
| Outdoors       | 1 month or more   | Pinching or taping |
|                | Less than 1 month |                    |
| Indoors        | Every time        |                    |

### 6-6-5. Final Installation Checks

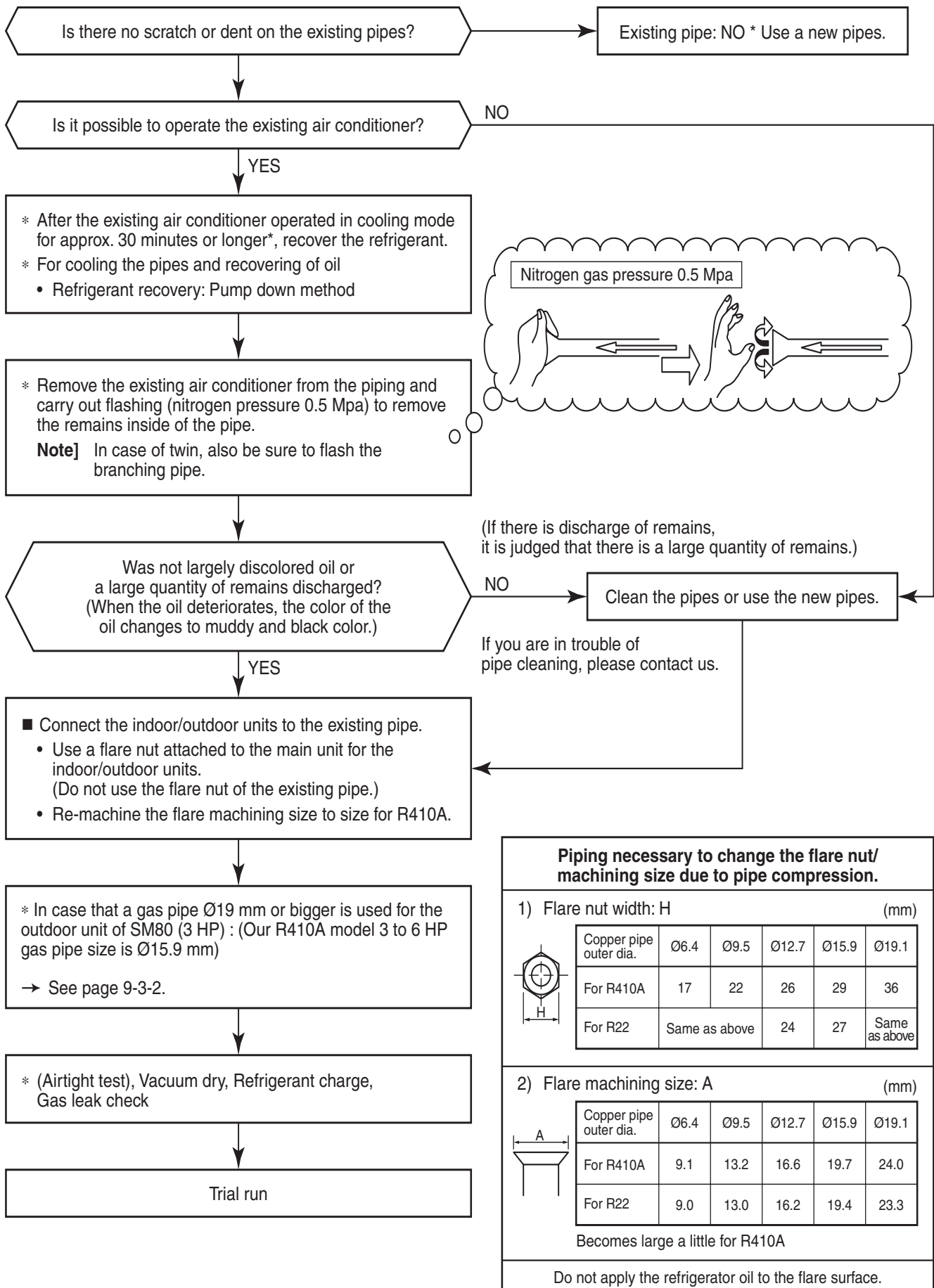

### 6-6-6. Handling of Existing Pipe

When using the existing pipe, carefully check it for the following:

- Wall thickness (within the specified range)
- Scratches and dents
- Water, oil, dirt, or dust in the pipe
- Flare looseness and leakage from welds
- Deterioration of copper pipe and heat insulator

#### Cautions for using existing pipe

- Do not reuse the flare to prevent gas leak.  
Replace it with the supplied flare nut and then process it to a flare.
- Blow nitrogen gas or use an appropriate means to keep the inside of the pipe clean.  
If discolored oil or much residue is discharged, wash the pipe.
- Check welds, if any, on the pipe for gas leak.  
When the pipe corresponds to any of the following, do not use it. Install a new pipe instead.
- The pipe has been open (disconnected from indoor unit or outdoor unit) for a long period.
- The pipe has been connected to an outdoor unit that does not use refrigerant R22, R410A or R407C.
- The existing pipe must have a wall thickness equal to or larger than the following thickness.

| Reference outside diameter (mm) | Wall thickness (mm) |
|---------------------------------|---------------------|
| Ø9.5                            | 0.8                 |
| Ø15.9                           | 1.0                 |
| Ø19.1                           | 1.0                 |

- Never use any pipe with a wall thickness less than these thicknesses due to insufficient pressure capacity.

# 7.CIRCUIT CONFIGURATION AND CONTROL SPECIFICATIONS

## 7-1. Outdoor unit control

### 7-1-1. Prim circuit board (MCC-1630)

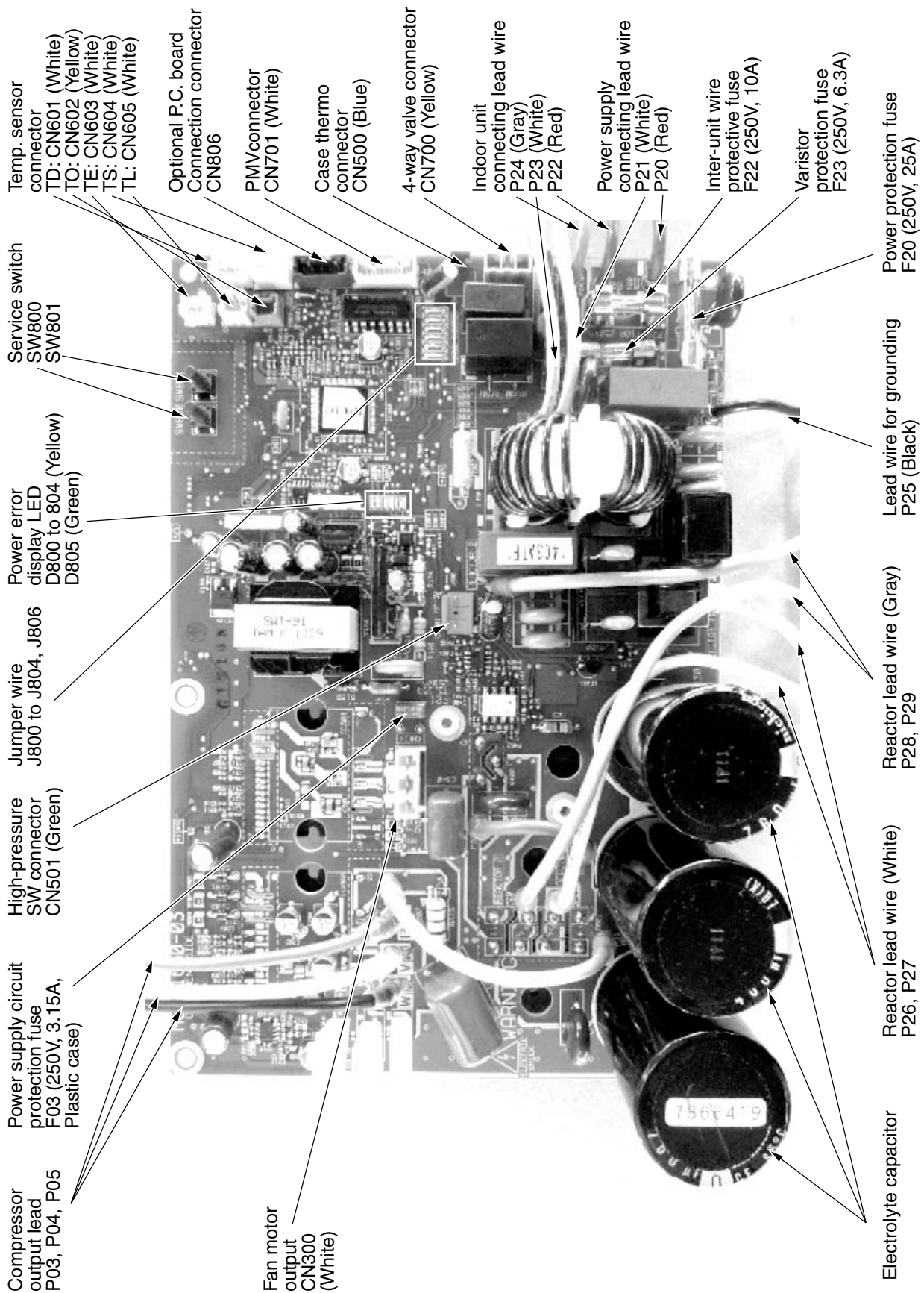

## 7-1-2. Outline of Main Controls

### 1. Pulse Modulating Valve (PMV) control

- 1) For PMV with 50 to 500 pulses during operation, respectively.
- 2) In cooling operation, PMV is controlled with the temperature difference between TS sensor and TC sensor.
- 3) In heating operation, PMV is controlled with the temperature difference between TS sensor and TE sensor.
- 4) For the temperature difference in items 2) and 3), 1 to 5K is aimed as the target in both cooling and heating operations.
- 5) When the cycle excessively rose in both cooling and heating operations, PMV is controlled by TD sensor.  
The aimed value is usually 92°C for SM110, SM140 in both cooling and heating operations.

## REQUIREMENT

---

A sensor trouble may cause a liquid back-flow or abnormal overheat resulting in excessive shortening of the compressor life. In a case of trouble on the compressor, be sure to check there is no error in the resistance value an the refrigerating cycle of each sensor after repair and then start the operation.

---

### 2. Discharge temperature release control

- 1) When the discharge temperature did not fall or the discharge temperature rapidly went up by PMV control, this control lowers the operation frequency. It subdivides the frequency control up to 0.6Hz to stabilize the cycle.
- 2) When the discharge temperature detected an abnormal stop zone, the compressor stops and then restarts after 2 minutes 30 seconds.  
The error counting is cleared when the operation continued for 10 minutes. If the error is detected by 4 times without clearing, the error is determined and restarting is not performed.  
\* The cause is considered as excessively little amount of refrigerant, PMV error or clogging of the cycle.
- 3) For displayed contents of error, confirm on the check code list.

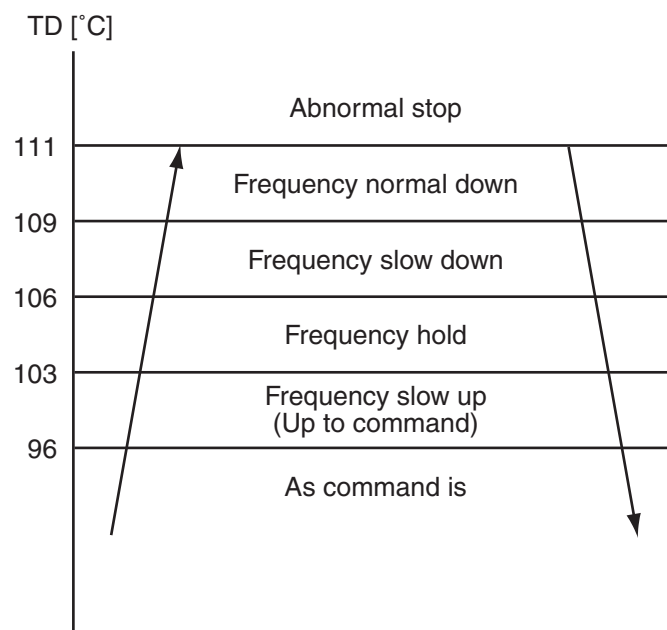



### 3. Current release control

The output frequency and the output voltage are controlled by AC current value detected by T20 on the outdoor P.C. board so that input current of the inverter does not exceed the specified value.

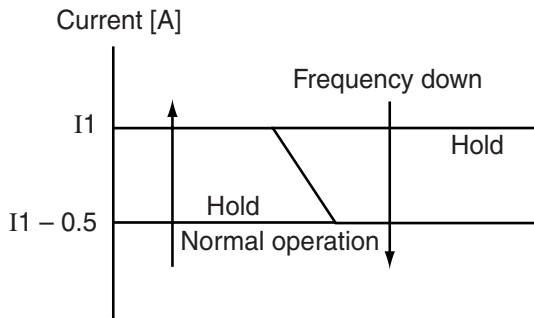

| Objective model | SM110 |      | SM140 |      |
|-----------------|-------|------|-------|------|
|                 | COOL  | HEAT | COOL  | HEAT |
| I1 value [A]    | 20.4  | 21.2 | 21.2  | 21.2 |

### 4. Outdoor fan control

Allocations of fan tap revolutions [rpm]

|       | W1  | W2  | W3  | W4  | W5  | W6  | W7  | W8  | W9  | WA  | WB  | WC  | WD  | WE  | WF  |
|-------|-----|-----|-----|-----|-----|-----|-----|-----|-----|-----|-----|-----|-----|-----|-----|
| SM110 | 250 | 280 | 320 | 360 | 410 | 460 | 520 | 580 | 640 | 700 | 760 | 880 | 880 | 900 | 930 |
| SM140 | 250 | 280 | 320 | 360 | 410 | 460 | 520 | 580 | 640 | 700 | 760 | 880 | 880 | 900 | 970 |

#### 4-1. Cooling fan control

- 1) An outdoor fan is controlled by TL sensor, TO sensor and operation frequency. An outdoor fan is controlled at 1-tap interval of DC fan control.
- 2) At the start time, the fan is fixed for 60 seconds only with the maximum fan tap corresponded to the zone in the following table but it is controlled with TL sensor temperature after then.

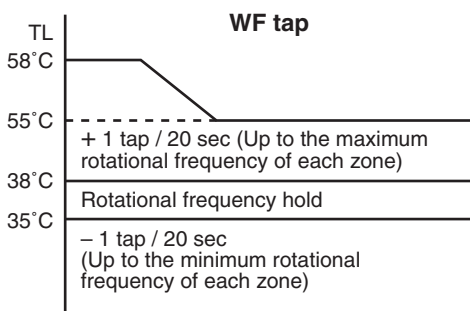

| Temp. range  | SM110 | Under 30.0 Hz |      | Over 30.0, under 43.8 Hz |                      | Over 43.8 Hz |                      |
|--|-------|---------------|------|--------------------------|----------------------|--------------|----------------------|
|  | SM140 | Under 34.2 Hz |      | Over 34.2, under 52.2 Hz |                      | Over 52.2 Hz |                      |
|  |       | MIN.          | MAX. | MIN.                     | MAX.                 | MIN.         | MAX.                 |
| $38^{\circ}\text{C} \leq \text{TO}$                      |       | W6            | WB   | W8                       | SM110:WD<br>SM140:WF | WA           | SM110:WD<br>SM140:WF |
| $29^{\circ}\text{C} \leq \text{TO} < 38^{\circ}\text{C}$ |       | W5            | WA   | W7                       | WD                   | W9           | SM110:WD<br>SM140:WF |
| $15^{\circ}\text{C} \leq \text{TO} < 29^{\circ}\text{C}$ |       | W3            | W7   | W5                       | W9                   | W7           | WB                   |
| $5^{\circ}\text{C} \leq \text{TO} < 15^{\circ}\text{C}$  |       | W2            | W5   | W4                       | W7                   | W6           | W9                   |
| $0^{\circ}\text{C} \leq \text{TO} < 5^{\circ}\text{C}$   |       | W1            | W3   | W3                       | W5                   | W4           | W7                   |
| $-4^{\circ}\text{C} \leq \text{TO} < 0^{\circ}\text{C}$  |       | W1            | W2   | W2                       | W4                   | W3           | W5                   |
| $\text{TO} < -4^{\circ}\text{C}$                         |       | OFF           | OFF  | OFF                      | OFF                  | OFF          | OFF                  |
| TO error   |       | OFF           | WB   | OFF                      | SM110:WD<br>SM140:WF | OFF          | SM110:WD<br>SM140:WF |

## 4-2. Heating fan control

- 1) An outdoor fan is controlled by TE sensor, TO sensor and operation frequency. (It is controlled with W1 for minimum and the maximum is controlled according to the following table.)
- 2) At the start time, the fan is fixed for 3 minutes only with the maximum fan tap corresponded to the zone in the following table but it is controlled with TE sensor temperature after then.
- 3) When a status  $TE \geq 24^\circ\text{C}$  continues for 5 minutes, the operation stops. In this case, no error display appears and the status is same as the normal thermo-OFF. The can restarts after approx. 2 minutes 30 seconds and this continuous operation is not an error.
- 4) When the above status as 3) occurs frequently, it is considered that filter of the suction part of the indoor unit is dirty. Clean the filter and restart the operation.

| TE   | SM110   | Under 31.2 Hz       | Over 31.2, under 47.4 Hz | Over 47.4 Hz             |
|------|---|---------------------|--------------------------|--------------------------|
|      |   | SM140               | Under 36.0 Hz            | Over 36.0, under 55.8 Hz |
| 24°C | - 2 tap / 20 seconds (up to W1)<br>Stop timer count |                     | MAX.                     | MAX.                     |
| 21°C | - 2 tap / 20 seconds (up to W1)                     | MAX.                | MAX.                     | MAX.                     |
| 18°C | - 1 tap / 20 seconds (up to W1)                     | 10°C ≤ TO           | W7                       | W8                       |
| 15°C | Rotational frequency hold                           | 5°C ≤ TO < 10°C     | WF                       | WF                       |
|      | + 1 tap / 20 seconds (up to Max. tap of each zone)  | - 3°C ≤ TO < 5°C    | WF                       | WF                       |
|      |   | - 10°C ≤ TO < - 3°C | WF                       | WF                       |
|      |   | TO < - 10°C         | WF                       | WF                       |
|      |   | TO error            | WF                       | WF                       |

## 5. Coil heating control

- 1) This control function heats the compressor by turning on the stopped compressor instead of a case heater. It purposes to prevent stagnation of the refrigerant inside of the compressor.
- 2) As usual, turn on power of the compressor for the specified time before a test run after installation; otherwise a trouble of the compressor may be caused.  
As same as a test run, it is recommended to turn on power of the compressor beforehand when starting operation after power of the compressor has been interrupted and left as it is for a long time.
- 3) A judgment for electricity is performed by TD and TO sensors.  
If TO sensor is defective, a backup control is automatically performed by TE sensor.  
For a case of defective TO sensor, judge it with outdoor LED display.
- 4) For every model, the power is turned off when TD is 30°C or more.

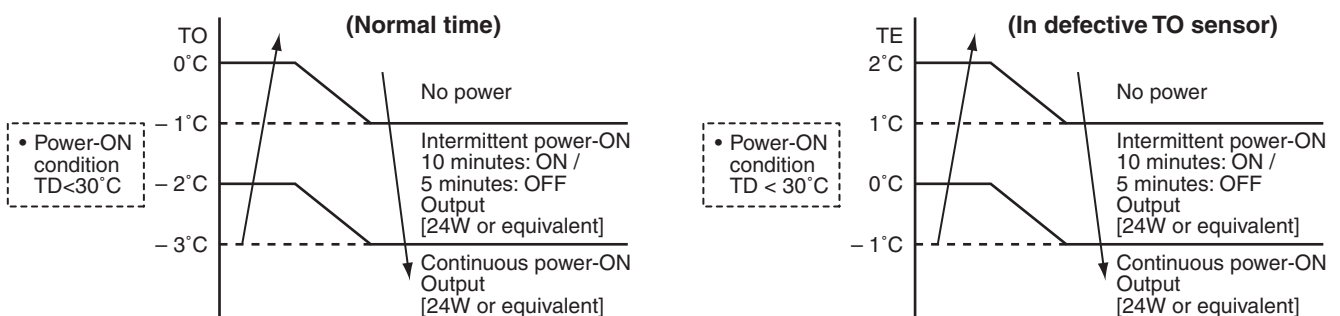

## REQUIREMENT

While heating the coil, the power sound may be heard. However it is not a trouble.

## 6. Short intermittent operation preventive control

- 1) For 3 to 10 minutes after operation start, in some cases, the compressor does not stop to protect the compressor even if receiving the thermostat-OFF signal from indoor.  
However it is not abnormal status. (The operation continuance differs according to the operation status.)
- 2) When the operation stops by the remote controller, the operation does not continue.

## 7. Current release value shift control

- 1) This control purposes to prevent troubles of the electronic parts such as the compressor driving elements and the compressor during cooling operation.
- 2) The current release control value (I1) is selected from the following table according to TO sensor value.

Current release control value (I1) [A]

| Temperature range  | SM110 | SM140 |
|--|-------|-------|
| $47^{\circ}\text{C} \leq \text{TO}$                      | 15.0  | 15.5  |
| $44^{\circ}\text{C} \leq \text{TO} < 47^{\circ}\text{C}$ | 16.8  | 17.4  |
| $39^{\circ}\text{C} \leq \text{TO} < 44^{\circ}\text{C}$ | 17.7  | 18.3  |
| TO error   | 15.0  | 15.5  |

## 8. Over-current protective control

- 1) When the over-current protective circuit detected an abnormal current, stop the compressor.
- 2) The compressor restarts after 2 minutes 30 seconds setting [1] as an error count.
- 3) When the error count [8] was found, determine an error and restart operation is not performed.
- 4) For the error display contents, confirm on the check code list.

## 9. High-pressure release control

- 1) The operation frequency is controlled to restrain abnormal rising of high pressure by TL sensor in cooling operation and TC sensor in heating operation.
- 2) When TL sensor in cooling operation or TC sensor in heating operation detects abnormal temperature of the stop zone, stop the compressor and the error count becomes +1.
- 3) When the compressor stopped with 2), the operation restarts from the point of the normal operation zone (e point or lower) where it returned after 2 minutes 30 seconds.
- 4) The error count when the compressor stopped with 2) is cleared after the operation continued for 10 minutes.

If the error count becomes [10] without clearing, the error is determined and reactivation is not performed.

- 5) For the error display contents, confirm on the check code list.

HEAT TC / COOL TL  
[°C]

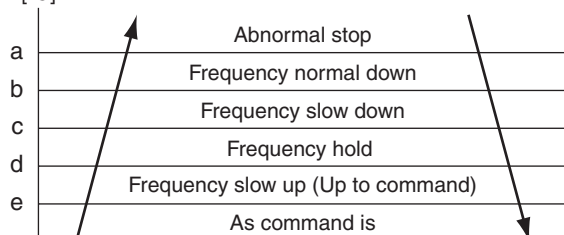

|   | HEAT | COOL |
|---|------|------|
|   | TC   | TL   |
| a | 62°C | 63°C |
| b | 57°C | 62°C |
| c | 55°C | 60°C |
| d | 53°C | 58°C |
| e | 49°C | 54°C |

## 10. Defrost control

- ① In heating operation, defrost operation is performed when TE sensor temperature satisfies any condition in A zone to D zone.
- ② The defrost operation is immediately finished if TE sensor temperature has become 12°C or more, or it also is finished when condition of  $7^{\circ}\text{C} \leq \text{TE} < 12^{\circ}\text{C}$  has continued for 1 minute. The defrost operation is also finished when defrost operation has continued for 10 minutes even if TE sensor temperature has become 7°C or lower.
- ③ After defrost operation has finished, the compressor and the outdoor fan start heating operation after stopped for approx. 40 seconds.

## Start of heating operation

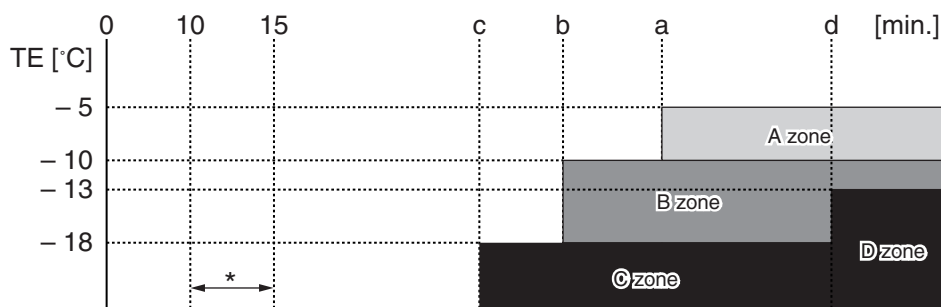

\* From 10 minutes to 15 minutes after a heating operation started, the minimum value of TE is stored in memory as TEO and the minimum temperature of TO as ToO.

|               | At normal TO  | At error TO  |
|---------------|---|--|
| <b>A zone</b> | When status of $[(TEO - TE) - (ToO - TO) \geq 3^{\circ}C]$ continued for 20 seconds | When status of $[(TEO - TE) \geq 3^{\circ}C]$ continued for 20 seconds |
| <b>B zone</b> | When status of $[(TEO - TE) - (ToO - TO) \geq 2^{\circ}C]$ continued for 20 seconds | When status of $[(TEO - TE) \geq 2^{\circ}C]$ continued for 20 seconds |
| <b>C zone</b> | When status of $[TE \leq -18^{\circ}C]$ continued for 20 seconds                    |  |
| <b>D zone</b> | When compressor operation status with $TE \leq -13^{\circ}C$ are added by d times   |  |

|          | SM110, SM140 |
|----------|--------------|
| <b>a</b> | 55           |
| <b>b</b> | 39           |
| <b>c</b> | 29           |
| <b>d</b> | 90           |

## 11. High-pressure switch

- 1) When the high-pressure switch operates, the operation of the compressor is terminated.
- 2) The compressor restarts after 5 minutes using [1] as an error count.  
After restart, the error count is cleared when operation continues for 10 minutes or more.
- 3) An error is confirmed with the error count [10].
- 4) For the indicated contents of error, confirm using the check code table.

## 12 Control of compressor case thermo

- 1) The compressor stops when the case thermo of the compressor operated.
- 2) When the case thermo operated for approx. 80 seconds, E04 error code (same as serial error) is displayed on the wired remote controller. → Refer to the Check Code.
- 3) When the case thermo is reset, the operation restarts.

## 8. TROUBLESHOOTING

### 8-1. Summary of Troubleshooting

<Wired remote controller type>

#### 1. Before troubleshooting

- 1) Required tools/instruments
  - ⊕ and ⊖ screwdrivers, spanners, radio cutting pliers, nippers, push pins for reset switch
  - Tester, thermometer, pressure gauge, etc.
- 2) Confirmation points before check
  - a) The following operations are normal.
    1. Compressor does not operate.
      - Is not 3-minutes delay (3 minutes after compressor OFF)?
      - Is not the outdoor unit in standby status though the remote controller reached the setup temperature?
      - Does not timer operate during fan operation?
      - Is not an overflow error detected on the indoor unit?
      - Is not outside high-temperature operation controlled in heating operation?
    2. Indoor fan does not rotate.
      - Does not cool air discharge preventive control work in heating operation?
    3. Outdoor fan does not rotate or air volume changes.
      - Does not high-temperature release operation control work in heating operation?
      - Does not outside low-temperature operation control work in cooling operation?
      - Is not defrost operation performed?
    4. ON/OFF operation cannot be performed from remote controller.
      - Is not the control operation performed from outside/remote side?
      - Is not automatic address being set up?  
(When the power is turned on at the first time or when indoor unit address setting is changed, the operation cannot be performed for maximum approx. 5 minutes after power-ON.)
      - Is not being carried out a test run by operation of the outdoor controller?
  - b) Did you return the cabling to the initial positions?
  - c) Are connecting cables of indoor unit and remote controller correct?

#### 2. Troubleshooting procedure

When a trouble occurred, check the parts along with the following procedure.



#### NOTE

---

For cause of a trouble, power conditions or malfunction/erroneous diagnosis of microcomputer due to outer noise is considered except the items to be checked.

If there is any noise source, change the cables of the remote controller to shield cables.

---

## <Wireless remote controller type>

### 1. Before troubleshooting

- 1) Required tools/instruments
  - ⊕ and ⊖ screwdrivers, spanners, radio cutting pliers, nippers, etc.
  - Tester, thermometer, pressure gauge, etc.
- 2) Confirmation points before check
  - a) The following operations are normal.
    1. Compressor does not operate.
      - Is not 3-minutes delay (3 minutes after compressor OFF)?
      - Is not the outdoor unit in standby status though the remote controller reached the setup temperature?
      - Does not timer operate during fan operation?
      - Is not an overflow error detected on the indoor unit?
      - Is not outside high-temperature operation controlled in heating operation?
    2. Indoor fan does not rotate.
      - Does not cool air discharge preventive control work in heating operation?
- 3) Outdoor fan does not rotate or air volume changes.
  - Does not high-temperature release operation control work in heating operation?
  - Does not outside low-temperature operation control work in cooling operation?
  - Is not defrost operation performed?
- 4) ON/OFF operation cannot be performed from remote controller.
  - Is not forced operation performed?
  - Is not the control operation performed from outside/remote side?
  - Is not automatic address being set up?
  - Is not being carried out a test run by operation of the outdoor controller?
    - a) Did you return the cabling to the initial positions?
    - b) Are connecting cables between indoor unit and receiving unit correct?

### 2. Troubleshooting procedure

(When the power is turned on at the first time or when indoor unit address setting is changed, the operation cannot be performed for maximum approx. 5 minutes after power-ON.)

When a trouble occurred, check the parts along with the following procedure.

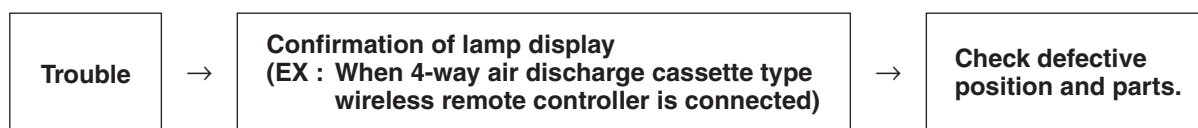

#### 1) Outline of judgment

The primary judgment to check where a trouble occurred in indoor unit or outdoor unit is performed with the following method.

---

### Method to judge the erroneous position by flashing indication on the display part of indoor unit (sensors of the receiving unit)

---

The indoor unit monitors operating status of the air conditioner, and the blocked contents of self-diagnosis are displayed restricted to the following cases if a protective circuit works.

## 8-2. Troubleshooting

### 8-2-1. Outline of judgment

The primary judgment to check whether a trouble occurred in the indoor unit or outdoor unit is carried out with the following method.

Method to judge the erroneous position by flashing indication on the display part of the indoor unit (sensors of the receiving part)

The indoor unit monitors the operating status of the air conditioner, and the blocked contents of self-diagnosis are displayed restricted to the following cases if a protective circuit works.

● : Go off, ○ : Go on, ☼ : Flash (0.5 sec.)

| Lamp indication  | Check code  | Cause of trouble occurrence  |  |
|--|---|--|--|
| Operation   Timer   Ready<br>●   ●   ●<br>No indication at all | —   | Power supply OFF or miswiring between receiving unit and indoor unit   |  |
| Operation   Timer   Ready<br>☼   ●   ●<br>Flash                | E01   | Receiving error } Receiving unit } Miswiring or wire connection error between receiving unit and indoor unit<br>Sending error }<br>Communication stop }  |  |
|  | E02   |  |  |
|  | E03   |  |  |
|  | Operation   Timer   Ready<br>☼   ●   ●<br>Flash   | E08  | Duplicated indoor unit No. Setup error   |
|  |   | E09  |  |
|  |   | E10  | Communication error between CPUs on indoor unit P.C. board   |
|  |   | E18  | Wire connection error between indoor units, Indoor power OFF (Communication stop between indoor master and follower or between main and sub indoor twin) |
| Operation   Timer   Ready<br>●   ●   ☼<br>Flash                | E04   | Miswiring between indoor unit and outdoor unit or connection error (Communication stop between indoor and outdoor units)<br>Outdoor unit case thermostat work on ..... Comp. overheating<br>Outdoor wiring error |  |
| Operation   Timer   Ready<br>●   ☼   ☼<br>Alternate flash      | P01   | Overflow was detected. } Protective device of indoor unit worked.<br>Indoor DC fan error }   |  |
|  | P10   |  |  |
|  | P12   |  |  |
| Operation   Timer   Ready<br>☼   ●   ☼<br>Alternate flash      | P03   | Outdoor unit discharge temp. error } Protective device of outdoor unit worked. *1<br>Case thermostat work on,<br>Power error, High pressure protection }   |  |
|  | P04   |  |  |
|  | P05   | Negative phase detection error } Outdoor unit error<br>Heat sink overheat error }<br>Gas leak detection error }  |  |
|  | P07   |  |  |
|  | P15   |  |  |
|  | P19   | 4-way valve system error (Indoor or outdoor unit judged.)  |  |
|  | P20   | Outdoor unit high pressure protection  |  |
|  | P22   | Outdoor unit: Outdoor unit fan error } Protective device of outdoor unit worked. *1<br>Outdoor unit: Inverter Idc operation }<br>Outdoor unit: Position detection error }  |  |
|  | P26   |  |  |
|  | P29   |  |  |
| P31  | Stopped because of error of other indoor unit in a group (Check codes of E03/L03/L07/L08) |  |  |

1: These are representative examples and the check code differs according to the outdoor unit to be combined.

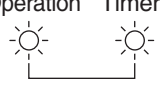
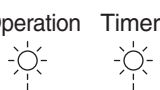
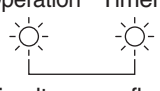
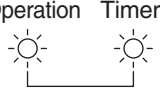
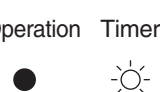
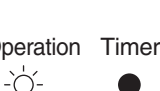
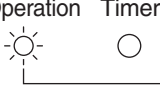
| Lamp indication  | Check code   | Cause of trouble occurrence   |
|--|--|---|
| Operation Timer Ready<br><br>Alternate flash      | F01  | Heat exchanger sensor (TCJ) error }<br>Indoor unit sensor error<br>Heat exchanger sensor (TC) error }<br>Heat exchanger sensor (TA) error }   |
|  | F02  |   |
|  | P10  |   |
| Operation Timer Ready<br><br>Alternate flash      | F04  | Discharge temp. sensor (TD) error }<br>Sensor error of outdoor unit *1<br>Temp. sensor (TE) error }<br>Temp. sensor (TL) error }<br>Temp. sensor (TO) error }<br>Temp. sensor (TS) error }<br>Temp. sensor (TH) error }<br>Temp. Sensor miswiring (TE, TS) }  |
|  | F06  |   |
|  | F07  |   |
|  | F08  |   |
|  | F12  |   |
|  | F13  |   |
| Operation Timer Ready<br><br>Simultaneous flash   | F29  | Indoor EEPROM error   |
|  | Operation Timer Ready<br><br>Simultaneous flash | F31   |
| Operation Timer Ready<br><br>Flash               |  | H01   |
|  | H02  |   |
|  | H03  | Power supply, outdoor P.C. board error  |
| Operation Timer Ready<br><br>Simultaneous flash | L03  | Duplicated header indoor units }<br>→ AUTO address<br>* If group construction and<br>address are not normal<br>power supply turned on,<br>automatically goes to<br>address setup mode.<br>There is indoor unit of group connection }<br>in individual indoor unit.<br>Unsetting of group address<br>Missed setting<br>(Unset indoor capacity) |
|  | L07  |   |
|  | L08  |   |
|  | L09  |   |
| Operation Timer Ready<br><br>Simultaneous flash | L10  | Unset model type (Service board)  |
|  | L20  | Duplicated indoor central addresses   |
|  | L30  | Outside interlock error   |

\*1: These are representative examples and the check code differs according to the outdoor unit to be combined.

## 8-2-2. Others (Other than Check Code)

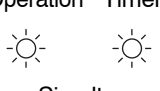
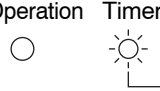
| Lamp indication  | Check code | Cause of trouble occurrence   |
|--|------------|---|
| Operation Timer Ready<br><br>Simultaneous flash | —          | During test run   |
| Operation Timer Ready<br><br>Alternate flash    | —          | Disagreement of cool/heat<br>(Automatic cool/heat setting to automatic cool/heat prohibited model, or setting of heating to cooling-only model) |



## 8-2-3. Monitor Function of Remote Controller Switch

### ■ Calling of sensor temperature display

#### <Contents>

Each data of the remote controller, indoor unit and outdoor unit can be understood by calling the service monitor mode from the remote controller.

#### <Procedure>

- 1 Push **TEST** + **CL** buttons simultaneously for 4 seconds to call the service monitor mode.

The service monitor goes on, the master indoor unit No. is displayed at first and then the temperature of CODE No. **00** is displayed.

- 2 Push temperature set **TEMP.** buttons and then change the CODE No. of data to be monitored.

The CODE No. list is shown below.

#### <RBC-AMT32E>

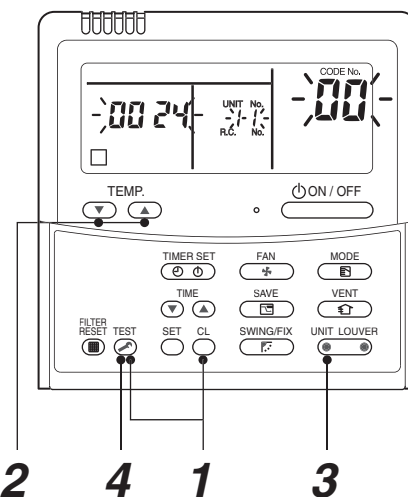

<Operation procedure>

**1 → 2 → 3 → 4**

Returned to usual display

|                  | CODE No. | Data name                                      | Unit  |
|------------------|----------|--|-------|
| Indoor unit data | 01       | Room temperature (Remote controller)           | °C    |
|                  | 02       | Indoor suction temperature (TA)                | °C    |
|                  | 03       | Indoor heat exchanger (Coil) temperature (TCJ) | °C    |
|                  | 04       | Indoor heat exchanger (Coil) temperature (TC)  | °C    |
|                  | * 07     | Indoor fan revolution frequency                | rpm   |
|                  | * F2     | Indoor fan calculated operation time           | ×100h |
|                  | F3       | Filter sign time                               | ×1h   |
|                  | * F8     | Indoor discharge temperature*1 (4-way only)    | °C    |

|                   | CODE No. | Data name                                      | Unit  |
|-------------------|----------|--|-------|
| Outdoor unit data | 60       | Outdoor heat exchanger (Coil) temperature (TE) | °C    |
|                   | 61       | Outside temperature (TO)                       | °C    |
|                   | 62       | Compressor discharge temperature (TD)          | °C    |
|                   | 63       | Compressor suction temperature (TS)            | °C    |
|                   | 65       | Heat sink temperature (TH)                     | °C    |
|                   | 6A       | Operation current (× 1/10)                     | A     |
|                   | * 6D     | Outdoor heat exchanger (Coil) temperature (TL) | °C    |
|                   | * 70     | Compressor operation frequency                 | rps   |
|                   | * 72     | Outdoor fan revolution frequency (Lower)       | rpm   |
|                   | * 73     | Outdoor fan revolution frequency (Upper)       | rpm   |
|                   | F1       | Compressor calculated operation time           | ×100h |

- The CODE No. with \* marks in the above table are displayed only on the indoor units of 4 series models and after. (4 series indoor units mean RAV-SM1404UT-E for example.).
- The indoor discharge temperature of CODE No. [F8] is the estimated value from TC or TCJ sensor. Use this value to check discharge temperature at test run. (A discharge temperature sensor is not provided to this model.)
- The data value of each item is not the real time, but value delayed by a few seconds to ten-odd seconds.

- 3 Push **UNIT LOUVER** button to select the indoor unit to be monitored. Each data of the indoor unit and its outdoor units can be monitored.

- 4 Pushing **TEST** button returns the status to the usual display.

## 8-2-4. Check Code List (Outdoor)

○ : Go on, ◎ : Flash, ● : Go off

ALT (Alternate): Alternate flashing when there are two flashing LED SIM (Simultaneous): Simultaneous flashing when there are two flashing LED

| Central control indication | Remote controller indication | Sensor lamp part |       |       |       | Representative defective position   | Detection         | Explanation of error contents  | Automatic reset | Operation continuation |
|----------------------------|------------------------------|------------------|-------|-------|-------|---|-------------------|--|-----------------|------------------------|
|                            |                              | Block indication |       |       |       |   |                   |  |                 |                        |
|                            |                              | Operation        | Timer | Ready | Flash |   |                   |  |                 |                        |
| 19                         | F04                          | ◎                | ◎     | ○     | ALT   | Outdoor unit Discharge temp. sensor (TD) error                                      | Outdoor           | Open/Short of discharge temp. sensor was detected.   | ×               | ×                      |
| 18                         | F06                          | ◎                | ◎     | ○     | ALT   | Outdoor unit Temp. sensor (TE, TS, TL) error  | Outdoor           | Open/Short of heat exchanger temp. sensor was detected.<br>Miswiring between TE sensor and TS sensor   | ×               | ×                      |
| 1d                         | F08                          | ◎                | ◎     | ○     | ALT   | Outdoor unit Outside temp. sensor (TO) error  | Outdoor           | Open/Short of outside temp. sensor was detected.   | ○               | ○                      |
| 18                         | F07                          | ◎                | ◎     | ○     | ALT   | Outdoor unit Temp. sensor (TL) error  | Outdoor           | Open/Short of heat exchanger temp. sensor was detected.  | ×               | ×                      |
| A2                         | F12                          | ◎                | ◎     | ○     | ALT   | Outdoor unit Temp. sensor (TS) error  | Outdoor           | Open/Short of suction temp. sensor was detected.   | ×               | ×                      |
| 43                         | F13                          | ◎                | ◎     | ○     | ALT   | Outdoor unit Temp. sensor (TH) error  | Outdoor           | Open/Short of heat sink temp. sensor (Board installed) was detected.   | ×               | ×                      |
| 18                         | F15                          | ◎                | ◎     | ○     | ALT   | Outdoor unit Misconnection of temp. sensor (TE, TS)                                 | Outdoor           | Misconnection of outdoor heat exchanger temp. sensor and suction temp. sensor was detected.  | ×               | ×                      |
| IC                         | F31                          | ◎                | ◎     | ○     | SIM   | Outdoor unit EEPROM error   | Outdoor           | Outdoor P.C. board part (EEPROM) error was detected.   | ×               | ×                      |
| 1F                         | H01                          | ●                | ◎     | ●     |       | Outdoor unit Compressor break down  | Outdoor           | When reached min-Hz by current release control, short-circuited current (Idc) after DC excitation was detected.  | ×               | ×                      |
| 1d                         | H02                          | ●                | ◎     | ●     |       | Outdoor unit Compressor lock  | Outdoor           | Compressor lock was detected.  | ×               | ×                      |
| 17                         | H03                          | ●                | ◎     | ●     |       | Outdoor unit Current detection circuit error  | Outdoor           | Current detection circuit error  | ×               | ×                      |
| 88                         | L10                          | ◎                | ○     | ◎     | SIM   | Outdoor unit Setting error of service P.C. board type                               | Outdoor           | When outdoor service P.C. board was used, model type select jumper setting was inappropriate.  | ×               | ×                      |
| 1E                         | P03                          | ◎                | ●     | ◎     | ALT   | Outdoor unit Discharge temp. error  | Outdoor           | Error was detected by discharge temp. release control.   | ×               | ×                      |
| 21                         | P04                          | ◎                | ●     | ◎     | ALT   | Outdoor unit High pressure system error, Power supply voltage error                 | Outdoor           | When case thermostat worked, error was detected by high release control from indoor/outdoor heat exchanger temp. sensor. Power supply voltage error                  | ×               | ×                      |
| AF                         | P05                          | ◎                | ●     | ◎     | ALT   | Power supply error  | Outdoor           | Power supply voltage error   | ×               | ×                      |
| 1C                         | P07                          | ◎                | ●     | ◎     | ALT   | Outdoor unit Heat sink overheat   | Outdoor           | Abnormal overheat was detected by outdoor heat sink temp. sensor.  | ×               | ×                      |
| AE                         | P15                          | ◎                | ●     | ◎     | ALT   | Gas leak detection  | Outdoor           | Abnormal overheat of discharge temp. or suction temp. was detected.  | ×               | ×                      |
| 22                         | P20                          | ◎                | ●     | ◎     | ALT   | Outdoor unit High pressure system error   | Outdoor           | Error was detected by high release control from indoor/outdoor heat exchanger temp. sensor.  | ×               | ×                      |
| 1A                         | P22                          | ◎                | ●     | ◎     | ALT   | Outdoor unit Outdoor fan error  | Outdoor           | Error (Over-current, lock, etc.) was detected on outdoor fan drive circuit.  | ×               | ×                      |
| 14                         | P26                          | ◎                | ●     | ◎     | ALT   | Outdoor unit Inverter Idc operation   | Outdoor           | Short-circuited protective operation of compressor drive circuit element (G-Tr /IGBT) worked.  | ×               | ×                      |
| 16                         | P29                          | ◎                | ●     | ◎     | ALT   | Outdoor unit Position detection error   | Outdoor           | Position detection error of compressor motor was detected.   | ×               | ×                      |
| 97                         | E01                          | ◎                | ●     | ●     |       | No remote controller master unit<br>Remote controller communication error           | Remote controller | Signal was not received from indoor unit.<br>Main remote controller was not set. (including 2 remote controllers)  | —               | —                      |
| —                          | E02                          | ◎                | ●     | ●     |       | Remote controller send error  | Remote controller | Signal cannot be sent to indoor unit.  | —               | —                      |
| 97                         | E03                          | ◎                | ●     | ●     |       | Regular communication error between indoor and remote controller                    | Indoor            | No communication from remote controller and network adapter  | ○               | ×                      |
| 04                         | E04                          | ●                | ●     | ◎     |       | Indoor/Outdoor serial error, Case thermostat operation of the outdoor unit occurred | Indoor            | Serial communication error between indoor and outdoor, Case thermostat operation occurred  | ○               | ×                      |
| 96                         | E08                          | ◎                | ●     | ●     |       | Duplicated indoor addresses   | ◇                 | Indoor Same address as yours was detected.   | ○               | ×                      |
| 99                         | E09                          | ◎                | ●     | ●     |       | Duplicated main remote controllers  | Remote controller | In 2-remote controller control, both were set as master. (Indoor master unit stops warning and follower unit continues operation.)                                   | ×               | ×                      |
| CF                         | E10                          | ◎                | ●     | ●     |       | Communication error between CPU   | Indoor            | MCU communication error between main motor and micro computer  | ○               | △                      |
| 97,99                      | E18                          | ◎                | ●     | ●     |       | Regular communication error between master and follower indoor units                | Indoor            | Regular communication was impossible between master and follower indoor units. Communication between twin master (Main unit) and follower (sub unit) was impossible. | ○               | ×                      |
| 96                         | L03                          | ◎                | ●     | ◎     | SIM   | Duplicated indoor master units  | ◇                 | Indoor There are multiple master units in a group.   | ×               | ×                      |
| 99                         | L07                          | ◎                | ●     | ◎     | SIM   | There is group cable in individual indoor unit.                                     | ◇                 | Indoor When even one group connection indoor unit exists in individual indoor unit   | ×               | ×                      |
| 99                         | L08                          | ◎                | ●     | ◎     | SIM   | Unset indoor group address  | ◇                 | Indoor Indoor address group was unset.   | ×               | ×                      |
| 46                         | L09                          | ◎                | ●     | ◎     | SIM   | Unset indoor capacity   | Indoor            | Capacity of indoor unit was unset.   | ×               | ×                      |
| 66                         | L30                          | ◎                | ○     | ◎     | SIM   | Outside error input to indoor unit (Interlock)                                      | Indoor            | Abnormal stop by CN80 outside error input  | ×               | ×                      |
| 08                         | P19                          | ◎                | ●     | ◎     | ALT   | 4-way valve inverse error   | Indoor<br>Outdoor | In heating operation, error was detected by temp. down of indoor heat exchanger or temp. up of TE, TS.   | ○               | ×                      |

◇ When this warning was detected before group construction/address check finish at power supply was turned on, the mode shifts automatically to AUTO address setup mode.

○ : Go on, ◎ : Flash, ● : Go off

ALT (Alternate): Alternate flashing when there are two flashing LED SIM (Simultaneous): Simultaneous flashing when there are two flashing LED

| Central control indication | Remote controller indication | Sensor lamp part         |       |       |       | Representative defective position             | Detection              | Explanation of error contents   | Automatic reset | Operation continuation |
|----------------------------|------------------------------|--------------------------|-------|-------|-------|---|------------------------|---|-----------------|------------------------|
|                            |                              | Block indication         |       |       |       |   |                        |   |                 |                        |
|                            |                              | Operation                | Timer | Ready | Flash |   |                        |   |                 |                        |
| 0F                         | F01                          | ◎                        | ◎     | ●     | ALT   | Indoor unit Heat exchanger sensor (TCJ) error | Indoor                 | Open/Short of heat exchanger (TCJ) was detected.  | ○               | ×                      |
| 0d                         | F02                          | ◎                        | ◎     | ●     | ALT   | Indoor unit Heat exchanger sensor (TC) error  | Indoor                 | Open/Short of heat exchanger (TC) was detected.   | ○               | ×                      |
| 0C                         | F10                          | ◎                        | ◎     | ●     | ALT   | Indoor unit Room temp. sensor (TA) error      | Indoor                 | Open/Short of room temp. (TA) was detected.   | ○               | ×                      |
| 12                         | F29                          | ◎                        | ◎     | ●     | SIM   | Indoor unit Other indoor P.C. board error     | Indoor                 | EEPROM error (Other error may be detected. If no error, automatic address is repeated.)   | ×               | ×                      |
| 11                         | P01                          | ●                        | ◎     | ◎     | ALT   | Indoor unit Indoor fan error                  | Indoor                 | Indoor AC fan error was detected. (Fan thermal relay worked.)   | ×               | ×                      |
| 0b                         | P10                          | ●                        | ◎     | ◎     | ALT   | Indoor unit Overflow detection                | Indoor                 | Float switch worked.  | ×               | ×                      |
| 11                         | P12                          | ●                        | ◎     | ◎     | ALT   | Indoor unit Indoor fan error                  | Indoor                 | Indoor fan error (Over-current / Lock, etc.) was detected.  | ×               | ×                      |
| 47                         | P31                          | ◎                        | ●     | ◎     | ALT   | Other indoor unit error                       | Indoor                 | Other indoor under condition of warning in group. E03/L07/L03/L08 warning   | ○               | ×                      |
| 67                         | —                            | By unit with warning No. |       |       | ALT   | Error in indoor group                         | Network adapter        | Sub remote controller error in a group (Details of remote controller are displayed with unit No. Only central control side is displayed.) | —               | —                      |
| 97                         | —                            | —                        |       |       |       | LAN system communication error                | Network adapter/Center | Communication error of central control system signal * Is not displayed on the remote controller  | ○               | ○                      |
| 98                         | L20                          | ◎                        | ○     | ◎     | SIM   | LAN system communication error                | Network adapter/Center | Duplicated indoor address of central control system communication   | ○               | ×                      |
| 99                         | —                            | —                        |       |       |       | There are multiple communication adapters.    | Network adapter        | There are multiple communication adapters on remote controller communication line.  | ○               | ○                      |

## Error mode detected by indoor unit

| Operation of diagnostic function |   |  |                                  | Judgment and measures   |
|----------------------------------|---|--|----------------------------------|---|
| Check code                       | Cause of operation  | Status of air conditioner                    | Condition                        |   |
| E03                              | No communication from remote controller (including wireless) and communication adapter  | Stop<br>(Automatic reset)                    | Displayed when error is detected | <ol style="list-style-type: none"> <li>1. Check cables of remote controller and communication adapters. <ul style="list-style-type: none"> <li>• Remote controller LCD display OFF (Disconnection)</li> <li>• Central remote controller [97] check code</li> </ul> </li> </ol>  |
| E04                              | The serial signal is not output from outdoor unit to indoor unit. <ul style="list-style-type: none"> <li>• Miswiring of inter-unit wire</li> <li>• Defective serial sending circuit on outdoor P.C. board</li> <li>• Defective serial receiving circuit on indoor P.C. board</li> </ul> | Stop<br>(Automatic reset)                    | Displayed when error is detected | <ol style="list-style-type: none"> <li>1. Outdoor unit does not completely operate. <ul style="list-style-type: none"> <li>• Inter-unit wire check, correction of miswiring</li> <li>• Check outdoor P.C. board. Correct wiring of P.C. board.</li> </ul> </li> <li>2. When outdoor unit normally operates<br/>Check P.C. board (Indoor receiving / Outdoor sending).</li> </ol>          |
|                                  | Case thermostat operation<br>* Abnormal overheat of compressor  | Stop   | Displayed when error is detected | <ol style="list-style-type: none"> <li>1. Check case thermostat and connector.</li> <li>2. Check gas leak, recharge</li> <li>3. Check full open of service valve.</li> <li>4. Check PMV (Pulse Motor Valve).</li> <li>5. Check broken pipe.</li> </ol>  |
| E08                              | Duplicated indoor unit address  | Stop   | Displayed when error is detected | <ol style="list-style-type: none"> <li>1. Check whether remote controller connection (Group/Individual) was changed or not after power supply turned on (Finish of group construction/Address check).</li> </ol> <p>* If group construction and address are not normal when the power has been turned on, the mode automatically shifts to address setup mode. (Resetting of address)</p> |
| L03                              | Duplicated indoor master unit   |  |                                  |   |
| L07                              | There is group wire in individual indoor unit.  |  |                                  |   |
| L08                              | Unset indoor group address  |  |                                  |   |
| L09                              | Unset indoor capacity   | Stop   | Displayed when error is detected | <ol style="list-style-type: none"> <li>1. Set indoor capacity (CODE No. (DN) = 11)</li> </ol>   |
| L30                              | Abnormal input of outside interlock   | Stop   | Displayed when error is detected | <ol style="list-style-type: none"> <li>1. Check outside devices.</li> <li>2. Check indoor P.C. board.</li> </ol>  |
| P10                              | Float switch operation <ul style="list-style-type: none"> <li>• Float circuit, Disconnection, Coming-off, Float switch contact error</li> </ul>   | Stop   | Displayed when error is detected | <ol style="list-style-type: none"> <li>1. Trouble of drain pump</li> <li>2. Clogging of drain pump</li> <li>3. Check float switch.</li> <li>4. Check indoor P.C. board.</li> </ol>  |
| P12                              | Indoor DC fan error   | Stop   | Displayed when error is detected | <ol style="list-style-type: none"> <li>1. Position detection error</li> <li>2. Over-current protective circuit of indoor fan driving unit operated.</li> <li>3. Indoor fan locked.</li> <li>4. Check indoor P.C. board.</li> </ol>  |
| P19                              | 4-way valve system error <ul style="list-style-type: none"> <li>• After heating operation has started, indoor heat exchangers temp. is down.</li> </ul>   | Stop<br>(Automatic reset)                    | Displayed when error is detected | <ol style="list-style-type: none"> <li>1. Check 4-way valve.</li> <li>2. Check 2-way valve and check valve.</li> <li>3. Check indoor heat exchanger (TC/TCJ).</li> <li>4. Check indoor P.C. board.</li> </ol>   |
| P31                              | Own unit stops while warning is output to other indoor units.   | Stop<br>(Follower unit)<br>(Automatic reset) | Displayed when error is detected | <ol style="list-style-type: none"> <li>1. Judge follower unit while header unit is [E03], [L03], [L07] or [L08].</li> <li>2. Check indoor P.C. board.</li> </ol>  |
| F01                              | Coming-off, disconnection or short of indoor heat exchanger temp. sensor (TCJ)  | Stop<br>(Automatic reset)                    | Displayed when error is detected | <ol style="list-style-type: none"> <li>1. Check indoor heat exchanger temp. sensor (TCJ).</li> <li>2. Check indoor P.C. board.</li> </ol>   |
| F02                              | Coming-off, disconnection or short of indoor heat exchanger temp. sensor (TC)   | Stop<br>(Automatic reset)                    | Displayed when error is detected | <ol style="list-style-type: none"> <li>1. Check indoor heat exchanger temp. sensor (TC).</li> <li>2. Check indoor P.C. board.</li> </ol>  |
| F10                              | Coming-off, disconnection or short of indoor heat exchanger temp. sensor (TA)   | Stop<br>(Automatic reset)                    | Displayed when error is detected | <ol style="list-style-type: none"> <li>1. Check indoor heat exchanger temp. sensor (TA).</li> <li>2. Check indoor P.C. board.</li> </ol>  |
| F29                              | Indoor EEPROM error <ul style="list-style-type: none"> <li>• EEPROM access error</li> </ul>   | Stop<br>(Automatic reset)                    | Displayed when error is detected | <ol style="list-style-type: none"> <li>1. Check indoor EEPROM. (including socket insertion)</li> <li>2. Check indoor P.C. board.</li> </ol>   |
| E10                              | Communication error between indoor MCU <ul style="list-style-type: none"> <li>• Communication error between fan driving MCU and main MCU</li> </ul>   | Stop<br>(Automatic reset)                    | Displayed when error is detected | <ol style="list-style-type: none"> <li>1. Check indoor P.C. board.</li> </ol>   |
| E18                              | Regular communication error between indoor aster and follower units and between main and sub units  | Stop<br>(Automatic reset)                    | Displayed when error is detected | <ol style="list-style-type: none"> <li>1. Check remote controller wiring.</li> <li>2. Check indoor power supply wiring.</li> <li>3. Check indoor P.C. board.</li> </ol>   |

## **Error mode detected by outdoor unit**

The indoor unit check code has been ramified from **4** series and after.

The ramified check code is displayed only when combined with **4**-series indoor unit.

(Ex. Combination of RAV-SM1404UT-E with RAV-SM1403AT-E1)

When the indoor unit is 3 series and before, the conventional check code is displayed.

(Ex. Combination of RAV-SM1402CT-E and RAV-SM1403AT-E1)

| Operation of diagnostic function |                |  |                           |                                  | Judgment and measures  |
|----------------------------------|----------------|--|---------------------------|----------------------------------|--|
| Check code                       |                | Cause of operation   | Status of air conditioner | Condition                        |  |
| Indoor unit                      |                |  |                           |                                  |  |
| before 3 series                  | after 4 series |  |                           |                                  |  |
| F04                              | F04            | Disconnection, short of discharge temp. sensor (TD)  | Stop                      | Displayed when error is detected | 1. Check discharge temp. sensor (TD).<br>2. Check outdoor P.C. board   |
| F06                              | F06            | Disconnection, short of outdoor temp. sensor (TE)  | Stop                      | Displayed when error is detected | 1. Check temp. sensor (TE).<br>2. Check outdoor P.C. board .   |
|                                  | F07            | Disconnection, short of outdoor temp. sensor (TL)  | Stop                      | Displayed when error is detected | 1. Check temp. sensor (TL).<br>2. Check outdoor P.C. board .   |
|                                  | F12            | Disconnection, short of suction temp. sensor (TS)  | Stop                      | Displayed when error is detected | 1. Check suction temp. sensor (TS).<br>2. Check outdoor P.C. board.  |
|                                  | F15            | Miss-mounting of outdoor temp. sensor (TE, TS)   | Stop                      | Displayed when error is detected | 1. Check temp. sensor (TE, TS).<br>2. Check outdoor P.C. board.  |
| F08                              | F08            | Disconnection, short of outside temp. sensor (TO)  | Continue                  | Displayed when error is detected | 1. Check outside temp. sensor (TO).<br>2. Check outdoor P.C. board.  |
| L29                              | F13            | Disconnection, short of heat sink temp. sensor (TH)  | Stop                      | Displayed when error is detected | 1. Check outdoor P.C. board (IC200 is incorporated in TH sensor.)  |
|                                  | F31            | Outdoor P.C. EEPROM error  | Stop                      | Displayed when error is detected | 1. Check outdoor P.C. board.   |
|                                  | L10            | Unset jumper of service P.C. board   | Stop                      | Displayed when error is detected | 1. Outdoor service P.C. board.<br>Check model type setting jumper wire.  |
|                                  | P07            | Heat sink overheat error<br>* Heat sink temp. sensor detected over specified temperature.  | Stop                      | Displayed when error is detected | 1. Check screw tightening between P.C. Board and heat sink and check radiator grease.<br>2. Check heat sink blast path.  |
|                                  | P15            | Detection of gas leak<br>* Discharge temp. sensor (TD), Suction temp. sensor (TS) detected temperature over specified temp.  | Stop                      | Displayed when error is detected | 1. Check gas leak, recharge<br>2. Check full open of service valve.<br>3. Check PMV (Pulse Motor Valve).<br>4. Check broken pipe.<br>5. Check discharge temp. sensor (TD), suction temp. sensor (TS).                    |
|                                  | P19            | 4-way valve inverse error<br>* After heating operation has started, indoor heat exchanger temp. lowers under the specified temp.<br>* After heating operation has started, outdoor heat exchanger / suction temp. rises over the specified temp. | Stop                      | Displayed when error is detected | 1. Check operation of 4-way valve.<br>2. Check outdoor heat exchanger (TE), suction temp. sensor (TS).<br>3. Check indoor heat exchanger sensor (TC).<br>4. Check 4-way valve coil.<br>5. Check PMV (Pulse Motor Valve). |
| H01                              | H01            | Compressor break down<br>* Although operation has started, operation frequency decreases and operation stops.  | Stop                      | Displayed when error is detected | 1. Check power supply voltage. (AC198 to 264V)<br>2. Overload operation of refrigerating cycle   |
| H02                              | H02            | Compressor lock<br>* Over-current detection after compressor start-up  | Stop                      | Displayed when error is detected | 1. Trouble of compressor (Lock, etc.): Replace compressor.<br>2. Wiring error of compressor (Open phase)   |

| Operation of diagnostic function |                |  |                           |                                  | Judgment and measures  |
|----------------------------------|----------------|--|---------------------------|----------------------------------|--|
| Check code                       |                | Cause of operation   | Status of air conditioner | Condition                        |  |
| Indoor unit                      |                |  |                           |                                  |  |
| before 3 series                  | after 4 series |  |                           |                                  |  |
| H03                              | H03            | Current detection circuit error  | Stop                      | Displayed when error is detected | 1. Check outdoor P.C. board. (AC current detection circuit)  |
| P03                              | P03            | Discharge temp. error<br>* Discharge temp. (TD) over specified value was detected.   | Stop                      | Displayed when error is detected | 1. Check refrigerating cycle (Gas leak)<br>2. Trouble of electronic expansion valve<br>3. Check discharge temp. sensor (TD).   |
| P04                              | P04            | High pressure SW system error  | Stop                      | Displayed when error is detected | 1. Check service valves are fully opened. (Gas side, Liquid side)<br>2. Check of outdoor fan operation.<br>3. Check motor error of outdoor fan.<br>4. Check clogging of outdoor PMV.<br>5. Check clogging of heat exchanger in indoor/outdoor units.<br>6. Short-circuit status of suction/discharge air in outdoor unit.<br>7. Check outdoor P.C. board error.<br>8. Check fan system error (Cause of air volume drop) at indoor side.<br>9. Check PMV opening status in indoor unit. |
|                                  | P05            | Power supply voltage error   | Stop                      | Displayed when error is detected | 1. Check power supply voltage. AC198 to 264V   |
|                                  | P20            | High pressure protective operation<br>• During cooling operation, outdoor temp. sensor (TL) detected temperature over specified temp.<br>• During heating operation, indoor temp. sensor (TC, TCJ) detected temperature over specified temp. | Stop                      | Displayed when error is detected | 1. Check outdoor heat exchanger sensor (TL).<br>2. Check indoor heat exchanger sensor (TC, TCJ).<br>3. Check full open of service valve.<br>4. Check indoor/outdoor fan.<br>5. Check PMV (Pulse Motor Valve).<br>6. Check clogging and short circuit of indoor/outdoor heat exchanger.<br>7. Overcharge of refrigerant. Recharge   |
| P22                              | P22            | Outdoor fan system error   | Stop                      | Displayed when error is detected | 1. Check lock of fan motor.<br>2. Check power supply voltage. AC198 to 264V<br>3. Check outdoor P.C. board.  |
| P26                              | P26            | Short-circuit error of compressor driving element  | Stop                      | Displayed when error is detected | 1. When performing operation while taking-off compressor wire, P26 error occurs. Check control P.C. board.<br>2. When performing operation while taking-off compressor wire, an error does not occur. (Compressor rare short)  |
| P29                              | P29            | Position detection circuit error   | Stop                      | Displayed when error is detected | 1. Check control P.C. board.   |

## **Error mode detected by remote controller or central controller (TCC-LINK)**

| Operation of diagnostic function  |   |   |                                  | Judgment and measures  |
|---|---|---|----------------------------------|--|
| Check code  | Cause of operation  | Status of air conditioner   | Condition                        |  |
| Not displayed at all<br>(Operation on remote controller is impossible.) | No communication with master indoor unit <ul style="list-style-type: none"> <li>Remote controller wiring is not correct.</li> <li>Power of indoor unit is not turned on.</li> <li>Automatic address cannot be completed.</li> </ul> | Stop  | —                                | Power supply error of remote controller, Indoor EEPROM error <ol style="list-style-type: none"> <li>Check remote controller inter-unit wiring.</li> <li>Check remote controller.</li> <li>Check indoor power wiring.</li> <li>Check indoor P.C. board.</li> <li>Check indoor EEPROM.<br/>(including socket insertion)<br/>→ Automatic address repeating phenomenon generates.</li> </ol> |
| E01<br>*2   | No communication with master indoor unit <ul style="list-style-type: none"> <li>Disconnection of inter-unit wire between remote controller and master indoor unit (Detected by remote controller side)</li> </ul>                   | Stop<br>(Automatic reset)<br>* If center exists, operation continues. | Displayed when error is detected | Receiving error from remote controller <ol style="list-style-type: none"> <li>Check remote controller inter-unit wiring.</li> <li>Check remote controller.</li> <li>Check indoor power wiring.</li> <li>Check indoor P.C. board.</li> </ol>  |
| E02   | Signal send error to indoor unit<br>(Detected by remote controller side)  | Stop<br>(Automatic reset)<br>* If center exists, operation continues. | Displayed when error is detected | Sending error of remote controller <ol style="list-style-type: none"> <li>Check sending circuit inside of remote controller.<br/>→ Replace remote controller.</li> </ol>   |
| E09   | There are multiple main remote controllers.<br>(Detected by remote controller side)   | Stop<br>(Sub unit continues operation.)                               | Displayed when error is detected | <ol style="list-style-type: none"> <li>In 2-remote controllers (including wireless), there are multiple main units.<br/>Check that there are 1 main remote controller and other sub remote controllers.</li> </ol>   |
| L20<br>Central controller L20   | Duplicated indoor central addresses on communication of central control system<br>(Detected by indoor/central controller side)  | Stop<br>(Automatic reset)   | Displayed when error is detected | <ol style="list-style-type: none"> <li>Check setting of central control system network address. (Network adapter SW01)</li> <li>Check network adapter P.C. board.</li> </ol>   |
| —<br>*3<br>Central controller (Send)<br>C05 (Receive)<br>C06            | Communication circuit error of central control system<br>(Detected by central controller side)  | Continues<br>(By remote controller)                                   | Displayed when error is detected | <ol style="list-style-type: none"> <li>Check communication wire / miswiring</li> <li>Check communication (U3, U4 terminals)</li> <li>Check network adapter P.C. board.</li> <li>Check central controller (such as central control remote controller, etc.)</li> <li>Check terminal resistance. (TCC-LINK)</li> </ol>   |
| —<br>Central controller P30   | Indoor Gr sub unit error<br>(Detected by central controller side)   | Continuation/Stop<br>(According to each case)                         | Displayed when error is detected | Check the check code of the corresponding unit from remote controller.   |

\*2 The check code cannot be displayed by the wired remote controller.  
(Usual operation of air conditioner becomes unavailable.)

For the wireless models, an error is notified with indication lamp.

\*3 This trouble is related to communication of remote controller (A, B), central system (TCC-LINK U3, U4), and [E01], [E02], [E03], [E09] or [E18] is displayed or no check display on the remote controller according to the contents.

## Contents Error Display

- \* When fixations of the errors were overlapped, the latest error is displayed.
- \* When D800 to D804 are slowly flashing or D805 is flashing, push and hold SW800 and SW801 simultaneously for 5 seconds or more. The error display changes to the error which is generated.

| No. | Item   | Check code                        |                                  | LED display      |                  |                  |                  |                  |                 |
|-----|--|-----------------------------------|----------------------------------|------------------|------------------|------------------|------------------|------------------|-----------------|
|     |  | Wired remote controller           |                                  | D800<br>(Yellow) | D801<br>(Yellow) | D802<br>(Yellow) | D803<br>(Yellow) | D804<br>(Yellow) | D805<br>(Green) |
|     |  | Indoor unit<br>before 3<br>series | Indoor unit<br>after 4<br>series |                  |                  |                  |                  |                  |                 |
| 1   | TD sensor error                              | F04                               | F04                              | ○                | ●                | ●                | ●                | ●                | ○               |
| 2   | TE sensor error                              | F06                               | F06                              | ●                | ○                | ●                | ●                | ●                | ○               |
| 3   | TL sensor error                              | F06                               | F07                              | ○                | ○                | ●                | ●                | ●                | ○               |
| 4   | TO sensor error                              | F08                               | F08                              | ●                | ●                | ○                | ●                | ●                | ○               |
| 5   | TS sensor error                              | F06                               | F12                              | ○                | ●                | ○                | ●                | ●                | ○               |
| 6   | TH sensor error                              | L29                               | F13                              | ●                | ○                | ○                | ●                | ●                | ○               |
| 7   | Heat exchanger sensor (TE, TS) misconnection | F06                               | F15                              | ○                | ○                | ○                | ●                | ●                | ○               |
| 8   | EEPROM error                                 | L29                               | F31                              | ●                | ○                | ●                | ○                | ●                | ○               |
| 9   | Compressor breakdown                         | H01                               | H01                              | ○                | ○                | ●                | ○                | ●                | ○               |
| 10  | Compressor lock                              | H02                               | H02                              | ●                | ●                | ○                | ○                | ●                | ○               |
| 11  | Model unset                                  | L29                               | L10                              | ●                | ●                | ●                | ●                | ○                | ○               |
| 12  | Discharge temp. error                        | P03                               | P03                              | ●                | ○                | ●                | ●                | ○                | ○               |
| 13  | High-pressure SW error                       | P04                               | P04                              | ○                | ○                | ●                | ●                | ○                | ○               |
| 14  | Current detection circuit error              | H03                               | H03                              | ○                | ●                | ○                | ○                | ●                | ○               |
| 15  | Power supply error                           | P04                               | P05                              | ○                | ●                | ○                | ●                | ○                | ○               |
| 16  | Heat sink overheat error                     | L29                               | P07                              | ●                | ○                | ○                | ●                | ○                | ○               |
| 17  | Gas leak detection                           | L29                               | P15                              | ○                | ○                | ○                | ●                | ○                | ○               |
| 18  | 4-way valve reversal error                   | L29                               | P19                              | ●                | ●                | ●                | ○                | ○                | ○               |
| 19  | High-pressure protective operation           | P04                               | P20                              | ○                | ●                | ●                | ○                | ○                | ○               |
| 20  | Fan system error                             | P22                               | P22                              | ●                | ○                | ●                | ○                | ○                | ○               |
| 21  | Driving element short circuit                | P26                               | P26                              | ○                | ○                | ●                | ○                | ○                | ○               |
| 22  | Position detection circuit error             | P29                               | P29                              | ●                | ●                | ○                | ○                | ○                | ○               |
| 23  | Others (No fixation)                         | —                                 | —                                | ○                | ●                | ○                | ○                | ○                | ○               |

○ : ON   ● : OFF   ◎ : Rapid flash (5 times /sec.)

\* The LEDs and switches are located at the top right of the P.C. board of the outdoor unit as shown in the figure on the right.

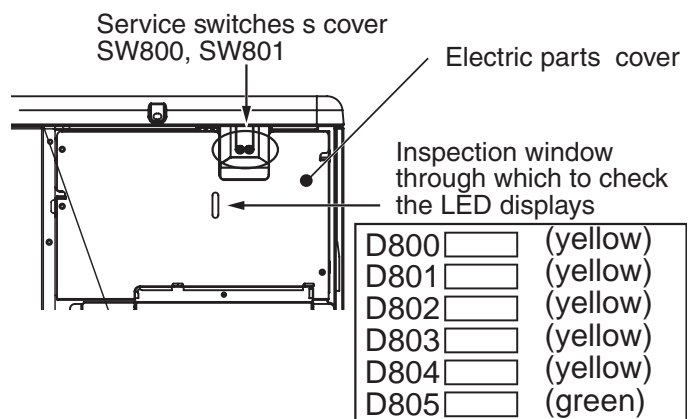



### 8-2-5. Diagnostic Procedure for Each Check Code (Outdoor Unit)

- 1) This section describes the diagnostic method for each check code displayed on the wired remote controller.
- 2) In some cases, a check code indicates multiple symptoms.  
In this case, confirm LED display on the outdoor P.C. board to narrow the contents to be confirmed.
- 3) The check code on the wired remote controller is displayed only when the same error occurred continuously by multiple times while LED of the outdoor P.C. board displays even an error which occurred once.  
Therefore the display on the wired remote controller may differ from that of LED.

#### LED display on outdoor P.C. board

##### Operation method of the service SW

[Display of error which is generating]

- When even one of D800 to D804 rapid flashing, it indicates that an error occurred. When D800 to D801 indicate slow flashing or when D805 flashes, push and hold SW800 and SW801 for 5 seconds or more simultaneously. The error display exchanges to display of the error under occurrence at present.

|               | (No error) | (Error occurred) |
|---------------|------------|------------------|
| D800 (Yellow) | ●          | ◎                |
| D801 (Yellow) | ●          | ●                |
| D802 (Yellow) | ●          | ●                |
| D803 (Yellow) | ●          | ●                |
| D804 (Yellow) | ●          | ●                |
| D805 (Green)  | ○          | ○                |

(Example of discharge temp. sensor error)

● : ON, ○ : OFF, ◎ : Rapid flashing (5 times / second)

##### Display of the latest error

- The latest error is displayed by the following action.  
As the memory is kept, it is confirmed even after the power supply was turned off once. (Except outside air temp. sensor (TO) error)

- 1) Check D800 to D804 are turned off (or rapid flashing) and D805 is turned on. When D800 to D804 are slowly flashing or D805 flashes, push and hold SW800 and SW801 for 5 seconds or more simultaneously. D800 to D804 will be turned off (or rapid flashing) and D805 flashes.

- 2) Push and hold SW800 for 5 seconds or more. D804 changes to slow flashing.

- 3) Push SW800 several times and change LED display (D800 to D804) to [Display of latest error (Including the present error)].







- 4) Push SW801. The latest error is displayed.



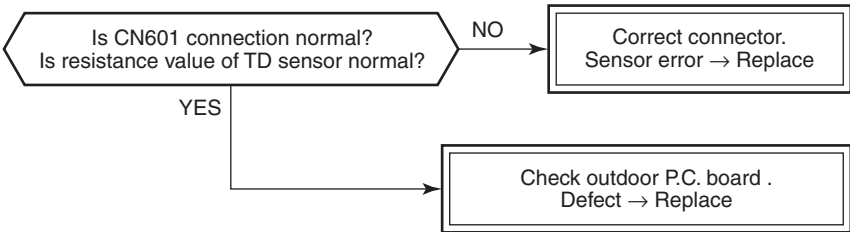

- 5) When finishing the work, be sure to execute item 1) to return LED to the initial status (Display of error under occurrence).

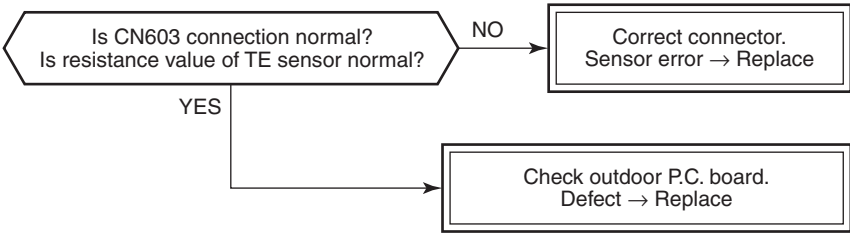
|               | Display of latest error<br>(Including the present error) |
|---------------|--|
| D800 (Yellow) | ○  |
| D801 (Yellow) | ●  |
| D802 (Yellow) | ●  |
| D803 (Yellow) | ●  |
| D804 (Yellow) | ●  |
| D805 (Green)  | ◎  |

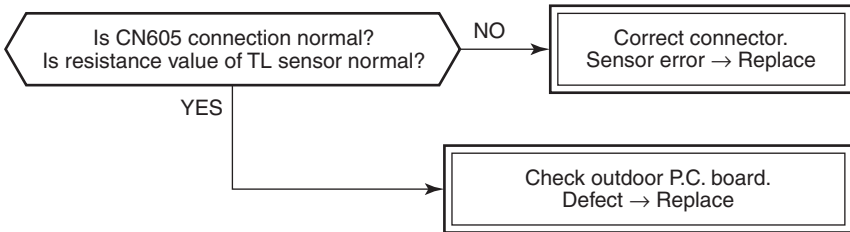

● : ON, ○ : OFF, ◎ : Rapid flashing (5 times / second)

| Check code | Outdoor LED display | Check and troubleshooting<br>(Item without special mention Indicates part of outdoor unit.)   |
|------------|---------------------|---|
|            | —                   | <p><b>[Indoor/Outdoor communication error]</b></p> <pre> graph TD     Q1{{Is setting of group address of remote controller correct?}} -- NO --&gt; A1[Check CODE No. [14].]     Q1 -- YES --&gt; Q2{{Are inner wiring and indoor/outdoor control wires (1, 2, 3) normal?}}     Q2 -- NO --&gt; A2[Correct wiring indoor/outdoor control wires]     Q2 -- YES --&gt; Q3{{Are wiring of terminal blocks (1, 2, 3) normal?}}     Q3 -- NO --&gt; A3[Correct wiring of connectors and terminal blocks.]     Q3 -- YES --&gt; A4[Check outdoor P.C. board. Defect -&gt; Replace] </pre>  |
| [E04]      | —                   | <p><b>[Case thermostat operation]</b></p> <pre> graph TD     Q1{{Are CN500 connection and case thermostat normal?}} -- NO --&gt; A1[Correct connector. Case thermostat error -&gt; Replace]     Q1 -- YES --&gt; Q2{{Is cooling/heating operation available when short-circuiting case thermostat?}}     Q2 -- NO --&gt; A2[Check outdoor P.C. board. Defect -&gt; Replace]     Q2 -- YES --&gt; Q3{{Is there no gas leak? Is it not refrigerant shortage?}}     Q3 -- NO --&gt; A3[Repair defectives position. Recharge refrigerant.]     Q3 -- YES --&gt; Q4{{Is valve fully opened?}}     Q4 -- NO --&gt; A4[Open valve fully.]     Q4 -- YES --&gt; Q5{{Is PMV normal?}}     Q5 -- NO --&gt; A5[Correct defective position. Replace defective part.]     Q5 -- YES --&gt; A6[Check crushed or broken pipe. Defect -&gt; Correct and Replace] </pre> |







| Check code | Outdoor LED display  | Check and troubleshooting<br>(Item without special mention indicates part of outdoor unit.)  |
|------------|--|--|
| [F04]      |   | <p><b>[Discharge temp. sensor (TD) error]</b></p>    |
| [F06]      | <br><br><br> | <p>• There is a possibility that it is one of the following errors.<br/>Confirm LED on outdoor P.C. board to judge which error it is.<br/>Heat exchanger temp. sensor (TE) error, Heat exchanger temp. sensor (TL) error, Suction temp. sensor (TS) error, Miswiring of heat exchanger sensor (TE, TS, TL)</p> <p><b>Heat exchanger temp. sensor (TE) error]</b></p>  <p><b>[Heat exchanger temp. sensor (TL) error]</b> → Refer to [F07] column.</p> <p><b>[Suction temp. sensor (TS) error]</b> → Refer to [F12] column.</p> <p><b>[Miswiring of heat exchanger sensor (TE, TS)]</b> → Refer to [F15] column.</p> |
| [F07]      |   | <p><b>[Heat exchanger temp. sensor (TL) error]</b></p>   |

| Check code | Outdoor LED display   | Check and troubleshooting<br>(Item without special mention indicates part of outdoor unit.)  |
|------------|---|--|
| [F08]      |    | <p><b>[Outside air temp. sensor (TO) error]</b></p> <pre> graph TD     Q1{{Is CN602 connection normal?<br/>Is resistance value of TO sensor normal?}}     Q1 -- NO --&gt; A1[Correct connector.<br/>Sensor error → Replace]     Q1 -- YES --&gt; A2[Check outdoor P.C. board.<br/>Defect → Replace]   </pre>   |
| [F12]      |    | <p><b>[Suction temp. sensor (TS) error]</b></p> <pre> graph TD     Q2{{Is CN604 connection normal?<br/>Is resistance value of TS sensor normal?}}     Q2 -- NO --&gt; A3[Correct connector.<br/>Sensor error → Replace]     Q2 -- YES --&gt; A4[Check outdoor P.C. board.<br/>Defect → Replace]   </pre>   |
| [F13]      |   | <p><b>[Heat sink temp. sensor (TH) error]</b></p> <pre> graph TD     A5[Check outdoor P.C. board.<br/>Defect → Replace]   </pre>   |
| [F15]      |  | <p><b>[Miswiring of heat exchanger sensor (TE, TS)]</b></p> <pre> graph TD     Q3{{Is mounting status of<br/>TE and TS sensors normal?}}     Q3 -- NO --&gt; A6[Correct sensor mounting.]     Q3 -- YES --&gt; Q4{{Is CN604 connection normal?<br/>Is resistance value of TS sensor normal?}}     Q4 -- NO --&gt; A7[Correct connector.<br/>Sensor error → Replace]     Q4 -- YES --&gt; Q5{{Is CN603 connection normal?<br/>Is resistance value of TE sensor normal?}}     Q5 -- NO --&gt; A8[Correct connector.<br/>Sensor error → Replace]     Q5 -- YES --&gt; A9[Check outdoor P.C. board.<br/>Defect → Replace]   </pre> |

| Check code | Outdoor LED display  | Check and troubleshooting<br>(Item without special mention Indicates part of outdoor unit.)   |
|------------|--|---|
| [F31]      | <ul style="list-style-type: none"> <li>●</li> <li>◎</li> <li>●</li> <li>◎</li> <li>●</li> <li>○</li> </ul> | <p><b>[EEPROM error]</b></p> <div style="border: 1px solid black; padding: 5px; width: fit-content; margin: 10px auto;"> <p>Check outdoor P.C. board.<br/>Defect → Replace</p> </div>   |
| [H01]      | <ul style="list-style-type: none"> <li>◎</li> <li>◎</li> <li>●</li> <li>◎</li> <li>●</li> <li>○</li> </ul> | <p><b>[Compressor break down]</b></p> <pre> graph TD     Q1{{Is power supply voltage normal?<br/>AC198 to 264V}} -- NO --&gt; A1[Correct power supply line.]     Q1 -- YES --&gt; Q2{{Is wire connection normal?<br/>Compressor lead<br/>(P.C. board side, Compressor side),<br/>Reactor lead, Power supply lead}}     Q2 -- NO --&gt; A2[Check wire connection<br/>and correct it.]     Q2 -- YES --&gt; Q3{{Is it not abnormal overload?}}     Q3 -- YES --&gt; A3[Correct and clear the cause.]     Q3 -- NO --&gt; A4[Check outdoor P.C. board.<br/>Defect → Replace]   </pre>  |
| [H02]      | <ul style="list-style-type: none"> <li>●</li> <li>●</li> <li>◎</li> <li>◎</li> <li>●</li> <li>○</li> </ul> | <p><b>[Compressor lock]</b></p> <pre> graph TD     Q1{{Is power supply voltage normal?<br/>AC198 to 264V}} -- NO --&gt; A1[Correct power supply line.]     Q1 -- YES --&gt; Q2{{Is wire connection normal?<br/>Compressor lead<br/>(P.C. board side, Compressor side),<br/>Reactor lead, Power supply lead}}     Q2 -- NO --&gt; A2[Check wire connection<br/>and correct it.]     Q2 -- YES --&gt; Q3{{Is compressor normal?}}     Q3 -- YES --&gt; A3[Check outdoor P.C. board.<br/>Defect → Replace]     Q3 -- NO --&gt; Q4{{Is there no refrigerant stagnation?}}     Q4 -- NO --&gt; A4[Compressor lock → Replace]     Q4 -- YES --&gt; Q5{{Does PMV normally operate?}}     Q5 -- NO --&gt; A5[Check TE, TS sensors and PMV.<br/>Defect → Replace]     Q5 -- YES --&gt; A6[Check outdoor P.C. board.<br/>Defect → Replace]   </pre> |

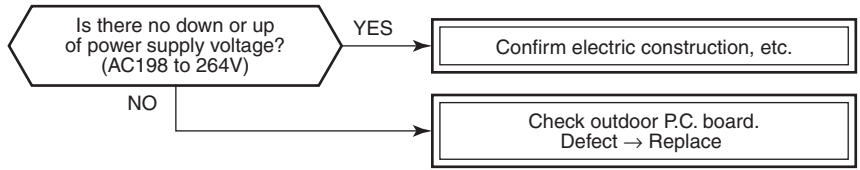
| Check code | Outdoor LED display   | Check and troubleshooting<br>(Item without special mention indicates part of outdoor unit.)  |
|------------|---|--|
| [H03]      |  | <p><b>[Current detection circuit error]</b></p> <div style="border: 1px solid black; padding: 5px; width: fit-content; margin: 10px auto;"> <p>Check outdoor P.C. board.<br/>Defect → Replace</p> </div>   |
| [L10]      |  | <p><b>[Unset model type]</b> : Only when service P.C. board is used</p> <div style="border: 1px solid black; padding: 5px; width: fit-content; margin: 10px auto;"> <p>Cut jumper line according to the explanation sheet packaged with the service P.C. board.</p> </div>   |
| [P03]      |  | <p><b>[Discharge temp. error]</b></p> <pre> graph TD     Q1{{Is there no gas leak?<br/>Is refrigerant charge amount adequate?}} -- NO --&gt; A1[Repair defective position.<br/>Recharge refrigerant.]     Q1 -- YES --&gt; Q2{{Is PMV normal?}}     Q2 -- NO --&gt; A2[Repair defective position.<br/>Replace defective part.]     Q2 -- YES --&gt; Q3{{Is it not abnormal overload?}}     Q3 -- YES --&gt; A3[Correct and clear the cause.]     Q3 -- NO --&gt; Q4{{Is CN601 connection normal?<br/>Is resistance value of TD sensor normal?}}     Q4 -- NO --&gt; A4[Correct connector.<br/>Sensor error → Replace]     Q4 -- YES --&gt; A5[Check outdoor P.C. board.<br/>Defect → Replace]   </pre> |

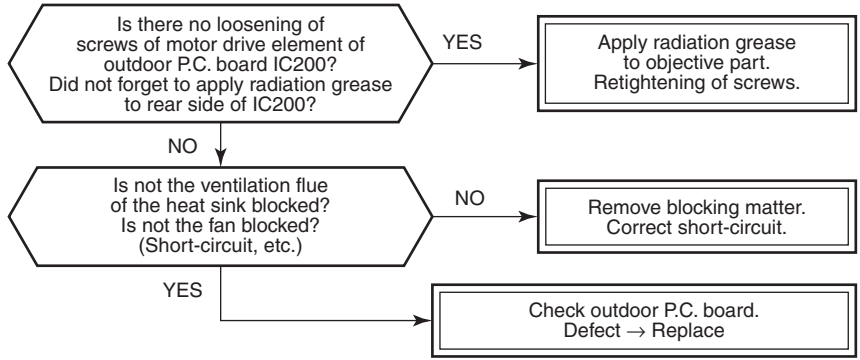
| Check code | Outdoor LED display   | <DCheck and troubleshooting<br>(Item without special mention Indicates part of outdoor unit.)                   |
|------------|---|---|
| [P04]      | <p>* There is a possibility that it is one of the following errors.<br/>Confirm LED on outdoor P.C. board to judge which error it is. (1) high-pressure SW system error, (2) power supply error (Vdc), (3) high-pressure protective operation.</p> <p>⊙<br/>⊙<br/>●<br/>●<br/>⊙<br/>○</p> | <p><b>[High pressure SW system error]</b><br/>Power supply error (Vdc), High pressure protective operation.</p> |

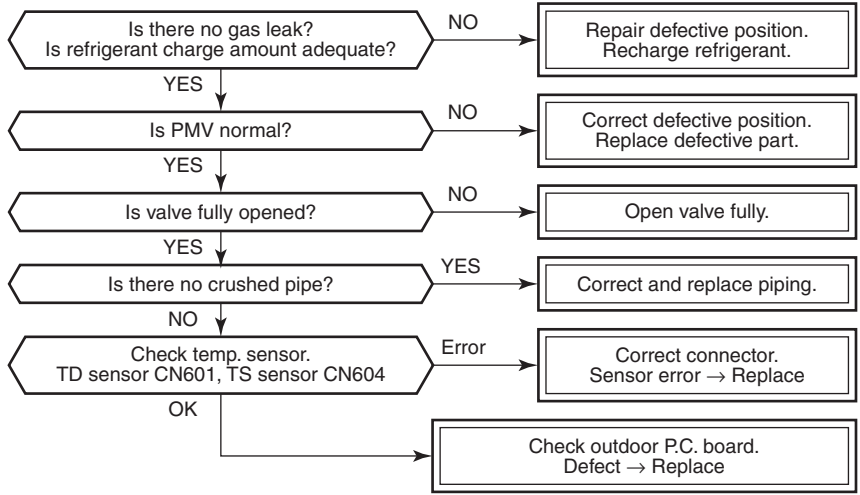

| Check code | Outdoor LED display   | Check and troubleshooting<br>(Item without special mention Indicates part of outdoor unit.)   |
|------------|---|---|
| [P04]      |    | [Power supply error (Vdc)] → Refer to [P05] column.   |
|            |    | [High pressure protective operation] → Refer to [P20] column.   |
| [P05]      |    | <p><b>[Power supply error (Voltage error)]</b></p>  |
| [P07]      |   | <p><b>[Heat sink overheat error]</b></p>          |
| [P15]      |  | <p><b>[Gas leak detection]</b></p>                |

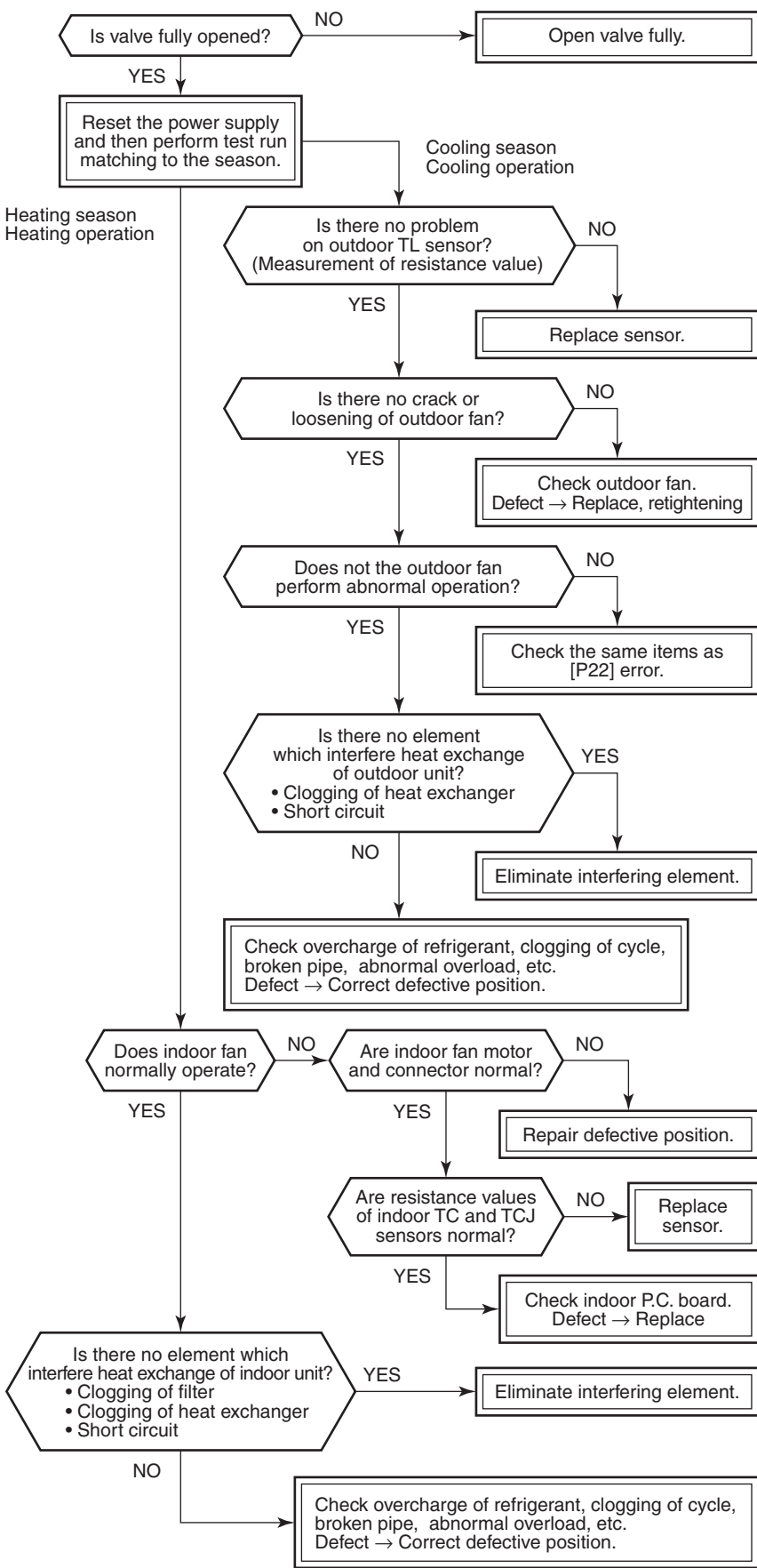

| Check code | Outdoor LED display  | Check and troubleshooting<br>(Item without special mention Indicates part of outdoor unit.)  |
|------------|--|--|
| [P19]      | <ul style="list-style-type: none"> <li>●</li> <li>●</li> <li>●</li> <li>◎</li> <li>◎</li> <li>○</li> </ul> | <p><b>[4-way valve reversal error]</b></p> <pre> graph TD     Q1{{Is operation of 4-way valve normal?<br/>(Check pipe temp. and etc. in cooling/heating operation.)}}     Q2{{Is power supply to 4-way valve coil normal?}}     Q3{{Is power supply to 4-way valve coil in heating?}}     Q4{{Are temperature sensor normal?<br/>TE sensor: CN603<br/>TS sensor: CN604}}     Q5{{Is refrigerant flow by PMV normal?}}     Q6{{Are TC sensor and TCJ sensor normal?}}     Q7{{Check outdoor P.C. board.}}     A1[Replace coil of 4-way valve.]     A2[Replace TE sensor.<br/>Replace TS sensor.]     A3[Check and replace of PMV]     A4[Replace TC sensor<br/>Replace TCJ sensor]     A5[Check indoor P.C. board.<br/>Defect -&gt; Replace]     A6[Check outdoor P.C. board.<br/>Defect -&gt; Replace]     A7[Check 4-way valve.<br/>Defective -&gt; Replace]      Q1 -- NO --&gt; Q2     Q1 -- YES --&gt; Q4     Q2 -- NO --&gt; A1     Q2 -- YES --&gt; Q3     Q3 -- NO --&gt; A7     Q3 -- YES --&gt; Q4     Q4 -- NO --&gt; A2     Q4 -- YES --&gt; Q5     Q5 -- NO --&gt; A3     Q5 -- YES --&gt; Q6     Q6 -- NO --&gt; A4     Q6 -- YES --&gt; A5     Q7 -- Error --&gt; A6     Q7 -- OK --&gt; A5   </pre> |

| Check code | Outdoor LED display   | Check and troubleshooting<br>(Item without special mention Indicates part of outdoor unit.)  |
|------------|---|--|
| [P20]      |  | <p><b>[High pressure protective operation]</b></p>  <pre> graph TD     Q1{{Is valve fully opened?}} -- NO --&gt; A1[Open valve fully.]     Q1 -- YES --&gt; B1[Reset the power supply and then perform test run matching to the season.]     B1 --&gt; C1[Is there no problem on outdoor TL sensor? Measurement of resistance value]     C1 -- NO --&gt; A2[Replace sensor.]     C1 -- YES --&gt; Q2{{Is there no crack or loosening of outdoor fan?}}     Q2 -- NO --&gt; A3[Check outdoor fan. Defect -&gt; Replace, retightening]     Q2 -- YES --&gt; Q3{{Does not the outdoor fan perform abnormal operation?}}     Q3 -- NO --&gt; A4[Check the same items as [P22] error.]     Q3 -- YES --&gt; Q4{{Is there no element which interfere heat exchange of outdoor unit? Clogging of heat exchanger, Short circuit}}     Q4 -- YES --&gt; A5[Eliminate interfering element.]     Q4 -- NO --&gt; A6[Check overcharge of refrigerant, clogging of cycle, broken pipe, abnormal overload, etc. Defect -&gt; Correct defective position.]     B1 --&gt; C2[Is there no problem on outdoor TL sensor? Measurement of resistance value]     C2 -- NO --&gt; A2     C2 -- YES --&gt; Q5{{Does indoor fan normally operate?}}     Q5 -- NO --&gt; Q6{{Are indoor fan motor and connector normal?}}     Q6 -- NO --&gt; A7[Repair defective position.]     Q6 -- YES --&gt; Q7{{Are resistance values of indoor TC and TCJ sensors normal?}}     Q7 -- NO --&gt; A8[Replace sensor.]     Q7 -- YES --&gt; A9[Check indoor P.C. board. Defect -&gt; Replace]     Q5 -- YES --&gt; Q8{{Is there no element which interfere heat exchange of indoor unit? Clogging of filter, Clogging of heat exchanger, Short circuit}}     Q8 -- YES --&gt; A5     Q8 -- NO --&gt; A6   </pre> |

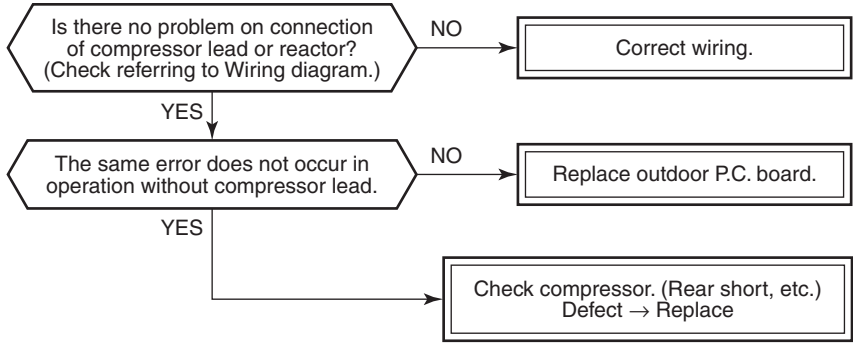
| Check code                   | Outdoor LED display        | Check and troubleshooting<br>(Item without special mention Indicates part of outdoor unit.)   |                              |      |      |      |      |      |  |   |   |   |   |   |
|------------------------------|----------------------------|---|------------------------------|------|------|------|------|------|--|---|---|---|---|---|
| [P22]                        | ●<br>◎<br>●<br>◎<br>◎<br>○ | <p><b>[Fan system error]</b></p> <pre> graph TD     Q1{{Is there no problem on power supply voltage?<br/>(AC 198 to 264V)}}     Q2{{Does the fan rotate without trouble when rotating<br/>shaft of fan motor with hands during power-OFF?<br/>Is there no problem on coil resistance of fan motor?<br/>Between red and white lead wire : 12 to 20Ω<br/>Between white and black lead wire : 12 to 20Ω<br/>Between black and red lead wire : 12 to 20Ω}}     A1[Check wiring construction.<br/>Ask repair of power supply.]     A2[Replace fan motor.]     A3[Check outdoor P.C. board.<br/>Defect → Replace]      Q1 -- NO --&gt; A1     Q1 -- YES --&gt; Q2     Q2 -- YES --&gt; A3     Q2 -- NO --&gt; A2   </pre> <p><b>Single operation check for outdoor fan</b></p> <p>A single operation of the outdoor fan can be confirmed by handling the service switch SW800, SW801. Use this method to check whether there is trouble or not on the fan.</p> <p><b>[Method]</b></p> <ol style="list-style-type: none"> <li>(1) Check D800 to D804 are turned off (or rapid flashing) and D805 is turned on. When D800 to D801 flash slowly or D805 flashes, push and hold SW800 and SW801 for 5 seconds or more simultaneously. In the result, D800 to D804 are turned off (or rapid flashing) and D805 changes from flashing to lighting.</li> <li>(2) Push and hold SW800 for 5 seconds or more. D804 changes to slow flashing.</li> <li>(3) Push SW800 and stop it at LED display of the following “Outdoor fan single operation”.</li> </ol> <table border="1" data-bbox="762 1216 1232 1312"> <tr> <td data-bbox="762 1216 951 1312">Outdoor fan single operation</td> <td data-bbox="951 1216 1011 1312">D800</td> <td data-bbox="1011 1216 1056 1312">D801</td> <td data-bbox="1056 1216 1101 1312">D802</td> <td data-bbox="1101 1216 1145 1312">D803</td> <td data-bbox="1145 1216 1232 1312">D804</td> </tr> <tr> <td data-bbox="762 1312 951 1339"></td> <td data-bbox="951 1312 1011 1339">○</td> <td data-bbox="1011 1312 1056 1339">○</td> <td data-bbox="1056 1312 1101 1339">●</td> <td data-bbox="1101 1312 1145 1339">○</td> <td data-bbox="1145 1312 1232 1339">◎</td> </tr> </table> <p>○: ON, ●: OFF ◎: Rapid flashing</p> <ol style="list-style-type: none"> <li>(4) Push SW801 and then stop it at the position where D805 flashes rapidly.</li> <li>(5) Push and hold SW801 for 5 seconds or more. In the result, D804 changes to slow flashing, D805 changes to lighting and the fan rotates.</li> <li>(6) The fan stops when pushing long SW800 and SW801 for 5 seconds or more simultaneously or when 2 minutes passed.</li> </ol> <p>* If an unknown point generated on the way of the operation, push and hold SW800 and SW801 for 5 seconds or more simultaneously. You can return to the item (1).</p> | Outdoor fan single operation | D800 | D801 | D802 | D803 | D804 |  | ○ | ○ | ● | ○ | ◎ |
| Outdoor fan single operation | D800                       | D801  | D802                         | D803 | D804 |      |      |      |  |   |   |   |   |   |
|                              | ○                          | ○   | ●                            | ○    | ◎    |      |      |      |  |   |   |   |   |   |

| Check code   | Outdoor LED display   | Check and troubleshooting<br>(Item without special mention indicates part of outdoor unit.)   |
|--------------|---|---|
| [P26]        |    | <p><b>[Short-circuit of compressor drive element]</b></p>  <pre> graph TD     Q1{{Is there no problem on connection of compressor lead or reactor?<br/>(Check referring to Wiring diagram.)}}     A1[Correct wiring.]     Q2{{The same error does not occur in operation without compressor lead.}}     A2[Replace outdoor P.C. board.]     A3[Check compressor. (Rear short, etc.)<br/>Defect -&gt; Replace]      Q1 -- NO --&gt; A1     Q1 -- YES --&gt; Q2     Q2 -- NO --&gt; A2     Q2 -- YES --&gt; A3 </pre> |
| [P29]        |    | <p><b>[Position detection circuit error]</b></p> <div style="border: 1px solid black; padding: 5px; width: fit-content; margin: 10px auto;"> <p>Check outdoor P.C. board.<br/>Defect → Replace</p> </div>   |
| —<br>No code |  | <p><b>[Other error]</b> Compressor disorder due to sudden change of load, etc.</p> <ul style="list-style-type: none"> <li>* Although the display of outdoor LED outputs, the unit automatically restarts and error is not determined.</li> <li>* A code may not appear when an open phase shortage, coming-out of wires or power relay trouble occurred.</li> </ul>   |

**Temperature sensor**

**Temperature – Resistance value characteristic table**

**TA, TC, TCJ, TE, TS, TO sensors**

**TD, TL sensors**

**Representative value**

**Representative value**

| Temperature (°C) | Resistance value (kΩ) |                  |                 |
|------------------|-----------------------|------------------|-----------------|
|                  | (Minimum value)       | (Standard value) | (Maximum value) |
| 0                | 32.33                 | 33.80            | 35.30           |
| 10               | 19.63                 | 20.35            | 21.09           |
| 20               | 12.23                 | 12.59            | 12.95           |
| 25               | 9.75                  | 10.00            | 10.25           |
| 30               | 7.764                 | 7.990            | 8.218           |
| 40               | 5.013                 | 5.192            | 5.375           |
| 50               | 3.312                 | 3.451            | 3.594           |
| 60               | 2.236                 | 2.343            | 2.454           |
| 70               | 1.540                 | 1.623            | 1.709           |
| 80               | 1.082                 | 1.146            | 1.213           |
| 90               | 0.7740                | 0.8237           | 0.8761          |
| 100              | 0.5634                | 0.6023           | 0.6434          |

| Temperature (°C) | Resistance value (kΩ) |                  |                 |
|------------------|-----------------------|------------------|-----------------|
|                  | (Minimum value)       | (Standard value) | (Maximum value) |
| 0                | 150.5                 | 161.3            | 172.7           |
| 10               | 92.76                 | 99.05            | 105.6           |
| 20               | 58.61                 | 62.36            | 66.26           |
| 25               | 47.01                 | 49.93            | 52.97           |
| 30               | 37.93                 | 40.22            | 42.59           |
| 40               | 25.12                 | 26.55            | 28.03           |
| 50               | 17.00                 | 17.92            | 18.86           |
| 60               | 11.74                 | 12.34            | 12.95           |
| 70               | 8.269                 | 8.668            | 9.074           |
| 80               | 5.925                 | 6.195            | 6.470           |
| 90               | 4.321                 | 4.507            | 4.696           |
| 100              | 3.205                 | 3.336            | 3.468           |

**TA, TC, TCJ, TE, TS, TO sensors**

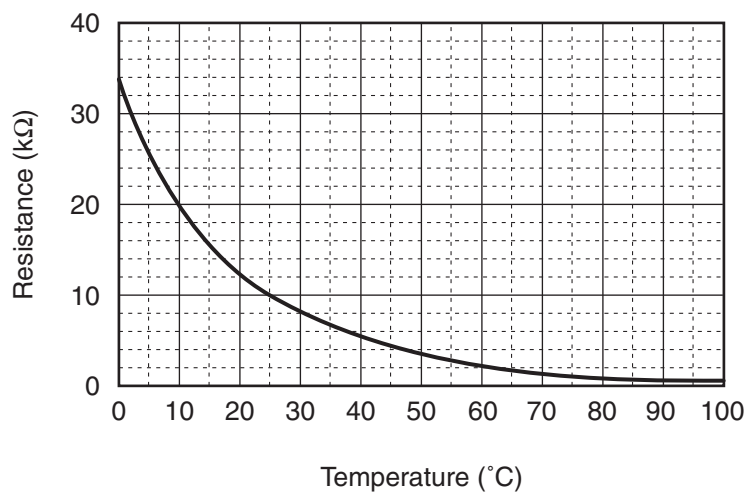

Output voltage (V)

**TD, TL sensors**

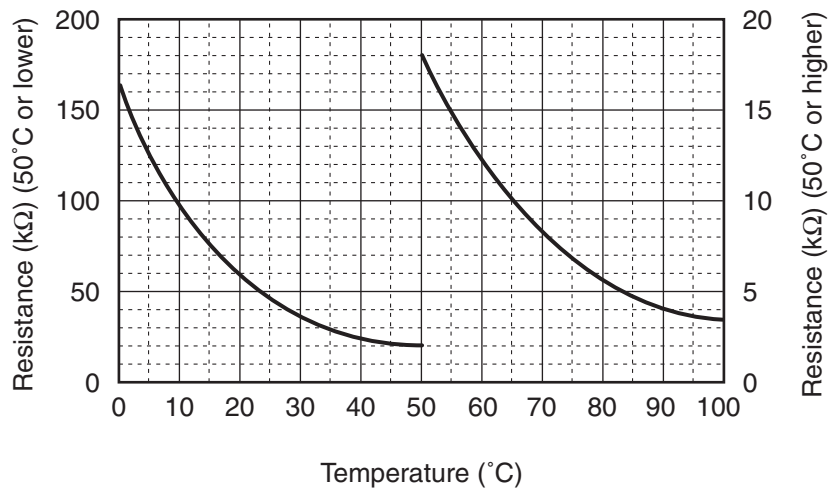

\* As TH sensor (Outdoor unit heat sink temp. sensor) is incorporated in the outdoor control P.C. board, the resistance value cannot be measured.

**Table Inspection of outdoor unit main parts**

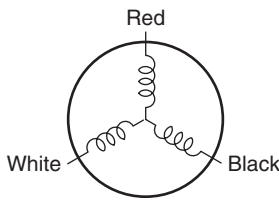
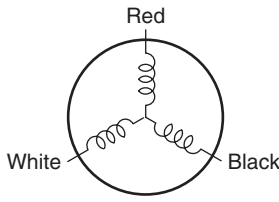
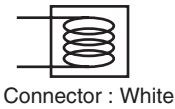
| No.              | Parts name   | Checking procedure   |                  |                  |             |              |               |             |
|------------------|--|--|------------------|------------------|-------------|--------------|---------------|-------------|
| 1                | Compressor<br>(Model : DA422A3F-12M)                               | <p>Measure the resistance value of each winding by using the tester.</p> <div style="display: flex; align-items: center;">  <table border="1" data-bbox="890 324 1423 542"> <thead> <tr> <th>Position</th> <th>Resistance value</th> </tr> </thead> <tbody> <tr> <td>Red – White</td> <td rowspan="3" style="text-align: center; vertical-align: middle;">0.476 Ω</td> </tr> <tr> <td>White – Black</td> </tr> <tr> <td>Black – Red</td> </tr> </tbody> </table> </div> <p style="text-align: right;">Under 20°C</p>      | Position         | Resistance value | Red – White | 0.476 Ω      | White – Black | Black – Red |
| Position         | Resistance value   |  |                  |                  |             |              |               |             |
| Red – White      | 0.476 Ω  |  |                  |                  |             |              |               |             |
| White – Black    |  |  |                  |                  |             |              |               |             |
| Black – Red      |  |  |                  |                  |             |              |               |             |
| 2                | Outdoor fan motor<br>(Model : WDF-340-A100-1)                      | <p>Measure the resistance value of each winding by using the tester.</p> <div style="display: flex; align-items: center;">  <table border="1" data-bbox="890 672 1423 889"> <thead> <tr> <th>Position</th> <th>Resistance value</th> </tr> </thead> <tbody> <tr> <td>Red – White</td> <td rowspan="3" style="text-align: center; vertical-align: middle;">17.3 ± 1.7 Ω</td> </tr> <tr> <td>White – Black</td> </tr> <tr> <td>Black – Red</td> </tr> </tbody> </table> </div> <p style="text-align: right;">Under 20°C</p> | Position         | Resistance value | Red – White | 17.3 ± 1.7 Ω | White – Black | Black – Red |
| Position         | Resistance value   |  |                  |                  |             |              |               |             |
| Red – White      | 17.3 ± 1.7 Ω   |  |                  |                  |             |              |               |             |
| White – Black    |  |  |                  |                  |             |              |               |             |
| Black – Red      |  |  |                  |                  |             |              |               |             |
| 3                | 4-way valve coil<br>(Cooling/heating switching)<br>(Model : STF-H) | <p>Measure the resistance value of each winding by using the tester.</p> <div style="display: flex; align-items: center;">  <table border="1" data-bbox="890 1019 1423 1131"> <thead> <tr> <th>Resistance value</th> </tr> </thead> <tbody> <tr> <td style="text-align: center;">1215.3 ± 121.5 Ω</td> </tr> </tbody> </table> </div> <p style="text-align: right;">Under 20°C</p>  | Resistance value | 1215.3 ± 121.5 Ω |             |              |               |             |
| Resistance value |  |  |                  |                  |             |              |               |             |
| 1215.3 ± 121.5 Ω |  |  |                  |                  |             |              |               |             |

## 9. SETUP AT LOCAL SITE AND OTHERS

### 9-1. Calling of Error History

#### <Contents>

The error contents in the past can be called.

#### <Procedure>

- 1 Push **SET** + **TEST** buttons simultaneously for 4 seconds or more to call the service check mode.

Service Check goes on, the **CODE No. 01** is displayed, and then the content of the latest alarm is displayed. The number and error contents of the indoor unit in which an error occurred are displayed.

- 2 In order to monitor another error history, push the set temperature **▼** / **▲** buttons to change the error history No. (CODE No.).

**CODE No. 01** (Latest) → **CODE No. 04** (Old)

**NOTE** : 4 error histories are stored in memory.

- 3 Pushing **TEST** button returns the display to usual display.

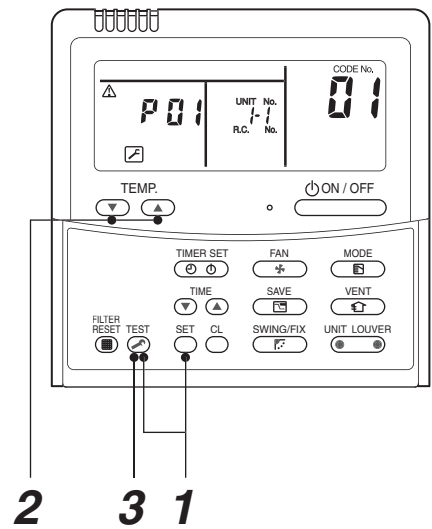

<Operation procedure>

**1 → 2 → 3**

Returned to usual display

#### REQUIREMENT

Do not push **CL** button, otherwise all the error histories of the indoor unit are deleted.

### 9-2. Group Control Operation

In a group control, operation of maximum 8 indoor units can be controlled by a remote controller.

The indoor unit connected with outdoor unit (Individual/Master of twin) controls room temperature according to setting on the remote controller.

#### <System example>

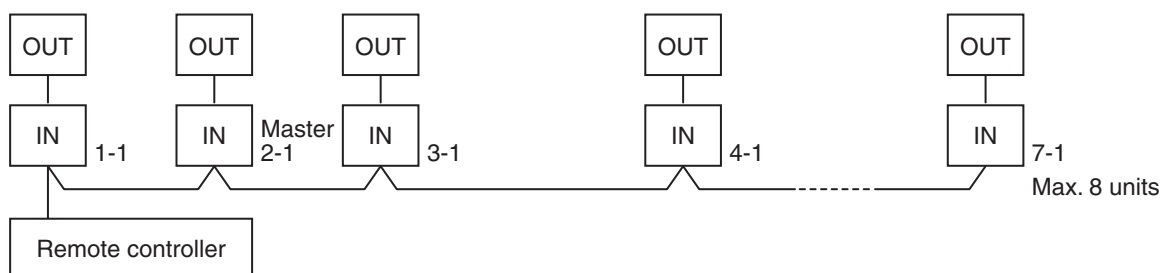

1. Display range on remote controller

The setup range (Operation mode/Air volume select/Setup temp) of the indoor unit which was set to the master unit is reflected on the remote controller.

2. Address setup

Turn on power of the indoor unit to be controlled in a group within 3 minutes after setting of automatic address. If power of the indoor unit is not turned on within 3 minutes (completion of automatic address setting), the system is rebooted and the automatic address setting will be judged again.

- 1) Connect 3 In/Out cables surely.
- 2) Check line address/indoor address/group address of the unit one by one.
- 3) The unit No. (line/indoor gout address) which have been set once keep the present status as a rule if the unit No. is not duplicated with one of another unit.

## ■ Indoor unit power-ON sequence

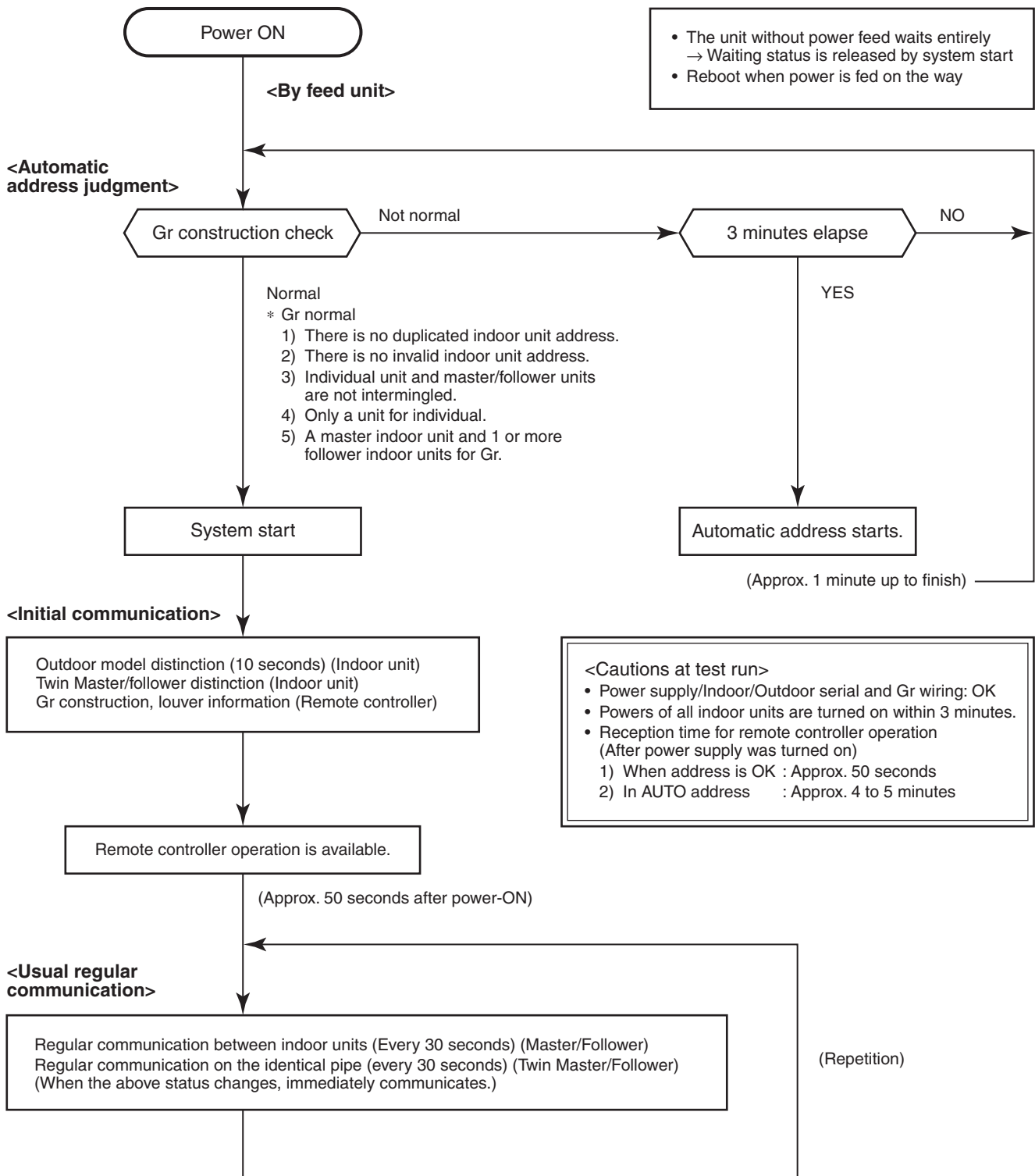

- In a group operation, if the indoor unit which was fed power after judgment of automatic address cannot receive regular communication from the master unit and regular communication on identical pipe within 120 seconds after power was turned on, it reboots (system reset).
  - The operation starts from judgment of automatic address (Gr construction check) again.  
(If the address of the master unit was determined in the previous time, the power fed to the master unit and reboot works, the master unit may change though the indoor unit line address is not changed.)



### 9-3. Outdoor Unit

Various displays and various operations are enabled by push buttons (service) switches and LED on the outdoor control P.C. board.

#### Service switch (SW800, SW801) operations

##### LED display

- 4 patterns are provided for LED display.

○ : ON, ● : OFF, ◎ : Rapid flashing (5 times/second), ◇ : Slow flashing (Once/second)

- In the initial status of LED display, D805 is ON as the right figure.

When the initial status does not appear (in case of flashing of D805), LED display can be returned to the initial status by pushing and holding the service switches SW800 and SW801 for 5 seconds or more simultaneously.

| LED display: Initial status |   |
|-----------------------------|---|
| LED                         |   |
| D800                        | <input type="checkbox"/> (Yellow) OFF or rapid flashing |
| D801                        | <input type="checkbox"/> (Yellow) OFF or rapid flashing |
| D802                        | <input type="checkbox"/> (Yellow) OFF or rapid flashing |
| D803                        | <input type="checkbox"/> (Yellow) OFF or rapid flashing |
| D804                        | <input type="checkbox"/> (Yellow) OFF or rapid flashing |
| D805                        | <input checked="" type="checkbox"/> (Green) ON          |

#### 9-3-1. Refrigerant recovery control

HFC refrigerant is "Ozone layer destructive coefficient = 0". However the discharge regulation is established for HFC refrigerant as it is greenhouse gas.

For this Model, a switch is mounted for refrigerant recovery operation (pump down) by the outdoor unit so that this Model can easily react to the environment when it will be reinstalled or scrapped.

##### [Operating method]

- Set fan operation to the indoor unit.
- Check LED display is the initial status. If it is not so, set the initial status.
- Push and hold SW800 for 5 seconds or more and then check D804 flashes slowly.
- Push SW800 several times and then stop it at the point where LED display (D800 to D804) is indicated as the following table.

| D800 | D801 | D802 | D803 | D804 |
|------|------|------|------|------|
| ○    | ●    | ●    | ●    | ◎    |

○ : ON, ● : OFF, ◎ : Rapid flashing (5 times/second)

- Push SW801 so that D805 flashes rapidly.
  - Push and hold SW801 for 5 seconds or more. The forced cooling operation starts if D804 flashes slowly and D805 is turned on. (Max. 10 minutes)
  - After operation for 3 minutes or more, close the valve at liquid side.
  - After recovery of refrigerant, close the valve at gas side.
  - Push and hold SW800 and SW801 for 5 seconds or more simultaneously. The LED returns to the initial status, the cooling operation stops and the indoor fan operation stops.
  - Turn off the power supply.
- \* If an unknown point generated on the way of the operation, push and hold SW800 and SW801 for 5 seconds or more simultaneously. You can return to the item 2).

## 9-3-2. Various settings on outdoor unit (Existing piping, power save, cooling-only, etc.)

### (1) Service switch setting

Various settings are available by setting service switches.

#### [Operating method]

- 1) Check LED display is the initial status. If it is not so, set the initial status.
- 2) Push and hold SW800 for 5 seconds or more and then check D804 flashes slowly.
- 3) Push SW800 several times and then stop it at the LED display of function item to be set up.

| Function               | LED display |           |           |           |           | Control contents  |       |       |  |       |  |      |      |      |      |                 |      |      |      |      |                       |      |      |      |      |
|------------------------|-------------|-----------|-----------|-----------|-----------|---|-------|-------|--|-------|--|------|------|------|------|-----------------|------|------|------|------|-----------------------|------|------|------|------|
| Existing pipes setting | D800<br>●   | D801<br>● | D802<br>○ | D803<br>● | D804<br>◎ | When the existing piping uses Ø19.1 pipe, this function is validated. In this case, the heating capacity may drop due to outside temp. and indoor temp. in heating time.  |       |       |  |       |  |      |      |      |      |                 |      |      |      |      |                       |      |      |      |      |
| Power save setting     | D800<br>○   | D801<br>○ | D802<br>● | D803<br>● | D804<br>◎ | This function validates the power save function. This function lowers the compressor frequency. In this case, the Max. capacity drops (Approx. -10%)  |       |       |  |       |  |      |      |      |      |                 |      |      |      |      |                       |      |      |      |      |
| Snow-break fan control | D800<br>●   | D801<br>○ | D802<br>● | D803<br>● | D804<br>◎ | This function validates the control to prevent occurrence of motor lock by the accumulated snow entered from clearance of the fan guard or heat exchanger into blast route. Even when the compressor stops, the outdoor fan is operated with W3 when the outside temperature is under 7°C.  |       |       |  |       |  |      |      |      |      |                 |      |      |      |      |                       |      |      |      |      |
| Max. frequency change  | D800<br>●   | D801<br>● | D802<br>● | D803<br>○ | D804<br>◎ | This function is validated if the max. value of compressor frequency is required to lower. It lowers the max. frequency in cooling/heating time. In this case, the max. capacity lowers.<br>Max. compressor frequency (rps) <table border="1" style="margin-left: 20px;"> <thead> <tr> <th rowspan="2">Model</th> <th colspan="2">SM110</th> <th colspan="2">SM140</th> </tr> <tr> <th>Cool</th> <th>Heat</th> <th>Cool</th> <th>Heat</th> </tr> </thead> <tbody> <tr> <td>Standard status</td> <td>54.0</td> <td>54.6</td> <td>65.4</td> <td>73.2</td> </tr> <tr> <td>When setting is valid</td> <td>48.6</td> <td>48.6</td> <td>65.4</td> <td>65.4</td> </tr> </tbody> </table> | Model | SM110 |  | SM140 |  | Cool | Heat | Cool | Heat | Standard status | 54.0 | 54.6 | 65.4 | 73.2 | When setting is valid | 48.6 | 48.6 | 65.4 | 65.4 |
| Model                  | SM110       |           | SM140     |           |           |   |       |       |  |       |  |      |      |      |      |                 |      |      |      |      |                       |      |      |      |      |
|                        | Cool        | Heat      | Cool      | Heat      |           |   |       |       |  |       |  |      |      |      |      |                 |      |      |      |      |                       |      |      |      |      |
| Standard status        | 54.0        | 54.6      | 65.4      | 73.2      |           |   |       |       |  |       |  |      |      |      |      |                 |      |      |      |      |                       |      |      |      |      |
| When setting is valid  | 48.6        | 48.6      | 65.4      | 65.4      |           |   |       |       |  |       |  |      |      |      |      |                 |      |      |      |      |                       |      |      |      |      |

○ : ON, ● : OFF, ◎ : Rapid flashing (5 times/second)

- 4) Push SW801 so that D805 will flash rapidly.
  - 5) Push and hold SW801 for 5 seconds or more. D804 changes to slow flashing, D805 changes to lighting and then various settings are validated.
  - 6) When you want to continue the settings, moreover repeat items from 3) to 5).
  - 7) To invalidate various settings, execute items 1) to 3), push SW801 and then turn off D805.
  - 8) Push and hold SW801 for 5 seconds or more. D804 changes to slow flashing, D805 is turned off and then various settings are invalidated.
- \* If an unknown point generated on the way of the operation, push and hold SW800 and SW801 for 5 seconds or more simultaneously. You can return to the item (1).

### Confirmation method of various settings

You can confirm that various settings are validated.

- 1) Check LED displays are in the initial status. If it are not so, return them to the initial status.
- 2) Push and hold SW800 for 5 seconds or more. D804 changes to slow flashing.
- 3) Push SW800 several times and then stop it at the point where LED display (D800 to D804) to be checked. If the setting became valid, D804 and D805 flash rapidly. (When the setup was invalid, D804 flashes rapidly and D805 goes off.)
- 4) Push SW800 and SW801 for 5 seconds or more simultaneously to return LED display to the initial status.

### In the case to return the setting to one at shipment from factory

When to return the setting to one at shipment from the factory due to reinstallation and so on, the setting can be returned in the following procedure.

- 1) Check LED display is the initial status. If it is not the initial status, return the setting to the initial status.
- 2) Push and hold SW800 for 5 seconds or more and then check D804 flashes slowly.
- 3) Push SW800 several times to make LED display status to "LED display to return the setting at shipment from the factory" in the right table.
- 4) Push and hold SW801 for 5 seconds or more and then check D804 flashes slowly.
- 5) Push and hold SW800 and SW801 simultaneously to return the LED display to the initial status.

| LED display to return the setting at shipment from the factory |      |      |      |      |      |
|--|------|------|------|------|------|
| D800   | D801 | D802 | D803 | D804 | D805 |
| ●  | ●    | ●    | ●    | ◎    | ●    |

○: ON, ●: OFF,  
◎: Rapid flashing (5 times/second)

### (2) Cooling-only setting

By changing setting of the jumper line, the setting can be changed to a cooling-only air conditioner.

| Function             | Setting position | Control contents   |
|----------------------|------------------|--|
| Cooling-only setting | J804             | When using the machine as a ooling-only air conditioner, cut the left jumper line.<br>(There is another method to change the machine to a cooling-only air conditioner; that is to use DN code "0F" of the remote controller.) |

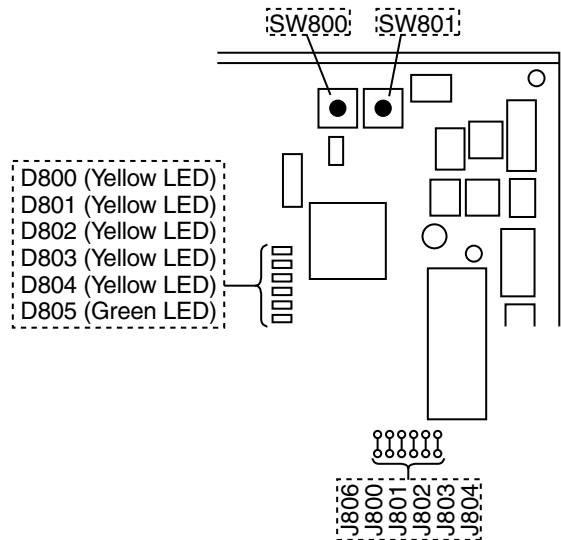

### 9-3-3. Service support function (LED display, service switch operating method)

#### 1. LED display switching

##### 1-1. Display switching list

The displayed contents of LED D800 to D805 on the outdoor P.C. board can be switched by handling the service switches SW800 and SW801.

##### [Operating method]

- 1) Check LED display is the initial status. If it is not so, set the initial status.
- 2) Push SW800 several times and then stop it at the point where LED display to be indicated.

| LED display |      |      |      |      |      | Control contents  |
|-------------|------|------|------|------|------|---|
| D800        | D801 | D802 | D803 | D804 | D805 | Error display (Error which is occurring at present)<br>The error which is occurring at present is displayed.<br>LED goes off while an error does not occur. (Refer to A)  |
| ●           | ●    | ●    | ●    | ●    | ○    |   |
| D800        | D801 | D802 | D803 | D804 | D805 | Error display (The latest error: The latest error including this moment)<br>After error status was eliminated, if you want to check the error which occurred before, call this setting and check it.<br>(Even after turning off the power supply once, you can recheck it.)<br>* In the case that an error occurred at present, the same contents as that at present is displayed.<br>* TO sensor error only is not displayed in this setting.<br>(Check setting which is occurring at present.) (Refer to B) |
| ○           | ●    | ●    | ●    | ●    | ○    |   |
| D800        | D801 | D802 | D803 | D804 | D805 | Discharge temperature sensor (TD) display<br>Detected value of the discharge temperature (TD) is displayed. (Refer to C)  |
| ●           | ○    | ●    | ●    | ●    | ○    |   |
| D800        | D801 | D802 | D803 | D804 | D805 | Outdoor heat exchanger temperature sensor (TE) display<br>Detected value of the outdoor heat exchanger temperature sensor (TE) is displayed. (Refer to C)   |
| ○           | ○    | ●    | ●    | ●    | ○    |   |
| D800        | D801 | D802 | D803 | D804 | D805 | Liquid temperature sensor (TL) display<br>The detected value of the liquid temperature sensor (TL) is displayed. (Refer to C)   |
| ●           | ○    | ○    | ●    | ●    | ○    |   |
| D800        | D801 | D802 | D803 | D804 | D805 | Suction temperature sensor (TS) display<br>Detected value of the suction temperature sensor (TS) is displayed. (Refer to C)   |
| ●           | ●    | ○    | ●    | ●    | ○    |   |
| D800        | D801 | D802 | D803 | D804 | D805 | Outside temperature sensor (TO) display<br>Detected value of the outside temperature sensor (TO) is displayed. (Refer to C)   |
| ○           | ●    | ○    | ●    | ●    | ○    |   |
| D800        | D801 | D802 | D803 | D804 | D805 | Heat sink temperature sensor (TH) display<br>Detected value of the heat sink temperature sensor (TH) is displayed. (Refer to C)   |
| ○           | ○    | ○    | ●    | ●    | ○    |   |
| D800        | D801 | D802 | D803 | D804 | D805 | Current display<br>The current value which flows to the outdoor unit is displayed. (Refer to C)   |
| ○           | ●    | ●    | ○    | ●    | ○    |   |
| D800        | D801 | D802 | D803 | D804 | D805 | Compressor operation frequency display<br>The operation frequency of the compressor is displayed. (Refer to C)  |
| ●           | ○    | ●    | ○    | ●    | ○    |   |
| D800        | D801 | D802 | D803 | D804 | D805 | PMV opening display<br>The opening of PMV (Electronic expansion valve) is displayed. (Refer to C)   |
| ○           | ○    | ●    | ○    | ●    | ○    |   |
| D800        | D801 | D802 | D803 | D804 | D805 | Indoor suction temperature sensor (TA) display<br>The detected value of the indoor suction temperature sensor (TA) is displayed. (Refer to C)   |
| ●           | ●    | ○    | ○    | ●    | ○    |   |
| D800        | D801 | D802 | D803 | D804 | D805 | Indoor heat exchanger temperature sensor (TC) display<br>The detected value of the indoor heat exchanger temperature sensor (TC) is displayed. (Refer to C)   |
| ○           | ●    | ○    | ○    | ●    | ○    |   |
| D800        | D801 | D802 | D803 | D804 | D805 | Indoor heat exchanger temperature (TCJ) display<br>The detected value of the indoor heat exchanger temperature sensor (TCJ) is displayed. (Refer to C)  |
| ○           | ●    | ○    | ○    | ●    | ○    |   |

○ : ON, ● : OFF, ◎ : Rapid flashing (5 times/second)

- 3) Pushing SW901 changes item to one to be displayed.
- 4) To see other display contents, repeat items 1) to 3).
- 5) To finish LED display, be sure to execute item 1) to return LED to the initial status (error display of current occurrence) and then finish LED display.

## 1-2. Error display

The error which is occurring at present and the latest error (the latest error data including one which is occurring now) can be confirmed by lighting LED D800 to D805 on the outdoor control P.C. board.

### A. Error display which occurs at present

| LED display |      |      |      |      |      | Error name                                   | Wired remote controller error code |                             |
|-------------|------|------|------|------|------|--|------------------------------------|-----------------------------|
| D800        | D801 | D802 | D803 | D804 | D805 |  | Indoor units before 3 series       | Indoor units after 4 series |
| ●           | ●    | ●    | ●    | ●    | ○    | Normal                                       | -                                  | -                           |
| ○           | ●    | ●    | ●    | ●    | ○    | Discharge temp. sensor (TD) error            | F04                                | F04                         |
| ●           | ○    | ●    | ●    | ●    | ○    | Heat exchanger temp. sensor (TE) error       | F06                                | F06                         |
| ○           | ○    | ●    | ●    | ●    | ○    | Liquid temp. sensor (TL) error               | F06                                | F07                         |
| ●           | ●    | ○    | ●    | ●    | ○    | Outside temp. sensor (TO) error              | F08                                | F08                         |
| ○           | ●    | ○    | ●    | ●    | ○    | Suction temp. sensor (TS) error              | F06                                | F12                         |
| ●           | ○    | ○    | ●    | ●    | ○    | Heat sink temp. sensor (TH) error            | L29                                | F13                         |
| ○           | ○    | ○    | ●    | ●    | ○    | Heat exchanger sensor (TE, TS) misconnection | F06                                | F15                         |
| ●           | ○    | ●    | ○    | ●    | ○    | EEPROM error                                 | L29                                | F31                         |
| ○           | ○    | ●    | ○    | ○    | ○    | Compressor breakdown                         | H01                                | H01                         |
| ●           | ●    | ○    | ○    | ●    | ○    | Compressor lock                              | H02                                | H02                         |
| ●           | ●    | ●    | ●    | ○    | ○    | Model unset                                  | L29                                | L10                         |
| ●           | ○    | ●    | ●    | ○    | ○    | Discharge temp. error                        | P03                                | P03                         |
| ○           | ○    | ●    | ●    | ○    | ○    | High-pressure SW error                       | P04                                | P04                         |
| ○           | ●    | ○    | ○    | ●    | ○    | Current detection circuit error              | H03                                | H03                         |
| ○           | ●    | ○    | ●    | ○    | ○    | Power supply error                           | P04                                | P05                         |
| ●           | ○    | ○    | ●    | ○    | ○    | Heat sink overheat error                     | L29                                | P07                         |
| ○           | ○    | ○    | ●    | ○    | ○    | Gas leak detection                           | L29                                | P15                         |
| ●           | ●    | ●    | ○    | ○    | ○    | 4-way valve reversal error                   | L29                                | P19                         |
| ○           | ●    | ●    | ○    | ○    | ○    | High pressure protective operation           | P04                                | P20                         |
| ●           | ○    | ●    | ○    | ○    | ○    | Fan system error                             | P22                                | P22                         |
| ○           | ○    | ●    | ○    | ○    | ○    | Driving element short circuit                | P26                                | P26                         |
| ●           | ●    | ○    | ○    | ○    | ○    | Position detection circuit error             | P29                                | P29                         |
| ○           | ●    | ○    | ○    | ○    | ○    | Others (No determination)                    | L31                                | L31                         |

○ : ON, ● : OFF, ◎ : Rapid flashing (5 times/second)

### B. Error display of the latest (including error which occurs at present) error

| LED display |      |      |      |      |      | Error name                                   |
|-------------|------|------|------|------|------|--|
| D800        | D801 | D802 | D803 | D804 | D805 |  |
| ●           | ●    | ●    | ●    | ●    | ◇    | Normal                                       |
| ○           | ●    | ●    | ●    | ●    | ◇    | Discharge temp. sensor (TD) error            |
| ●           | ○    | ●    | ●    | ●    | ◇    | Heat exchanger temp. sensor (TE) error       |
| ○           | ○    | ●    | ●    | ●    | ◇    | Liquid temp. sensor (TL) error               |
| ○           | ●    | ○    | ●    | ●    | ◇    | Suction temp. sensor (TS) error              |
| ●           | ○    | ○    | ●    | ●    | ◇    | Heat sink temp. sensor (TH) error            |
| ○           | ○    | ○    | ●    | ●    | ◇    | Heat exchanger sensor (TE, TS) misconnection |
| ●           | ○    | ●    | ○    | ●    | ◇    | EEPROM error                                 |
| ○           | ○    | ●    | ○    | ●    | ◇    | Compressor breakdown                         |
| ●           | ●    | ○    | ○    | ●    | ◇    | Compressor lock                              |
| ●           | ●    | ●    | ●    | ○    | ◇    | Model unset                                  |
| ●           | ○    | ●    | ●    | ○    | ◇    | Discharge temp. error                        |
| ○           | ○    | ●    | ●    | ○    | ◇    | High-pressure SW error                       |
| ○           | ●    | ○    | ○    | ●    | ◇    | Current detection circuit error              |
| ○           | ●    | ○    | ●    | ○    | ◇    | Power supply error                           |
| ●           | ○    | ○    | ●    | ○    | ◇    | Heat sink overheat error                     |
| ○           | ○    | ○    | ●    | ○    | ◇    | Gas leak detection                           |
| ●           | ●    | ●    | ○    | ○    | ◇    | 4-way valve reversal error                   |
| ○           | ●    | ●    | ○    | ○    | ◇    | High pressure protective operation           |
| ●           | ○    | ●    | ○    | ○    | ◇    | Fan system error                             |
| ○           | ○    | ●    | ○    | ○    | ◇    | Driving element short circuit                |
| ●           | ●    | ○    | ○    | ○    | ◇    | Position detection circuit error             |
| ○           | ●    | ○    | ○    | ○    | ◇    | Others (No determination)                    |

○ : ON, ● : OFF, ◎ : Rapid flashing (5 times/second), ◇ : Slow flashing (Once/second)

### C. Sensor, current, compressor operation frequency, PMV opening display

The values, such as the temperature sensor or the current value, which the controller detects are easily confirmed.

\* Temperature sensor: TD, TE, TL, TS, TO, TH, TA, TC, TCJ

| LED display |      |      |      |      |      | Temp. sensor<br>(°C) | Current<br>(A) | Compressor<br>frequency (rps) | PMV opening<br>(pls) |
|-------------|------|------|------|------|------|----------------------|----------------|-------------------------------|----------------------|
| D800        | D801 | D802 | D803 | D804 | D805 |                      |                |                               |                      |
| ●           | ●    | ●    | ●    | ●    | ◇    | - 25 or less         | 0 ~            | 0 ~                           | 0 ~ 19               |
| ○           | ●    | ●    | ●    | ●    | ◇    | - 25 ~               | 1 ~            | 5 ~                           | 20 ~ 39              |
| ●           | ○    | ●    | ●    | ●    | ◇    | - 20 ~               | 2 ~            | 10 ~                          | 40 ~ 59              |
| ○           | ○    | ●    | ●    | ●    | ◇    | - 15 ~               | 3 ~            | 15 ~                          | 60 ~ 79              |
| ●           | ●    | ○    | ●    | ●    | ◇    | - 10 ~               | 4 ~            | 20 ~                          | 80 ~ 99              |
| ○           | ●    | ○    | ●    | ●    | ◇    | - 5 ~                | 5 ~            | 25 ~                          | 100 ~ 119            |
| ●           | ○    | ○    | ●    | ●    | ◇    | 0 ~                  | 6 ~            | 30 ~                          | 120 ~ 139            |
| ○           | ○    | ○    | ●    | ●    | ◇    | 5 ~                  | 7 ~            | 35 ~                          | 140 ~ 159            |
| ●           | ●    | ●    | ○    | ●    | ◇    | 10 ~                 | 8 ~            | 40 ~                          | 160 ~ 179            |
| ○           | ●    | ●    | ○    | ●    | ◇    | 15 ~                 | 9 ~            | 45 ~                          | 180 ~ 199            |
| ●           | ○    | ●    | ○    | ●    | ◇    | 20 ~                 | 10 ~           | 50 ~                          | 200 ~ 219            |
| ○           | ○    | ●    | ○    | ●    | ◇    | 25 ~                 | 11 ~           | 55 ~                          | 220 ~ 239            |
| ●           | ●    | ○    | ○    | ●    | ◇    | 30 ~                 | 12 ~           | 60 ~                          | 240 ~ 259            |
| ○           | ●    | ○    | ○    | ●    | ◇    | 35 ~                 | 13 ~           | 65 ~                          | 260 ~ 279            |
| ●           | ○    | ○    | ○    | ●    | ◇    | 40 ~                 | 14 ~           | 70 ~                          | 280 ~ 299            |
| ○           | ○    | ○    | ○    | ●    | ◇    | 45 ~                 | 15 ~           | 75 ~                          | 300 ~ 319            |
| ●           | ●    | ●    | ●    | ○    | ◇    | 50 ~                 | 16 ~           | 80 ~                          | 320 ~ 339            |
| ○           | ●    | ●    | ●    | ○    | ◇    | 55 ~                 | 17 ~           | 85 ~                          | 340 ~ 359            |
| ●           | ○    | ●    | ●    | ○    | ◇    | 60 ~                 | 18 ~           | 90 ~                          | 360 ~ 379            |
| ○           | ○    | ●    | ●    | ○    | ◇    | 65 ~                 | 19 ~           | 95 ~                          | 380 ~ 399            |
| ●           | ●    | ○    | ●    | ○    | ◇    | 70 ~                 | 20 ~           | 100 ~                         | 400 ~ 419            |
| ○           | ●    | ○    | ●    | ○    | ◇    | 75 ~                 | 21 ~           | 105 ~                         | 420 ~ 439            |
| ●           | ○    | ○    | ●    | ○    | ◇    | 80 ~                 | 22 ~           | 110 ~                         | 440 ~ 459            |
| ○           | ○    | ○    | ●    | ○    | ◇    | 85 ~                 | 23 ~           | 115 ~                         | 460 ~ 479            |
| ●           | ●    | ●    | ○    | ○    | ◇    | 90 ~                 | 24 ~           | 120 ~                         | 480 ~ 499            |
| ○           | ●    | ●    | ○    | ○    | ◇    | 95 ~                 | 25 ~           | 125 ~                         | 500                  |
| ●           | ○    | ●    | ○    | ○    | ◇    | 100 ~                | 26 ~           | 130 ~                         | -                    |
| ○           | ○    | ●    | ○    | ○    | ◇    | 105 ~                | 27 ~           | 135 ~                         | -                    |
| ●           | ●    | ○    | ○    | ○    | ◇    | 110 ~                | 28 ~           | 140 ~                         | -                    |
| ○           | ●    | ○    | ○    | ○    | ◇    | 115 ~                | 29 ~           | 145 ~                         | -                    |
| ●           | ○    | ○    | ○    | ○    | ◇    | 120 or more          | 30 ~           | 150 ~                         | -                    |
| ○           | ○    | ○    | ○    | ○    | ◇    | Sensor error         | 31 or more     | 155 or more                   | -                    |

○ : ON, ● : OFF, ◇ : Slow flashing (Once/second)

## 2. Special operation for maintenance check (SW800 and SW801 operations)

The following special operations for maintenance check can be performed by handling the service switches SW800 and SW801.

### [Operating method]

- 1) Check LED display is the initial status. If it is not so, set the initial status.
- 2) Push and hold SW800 for 5 seconds or more and then check D804 flashes slowly.
- 3) Push SW800 and then stop it at the LED display of the function item to be set.

| Special operation                      | LED display |           |           |           |           | Control contents  |
|--|-------------|-----------|-----------|-----------|-----------|---|
| Refrigerant recovery operation         | D800<br>○   | D801<br>● | D802<br>● | D803<br>● | D804<br>◎ | The outdoor unit performs cooling operation. As the indoor unit does not operate by this operation only, carry out the fan operation beforehand. (Refer to 9-3-1.)              |
| PMV full open operation                | D800<br>○   | D801<br>● | D802<br>○ | D803<br>● | D804<br>◎ | Open PMV (Electronic expansion valve) fully. Execute the following item 6) or the control returns to normal operation after 2 minutes. (Refer Note 1)                           |
| PMV full close operation               | D800<br>●   | D801<br>○ | D802<br>○ | D803<br>● | D804<br>◎ | Close PMV (Electronic expansion valve) completely. Execute the following item 6) or the control returns to normal operation after 2 minutes. (Refer Note 1)                     |
| PMV middle opening operation           | D800<br>○   | D801<br>○ | D802<br>○ | D803<br>● | D804<br>◎ | Open PMV (Electronic expansion valve) to middle position (250 pulses). Execute the following item 6) or the control returns to normal operation after 2 minutes. (Refer Note 1) |
| Indoor heating trial operation command | D800<br>○   | D801<br>● | D802<br>● | D803<br>○ | D804<br>◎ | Carry out a trial heating operation. The operation returns to the normal control by executing the following item 6). (Refer Note 2)   |
| Indoor cooling trial operation command | D800<br>●   | D801<br>○ | D802<br>● | D803<br>○ | D804<br>◎ | Carry out a trial cooling operation. The operation returns to the normal control by executing the following item 6). (Refer Note 2)   |
| Fan motor forced operation             | D800<br>○   | D801<br>○ | D802<br>● | D803<br>○ | D804<br>◎ | Operate the fan motor forcedly. Execute the following item 6) or the control returns to normal operation after 2 minutes. (Refer Note 1)  |
| 4-way valve relay operation            | D800<br>●   | D801<br>● | D802<br>○ | D803<br>○ | D804<br>◎ | Turn on 4-way valve power relay (CN700) Execute the following item 6) or the control returns to normal operation after 2 minutes. (Refer Note 1)                                |

○ : ON, ● : OFF, ◎ : Rapid flashing (5 times/second)

(Note 1) Although these special operations are available even operating time, basically carry out these operations while the machine stops. If carrying out these operations, the pressure may change suddenly and a danger may grow.

(Note 2) Indoor trial cooling operation request / Indoor trial heating operation request

Cooling/heating trial operations are available from the outdoor unit only in combination with the following indoor units.

Trial operation is available: Indoor units after 4 series (RAV-SM\*\*\*\*4\*T-E)

Trial operation is unavailable: Indoor units except the above units or in case that the indoor units except the above units are included at twin connection.

Note) The forced trial operation in this setting cannot be cleared by the indoor remote controller. Be sure to clear it by operation of the outdoor unit (6 below).

- 4) Push SW801 and then stop it at point where D805 becomes rapid flashing.
  - 5) Push and hold SW801 for 5 seconds or more. D804 changes to slow flashing, D805 changes lighting and then the special operation becomes valid.
  - 6) To invalidate various settings, push and hold SW800 and SW801 for 5 seconds or more simultaneously. D800 to D804 go off (or rapid flashing), D805 goes on (Initial status: Display of error which is occurring at present), and then the special operation becomes invalid (normal control).
- \* If an unknown point generated on the way of the operation, push and hold SW800 and SW801 for 5 seconds or more simultaneously. You can return to the item 1).

#### **9-4. Applicable Control of Outdoor unit**

The following controls are enabled by connecting the part "Application control kit" (TCB-PCOS1E2) sold separately.

(1) Power peak cut control

\* The capacity of the outdoor unit is saved by the Demand signal from outside and corresponds to the temporary peak cut.

\* The capacity save is switched to 3 stages, 75%, 50% and operation stop.

(2) Night operation (Sound reduction)

\* Input a timer on the market (Arranged at site). The capacity is lowered regardless of load and the operation noise is reduced until 45dB. However the normal control is carried out if the outside temperature (TO sensor value) is 40°C or more.

(3) Compressor operation output

\* When the compressor drives, turn on the contact output of no voltage.



## 10. ADDRESS SETUP

### 10-1. Address Setup Procedure

When an outdoor unit and an indoor unit are connected, or when an outdoor unit is connected to each indoor unit respectively in the group operation even if multiple refrigerant lines are provided, the automatic address setup completes with power-ON of the outdoor unit. The operation of the remote controller is not accepted while automatic address works. (Approx. 4 to 5 minutes)

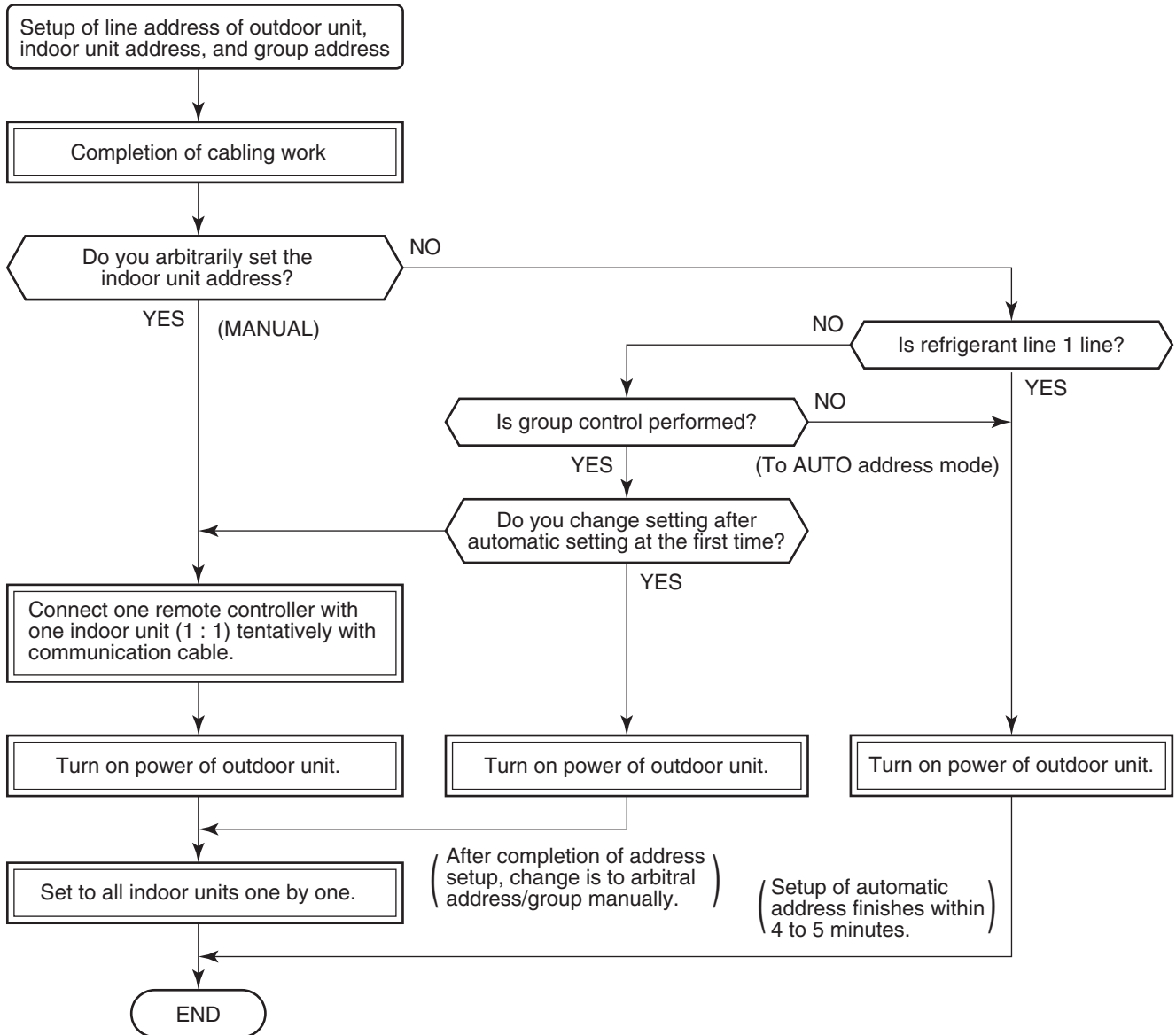

- When the following addresses are not stored in the neutral memory (IC503) on the indoor P.C. board, a test run operation cannot be performed. (Unfixed data at shipment from factory)

|                     | Item code | Data at shipment | Setup data range  |
|---------------------|-----------|------------------|---|
| Line address        | 12        | 0099             | 0001 (No. 1 unit) to 0064 (No. 64 unit)   |
| Indoor unit address | 13        | 0099             | 0001 (No. 1 unit) to 0064 (No. 64 unit)<br>Max. value of indoor units in the identical refrigerant line   |
| Group address       | 14        | 0099             | 0000 : Individual (Indoor units which are not controlled in a group)<br>0001 : Master unit (1 indoor unit in group control)<br>0002 : Sub unit (Indoor units other than master unit in group control) |

## 10-2. Address Setup & Group Control

### <Terminology>

Indoor unit No. : N - n = Outdoor unit line address N (Max. 30) - Indoor unit address n (Max. 64)

Group address : 0 = Single (Not group control)  
 1 = Master unit in group control  
 2 = Sub unit in group control

Master unit (= 1) : The representative of multiple indoor units in group operation sends/receives signals to/from the remote controllers and sub indoor units.  
 (\* It has no relation with an indoor unit which communicates serially with the outdoor units.)  
 The operation mode and setup temperature range are displayed on the remote controller LCD.  
 (Except air direction adjustment of louver)

Sub unit (= 2) : Indoor units other than master unit in group operation  
 Basically, sub units do not send/receive signals to/from the remote controllers.  
 (Except errors and response to demand of service data)

Header unit (Representative unit) (Master Twin)

: This unit communicates with the indoor unit (follower) which serial-communicates with the outdoor units and sends/receives signal (Command from compressor) to/from the outdoor units as the representative of the cycle control in the indoor units of the identical line address within the minimum unit which configures one of the refrigerating cycles of Twin.

Follower unit (Subordinate unit) (Sub Twin)

: Indoor units excluding the header unit in Twin

This unit communicates with (Header) indoor unit in the identical line address and performs control synchronized with (Header) indoor unit.

This unit does not perform the signal send/receive operation with the outdoor units. :  
 No judgment for serial signal error.

### 10-2-1. System Configuration

#### 1. Single

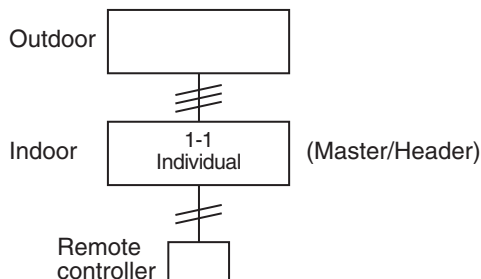

#### 2. Twin

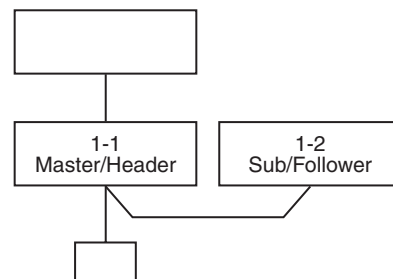

#### 3. Single group operation

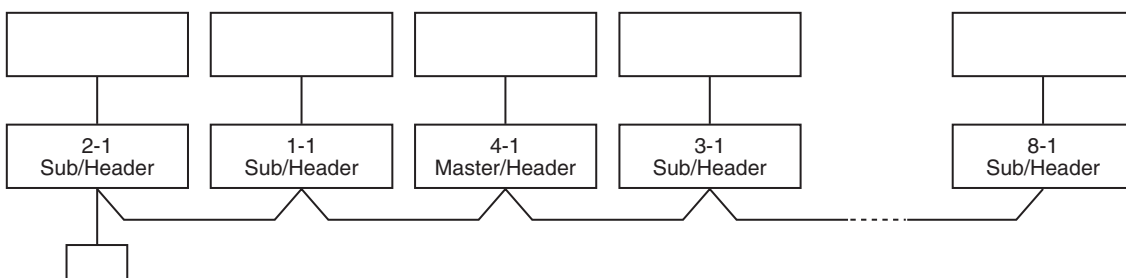

## 10-2-2. Automatic Address Example from Unset Address (No miswiring)

### 1. Standard (One outdoor unit)

#### 1) Single

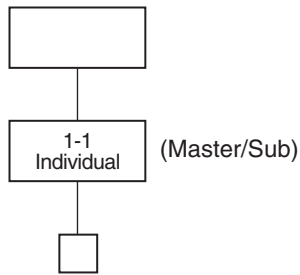

#### 2) Group operation (Twin, Triple operation)

(Multiple outdoor units = Multiple indoor units only with serial communication)

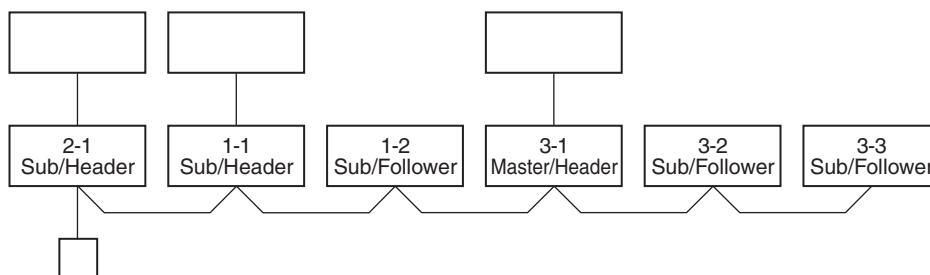

### Only turning on source power supply (Automatic completion)

- Header unit: The header unit receives the indoor unit data (thermo status) of the follower (Without identical line address & indoor/outdoor serial) and then finally controls the outdoor compressor matching with its own thermo status.  
The header unit sends this command information to the follower unit.
- Follower unit: The follower unit receives the indoor unit data from the header (With identical line address & indoor/outdoor serial) and then performs the thermo operation synchronized with the header unit.  
The follower unit sends own thermo ON/OFF demand to the header unit.

#### **(Example)**

No. 1-1 header unit sends/receives signal to/from No. 1-2 and No. 1-3 follower units.  
(It is not influenced by the line 2 or 3 address indoor unit.)

### 10-2-3. Automatic Address Example from Unset Address (No miswiring)

#### 1. Standard (One outdoor unit)

- 1) Single                      2) Twin

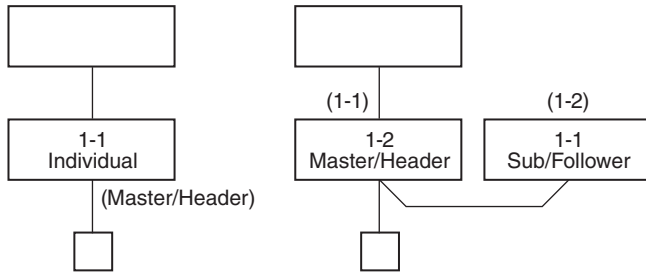

**Only turning on source power supply (Automatic completion)**

---

#### 2. Group operation

(Multiple outdoor units = Multiple indoor units with serial communication only, without twin)

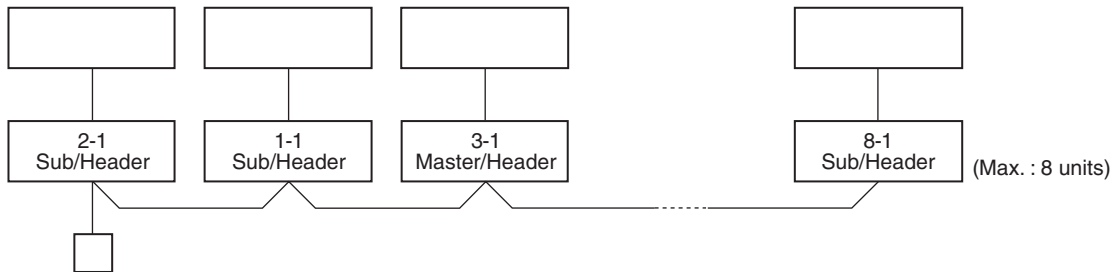

**Only turning on source power supply (Automatic completion)**

---

#### 3. Multiple groups operation

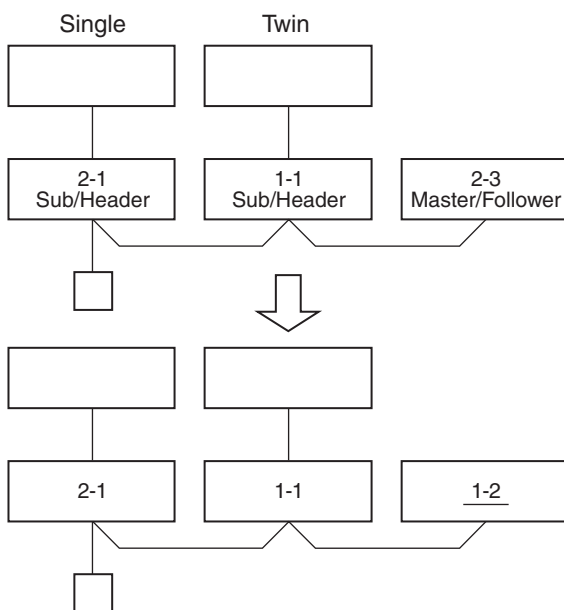

**Change is necessary**

**Manually change addresses of the multiple follower units simultaneously from the remote controller.**

---

### 10-3. Remote Controller Wiring

- Strip off approx. 9 mm the wire to be connected.
- For single system, use non polarity, 2 core wire is used for wiring of the remote controller. (0.5 mm<sup>2</sup> to 2.0 mm<sup>2</sup> wires)
- For the synchronous twin, triple system, use 2-core shield wire (Vinyl cord for microphone 0.5 to 2.0 mm<sup>2</sup>) to conform to the EMC standard.

### Wiring diagram

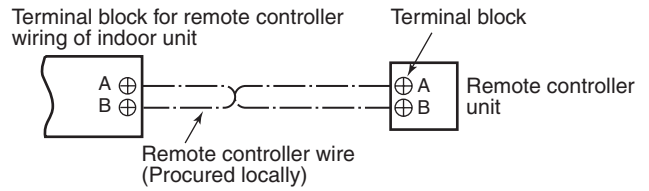

\* For details of wiring/installation of the remote controller, refer to the Installation Manual enclosed with the remote controller.

### Single system

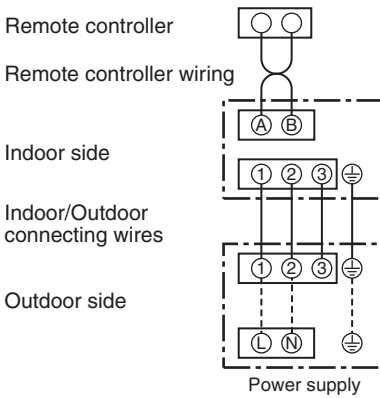

### Simultaneous twin system

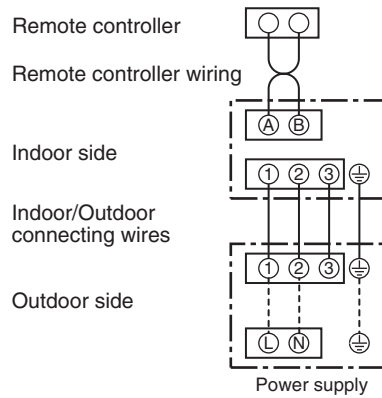

### 10-4. Address Setup (Manual setting from remote controller)

In case that addresses of the indoor units will be determined prior to piping work after cabling work

- Set an indoor unit per a remote controller.
- Turn on power supply.

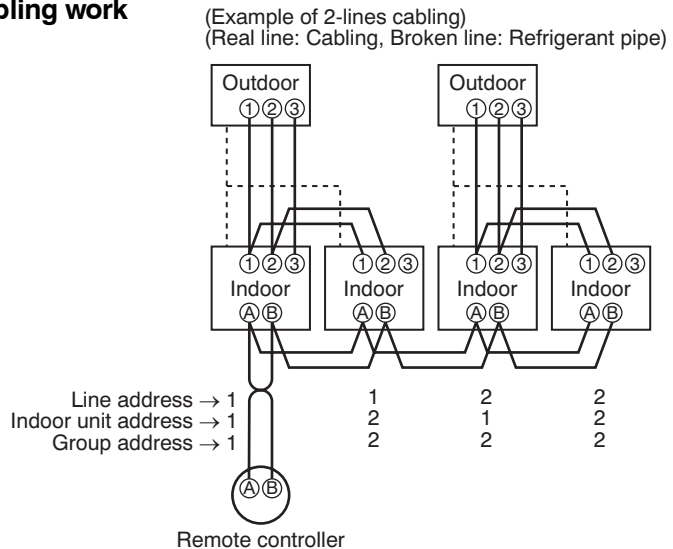

For the above example, perform setting by connecting singly the wired remote controller without remote controller inter-unit cable.

Group address  
 Individual : 0000  
 Master unit : 0001  
 Sub unit : 0002 } In case of group control

- 1** Push **SET** + **CL** + **TEST** buttons simultaneously for 4 seconds or more.
- 2** (← Line address)  
Using the temperature setup (▼) / (▲) buttons, set **I2** to the CODE No.
- 3** Using timer time (▼) / (▲) buttons, set the line address.
- 4** Push **SET** button. (OK when display goes on.)
- 5** (← Indoor unit address)  
Using the temperature setup (▼) / (▲) buttons, set **I3** to the CODE No.
- 6** Using timer time (▼) / (▲) buttons, set 1 to the line address.
- 7** Push **SET** button. (OK when display goes on.)
- 8** (← Group address)  
Using the temperature setup (▼) / (▲) buttons, set **I4** to the CODE No.
- 9** Using timer time (▼) / (▲) buttons, set **0000** to Individual, **0001** to Master unit, and **0002** to sub unit.
- 10** Push **SET** button. (OK when display goes on.)
- 11** Push **TEST** button.  
Setup completes. (The status returns to the usual stop status.)

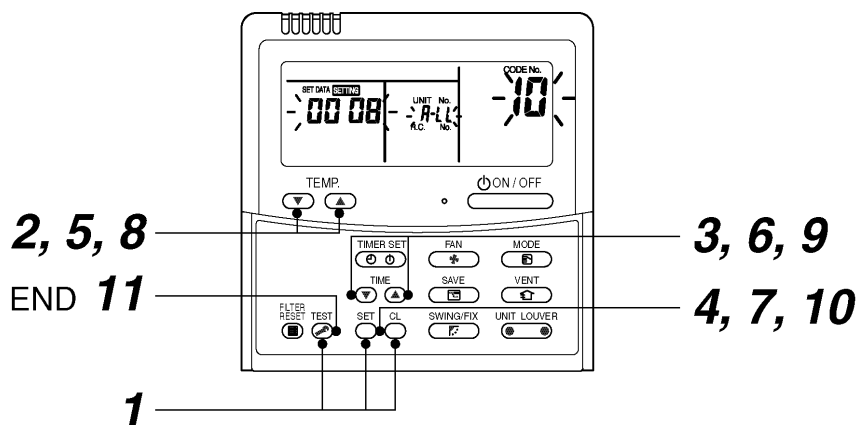

<Operation procedure>

**1 → 2 → 3 → 4 → 5 → 6 → 7 → 8 → 9 → 10 → 11** END

## 10-5. Confirmation of Indoor Unit No. Position

### 1. To know the indoor unit addresses though position of the indoor unit body is recognized

- In case of individual operation (Wired remote controller : indoor unit = 1 : 1)  
(Follow to the procedure during operation)

<Procedure>

- 1** Push **ON/OFF** button if the unit stops.
- 2** Push **UNIT LOUVER** button.

Unit No. **I-1** is displayed on LCD.

(It disappears after several seconds.)

The displayed unit No. indicate line address and indoor unit address.

(When other indoor units are connected to the identical remote controller (Group control unit), other unit numbers are also displayed every pushing **UNIT LOUVER** button.)

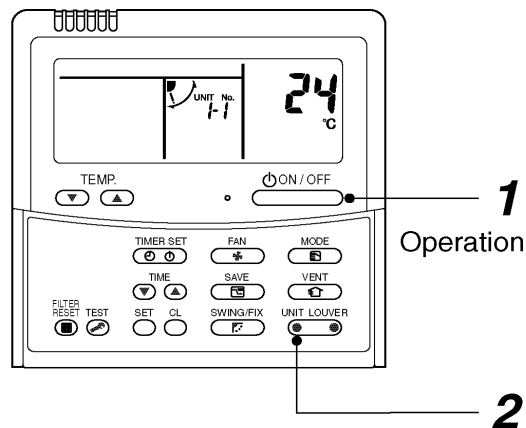

<Operation procedure>

**1 → 2** END

## 2. To know the position of indoor unit body by address

- To confirm the unit No. in the group control  
(Follow to the procedure during operation) (in this procedure, the indoor units in group control stop.)

### <Procedure>

The indoor unit numbers in the group control are successively displayed, and fan, louver, and drain pump of the corresponding indoor unit are turned on.

(Follow to the procedure during operation)

#### 1 Push and buttons simultaneously for 4 seconds or more.

- Unit No. *ALL* is displayed.
- Fans and louvers of all the indoor units in the group control operate.

#### 2 Every pushing button, the unit numbers in the group control are successively displayed.

- The unit No. displayed at the first time indicates the master unit address.
- Fan and louver of the selected indoor unit only operate.

#### 3 Push button to finish the procedure. All the indoor units in the group control stop.

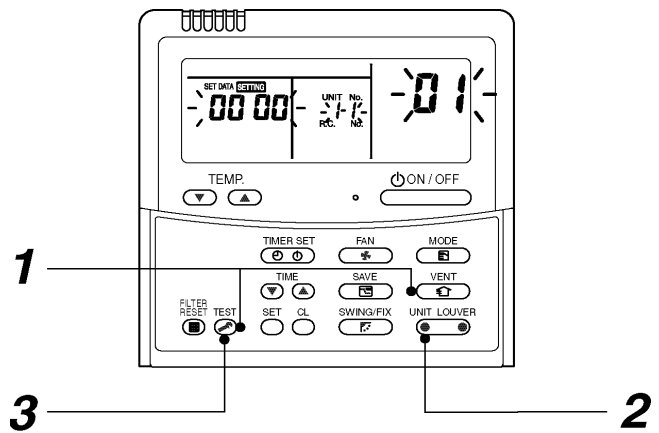

<Operation procedure>

**1 → 2 → 3** END

### <Maintenance/Check list>

Aiming in environmental preservation, it is strictly recommended to clean and maintain the indoor/outdoor units of the operating air conditioning system regularly to secure effective operation of the air conditioner.

It is also recommended to maintain the units once a year regularly when operating the air conditioner for a long time.

Check periodically signs of rust or scratches, etc. on coating of the outdoor units.

Repair the defective position or apply the rust resisting paint if necessary.

If an indoor unit operates for approx. 8 hours or more per day, usually it is necessary to clean the indoor/outdoor units once three months at least.

These cleaning and maintenance should be carried out by a qualified dealer.

Although the customer has to pay the charge for the maintenance, the life of the unit can be prolonged.

Failure to clean the indoor/outdoor units regularly will cause shortage of capacity, freezing, water leakage or trouble on the compressor.

| Part name                | Object |         | Contents of check   | Contents of maintenance  |
|--------------------------|--------|---------|---|--|
|                          | Indoor | Outdoor |   |  |
| Heat exchanger           | ○      | ○       | • Blocking with dust, damage check  | • Clean it when blocking is found.   |
| Fan motor                | ○      | ○       | • Audibility for sound  | • When abnormal sound is heard   |
| Filter                   | ○      | —       | • Visual check for dirt and breakage  | • Clean with water if dirty<br>• Replace if any breakage   |
| Fan                      | ○      | ○       | • Visual check for swing and balance<br>• Check adhesion of dust and external appearance. | • Replace fan when swinging or balance is remarkably poor.<br>• If a large dust adheres, clean it with brush or water. |
| Suction/Discharge grille | ○      | —       | • Visual check for dirt and scratch   | • Repair or replace it if deformation or damage is found.  |
| Drain pan                | ○      | —       | • Check blocking by dust and dirt of drain water.   | • Clean drain pan, Inclination check   |
| Face panel, Louver       | ○      | —       | • Check dirt and scratch.   | • Cleaning/Coating with repair painting  |
| External appearance      | —      | ○       | • Check rust and peeling of insulator<br>• Check peeling and floating of coating film     | • Coating with repair painting   |

# 11. REPLACEMENT OF THE SERVICE P.C. BOARD MCC-1630

## 1. Removing the P.C. board

- (1) Turn off the power supply of the outdoor unit and allow at least 3 minute for the capacitor to discharge. Confirm that the light of the LED (D800 to D805) fades away.
- (2) Remove all the connectors and fast-on terminals connected to the P.C.board.  
(Remove the connectors and fast-on terminals by pulling the connector body. Do not pull the wire).
- (3) Remove all the screws which secures the P.C.board.  
(These screws are to be reused after procedure.)
- (4) Remove the P.C.board from the BOX.

## 2. Setting the jumper wires

### Modelswitching (J800 to J804, J806)

Since this service P.C. board is available for several models, cut the jumper wires according to the following table. If they are not cut correctly, an error code "L10 or E04" appears on the remote controller and the operation of the air conditioner is disabled.

| Model name                | J 806 | J 800 | J 801 | J 802 | J 803 | J 804 |
|---------------------------|-------|-------|-------|-------|-------|-------|
| Factory setting (default) | -     | -     | -     | -     | -     | -     |
| RAV-SM1103AT-E1           | -     | Cut   | -     | -     | -     | -     |
| RAV-SM1403AT-E1           | -     | -     | Cut   | -     | -     | -     |

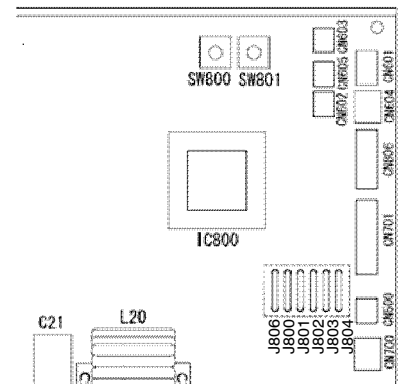

## 3. Installing the P.C. board

- (1) Apply thermal grease to the back (heat sink contacting side) of devices IC200 and IC300.
- (2) Reuse the insulating sheet. When a small amount of thermal grease is applied to the back of the insulating sheet, it adheres temporarily to the heat sink, which makes it easy to attach the insulating sheet.
- (3) Reuse the sub heat sink. Applying thermal grease to the surface and the back of the sub heat sink.
- (4) Insert the P.C. board, align the holes of the insulating sheets, semiconductor devices, and heat sinks, and then secure them with screws.  
Tighten the screw (A) at the end.
- (5) Connect the lead wires according to the wiring diagram stuck on the backside of the panel .

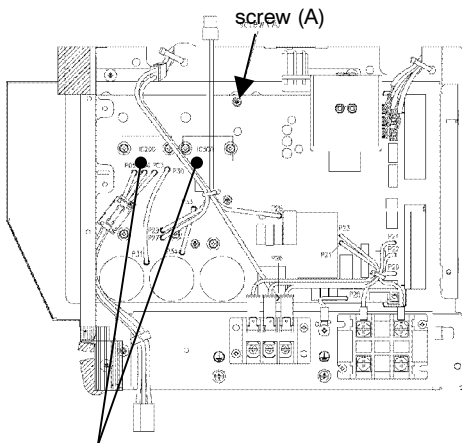

Apply thermal grease to the back (heat sink contacting side) of IC200 and IC300.

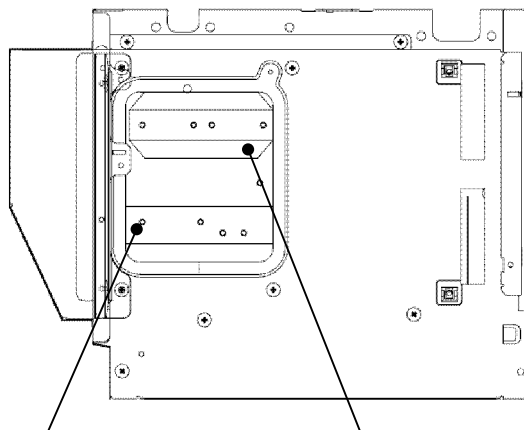

Reuse the insulating sheet. Applying thermal grease to the back of the insulating sheet makes it easy to attach the insulation sheet.

Reuse the sub heat sink. Applying thermal grease to the surface and the back of the sub heat sink.



## 12. HOW TO EXCHANGE COMPRESSOR

### 12-1. Exchanging Procedure of Compressor (Outline)

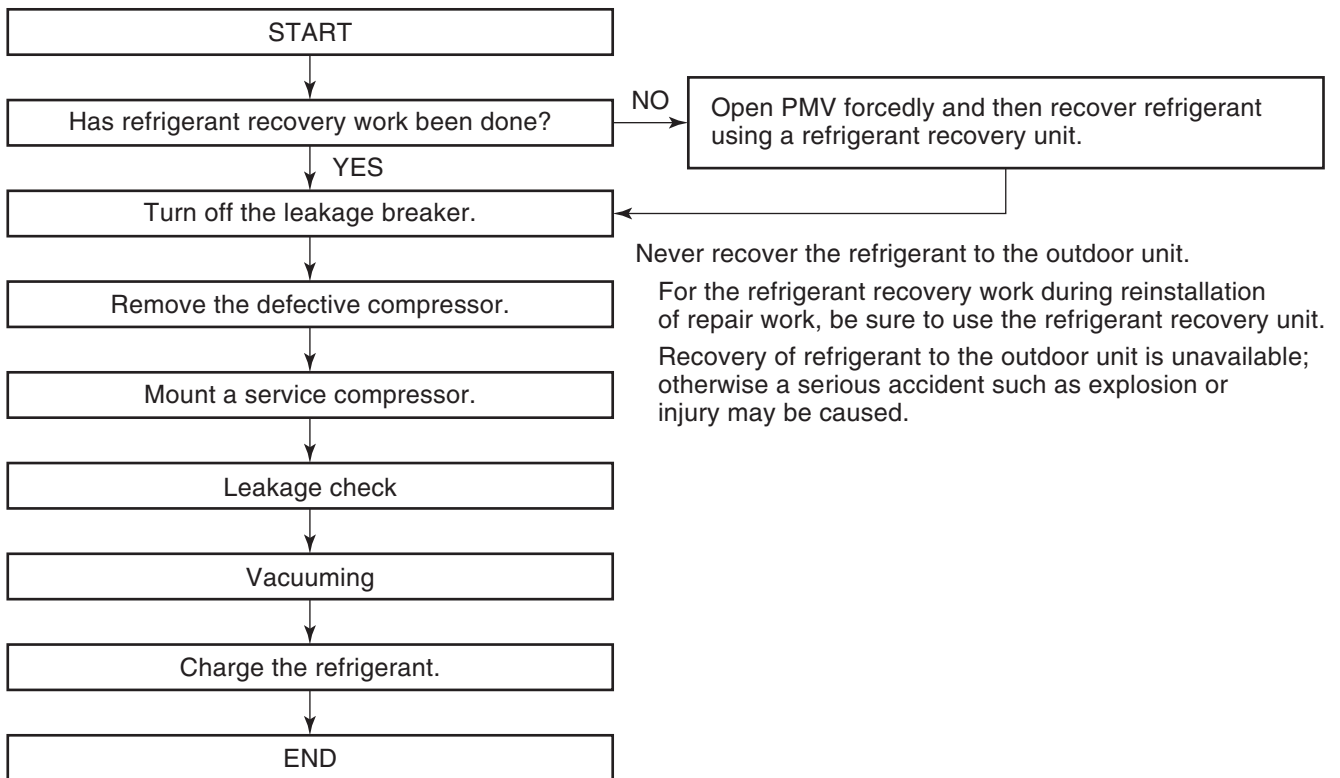



### 12-2. Exchange of Compressor

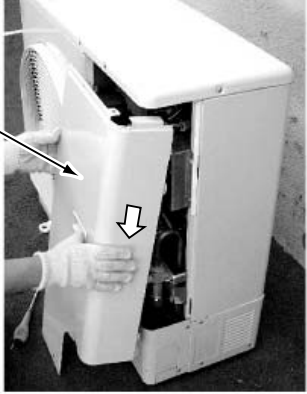
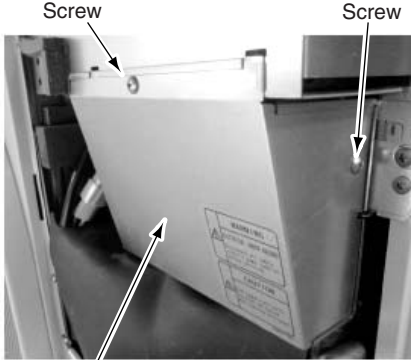

For exchange of compressors, refer to (11) Compressor in Section 13. **Detachments.**

# 13. DETACHMENTS

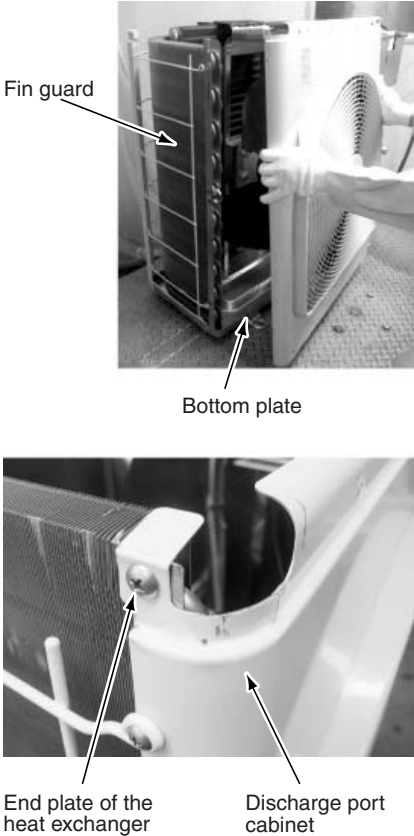
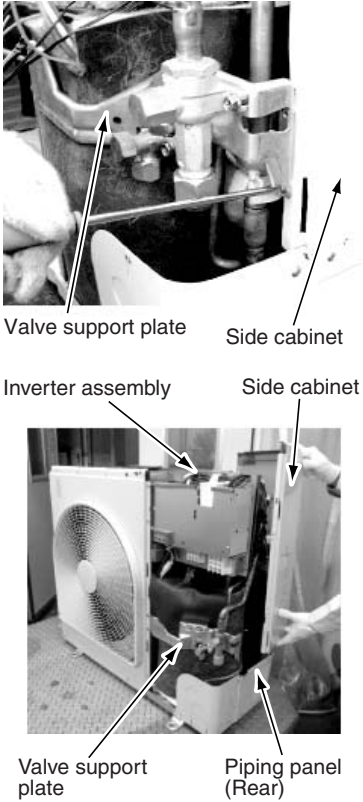

RAV-SM1103AT-E1, RAV-SM1403AT-E1

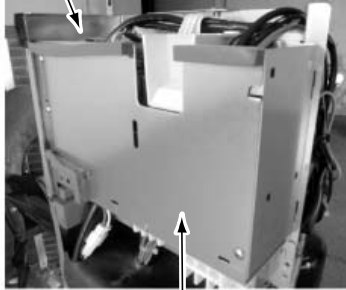
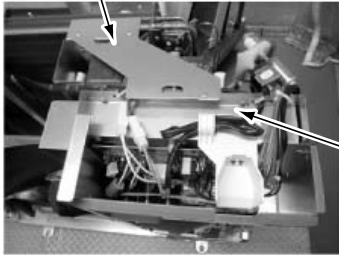
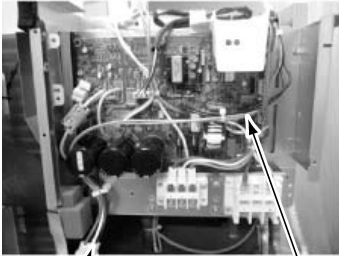
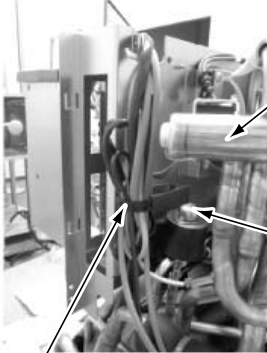
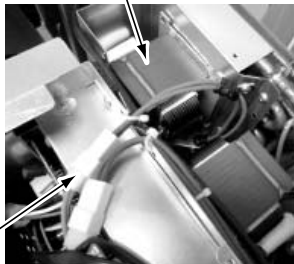
| No. | Part name        | Procedure   | Remarks  |
|-----|------------------|---|--|
| ①   | Common procedure | <hr/> <p style="text-align: center;"><b>⚠ CAUTION</b></p> <p>Never forget to put on the gloves at working time, otherwise an injury will be caused by the parts, etc.</p> <hr/> <p><b>1. Detachment</b></p> <ol style="list-style-type: none"> <li>1) Stop operation of the air conditioner, and also turn off switch of the breaker.</li> <li>2) Remove the front cabinet.<br/>(M4 (Hexagon) x 10, 3 pcs.) <ul style="list-style-type: none"> <li>• After taking off screws, remove the front cabinet by pulling it downward.</li> </ul> </li> <li>3) Remove the cover of the terminal block.<br/>(M4 x 8, 2 pcs.)</li> <li>4) Disconnect the connecting cables and power cord from the terminals and cord clamp.</li> <li>5) Remove the roof plate.<br/>(M4 (Hexagon) x 10, 6 pcs.)</li> </ol> <p><b>2. Attachment</b></p> <ol style="list-style-type: none"> <li>1) Attach the roof plate.<br/>(M4 (Hexagon) x 10, 6 pcs.)</li> <li>2) Connect the connecting cable and power cord at the terminal and fix them with cord clamp.</li> <li>3) Attach the cover of the terminal block.<br/>(M4 x 8, 2 pcs.)</li> </ol> <hr/> <p style="text-align: center;"><b>⚠ CAUTION</b></p> <p>Using bundling band sold at a market, be sure to fix the power cables and indoor/outdoor connecting cables along the inter-unit cable so that they do not come to contact with the compressor, valves and cables at gas side, and the discharge pipe.</p> <hr/> <ol style="list-style-type: none"> <li>4) Attach the front cabinet.<br/>(M4 (Hexagon) x 10, 3 pcs.)</li> </ol> |  <p>Front cabinet</p>  <p>Screw</p> <p>Screw</p> <p>Cover of the terminal block</p>  <p>Roof plate</p> |

| No. | Part name              | Procedure   | Remarks   |
|-----|------------------------|---|---|
| ②   | Discharge port cabinet | <p><b>1. Detachment</b></p> <ol style="list-style-type: none"> <li>1) Perform work of item 1 of ①.</li> <li>2) Remove screws (M4 x 8, 3 pcs.) of discharge port cabinet for partition plate.</li> <li>3) Remove screws (M4 (Hexagon) x 10, 2 pcs.) of discharge port cabinet for the bottom plate.</li> <li>4) Remove screw (M4 x 8, 1 pc.) of discharge port cabinet for the end plate of the heat exchanger.</li> <li>5) Remove the screws (M4 x 8, 2pcs) of discharge port cabinet and motor base.</li> <li>6) Remove screws (M4 (Hexagon) x 10, 2 pcs.) of discharge port cabinet for the fin guard.</li> </ol> <p><b>2. Attachment</b></p> <ol style="list-style-type: none"> <li>1) Put the upper left side of the discharge port cabinet on the end plate of the heat exchanger, and then fix it with screw. (M4 x 8, 1 pc.)</li> <li>2) Attach the removed screws to the original positions.</li> </ol> |  <p>The top photograph shows a person's hands lifting the discharge port cabinet away from the main unit. Arrows point to the 'Fin guard' on the left and the 'Bottom plate' at the base of the cabinet. The bottom photograph shows the cabinet being re-attached to the 'End plate of the heat exchanger' on the left side of the unit. An arrow points to the 'Discharge port cabinet' on the right.</p>                                     |
| ③   | Side cabinet           | <ol style="list-style-type: none"> <li>1) Perform work of item 1 of ①.</li> <li>2) Remove screws fixing the inverter and the side cabinet. (M4 x 8, 2 pcs.)</li> <li>3) Remove screws of the side cabinet and the valve support plate. (M4 x 8, 2 pcs.)</li> <li>4) Remove screw of the side cabinet and the piping panel (Rear). (M4 (Hexagon) x 10, 1 pc.)</li> <li>5) Remove screw of the side cabinet and the bottom plate. (M4 (Hexagon) x 10, 1 pc.)</li> <li>6) Remove screw of the side cabinet and the fin guard (Heat exchanger). (M4 (Hexagon) x 10, 2 pcs.)</li> </ol>  |  <p>The top photograph shows the side cabinet being lifted away from the unit. Arrows point to the 'Valve support plate' on the left and the 'Side cabinet' on the right. The bottom photograph shows the side cabinet being removed from the unit. Arrows point to the 'Inverter assembly' on the left, the 'Side cabinet' on the right, the 'Valve support plate' at the bottom left, and the 'Piping panel (Rear)' at the bottom right.</p> |

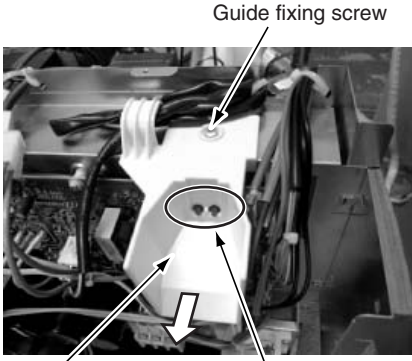
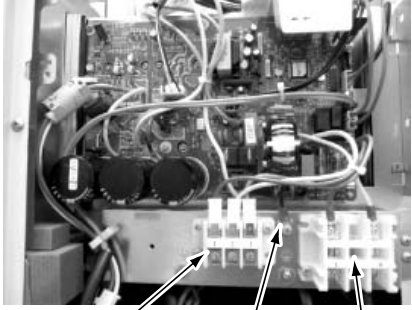
| No. | Part name         | Procedure   | Remarks  |
|-----|-------------------|---|--|
| ④   | Inverter assembly | <p>1) Perform works of 1 of ①, 1 of ②, and ③.</p> <p>2) Remove the front cover.<br/>(M4 x 8, 3 pcs.)</p> <p>3) Remove the inverter fixing plate.<br/>(M4 x 8, 3 pcs.)</p> <p>4) Remove connectors connected to other parts from P.C. board.</p> <p>CN601: TD sensor (3P, White)<br/>           CN602: TO sensor (2P, Yellow)<br/>           CN603: TE sensor (2P, White)<br/>           CN604: TS sensor (3P, White)<br/>           CN605: TL sensor (2P, White)<br/>           CN300: Outdoor fan (3P, White)<br/>           CN500: Case thermo (2P, Blue)<br/>           CN700: 4-way valve coil (3P, Yellow)<br/>           CN701: PMV coil (6P, White)<br/>           CN501: High-pressure SW (3P, Green)</p> <p>* Unlock the locks of the housing part and then remove the connectors.</p> <p>5) Remove the compressor lead connectors.</p> <p>6) Remove the relay connector of the reactor lead attached to the partition plate side.</p> <p>7) Cut bunding band which fixed the various lead wires to the inverter assembly.</p> <p>8) Pull up upward the hook for the partition plate (Back left) so as to remove it.</p> <p>* Caution for attachment of the inverter assembly<br/>           When attaching the inverter assembly to the partition plate surely attach the hook for the partition plate (Back left).</p> |  <p>Inverter assembly</p> <p>Front cover</p>  <p>Inverter fixing plate</p> <p>Inverter assembly</p>  <p>Compressor lead connector</p> <p>Case thermo lead</p>  <p>4way valve</p> <p>PMV</p> <p>Wire clamp</p> <p>There is a hook for the partition board at the rear side.</p>  <p>Reactor (Partition plate side)</p> <p>Relay connector</p>  |

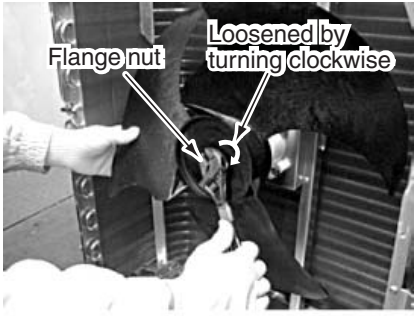

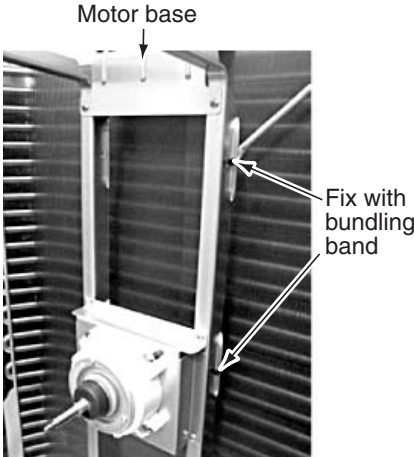
| No. | Part name                       | Procedure  | Remarks  |
|-----|---------------------------------|--|--|
| ⑤   | Outdoor unit control P.C. board | <ol style="list-style-type: none"> <li>1) Perform works of 1 of ①, 2) of ④.</li> <li>2) Remove the guide. (M4 x 8, 1 pc.)</li> <li>3) Remove connectors and lead wires which are connected to the other parts from the cycle P.C. board.               <ol style="list-style-type: none"> <li>1. Connectors (On P.C. board)                   <ul style="list-style-type: none"> <li>CN601: TD sensor (3P, White)</li> <li>CN602: TO sensor (2P, Yellow)</li> <li>CN603: TE sensor (2P, White)</li> <li>CN604: TS sensor (3P, White)</li> <li>CN605: TL sensor (2P, White)</li> <li>CN300: Outdoor fan (3P, White)</li> <li>CN500: Case thermo (2P, Blue)</li> <li>CN700: 4-way valve (3P, Yellow)</li> <li>CN701: PMV coil (6P, White)</li> <li>CN501: High-pressure SW (3P, Green)</li> </ul> </li> <li>2. Connectors (Relay connection)                   <ul style="list-style-type: none"> <li>Reactor lead wire (White)</li> <li>Reactor lead wire (Gray)</li> <li>Compressor lead wire (Red, White, Black)</li> </ul> </li> </ol> </li> <li>* Unlock the locks of the housing part and then remove the connectors.</li> <li>4) Remove the Faston terminal (White (3)) on the indoor/outdoor connection terminal block.</li> <li>5) Remove the earth wire (Black) which is fixed to the terminal fixed plate with screw (1 pc.).</li> <li>6) Remove the power supply connection lead wire from the power supply terminal block. (L (Red), N (White))</li> <li>7) Remove screws (4 pcs.) which fixed the heat sink and IPM and screws (3 pcs.) which fixed the heat sink and rectifier.</li> <li>8) Remove screws which fixed P.C. board and remove board fixed claws (2 positions) to remove P.C. board.</li> <li>9) Attach a new P.C. board.</li> </ol> |  <p>Guide fixing screw</p> <p>Guide</p> <p>To remove the guide, pull it toward arrow direction so that the force is not applied to this switch.</p>  <p>Indoor/outdoor connection terminal block</p> <p>Earth wire</p> <p>Power supply terminal block</p> |

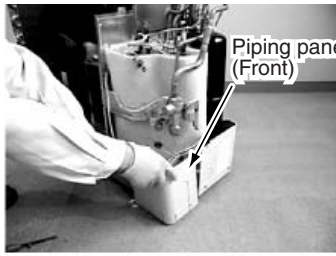
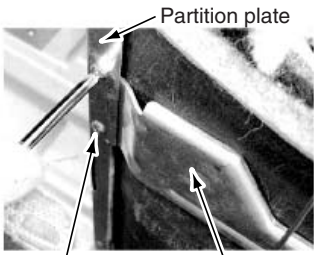
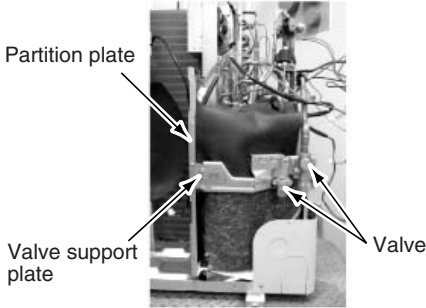
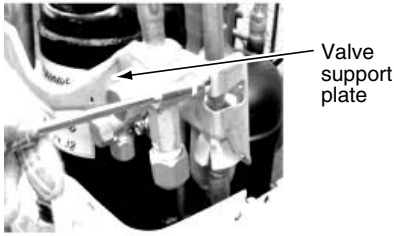
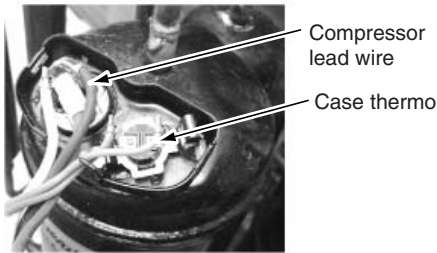
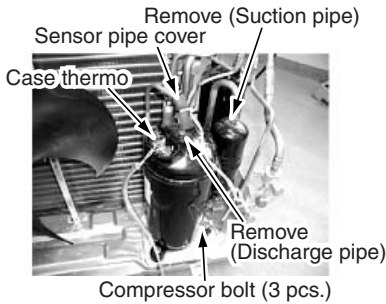
| No. | Part name | Procedure   | Remarks   |
|-----|-----------|---|---|
| ⑥   | Fan motor | <p>1) Perform works of items 1 of ①, 1 of ②,</p> <p>2) Remove the flange nut fixing the fan motor and the propeller fan.</p> <ul style="list-style-type: none"> <li>Loosen the flange nut by turning clockwise. (To tighten the flange nut, turn it counterclockwise.)</li> </ul> <p>3) Remove the propeller fan.</p> <p>4) Remove the lead wire from the hook fixing the fan motor lead wires on the motor base. (Three positions)</p> <p>5) Disconnect the connector for fan motor from the inverter.</p> <p>6) Remove the fixing screws (4 pcs.) while holding by hands so that the fan motor does not fall.</p> <p><b>*(Note)</b></p> <ul style="list-style-type: none"> <li>Tighten the flange nut with torque 4.9N•m (50kgf/cm).</li> <li>Be careful that the reactor does not come to contact with the fan motor lead at the rear side of the inverter assembly.</li> </ul> <hr/> <p style="text-align: center;"><b>⚠ CAUTION</b></p> <p>Using a bundling band on the market, be sure to fix the fan motor lead wire to the motor base so that it does not come to contact with the propeller fan.</p> <hr/> |    |

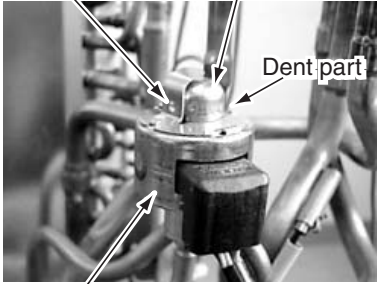
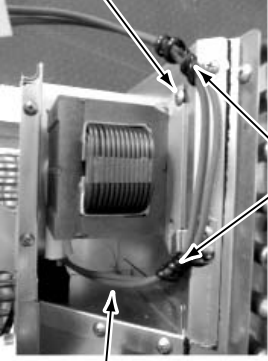
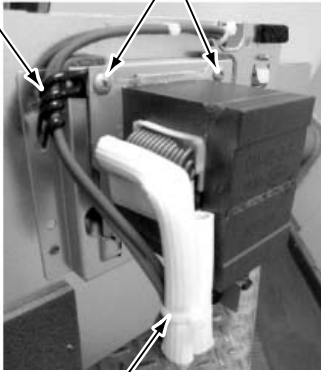
| No. | Part name  | Procedure  | Remarks  |
|-----|------------|--|--|
| ⑦   | Compressor | <ol style="list-style-type: none"> <li>1) Evacuate refrigerant gas.</li> <li>2) Perform works of items 1 of ①, 1 of ②, ③ and ④.</li> <li>3) Remove screws which fixes the piping panel (Front) and the bottom plate.<br/>(M4 (Hexagon) x 10, 2 pcs.)</li> <li>4) Remove screw of the piping panel (Front) and the piping panel (Rear).<br/>(M4 (Hexagon) x 10, 1 pc.)</li> <li>5) Remove screws fixing the partition plate to the valve support plate. (M4 x 8, 2 pcs.)</li> <li>6) Remove the valve support plate.<br/>(M6 x 4 pcs.)</li> <li>7) Remove screws of the partition plate and the bottom plate. (M4 x 8, 1 pc.)</li> <li>8) Remove screws of the partition plate and the heat exchanger (M4 x 8, 2 pcs.)</li> <li>9) Remove the noise-insulator.</li> <li>10) Remove the terminal covers of the compressor, and disconnect lead wires of the compressor and the compressor thermo assembly from the terminal.</li> <li>11) Remove pipes connected to the compressor with a burner.</li> </ol> <hr/> <p style="text-align: center;"><b>⚠ CAUTION</b></p> <p>Pay attention to that flame does not involve 4-way valve or PMV.<br/>(If doing so, a malfunction may be caused.)</p> <hr/> <ol style="list-style-type: none"> <li>12) Pull the refrigerating cycle upward.</li> <li>13) Remove bolt fixing the compressor on the bottom plate. (3 pcs.)</li> <li>14) Pull the compressor toward you.</li> </ol> <hr/> <p style="text-align: center;"><b>⚠ CAUTION</b></p> <p>When reconnecting the lead wires to the compressor terminals after replacement of the compressor, be sure to caulk the Faston terminal without loosening.</p> <hr/> |  <p>Piping panel (Front)</p>  <p>Partition plate<br/>Screw<br/>Valve support plate</p>  <p>Partition plate<br/>Valve support plate<br/>Valve</p>  <p>Valve support plate</p>  <p>Compressor lead wire<br/>Case thermo</p>  <p>Remove (Suction pipe)<br/>Sensor pipe cover<br/>Case thermo<br/>Remove (Discharge pipe)<br/>Compressor bolt (3 pcs.)</p> |

| No. | Part name                         | Procedure   | Remarks   |
|-----|-----------------------------------|---|---|
| ⑧   | Pulse Modulating Valve (PMV) coil | <p><b>1. Detachment</b></p> <ol style="list-style-type: none"> <li>1) Perform works of items 1 of ① and ③.</li> <li>2) Remove the coil from PMV body while pulling it upward.</li> </ol> <p><b>2. Attachment</b></p> <ol style="list-style-type: none"> <li>1) Match the positioning extrusion of the coil surely to the concavity of PMV body to fix it.</li> </ol>  | <p>Positioning projection</p> <p>PMV main unit</p> <p>Dent part</p>  <p>PMV coil</p>   |
| ⑨   | Reactor                           | <p><b>1. Detachment</b></p> <ol style="list-style-type: none"> <li>1) Perform works of items of 1 of ① and 3) of ④.</li> <li>2) Remove the reactor lead wire from the cord clamp which fixes lead wires.</li> <li>3) Remove screw which fixes the reactor.<br/>Partition plate side: M4 x 8, 1 pc.<br/>Inverter rear side: M4 x 8, 2 pcs.</li> <li>4) Pull off the reactor upward to remove the reactor.</li> </ol> <hr/> <p style="text-align: center;"><b>⚠ CAUTION</b></p> <p>As the reactor body becomes high temperature in this Model, the lead wires are fixed with the cord clamp so that the reactor lead does not come to contact with the main body. When replacing the reactor or returning the inverter assembly to the original position after removing it, be sure to fix the lead wires with the cord clamp so that the main body does not come to contact to the lead.</p> <hr/> | <p>Screw</p> <p>Cord clamp</p>  <p>Do not pull the lead wire strongly too much.</p> <p>Cord clamp</p> <p>Screw</p>  <p>Bind the lead wires with bundling band.</p> |

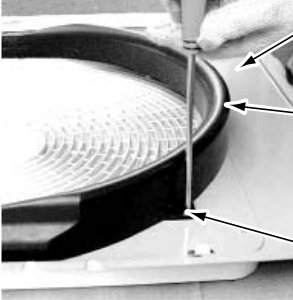

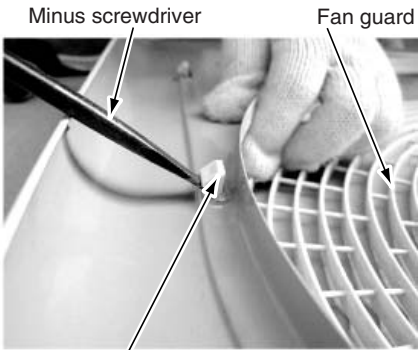
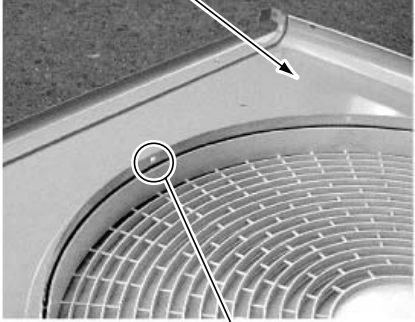
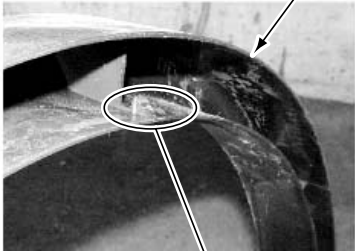
| No. | Part name | Procedure  | Remarks   |
|-----|-----------|--|---|
| ⑩   | Fan guard | <p><b>1. Detachment</b></p> <p>1) Perform works of items 1 of ① and ②.</p> <p>2) Remove the discharge port cabinet, and put it down so that the fan guard side directs downward.</p> <div data-bbox="416 412 948 530" style="border: 1px solid black; padding: 5px; margin: 10px 0;"> <p><b>Perform work on a corrugated cardboard, cloth, etc. to prevent flaw to the product.</b></p> </div> <p>3) Remove screws fixing the bell mouth. (M4 x 8, 2 pcs.)</p> <p>4) Remove the bell mouth.</p> <p>5) Remove the hooking claws by pushing with minus screwdriver along with the arrow mark as shown in right figure.</p> <p><b>2. Attachment</b></p> <p>1) Insert claw of the fan guard in hole of discharge port cabinet. Push the hooking claws (5 positions) with hands and fix the claws.</p> <div data-bbox="416 958 948 1111" style="border: 1px solid black; padding: 5px; margin: 10px 0;"> <p><b>After all the attachment works are completed, check that all the hooking claws are fixed to the specified positions.</b></p> </div> <p>2) Mount the bell mouth by hooking three claws at upper side of the bell mouth in the slits on the discharge port cabinet.</p> <p>3) After attachment, fix the bell mouth with screws. (M4 x 8, 2 pcs.)</p> |  <p>Discharge port cabinet</p> <p>Bell mouth</p> <p>Remove two screws</p>  <p>Bell mouth</p> <p>Discharge port cabinet</p>  <p>Minus screwdriver</p> <p>Fan guard</p> <p>Hooking claw</p>  <p>Discharge port cabinet</p> <p>Slit (3 positions)</p>  <p>Bell mouth</p> <p>Claw (3 positions)</p> |

# 14. EXPLODED VIEWS AND PARTS LIST

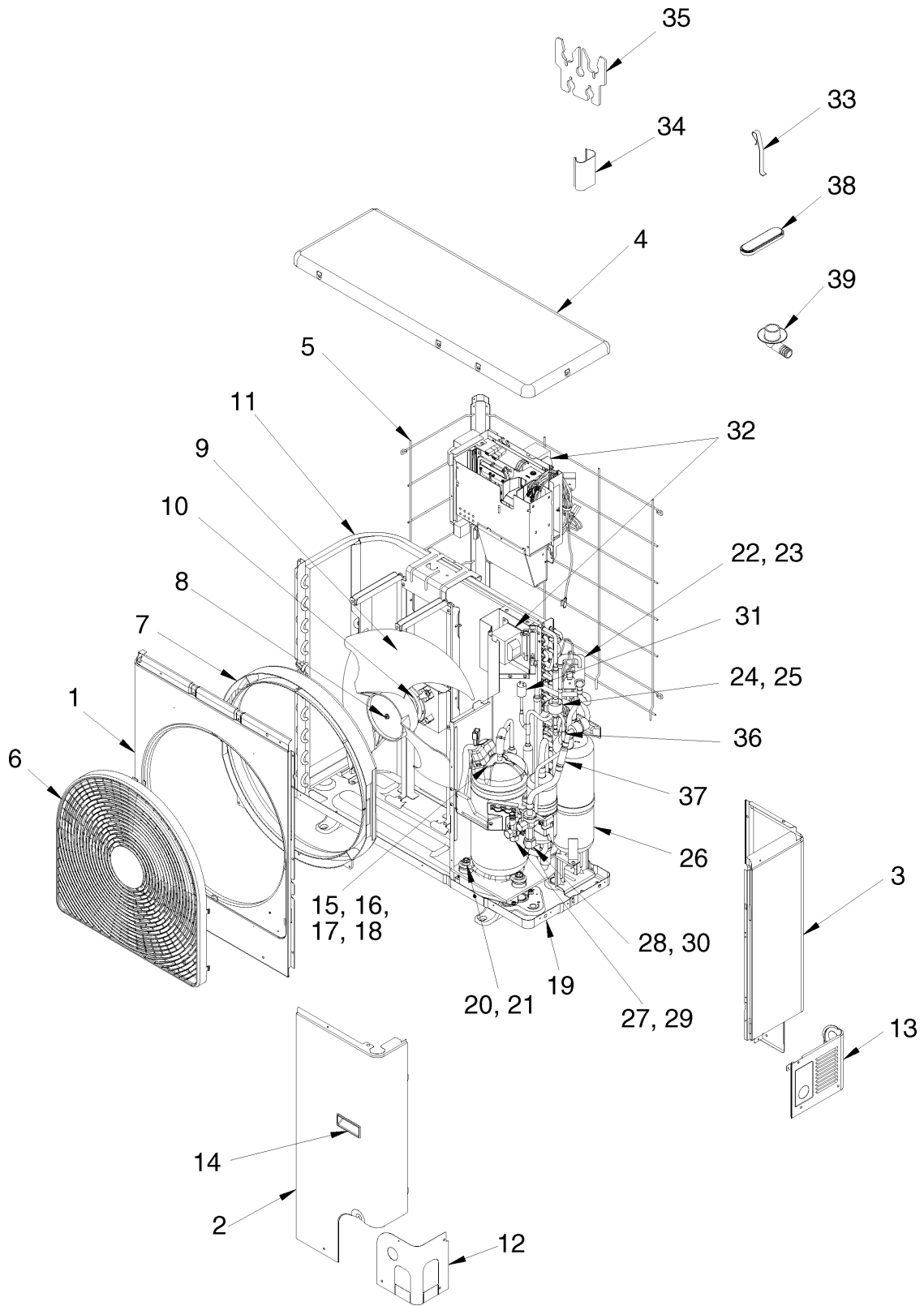

| Location No. | Part No. | Description                     | Model Name RAV- |             |
|--------------|----------|---------------------------------|-----------------|-------------|
|              |          |                                 | SM1103AT-E1     | SM1403AT-E1 |
| 1            | 43005727 | CABINET, AIR, OUTLET            | 1               | 1           |
| 2            | 43100350 | CABINET, FRONT, ASSY, ROHS      | 1               | 1           |
| 3            | 43100349 | CABINET, SIDE, ASSY, ROHS       | 1               | 1           |
| 4            | 4310A009 | PLATE, ROOF                     | 1               | 1           |
| 5            | 4301V071 | GUARD, FIN                      | 1               | 1           |
| 6            | 43191651 | GUARD, FAN                      | 1               | 1           |
| 7            | 43122065 | BELL MOUTH                      | 1               | 1           |
| 8            | 43F47669 | NUT, FLANGE                     | 1               | 1           |
| 9            | 43120224 | FAN, PROPELLER, PE492           | 1               | 1           |
| 10           | 4312C090 | MOTOR, FAN, WDF-340-A100-1      | 1               | 1           |
| 11           | 4314G308 | CONDENSOR ASSY                  | 1               | 1           |
| 12           | 43100347 | PANEL, FRONT, PIPING, ROHS      | 1               | 1           |
| 13           | 43100345 | PANEL, BACK, PIPING, ROHS       | 1               | 1           |
| 14           | 43119390 | HANGER                          | 2               | 2           |
| 15           | 43141519 | COMPRESSOR, DA422A3F-12M        | 1               | 1           |
| 16           | 43F50407 | THERMOSTAT,BIMETAL              | 1               | 1           |
| 17           | 43F63317 | HOLDER,THERMOSTAT               | 1               | 1           |
| 18           | 43160625 | LEAD ASSY, COMPRESSOR           | 1               | 1           |
| 19           | 43100343 | BASE ASS'Y, ROHS                | 1               | 1           |
| 20           | 43197183 | BOLT, COMPRESSOR                | 3               | 3           |
| 21           | 43149324 | RUBBER, CUSHION                 | 3               | 3           |
| 22           | 43F46500 | VALVE, 4WAY, STF-H0218          | 1               | 1           |
| 23           | 43146749 | COIL, SOLENOID, STF-H01AJ1949A1 | 1               | 1           |
| 24           | 43146634 | VALVE, PULSE, MODULATING        | 1               | 1           |
| 25           | 43046494 | COIL, PMV, ASSY                 | 1               | 1           |
| 26           | 43148170 | ACCUMULATOR ASS'Y               | 1               | 1           |
| 27           | 43146686 | VALVE, PACKED, 9.52             | 1               | 1           |
| 28           | 43146724 | VALVE, BALL, SBV-JA5GTC-1, ROHS | 1               | 1           |
| 29           | 43F47401 | BONNET, 3/8 IN                  | 1               | 1           |
| 30           | 43194029 | BONNET, 5/8 IN                  | 1               | 1           |
| 31           | 43151301 | SWITCH, PRESSURE                | 1               | 1           |
| 32           | 43158231 | REACTOR                         | 2               | 2           |
| 33           | 43F19904 | HOLDER, SENSOR (TS)             | 2               | 2           |
| 34           | 43F63188 | HOLDER, TC SENSOR               | 1               | 1           |
| 35           | 43063332 | HOLDER, SENSOR                  | 1               | 1           |
| 36           | 4314Q068 | STRAINER, ROHS                  | 1               | 1           |
| 37           | 4314Q033 | STRAINER, ROHS                  | 1               | 1           |
| 38           | 43F89160 | CAP, WATERPROOF                 | 5               | 5           |
| 39           | 43F32441 | NIPPLE, DRAIN                   | 1               | 1           |

# Inverter assembly

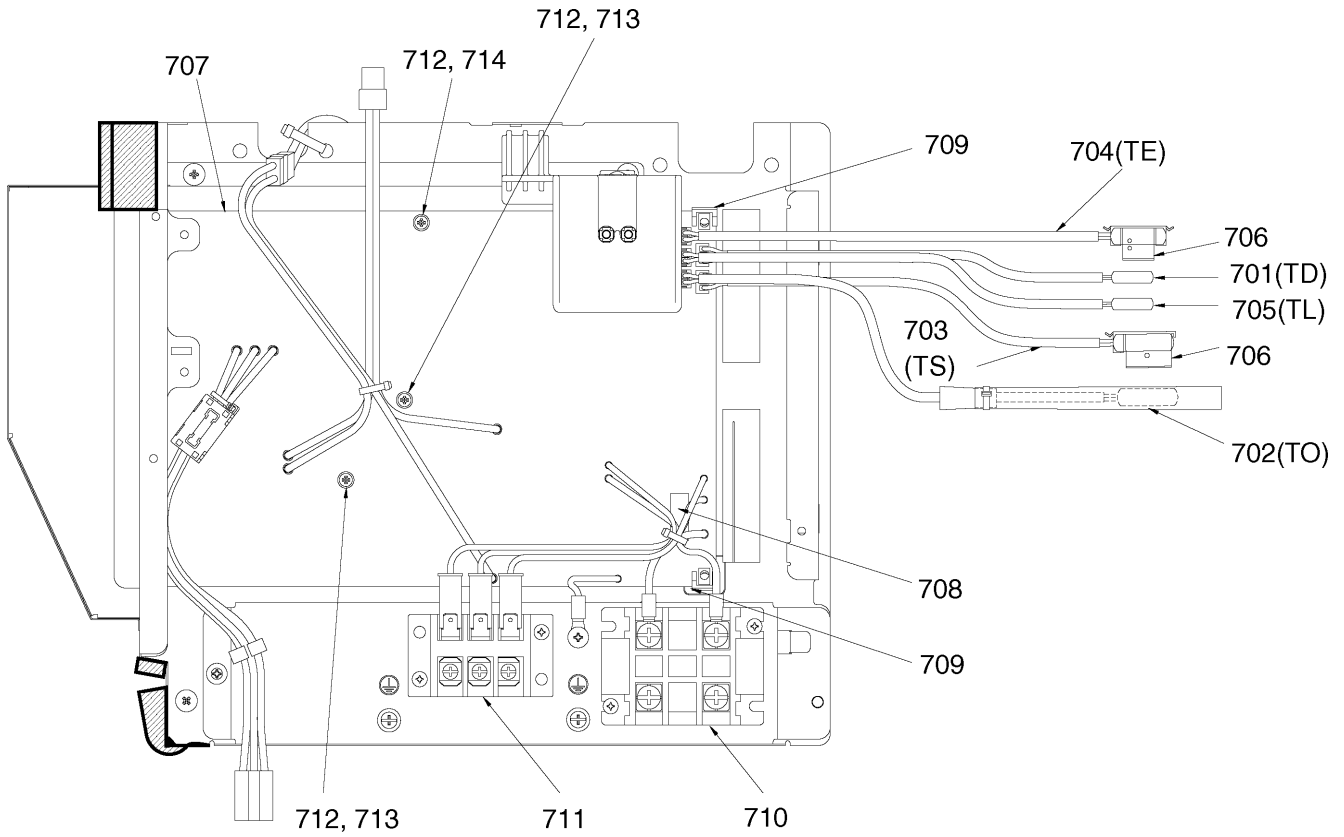

| Location No. | Part No. | Description             | Model Name RAV- |             |
|--------------|----------|-------------------------|-----------------|-------------|
|              |          |                         | SM1103AT-E1     | SM1403AT-E1 |
| 701          | 43150351 | SENSOR, TD              | 1               | 1           |
| 702          | 43150350 | SENSOR ASSY             | 1               | 1           |
| 703          | 43150353 | SENSOR                  | 1               | 1           |
| 704          | 43150352 | SENSOR                  | 1               | 1           |
| 705          | 43150355 | SENSOR                  | 1               | 1           |
| 706          | 43F63338 | HOLDER, ASSY (SENSOR)   | 1               | 1           |
| 707          | 4316V496 | PC BOARD ASSY, MCC-1630 | 1               | 1           |
| 708          | 43160589 | FUSE                    | 1               | 1           |
| 709          | 43F63248 | SUPPORTER, ASSY         | 1               | 1           |
| 710          | 43160567 | TERMINAL BLOCK, 3P, 30A | 1               | 1           |
| 711          | 43160565 | TERMINAL BLOCK, 3P, 20A | 1               | 1           |
| 712          | 43163059 | SPACER, BUSH            | 3               | 3           |
| 713          | 43163066 | SPACER, COLLAR          | 2               | 2           |
| 714          | 43163060 | SPACER, COLLAR          | 1               | 1           |

# **TOSHIBA CARRIER CORPORATION**

23-17, TAKANAWA 3 CHOME, MINATOKU, TOKYO, 108-8580, JAPAN

Copyright © 1999 to 2012 TOSHIBA CARRIER CORPORATION, ALL Rights Reserved.

## Free Manuals Download Website

<http://myh66.com>

<http://usermanuals.us>

<http://www.somanuals.com>

<http://www.4manuals.cc>

<http://www.manual-lib.com>

<http://www.404manual.com>

<http://www.luxmanual.com>

<http://aubethermostatmanual.com>

Golf course search by state

<http://golfingnear.com>

Email search by domain

<http://emailbydomain.com>

Auto manuals search

<http://auto.somanuals.com>

TV manuals search

<http://tv.somanuals.com>