

Stratagy[®]

Voice Processing Systems

**Stratagy iES32, ES4, ES80,
ES96, ES96R**

User Guide

Publication Information

Toshiba America Information Systems, Inc., Telecommunication Systems Division, reserves the right, without prior notice, to revise this information publication for any reason, including, but not limited to, utilization of new advances in the state of technical arts or to simply change the design of this document.

Further, Toshiba America Information Systems, Inc., Telecommunication Systems Division, also reserves the right, without prior notice, to make such changes in equipment design or components as engineering or manufacturing methods may warrant.

STG-UG-ESALL-VB
4016230

Version B, January 2003

© Copyright 2003

Toshiba America Information Systems, Inc. Telecommunication Systems Division

All rights reserved. No part of this manual, covered by the copyrights hereon, may be reproduced in any form or by any means—graphic, electronic, or mechanical, including recording, taping, photocopying, or information retrieval systems—without express written permission of the publisher of this material.

Strata is a registered trademark of Toshiba Corporation.

Strategy and Perception are registered trademarks of Toshiba America Information Systems, Inc.

Trademarks, registered trademarks, and service marks are the property of their respective owners.

TOSHIBA AMERICA INFORMATION SYSTEMS, INC. ("TAIS")

Telecommunication Systems Division License Agreement

IMPORTANT: THIS LICENSE AGREEMENT ("AGREEMENT") IS A LEGAL AGREEMENT BETWEEN YOU ("YOU") AND TAIS. CAREFULLY READ THIS LICENSE AGREEMENT. USE OF ANY SOFTWARE OR ANY RELATED INFORMATION (COLLECTIVELY, "SOFTWARE") INSTALLED ON OR SHIPPED WITH A TAIS TELECOMMUNICATION SYSTEM PRODUCT OR OTHERWISE MADE AVAILABLE TO YOU BY TAIS IN WHATEVER FORM OR MEDIA, WILL CONSTITUTE YOUR ACCEPTANCE OF THESE TERMS, UNLESS SEPARATE TERMS ARE PROVIDED BY THE SOFTWARE SUPPLIER. IF YOU DO NOT AGREE WITH THE TERMS OF THIS LICENSE AGREEMENT, DO NOT INSTALL, COPY OR USE THE SOFTWARE AND PROMPTLY RETURN IT TO THE LOCATION FROM WHICH YOU OBTAINED IT IN ACCORDANCE WITH APPLICABLE RETURN POLICIES. EXCEPT AS OTHERWISE AUTHORIZED IN WRITING BY TAIS, THIS SOFTWARE IS LICENSED FOR DISTRIBUTION ONLY TO END-USERS PURSUANT TO THIS LICENSE AGREEMENT.

1. License Grant. The Software is not sold; it is licensed upon payment of applicable charges. TAIS grants to you a personal, non-transferable and non-exclusive right to use the copy of the Software provided under this License Agreement. You agree you will not copy the Software except as necessary to use it on one TAIS system at a time at one location. Modifying, translating, renting, copying, distributing, transferring or assigning all or part of the Software, or any rights granted hereunder, to any other persons and removing any proprietary notices, labels or marks from the Software is strictly prohibited; You agree violation of such restrictions will cause irreparable harm to TAIS and provide grounds for injunctive relief, without notice, against You or any other person in possession of the Software. You and any other person whose possession of the software violates this License Agreement shall promptly surrender possession of the Software to TAIS, upon demand. Furthermore, you hereby agree not to create derivative works based on the Software. TAIS reserves the right to terminate this license and to immediately repossess the software in the event that You or any other person violates this License Agreement.
2. Intellectual Property. You acknowledge that no title to the intellectual property in the Software is transferred to you. You further acknowledge that title and full ownership rights to the Software will remain the exclusive property of TAIS and/or its suppliers, and you will not acquire any rights to the Software, except the license expressly set forth above. You will not remove or change any proprietary notices contained in or on the Software. The Software is protected under US patent, copyright, trade secret, and/or other proprietary laws, as well as international treaties. Any transfer, use, or copying of the software in violation of the License Agreement constitutes copyright infringement. You are hereby on notice that any transfer, use, or copying of the Software in violation of this License Agreement constitutes a willful infringement of copyright.
3. No Reverse Engineering. You agree that you will not attempt, and if you employ employees or engage contractors, you will use your best efforts to prevent your employees and contractors from attempting to reverse compile, reverse engineer, modify, translate or disassemble the Software in whole or in part. Any failure to comply with the above or any other terms and conditions contained herein will result in the automatic termination of this license and the reversion of the rights granted hereunder back to TAIS.
4. Limited Warranty. THE SOFTWARE IS PROVIDED "AS IS" WITHOUT WARRANTY OF ANY KIND, TO THE MAXIMUM EXTENT PERMITTED BY APPLICABLE LAW, TAIS AND ITS SUPPLIERS DISCLAIM ALL WARRANTIES WITH REGARD TO THE SOFTWARE, EITHER EXPRESS OR IMPLIED, INCLUDING, BUT NOT LIMITED TO, THE WARRANTY OF NON-INFRINGEMENT OF THIRD PARTY RIGHTS, THE WARRANTY OF YEAR 2000 COMPLIANCE, AND THE IMPLIED WARRANTIES OF MERCHANTABILITY AND FITNESS FOR A PARTICULAR PURPOSE. THE ENTIRE RISK AS TO THE QUALITY AND PERFORMANCE OF THE SOFTWARE IS WITH YOU. NEITHER TAIS NOR ITS SUPPLIERS WARRANT THAT THE FUNCTIONS CONTAINED IN THE SOFTWARE WILL MEET YOUR REQUIREMENTS OR THAT THE OPERATION OF THE SOFTWARE WILL BE UNINTERRUPTED OR ERROR-FREE. HOWEVER, TAIS WARRANTS THAT ANY MEDIA ON WHICH THE SOFTWARE IS FURNISHED IS FREE FROM DEFECTS IN MATERIAL AND WORKMANSHIP UNDER NORMAL USE FOR A PERIOD OF NINETY (90) DAYS FROM THE DATE OF DELIVERY TO YOU.
5. Limitation Of Liability. TAIS' ENTIRE LIABILITY AND YOUR SOLE AND EXCLUSIVE REMEDY UNDER THIS LICENSE AGREEMENT SHALL BE AT TAIS' OPTION REPLACEMENT OF THE MEDIA OR REFUND OF THE PRICE PAID, TO THE MAXIMUM EXTENT PERMITTED BY APPLICABLE LAW, IN NO EVENT SHALL TAIS OR ITS SUPPLIERS BE LIABLE TO YOU FOR ANY CONSEQUENTIAL, SPECIAL, INCIDENTAL OR INDIRECT DAMAGES FOR PERSONAL INJURY, LOSS OF BUSINESS PROFITS, BUSINESS INTERRUPTION, LOSS OF BUSINESS INFORMATION/DATA, OR ANY OTHER PECUNIARY LOSS OF ANY KIND ARISING OUT OF THE USE OR INABILITY TO USE THE SOFTWARE, EVEN IF TAIS OR ITS SUPPLIER HAS BEEN ADVISED OF THE POSSIBILITY OF SUCH DAMAGES. IN NO EVENT SHALL TAIS OR ITS SUPPLIERS BE LIABLE FOR ANY CLAIM BY A THIRD PARTY.
6. State/Jurisdiction Laws. SOME STATES/JURISDICTIONS DO NOT ALLOW THE EXCLUSION OF IMPLIED WARRANTIES OR LIMITATIONS ON HOW LONG AN IMPLIED WARRANTY MAY LAST, OR THE EXCLUSION OR LIMITATION OF INCIDENTAL OR CONSEQUENTIAL DAMAGES. SO SUCH LIMITATIONS OR EXCLUSIONS MAY NOT APPLY TO YOU. THIS LIMITED WARRANTY GIVES YOU SPECIFIC RIGHTS AND YOU MAY ALSO HAVE OTHER RIGHTS WHICH VARY FROM STATE/JURISDICTION TO STATE/JURISDICTION.
7. Export Laws. This License Agreement involves products and/or technical data that may be controlled under the United States Export Administration Regulations and may be subject to the approval of the United States Department of Commerce prior to export. Any export, directly or indirectly, in contravention of the United States Export Administration Regulations, or any other applicable law, regulation or order, is prohibited.
8. Governing Law. This License Agreement will be governed by the laws of the State of California, United States of America, excluding its conflict of law provisions.
9. United States Government Restricted Rights. The Software is provided with Restricted Rights. Use, duplication, or disclosure by the United States Government, its agencies and/or instrumentalities is subject to restrictions as set forth in subparagraph (c)(1)(ii) of The Rights in Technical Data and Computer Software Clause at DFARS 252.227-7013 (October 1988) or subparagraphs (c)(1) and (2) of the Commercial Computer Software - Restricted Rights at 48 CFR 52.227-19, as applicable.
10. Severability. If any provision of this License Agreement shall be held to be invalid, illegal or unenforceable, the validity, legality and enforceability of the remaining provisions hereof shall not in any way be affected or impaired.
11. No Waiver. No waiver of any breach of any provision of this License Agreement shall constitute a waiver of any prior, concurrent or subsequent breach of the same or any other provisions hereof, and no waiver shall be effective unless made in writing and signed by an authorized representative of the waiving party.

YOU ACKNOWLEDGE THAT YOU HAVE READ THIS LICENSE AGREEMENT AND THAT YOU UNDERSTAND ITS PROVISIONS. YOU AGREE TO BE BOUND BY ITS TERMS AND CONDITIONS. YOU FURTHER AGREE THAT THIS LICENSE AGREEMENT CONTAINS THE COMPLETE AND EXCLUSIVE AGREEMENT BETWEEN YOU AND TAIS AND SUPERSEDES ANY PROPOSAL OR PRIOR AGREEMENT, ORAL OR WRITTEN, OR ANY OTHER COMMUNICATION RELATING TO THE SUBJECT MATTER OF THIS LICENSE AGREEMENT.

Toshiba America Information Systems, Inc.
Telecommunication Systems Division
9740 Irvine Boulevard
Irvine, California 92618-1697
United States of America

TSD 081601

5932

Toshiba America Information Systems, Inc.

Telecommunication Systems Division

Limited Warranty

Toshiba America Information Systems, Inc., ("TAIS") warrants that this voice processing equipment (except for fuses, lamps, and other consumables) will, upon delivery by TAIS or an authorized TAIS dealer to a retail customer in new condition, be free from defects in material and workmanship for twenty-four (24) months after delivery. This warranty is void (a) if the equipment is used under other than normal use and maintenance conditions, (b) if the equipment is modified or altered, unless the modification or alteration is expressly authorized by TAIS, (c) if the equipment is subject to abuse, neglect, lightning, electrical fault, or accident, (d) if the equipment is repaired by someone other than TAIS or an authorized TAIS dealer, (e) if the equipment's serial number is defaced or missing, or (f) if the equipment is installed or used in combination or in assembly with products not supplied by TAIS and which are not compatible or are of inferior quality, design, or performance.

Customer will, at its sole cost and expense, provide the necessary Uninterruptible Power Supply (UPS) equipment as specified by TAIS in the *Stratagy Voice Processing General Description* for use with the Stratagy ES system at all times. System failures and/or damages resulting from either not using a UPS with the Stratagy ES or the use of a UPS not equivalent to that specified by TAIS are not covered by this warranty.

The sole obligation of TAIS or Toshiba Corporation under this warranty, or under any other legal obligation with respect to the equipment, is the repair or replacement by TAIS or its authorized dealer of such defective or missing parts as are causing the malfunction with new or refurbished parts (at their option). If TAIS or one of its authorized dealers does not replace or repair such parts, the retail customer's sole remedy will be a refund of the price charged by TAIS to its dealers for such parts as are proven to be defective, and which are returned to TAIS through one of its authorized dealers within the warranty period and no later than thirty (30) days after such malfunction, whichever first occurs.

Under no circumstances will the retail customer or any user or dealer or other person be entitled to any direct, special, indirect, consequential, or exemplary damages, for breach of contract, tort, or otherwise. Under no circumstances will any such person be entitled to any sum greater than the purchase price paid for the item of equipment that is malfunctioning.

To obtain service under this warranty, the retail customer must bring the malfunction of the machine to the attention of one of TAIS' authorized dealers within the twenty-four (24) month period and no later than thirty (30) days after such malfunction, whichever first occurs. Failure to bring the malfunction to the attention of an authorized TAIS dealer within the prescribed time results in the customer being not entitled to warranty service.

THERE ARE NO OTHER WARRANTIES FROM EITHER TOSHIBA AMERICA INFORMATION SYSTEMS, INC., OR TOSHIBA CORPORATION WHICH EXTEND BEYOND THE FACE OF THIS WARRANTY. ALL OTHER WARRANTIES, EXPRESS OR IMPLIED, INCLUDING THE WARRANTIES OF MERCHANTABILITY, FITNESS FOR A PARTICULAR PURPOSE, AND FITNESS FOR USE, ARE EXCLUDED.

No TAIS dealer and no person other than an officer of TAIS may extend or modify this warranty. No such modification or extension is effective unless it is in writing and signed by the vice president and general manager, Telecommunication Systems Division.

Contents

Introduction

Organization	vii
Conventions	viii
Action/Response Table	ix
Related Documents/Media	x
Strategy eBrochure and Advisor CD-ROM	x

Chapter 1 – The Grand Tour

Overview	2
Features to Personalize Your Mailbox	4
Message Folders	4
Single Message Folder	5
Dual Message Folders	5
Multiple Message Folders	6
Message Types	8
Forwarded Message	8
Reply Message	8
Fax Message	9
E-mail Message	9
Greetings	10
Personal	10
System	10
Busy	10
Special Delivery Options	11
Urgent	11
Private	11

Contents

Chapter 2 –Getting Started

Return Receipt	11
Future Delivery	11
Message Destination Selections	12
Personal Distribution Lists	12
System Distribution Lists	13
Directory	13
User Options	14
User Prompts	15

Chapter 2 – Getting Started

User Tutorial	17
Step 1: Access Your Mailbox	18
Step 2: Record Your Name	20
Step 3: Record Your Personal Greeting	21
Step 4: Change Your Security Code	22
Step 5: Exit Your Mailbox or User Mode	22

Chapter 3 – Play Messages

Access Messages	24
Playback Controls	24
Play Messages	26
Special Functions	29
Retrieve and Listen to E-mail Messages	33

Chapter 4 – Send Messages

Recording Controls	38
Send a Message	39
Forward a Message	43
Reply to the Current Message	46
Special Delivery Options	48
Future Delivery	49
Send a Direct Fax	50

Chapter 5 – Manage Mailbox

Change Greeting 54

 Create or Record Over a Personal Greeting 55

 Select a Personal Greeting 57

 Review a Personal Greeting 58

Change User Options 59

 Change Do Not Disturb (DND) Setting 60

 Change Call Screening Setting 61

 Change Security Code 62

 Select Busy Greeting 63

 Create or Record Over Busy Greeting 64

 Record Your Name 66

 Change Message Notification 68

 Set Automatic Message Copy 70

 Review Option Settings 73

Manage Personal Distribution Lists 74

Manage Guest Mailboxes 76

Use Guest Mailboxes 77

Manage Personal Folders 78

Appendix A – Using Strategy ES with a Strata CTX

Call Forward 81

Message Waiting 83

 Responding to a Lit Msg LED 83

 Turning On/Off Message Waiting LED on Another Extension 84

Toshiba Proprietary Integration 84

 Soft Key Control of Voice Mail 84

 Call Record to Strategy ES 90

Direct Transfer to Voice Mailbox 91

Voice Mail Conference 91

Appendix B – Fax Printer Driver

Configure/Personalize Fax Printer Driver	94
Use Fax Printer Driver	97
SES Fax Client Screen	98
Schedule Fax for Future Delivery	100

Appendix C – Automatic Speech Recognition

Reach Destination	102
Access Your Mailbox	102
Send a Message	103

Appendix D – Unified Messaging (UM) with Outlook Integration

Strategy ES Message Window	106
Address Book Feature	108
Update Strategy ES Address Book Manually	108
Update Strategy ES Address Book Automatically	108
Using UM Feature	109
Voice Mail Options	112
Play Voice Message	112
Reply to Voice Message	113
Forward Voice Message	114
Send Voice Message	115
View Fax	115

Appendix E – Unified Messaging with IP Integration

Configure Windows for Strategy ES Codec	118
Check Codec is Installed on PC	118
Configure Windows	119
Record Strategy ES Voice Messages (using Windows Sound Recorder)	120
Send .WAV File as Voice Message	121

Appendix F – Remote User Password Administration for TTS

Set Remote User Password	124
--------------------------------	-----

Appendix G – Using Strategy ES with a Strata Legacy System

Call Forward 126
 Set Call Forward to Strategy ES 126
 Cancel Call Forward 130
 Cancel the Programmed Call Forward Voice Mail Code 130
 Message Retrieval 131
Glossary 133
Index..... 137

Contents

Appendix G –Using Strategy ES with a Strata Legacy System

Introduction

This guide describes the voice messaging capabilities and procedures for making the Strategy ES and Strategy iES32 Voice Processing System work for you.

Organization

This guide is divided as follows:

- **Chapter 1 – The Grand Tour** is an overview of the Strategy ES system. Topics covered are: features to personalize your mailbox; an explanation of message folders, greetings, types and destinations; special delivery options; and available user options and prompts.
- **Chapter 2 – Getting Started** provides instructions on those features you need when accessing Strategy ES for the first time, including changing your security code and recording your name.
- **Chapter 3 – Play Messages** contains step-by-step instructions on playing messages.
- **Chapter 4 – Send Messages** details how to send, forward, and reply to a message.
- **Chapter 5 – Manage Mailbox** provides step-by-step instructions on recording greetings, using destination (distribution) lists, and activating options such as Do Not Disturb and Call Screening.
- **Appendix A – Using Strategy ES with a Strata CTX** outlines Call Forward, Message Waiting, Toshiba Proprietary Integration (i.e., Soft Key Control of Voice Mail and Call Record features), and the Direct Transfer to Voice Mail and Voice Mail Conferencing features.
- **Appendix B – Fax Printer Driver** provides step-by-step instructions on configuring and using the fax printer driver.

- **Appendix C – Automatic Speech Recognition** contains step-by-step instructions on using the optional speech recognition feature.
- **Appendix D – Unified Messaging with Outlook Integration** contains step-by-step instructions on using the optional Unified Messaging feature.
- **Appendix E – Unified Messaging with IP Integration** contains instructions on recording and sending a .wav file using Windows® Sound Recorder.
- **Appendix F – Remote User Password Administration for TTS** provides instructions on how to update the Strategy ES software with your e-mail log on password so that the system can read your e-mail messages via Text-to-Speech (TTS).
- **Appendix G – Using Strategy ES with a Strata Legacy System** explains how to program your Toshiba proprietary telephone for Call Forward and Message Retrieval when using your integrated Strategy ES system.
- **Glossary** defines frequently-used Strategy ES voice processing system features and functions.
- **Index**

Conventions

Conventions	Description
Note	Elaborates specific items or references other information. Within some tables, general notes apply to the entire table and numbered notes apply to specific items.
Important!	<i>Calls attention to important instructions or information.</i>
Extension Number	<p>Press to answer a call to the Extension Number. Each station can have multiple extension buttons. Incoming calls ring the extension button(s) from the top down. For example, station 10's extensions ring 10-1 first, then 10-2, 10-3, and 10-4. A station is considered busy when all extensions are being used.</p> <p>Note The naming convention for DKT assignments within Toshiba is Directory Numbers. For clarity and ease of understanding, the terms Extension Number and Phantom Extension Number will be used in this document in lieu of PDN and PhDN.</p>

Conventions	Description
Arial bold	Represents telephone buttons.
Courier	Shows a computer keyboard entry or screen display.
“Type”	Indicates entry of a string of text.
“Press”	Indicates entry of a single key. For example: Type prog then press Enter .
Plus (+)	Shows a multiple PC keyboard or phone button entry. Entries without spaces between them show a simultaneous entry. Example: Esc+Enter . Entries with spaces between them show a sequential entry. Example: # + 5.
Tilde (~)	Means “through.” Example: 350~640 Hz frequency range.
➤	Denotes the step in a one-step procedure.
➤	Denotes a procedure.
See Figure 10	Grey words within the printed text denote cross-references. In the electronic version of this document (Library CD-ROM), cross-references appear in blue hypertext.

Action/Response Table

Actions you perform appear in this column. They can consist of either a single step or a series of numbered steps.

The *immediate response to the action* performed appears in this column. Additional notes and comments are also included.

Related Documents/Media

Note Some documents listed here may appear in different versions on the CD-ROM or in print. To find the most current version, check the version/date in the Publication Information on the back of the document's title page.

Important! *Read this User Guide first, then use it with the Quick Reference Guide.*

- Strategy General Description
- Strategy Enterprise Server (ES) Installation & Maintenance Manual
- Strategy Enterprise Server System Administrator Guide
- Strategy Enterprise Server Quick Reference Guide
- Strategy Library CD-ROM

Strategy eBrochure and Advisor CD-ROM

Packaged with every Strategy shipped is a CD-ROM containing *Strategy eBrochure*, and an end-user tutorial, *Strategy Advisor*. Additional copies of this CD-ROM can be purchased from your Dealer Sales Representative.

eBrochure

The *eBrochure* provides a description of each of the Strategy products along with audio supplemented mini-demonstrations illustrating the capabilities of Strategy voice processing. Also included on the CD-ROM is an electronic copy of this *Strategy General Description*.

Advisor

The *Strategy Advisor* is an end-user tutorial that can be used as a learning tool for the new user or as a refresher course for existing Strategy users.

The *Strategy Advisor* program covers general topics—such as play messages, send messages, etc.—that are applicable to all models of Strategy systems. The Strategy iES32 and Strategy ES tutorials are separated into two sections: the Telephone User Interface (TUI) and Unified Messaging. All presentations interact with the viewer in order to provide a better understanding of how Strategy works.

This chapter provides an overview of the system and covers the following general topics:

- Features to personalize your mailbox
- Message folders
- Message types
- Greetings
- Special delivery options
- Message destinations
- User options
- User prompts
- User Tutorial (New User)

Overview

Strategy ES manages multiple voice processing functions simultaneously 24-hours-a-day, seven-days-a-week. Your mailbox is always available for callers to leave private voice or fax (optional feature) messages. In addition, you can update your greeting at your convenience or send and receive messages from any touchtone telephone.

Callers control their own progress through the system. They no longer have to wait for a person to answer the telephone. If your extension is busy or you do not answer, callers can transfer to an operator, call another extension, or record a private, detailed message.

A representative in your company is assigned as the System Administrator for the system. The System Administrator is responsible for system maintenance that includes configuring your mailbox to suit your needs.

The configuration affects how and which features you can access. Whenever possible, this guide provides information concerning feature exceptions and which features may be configured to work differently.

You can access your mailbox from any tone-dialing telephone using your security code. After you access Strategy ES, you hear the number of messages you have in your message folder(s), followed by a prompt from the Main Menu options (see [Figure 1](#)). You can then:

- Listen to your messages
- Send or forward messages
- Reply to messages
- Manage your mailbox (e.g., change your greetings, create distribution lists, etc.)
- Listen to your e-mail messages

Note This feature is only available to users of Strategy ES with Unified Messaging (UM) and Text-to-Speech (TTS) capabilities. Check with your System Administrator to find out if your system is configured for this feature.

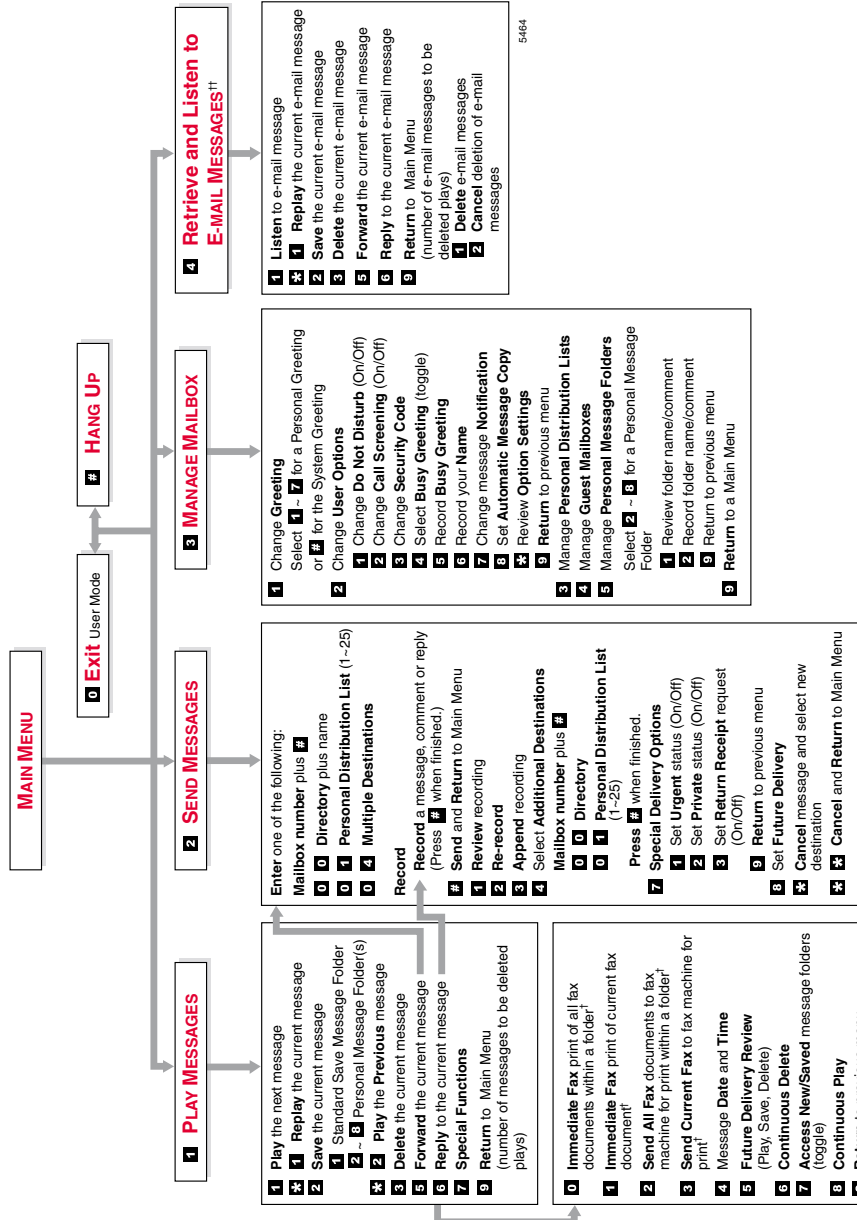

5464

Figure 1 Strategy ES Main Menu

† Optional feature
†† Requires UM and TTS

Features to Personalize Your Mailbox

The Strategy ES Voice Processing System offers a variety of features to personalize your mailbox. The following are a few of those features:

- **Mailbox Security Code** – Your mailbox has a security code. The code must be entered by you in order to “log into” your mailbox, giving you access to your messages, settings, greetings, etc. (see [“Change Your Security Code”](#) on [page 22](#)).
- **Name Recording** – Your name is announced whenever the directory is accessed, you select the system greeting, or a message is sent by another Strategy ES user. When you first enter your mailbox, you need to record your name (see [“Record Your Name”](#) on [page 20](#)).
- **Personal Greetings** – You can record up to seven personal greetings that are played when you are unavailable (see [“Change Greeting”](#) on [page 54](#)).
- **Guest Users** – You can create guest mailboxes that can be used by clients, friends, etc. Users frequently use this feature to create guest mailboxes for clients, so that they can easily exchange confidential information (see [“Manage Guest Mailboxes”](#) on [page 76](#)).
- **Personal Folders** – You can save your messages in up to seven personal folders you create. The folders are for only your use and you can change them whenever necessary (see [“Manage Personal Folders”](#) on [page 78](#)).

Message Folders

Messages in the Strategy ES are stored in message folders and play in the order received – FIFO (First In, First Out) or LIFO (Last In, First Out).

Your mailbox has one of the following folder configurations:

- A single message folder where all messages reside.
- Dual message folders – new, saved.
- Multiple message folders where, in addition to the new and saved folders, you can create up to seven personal folders for your messages.

Note Consult your System Administrator for your mailbox’s programming.

Single Message Folder

Your messages reside in one message folder. When you access your mailbox, Strategy ES announces you have “x messages, y is (are) new, z is (are) urgent, w fax(es).” New messages play based on the type (urgent messages play first) and order received (FIFO/LIFO). If no new messages exist, Strategy ES plays any saved messages in the mailbox.

After you play the last message in the folder, Strategy ES prompts, “End of messages.” You can choose to return to the top of the folder, etc.

Dual Message Folders

Your messages reside in one of two folders—new or saved. When you access your mailbox, Strategy ES announces you have “x new, y is (are) urgent and z saved messages, w fax(es).”

New Message Folder

New messages consist of messages that are unheard.

When you press **1** from the Main Menu to play messages, Strategy ES automatically accesses the New Message Folder. A new message begins to play based on the type (urgent messages play first) and order received (FIFO/LIFO). After you play the last message in the folder, Strategy ES prompts, “End of messages.” You can choose to return to the top of the folder, or go to the top of the saved folder.

Your Message Waiting LED only extinguishes when all new messages have been either deleted or saved.

Note You can enable a Message Pending feature on your mailbox. When enabled, the system marks new messages that have been partially heard (for more than two seconds by default) as Pending. Pending messages remain in the New Message Folder; however, if the New Message Folder contains only Pending Messages, your Message Waiting LED goes out. This allows you to retain messages in the New Message Folder, yet alert you when new messages arrive. Messages marked as Pending also submit a Return Receipt notification to the sender of the message, if it was requested. Consult your System Administrator for further information.

If no new messages exist, Strategy ES automatically accesses the Saved Message Folder. If you are in the Saved Message Folder, you can toggle back to the New Message Folder by pressing **77**.

Saved Message Folder

Saved messages consist of messages that:

- You save by pressing **2** either during or after playing the message. Strategy prompts, “This message will be saved in the Saved Message Folder.”
- Strategy ES automatically saves when you do not press **3** (delete) after playing the message.

Messages are not moved to the Saved Message Folder until you log out of your mailbox, enabling you to return to the new message folder and replay the message.

Access the Saved Message Folder from the Main Menu by pressing **177** or from the New Message Folder by pressing **77**. Strategy ES automatically accesses the Saved Message Folder when no new messages exist.

After you play the last message in the folder, Strategy ES prompts, “End of messages.” You can choose to return to the top of the folder, or go to the top of the new message folder by pressing **77**.

Multiple Message Folders

Your messages reside in up to nine folders— one new (folder 0), one saved (folder 1) and up to seven personal folders (folders 2~8), created by you for the purpose of saving your messages. The personal folders are for only your use. When you access your mailbox, Strategy ES announces the number of messages you have in the same manner as the example in “[Dual Message Folders](#)” on [page 5](#).

Message folders enable you to store saved messages topically, providing better organization of important correspondence. You can record a comment for each folder, such as “Messages from Toshiba America,” to assist you in locating the right folder in which to store or retrieve a message.

Note To create or change personal folders, see “[Manage Personal Folders](#)” on [page 78](#).

New Message Folder

The New Message Folder is configured identically for both the Dual Message and Multiple Message Folder mailboxes with the following exception:

If no new messages exist in a Multiple Message Folder mailbox, Strategy ES accesses the Saved Message Folder (if you have not created any personal folders) or plays the name/comment/number of all available personal folders. You are then requested to enter the folder number.

Saved Message Folder/Personal Message Folders

Saved messages consist of messages that:

- Strategy ES automatically saves when you do not press **3** (delete) after playing the entire message. The message is saved in the Saved Message Folder (folder 1), the default destination for saved messages. Strategy ES prompts, “This message will be saved.”
- You save by pressing **2** either during or after playing the message. Strategy ES checks your mailbox for Personal Message Folders.

If personal folders do not exist, Strategy ES saves the message in the Saved Message Folder (folder 1). Strategy prompts, “This message will be saved.”

If Personal Message Folders *do* exist, Strategy ES plays the recorded name/comment and number of all available personal folders. You are requested to enter a valid folder number where you want the message saved. If you know the personal folder number you want, you can select it at anytime. You do not have to listen to the entire list of available folders. If an invalid number is entered, Strategy ES automatically saves the message in folder 1.

Messages are not moved to a “save” folder until you log out of your mailbox, enabling you to return to the new message folder and replay the message.

After you play the last message in the folder, Strategy ES prompts, “End of messages.” You can choose to return to the top of the folder, go to the top of another folder, etc.

Access Folders

When you press **77** from the New or Saved Message Folders or **177** from the Main Menu, Strategy ES checks your mailbox for personal folders. Depending upon whether it finds any, Strategy ES performs the following procedures:

Access Method	No Personal Folders	Personal Folders
From New or Saved Message Folder, press 77 .	Goes to Saved Message Folder.	Strategy ES prompts you to: <ul style="list-style-type: none">• Enter a personal folder number. or press...• 0 for the New Message Folder.• 1 for the Saved Message Folder.
From Main Menu, press 177 .		

Message Types

The Strategy ES has the following special types of messages—forwarded, reply, fax, and e-mail.

Forwarded Message

Any message sent to you can be forwarded to one or more individual destinations or a personal or system distribution list. When forwarding a message, recording a message (comment) is optional.

Reply Message

Messages from other Strategy ES users to which you want to send an immediate response can be sent as a reply message. When replying to a message, Strategy ES does not prompt you to select the destination if the original message was recorded within a user's mailbox. If the message was not recorded from a user's mailbox, you can still reply to the message but the system requests that you enter a destination mailbox number.

When listening to a reply message, a prompt notifies the user of the name/mailbox number of the person who sent the reply.

Fax Message

Note Fax Messaging is an optional feature in the Strategy ES. Check with your System Administrator to find out if your system is configured for this feature.

Fax messages can be sent to your mailbox and stored or forwarded along with voice messages. When you access your mailbox, Strategy ES tells you the number of fax messages that are in your mailbox. Once you access the fax message, Strategy ES plays the header information that includes the number of pages received. You cannot listen to the actual fax document.

You can forward the fax to other users as you would a voice message, including sending a voice comment with the fax to provide information about the message. You can also print the fax. See “[Special Functions](#)” on [page 29](#) for details.

E-mail Message

Note This feature is only available to users of Strategy ES with Unified Messaging (UM) and Text-to-Speech (TTS) capabilities. Check with your System Administrator to find out if your system is configured for this feature.

You can retrieve and listen to your e-mail messages from your mailbox. Once you access the e-mail message, Strategy ES plays the header information that includes sender information and time and then plays the content. Upon playing the e-mail message you can:

- Delete it from your e-mail Inbox on your computer. e-mails that are not deleted remain in your e-mail Inbox and are played the next time you access this function.
- Forward it to other users that have UM privileges. The destination user must have both a Strategy ES voice mailbox and an e-mail address that has been defined in the destination user’s mailbox.
- Reply to a e-mail message. The Strategy ES generates an e-mail message with your recorded reply attached as an audio .wav file, and sent back to the originator.

Greetings

You can select either a personal or system greeting to play to callers when you do not answer or when your telephone is busy.

Depending on how your system is configured, callers may hear a separate busy greeting—the system or the custom busy greeting. See [“Change User Options”](#) on [page 59](#) for details.

Personal

Personal greetings are greetings that you record for callers. Strategy ES stores all recorded greetings under the personal greeting number (1~7) for your mailbox. Using the greeting number, you can select which greeting plays.

The System Administrator can also schedule your greetings to automatically play at different times. If you choose, you can override the automatic schedule using [“Select a Personal Greeting”](#) on [page 57](#).

System

The system greeting is a standard prerecorded greeting with all Strategy ES systems. It cannot be recorded over or deleted. The greeting states, “Please leave a message for (name).” Strategy ES adds your name from the name recording that you made (see [“Record Your Name”](#) on [page 20](#)).

Busy

If your mailbox is configured for a personal busy greeting, you can record a custom busy greeting that plays when your extension is busy. If a custom greeting is not recorded, the default system busy greeting plays. The custom busy greeting can also be turned On/Off using the Select Your Busy Greeting option on the Change User Options Menu (see [“Select Busy Greeting”](#) on [page 63](#)).

Note The System Administrator must configure your mailbox for the custom busy greeting option to be available.

Special Delivery Options

In addition to recording and sending a new message, you can mark the message urgent, private, or request a return receipt.

Urgent

Messages can be marked urgent by the sender and always play first in the New Message Folder. After the message plays, the urgent status is removed.

Private

Messages can be marked private by the sender. The same options, such as saving and deleting, apply to the private messages; however, a private message cannot be forwarded or copied using the Automatic Message Copy feature. Once a message is sent, the private status cannot be removed.

Return Receipt

You can mark a message for Return Receipt if you want verification that it has been played. When a user completely plays a message marked for Return Receipt, a notification is sent back to the sender. Strategy ES notifies the sender the time the message was heard and by whom and then plays the original message as a reminder of the message. This can be helpful if multiple messages were sent to the same destination with Return Receipt requested.

Future Delivery

Strategy ES can be configured so that your message is delivered at a future specified time and date. After marking the message for future delivery, you can review (play, save, delete) the message at any time before it is sent (see [“5 Future Delivery Review”](#) on page 30).

Message Destination Selections

At the beginning of the Send Messages menu, you are asked to enter the destination mailbox number(s). You can choose to enter a single destination (e.g., mailbox number) or multiple destinations (e.g., mailbox number, personal lists). Using the Multiple Destinations option enables you to address your message to all the recipients at the start of the menu.

You can then record your message and, if desired, add additional destinations when prompted later in the menu. Valid destinations are:

- Mailbox Number

Note If you don't know the user's mailbox number, you can locate the mailbox number on Strategy ES's system-wide directory by pressing **00**.

- Personal distribution list
- System distribution list
- Audio Messaging Interchange Specification (AMIS) Proxy mailbox number
- AMIS Gateway number plus a remote mailbox number

Note AMIS analog networking is an optional feature and enables a Strategy mailbox user to send, receive and reply to relayed voice messages over any remote voice mail system that supports the AMIS analog protocol.

See [“Send a Message”](#) on [page 39](#) for instructions on using these options.

Personal Distribution Lists

You can create up to 25 Personal Distribution Lists consisting of other system users. You can add or delete users at any time. The lists are for only your use.

At the time you create a list, you are given the option of recording a “list comment” that serves as the title or name for the list. The comment plays each time you use the list to confirm that you have chosen the correct distribution list.

System Distribution Lists

In addition to Personal Distribution Lists, Stragy ES supports system-wide distribution lists created by the System Administrator for use by everyone in your company. You should check with your System Administrator to find out which lists are available.

The “list comment” for the selected system list is played whenever you enter the mailbox number to confirm that the right list has been chosen.

Important! When creating lists, you should keep in mind that Stragy ES does not check for duplicate users on separate lists when sending a message. For example, if you select Personal Distribution List #1 and #3 as destinations for your message and Mailbox Number 1001 is on both lists, the message is sent twice to Mailbox Number 1001.

Directory

Using your telephone’s dial pad, you can enter the digits corresponding to the first few letters of a user’s name or the first letters of a system distribution list name. Stragy ES plays the recorded name and mailbox number that matches the combination of entered digits. You can then select the name or go on to the next name in the directory.

Each mailbox can be identified with up to two names. These names are entered into the automated directory by the System Administrator and enhance the directory’s search/find capabilities. Common choices for the names are the first and last names of the user, last name of the user and a commonly misspelled version of the last name or in the case of a system distribution list, two words that might appear in the list title.

User Options

You can set your mailbox for Do Not Disturb (DND) or call screening, select or record a busy greeting (plays when your telephone is busy), designate where or how you are notified of a message, and set your mailbox to automatically copy messages to another mailbox.

The following is a brief description of each of the options. Please see [“Change User Options”](#) on [page 59](#) for more detailed information.

Important! The System Administrator must activate these features for them to be available.

- **DND** – When a caller enters your extension number, the Strategy ES automatically sends the call to your mailbox without first ringing your telephone.
- **Call Screening** – Strategy ES asks callers for their name. Without the caller’s knowledge, the system relays that information to you. You can decide to receive the call, let the call forward to your mailbox, or transfer the call to another extension with or without an announcement.
- **Busy Greeting** – You can record your own custom busy greeting that plays when callers reach your extension, and it is busy.
- **Message Notification** – Your mailbox can have notification records programmed by the System Administrator with a specific notification method (message waiting lights, pagers, voice, etc.) and the time/day when that notification record applies.

Once you have turned on a specific notification record, Strategy ES automatically calls you at the designated number and with the chosen method to notify you of your messages.

- **Automatic Message Copy** – You can set your mailbox to automatically copy all messages or just urgent messages to another mailbox during specified times of the day.

User Prompts

The Strategy ES system prompts only for menu options available to you. You do not hear prompts for options:

- Not available in your Strategy ES system (i.e., fax).
- Not configured for your mailbox by the System Administrator (e.g., guest users, DND).

Check with your System Administrator to verify which user options and features are available to you.

This chapter instructs you on accessing and exiting your mailbox and outlines the user tutorial steps.

User Tutorial

When you log on to the Strategy ES Voice Processing system for the very first time, you hear a tutorial that walks you through the following basic steps:

- Record your name. Your name is announced whenever the directory is accessed, you select the system greeting, or another Strategy ES user sends a message to you.
- Record your personal greeting. Your personal greeting automatically plays when you are not available to answer your telephone.
- Change the default security code for your mailbox to ensure privacy. You should change it on a regular basis.

Note If you do not complete the tutorial before hanging up, Strategy ES saves any completed portion (e.g., your name recording) and restarts where you left off the next time you log on to your mailbox. Once the Strategy ES tutorial is completed successfully, it cannot be replayed.

Getting Started

Step 1: Access Your Mailbox

Step 1: Access Your Mailbox

The Main Menu (shown below) is your starting point for all of Strategy ES's messaging features. Pressing **999** from most menus returns you to the Main Menu.

To access your mailbox, you need to know:

- The telephone number to access Strategy ES
- Your mailbox number
- Your default security code

Please ask your System Administrator if you do not have this information.

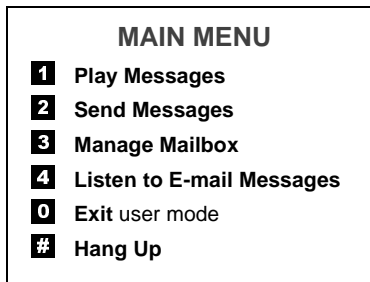

Each time you access your mailbox, Strategy ES announces:

- The number of new and saved messages you have in your message folder(s).
- The number of messages that will be purged upon exiting your mailbox, if applicable.

Strategy ES then plays the Main Menu options.

If you receive new messages while you are logged on to your mailbox, Strategy ES informs you that new messages have arrived every time you return to the Main Menu.

<p>1. From an internal telephone, call Strategy ES on _____</p>	<p>The system answers with your standard company greeting.</p>
<p>...or from an external telephone, call Strategy ES on _____.</p>	
<p>2. When Strategy ES answers, press *.</p>	<p>Strategy ES prompts you to enter your mailbox number.</p>
<p>3. Enter your mailbox number.</p>	<p>Strategy ES prompts you to enter your security code.</p>
<p>4. Enter the default security code. If you make a mistake while entering the code, press * to re-enter.</p>	<p>You are now in your mailbox. Strategy ES plays the number of messages you have and then prompts you with a list of choices from the Main Menu.</p>

Note If the Strategy ES is fully integrated with the telephone system, Strategy ES is informed of your mailbox number and prompts you for your security code. Consult your System Administrator for information on how your system is integrated.

Step 2: Record Your Name

Your name is announced whenever the directory is accessed, you select the system greeting, or a message is sent by you to another Strategy ES user.

When you first enter your mailbox, the Strategy ES tutorial prompts you to record your name and walks you through the entire recording sequence. You can re-record your name at any time (see [“Record Your Name”](#) on [page 66](#)).

1. At the tone, state your name slowly and clearly (if you like, you can also state your extension).
 2. Press **#** when done.
 3. After your name plays, press:
 - #** To accept the recording
- * Re-record

Strategy ES plays your name recording.

Your recording becomes part of your mailbox and Strategy ES prompts you to record your personal greeting.

Strategy ES returns you to the record your name prompt.

Step 3: Record Your Personal Greeting

The tutorial now prompts you to record your personal greeting. This greeting becomes your Personal Greeting #1. You can record up to six other greetings (see [“Create or Record Over a Personal Greeting”](#) on [page 55](#) for instructions).

Personal greetings should be informative and advise callers when you will be available to return their calls or respond to their messages. You can update personal greetings as often as you want.

Sample Greeting

“Hi. This is Mary Smith of the Toshiba Marketing Department. It is Monday, June 19, and I am in the office today. I am either on the telephone or have stepped away for a few minutes and your call has been forwarded to my voice mailbox. If at the tone you leave a detailed message and a telephone number where I can reach you, I will be happy to return your call.”

<ol style="list-style-type: none"> 1. At the tone, begin recording your greeting. 2. Press # when done. 3. After your greeting plays, press: <ul style="list-style-type: none"> # To accept the recording * Re-record 	<p>The following information should be included:</p> <ul style="list-style-type: none"> • Your name • Company and/or department • Date • Your availability • Instructions to leave a detailed message • Call coverage options <p>Stratagy ES plays your greeting.</p> <p>Your greeting becomes Personal Greeting #1 and Stratagy ES prompts you to change your security code.</p> <p>Stratagy ES returns you to the record your greeting prompt.</p>
------------------------------------------------------------------------------------------------------------------------------------------------------------------------------------------------------------------------------------------------------------------------------------------------------	------------------------------------------------------------------------------------------------------------------------------------------------------------------------------------------------------------------------------------------------------------------------------------------------------------------------------------------------------------------------------------------------------------------------------------------------------------------------------------------------------------------

Step 4: Change Your Security Code

You should change your security code on a regular basis to ensure the privacy of your messages and personal greetings (see “[Change Security Code](#)” on [page 62](#)).

Stratagy ES prompts you to enter your new security code and notifies you of the number of allowable digits. For example, Stratagy ES might prompt “the new security code must have at least three digits and 16 maximum digits” or “the new security code must be exactly four digits.”

- | | |
|-----------------------------------------|-----------------------------------------------------------------------------------------------------------------|
| 1. Enter your new security code + #. | Stratagy ES prompts you to <i>re-enter</i> your new security code for verification. |
| 2. Re-enter your new security code + #. | After entering the security code a second time, Stratagy ES announces that your security code has been changed. |

You have completed the tutorial. Stratagy ES announces “mailbox number xxx is enabled,” and announces the number of messages in your mailbox. You can now perform any of the functions available on the Stratagy ES Main Menu or exit the mailbox.

Step 5: Exit Your Mailbox or User Mode

- | | |
|-------------------------------------------------------------------------------------|--------------------------------------------------------------------------------------------------------------------------------------------------------------------------------------------------------------------------------------------------------------------------------------------------------------------------------------------------------------------------------------------------------------------------------------------------------------------|
| ➤ To exit your mailbox, press # to hang up
...or to exit the user mode, press 0. | Stratagy prompts, “Thank you for calling. Good-bye.”

Stratagy ES can be configured so that you can exit your mailbox without leaving the Stratagy ES system. Please ask your System Administrator to find out if your system is configured for this or some other function when pressing 0.

If you have the “0 to EXIT User Mode” capability, you hear Stratagy ES’s instructional greeting. You can now access another user or a different mailbox. |
|-------------------------------------------------------------------------------------|--------------------------------------------------------------------------------------------------------------------------------------------------------------------------------------------------------------------------------------------------------------------------------------------------------------------------------------------------------------------------------------------------------------------------------------------------------------------|

This chapter explains how to use the Play Messages feature. It covers:

- Accessing messages
- Playback controls
- Playing messages
- Special functions
- Retrieve and listen to e-mail messages

Stratagy ES lights the message waiting light on your telephone when a voice or fax message has been left for you on the Stratagy ES system.

Note Your telephone system and telephone must support a message waiting light for this feature to function.

If configured, Stratagy ES automatically turns off your message waiting light on your telephone when your new message folder is empty or only Pending messages remain (see “[Message Folders](#)” on [page 4](#)).

All new messages must be deleted, saved, or pending (partially heard) for Stratagy ES to turn off the message waiting light on your telephone. The Message Waiting LED remains on only if there are new messages in the folder.

Access Messages

Once you press **1** to play your messages, the following telephone keys assist you in going through your messages:

- 1** Takes you to the next message or back to the top of the folder when you have reached the last message in the folder.
- *1** Replays the current message.
- *2** Takes you to the previous message or back to the last message in the folder when you have reached the top of the message folder.

If you receive new messages while you are accessing your mailbox, Strategy ES notifies you every time you return to the Main Menu that new messages have arrived.

Note See “[Message Folders](#)” on [page 4](#) on using access keys **77** and **177**.

Playback Controls

While playing a message, you can pause, control the volume, location, and speed of playback using the following keys (shown below).

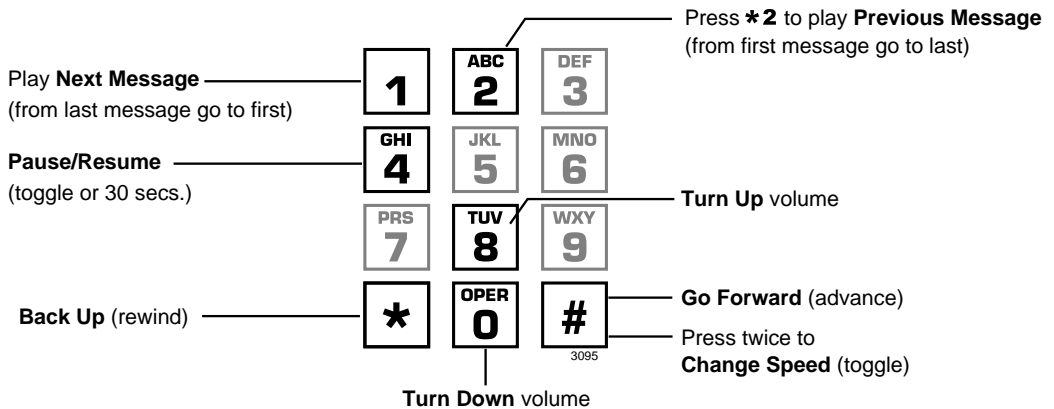

1 Play Next Message

Plays next message in folder. If you are at the last message in the folder, goes to the first message in the same folder.

***1 Replay Current Message**

Plays previous message in folder. If you are at the first message in the folder, goes to the last message in the same folder.

***2 Play Previous Message**

Plays previous message in folder. If you are at the first message in the folder, goes to the last message in the same folder.

4 Pause/Resume (toggle or 30 seconds)

At any time while playing messages, you can press **4** to pause the playback. The message resumes playing as soon as you press **4** or automatically at the end of a defined amount of time (default is 30 seconds). You can pause the playback as many times as necessary.

8 Turn Up Volume, 0 Turn Down Volume

Each time you press **8** or **0**, the volume of messages adjusts one increment until the maximum number of increments is reached. Strategy ES saves the current level when you exit.

*** Back Up (rewind)**

The message backs up/rewinds and then begins playing. The default is five seconds (set by the System Administrator).

Go Forward (advance)

The message goes forward/advances and then begins playing. The default is five seconds (set by the System Administrator).

Change Speed (toggle)

Two speeds are available for playing messages: normal and fast (level set for your mailbox by the System Administrator). When you exit the Play Messages Menu, the system returns to the default speed.

Play Messages

When you access your mailbox, Strategy ES tells you the number of urgent, new, saved, and fax messages (if supported by your system; check with your System Administrator) you have in your mailbox.

When you press **1** from the Main Menu to play messages (menu shown below), Strategy ES automatically accesses the New Message Folder. If no messages exist in the New Message Folder, Strategy ES automatically accesses the Saved Message Folder or Personal Folders.

If your mailbox is empty, the Strategy ES Main menu prompt does not include “press **1** to play messages.”

From the Main Menu:

- 1 Play Messages**
 - 1** Play the next message
 - * **1** **Replay** the current message
 - 2** **Save** the current message
 - * **2** **Play** the **Previous** message
 - 3** **Delete** the current message
 - 5** **Forward** the current message
 - 6** **Reply** to the current message
 - 7 Special Functions**
 - 0** **Immediate Fax** print of all fax documents within a folder†
 - 1** **Immediate Fax** print of current fax document†
 - 2** **Send All Fax** documents to fax machine for print within a folder†
 - 3** **Send Current Fax** to fax machine for print
 - 4** Message **Date** and **Time**
 - 5** **Future Delivery Review** (Play, Save, Delete)
 - 6** **Continuous Delete**
 - 7** **New/Saved** message folder (toggle)
 - 8** **Continuous Play**
 - 9** **Return** to previous menu
 - 9** **Return** to the Main Menu

While playing a message, you can press:

- 4** **Pause/Resume** (toggle or 30 seconds)
- 8** **Turn Up** volume
- 0** **Turn Down** volume
- * **Backup** (rewind)
- #** **Go Forward** (advance)
- # #** **Change Speed** (toggle)

4554

† Optional feature

<p>1. From the Main Menu, press 1. While the message plays, you can select 4 to pause/resume, 8 to turn up volume, 0 to turn down volume, * to back up (rewind), # to go forward (advance), and/or ## to change speed (toggle).</p> <p>2. (Optional) While the message plays or immediately after, you can select <i>one</i> of the following:</p> <p>1 Play the next message</p> <p>2 Save the current message</p> <p>(Optional) For Multiple Folder mailboxes: Enter a folder number (1 for Saved Message Folder, 2~8 for Personal Folders).</p> <p>Note To create or change personal folders, see “Manage Personal Folders” on page 78.</p>	<p>A message plays.</p> <p>Skips to the beginning of the next message.</p> <p>Note If you reach the end of your messages, pressing 1 takes you back to the top of the same folder.</p> <p>Single or dual message folders: Strategy ES saves the message and the Play Messages Menu plays.</p> <p>Multiple message folders: Strategy ES plays the recorded names/comment/numbers of all available folders. You are requested to enter a valid folder number where you want the message saved.</p> <p>If an invalid number is entered, Strategy ES automatically saves the message in folder 1.</p>
------------------------------------------------------------------------------------------------------------------------------------------------------------------------------------------------------------------------------------------------------------------------------------------------------------------------------------------------------------------------------------------------------------------------------------------------------------------------------------------------------------------------------------------------------------------------------------------------------------------------------------------------------------------------------------------------------------------------------------------------------------	------------------------------------------------------------------------------------------------------------------------------------------------------------------------------------------------------------------------------------------------------------------------------------------------------------------------------------------------------------------------------------------------------------------------------------------------------------------------------------------------------------------------------------------------------------------------------------------------------------------------

- 3** Delete the current message

- 5** Forward the current message

- 6** Reply to the current message

- 7** Special Functions
 - *1** Replay the current message
 - *2** Play the previous message

Note Messages are not moved to the saved folder until you log out of your mailbox, enabling you to return to the new message folder and replay the message.

The Play Messages Menu plays.

Flags the current message for deletion. The Play Messages Menu plays. When you exit Play Messages, Strategy ES tells you the number of messages to be deleted. If you do not want to delete a message, save the message before exiting your mailbox.

Note Strategy ES can be programmed to purge messages after a preset length of time. Consult your System Administrator. Strategy ES notifies you before purging messages.

With the exception of private messages, all messages can be forwarded to a single user, multiple users, or a destination list. See [“Forward a Message”](#) on [page 43](#) for details on this feature.

Your reply is sent to the originator of the message. In addition, you can send your reply to a single user, multiple users, or a destination list. See [“Reply to the Current Message”](#) on [page 46](#) for details on this feature.

Strategy ES prompts with the options. See [“Special Functions”](#) on [page 29](#) for instructions on using this option.

The current message plays from the beginning.

The previous message plays from the beginning.

Note If you are at the top of the message folder, pressing ***2** takes you to the bottom of the same folder.

9 Return to Main Menu

Stratagy ES tells you the total number of messages that will be deleted when you log out of your mailbox, and then returns to the Main Menu.

Special Functions

You can print or send faxes, check the date and time a message was sent, or review a message set for future delivery in the Play Messages Menu.

When you play a message, this option is available by pressing **7** Special Functions.

Note If a message does not contain a fax, Stratagy ES does not play Fax options.

➤ Press an option number:

0 Immediate Fax print of all fax documents within a folder

Retrieves (prints) all the faxes from your mailbox while calling from a fax machine (or other device capable of receiving a fax) with a handset.

1 Immediate Fax print of current fax document

Retrieves (prints) the current fax from your mailbox while calling from a fax machine (or other device capable of receiving a fax) with a handset.

2 Send all Fax documents within a folder to a fax machine for print
Enter fax machine's telephone number.

Stratagy ES prompts for the fax machine's telephone number.

Press **#** to accept entry

The system sends all fax messages to a fax machine (or other device capable of receiving a fax) for retrieval (print). The Play Messages Menu plays.

...or ***** to re-enter fax number.

3 Send Current Fax to fax machine for print

Stratagy ES prompts for the fax machine's telephone number.

Play Messages

Special Functions

Enter fax machine's telephone number.

Press **#** to accept entry

...or ***** to re-enter fax number.

4 Message Date and Time

5 Future Delivery Review

While the message is playing or immediately after, you can press **1** to play the next message, **2** to save the current message, **3** to delete the current message and/or **9** to return to the Special Functions Menu.

6 Continuous Delete

The system sends a fax message currently residing in your mailbox to a fax machine (or other device capable of receiving a fax) for retrieval (print). The Play Messages Menu plays.

The date and time the message was received plays, followed by the entire message.

Note If your System Administrator programmed an automatic date and time stamp for all messages, the stamp plays automatically at the beginning of each message.

Strategy ES announces the total number of future delivery messages and plays the first message (i.e., future delivery time/date, destination mailbox, and the entire message) based on chronological order. Strategy ES automatically saves the message for future delivery.

Strategy ES prompts for **#** or ***** entry.

Press **#** to delete all messages

Deletes multiple messages at one time in your New, Saved or Personal Message Folder(s) without additional action from you.

Note See the Continuous Play feature on [page 32](#) before using Continuous Delete.

The number of messages deleted is based on a preset length of time (designated in minutes) set by your System Administrator on a system-wide basis.

Important! *The deletion starts with the first message in the folder and continues until the preset time has expired. Both heard and unheard messages are deleted. If there are multiple folders, the deletion occurs only in the folder you are in when you press **6** for continuous delete.*

...or ***** to cancel option.

7 New/Saved message folder (toggle)

If personal folders exist, enter a folder number

...or **0** to go to new folder, **1** to go to Saved Message Folder, or ***** to return to previous menu.

Returns to Play Messages Menu.

Stratagy ES checks the system for any personal folders you have created. If personal folders exist, Stratagy ES prompts for a personal folder number. If none exist, this feature operates as a toggle and moves you back and forth between the New and Saved Message Folders.

8 Continuous Play

Plays many messages at a time in your New, Saved or Personal Message Folder(s) without additional action from you.

Note Messages played in the New Message Folder remain as new messages and are not automatically saved.

The number of messages played is based on a preset length of recorded time (designated in minutes) and therefore varies. (Your System Administrator sets the length of time on a system-wide basis.) The messages played are those whose cumulative time is equal to, or less than, the designated number of minutes.

Important! *The playback starts with the first message in the folder and continues until the preset time has expired. If there are multiple folders, the playback occurs only in the folder you are in when you press **8** for continuous playback.*

Ask your System Administrator to verify that you have this option.

Stratagy ES returns to the Play Messages Menu.

9 Return to previous menu

Retrieve and Listen to E-mail Messages

Note This feature is only available to users of Strategy ES with Unified Messaging (UM) and Text-to-Speech (TTS) capabilities. Check with your System Administrator to find out if your system is configured for this feature.

When you press **4** (menu shown below) from the Main Menu, Strategy ES announces how many new e-mail messages you have, and gives you the opportunity to have them read to you. By pressing **1**, Strategy ES retrieves and begins reading your e-mail messages using an automated voice.

The order in which they are read to you, is determined by your e-mail service. In most cases, this is in the order in which they were received.

From the Main Menu:

4 Retrieve and Listen to E-mail Messages

- 1 Listen** to e-mail message
- * 1 Replay** the current e-mail message
- 2 Save** the current e-mail message
- 3 Delete** the current e-mail message
- 5 Forward** the current e-mail message
- 6 Reply** to the current e-mail message
- 9 Return** to the Main Menu
- 1 Delete** e-mail messages
- 2 Cancel** deletion of e-mail messages

5453

1. From the Main Menu, press **4**.
2. Press **1** to play your e-mail messages.

The system accesses your e-mail account and prompts you with the number of new e-mail messages you have. The E-mail Message Menu plays.

An e-mail message plays. The system tells you if a attachment(s) is present. Strategy ES can only alert you of the presence of attachments, it cannot administer them in any way.

Play Messages

Retrieve and Listen to E-mail Messages

3. (Optional) While the message plays or immediately after, you can select one of the following:

- 1 Play the next e-mail message
- 2 Save the current e-mail message
- 3 Delete the current e-mail message

- 5 Forward the current e-mail message

Comments can be recorded for this message, which is attached as a standard .wav file to the original message.

Skips to the beginning of the next e-mail message.

Note If you reach the end of your e-mail messages, pressing **9** takes you back to the previous menu.

The e-mail message remains in your e-mail mailbox and the E-Mail Message Menu plays.

Marks the current e-mail message for deletion from your e-mail account. The Listen to E-mail Message Menu plays.

Important! *If you only press **3** and then hang up, the message is not deleted. You must press **9** to exit this menu in order for the deletion to be complete.*

Strategy ES requests address information. After the first destination has been entered, additional destinations can be entered by pressing **4**. The destination user must have a Strategy ES voice mailbox with an e-mail address designated within that mailbox.

If the destination mailbox does not support e-mail, the system informs you that this was an invalid entry. E-mail messages cannot be forwarded to Strategy ES Personal or System Distribution Lists.

Note Check with your System Administrator to see if your mailbox is set up for this feature.

6 Reply to the current e-mail message

Stratagy ES creates an e-mail message with your reply attached as a standard .wav audio file and sent to the originator.

***1** Replay the current e-mail message

The current e-mail message plays from the beginning.

9 Return to Main Menu

Stratagy ES tells you the total number of e-mail messages that will be deleted when you leave this menu, and asks for confirmation.

1 Delete e-mail messages that are marked for deletion

Stratagy ES deletes all the messages you marked for deletion and returns you to the Main Menu.

2 Cancels deletion of e-mail messages marked for deletion

Stratagy ES saves the messages and the E-mail Message Menu plays.

Play Messages

Retrieve and Listen to E-mail Messages

You can record and send a message from any touchtone telephone to another Strategy ES user, several users, or to a personal or system distribution list.

This chapter covers:

- Recording controls
- Send a message
- Forward a message
- Reply to the current message
- Special Delivery options
- Future Delivery
- Send a fax

Recording Controls

While recording a message, you can pause/resume the recording or end the recording using the following keys (shown below).

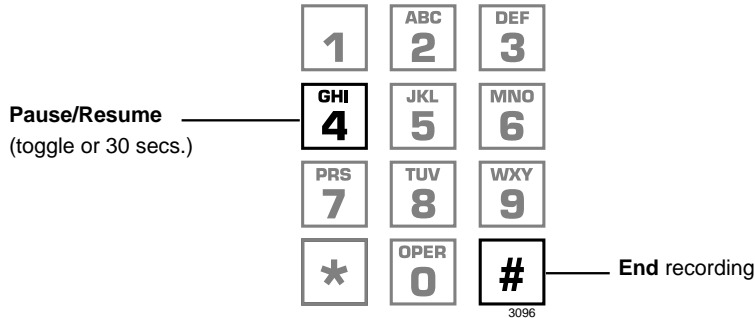

4 Pause/Resume (toggle or 30 seconds)

At any time while recording messages to another mailbox in the system, you can press **4** to pause the recording. The message resumes recording as soon as you press **4**. Strategy ES prompts you with, “Begin recording... (Beep).”

If within a defined amount of time (default is 30 seconds) you do not press **4**, Strategy ES restarts another 30-second pause. If during the second 30-second pause you:

- Do not press any key, Strategy ES assumes you have cancelled the message and returns to the Main Menu.
- Press **#**, Strategy ES returns you to the Send Messages Menu and you can send, review or record over the message.

End Recording

After recording a message, press **#** to end the recording.

Send a Message

Using the Send Messages Menu (shown below), you can record a message and send it to single mailbox or multiple destinations (e.g., personal or system distribution list), forward a message (with a comment), or reply to a message sent you.

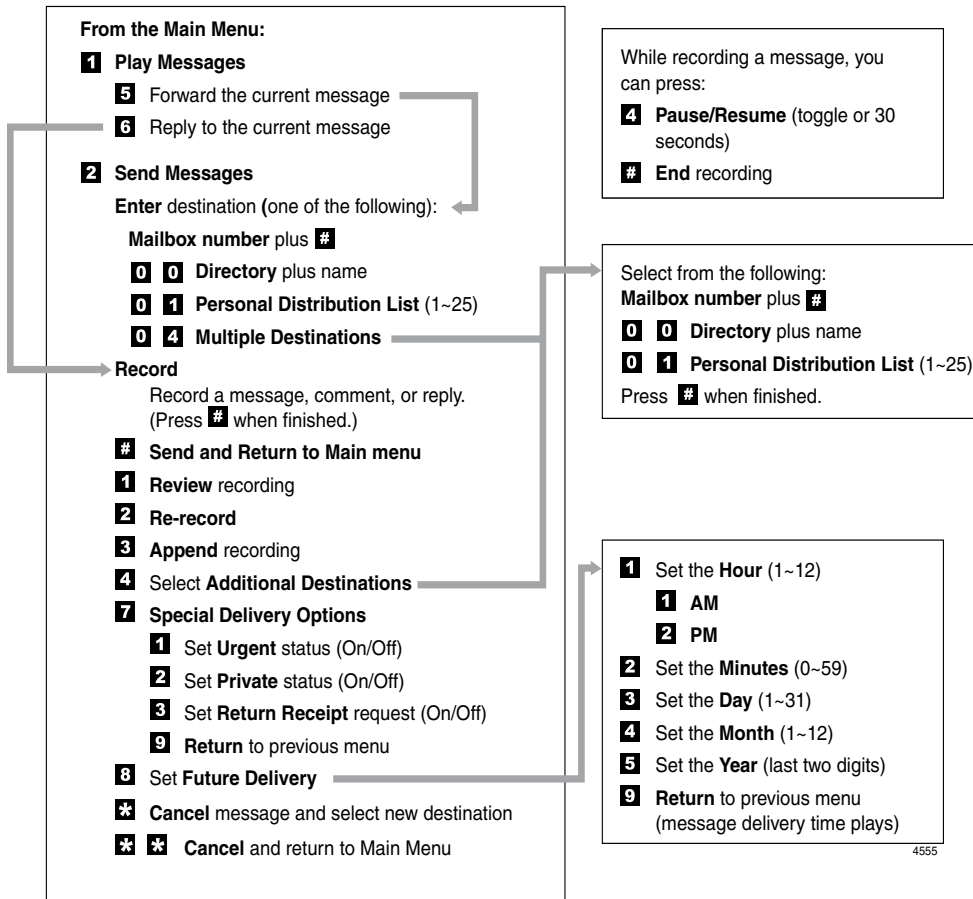

Send Messages

Send a Message

1. From the Main Menu, press **2**.
2. Enter *one* of the following destinations:
Mailbox number plus **#**. Press **#** again to record a message without playing the user's name.

00 Directory plus the first letters (Q=7, Z=9) of the user's first or last name

...or the first letters of a system distribution list name.

Note Entry must be at least three letters long.

Press **#** to select the name as the destination, **1** to hear the next name, or ***** to cancel your entry and re-enter.

Strategy ES prompts you to enter the destination (i.e., mailbox number, Personal or System Distribution List, or Multiple Destinations).

If you entered a user's mailbox number, Strategy ES plays the user's name or mailbox number for confirmation.

If you entered a system distribution list mailbox number, Strategy ES plays the list comment or number for confirmation. Ask your System Administrator for more information about system lists available to you.

Note If your Strategy ES system is designed with a fixed length number for your mailbox number, do not press **#** after entering a mailbox number. See your System Administrator for specific operation of your system.

Strategy ES plays the first match for the combination of letters you entered.

Note See your System Administrator for specific operation of your system.

01 plus a Personal Distribution List number (**1~25**).

04 Multiple Destinations

3. Record a message after the tone. When finished, press **#**.

While recording, you can press **4** to pause/resume (toggle or 30 seconds) the recording.

4. Press **#** again to send the message immediately

...or before sending the message, you can use all of the following options in any combination as often as desired.

1 Review recording

2 Re-record

Press **#** when done.

Strategy ES plays the list comment or number for confirmation. See “[Manage Personal Distribution Lists](#)” on [page 74](#) to create or revise a destination (distribution) list.

You are prompted for the destinations: mailbox number, directory and/or **01** Personal Distribution List.

Note If you forget to enter any destination(s), you can press **4** Additional Destinations after you record your message to add destinations (see [page 42](#)).

Strategy ES tells you that your message has been sent and returns you to the Main Menu.

Important! *If you press **#** to send your message, you cannot use the special recording and sending options.*

The recording plays.

The system prompts you to record at the beep.

Send Messages

Send a Message

3 Append recording
Press **#** when done.

4 Select Additional
Destinations

7 Special Delivery
Options

8 Set Future Delivery

* Cancel message and
select new destination

** Cancel and Return to
the Main Menu

The appended recording plays after the already recorded portion of the message. The system prompts you to record at the beep.

Send the message to additional destinations. (See [Step 2](#) on [page 40](#) for instructions.)

You can send a message as urgent, private, or with a return receipt request. The settings may be used in any combination and may be changed prior to sending the message.

See [“Special Delivery Options”](#) on [page 48](#) for instructions on using this option.

You can have your message delivered at a future specified time and date. See [“Future Delivery”](#) on [page 49](#) for instructions on using this option.

Cancels the message and returns you to [Step 2](#) on [page 40](#).

Cancels the message and returns you to the Main Menu.

Forward a Message

Any message sent to you that is not marked as Private can be forwarded to a single destination or a personal or system distribution list. When forwarding a message, recording a message (comment) is optional.

1. From the Play Messages Menu, press **5**.
2. Enter *one* of the following destinations:
Mailbox number plus **#**. Press **#** again to record a message without playing the user's name.

00 Directory plus the first letters (Q=7, Z=9) of the user's first or last name

...or the first letters of a system distribution list name.

Note Entry must be at least three letters long.

Strategy ES prompts you to enter the destination (i.e., mailbox number, Personal or System Distribution List or Multiple Destinations).

If you entered a user's mailbox number, Strategy ES plays the user's name or mailbox number for confirmation.

If you entered a system distribution list mailbox number, Strategy ES plays the list comment or number for confirmation. Ask your System Administrator for more information about system lists available to you.

Note If your Strategy ES system is designed with a fixed length number for your mailbox number, do not press **#** after entering a mailbox number. See your System Administrator for specific operation of your system.

Strategy ES plays the first match for the combination of letters you entered.

Note See your System Administrator for specific operation of your system.

Send Messages

Forward a Message

Press **#** to select the name as the destination, **1** to hear the next name, or ***** to cancel your entry and re-enter.

01 plus a Personal Distribution List number (**1~25**).

04 Multiple Destinations

3. (Optional) Press **2** to record a message (comment) after the tone. When finished, press **#**.

While recording, you can press **4** to pause/resume (toggle or 30 seconds) the recording.

4. Press **#** again to forward the message immediately

...or before sending the message, you can use any of the following options:

Stratagy ES plays the list comment or number for confirmation. See “[Manage Personal Distribution Lists](#)” on [page 74](#) to create or revise a destination (distribution) list.

You are prompted for the destinations: mailbox number, directory and/or **01** Personal Distribution List.

Note If you forget to enter any destination(s), you can press **4** Additional Destinations after you record your message to add destinations (see [page 45](#)).

Stratagy ES tells you that your message has been forwarded and returns you to the Main Menu.

Important! *If you press **#** to forward your message, you cannot use the special recording and sending options.*

- 1** Review recording
- 2** Re-record
Press **#** when done.
- 3** Append recording
Press **#** when done.
- 4** Select Additional Destinations
- 7** Special Delivery Options
- 8** Set Future Delivery
- * Cancel message and select new destination
- ** Cancel and Return to the Main Menu

The forwarding comment plays.

The system prompts you to record the comment at the beep.

The appended forwarding comment plays after the already recorded message comment. The system prompts you to record at the beep.

Send the forwarded message to additional destinations. (See [Step 2](#) on [page 43](#) for step-by-step instructions.) You may repeat this step as often as necessary.

You can send a message as urgent, private, or with a return receipt request. The settings may be used in any combination and may be changed prior to sending the message.

See “[Special Delivery Options](#)” on [page 48](#) for instructions on using this option.

You can have your message delivered at a future specified time and date. See “[Future Delivery](#)” on [page 49](#) for instructions on using this option.

Cancels the message and returns you to [Step 2](#) on [page 43](#).

Cancels the message and returns you to the Main Menu.

Reply to the Current Message

Strategy ES lets you reply to a message that you are currently playing.

When you reply to a message sent from within a Strategy ES user's mailbox, you do not have to select a destination since Strategy ES "remembers" the source of the message. You can send the reply to additional destinations.

If the message was not recorded from a user's mailbox, you may still reply to the message but you must enter the destination mailbox number.

When the originator(s) receives and plays the reply, he/she hears the prompt, "Reply message from [name or mailbox number]."

1. From the Play Messages Menu, press **6**.
2. (Optional) If the message was not recorded from a user's mailbox, you must enter a destination (see [Step 2](#) on [page 40](#) for instructions).
3. Record your reply after the tone. When finished, press **#**.
While recording, you can press **4** to pause/resume (toggle or 30 seconds) the recording.
4. Press **#** again to send the reply immediately

You are prompted to record your reply to the message.

Strategy ES tells you that your reply has been sent and returns you to the Main Menu.

Important! *If you press # to send your reply you cannot use the special recording and sending options.*

...or before sending the message, you can use any of the following options:

- 1** Review recording
- 2** Re-record
Press **#** when done.
- 3** Append recording
Press **#** when done.
- 4** Select Additional Destinations
- 7** Special Delivery Options
- 8** Set Future Delivery
- *** Cancel reply
- **** Cancel and Return to the Main Menu

The recording plays.

The system prompts you to record at the beep.

The appended recording plays after the already recorded portion of the message. The system prompts you to record at the beep.

Send the message to additional destinations. (See [Step 2](#) on [page 40](#) for instructions.)

You can send a message as urgent, private, or with a return receipt request. The settings may be used in any combination and may be changed prior to sending the message.

See [“Special Delivery Options”](#) on [page 48](#) for instructions on using this option.

You can have your message delivered at a future specified time and date. See [“Future Delivery”](#) on [page 49](#) for instructions on using this option.

Cancels the reply and returns you to [Step 3](#) on [page 46](#).

Cancels the message and returns you to the Main Menu.

Special Delivery Options

You can send a message as urgent, private, or with a return receipt request. The settings may be used in any combination and may be changed prior to sending the message.

When you send, forward or reply to a message, this option is available by pressing **7** Special Delivery Options.

➤ Enter an option number:

1 Set Urgent status
(toggle)

To remove the urgent status, press **7** then **1** again.

2 Set Private status
(toggle)

To remove the private status, press **7** then **2** again.

3 Set Return Receipt request (toggle)

To remove the return receipt request, press **7** then **3** again.

9 Return to previous menu

Urgent messages play first in the New Message Folder.

Private messages cannot be forwarded.

Stratagy ES notifies you when and by whom the message was received and plays the original message.

Only messages that have been deleted, saved, or marked as Pending (if so enabled) by the destination mailbox submit a Return Receipt notification.

Stratagy ES returns you to the previous menu.

Future Delivery

Strategy ES can be configured so that your message is delivered at a future specified time and date. When you send, forward or reply to a message, this option is available by pressing **8** Set Future Delivery.

Since each of the settings default to the current time/date, you do not need to enter all the options. For example, if you have recorded a message and want to have it delivered that afternoon at 2:30 p.m., you only need to enter the hour (2), select p.m. and enter the minutes (30) using options 1 and 2.

After marking the message for future delivery, you can review (play, save, delete) the message at any time before it is sent. See [Chapter 3 – Play Messages](#) for instructions on using the Future Delivery Review option.

➤ Enter an option number and press **#**.

1 Set Hour (**1~12**)

1 AM

2 PM

2 Set Minutes (**0~59**)

3 Set Day (**1~31**)

4 Set Month (**1~12**)

5 Set Year (two or four digits)

9 Return to previous menu

Strategy ES prompts you to select a.m. or p.m.

Two-digit numbers less than the last two digits of the current year are set for the twenty-first century. For example, enter **01** to set 2001.

Strategy ES plays the message delivery time and date and returns you to the previous menu.

Note Once the message has been sent, you can review, continue to send (save), or delete this message using the Future Delivery Review option on the Play Messages Menu. (See [Chapter 3 – Play Messages](#).)

Send a Direct Fax

Stratagy ES enables you to send a fax to a mailbox when you are calling from a fax machine handset.

1. Put the document to be faxed into the fax machine.
2. From the fax machine handset, dial the number for Stratagy ES.
3. Press **988**.
4. Enter the destination mailbox. Finish by pressing **#**.
5. (Optional) Press **1** to record a comment.
Begin recording at the tone.
Finish by pressing **#**.
After recording, you can press:
 - 1** Review comment
 - 2** Re-record
Press **#** when done.
 - 3** Append recording
Press **#** when done.
 - 4** Cancel recording
 - 9** Save recording

The company greeting plays.

The system prompts you to enter the destination mailbox for your fax.

Stratagy ES prompts you to record a comment, enter an additional destination or send the fax.

The system prompts you to record at the beep.

The complete comment plays.

The system prompts you to record at the beep.

The appended comment plays after the already recorded portion. The system prompts you to record at the beep.

The comment is canceled. The system returns to the previous menu.

Stratagy ES tells you that the comment has been recorded and returns to the previous menu.

6. (Optional) Press **4**
Additional Destinations.

Send the message to additional destinations.
(See [Step 2](#) on [page 43](#) for step-by-step
instructions.) You can repeat this step as often as
necessary.

7. Press the **Start** key on the
fax machine and hang up
the handset.

The fax is processed and sent to the destination
mailbox(es).

Send Messages

Send a Direct Fax

Stratagy ES provides special options to customize and manage your mailbox features (menu shown below).

From the Main Menu:

- 3** **Manage Mailbox**
 - 1** Change **Greeting**
 - 2** Change **User Options**
 - 3** Manage **Personal Distribution Lists**
 - 4** Manage **Guest Mailboxes**
 - 5** Manage **Personal Folders**
 - 9** **Return to Main Menu**

4576

Change Greeting

You can select either a personal or system greeting to play callers when you do not answer or when your telephone is busy.

This section discusses the three basic greeting controls (menu shown below):

- Create or record over a personal greeting
- Select a personal greeting
- Review a personal greeting

From the Main Menu:

3 **Manage Mailbox**

From the Manage Mailbox Menu:

1 **Change Greeting**

1 ~ 7 Select a **Personal Greeting**

Select **System Greeting**

1 **Review** selected greeting

2 **Record** (new) greeting

1 **Review** recording

2 **Re-record**

3 **Append** recording

4 **Cancel** recording

9 **Save** recording

9 **Return** to previous menu

***** **Review** current greeting

9 **Return** to previous menu

4550

Create or Record Over a Personal Greeting

Personal greetings should be informative and advise callers when you will be available to return their calls or respond to their messages. You can prerecord greetings for the days of the week when you are out of the office or on vacation. You can update personal greetings as often as you want.

You can record and store up to seven different recorded greetings from which you can select as your personal greeting. The System Administrator can also schedule your greetings to play automatically at different times.

1. From the Manage Mailbox Menu, press **1**.
2. Enter a number from **1~7**.
3. Press **2** to record the greeting (speak slowly and clearly). Press **#** when done.

Stratagy ES plays the Change Greeting options.

Your greeting is identified by the number chosen. For example, you can record a general greeting as greeting 1, then record a greeting for holidays as greeting 2. Later, you can choose which one plays. You can re-record a greeting at any time.

The following information should be included in your Personal Greeting:

- Your name
- Company and/or department
- Date
- Your availability
- Instructions to leave a detailed message
- Call coverage options

Sample Greeting

“Hi. This is Mary Smith of the Toshiba Marketing Department. It is Monday, June 19, and I am in the office today. I am either on the telephone or have stepped away for a few minutes and your call has been forwarded to my voice mailbox. If at the tone you leave a detailed message and a telephone number where I can reach you, I will be happy to return your call.”

Manage Mailbox

Change Greeting

4. (Optional) After recording, you can press:
 - 1** Review recording
 - 2** Re-record
Press **#** when done.
 - 3** Append recording
Press **#** when done.
 - 4** Cancel recording
 - 9** Save recording
5. Press **9** to return to the previous menu.
6. Press **1** and select another greeting number (**1~7**).
7. Repeat [Step 3 on page 55](#) for any additional greetings you want to record.
8. To return to the Main Menu, press **999**.

You can repeat options 1~3 as many times as you wish.

The complete greeting plays.

The system prompts you to record at the beep.

Appending a greeting enables you to add information to the end of your already recorded greeting. The system prompts you to record at the beep.

The greeting is canceled. The system returns to the previous menu.

Strategy ES tells you that greeting (number) has been recorded and returns to the previous menu. Again, you are given the option to review or record over the greeting you have just recorded.

You are given the option to record another greeting.

Important! *The last greeting selected or recorded is the greeting that callers hear as your mailbox greeting.*

Strategy ES plays the Main Menu options.

Select a Personal Greeting

1. From the Manage Mailbox Menu, press 1 .	Strategy ES plays the Change Greeting options.
2. Enter a personal greeting number (1~7) ...or # to select the system greeting.	Your callers hear the selected greeting when you do not answer or when your telephone is busy. Your callers hear the system greeting when you do not answer or when your telephone is busy.
...or * to review the current greeting.	<p>Note If you have recorded a busy greeting, this greeting does not play when your telephone is busy (see “Select Busy Greeting” on page 63 for details).</p> <p>Important! <i>The last greeting selected or recorded is the greeting that callers hear as your mailbox greeting.</i></p>
3. Press 9 to return to the previous menu	The current greeting plays.
...or 99 to return to the Manage Mailbox Menu	Strategy ES returns to the previous menu.
...or 999 to return to the Main Menu.	The Manage Mailbox Menu plays.
	The Main Menu plays.

Review a Personal Greeting

1. From the Manage Mailbox Menu, press 1 .	Strategy ES plays the Change Greeting options.
2. Press * to review the current greeting	The current greeting plays. Strategy ES prompts you with the Change Greeting Menu options.
...or enter a number from 1~7 , then press 1 to review the greeting.	Note Pressing * does not affect the current greeting selection.
3. Press 9 to return to the previous menu	The greeting plays. Strategy ES prompts you with the Change Greeting Menu options.
...or 99 to return to the Manage Mailbox Menu	Strategy ES returns to the previous menu.
...or 999 to return to the Main Menu.	The Manage Mailbox Menu plays.
	The Main Menu plays.

Change User Options

Strategy ES provides a number of special options to improve time management and productivity (menu shown below). For example, the DND feature can provide blocks of time for meetings or projects uninterrupted by the ringing of a telephone.

From the Main Menu:

3 **Manage Mailbox**

From the Manage Mailbox Menu:

2 Change **User Options**

1 Change **Do Not Disturb** (On/Off)

2 Change **Call Screening** (On/Off)

3 Change **Security Code**

4 Select **Busy Greeting** (toggle)

5 Record **Busy Greeting**

6 Record your **Name**

7 Change message **Notification**

8 Set **Automatic Message Copy**

***** Review **Option Settings**

9 **Return** to previous menu

4553

Important!

- *If you do not hear all the options for this menu, they may not be configured for your mailbox or system. Please ask your System Administrator to verify which user options are available to you.*
- *If the DND, Call Screening or busy greeting features do not function after you have enabled them, contact your System Administrator. These features can only operate if Strategy ES performs as the Automated Attendant (AA) and your telephone system or telephone may be performing that function instead.*

Change Do Not Disturb (DND) Setting

If you set this feature to On, Strategy ES automatically sends calls to your mailbox without first ringing your telephone. The System Administrator can also set this feature to turn On or Off automatically at pre-scheduled times and/or days of the week.

1. From the Manage Mailbox Menu, press **2**.
2. Press **1**.
3. (Optional) Press **1** again to reset the feature, if required.
4. Press **9** to return to the Manage Mailbox Menu ...or **99** to return to the Main Menu.

Strategy ES plays the Change User Options Menu.

A prompt verifies the current status (On/Off) of the DND feature.

Important! *DND on the Strategy ES voice processing system is different from the DND features for your telephone system. If your telephone comes with a DND button or feature, it works independently from this feature on Strategy ES.*

Pressing **1** toggles the DND feature On and Off.

You can select another user Manage Mailbox option.

You can select another Main Menu option.

Change Call Screening Setting

If you set this feature to On, Strategy ES asks callers for their name and company. Without the caller's knowledge, the system relays that information to you and provides you with special options to handle the call (menu shown below).

- | |
|----------------------------------------------------------------------------------------------------------------------------------------------------------------------------------------------------------------------------------------------------------------------------------------------------------------------------------------------|
| <ol style="list-style-type: none">1 Receive the call2 Reject the call and let the call forward to your mailbox3 Transfer the call to another extension with an announcement4 Transfer the call to another extension without an announcement |
|----------------------------------------------------------------------------------------------------------------------------------------------------------------------------------------------------------------------------------------------------------------------------------------------------------------------------------------------|

The System Administrator can also set this feature to turn On or Off automatically at pre-scheduled times and/or days of the week.

- | | |
|----------------------------------------------------------------------------------------------------------------------------------------------------------------------------------------------------------------------------------------------------------------------------------------------------------------------|------------------------------------------------------------------------------------------------------------------------------------------------------------------------------------------------------------------------------------------------------------------------------------------------------------------------------|
| <ol style="list-style-type: none">1. From the Manage Mailbox Menu, press 2.2. Press 2.3. (Optional) Press 2 again to reset the feature, if required.4. Press 9 to return to the Manage Mailbox Menu ...or 99 to return to the Main Menu. | <p>Strategy ES plays the Change User Options Menu.</p> <p>A prompt verifies the current status (On/Off) of the Call Screening feature.</p> <p>Pressing 2 toggles the Call Screening feature On and Off.</p> <p>You can select another user Manage Mailbox option.</p> <p>You can select another Main Menu option.</p> |
|----------------------------------------------------------------------------------------------------------------------------------------------------------------------------------------------------------------------------------------------------------------------------------------------------------------------|------------------------------------------------------------------------------------------------------------------------------------------------------------------------------------------------------------------------------------------------------------------------------------------------------------------------------|

Change Security Code

Each mailbox in the system has a security code. The code must be entered by you in order to “log on” to your mailbox, enabling you to access your messages, settings, greetings, etc.

Note You can change your security code as often as you wish to ensure the privacy of your messages and personal greetings.

1. From the Manage Mailbox Menu, press 2 .	Stratagy ES plays the Change User Options Menu.
2. Press 3 .	Stratagy ES prompts you to enter your new security code and notifies you of the number of allowable digits. For example, Stratagy ES might prompt “the new security code must have at least 3 digits and 16 maximum digits” or “the new security code must be exactly 4 digits.”
3. Enter your new security code + # .	Stratagy ES prompts you to re-enter your new security code for verification.
4. Re-enter your new security code + # .	After entering the security code a second time, Stratagy ES announces that your security code has been changed.

Select Busy Greeting

-
- | | |
|---------------------------------------------------------------------------------------------------------------------------------------------------------------------------------------------------------------------------------------------------------------------------------------------------------------------------|--------------------------------------------------------------------------------------------------------------------------------------------------------------------------------------------------------------------------------------------------------------------------------------------------------------------------------------------------------------------------------------------------------------------------------------------------------------------------------------------------------------------------------------|
| <ol style="list-style-type: none">1. From the Manage Mailbox Menu, press 2.2. Press 4.3. (Optional) Press 4 again to reset the feature, if required.
4. Press 9 to return to the Manage Mailbox Menu ...or 99 to return to the Main Menu. | <p>Stratagy ES plays the Change User Options Menu.</p> <p>A prompt verifies the current status (custom/system) of the Busy Greeting feature.</p> <p>Pressing 4 toggles between selecting your custom busy greeting and the system busy greeting.</p> <p>Note The custom busy greeting must be recorded before it can be selected (see “Create or Record Over Busy Greeting” on page 64).</p> <p>You can select another user Manage Mailbox option.</p> <p>You can select another Main Menu option.</p> |
|---------------------------------------------------------------------------------------------------------------------------------------------------------------------------------------------------------------------------------------------------------------------------------------------------------------------------|--------------------------------------------------------------------------------------------------------------------------------------------------------------------------------------------------------------------------------------------------------------------------------------------------------------------------------------------------------------------------------------------------------------------------------------------------------------------------------------------------------------------------------------|

Create or Record Over Busy Greeting

You can record your own custom busy greeting (menu shown below) that plays when callers reach your extension and it is busy. While your callers are listening to the busy greeting, they can enter a different mailbox number, press * to hold (if configured for your mailbox by the System Administrator), or remain on the line to leave a message.

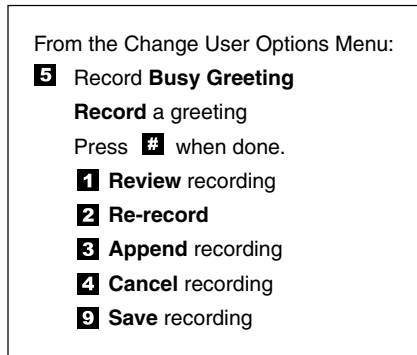

4556

Note Depending on the configuration of your telephone and telephone system, Strategy ES may not receive a busy tone when callers reach your extension. If Strategy ES doesn't receive a busy tone, your selected personal greeting plays instead.

If a custom greeting is not recorded, the default system busy greeting plays.

<ol style="list-style-type: none">1. From the Manage Mailbox Menu, press 2.2. Press 5.3. Begin recording at the tone. Press # when done.4. (Optional) After recording, you can press:<ol style="list-style-type: none">1 Review greeting2 Re-record Begin recording at the tone. Press # when done.3 Append recording Begin recording at the tone. Press # when done.4 Cancel recording9 Save recording5. Press 9 to return to the Manage Mailbox Menu ...or 99 to return to the Main Menu.	<p>Strategy ES plays the Change User Options Menu.</p> <p>Strategy ES prompts you to record your custom busy greeting.</p> <p>Sample Greeting: “Thanks for calling. I’m currently on the phone. If you would like to hold, press star, or you can leave me a message after the tone.”</p> <p>The complete greeting plays. The system prompts you to record at the beep.</p> <p>The appended greeting plays after the already recorded portion of the greeting. The system prompts you to record at the beep.</p> <p>The greeting is canceled. The system returns to the previous menu. Strategy ES tells you that the greeting has been recorded and returns to the previous menu. You can select another user Manage Mailbox option. You can select another Main Menu option.</p>
-----------------------------------------------------------------------------------------------------------------------------------------------------------------------------------------------------------------------------------------------------------------------------------------------------------------------------------------------------------------------------------------------------------------------------------------------------------------------------------------------------------------------------------------------------------------------------------------------------------------------------------------------------------------------------------------------------------	--------------------------------------------------------------------------------------------------------------------------------------------------------------------------------------------------------------------------------------------------------------------------------------------------------------------------------------------------------------------------------------------------------------------------------------------------------------------------------------------------------------------------------------------------------------------------------------------------------------------------------------------------------------------------------------------------------------------------------------------------------------------------------------------------------

Record Your Name

Your name is announced whenever the directory is accessed, you select the system greeting, or a message is sent by another Strategy ES user.

Strategy ES prompts you through the entire recording sequence (menu shown below). You can re-record your name at any time simply by repeating these steps.

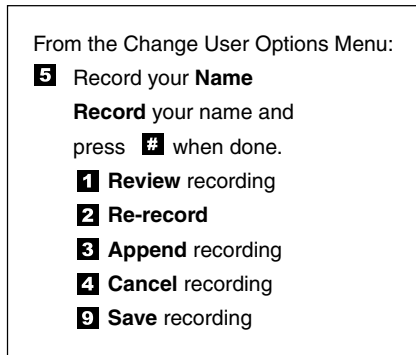

4557

Note Some Strategy ES systems may not be configured to play your name when you log on to your mailbox.

1. From the Manage Mailbox Menu, press **2**.
2. Press **6**.
3. At the tone, state your name slowly and clearly.
Press **#** when done.
4. (Optional) After recording, you can press:
 - 1** Review recording
 - 2** Re-record
Press **#** when done.
 - 3** Append recording
Press **#** when done.
 - 4** Cancel recording
 - 9** Save recording

Strategy ES plays the Change User Options Menu.

Strategy ES prompts you to record your name.

Your newly recorded name plays.

You can re-record your name as often as you wish.

You can add a short comment that plays at the end of the recording (for example, a vacation announcement).

You can cancel your newly recorded name (and extension) and return to the previous menu.

Strategy ES confirms that your name has been recorded. Strategy ES returns to the previous menu.

When your mailbox is accessed, you can select either the system or personal greeting to play.

See [Chapter 5 – Manage Mailbox](#) for instructions on selecting and creating greetings.

Change Message Notification

Your mailbox can have notification records programmed by the System Administrator with a specific notification method (message waiting lights, pagers, voice, etc.) and the time/day when that notification record applies. The repeat count (how many times the notification is attempted) and interval for retrying the notification is also set.

Once you have enabled a notification record by entering the template number (menu shown below), Strategy ES automatically performs the chosen notification method.

The Strategy ES enables you to change digits that a notification may use in an attempt to notify you of a message. These digits could be the number where you can be reached, your paging service, or the number that displays in a digital pager's LCD screen. It depends on how the notification event has been programmed.

From the Change User Options Menu:

- 7** Change message **Notification**
Enter notification template number
or enter **0 0** for a list of templates
- 1** **Enable/Disable** notification template
(toggle)
- 2** **Change** notification digits
- #** **Save** changes
- 9** **Return** to previous menu

4558

1. From the Manage Mailbox Menu, press 2 .	Strategy ES plays the Change User Options Menu.
2. Press 7 .	You are told the number of notification records you have and are prompted to enter the notification record number.
3. Enter the notification template number	Strategy ES confirms the template number, either speaks or spells the template title, states whether the template is enabled or disabled, and tells you the phone number (if applicable).

...or if you do not remember the template number you want, press **00**.

Press **#** to select the notification template or **1** to hear the next record.

4. Press an option number:

1 Enable/disable notification template (toggle)

2 Change notification digits

Enter the new notification digits and press **#**.

Save changes

9 Return to previous menu

5. Press **9** to return to the Manage Mailbox Menu
...or **99** to return to the Main Menu.

The system plays a template header record for each notification template consisting of the template number and title (e.g., CTX message light on). After each header record plays, you are asked to select the record or hear the next record.

Pressing **1** toggles the notification template between Enable and Disable. After pressing **1**, a prompt verifies the current status.

Strategy ES verifies the number entered.

Strategy ES tells you that the notification template changes have been recorded. Strategy ES returns to the previous menu.

Strategy ES cancels the change message notification options and returns to the previous menu.

You can select another user Manage Mailbox option.

You can select another Main Menu option.

Set Automatic Message Copy

When enabled, the Automatic Message Copy feature (menu shown below) automatically copies messages from your mailbox to a designated mailbox.

You can choose to copy all your messages or only the messages marked urgent, designate the mailbox destination for the copies, and set the time of day for copying the messages that arrive at your mailbox. You can also set a time delay, if one is needed.

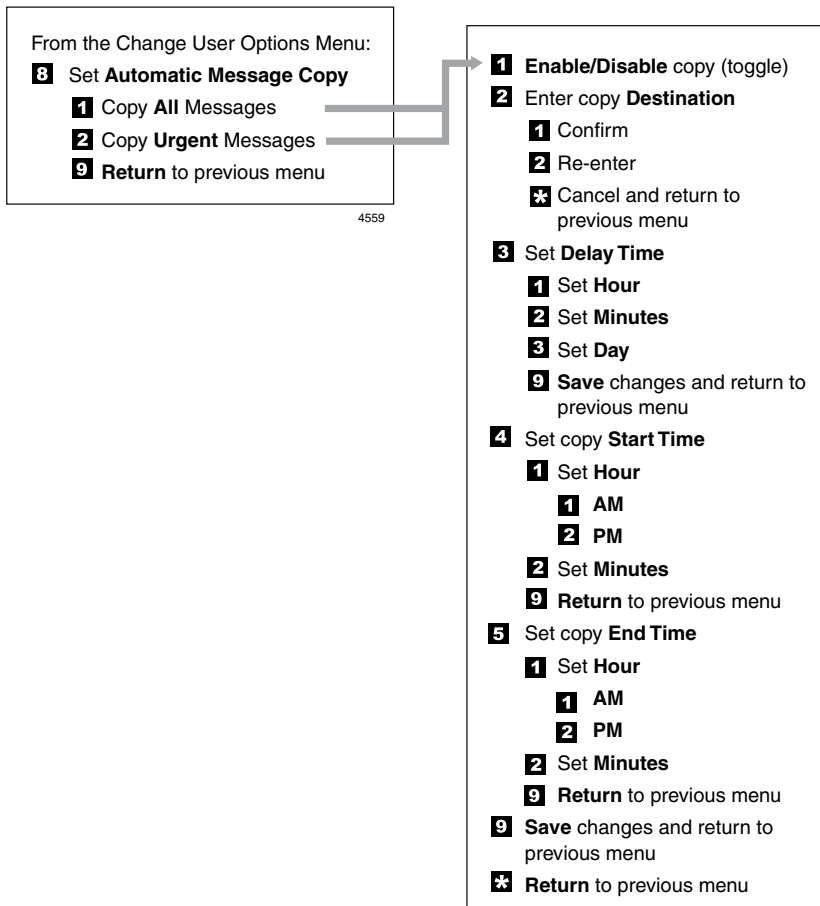

<p>1. From the Manage Mailbox Menu, press 2.</p> <p>2. Press 8.</p> <p>3. Press 1 to copy all messages</p> <p> ...or 2 to copy only urgent messages</p> <p> ...or 9 to return to previous menu.</p> <p>4. (Optional) You can select all of the following options in any combination:</p> <p> 1 Enable/Disable (toggle)</p> <p> 2 Enter message destination</p> <p> Press 1 to confirm the number, 2 to erase and re-enter, or * to cancel and return to previous menu.</p>	<p>Stratagy ES plays the Change User Options Menu.</p> <p>Stratagy ES plays the Automatic Message Copy Menu.</p> <p>Stratagy ES confirms the automatic message copy for all messages is enabled/disabled, the mailbox where the message will be copied, delay time, and auto copying starting/ending times.</p> <p>Stratagy ES confirms the automatic message copy for urgent messages is enabled/disabled, the mailbox where the message will be copied, delay time, and auto copying starting/ending times.</p> <p>Stratagy ES returns to the previous menu.</p> <p>Pressing 1 toggles the message copy feature On/Off.</p> <p>A prompt verifies the mailbox number and prompts you for an entry of 1, 2 or *.</p> <p>Pressing 1 saves the mailbox number.</p>
---------------------------------------------------------------------------------------------------------------------------------------------------------------------------------------------------------------------------------------------------------------------------------------------------------------------------------------------------------------------------------------------------------------------------------------------------------------------------------------------------------------------------------------------------------------------	-----------------------------------------------------------------------------------------------------------------------------------------------------------------------------------------------------------------------------------------------------------------------------------------------------------------------------------------------------------------------------------------------------------------------------------------------------------------------------------------------------------------------------------------------------------------------------------------------------------------------------------------------------------------------------------------------------------------------------------------------------------------------------------------------------

Manage Mailbox

Change User Options

3 Set delay time

Select *one* of the following:

1 Set hour

2 Set minutes

3 Set day

9 Returns to previous menu

4 Set Copy Start Time.

Enter an option number and press **#**.

1 Set Hour (**1~12**)

1 AM

2 PM

2 Set Minutes (**0~59**)

5 Set Copy End Time.

Enter an option number and press **#**.

1 Set Hour (**1~12**)

1 AM

2 PM

2 Set Minutes (**0~59**)

Strategy ES prompts you to enter the time.

Only one of the following entries are allowed.

System prompts for number of hours to delay message (maximum is 24 hours). Once you have entered the value, Strategy ES saves the entry and returns to the previous menu.

System prompts for number of minutes to delay message (maximum is 60 minutes). Once you have entered the value, Strategy ES saves the entry and returns to the previous menu.

System prompts for number of days to delay message (maximum is 25 days). Once you have entered the value, Strategy ES saves the entry and returns to the previous menu.

Saves current entry and returns to the auto copy message.

Strategy ES prompts you to enter the time.

Strategy ES prompts you to select AM or PM.

Strategy ES prompts you to enter the time.

Strategy ES prompts you to select AM or PM.

- | | |
|------------------------------------------------------------------------------------------------------------------------------------------------------------------------------------------------------------------------|----------------------------------------------------------------------------------------------------------------------------------------------------------------------------------------------------------------------------------------|
| <p>9 Saves changes and returns to previous menu.</p> <p>* Cancel changes and returns to previous menu.</p> <p>9 Return to the Manage Mailbox Menu
...or 99 to return to Main Menu.</p> | <p>Saves the changes and returns to the auto copy message.</p> <p> Cancels changes and returns to the auto copy message.</p> <p>You can select another user Manage Mailbox option.</p> <p>You can select another Main Menu option.</p> |
|------------------------------------------------------------------------------------------------------------------------------------------------------------------------------------------------------------------------|----------------------------------------------------------------------------------------------------------------------------------------------------------------------------------------------------------------------------------------|

Review Option Settings

- | | |
|--------------------------------------------------------------------------------------------------------------------------------------------------------------------------------------------------------------------------------|------------------------------------------------------------------------------------------------------------------------------------------------------------------------------------------------------------------------------------------------------------------------------------------------------|
| <p>1. From the Manage Mailbox Menu, press 2.</p> <p>2. Press * to Review your Option Settings.</p> <p>3. Press 9 to return to the Manage Mailbox Menu
...or 99 to return to the Main Menu.</p> | <p>Strategy ES plays the Change User Options Menu.</p> <p>Strategy ES verifies the status of your DND, Call Screening options and plays your selected busy message and name recording.</p> <p>You can select another user Manage Mailbox option.</p> <p>You can select another Main Menu option.</p> |
|--------------------------------------------------------------------------------------------------------------------------------------------------------------------------------------------------------------------------------|------------------------------------------------------------------------------------------------------------------------------------------------------------------------------------------------------------------------------------------------------------------------------------------------------|

Manage Personal Distribution Lists

The Manage Personal Distribution Lists feature enables you to create and manage up to 25 personal distribution lists. The lists consist of the mailboxes to which you most frequently send messages.

At the time you create a list, you are given the option of recording a “list comment” that serves as the title or name for the list. The comment plays each time you use the list to confirm that you have chosen the correct distribution list.

From the Manage Personal Distribution Lists Menu (shown below), you can review the list contents, add and delete mailboxes to the list, and record a list comment.

From the Main Menu:

- 3** Manage Mailbox

From the Manage Mailbox Menu:

- 3** Manage Personal **Distribution Lists**

Select **1**–**25** for a Personal Distribution Lists

- 1** Review current list
- 2** Add a mailbox to the list
- 3** Delete a mailbox from the list
- 4** Record a list **Comment**
- 9** Return to previous menu
- *** Return to previous menu

<ol style="list-style-type: none">1. From the Manage Mailbox Menu, press 3.2. Select the desired list number 1~25.3. After selecting a list, you can press:<ul style="list-style-type: none">1 Review your current list2 Add a Mailbox to the list	<p>Strategy ES plays the Manage Personal Lists options.</p> <p>The system prompts you with the name (and extension) of each mailbox on the list.</p> <p>Strategy ES prompts you to enter the mailbox number.</p>
---------------------------------------------------------------------------------------------------------------------------------------------------------------------------------------------------------------------------------------------------------------------------------------------------------------------------------------	------------------------------------------------------------------------------------------------------------------------------------------------------------------------------------------------------------------

Enter the mailbox number or press **00** for Strategy ES directory assistance. Press **#** when done.

- 3** Delete a Mailbox from the list

Enter the mailbox number or press **00** for Strategy ES directory assistance. Press **#** when done.

- 4** Record a list Comment

Record your comment. Press **#** when done.

(Optional) After recording, you can press **1** to review recording, **2** to rerecord, **3** to append the recording, **4** to cancel the recording or **9** to save the recording and return to the previous menu.

- 4. Press ***** to return to the previous menu
 - ...or ***9** to return to the Manage Mailbox Menu
 - ...or ***99** to return to the Main Menu.

The name (and extension) plays. You can add additional mailbox numbers as needed.

Strategy ES prompts you to enter the mailbox number.

The name (and extension) plays. The system prompts "Deleted."

When sending a message, the comment plays each time the destination list is selected.

Strategy ES prompts you to record the comment.

Strategy ES returns to the previous menu.

You can select another Manage Mailbox option.

You can select another Main Menu option.

Manage Guest Mailboxes

Guest mailboxes provide limited access to the Strategy ES system for temporary and project-oriented employees, such as consultants and contractors. Guest users may only send and receive messages to their host and other guests that share the same host mailbox.

The Guest mailboxes are selected from a system-generated list and assigned on a per-use basis. See your System Administrator for details if you have this feature.

Managing guest mailboxes entails creating and deleting guest mailboxes and resetting a guest password (menu shown below).

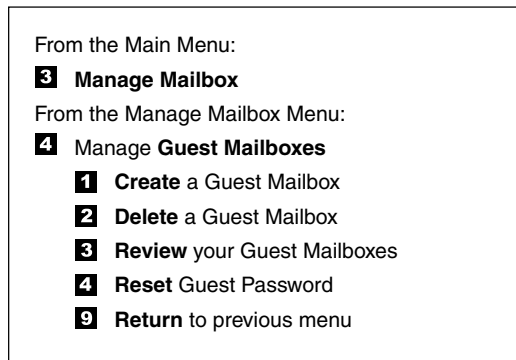

1. From the Manage Mailbox Menu, press **4**.
 2. Select *one* of the following:
 - 1** Create a Guest Mailbox
 - 2** Delete a Guest Mailbox
- Enter the mailbox number. Press **#** when done.

Strategy ES plays the Manage Guest Mailboxes options.

The system prompts with a Guest Mailbox number. Be sure to make a note of the number and the person you assign.

Strategy ES prompts you to enter the mailbox number.

The system confirms the Guest Mailbox is deleted.

3 Review your Guest Mailboxes

4 Reset Guest Password

Enter the mailbox number.

3. Press **9** to return to the Manage Mailbox Menu
...or **99** to return to the Main Menu.

The system lists your Guest Mailbox numbers.

Strategy ES prompts you to enter the mailbox number.

Strategy ES resets the password for the guest mailbox.

You can select another user Manage Mailbox option.

You can select another Main Menu option.

Use Guest Mailboxes

A guest user can access his/her mailbox in the same manner as a regular Strategy ES user. The guest can play and send messages but is denied access to all Manage Mailbox Menu features except “**3** Change Security Code” and “**6** Record your Name.”

Note See “[Access Your Mailbox](#)” on [page 18](#) for instructions on accessing the guest mailbox.

Manage Personal Folders

Your messages can reside in up to nine folders—one new, one saved and seven personal folders created by you for the purpose of saving your messages. The personal folders are for only your use.

At the time you create a folder, you are given the option of recording a “name/comment” that serves as the title or name for the folder (menu shown below). The comment plays each time you use the folder to confirm that you have chosen the correct one.

When you access your mailbox, Strategy ES announces that you have “x number of new messages and x number of saved messages.” When you press **2** from the Play Messages menu to save a message, Strategy ES plays the folder number and the recorded name/comment of each of the available folders.

You are requested to enter a valid folder number where you want the message saved. If an invalid number is entered, Strategy ES automatically saves the message in folder **1** (i.e., standard save folder).

From the Main Menu:

3 **Manage Mailbox**

From the Manage Mailbox Menu:

5 **Manage Personal Folders**

Select **2-8** for a Personal Folder

1 **Review** folder name/comment

2 Record folder name/comment

1 **Review** recording

2 **Re-record** a folder **Comment**

3 **Append** a folder **Comment**

4 **Cancel** recording

9 **Save** recording and return to previous menu

9 **Return** to previous menu

<ol style="list-style-type: none">1. From the Manage Mailbox Menu, press 5.2. Enter a number from 2~8.3. After selecting a folder, you can press:<ol style="list-style-type: none">1 Review folder name/comment2 Record the name and comment At the tone, state the folder name and comment slowly and clearly. Press # when done.4. (Optional) After recording, you can press:<ol style="list-style-type: none">1 Review recording2 Re-record Press # when done.3 Append recording Press # when done.4 Cancel recording9 Save recording	<p>Strategy ES plays the Manage Personal Folders options.</p> <p>Number 1 is reserved for the standard save folder and cannot be used.</p> <p>The system plays the folder name and comment.</p> <p>The newly recorded folder name/comment plays.</p> <p>You can re-record the folder name/comment as often as you wish.</p> <p>You can add a short comment that plays at the end of the original comment.</p> <p>You can cancel your newly recorded folder name/comment and return to the previous menu.</p> <p>Strategy ES confirms that the folder name/comment has been recorded. Strategy ES returns to the Manage Personal Folders menu.</p>
------------------------------------------------------------------------------------------------------------------------------------------------------------------------------------------------------------------------------------------------------------------------------------------------------------------------------------------------------------------------------------------------------------------------------------------------------------------------------------------------------------------------------------------------------------------------------------------------------------------------------------------------------------------------------------------------------------------------------------------------------------	---------------------------------------------------------------------------------------------------------------------------------------------------------------------------------------------------------------------------------------------------------------------------------------------------------------------------------------------------------------------------------------------------------------------------------------------------------------------------------------------------------------------------------------------------------------------------------------------------------------------------------------------------

Manage Mailbox

Manage Personal Folders

5. Press **9** to return to the previous menu
...or **99** to return to the Manage Mailbox Menu
...or **999** to return to the Main Menu.

Strategy ES returns to the previous menu.

You can select another Manage Mailbox option.

You can select another Main Menu option.

Using Strategy ES with a Strata CTX

A

This appendix covers the use of Strategy ES voice mail with the Strata CTX. Call Forward, Message Waiting, Toshiba Proprietary Integration, Direct Transfer to Voice Mail and Voice Mail Conference features are all described.

Note Check with your System Administrator about your company's phone system and telephones.

Call Forward

Note See *Strata CTX 3000/2000-series Telephone User Guide* for additional information on programming and using this feature on your phone.

There are two types of Call Forwarding: System and Station.

- System Call Forward (which is set in Programming) automatically directs calls to a predefined location, such as Voice Mail.
- Station Call Forward enables you to assign Call Forward destinations for each extension on your phone. Each extension can be independently set for a different Call Forward feature. You can set a flexible button to perform any Call Forward function.

Call Forward must be set prior to receiving the call.

Note Station Call Forward takes priority over System Call Forward.

[Table 1](#) on [page 82](#) contains the Call Forward Button sequences for performing Call Forward. There are two ways to perform each Call Forward function. One, enter the button sequence as described, or two, program a flexible button to perform the sequence.

► To use the Call Forward button sequence

- Follow the instructions in [Table 1](#) below shown under “Button Sequence.” Some features require additional input, such as:
 - **Destination** – If the destination is an outside number, press # after entering the destination. The CTX accepts destination numbers of up to 32 digits.
 - **Timer** – This is a two digit entry representing how long (8 to 160 seconds) your telephone should ring before forwarding the call. If you enter one digit, you must press # after entering the single digit.

Also, in the following table, (Tone) means that a confirmation tone plays at that point in the sequence.

Table 1 Call Forward Procedures

Feature	Button Sequence
Call Forward - Station	
Call Forward Any Call (Internal and Incoming Line)	
All Call	Press Extension button + #6011 (Tone) + Destination No. (Tone)
Busy	Press Extension button + #6021 (Tone) + Dest. No. (Tone)
No Answer	Press Extension button + #6031 (Tone) + Dest. No. (Tone) + Timer + #
Busy No Answer	Press Extension button + #6041 + Dest. No. + Timer + #
Cancel	Press Extension button + #6051 (Tone)
Call Forward - System	
Call Forward - Incoming Line Calls	
All Calls	Extension button + #6013 (Tone) + Dest. No. (Tone)
Busy	Extension button + #6023 (Tone) + Dest. No. (Tone)
No Answer	Extension button + #6033 + Dest. No. (Tone) + Timer (Tone) + #
Busy No Answer	Extension button + #6043 + Dest. No. (Tone) + Timer (Tone) + #
Cancel	Extension button + #6053 (Tone)
Call Forward - System	
Activate	#620 (Tone)
Cancel	#621 (Tone)

Message Waiting

Use your **Msg** LED/button and LCD to see/retrieve message(s).

An extension can receive up to four simultaneous Message Waiting indications and LCD messages. One message is reserved for the Message Center.

Your phone can be programmed to have up to four additional (flexible) Message Waiting buttons/LEDs. Ask if these buttons have been programmed on your phone. If so, substitute them when the **Msg** button/LED is mentioned in the following steps.

Responding to a Lit Msg LED

1. On an LCD phone, if you see a “+” press **Scroll** to display additional messages; otherwise, go to Step 2. The “+” indicates additional messages. The LCD can show up to three station messages for your extension and three for each additional (phantom) extension that you may have.
2. Press **Msg**, then lift the handset. Your phone rings the extension or voice mail device that sent the indication. The LED continues to flash red.
3. After answering the message(s), place the handset back on-hook.
4. If the Msg LED continues to flash, you have more messages; repeat Steps 1~3 above to retrieve them. Voice mail devices turn off the LED/LCD indications after a short delay, after you checked all messages.
5. To manually turn off your Msg LED, press your extension button, then press **#409**. Do this step for each message received.

Turning On/Off Message Waiting LED on Another Extension

If you call an extension and it's busy or there is no answer, you can light that extension's Message Waiting LED and enable that extension to call you back.

1. Dial an internal extension. You hear busy tone or there's no answer.
2. Press **Msg** or **7**. The Msg LED flashes red on the called phone. At your phone, the Msg LED lights steady red and the LCD shows the station number where you set a Message Waiting light.
3. Press **Spkr**. Your Msg LED turns Off. The Msg LED on the called telephone flashes until the called party presses the flashing **Msg** button - which calls you back.
4. To turn Off a Message LED that you have set on another extension, press **#64** plus the extension number that has the message light set. Then hang up to release your telephone.

Toshiba Proprietary Integration

If your company's Toshiba Strata CTX phone system has the Proprietary Integration with your Strategy ES enabled, you have two additional features at your disposal—Soft Key Control of Voice Mail and Call Record to Voice Mail. If you cannot access these features, check with your System Administrator.

Soft Key Control of Voice Mail

If you have a Strata 3000 or 2000-series digital phone equipped with a Liquid Crystal Display (LCD), many standard functions of the Strategy ES voice mail system can be displayed on the digital telephone LCD and operated by Soft Keys. Feature prompting makes voice mail functions easy to use via visual displays on the telephone in place of listening to voice prompts over the handset, although the Strategy ES voice prompts still play when soft keys are used.

Note For general information on using Soft Keys on your phone, please see the *Strata CTX DKT3000/2000-Series Telephone User Guide*.

When your telephone is idle, and a message arrives for an extension on your phone, the Msg LED is activated for the appropriate extension and updates the LCD with this display (shown right). If urgent messages are in the extension's mailbox, the SAVED display is replaced with the number of URGENT messages.

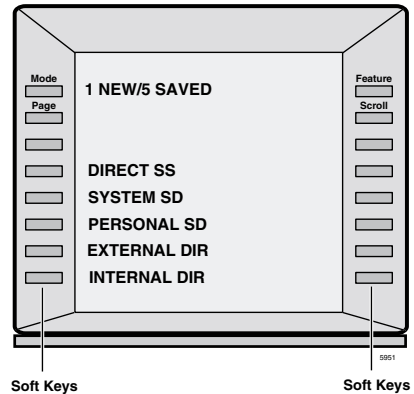

Once connected to your Strategy ES voice mailbox, the LCD displays the Strategy ES Main Menu options (shown at right). See [Table 2](#) on [page 86](#) below for a list of Main Menu soft keys.

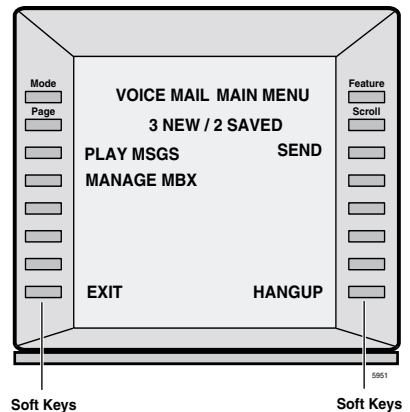

You are then able to perform many of the standard Strategy ES voice mail functions using the Soft Keys on your phone (Play Messages menu example shown at right). See [Table 3](#) on [page 86](#) for a list of Soft Keys.

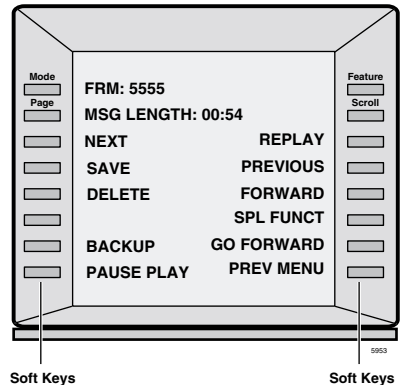

Table 2 Strategy ES Main Menu Soft Keys for CTX Digital Telephones

DKT 3014 SDL	DKT 3010 SD DKT 3020 SD	DKT 2010 SD DKT 2020 SD	Voice Mail Functions
PLAY MSGS	PLAY	PLAY	Play Messages
SEND	SEND	SEND	Send Messages
MANAGE MBX	MGMT	MGMT	Manage Mailbox
EXIT			Exit Mailbox
HANGUP	QUIT		Disconnect from Strategy ES

Table 3 Soft Keys for CTX Digital Telephones

DKT 3014 SDL	DKT 3010 SD DKT 3020 SD	DKT 2010 SD DKT 2020 SD	Voice Mail Functions
ACCEPT			Confirm automatic copy destination
ADD	ADD	ADD	Create a Guest Mailbox
ADD DESTS			Additional Destinations
ADD MBX	ADD	ADD	Add a mailbox to the list
ALL MSGS			Copy All Messages
AM?			AM
APPEND	APND		Append recording
AUTO COPY			Set Automatic Msg Copy
BACK UP			Backup (rewind)
BSY GRT REC			Record Busy Greeting
BUSY GREET			Select Busy Greeting (toggle)
CALL SCREEN			Change Call Screening (On/Off)
CANCEL			Cancel recording
CANCEL MSG	CANC	CNCL	Cancel message and select new destination
CHANGE			Change notification digits
CHG GREETING	GRT	GRT	Change Greeting

Table 3 Soft Keys for CTX Digital Telephones (*continued*)

DKT 3014 SDL	DKT 3010 SD DKT 3020 SD	DKT 2010 SD DKT 2020 SD	Voice Mail Functions
CONT DELETE			Continuous Delete
CONT PLAY			Continuous Play
DATE & TIME	DATE		Message Date and Time
DELAY TIME			Set Delay Time
DELETE	DEL	DEL	Delete the message/guest mailbox
DELETE MBX	DEL	DEL	Delete a mailbox from the personal distribution list
DELETE MSG			Delete message (Future Delivery Review)
DESTINATION			Enter automatic copy destination
DIRECTORY	DIR	DIR	Directory plus name
DND	DND	DND	Change Do Not Disturb (On/Off)
ENABLE/ DISABLE			Enable/Disable: <ul style="list-style-type: none"> • Notification template (toggle) • Automatic copy
END TIME			Set copy End Time
FOLDERS	FLDR		New/Saved message folder
FORWARD	FWD	FWD	Forward the current message
FUTURE DLVR			Set Future Delivery, Future Delivery Review
GO FORWARD			Go forward (advance)
GUEST MBXES	GST	GST	Manage Guest Mailboxes
IMM ALL FAX	SNDN		Immediate Fax (all faxes in folder)
IMM THS FAX	SND1		Immediate Fax (current fax doc)
MARK PRIVAT	PRV	PRV	Set Private status (On/Off)
MARK URGENT	URG	URG	Set Urgent status (On/Off)

Table 3 Soft Keys for CTX Digital Telephones *(continued)*

DKT 3014 SDL	DKT 3010 SD DKT 3020 SD	DKT 2010 SD DKT 2020 SD	Voice Mail Functions
MSG FOLDERS	FLDR	FLDR	Manage Personal Folders
MSG NOTIFY			Change message Notification
MULTI ENTRY	MULTI	MULTI	Multiple Destinations
NAME RECORD	NAME	NAME	Record your Name
NEXT	NEXT	NEXT	Play next message
NEXT MSG			Play next message (Future Delivery Review)
NEXT NAME	NEXT	NEXT	Play next name
PAUSE	PAUS	PAUS	Pause recording
PAUSE PLAY			Pause playback
PER DST LST	LIST	LIST	Manage Personal Distribution Lists
PERSONAL LIST	LIST	LIST	Personal distribution list (1~25)
PM?			PM
PREVIOUS			Play the Previous message
PREV MENU	PREV		Return to previous menu
REC COMMENT	COMM	COMM	Record a list Comment
RECORD	REC	REC	Record
REENTER			Re-enter automatic copy destination
REENTER NAM	REDO	REDO	Re-enter name or Exit
REPLAY			Replay current message
REPLY	RPLY	RPLY	Reply to the current message
RE RECORD	RREC	RREC	Re-record

Table 3 Soft Keys for CTX Digital Telephones (*continued*)

DKT 3014 SDL	DKT 3010 SD DKT 3020 SD	DKT 2010 SD DKT 2020 SD	Voice Mail Functions
RESET PWORD	RSET	RSET	Reset Guest Password
RETRN RECPT	RTRC	RTRC	Set Return Receipt request (On/Off)
REVIEW	REVV	REVV	Review recording/guest mailboxes
REVIEW LIST	REVV	REVV	Review current list
REV OPTIONS			Review Option Settings
SAVE	SAVE	SAVE	Save the message/recording/changes
SAVE MSG			Save message (Future Delivery Review)
SECURITY COD	CODE	CODE	Change Security Code
SELECT NAME	PICK	PICK	Select name
SEND MSG	SEND	SEND	Send and Return to Main menu
SET DAY			Set the Day (1~31)
SET HOUR			Set the Hour (1~12)
SET MINUTES			Set the Minutes (0~59)
SET MONTH			Set up Month (1~12)
SET YEAR			Set up Year (last two digits)
SPCL FUNCT	SPCL		Special Functions
SND ALL FAX	FAXN		Send All Fax (in folder to fax dev)
SND THS FAX	FAX1		Send Current Fax (to fax device)
SPCIAL SEND	SPCL	SPCL	Special Delivery Options
START TIME			Set copy Start Time
STOP	STOP	STOP	End recording
URGENT MSGs			Copy Urgent Messages
USER OPTNS	OPTN	OPTN	Change User Options
YES			Resume playback

Call Record to Strategy ES

While on an active call, a station user can record the conversation and store it in a Strategy ES voice mailbox. Recordings can also be paused or restarted. Depending upon your System Administrator, you are given either a manual method of recording that allows you to designate the mailbox where the recording will be sent or an auto method that automatically sends the recording to a predefined mailbox that is assigned to the phone you are using. This may be your personal mailbox.

Note Ask your System Administrator which method you need to use when recording a call.

This feature requires the presence of a **Record** and a **PS/RES** (Pause/Resume) button on your telephone. Feature codes are not available.

Important! Strategy ES mailboxes have a definable limit on the length one message can be. If you plan on doing lengthy recordings using this feature, see your System Administrator so your message recording time can be properly defined.

► To record a call

1. With a call in progress, press **Record**.

If you are using the *auto method*, the Record LED flashes rapidly and there is approximately a one second interval (in extreme busy conditions, up to five seconds) before the recording starts and the Record LED changes to the in-use interval flash rate. You are now recording. Continue to Step 3.

...or if you are using the *manual method*, the Record LED flashes green rapidly. Continue to Step 2.

2. (Manual method only) If you want to record the call to the predefined mailbox associated with the phone you are using, press **#**. The Record LED flashes rapidly and there is approximately a one second interval (in extreme busy conditions, up to five seconds) before the recording starts and the Record LED changes to the in-use interval flash rate. You are now recording.

...or if you want to record this call to another mailbox, enter the mailbox number (usually the extension number). Finish by pressing **#**. The Record LED flashes rapidly and there is approximately a one second interval (in extreme busy conditions, up to five seconds) before the recording starts and the Record LED changes to the in-use interval flash rate. You are now recording.

3. To stop recording, press **Record**. The LED turns off and the recording stops. To resume recording at this point, you need to begin a new recording, see Step 1 on previous page.

Pause/Resume Recording

You can pause the recording while continuing the conversation by pressing **PS/RES**. The PS/RES LED flashes red. Your conversation is no longer being recorded.

To resume recording as part of the same message, press the **PS/RES** button again. You can pause and resume indefinitely throughout the conversation. The only limit may be a message length imposed by the voice mail system.

Direct Transfer to Voice Mailbox

An internal user on the Strata CTX can transfer a call directly to another person's voice mailbox without waiting for the call to forward from the called party's telephone. The voice mailbox does not even need to be associated with an active telephone in the Strata CTX.

Direct Transfer to Voice Mail simplifies getting a call for a busy or absent employee to his/her mailbox. It eliminates the need for the caller to enter the desired mailbox number after being connected to the voice mail system.

► To transfer a call directly to Voice Mail (VM)

1. While on a call, press **Cnf/Trn**. You hear feature dial tone.
2. Press **Direct Transfer to VM** or enter **#407**. You hear entry tone.
3. Enter the VM mailbox number (usually the same as the extension number), then press **#**. The call transfers immediately and your extension becomes idle. The transferred party hears the greeting associated with the specified mailbox and can then leave a message.

Note See *Strata CTX 3000/2000-series Telephone User Guide* for information on programming this feature on your phone.

Voice Mail Conference

Voice Mail ports may be included in conference calls. This enables all members of the conference to listen to and play voice mail messages.

Using Stratagy ES with a Strata CTX

Voice Mail Conference

The Strategy ES Fax Printer Driver enables you to select a document that you have created on your computer and after converting it to a Tagged Image Format (TIFF), gives you the option to store the file locally on your hard drive, send it to another Strategy ES user's mailbox, or transmit it to a remote facsimile device using the fax ports of the Strategy ES.

Notes

- The ability of sending faxes through the Strategy ES requires the server be updated with the optional Fax Server Feature Group. Check with your System Administrator to find out if your system is configured for the Fax Server Feature Group.
- This printer driver can only be used on computers running Windows® 2000/ME/98 and Windows NT®.

Configure/Personalize Fax Printer Driver

Note To use this printer driver, you must first load the Strategy ES Fax Printer Driver on your computer. See your System Administrator for details.

1. From Windows, select Start, Settings, then Control Panel.

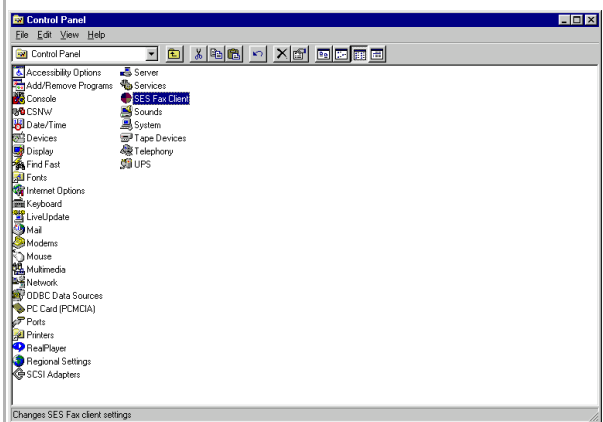

5621

2. From the Control Panel screen, select SES FaxClient.

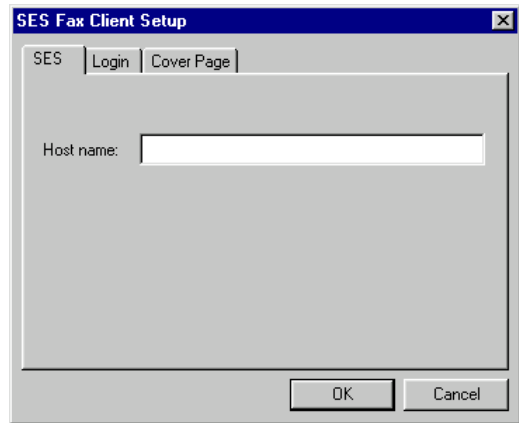

5622

3. In the *Host name:* field on the SES tab screen, type the computer name or IP address for the Strategy ES. Check with your System Administrator for this information.
4. Click on Login tab.

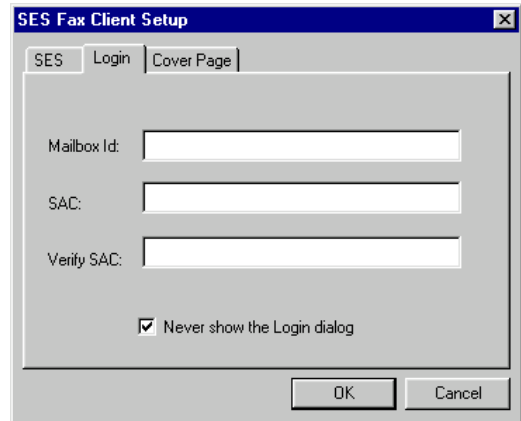

5623

5. Fill in the following fields on the screen:
 - Mailbox Id – Type your mailbox number in the Strategy ES.
 - SAC – Type your mailbox's security code.
 - Verify SAC – For verification, type your mailbox's security code again.

Fax Printer Driver

Configure/Personalize Fax Printer Driver

- Never show the Login dialog – Check/uncheck whether or not you want to type your mailbox number and security code each time you use the Strategy ES Fax Printer Driver.

6. Click the Cover Page tab.

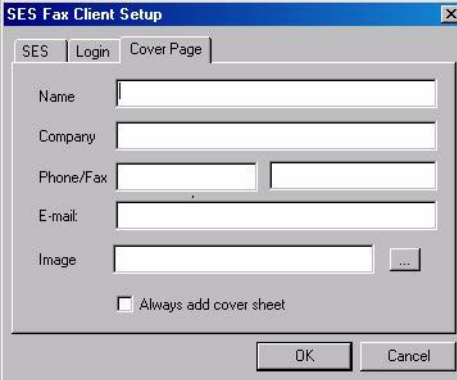

The screenshot shows the 'SES Fax Client Setup' dialog box with the 'Cover Page' tab selected. The dialog contains several input fields: 'Name', 'Company', 'Phone/Fax' (split into two boxes), 'E-mail', and 'Image' (with a browse button). There is also a checkbox labeled 'Always add cover sheet'. At the bottom are 'OK' and 'Cancel' buttons.

6590

7. Fill in the *Name/Company/Phone/Fax* and *E-mail* fields. This information becomes the From: data on the cover page each time you send a fax using the Strategy ES Fax Printer Driver.
8. For custom cover pages, the *Image* field needs to define the location of the template file being used for the cover page.

Note If a custom cover page is desired, see your System Administrator for details.

Use Fax Printer Driver

1. With the document displayed on your PC's monitor, select the Print option from the File menu.
2. From the *Name* field's drop-down menu, select StrategyES Fax.

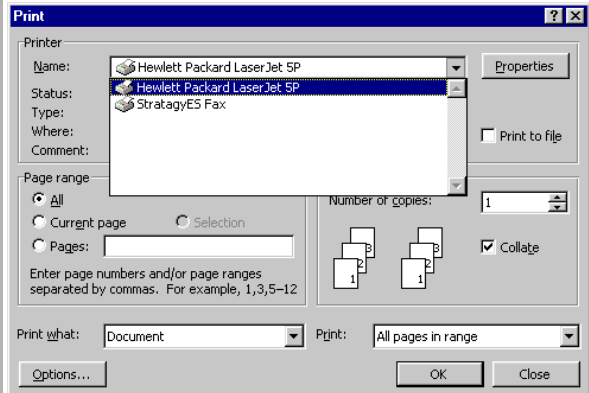

5625

3. Click OK.

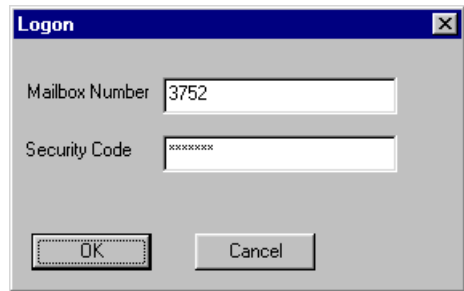

5822

Note If you removed the check mark from the *Never show the Login dialog* field (SES Fax Client Setup screen) when you configured the fax printer driver, this screen does not display. See [Step 5](#) on [page 95](#) for details.

4. Type your mailbox number and security code in the fields provided.

Note This is a security feature to prevent unauthorized use of Strategy ES fax features.

Once authorization has been satisfied, the SES Fax Client window displays (see “SES Fax Client Screen” on page 98).

SES Fax Client Screen

The SES Fax Client screen (shown below) enables you to create and send a fax using Strategy ES. Using the fields on this screen, you can address the fax (destination, fax number), add a cover page or a note to the fax, and enter destination information (name/company/fax/phone/e-mail) that will appear on the top of the cover page.

The screenshot shows the SES Fax Client window with the following fields and controls:

- Document Title:** Microsoft Word - SES Design.doc
- Pages:** 1
- Destination:**
 - Destination Type:** Phone Number (dropdown)
 - Number or Path:** 9495876798
 - Mailbox number / Fax number / File path:** (empty text area)
 - Buttons:** Browse..., Add, Remove, Add List, Save List
- Options:**
 - Add Cover Page
 - Buttons:** Schedule, Send, Cancel
- To:**
 - Name:** John Dart
 - Company:** Toshiba America
 - Phone:** 9495833000
 - Fax:** 9495876798
 - Email:** JDart@toshiba.co
 - Ref:** (empty)
 - Re:** (empty)
 - Button:** Add a Note

6585

Table 4 SES Fax Client Screen Fields

BUTTON	DESCRIPTION
Document Title	Defines the name of the document that you are attempting to fax.
Pages	Provides a page count of the fax document.
Destination Type	Enables you to select the type of destination for this fax. The three options are Local file, Mailbox, or Phone number.
Phone/Mailbox List/ Path	Depending on which Destination Type was selected, this field defines the fax number, mailbox number, or file name.
Browse	Enables you to browse for a path/directory where you can store the TIF file, or to peruse the Stratagy ES user directory for a destination mailbox number.
Add	Adds the defined destination to the list for distribution.
Remove	Removes the highlighted destination from the list.
Add List	Enables you to select a previously created list to the distribution.
Save List	Saves the currently defined list entries as a distribution list.
Add Cover Page	Provides the bottom portion of the screen where destination information can be defined.
Schedule	Enables you to schedule the fax for future delivery.
Send	Sends the fax to the defined destinations.
To (Name/Company/ Fax/Phone/Email)	Defines destination information (such as a recipients name, company, phone number, etc.). This information appears on the cover page.
Add a Note	Provides a text box where comments can be written and added to the cover page.

Schedule Fax for Future Delivery

1. After filling out the SES Fax Client screen, click Schedule. The Schedule Fax screen displays (shown right).
2. Using the drop-down menu select the date.
3. Using the scroll buttons, set the time of day.
4. Click Send

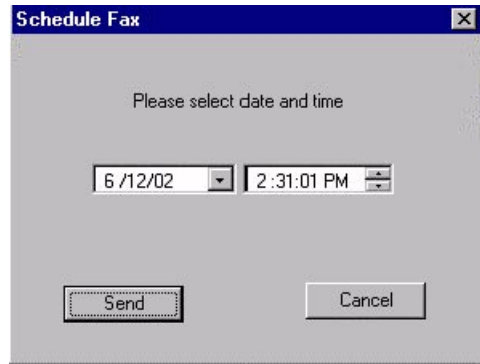

6586

Automatic Speech Recognition

C

Note Automatic Speech Recognition (ASR) is an optional feature in the Strategy ES. Check with your System Administrator to find out if your system is configured for this feature.

Strategy ES's ASR feature enables you to speak into the phone and accomplish the following tasks:

- Reach a destination by saying the user's name
- Log into your mailbox by saying a login command
- Send a message by saying "send message" or "quick message"

A typical company instructional greeting when you reach your company's main phone number would be, "Thank you for calling ABC Corporation. Please say the full name of the person you wish to reach or enter the extension number. You can also say 'send message' to send a message or 'login' to login to your mailbox."

This appendix covers the general procedures for each of these tasks.

Reach Destination

After listening to your company's instructional greeting and saying the user's name, Strategy ES follows this procedure:

- Strategy ES identifies the name and transfers your call to the user's mailbox.
- If Strategy ES is not sure about the spoken name, it prompts you with the name match it has made and requests that you confirm the choice by saying "yes" or "no." If you say "yes," Strategy ES transfers your call to the user's mailbox.
...or if Strategy ES cannot make a match for the spoken name (first or last name) or you say "no" when prompted to confirm the spoken name, it prompts you to repeat the name. If Strategy ES recognizes the name when you repeat it, it transfers your call to the user's mailbox.
- If Strategy ES still cannot identify the spoken name, it prompts you to spell the first and last name. If Strategy ES recognizes the name, it transfers your call to the user's mailbox.
...or if Strategy ES cannot make a match, it transfers your call to the company operator.

Note At any time during these steps, you can say "operator help" and reach the company operator.

Access Your Mailbox

After listening to your company's instructional greeting and speaking one of the login commands (i.e., mailbox login, mailbox logon, user login, user logon, access mailbox, log me in), Strategy ES follows this procedure:

- Strategy ES prompts you for your name. If Strategy ES recognizes the name, it then prompts you for your password.
...or if Strategy ES does not recognize the name, it follows the same steps as in "[Reach Destination](#)" procedure except it does not transfer you to an operator as a final solution. Instead, Strategy ES requests that you hang up and try again.
- You enter your password using the telephone dial pad. Strategy ES gives you access to your mailbox.

Send a Message

After listening to your company's instructional greeting and saying either "send message" or "quick message," Strategy ES follows this procedure:

- Strategy ES prompts you to speak the name of the user for whom you want to leave a message. Strategy ES identifies the name and transfers your call to the user's mailbox where you can leave the message.

...or if Strategy ES does not recognize the name, it follows the same steps as in the "[Reach Destination](#)" procedure except it does not transfer you to an operator as a final solution. Instead, Strategy ES requests you hang up and try again.

Automatic Speech Recognition

Send a Message

Unified Messaging (UM) with Outlook Integration

D

Unified Messaging (UM) lets you efficiently access e-mail, voice mail and fax messages all within your e-mail inbox. You can also retrieve, save and forward all these different types of messages as easily as you currently retrieve messages from your telephone.

This appendix discusses how to play and send voice messages with Strategy ES UM using Outlook Integration. It also includes instructions on how to configure your computer and Microsoft's Outlook® to integrate with the Strategy ES and how to set up the different options for voice message playback and management.

Strategy ES can integrate with Outlook e-mail client to provide innovative UM functions. This integration enables you to play your voice messages over your multimedia PC speakers or through your telephone. You can also view faxes on your PC screen, no more going back and forth to the fax machine!

Note See the Strategy Advisor CD-ROM for more UM information.

Strategy ES Message Window

The Strategy ES Message window (see [Figure 2](#) below and [Table 5](#) on [page 107](#)) enables you to manage both your voice and fax messages from your PC.

The Message window displays when you select a message from the Microsoft Outlook Inbox window. Using the toolbar, buttons and slides on the Message window, you can perform all the necessary functions to play, send, forward or reply to a message or view a fax.

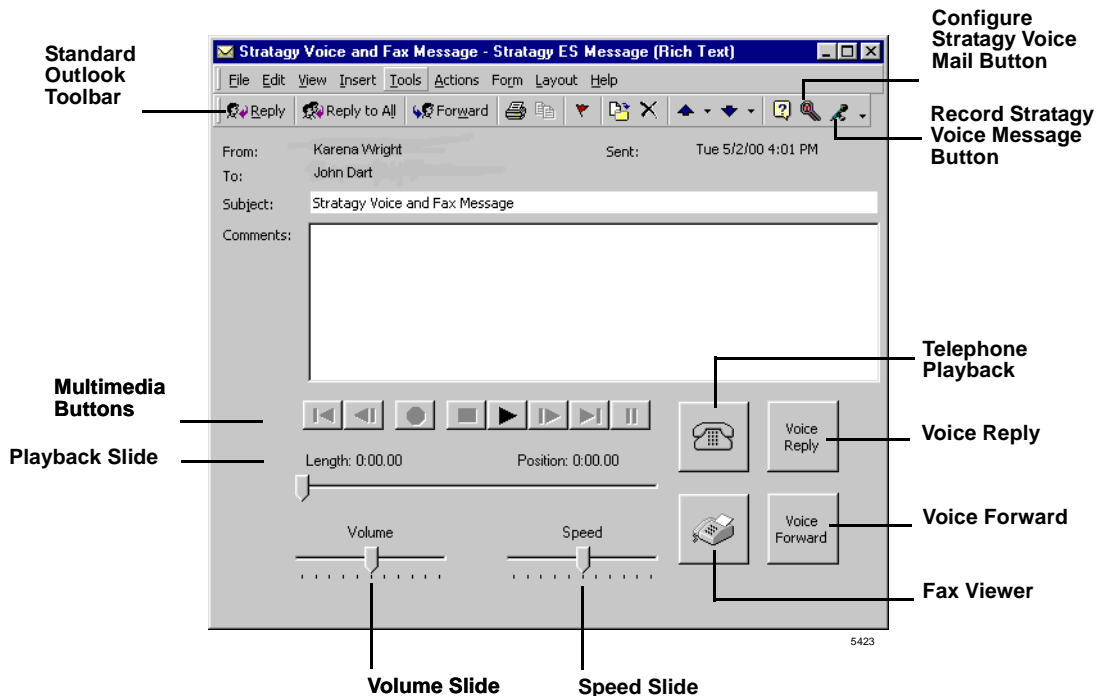

Figure 2 Strategy ES Message Window

Table 5 Stratagy ES Message Box Buttons

BUTTON	DESCRIPTION
Multimedia	Enables you to play, rewind, fast forward, pause and stop message playback.
Playback Slide	Enables you to move to a specific part of the message by dragging this slide button.
Volume Slide	You can adjust the volume of a message by moving the slider.
Speed Slide	If you are playing the message through your telephone, you can use this slide bar to change the speed of the playback.
Voice Forward	Lets you easily forward a message to a co-worker.
Voice Reply	Displays only when you receive a message from a co-worker, enabling you to reply to the sender.
Telephone Playback	<p>Displays when you set up Outlook to play or record voice messages using your telephone. Clicking on it, directs Stratagy ES to call your telephone to start the play or record process.</p> <p>Note While Stratagy ES is processing the call to your telephone, the icon displays an off-hook receiver.</p>
Fax Viewer	<p>Displays when the message contains a fax. When you click on this button, Outlook launches your computer's designated application for viewing the Tagged Image File Format (TIFF) files.</p> <p>Note If your computer is not configured to view TIFF files, ask your System Administrator for assistance.</p>
Standard Outlook Toolbar	<p>You can also use this toolbar for sending voice replies and forwarding voice messages to anyone that has e-mail.</p> <p>Note If you're sending a voice message to someone who's not on the Stratagy ES system, you must also send the Stratagy ES audio driver so the recipient can play the message on their computer. Your System Administrator has details about this driver.</p>
Configure Strategy Voice Mail	Using this button, you can select personal preferences, such as playing voice messages through your PC speakers or telephone.
Record Strategy Voice Message	Using this button, you can easily record voice messages for co-workers or any co-workers who use the Stratagy ES system.

Address Book Feature

- The Strategy ES Address Book makes it easy to find and select addresses for user's mailboxes. The address book lists all voice mailbox addresses in the system.

The address book can be manually or automatically updated with the most current mailbox list.

Update Strategy ES Address Book Manually

- From the Microsoft Outlook Inbox screen (shown at right), select Tools, then Synchronize Strategy Address Book. Strategy ES updates the address book with the most current mailbox list.

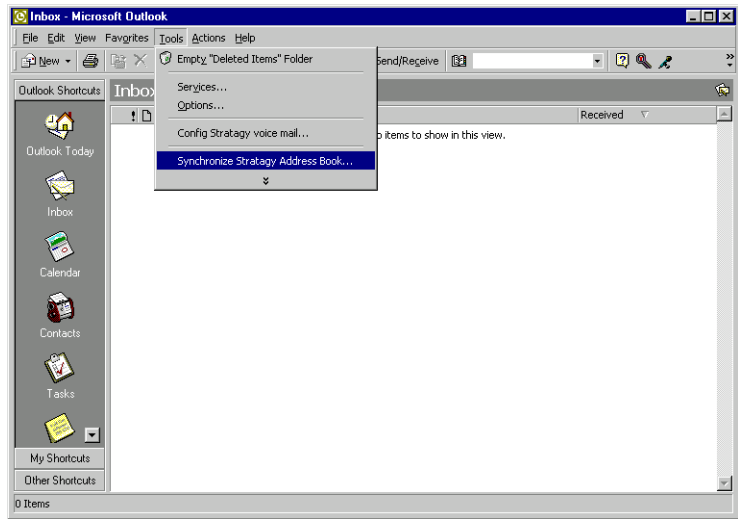

Update Strategy ES Address Book Automatically

- The Strategy ES Address book can be automatically updated with the Strategy ES at regular intervals (set number of days). See [Step 9](#) on [page 111](#) for instructions on setting the feature.

Using UM Feature

Step 1: Configure Your Computer for UM

Note This step may have already been performed for you. Check with your System Administrator.

Before using UM features, you'll need to configure the Strategy ES to coordinate and synchronize information with your computer.

1. From the Standard Outlook toolbar, click Configure Strategy Voice Mail (see [Figure 2](#) on [page 106](#)). The Strategy ES Message Configuration (Media Setting) screen displays (shown right).

Note Using this screen, you can set up your system to play voice messages through speakers, and determine how your Strategy ES messages are managed within Outlook.

2. From the Media Setting tab screen, select PC Speaker/Microphone or Telephone handset as your choice for playing and recording your messages.

- PC Speaker/Microphone – The messages play over your PC's speaker/microphone.
- Telephone handset – If you choose Telephone handset, you need to enter either an extension number or direct dial number in the Telephone Number field. This number is where you will receive your voice messages. A Telephone icon will display on the Strategy Message window indicating that you have chosen this option.

3. In the next section of the screen, select the method you want Strategy ES to use when processing a message after you select it to play in Outlook.

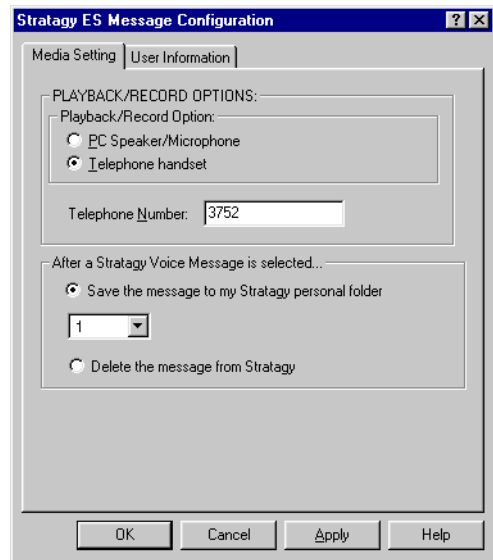

- Save the message to my Strategy personal folder – If you select this option, you need to select one of your personal folders from the drop-down list where the messages will be stored.

Important! The default setting is folder “1” which is your saved message folder. The Multiple Message Folder Feature must be enabled in order to use folders 2~8. (See “[Manage Personal Folders](#)” on [page 78](#).)

- Delete the message from Strategy – Deletes the message automatically from your Strategy mailbox after it has been downloaded to Outlook.

Important! If you choose to have messages deleted from the Strategy ES mailbox, the only copy of these messages that will be left will be on your computer.

4. Click OK and a dialog box informs you that the changes will be applied next time you open the message. Click OK again, then User Information tab. The User Information screen displays (shown right).

5. In the *Mailbox number* field, type the mailbox number of the user. Press **Enter**.

6. In the *Mailbox security code* field, type the security code for the previously defined mailbox. Press **Enter**.

7. The next two fields, *Server name/IP address* and *Domain name*, should be filled in by your System Administrator.

8. In the *Email password* field, type your e-mail password if you are going to use the e-mail Text-to-Speech (TTS) feature. Press **Enter**.

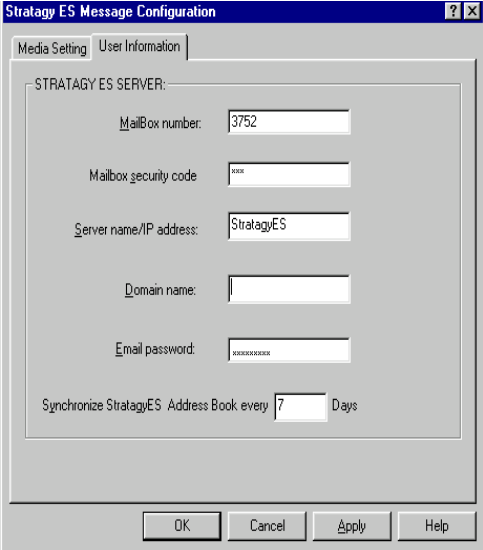

The screenshot shows the 'Strategy ES Message Configuration' dialog box with the 'User Information' tab selected. The dialog contains the following fields and controls:

- Media Setting** and **User Information** tabs at the top.
- STRATEGY ES SERVER:** section containing:
 - Mailbox number:** text box with '3752' entered.
 - Mailbox security code:** text box with '***' entered.
 - Server name/IP address:** text box with 'StrategyES' entered.
 - Domain name:** empty text box.
 - Email password:** text box with '*****' entered.
- Synchronize StrategyES Address Book every** 7 **Days**.
- OK**, **Cancel**, **Apply**, and **Help** buttons at the bottom.

53391

Notes

- The mailbox number, Server name/IP address and Domain name should have been filled in during the installation of the Strategy ES Outlook Integration software. These fields are available if changes are required.
 - Without this password, the TTS e-mail feature does not work.
 - This password must match the one entered in the E-mail Server (e.g., Exchange) account password for the TTS e-mail feature to function.
9. In the *Synchronize StrategyES Address Book every ___ Days* field, type the interval (number of days) you wish to have Outlook synchronize with the Strategy ES for the latest directory updates. After the specified amount of days, an automatic synchronization takes place.

To disable automatic synchronization, type zero for the number of days.

10. Click Apply.

Step 2: View Message Log

When you receive a voice or fax message in your Strategy ES mailbox, an e-mail message is inserted into your Outlook Inbox (shown at right). The *Subject* field tells you what type of message you received—voice, fax or a voice and fax.

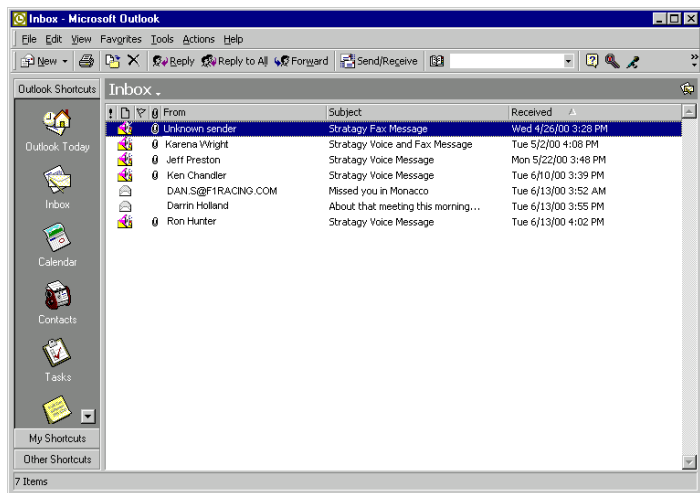

5422

Step 3: Select Message

- ▶ Double-click on a message listed in the Microsoft Outlook Inbox. The Strategy ES Message window displays (see [Figure 2](#) on [page 106](#)), enabling you to manage both your voice and fax messages from your PC.

See “[Voice Mail Options](#)” on [page 112](#) and “[View Fax](#)” on [page 115](#) for instructions on using your voice and fax mail.

Note When you listen to and delete a Strategy ES message by telephone, the e-mail listing is not deleted from the Outlook screen. If you click on the screen listing, you are alerted that the message has already been deleted by telephone. You must now delete it from the Outlook screen.

Voice Mail Options

UM voice mail option enables you to:

- Play a voice message
- Reply to a voice message
- Forward a voice message
- Send a voice message

Play Voice Message

- ▶ From the Strategy Voice and Fax Message screen, click Play on the multimedia bar. The voice message plays. While the message is playing you can use the other multimedia buttons to navigate through the message (see [Figure 3](#)).

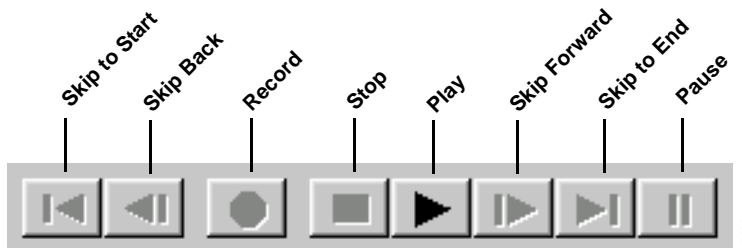
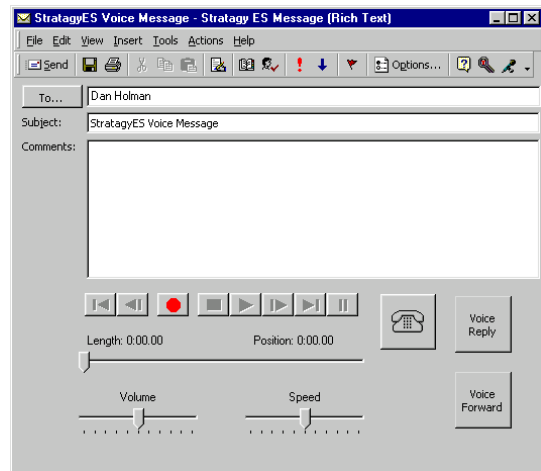

Figure 3 Multimedia Bar (Buttons)

Reply to Voice Message

1. From the Strategy Voice and Fax Message screen, click Voice Reply. Another message form displays with the *To* field filled in with the address of the original sender (shown right).
2. Click Record (see [Figure 3](#)) on the multimedia bar.
3. Speak your message clearly into the microphone.
4. Click Stop on the multimedia bar.
5. Click Send on the toolbar. The Reply Message window closes. The Outlook Inbox remains on the screen.
6. (Optional) From the Outlook Inbox screen, type a brief note into the *Comments* field about the voice message so you will not have to replay it to review the contents.



Forward Voice Message

1. From the Strategy Message window, click Voice Forward. Another message form displays (shown right).

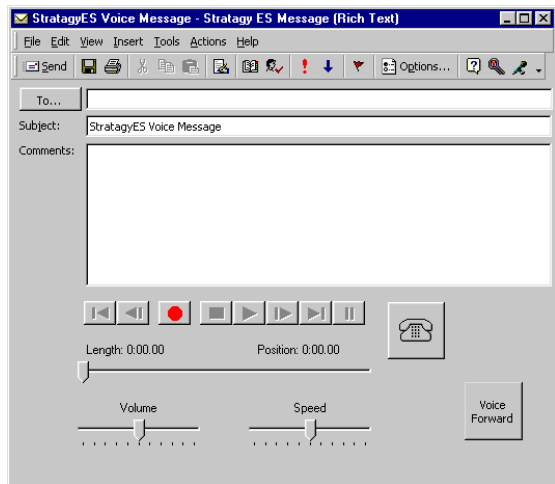

2. Click *To* field. The Select Names screen displays (shown right).
3. From the *Show Names from the* field drop-down list, select the Strategy ES Address Book.
4. Select a name or names from the address book. Click OK. The screen in Step 1 above displays with the *To* field filled in with your destination(s).
5. (Optional) To record a comment to go along with the forwarded message, click Record on the multimedia bar.
6. Speak your message clearly into the microphone. When finished, click End Recording on the Standard Outlook Toolbar (see [Figure 2](#) on page 106).
7. Click Send. The Reply Message window closes. The Outlook Inbox remains on the screen.

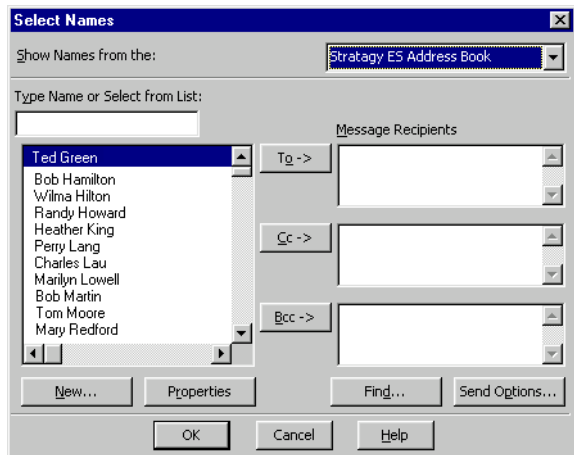

Send Voice Message

1. From the Strategy Voice and Fax Message screen, click Record Strategy Voice Message in the Standard Outlook toolbar.
2. Click To field. The Select Names screen displays (shown right).
3. From the *Show Names from the* field drop-down list, select Strategy ES Address Book.
4. Select a name or names from the address book. Click OK. The screen in Step 1 above displays with the *To* field filled in with your destination(s).
5. Click Record (see [Figure 3](#)) on the multimedia bar.
6. Speak your message clearly into the microphone.
7. Click Stop.
8. Click Send. The Message window closes. The Outlook Inbox is still displayed.

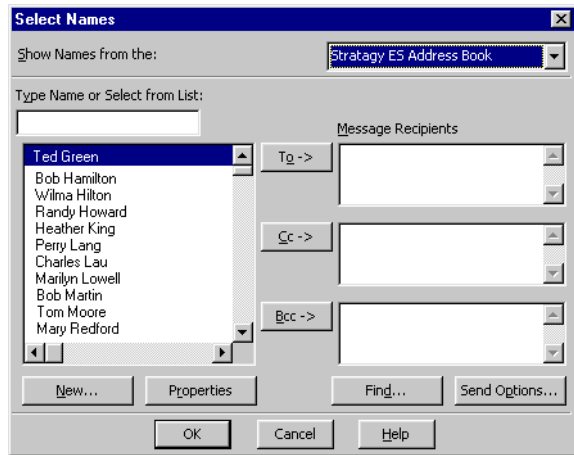

View Fax

UM enables you to view a fax message.

- From the Strategy Voice and Fax Message screen, click Fax Viewer (see [Figure 2](#) on [page 106](#)). The Strategy ES Message window launches your computer's designated application for displaying TIFF files.

Note Most imaging software lets you edit the fax, zoom in and out, rotate its view. You need to check with your System Administrator on your software's features.

Unified Messaging (UM) with Outlook Integration

View Fax

Unified Messaging with IP Integration

E

This appendix provides instructions on how to configure your computer to properly record .wav files in the correct format to send into Strategy ES as voice messages.

Note This process is only necessary if your computer is configured to use Unified Messaging with Internet Protocol (IP) Standard Integration.

Configure Windows for Strategy ES Codec

Note Before beginning the setup procedure, the TAIS Audio Codec must be installed on your PC.

Check Codec is Installed on PC

1. Click Start >Settings > Control Panel > Sounds and Multimedia > Hardware tab (shown right).
2. Confirm if the Strategy ES Audio Codec is present. If it is present, continue with this setup. If it is not, contact your System Administrator to have the Codec installed on your PC.

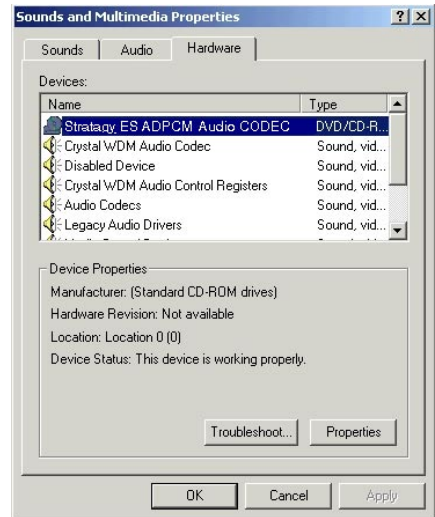

Configure Windows

1. Click Start > Settings > Control Panel > Multimedia (shown right).

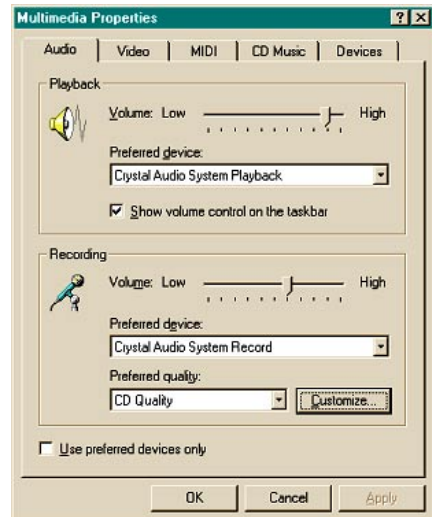

2. In the Recording section of the Multimedia Properties window, click Customize. The Sound Selection screen displays (shown right).

Note In Windows 2000 you can access the Sound Selection screen directly by selecting Start > Programs > Accessories > Entertainment > Sound Recorder > File > Properties > Convert Now.

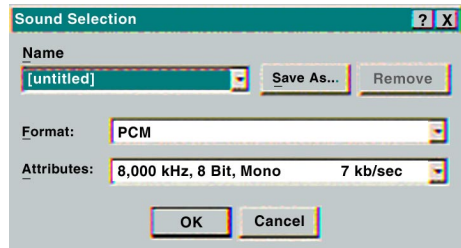

3. From the Sound Selection screen, select Toshiba ADPCM from the *Format* field's drop-down menu (this value is only present if the TAIS Audio Codec has been properly installed).
4. From the *Attributes* field, select 8,000 KHz, 4 Bit, Mono from the drop-down menu.

Unified Messaging with IP Integration

Record Strategy ES Voice Messages (using Windows Sound Recorder)

5. Click Save As and the Save As dialog box displays. Type Strategy ES Format in the available field.
6. Click OK. The Sound Selection screen displays (shown right).
7. From the Sound Selection screen, click OK.
8. From the Multimedia Properties screen, click OK to quit Multimedia Properties. This completes the setup.

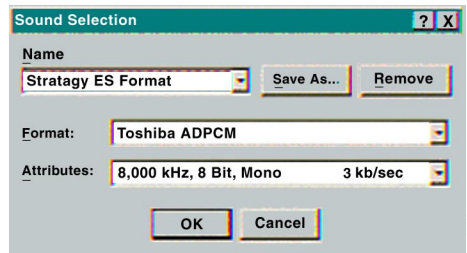
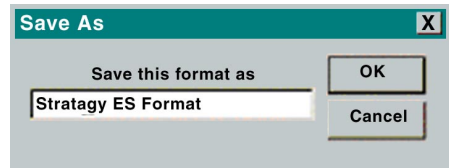

Record Strategy ES Voice Messages (using Windows Sound Recorder)

This procedure explains one way in which to record a .wav file that can be sent into the Strategy ES as a voice message. Other multimedia software can be used to perform this function provided that the software provides a way to set the recording compression rate. To use Microsoft Sound Recorder, perform the following:

1. From the Start Menu, select Programs > Accessories > either Multimedia (Windows NT®) or Entertainment (Windows 98 & Windows 2000) > Sound Recorder.
2. Click Record (red button) and record your message through the multimedia microphone connected to your PC.
3. When finished recording, click on File > Save As.
4. Select a folder in which to save the .wav file.
5. Enter a File name for the .wav file.
6. Click Change. The Sound Selection window displays.
7. From the *Name* field's drop-down menu, select Strategy ES Format. The attributes should change to reflect the proper compression of 8,000 KHz, 4 Bit, Mono.
8. Click OK to close the Sound Selection window. The Save As window displays.
9. If the target folder information is correct, click Save.

Send .WAV File as Voice Message

1. To send the .wav file into Strategy ES as either a new, reply, or forwarded voice message to a mailbox, attach the .wav file to an e-mail message (shown right).

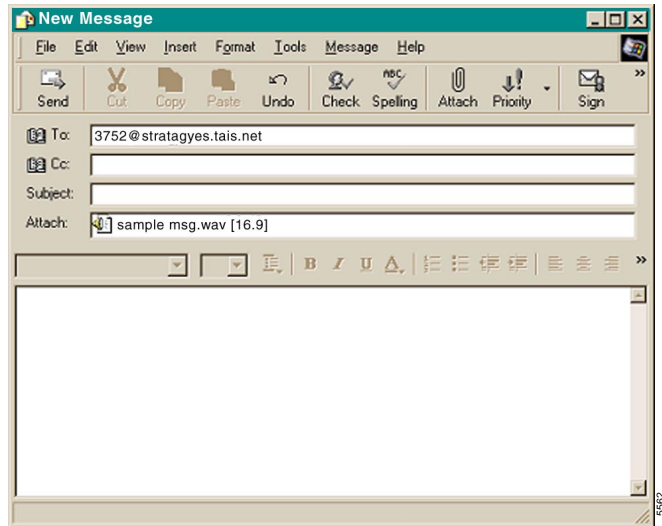

2. Make sure that the address for the message is correct. The addressing convention for sending voice messages into a Strategy ES is defined as <target mailbox number>@<system computer name.domain>.

Note As a quick tip, every time you get a Strategy ES voice message from a Strategy ES voice mail user, add that address to your personal address book.

If other Strategy ES mailbox addresses are entered in either the To:, cc:, or bcc: fields, those mailboxes also receive your message.

Unified Messaging with IP Integration

Send .WAV File as Voice Message

Remote User Password Administration for TTS

F

This appendix provides instructions on how to update the Strategy ES software with your e-mail log on password so that the system can retrieve e-mail messages and read them via Text-to-Speech (TTS).

Note This procedure is only required if you have TTS Privileges and you use Unified Messaging with the Internet Protocol (IP) Standard Integration.

Please contact your System Administrator to confirm your mailbox privileges.

To update the Strategy ES with your e-mail password, the Strategy ES Remote User Password Administration applet must be installed on the your computer.

- Without the password, the TTS e-mail feature does not work.
- This password must match the E-mail Server (e.g., Exchange) account password for the TTS feature to work.

Set Remote User Password

► To install Strategy ES Remote User Password Administration applet

1. Insert the Strategy ES Software CD-ROM into your computer.
2. From the Main Menu, select Remote User Password Administration. The Strategy ES Remote User Password Administration screen displays (shown right).
3. Enter the Strategy ES mailbox number for the user.
4. Enter that mailbox's security code.
5. Enter the password that you enter to log into your e-mail service.
6. Enter the computer name or IP address of the host Strategy ES system on the local network. Your System Administrator should have this information.
7. Enter the computer name or IP address of the host SMTP server on the local network.
8. Click Send Update. The applet will securely send your e-mail password directly into the Strategy ES system. Your System Administrator should have this information.

Strategy ES Remote User Password Administration

User Information

Mailbox Number:

Mailbox Security Code:

E-mail Password:

Server Information

Strategy ES Server Name/IP Address:

Network SMTP Server Name/IP Address:

Send Update Cancel Help

6586

Using Strategy ES with a Strata Legacy System

G

Notes

- Toshiba Legacy systems are Strata DK8/16, DK14, DK40i, DK424i, DK24/56/96. For information on Strata CTX systems, see [Appendix A – Using Strategy ES with a Strata CTX](#).
- The naming convention for DKT assignments within Toshiba is Directory Numbers. For clarity and ease of understanding, the terms Extension Number and Phantom Extension Number will be used in this document in lieu of PDN and PhDN.

This appendix explains the procedures for programming Toshiba Legacy proprietary telephones for Call Forward and Message Retrieval when using a Strategy ES Voice Processing System with one of the following Toshiba telephone systems:

- Strata DK14, DK40i, DK424i

Note Any reference to Strata DK 424i in this appendix, should be read to include DK424 and DK280. Any reference to DK40i should be read to include DK40 and DK16e.

- Strata DK8/16, DK24/56/96

Once programmed, your Strategy ES voice processing system can answer calls when you are busy or not available. It can give callers choices when you do not answer, such as: recording a message, dialing another extension, or dialing 0 for assistance.

Note This appendix does not include the procedures for Call Forward and Message Retrieval with a standard telephone. Consult the appropriate Toshiba Standard Telephone User Guide for these instructions.

If you have a Strata telephone system, you need to program your telephone only once for the Call Forward and Message Retrieval functions. Then you can follow the appropriate steps for using Call Forward and Message Retrieval.

Notes

- If you do not have Call Forward keys, you can use access codes instead. Refer to the appropriate User Guide for the Call Forward access/cancellation codes or check with your System Administrator.
- If the Strategy ES is fully integrated with your telephone system, you may not need to enter a Voice Mail ID code for Call Forwarding or Message Retrieval. Please consult your System Administrator if Voice Mail ID codes are required.
- With most Toshiba proprietary telephones, you can store the sequence of steps on a Speed Dial button for quick access. Refer to the appropriate Quick Reference or User Guide for your telephone for information and instructions on using Speed Dial buttons.

Call Forward

To direct forwarded calls to your mailbox and to ensure that callers receive your personal greeting, additional internal access digits must be programmed initially from your telephone for your extension number and for each phantom extension number by your telephone. These digits are called voice mail ID codes.

Note Your telephone must be the owner of the phantom extension number to store a voice mail ID code for the phantom extension number.

Set Call Forward to Strategy ES

Skip to [“To forward calls to Strategy ES”](#) on [page 128](#) if you have already performed this function. Once programmed, this code is automatically sent to the Strategy ES system whenever calls are forwarded to the Strategy ES system from your telephone, enabling callers direct access into your mailbox.

► To program the Strategy ES Voice Mail Code from a Strata DK telephone

- | | |
|-----------------------------------------------------------------------------------------------------------------------|------------------------------------------------------------------------------------------------------------------------------------------------------------------------------------------|
| 1. Press the extension number or phantom extension number. | You hear a dial tone. |
| 2. For Strata DK14, DK40i, and DK424, press #656
...or for Strata DK8/16 and DK24/56/96, press 656 . | You hear a confirmation tone. Display telephones show “#656 I.D. CODE SET.”
You have completed programming and hear a confirmation tone. Display telephones show “656 I.D. CODE SET.” |
| 3. Press 91 . | |
| 4. Enter your Strategy ES mailbox number. | |
| 5. Press Redial . | You hear a confirmation tone. Display telephones show “DATA PROGRAMED.” |
| 6. Press Spkr . | Resets your telephone to the idle condition. |

Notes

- To change the voice mail code, repeat steps.
- In order for the **#** button to function properly while using the Strategy ES system with a Toshiba Strata system, the **Speed Dial (REP, SDS)** button and the **Redial (RDL)** button must be provided on your Toshiba proprietary telephone.

► To forward calls to Strategy ES

1. Press the appropriate **Call Forward** button

...or press the extension number or phantom extension number, then enter the appropriate Call Forward access code.

The Call Forward LED flashes, or you hear a confirmation tone.

You hear a confirmation tone if an access code is dialed. Display telephones show “CALL FORWARD TO.”

Call Forward Access Codes

	Strata DK8/16 and DK24/54/96	Strata DK14, DK40i, and DK424i
Call Forward All Calls	601	#601
Call Forward Busy	602	#602
Call Forward No Answer	603	#603
Call Forward Busy No Answer	604	#604

2. Dial the Strategy ES system number _____.

You hear a confirmation tone.

3. (Optional) For Call Forward-No Answer and Call Forward- Busy/No Answer, you can set the number of seconds that your telephone rings before forwarding.

If you pressed a Call Forward button in Step 1, enter the number of seconds (**08~60**)

...or if you pressed a extension number or phantom extension number in Step 1, press **Speed Dial** and enter the number of seconds (**08~60**).

4. Press the same Call Forward button used in Step 1
...or if you used an access code sequence, press **Redial**, then **Spkr**.

Note Some older telephones do not have **Speed Dial** and **Redial** buttons. You may need to press **SDS** (or **REP**) + the number of seconds (08~60) + **RDL** or * + the number of seconds (08~60) + **#**.

The Call Forward LED lights steady.

Cancel Call Forward

1. Press the appropriate **Call Forward** button, then **Spkr**
...or press the extension number or phantom extension number, then enter the appropriate Call Forward access code.
2. Press **Spkr (SPEAKER)**.

The Call Forward LED turns OFF, or you hear a confirmation tone. Call Forward registration is canceled.

You hear a confirmation dial tone. Display telephones show “CALL FORWARD TO.” Dialing the access code (e.g., **#601**) and no station number cancels any Call Forward type.

See “[To forward calls to Strategy ES](#)” on [page 128](#) for access codes.

Cancel the Programmed Call Forward Voice Mail Code

1. Press the extension number or phantom extension number.
2. For Strata DK14, DK40i, and DK424i, press **#656**.
...or for Strata DK8/16 and DK24/56/96, press **656**.
3. Press **Redial**.
4. Press **Spkr (SPEAKER)**.

You hear a dial tone.

You hear a confirmation tone. Display telephones show “#656 (or 656) ID CODE SET.”

You will hear a confirmation tone. Display telephones show “DATA PROGRAMED.” The voice mail code is canceled.

Message Retrieval

You can program your **Msg** or phantom extension number/message waiting buttons to automatically retrieve your voice mail messages when you press it.

Skip to “[To retrieve messages with Msg or Phantom Extension Number/Message Waiting button](#)” on [page 132](#) if you have already performed this function. Once programmed, this key does not need to be programmed again.

► To program your **Msg** button to retrieve messages

1. Press the extension number or phantom extension number.

You hear a dial or confirmation tone after you press the button.

2. For Strata DK8/16 and DK24/56/96, press **657**.

You hear a confirmation tone. “657” or “#657” is the Strategy ES System Identification code for message retrieval from voice mail.

For Strata DK14, DK40i, and DK424i, press **#657**.

Your telephone must have the **Speed Dial (REP, SDS)** button and the **Redial (RDL)** button for the **#** button to function properly while using the Strategy ES system.

3. Press **92** (the Voice Mail ID code for Message Retrieval).
4. Enter your Strategy ES mailbox number + **#**.
5. Enter your security code + **#**.

By storing your security code, you avoid having to enter your code every time you access your mailbox.

Important! *Including your security code in this programming will enable anyone to retrieve your messages from your phone. If a security code is not desired, do not include it.*

6. Press **Redial**.
7. Press **Spkr**.

You hear a confirmation tone. Display telephones show, “DATA PROGRAMED.”

► To retrieve messages with Msg or Phantom Extension Number/Message Waiting button

- When the Message LED flashes...
For Strata DK14, DK40i, and DK424i, press **Msg** or [Phantom Extension Number/MW]
...or for the Strata DK8/16 and DK24/56/96, press the extension number + **Msg**.

Strategy ES is called and you are automatically connected to your mailbox.

The system automatically calls Strategy ES.

Note Pressing **Msg** before the extension number cancels the message waiting notification (e.g., the message light goes Off even though the registered messages may not have been retrieved).

► To cancel automatic retrieval

- For Strata DK14, DK40i, and DK424i, press the extension number or phantom extension number + **#657 + Redial**
...or for the Strata DK8/16 and DK24/56/96, press the extension number or phantom extension number + **657 + Redial**.

Note If you have a Toshiba telephone system, see [Chapter 5 – Manage Mailbox](#) for further instructions on using the Call Forward and Message Retrieval features. If you have one of the telephones listed in that chapter, you may need to program your telephone (once) so that the message waiting key works properly.

Depending upon your telephone system and telephone, a message waiting light is lit on your telephone when a voice message has been left for you on the Strategy ES system.

If configured, Strategy ES automatically turns off your message waiting light on your telephone when your new message queue is empty or only partially heard messages remain. All unheard messages must be accessed and partially heard, deleted or saved for Strategy ES to turn off the message waiting light on your telephone.

Glossary

This glossary defines frequently-used Strategy ES voice processing system features and functions.

Term	Definition
Busy Greeting	You can select your custom busy or the system busy greeting for callers to hear when your telephone is busy. If you do not record your custom busy greeting, the system busy greeting automatically plays.
Call Screening	Call Screening operates in On/Off mode. When On, Strategy ES asks callers for their name and company. Without the caller's knowledge, the system relays that information to you. You can decide to receive the call, let the call forward to your mailbox, or transfer the call to another extension with or without announcement.
Caller	Someone who calls into the Strategy ES system. A caller can obtain information, leave a message for someone, and/or provide information.
Called Party	The telephone user the caller reached. See "User."
Directory	A caller enters digits corresponding to the first few letters of a user's name and Strategy ES plays the recorded name (and optionally extension) that matches the entered digits. Strategy ES offers the caller the option of selecting the name and being transferred or hearing the next name.

Glossary

Do Not Disturb ~ Name Recording

Term	Definition
Do Not Disturb	Do Not Disturb operates in On/Off mode. When On, Stratagy ES automatically sends calls to your mailbox without ringing your telephone first.
Fax Messages	Fax messages sent to your mailbox. With the optional fax mail feature, your mailbox can receive, store, and forward fax messages along with voice messages. When you access your mailbox, Stratagy ES tells you the number of fax messages in your mailbox; and when you play the message, states the number of pages received. You cannot listen to the actual fax information. If you are calling from a fax machine, the fax can be transmitted on the same telephone connection; otherwise, you can direct the fax to a fax machine's number. The system redials the designated fax number and transmits the document.
FIFO (First In, First Out)	Messages play in either FIFO or LIFO order. FIFO plays messages from oldest to newest.
Future Delivery	With future delivery, you can arrange for your message to be delivered at a specific time and date in the future. Once you send the message, you can use the Play Messages—Future Delivery Review option to review, continue to send, or delete the message.
Guest Mailbox	Guest mailboxes provide limited access to the Stratagy ES system for temporary and project-oriented employees, such as consultants and contractors. Guest users can only send and receive messages to their Host mailbox and other guests of the Host mailbox.
LIFO (Last In, First Out)	Messages play in either LIFO or FIFO order. LIFO plays messages from newest to oldest.
Mailbox	A user mailbox records messages from callers. A user periodically checks the mailbox for messages, etc., or a variety of automatic notification methods can be employed. There is generally one mailbox for each extension, although several mailboxes can share a single extension when multiple users share the same telephone line.
Name Recording	Your name (and optionally, extension) recording is used for the directory, system greeting, and mailbox.

Term	Definition
New Message Folder	The new message folder contains unheard and partially heard messages. When playing new messages, urgent messages always play first.
Personal Folders	Mailboxes configured for multiple folders can create up to seven personal folders for saving messages. The folders can only be accessed by the mailbox user that created them.
Personal Greetings	<p>You may record up to seven personal greetings which are played for callers when you are unavailable. Although only one greeting can be in effect at any one time, you can switch between the greetings by entering the greeting number, or pre-schedule different greetings to play at a certain time and/or day.</p> <p>Greetings can be reviewed or re-recorded. You can also select the default system greeting.</p>
Personal Distribution List	A mailbox user can create/modify up to seven personal destination (distribution) lists and list comments for identification. When sending messages, you can select a mailbox number, personal distribution list, system distribution list, and/or the directory as the destination.
Private Messages	You can mark a message "private," meaning the message cannot be forwarded by the recipient to another user. The recipient is told the message has the Private attribute set when listening to his/her messages.
Return Receipt	When sending, forwarding, or replying to a message, you can request a return receipt. Stratagy ES notifies you when and by whom the message was received. The recipient is not notified that receipt verification was requested and cannot circumvent the procedure.
Saved Message Folder	<p>The saved message folder contains messages that you saved or that were automatically saved by the system. Messages flagged to be saved can be stored in the saved message folder.</p> <p>Mailboxes configured for Personal folders have the option of saving messages in a personal folder created by the mailbox user.</p>

Glossary

Security Code ~ User Notification

Term	Definition
Security Code	Each mailbox in the system has a security code. You must enter your security code to access your mailbox. The security code ensures the privacy of your messages, personal greetings, etc.
System Administrator	The representative in your company responsible for configuring the Strategy ES system and your mailbox to suit you and your companies needs.
System Greeting	Pre-recorded greeting that adds your recorded name: "Please leave a message for (name)." Can be used by any user on the Strategy ES system. Based on your selection, callers hear the system greeting or a personal greeting.
System Distribution List	System-wide destination (distribution) list the System Administrator creates for Strategy ES system users. When sending messages, you can choose a mailbox number, personal distribution list, system distribution list, and/or the directory as the destination.
Toshiba Proprietary Integration	Proprietary integration between Strata CTX phone system and Strategy ES voice mail. Provides a Soft Key Control of Voice Mail feature that enables the user to perform many of the standard functions using soft keys on the Strata 3000/2000-series digital telephones.
Urgent Messages	Messages are stamped Urgent by the sender and by default, are played first, followed by all other messages. The System Administrator can set a notification record to use pager notification exclusively whenever Urgent messages are received.
User	Subscriber of the mailbox, also known as a mailbox user. A user has access to one or more mailboxes in the system by knowing the security codes. Once a user accesses his/her mailbox, he/she can play back messages, delete those messages, send them to other mailboxes, etc.
User Notification	Each mailbox can have notification records set by the System Administrator to automatically call and notify you of your messages. You can enable/disable the notify method for each of these records or change the notification telephone number.

Index

A

- about this guide
 - conventions, [viii](#)
 - organization, [vii](#)
 - related documents/media, [x](#)
- access your mailbox, [18](#)
- ASR, [101](#)
- automatic message copy, [70](#)
- Automatic Speech Recognition, [101](#)

B

- basic functions
 - delete, [28, 34](#)
 - forward, [28](#)
 - play, [27, 34](#)
 - replay current message, [28, 35](#)
 - reply, [28](#)
 - save, [27, 34](#)
- busy greeting, [10](#)
 - record, [64](#)
 - select, [63](#)
- buttons
 - extension, [viii](#)

C

- call forward
 - system, [81](#)
- call record, [90](#)
- call screening, [61](#)
- change
 - greeting, [54](#)
 - security code, [22, 62](#)
 - user options, [59](#)
- continuous
 - delete, [30](#)
 - play, [32](#)
- copy
 - automatic message, [70](#)

D

- date/time of message, [30](#)
- delete messages, [28, 34](#)
- destination
 - additional users, [42, 45, 47](#)
 - directory, [13, 40, 43](#)
 - mailbox number, [40, 43](#)
 - multiple destinations, [41, 44](#)
 - personal list, [12, 41, 44](#)
 - system list, [13](#)

direct transfer to voice mailbox, 91
directory, 40, 43
distribution lists, 12, 13

E

e-mail messages, 9, 33
exit mailbox, 22
extension number, viii

F

fax messages, 9, 29
 schedule for future delivery, 100
fax printer driver, 93
folders, 31
 dual message, 5
 new, 5
 multiple message, 6
 personal, 78
 single message, 5
forward message, 8, 28, 43
future delivery, 11
 faxes, 100
 review, 30
 setting, 42, 47, 49

G

getting started, 17
greeting
 busy, 10, 64
 change, 54
 personal, 10
 change your selection, 57
 create, 55
 record over, 55
 review greeting, 58

 sample, 21, 55
 system, 10
guest mailboxes
 manage, 76
 use, 77

L

lists
 personal distribution, 41, 44

M

mailbox, 19, 40, 43
 access, 18
 exit, 22
 manage options, 53
 personalize, 4
 security code, 22
manage
 guest mailboxes, 76
 mailbox, 53
 personal folders, 78
menu
 main, 3
message waiting, 83
message waiting light
 on [PhDN/MW], 84
 on another telephone, 84
messages
 access, 24
 additional destinations, 42, 45, 47
 append, 42, 47
 automatic copy, 70
 continuous delete, 30
 continuous play, 32
 control

- back up (rewind), 25
- change speed, 25
- go forward (advance), 25
- pause/resume, 25, 44, 46
- play next, 25
- play previous, 25
- replay current, 25
- volume, 25
- date and time, 30
- delete, 28, 34
- destination, 12
- e-mail, 9, 33
- fax, 9, 29
- folders, 4
 - dual message, 5
 - saved, 6, 7
 - multiple message, 6
 - personal, 78
 - single message, 5
- forward, 8, 28, 43
- future delivery, 11, 30, 49
- new message folder, 5, 31
- notification, 68
- play, 23
- private, 11, 48
- reply, 8, 28, 46
- re-record, 41, 47
- return receipt request, 11, 48
- review recording, 41, 47
- save, 27, 34
- saved message folder, 6, 7, 31
- send, 37
- special delivery options, 11
- types, 8
- urgent, 11, 48

- Msg button/LED, 83
- multiple destinations, 41, 44

N

- name
 - recording, 20, 66
- new/saved messages, 5, 31
- notification, 68

P

- pause/resume playback, 25, 27, 44, 46
- pause/resume recording, 38, 41
- personal
 - distribution list, 41, 44
 - folders, 78
 - greeting, 10
 - change your selection, 57
 - create, 55
 - record over, 55
 - review, 58
 - sample, 55
- play messages, 23
 - special functions, 29
- playback
 - back up (rewind), 25
 - change speed, 25
 - continuous delete, 30
 - continuous play, 32
 - go forward (advance), 25
 - next message, 25, 27, 34
 - pause/resume, 25, 27, 44, 46
 - previous message, 25, 28
 - replay, 28, 35
 - replay current message, 25
 - volume, 25
- private messages, 11, 48

R

record

busy greeting, 64

messages

append

comment, 45

recording, 42, 47

re-record

comment, 45

message, 41, 47

review

comment, 45

recording, 41, 47

name, 20, 66

pause/resume, 38, 41

personal greeting, 21

record to voice mail, 90

reply message, 8, 28, 46

set future delivery, 49

special functions, 48

return receipt request, 11, 48

S

save messages

personal folders, 27

security code, 17

change, 22, 62

send messages, 37

soft keys, 84

special delivery options

private, 48

return receipt request, 48

urgent, 48

special functions, 29, 48

continuous delete, 30

continuous play, 32

date/time, 30

future delivery review, 30

immediate print all faxes, 29

immediate print current fax, 29

new/saved folder, 31

send fax, 29

Strata 3000/2000 digital phones, 84

Strata CTX, 84

Strata DK24/56/96, 8/16 and 280 telephones

call forward, 126

message retrieval, 131

system

greeting, 10

T

text-to-speech, 33

Toshiba Proprietary Integration, 84, 136

Toshiba telephone systems, 132

tutorial, 17

Stratagy ES Advisor, x

U

unified messaging, 105

address book feature, 108

configuration, 109

forward voice message, 114

message received, 111

play voice message, 112

reply to voice message, 113

select message, 112

send voice message, 115

update address book automatically, 108

update address book manually, 108

view fax, 115

- voice mail options, [112](#)
- unified messaging (IP integration), [117](#)
 - configure windows for Strategy ES
 - Codec, [118](#)
 - record .wav file, [120](#)
 - send .wav file, [121](#)
- urgent messages, [11](#), [48](#)
- user options
 - automatic message copy, [70](#)
 - busy greeting, [14](#), [64](#)
 - call screening, [14](#), [61](#)
 - change, [59](#)
 - do not disturb, [14](#), [60](#)
 - message notification selection, [14](#), [68](#)
 - security code, [62](#)
- user prompts, [15](#)
- user tutorial, [17](#)

V

- voice mail conference, [91](#)
- volume control, [25](#), [27](#)

Free Manuals Download Website

<http://myh66.com>

<http://usermanuals.us>

<http://www.somanuals.com>

<http://www.4manuals.cc>

<http://www.manual-lib.com>

<http://www.404manual.com>

<http://www.luxmanual.com>

<http://aubethermostatmanual.com>

Golf course search by state

<http://golfingnear.com>

Email search by domain

<http://emailbydomain.com>

Auto manuals search

<http://auto.somanuals.com>

TV manuals search

<http://tv.somanuals.com>