Electromagnetic Flowmeter CAPACITANCE TYPE

MODEL LF516 / LF546

INSTRUCTION MANUAL

TOSHIBA CORPORATION**NOTES**

Before using the equipment, please read this manual carefully and understand the contents, and then use the equipment correctly.

- **NEVER attempt to operate the equipment in any ways that are not described in this instruction manual.**
- **After reading this manual, store it with care in a place where it can be referred to whenever needed.**
- **Please be sure that this manual is delivered to the personnel who will use this product.**

NOTICE

We thank you very much for your purchase of our LF516/LF546 CAPACITANCE TYPE series electromagnetic flowmeter.

This instruction manual describes the notes on using an electromagnetic flowmeter , installation, configuration and maintenance. It is intended for the personnel in charge of installation, operation and maintenance.

To use this product properly and safely, read this manual carefully before using this product. After reading this manual, store it in a place where it can be referred to whenever needed.

About a PROFIBUS communication function, please read each instruction manual.

For the notes on usage, piping, installation, configuration and maintenance of the combined detector, check the model number of the combined detector and read the instruction manual of the relevant detector.

About Safety Precautions

Read the **Safety Precautions** described at the front carefully and understand the contents before using this product.

The “**Safely symbols**” used in the “**Safety Precautions**” are shown in a location such as in the margin to the left of the corresponding commentary in the main text.

NOTES

- 1. The reproduction of the contents of this Manual in any form, whether wholly or in part, is not permitted without explicit prior consent and approval.**
- 2. The information contained in this Manual is subject to change or review without prior notice.**
- 3. Be sure to follow all safety, operating and handling precautions described in this Manual and the regulations in force in the country in which this product is to be used.**

First Edition Dec., 2009

SAFETY PRECAUTIONS



Safety signs and labels affixed to the product and/or described in this manual give important information for using the product safely. They help prevent damage to property and obviate hazards for persons using the product.

Make yourself familiar with signal words and symbols used for safety signs and labels. Then read the safety precautions that follow to prevent an accident involving personal injury, death or damage to property.

Explanation of signal words

The signal word or words are used to designate a degree or level of hazard seriousness.

The signal words used for the product described in this manual are **WARNING** and **CAUTION**.



 WARNING	Indicates a potentially hazardous situation which, if not avoided, could result in death or serious injury .
 CAUTION	Indicates a potentially hazardous situation which, if not avoided, may result in minor to moderate injuries or in property damage .

Notes:

- 1 “Serious injury” refers to **an injury such as loss of sight, physical damage, burns (high temperature or low temperature) electric shock, bone fracture and poisoning and the after effect of the injury remains or the injury requires hospitalization or long periods of outpatient treatment.**
- 2 “Minor to moderate injuries” refers to **burns, electric shocks, and so on, that do not require the injured person to be hospitalized or go to a hospital for a long period of time for medical treatment.** “Property damage” includes **all kinds of damage to property, equipment or materials.**

Safety symbols

The following symbols are used in safety signs and labels affixed to a product and/or in the manual for giving safety instructions.

	Indicates an action that is prohibited. Simply DON'T do this action. The prohibited action is indicated by a picture or text inside or next to the circle
	Indicates an action that is mandatory. DO this action. The mandatory action is indicated by a picture or text inside or next to the circle.
	Indicates a potential hazard. The potentially hazardous situation is indicated by a picture or text inside or next to the triangle.







Color explanation

WARNING  Background color: Yellow and Red, Border: Black, Picture display: Black











CAUTION  Background color: Yellow, Border: Black, Picture display: Black

SAFETY PRECAUTIONS (continued)

Safety Precautions for Hazardous Locations







 WARNING	
<p>■ Do not disconnect while circuit is live unless location is known to be nonhazardous.</p> <p> DON'T</p>	<p>Live part of electric circuit or a high temperature department can cause explosion.</p>
<p>■ Do not modify or disassemble the enclosure.</p> <p> DON'T</p>	<p>Strength degradation and defects of enclosure can cause explosion.</p>
<p>■ Do not use parts of other products.</p> <p> DON'T</p>	<p>Protective performance degradation for hazardous location can cause explosion.</p>
<p>■ Do not touch circuits until assembly of all components is over.</p> <p> DON'T</p>	<p>Protective performance degradation for hazardous location can cause explosion.</p>
<p>■ Install per the National Electrical Code for the US (NEC, ANSI/NFPA 70) and the Canadian Electrical code for Canada (CEC, CAN/CSA-C22.1) and the drawing 3S8A2699(Refer to Appendix 2).</p> <p> DO</p>	<p>Unsuitable conduit connections for hazardous location can cause explosion.</p>

Safety Precautions for Installation and Wiring

 CAUTION	
<p>■ Install a switch and fuse to isolate the LF516/LF546 from mains power.</p> <p style="text-align: center;"> DO</p> <p>Power supply from mains power can cause electric shock or circuit break-down.</p>	<p>■ Use an appropriate device to carry and install the LF516/LF546.</p> <p style="text-align: center;"> DO</p> <p>If this product falls to the ground, injury, or malfunction of or damage to the product, can be caused.</p>
<p>■ Use crimped terminal lugs for the terminal board and GND terminal.</p> <p style="text-align: center;"> DO</p> <p>Loose connections can cause electric shock, fire from excessive current or system malfunction.</p>	<p>■ Do not modify or disassemble LF516/LF546 unnecessarily.</p> <p style="text-align: center;"> DON'T</p> <p>Modifying or disassembling this product can cause electric shock, malfunction of or damage to this product.</p>
<p>■ Turn off mains power before conducting wiring work.</p> <p style="text-align: center;"> DO</p> <p>Wiring while power is applied can cause electric shock.</p>	<p>■ Ground LF516/LF546 independently from power equipment. (100 ohm or less ground resistance)</p> <p style="text-align: center;"> DO</p> <p>Operating this product without grounding can cause electric shock or malfunction.</p>
<p>■ Turn off mains power before working on pipes.</p> <p style="text-align: center;"> DO</p> <p>Working on pipes while power is applied can cause electric shock.</p>	<p>■ Do not work on piping and wiring with wet hands.</p> <p style="text-align: center;"> DON'T</p> <p>Wet hands may result in electric shock.</p>
<p>■ Do not conduct wiring work with bare hands.</p> <p style="text-align: center;"> DON'T</p> <p>Remaining electric charge even if power is turned off can still cause electric shock.</p>	
<div style="border: 1px dashed black; padding: 10px; display: inline-block;">  <p>The label shown left is placed near the terminal board for power supply on the converter. Be alert to electric shock.</p> </div>	

SAFETY PRECAUTIONS (continued)

Safety Precautions for Maintenance and Inspection

 CAUTION	
<p>■ Do not touch LF516/LF546 main body when high temperature fluid is being measured.</p> <p> The fluid raises the main body temperature and can cause burns when touched.</p> <p>DON'T</p>	<p>■ Do not conduct wiring work when power is applied.</p> <p> Wiring while power is applied can cause electric shock.</p> <p>DON'T</p>
<p>■ Do not conduct wiring work with wet hands.</p> <p> Wet hands may result in electric shock.</p> <p>DON'T</p>	<div style="border: 1px dashed black; border-radius: 10px; padding: 10px;"> <p> The label shown left is placed near the terminal board for power input. (A black border and symbol on yellow triangle) Be alert to electric shock.</p> </div>
<p>■ Do not use a fuse other than the one specified.</p> <p> Using a fuse other than the one specified can cause system failure, damage or malfunction.</p> <p>DON'T</p>	<p>Use a rated fuse as follows:</p> <p>Fuse rating:</p> <ul style="list-style-type: none"> • 0.8A/250V for 100 to 240Vac <p>Dimensions:</p> <p style="padding-left: 20px;">Diameter 5.2 mm × 20 mm</p> <p>Melting time characteristic:</p> <ul style="list-style-type: none"> • Time Lag Fuses for 100 to 240Vac

Usage limitation

This product is **not manufactured for applying to a system requiring safety directly involved human life as follows**. Please contact your nearest Toshiba representative if there is a possibility of using this product for such use.

- **Main control systems of nuclear power plants, safety protection systems in nuclear facilities or other important systems requiring safety**
- **Medical control systems relating to life support**

Warranty and Limitation of Liability

Toshiba does not accept liability for any damage or loss, material or personal, caused as a direct or indirect result of the operation of this product in connection with, or due to, the occurrence of any event of force majeure (including fire or earthquake) or the misuse of this product, whether intentional or accidental.

Handling Precautions

To obtain the optimum performance from LF516/LF546 flowmeter for years of continuous operation, observe the following precautions.

(1) **Do not store or install** the flowmeter in :

- **Where there is direct sunlight.**
- Where **excessive vibration or mechanical shock occurs.**
- Where **high temperature or high humidity** conditions obtain.
- Where **corrosive atmospheres** exist.
- That can be **places submerged under water.**
- **Where there is a sloped floor.** To put the flowmeter temporarily on the floor, place it **carefully with something, such as a block, to support it so that the flowmeter will not topple over.**
- **Places where there is following factors.**

Factors to impede infrared switch to operate properly

- Intense light such as direct sunlight and reflected sunlight by window glass or metal plate
- Place where brightness changes suddenly such as ON/OFF of lighting
- Dense smoke or steam near the control panel
- Those attached on the control panel such as rain (dew drop), snow, ice, mud and oil, and haze due to their attachment
- Light reflecting object near the control panel, or reflecting object such as metal plate placed opposing to the control panel

When any of above factors is considered, take a measure for the proper operation of infrared switch such as to place a cover or to secure a space for at least a person to stand in front of the control panel.

When unable to avoid above factors, operate the EMF converter removing the factor by covering the control panel by hand so that light does not shine on it, by cleaning those attached on the control panel, or by standing in-between the reflecting object and the control panel to block the light.

(2) Wire cables **correctly and securely.**

Be sure to ground at the combined converter side (**grounding resistance 100Ω or less**). Avoid a common ground **used with other equipment** where earth current may flow. An **independent ground** is preferable

(3) Select cable paths away from electrical equipment (motors, transformers, or radio transmitters), which causes electromagnetic or electrostatic interference.

(4) The cable lead-in section must be tightened securely to keep air tightness.

NOTE : The cable connections are not provide with flowmeter. Because 1/2-14NPT screw holes are processed to this place, please prepare yourself for the cable connections.

(5) If the inside of the converter or cable terminals are wetted or humidified, it may cause insulation deterioration, which can result in **fault or noise occurrence**. So do not conduct **wiring in the open air on rainy days**.

Also, be careful not to wet down the converter even in the case of indoor wiring, and complete wiring work in a short period of time.

Handling Precautions (continued)

- (6) **Observe the following precautions when you open the converter housing cover:**
- **Do not open the cover in the open air unprotected against rain or wind.** This can cause **electric shock** or cause **damage to the flowmeter electronics**.
 - **Do not open the cover under high ambient temperature or high humidity conditions or in corrosive atmospheres.** This can cause **deterioration of system accuracy** or cause **damage to the flowmeter electronics**.
- (7) Since a varistor is built in converter, **do not conduct a withstand voltage test for the converter.**
In addition, the voltage for checking the insulation of the converter must be **250VDC or lower.**
- (8) This product may cause **interference to radio and television sets** if they are used near the installation site. **Use metal conduits etc. for cables to prevent this interference.**
- (9) Radio transmitters such as transceivers or cellular phones may cause interference to the flowmeter if they are used near the installation site. Observe the following precautions when using them:
- **Close a transmitter cover** before using a transceiver.
 - Do not use a transceiver whose output power is more than **5 W**.
 - Move the antenna of a transceiver or a cellular phone **at least 50 cm** away from the flowmeter and signal cables when using it.
 - **Do not use a radio transmitter or a cellular phone near the flowmeter** while it is operating online. The transmitter or cellular phone's output impulse noise may interfere with the flowmeter.
 - **Do not install a radio transmitter antenna** near the flowmeter and signal cables.
- (10) For reasons of flowmeter failure, inappropriate parameters, unsuitable cable connections or poor installation conditions, the flowmeter may not operate properly. To prevent any of these problems causing a system failure, **it is recommended that you have preventive measures designed and installed on the flowmeter signal receiving side.**

- * **We assume no responsibility for nonconformity caused by violation of precautions described in this manual or used in violation of the installation method and the operation method stipulated in a relevant ordinance or other regulations.**

Table of Contents

1.	Product Inspection and Storage.....	11
1.1	Product Inspection.....	11
1.2	Storage.....	11
2.	Overview.....	12
3.	Names of Parts.....	13
3.1	Appearance OF LF516/LF546.....	13
3.2	Construction of the terminal blocks.....	14
4.	Installation.....	15
4.1	Notes on Selecting the Installation Location.....	16
4.2	Mounting Procedure.....	17
4.2.1	Pipe checks.....	17
4.2.2	Installation Procedure.....	19
4.3	Piping Connections.....	21
4.4	Grounding.....	24
5.	Wiring.....	25
5.1	Cables.....	27
5.2	External Device Connections and Grounding.....	28
5.3	Notes on Wiring.....	29
5.4	Wiring.....	30
5.4.1	Terminal Treatment of Cables.....	30
5.4.2	Cable Connection.....	31
5.5	Digital I/O Connections.....	32
6.	Operation.....	33
6.1	Preparatory check.....	33
6.2	Zero Adjustment.....	34
7.	LCD Display and Controls.....	35
7.1	Name and Function of Each Part of LCD Display.....	35
7.2	Display Format.....	38
7.3	Basic operations.....	42
7.3.1	Mode Change.....	42
7.3.2	Setting and Calibration.....	46
7.4	Configuration Items Selection Table.....	50
7.5	Password input.....	52
8.	Parameter Settings.....	53

8.1	Parameter Setting Items.....	53
8.2	Check/Change of Parameters.....	54
8.2.1	Menu Configuration Selection Screen.....	54
8.2.2	Exciting Current Value.....	55
8.2.3	Meter Size.....	56
8.2.4	Exciting Frequency.....	58
8.2.5	Flow Direction Setting.....	58
8.2.6	Display Setting.....	59
8.2.7	Custom Coefficient Setting.....	63
8.2.8	Custom Unit Setting.....	64
8.2.9	Span (Range).....	65
8.2.10	Damping Constant.....	71
8.2.11	Rate-Of-Change Limit and Control Limit Time.....	72
8.2.12	Low Cutoff.....	74
8.2.13	Display Low Cutoff.....	75
8.2.14	Still Water Zero Adjustment.....	76
8.2.15	Manual Zero Adjustment.....	77
8.2.16	4-20mA Alarm Output Setting.....	78
8.2.17	Output Low Limit Setting.....	79
8.2.18	Digital Output.....	80
8.2.19	Digital Input.....	82
8.2.20	Count Rate (Pulse Rate), Pulse Width Setting Mode and Pulse Width.....	84
8.2.21	Preset Count.....	87
8.2.22	Preset Mode.....	89
8.2.23	Flow Rate High/Low Alarm and High-High/Low-Low Alarm.....	90
8.2.24	Mag-Prover-Self Diagnosis ON/OFF Setting.....	92
8.2.25	Fixed Value Output.....	93
8.2.26	Password Setting.....	96
8.2.27	LCD Adjustment.....	98
8.2.28	Switch Position Setting.....	99
8.2.29	Communication Setting.....	100
8.3	Parameter initial settings list.....	101
9.	Mag-Prover-Calibration.....	103
9.1	Calibration Items.....	103
9.2	Converter Using Mag-Prover's Built-In Signal Source.....	104
9.2.1	0 % Flow Rate Calibration (Zero Calibration).....	104
9.2.2	50 % Flow Rate Calibration.....	105
9.2.3	100 % Flow Rate Calibration (Span Calibration).....	105
9.2.4	Checking the Excitation Current.....	105
10.	Functional Description.....	106
10.1	Digital I/O Specifications.....	107
10.2	Totalizer and Pulse Output.....	108
10.3	Multi-range Function.....	112
10.4	Flow Rate High/Low, High-High/Low-Low Alarm Output.....	117
10.5	Preset Count Function.....	119
10.6	Remote Zero Adjustment.....	124
10.7	Remote Selection of Fixed Value Output.....	124
10.8	Converter Failure Alarm.....	125
10.9	Multiple range high/low limit alarm function (option).....	126
10.10	Custom unit function.....	128

11. Communications Function	131
11.1 Connections with HHT Terminal	131
11.2 Procedures for Communication with HHT	132
11.3 Notes on Communications	133
12. Self-Diagnosis and Alarms	134
12.1 Self-Diagnosits	134
12.2 Output Status for Errors and Alarms.....	137
13. Maintenance and Troubleshooting	138
13.1 Maintenance	139
13.2 Troubleshooting	140
13.2.1 Flow rate is not indicated.....	140
13.2.2 Flow rate indication is not correct.....	141
13.2.3 Flow rate indication is not stable.....	142
13.2.4 When switch operation is unable.....	143
14. Principle of Operation	144
15. Specifications	145
15.1 Specifications	145
15.2 Model Number Table	149
16. Outline Drawing	151
Appendix 1	152
Appendix 2	154

1. Product Inspection and Storage

1.1 Product Inspection

LF516/LF546 electromagnetic flowmeter is shipped in a cardboard container filled with shock-absorbing materials. Open the package carefully and check as follows:

- Make sure the following items are included in the package.
- Inspect the flowmeter for indications of **damage** that may have occurred during shipment.
- Make sure the type and specifications of the flowmeter are in accordance with the **ordered specifications**.

If you cannot find the items listed above or any problem exists, contact your nearest Toshiba representative.

1.2 Storage

To store the electromagnetic flowmeter after opening the package, select a storing place as follows and keep it under the conditions described below:

CAUTION

- (1) Avoid places where there is **direct sunlight, rain or wind**.
- (2) Store the product in a well-ventilated place. Avoid places of **extremely high humidity** or **extremely high or low temperature**. The following environment is recommended:
 - **Humidity range: 10 to 90% RH (no condensation)**
 - **Storage temperature: -25 to +65° C**
- (3) Avoid places where **vibrations or mechanical shock occur**.
- (4) If it leaves the cover of converter open while being stored, gradual deterioration of circuit isolation can be caused. And then **don't open the cover** until it is connected with wires.
- (5) To put the flowmeter temporarily on the floor, **place it carefully with something, such as stopper, to support it so that the flowmeter will not topple over**.

2. Overview

LF516/LF546 electromagnetic flowmeter can be use in the following hazardous (classified) locations.

Class , Division 2, Groups A, B, C and D,
 Class , Division 2, Groups E, F and G
 Class

This product is electromagnetic flowmeter that measure the volumetric flow rate of conductive fluid using Faraday's law of electromagnetic induction.

The device consists of two units: the detector, through which the fluid to be measured flows, and the converter, which receives the electromotive force signals from the detector, then converts the signals into the 4–20 mA dc signal.

Features

With a **linear relationship between the flow rate and output signal**, the electromagnetic flowmeter is featured as an easy-to-read indicator. In addition to this feature, it has the following outstanding features:

- (1) Low electric conductivity fluid (**Electric conductivity 0.01 μ S/cm or more**) can be measured
- (2) Wide flow velocity range setting, such as a flow velocity range of 0~0.5 and 0~10m/s, is achieved.
- (3) This flowmeter can be used to measure fluid even if it contains high concentration of slurry
 - **Ceramics** is used for the detector pipe as standard.
 - **The unique Noise-Sentry filter circuit and its advanced Arithmetic Logic Unit (ALU)** enables you to obtain a **stable output**.
- (4) Full graphic electronically rotatable LCD that enables display of a large amount of information
 1. With a large amount of a maximum of 9 characters x 7 lines, you can easily check various displays including bar graphs and alarm indications.
 2. The backlight allows you to read the indicator easily.
- (5) Use of infrared switches
 - Use of infrared switches allows you to perform various operations, without opening the converter housing cover.
- (6) **Intelligent functions**
 - The widely used **HART protocol^{*1} communications system** is used as a standard feature.
 - This product supports **PROFIBUS^{*2} communication** by option.

* 1 HART protocol: "HART" stands for Highway Addressable Remote Transducer and is a communication protocol recommended by HCF (HART communication Foundation) for industrial sensors.

* 2 PROFIBUS: PROFIBUS, which stands for PROCESS FIELDBUS, is a kind of field bus that is approved by international standard IEC61158. The electromagnetic flowmeter supports PRFIBUS PA for process automation.

3. Names of Parts

IMPORTANT

The cable connections are not provided in the conduit port of this apparatus.
Please prepare yourself for the cable connections, which could be used in Division2 hazardous locations.

3.1 Appearance of LF516/LF546

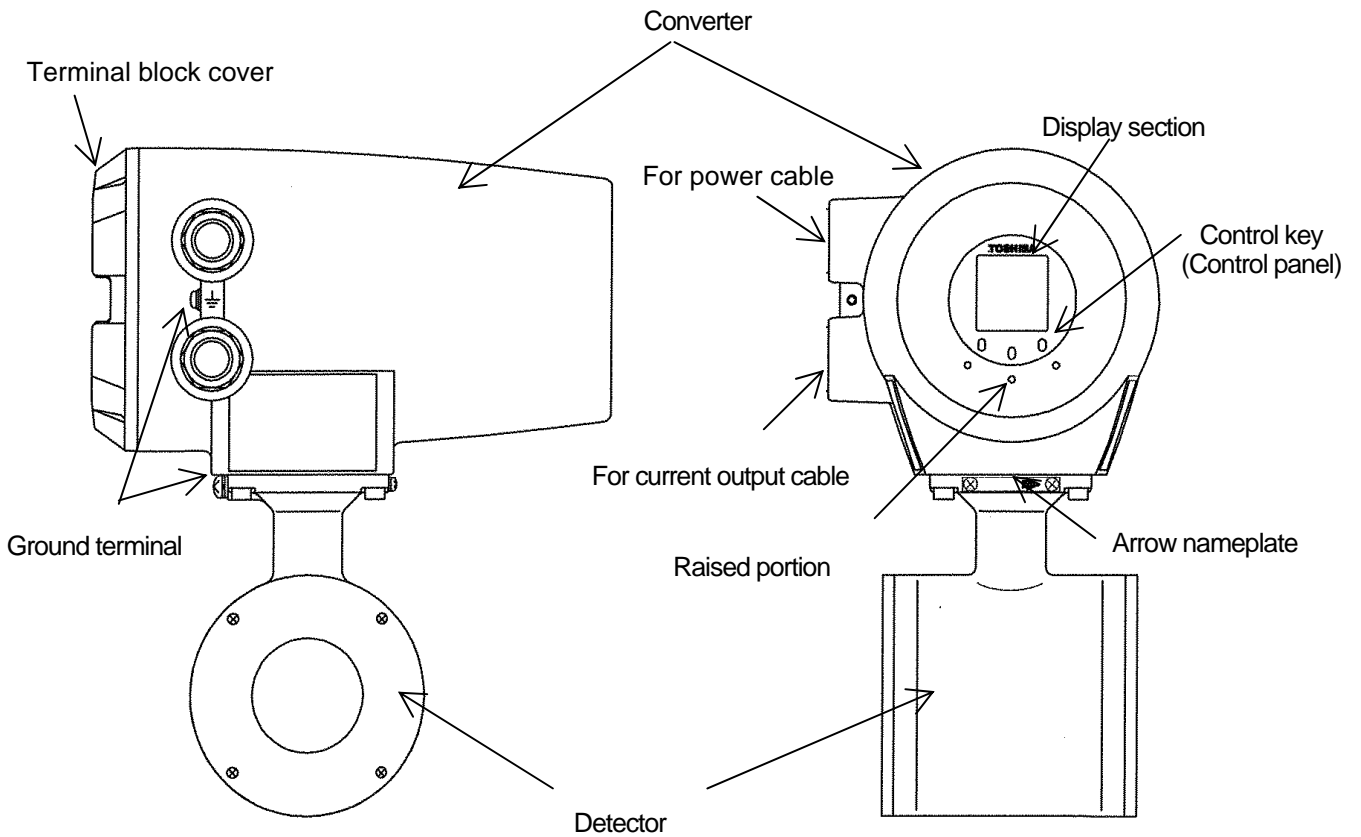
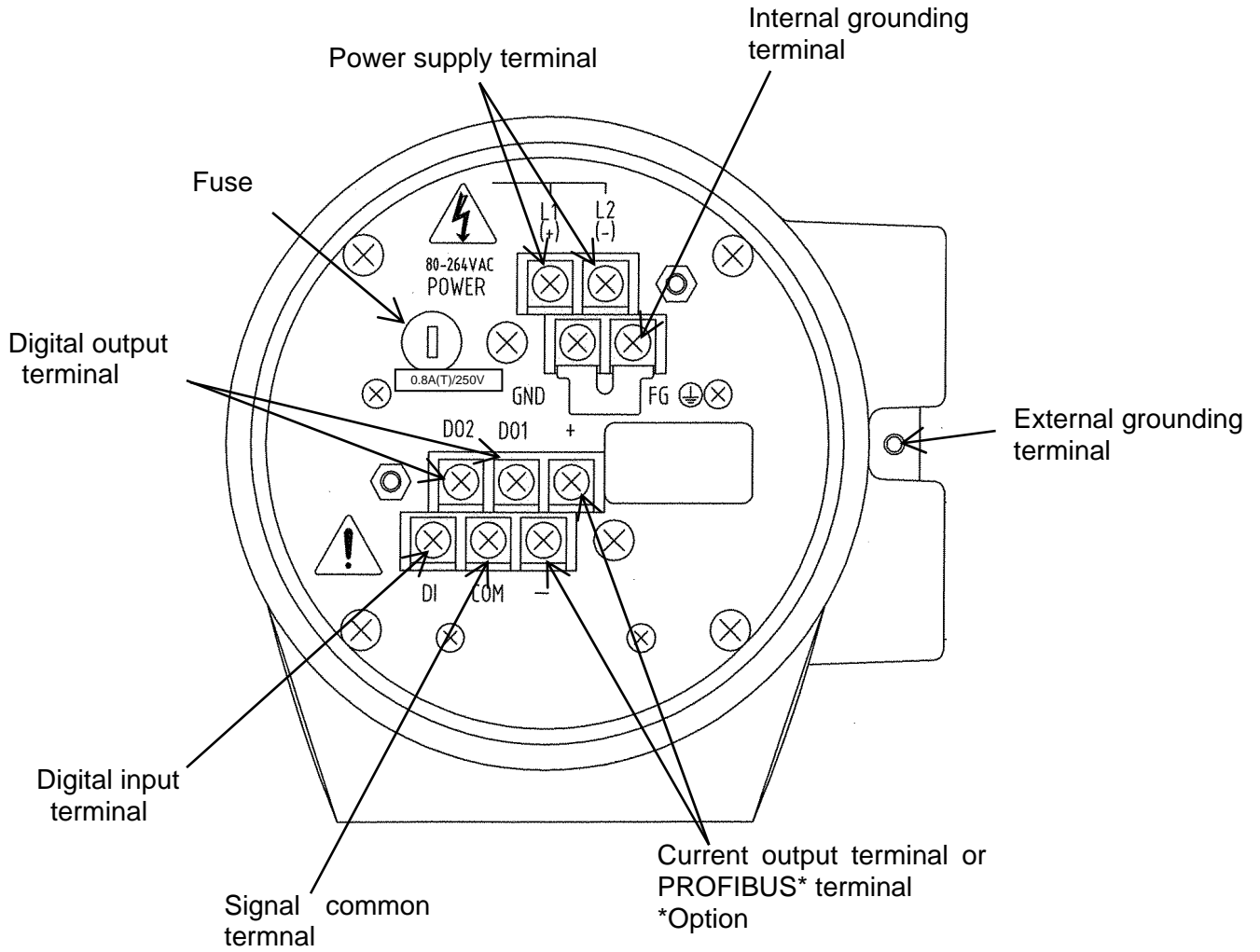

Figure 3.1.1 Appearance of LF516/LF546

3.2 Construction of the terminal blocks

Terminal Block Construction of LF546 Converter

When you remove the terminal block cover shown in the figure "Appearance of LF516/LF546", you can see the converter terminal block as shown below.

















 CAUTION	
	The label shown left is placed near the terminal board for power supply to this equipment. Be alert to electric shock.

Figure 3.2 Terminal Block Construction of LF546

4. Installation

Safety Precautions for Installation

 WARNING	
<p>■ Do not activate live circuits under environment of explosive atmospheres.</p> <p> DON'T</p>	<p>Live part of electric circuit or a high temperature department can cause explosion.</p>
<p>■ Do not use parts of other products.</p> <p> DON'T</p>	<p>Protective performance degradation for hazardous location can cause explosion.</p>
<p>■ Do not activate circuits While assembly of all components is not over.</p> <p> DON'T</p>	<p>Protective performance degradation for hazardous location can cause explosion.</p>
<p>■ Install per the National Electrical Code for the US (NEC, ANSI/NFPA 70) and the Canadian Electrical code for Canada (CEC, CAN/CSA-C22.1) and the drawing 3S8A2699 (Refer to Appendix 2.).</p> <p> DO</p>	<p>Unsuitable conduit connections for hazardous location can cause explosion.</p>

 CAUTION	
<p>■ Turn off mains power before working on pipes.</p> <p> DO</p> <p>Working on pipes while power is applied can cause electric shock.</p>	<p>■ Use an appropriate device to carry and install the LF516/LF546.</p> <p> DO</p> <p>If his product falls to the ground, injury, or malfunction of or damage to the product, can be caused.</p>
<p>■ Do not modify or disassemble the unnecessarily.</p> <p> DON'T</p> <p>Modifying or disassembling this product can cause electric shock, malfunction or damage to this product.</p>	<p>■ Ground the LF516/LF546 independently from power equipment. (100 ohm or less ground resistance)</p> <p> DO</p> <p>Operating this product without grounding can cause electric shock or malfunction.</p>
<p>■ Do not work on piping and wiring with wet hands.</p> <p> DON'T</p> <p>Wet hands may result in electric shock</p>	<p></p> <p>The label shown left is placed near the terminal board for power supply to the converter. Be alert to electric shock</p>

4.1 Notes on Selecting the Installation Location

This product is designed for the following environment.

- Indoor and outdoor installation
- Ambient temperature: - 10 to + 50
- Altitude: Up to 2000m
- Humidity range: 10 to 90% (no condensation)
- Regulation of power voltage: $\pm 10\%$
- Pollution degree 2
- Structure: IP67 and NEMA 4X

Do not store or install the flowmeter in :

1. Places within the immediate proximity of equipment producing electrical interference (such as **motors, transformers, radio transmitters, electrolytic cells, or other equipment causing electromagnetic or electrostatic interference**).
2. **Where there is direct sunlight.**
3. Where **excessive vibration or mechanical shock occurs.**
4. Where **high temperature or high humidity** conditions obtain.
5. Where **corrosive atmospheres** exist.
6. **That can be submerged under water.**
7. **Where there is a sloped floor.** To put the flowmeter temporarily on the floor, place it **carefully with something, such as a block, to support it so that the flowmeter will not topple over.**
8. Places of **too great an elevation or constricted areas** where clearance for installation or maintenance work is not provided.
9. Avoid places where fluid runs in a pulsating form.
10. Design piping so that the detector pipe is always filled with fluid, whether the fluid is flowing or not.
11. The detector has no adjustable piping mechanism. Install an adjustable short pipe where needed.
12. Chemical injections should be conducted on the downstream side of the flowmeter.
13. **Places where there is following factors.**
Factors to impede infrared switch to operate properly
 - Intense light such as direct sunlight and reflected sunlight by window glass or metal plate
 - Place where brightness changes suddenly such as lighting being turned ON/OFF
 - Dense smoke or steam near the control panel
 - Those attached on the control panel such as rain (dew drop), snow, ice, mud and oil, and haze due to their attachment
 - Light reflecting object near the control panel, or reflecting object such as metal plate placed opposing to the control panel

When any of above factors is considered, take a measure for the proper operation of infrared switch such as to place a cover or to secure a space for at least a person to stand in front of the control panel.

When unable to avoid above factors, operate the EMF converter removing the factor by covering the control panel by hand so that light does not shine on it, by cleaning those attached on the control panel, or by standing in-between the reflecting object and the control panel to block the light.

4.2 Mounting Procedure

1. Avoid places within the immediate proximity of equipment producing electrical interference (such as **motors, transformers, radio transmitters, electrolytic cells, or other equipment causing electromagnetic or electrostatic interference**).
2. **Avoid places where excessive pipe vibration occurs.**
3. Avoid places where fluid runs in a pulsating form.
4. Avoid places where there is **direct sunlight**. If this is unavoidable, use an appropriate **shade**
5. Avoid places where **corrosive atmospheres** or **high humidity conditions** obtain.
6. Avoid places of **too great an elevation or constricted areas** where clearance for installation or maintenance work is not provided.
7. Design piping so that the detector pipe is always filled with fluid, whether the fluid is flowing or not.
8. The detector has no adjustable piping mechanism. Install an adjustable short pipe where needed.
9. Chemical injections should be conducted on the downstream side of the flowmeter.

4.2.1 Pipe checks

(1) Before installing pipes, check for any leaning or misplacement (or eccentricity) as illustrated in Figure 4.1. An attempt to unreasonably connecting pipes that are inclined may lead to a detector breakdown or fluid leakage. Connecting pipes in an eccentric state may also cause local wears and tears of linings and grounding rings, as well as measurement errors. Before installing pipes, make sure to flash the interior of the pipes to remove deposited matters.

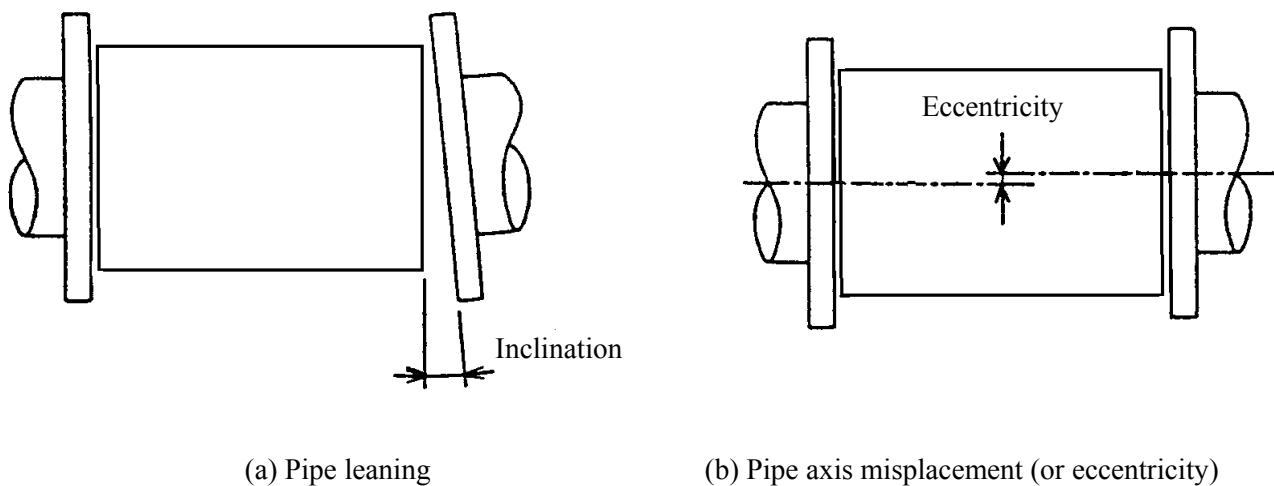

Figure 4.1 Pipe leaning and axis misplacement

(2) Preventing an Empty Pipe Condition

Fix the relevant pipes installed on both sides of the detector by attach fittings, etc. to support the pipe. By supporting the pipes, not only the pipe vibration is reduced but also the damage to the pipes by the electromagnetic flowmeter's weight and the fluid mass (see Figures 4.2 and 4.3).

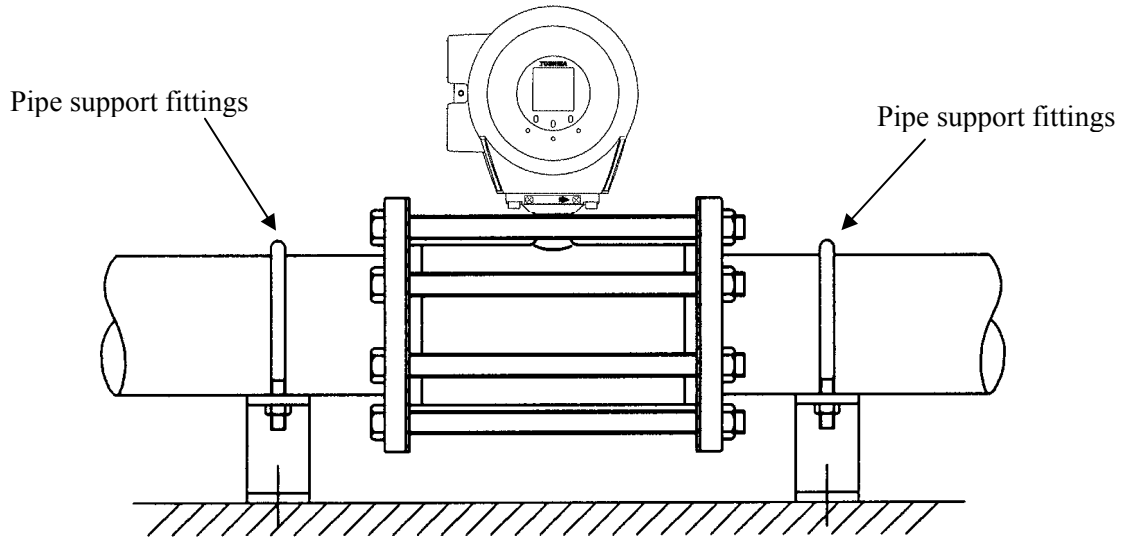

Figure 4.2 Example of Pipe Fixing Procedure

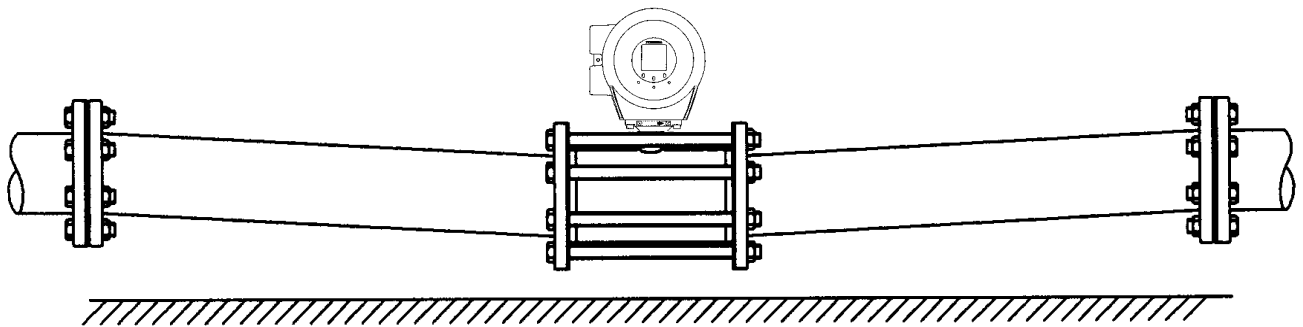

Figure 4.3 Model Diagram of Unsupported Pipes

4.2.2 Installation Procedure

To mount the LF516/LF546, place it between the upstream and downstream pipe flanges and tighten it with flange bolts and nuts. See Figure 4.4 and follow the procedure below:

1. Insert two lower mounting bolts through the clearance holes in the upstream (or downstream) pipe flange.
2. Install a packing next to the upstream (or downstream) flange face and the other packing next to the downstream (or upstream) pipe flange. The two mounting bolts can now be guided through the clearance holes in the downstream packing and flange.
3. Place the LF516/LF546 flowmeter detector between the two flange packings, with the flowmeter detector body above the two bolts. The flowmeter must be oriented in accordance with the flow direction arrow.
4. Install the two upper mounting bolts through the clearance holes in the upstream and downstream packings and flanges. Then install the remaining mounting bolts depending on the flange pattern used.
5. Thread nuts on both ends of the 4 (or more) mounting bolts, finger tight. **(See Table 4.1 Bolt length and tightening torque)**
6. While centering the flowmeter with the longitudinal axis of the pipeline, tighten the nuts with a wrench diagonally across in even increments. **(See Table 4.1 Bolt length and tightening torque)**

Note that the flowmeter detector pipe axis must be aligned with the pipeline axis on both upstream and downstream sides. This is essential to have stable characteristics of flow measurement (especially for flowmeters with meter sizes of 50 mm or less).

IMPORTANT

When high-temperature fluid is being measured, radiant heat from the detector pipe surface and adjoining pipes may cause the ambient temperature of the converter to go above 50 °C. If the ambient temperature goes above 50° C, try to lower the temperature by measures such as wrapping heat-insulating materials over the detector pipe and adjoining pipes.

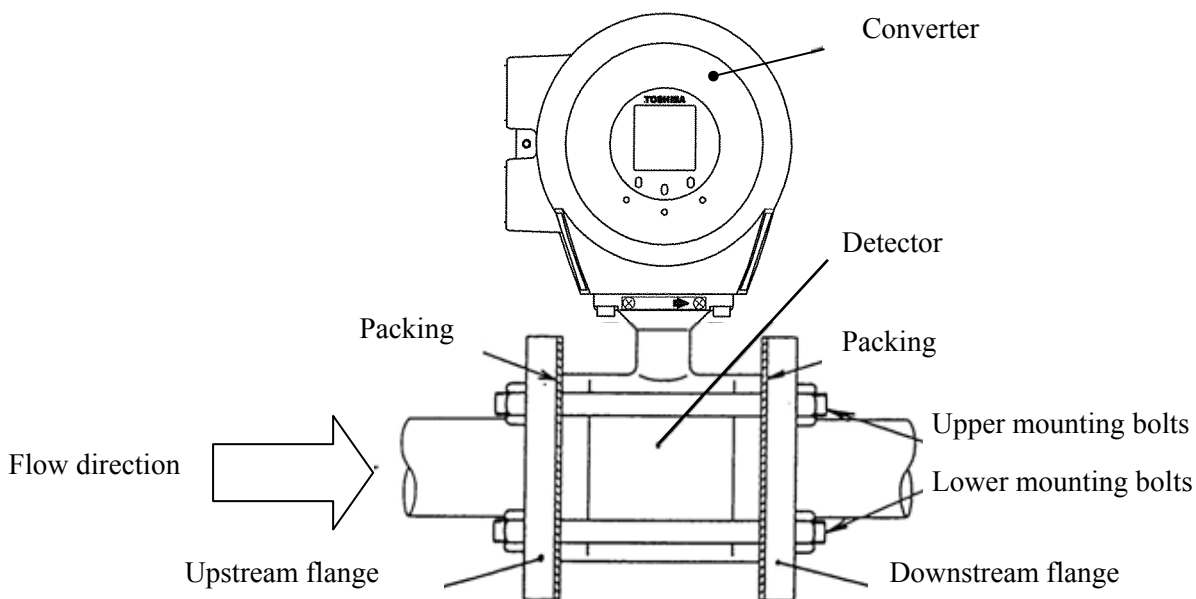

Figure 4.4 LF516/LF546 flowmeter piping connections

Table 4.1 Bolt length and Nut tightening torque

Meter size		ANSI class 150				ANSI class 300			
		Through Bolts			Tightening torque [N·m]	Through Bolts			Tightening torque [N·m]
		P.C.S	Dia-meter	Length [mm]		P.C.S	Dia-meter	Length [mm]	
15mm	1/2"	4	1/2"	150	12 to 15	4	1/2"	155	25 to 31
25mm	1"	4	1/2"	170	21 to 26	4	5/8"	180	53 to 66
40mm	1 1/2"	4	1/2"	195	32 to 40	4	3/4"	215	96 to 120
50mm	2"	4	5/8"	215	52 to 65	8	5/8"	220	52 to 65
80mm	3"	4	5/8"	225	71 to 88	8	3/4"	240	85 to 106
100mm	4"	8	5/8"	235	52 to 65	8	3/4"	255	125 to 156

Meter size		DIN/BS 10, DIN/BS 16				JIS 10K			
		Through Bolts			Tightening torque [N·m]	Through Bolts			Tightening torque [N·m]
		P.C.S	Dia-meter	Length [mm]		P.C.S	Dia-meter	Length [mm]	
15mm		4	M12	150	16 to 19	4	M12	150	10 to 13
25mm		4	M12	165	27 to 34	4	M16	170	22 to 28
40mm		4	M16	190	58 to 72	4	M16	190	32 to 40
50mm		4	M16	205	78 to 98	4	M16	200	43 to 53
80mm		8	M16	210	54 to 67	8	M16	210	27 to 34
100mm		8	M16	220	79 to 99	8	M16	215	37 to 46

4.3 Piping Connections

(1) Required Pipe Length

If various joints are used upstream of the detector outlet, the straight pipe length as shown in Table 4.2 is required.

Table 4.2 Required straight pipe length on the upstream side

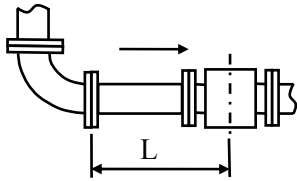
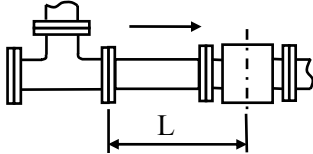
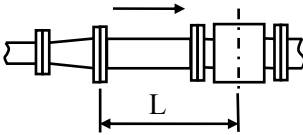
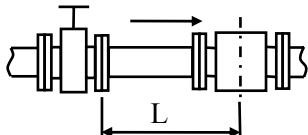
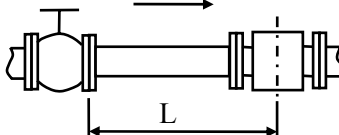
L=5D	L=10D
<p>(1) 90 ° bent</p>  <p>(2) Tee</p>  <p>(3) Diffuser</p>  <p>(4) Fully opened sluice valve</p> 	<p>(5) Other valves (not fully opened)</p> 

L: Required straight pipe length—straight pipe length plus half length of the detector.
D: Nominal bore size (diameter)

NOTES

The length of a reducer, if connected, can be counted as a part of the straight pipe length.
 No straight pipe length is needed on the downstream side. If a butterfly valve is installed downstream of the detector, do not let the valve plate protrude into the pipe of the detector

(2) Pipe Orientation

The detector may be installed in horizontal, vertical or sloping pipe runs as shown in Figure 4.5. However, except for horizontal installation, fluid should flow from lower to upper directions. See Figure 4.5.

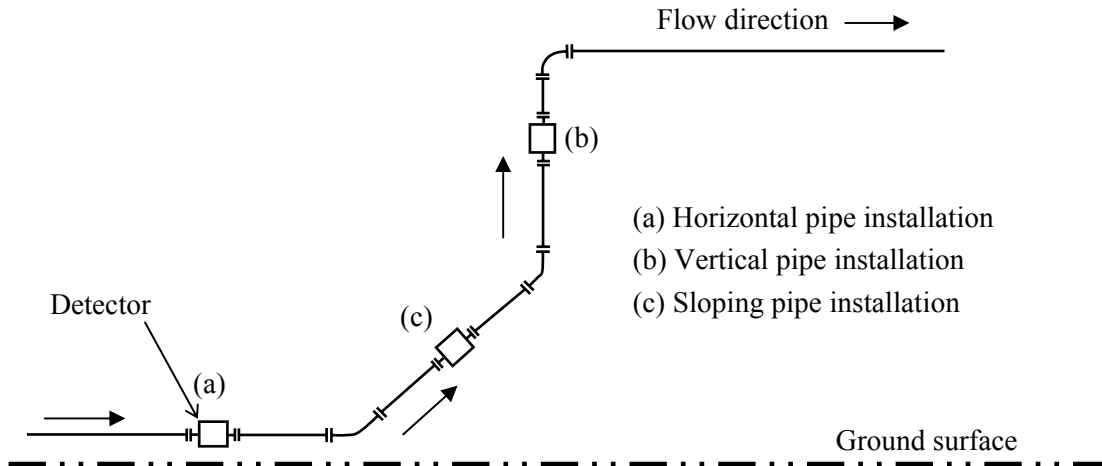

Figure 4.5 Detector Piping Orientation

The electrodes should be positioned horizontally against the ground surface in any piping installation. See Figure 4.6.

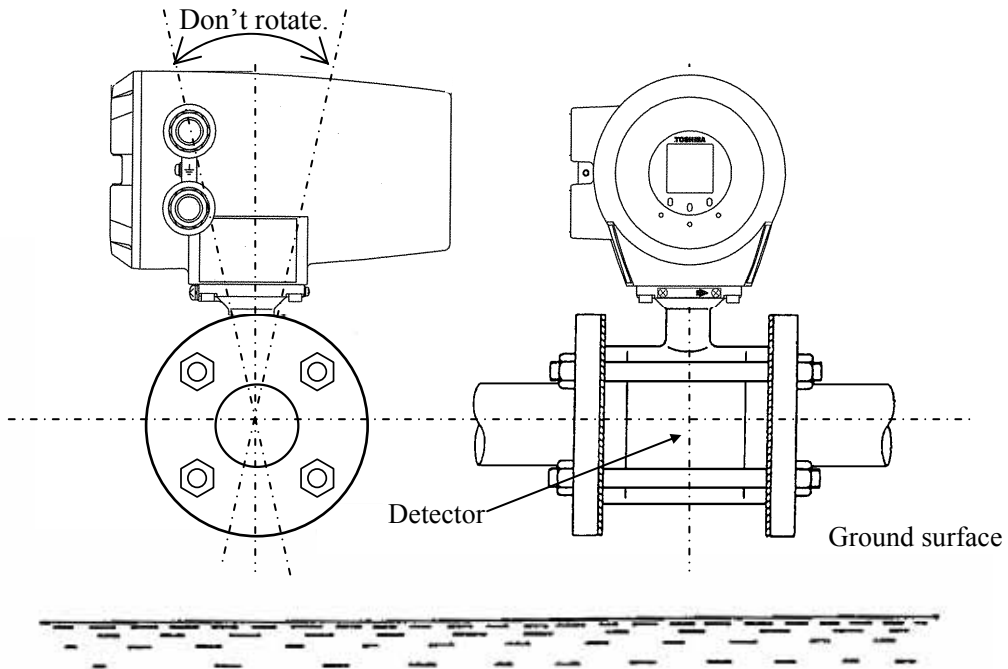

Figure 4.6 Installation position of the detector

(3) Flow Direction

Install the detector in accordance with the flow direction arrow on the detector. See Figure 4.7. If the actual flow runs opposite to the specified flow direction, the following display and output appears.

For single range measurement,

- LCD display: Instantaneous flow rate ----- indicates negative values,
Totalized flow ----- no counts added.
- Output: Current output ----- 4.0mA output,
Pulse output ----- No pulses

For bidirectional range measurement, the flow in opposite direction results in a positive output value. See 10.3, “Multi-range Functions.”

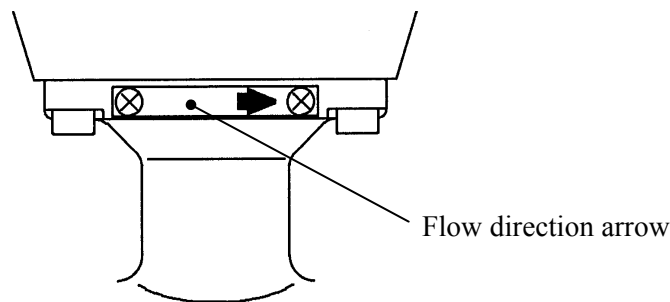

Figure 4.7 Flow direction arrow on the detector

(4) Preventing an Empty Pipe Condition

Design an upright pipe run (Figure 4.8) or sufficient head pressure (Fig. 4.9) at the downstream detector outlet if there is a possibility of the detector pipe becoming emptied.

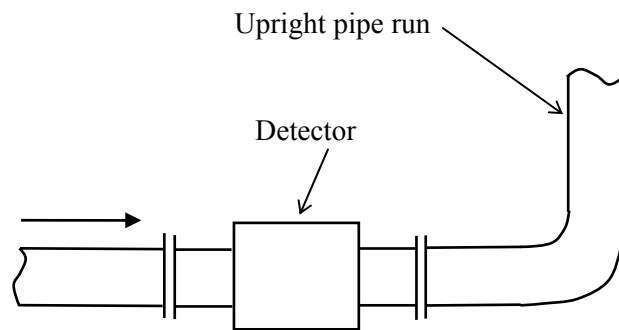

Figure 4.8 Detector with an upright pipe run at downstream outlet

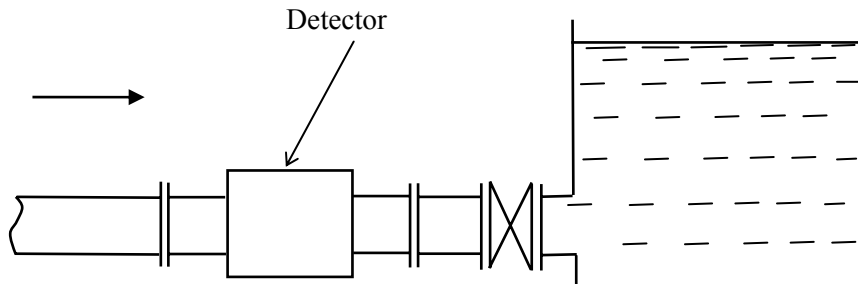



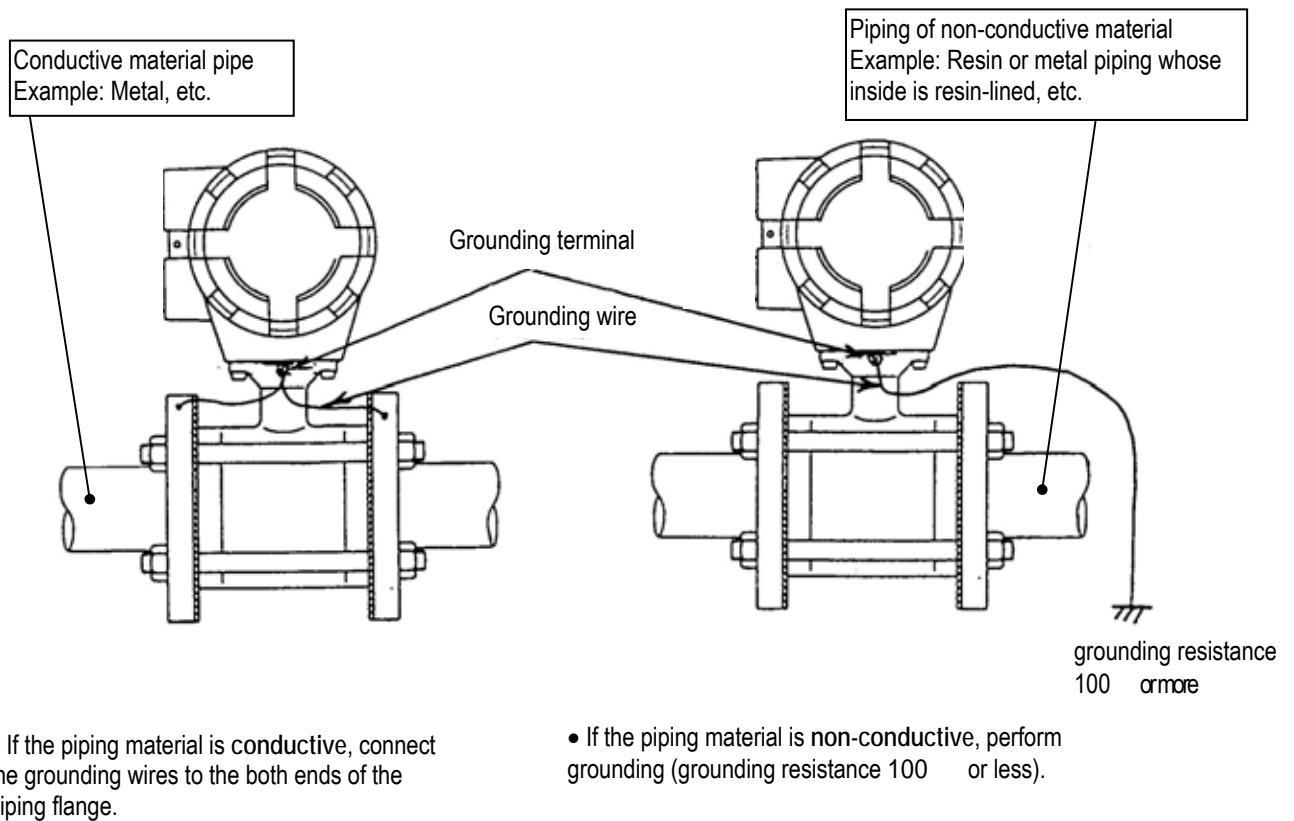

Figure 4.9 Detector with sufficient head pressure at downstream outlet

4.4 Grounding

 CAUTION	
<p>■ Do not wire cables and replace parts when power is supplied.</p> <p> Wiring work and replacing parts in the power-on state may cause electric shock.</p> <p>DON'T</p>	<p>■ Do not work on piping and wiring with wet hands.</p> <p> Wet hands may result in electric shock.</p> <p>DON'T</p>

Ground as shown in Figure 4.10. Make the grounding wire as short as possible. Use **grounding wire material of IV wire 5.5mm² or more**. Do not share a grounding wire with other instruments where grounding current may flow. (An independent grounding is preferable.)







- If the piping material is **conductive**, connect the grounding wires to the both ends of the piping flange.









- If the piping material is **non-conductive**, perform grounding (grounding resistance 100 or less).

Figure 4.10 Grounding the LF516/LF546 Type

5. Wiring

Notes on wiring

 WARNING	
<ul style="list-style-type: none">■ DO NOT DISCONNECT WHILE CIRCUIT IS LIVE UNLESS LOCATION IS KNOWN TO BE NONHAZARDOUS.	 DON'T
<p>Live part of electric circuit or a high temperature department can cause explosion.</p>	
<ul style="list-style-type: none">■ Do not activate circuits while assembly of all components is not over.	 DON'T
<p>Protective performance degradation for hazardous location can cause explosion.</p>	
<ul style="list-style-type: none">■ Install per the National Electrical Code for the US (NEC, ANSI/NFPA 70) and the Canadian Electrical code for Canada (CEC, CAN/CSA-C22.1) and the drawing 3S8A2699 (Refer to Appendix 2).	 DO
<p>Unsuitable conduit connections for hazardous location can cause explosion.</p>	

 CAUTION	
<p>■ Install a switch and fuse to isolate the LF516/LF546 from mains power.</p> <p> Power supply from mains power can cause electric shock or circuit break-down.</p> <p>DO</p>	<p>■ Turn off mains power before conducting wiring work.</p> <p> Wiring while power is applied can cause electric shock.</p> <p>DO</p>
<p>■ Do not work on piping and wiring with wet hands.</p> <p> Wet hands may result in electric shock</p> <p>DON'T</p>	<p>■ Ground the LF516/LF546 independently from power equipment. (100 ohm or less ground resistance)</p> <p> Operating this product without grounding can cause electric shock or malfunction.</p> <p>DO</p>
<p>■ Do not conduct wiring work with bare hands.</p> <p> Remaining electric charge even if power is turned off can still cause electric shock.</p> <p>DON'T</p>	<p>■ For the power supply wiring and grounding wiring, use crimping terminals with insulated sleeve.</p> <p> There is a risk of electric shock due to drop-off or loosening, and a risk of fire and equipment trouble due to heat generation.</p> <p>DO</p>
<p>■ Do not modify or disassemble the LF516/LF546 unnecessarily.</p> <p> Modifying or disassembling this product can cause electric shock, malfunction of or damage to this product.</p> <p>DON'T</p>	<p> The label shown left is placed near the power supply terminal on the converter.</p> <p>Be alert to electric shock.</p>

Flowmeter accuracy may be affected by the way wiring is executed. Proceed with correct wiring taking the precautions in following pages.

CAUTION

- (1) Select the cable run location so they are **away from electrical equipment (motors, transformers, or radio transmitters) which causes electromagnetic or electrostatic interference.**
- (2) Deterioration of flowmeter circuit insulation occurs if the converter interior or cable ends get wet or humidified. This in turn causes **malfunction of flowmeter or noise problems. Avoid a rainy day if the flowmeter is to be installed outdoors.** Even indoors, prevent water from splashing over the flowmeter. Try to finish the wiring as quickly as possible
- (3) The converter has a surge arrester/protector installed inside. Therefore, **do not conduct a withstand voltage test for the converter.** To check the insulation of the converter, use a voltage of **250Vdc or less.**
- (4) After wiring, be sure to install the terminal block protection cover.

5.1 Cables

Use the kind of cables shown in Table 5.1 to wire the converter.

Table 5.1 Installation Cables

Name	Cable name	Nominal cross-sectional area	Finished outer diameter	Description
Power cable	3-core vinyl sheathed cable or 2-core vinyl sheathed cable	2 mm ²	11~13mm	CVV JIS C 3401,IEC60695,IEC60754,IEC60227,IEC60245 or equivalent
Output signal cable	The number of conductors the cable contains differs depending on the specification of the output signal cable. Use a shielded cable of finished outer diameter 11 to 13mm and nominal cross-sectional area 1.25mm ² .			CVV-S JIS -258-C or equivalent

5.2 External Device Connections and Grounding

The terminal board connections of LF516/LF546 Flowmeter are shown in Figure 5.1. Proceed with wiring as described in Section 5.4, "Wiring Procedure."

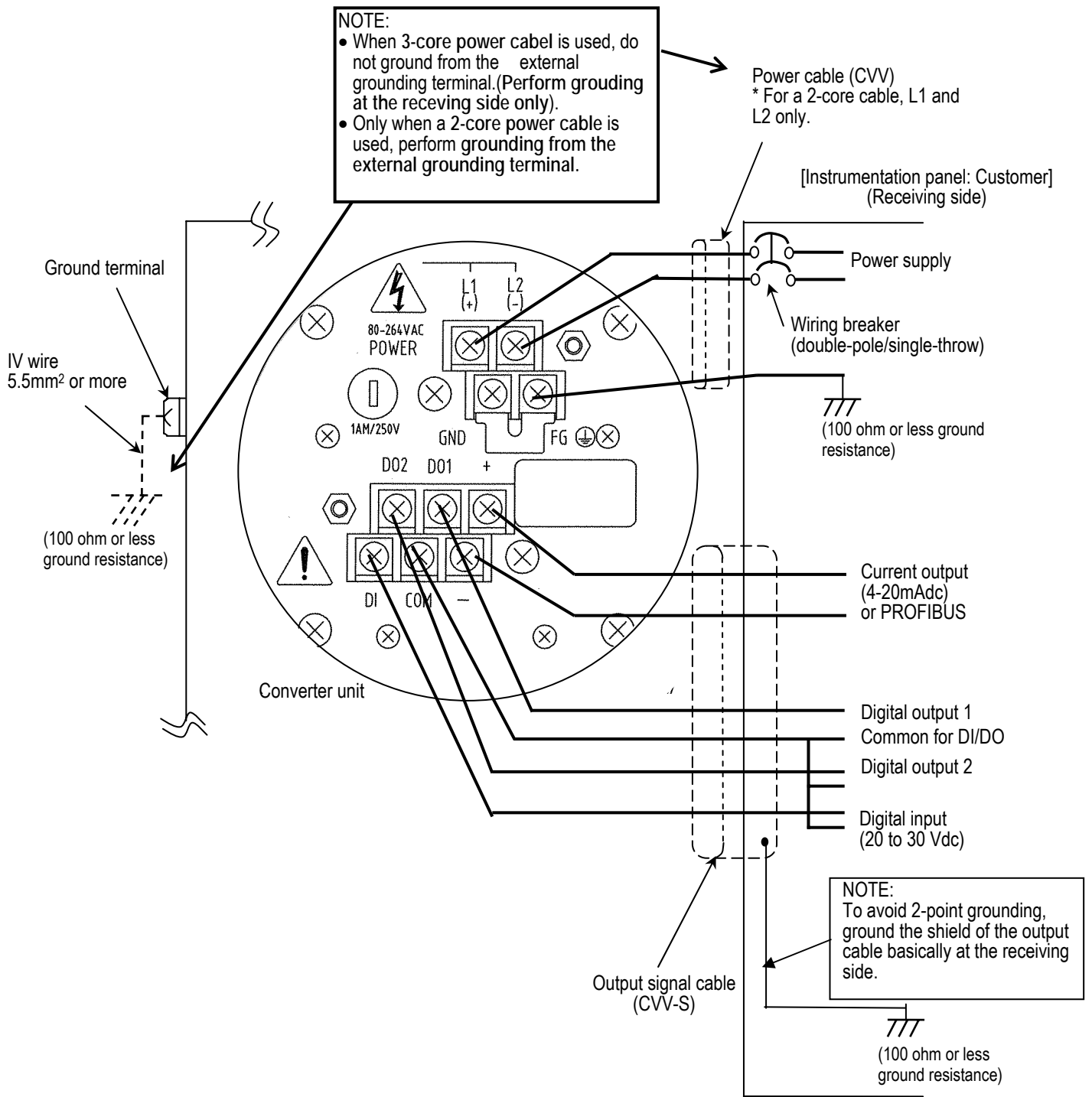

Figure 5.1 External Wiring Schematic Diagram

* Use a heavy copper braid or wire (cross-sectional area **5.5 mm² minimum**) to ground the terminal and make it **as short as possible** as shown in Figure 5.1 for **grounding**.

Also, **Avoid a common ground** where earth current may flow. (An **independent ground** is preferable.)

* The converter has no power switch. Install the power switch at the system side. **Be sure to use a double-pole/single-throw (both disconnection) wiring breaker.**

5.3 Notes on Wiring

Notes on Instrumentation-Converter Wiring

- To avoid 2-point grounding, **ground the shield of output cable basically at the receiving side.**
- Use a grounding wire of IV wire 5.5mm² or more. The size of the external grounding terminal screws is M4. Do not share a **grounding wire with other instruments where grounding current may flow. (An independent grounding is preferable.)**
- Power cable
 - When a 3-core cable is used: **Ground with the FG terminal.**
 - When a 2-core cable is used: Use an external grounding terminal and make the cable as short as possible.

5.4 Wiring

IMPORTANT

The cable connections are not provided in the conduit port of this apparatus.
Please prepare yourself for the cable connections which could be used in Division2 hazardous locations.

CAUTION

■ Do not wire cables and replace parts when power is supplied.



Wiring work and replacing parts in the power-on state may cause electric shock.

■ Do not work on piping and wiring **with wet hands**.



Wet hands may result in **electric shock**.

5.4.1 Terminal Treatment of Cables

Follow the procedures below to treat the terminals (at the converter side) of various cables and install the cables to the terminal block. Use appropriate cables based on the description in Section 5.1 "Cables." Crimp a **round type insulated crimp-type terminal** to the end of the cables.

(1) Power cable, current output cable, and digital I/O cables

The necessary cables should be ordered from the person responsible for the installation. Strip the sheath of each conductor as shown in Figure 5.6 and attach a crimping terminal with insulated sleeve to it. The size of the crimping terminal is M4:

- Connect the power cable to terminal blocks L1 and L2.
- Connect the current output cable to terminal blocks + and -.
- Connect the digital I/O cable to terminal blocks D1, D01, D02 and COM, as required.

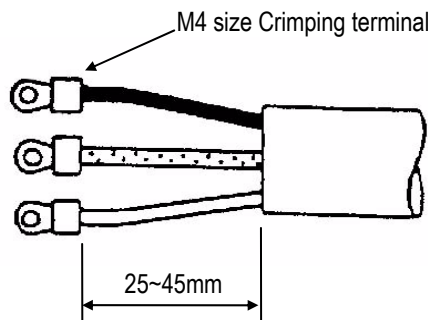

Figure 5.6 Terminal Treatment of Power Cable, Current Output Cable and Digital I/O cable

5.4.2 Cable Connection

Connect and install the terminal-treated cables to the terminal block by the following procedure.

*Connect the cables to the terminal block securely. A loose connection may cause incorrect measurement. After connecting a cable, try to pull it to check whether it has been connected securely.

Referring to Section 5.2 "External Device Connections and Grounding", connect each cable to the terminal block. **Tighten the screws of the terminal block tightly to ensure the secure connection.** A loose connection may cause incorrect measurement. **After connecting a cable, try to pull it to see whether it has been connected securely.**

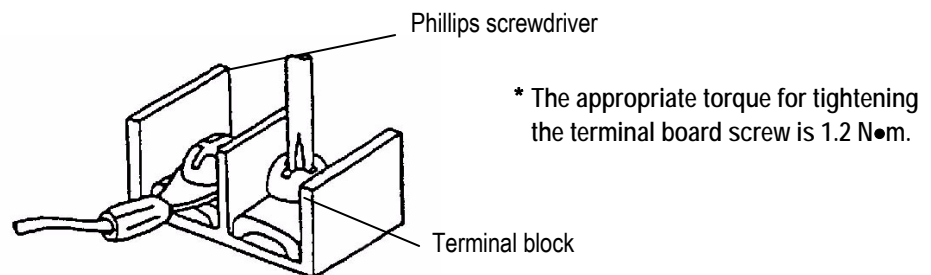

Figure 5.10 Connecting a Cable to Terminal Block

5.5 Digital I/O Connections

Digital I/O terminals consist of contact output terminals (DO1 and DO2), voltage signal input terminal (DI), and signal common terminal (COM). Each terminal (DO1, DO2 and DI) is isolated from internal circuits. Terminal (COM) is the signal common for the other three terminals (DO1, DO2 and DI).

Functions can be assigned for each terminal with the LCD control keys. See **Chapter 10, "Digital I/O Functions."**

To connect an electromagnetic relay or counter to the contact output terminal (DO1 or DO2), put a surge-absorbing diode into the input circuit of the relay or counter. See Figure 5.3 for an example of electromagnetic counter connection.

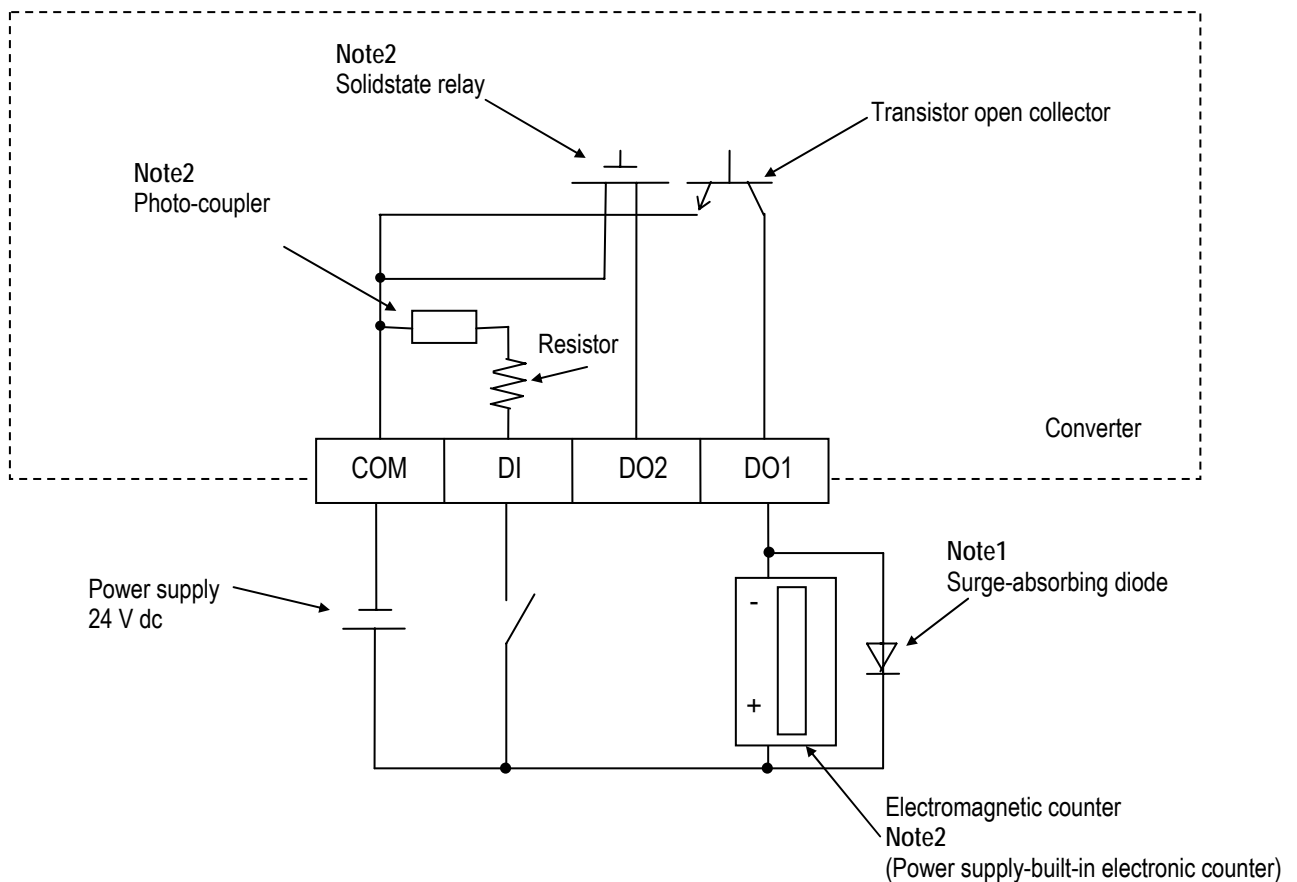





Figure 5.3 Electromagnetic Counter Connection Example

Note 1: Use a surge-absorbing diode of the rating: **current rating 1A and voltage rating 200 V minimum.**

Note 2: **When a power supply-built-in electronic counter is used, the surge-absorbing diode is not required.**

6. Operation

 CAUTION	
<ul style="list-style-type: none"> ■ Do not touch the terminal board when power is supplied. <div style="display: flex; align-items: center; margin-top: 10px;">  <p style="margin: 0;">Touching the terminal board when power is supplied can cause electric shock.</p> </div> <p style="margin-top: 5px;">DON'T</p>	<ul style="list-style-type: none"> ■ Do not touch the main body when high temperature fluid is being measured. <div style="display: flex; align-items: center; margin-top: 10px;">  <p style="margin: 0;">The fluid raises the main body temperature and can cause burns.</p> </div> <p style="margin-top: 5px;">DON'T</p>

6.1 Preparatory check

Follow the procedure described below to prepare before starting the flow measurement

System Check

Check the items listed below

- Check **the wiring between the converter and related instruments.**
- Make sure **all the bolts of connection flanges on which the flowmeter** is mounted securely tightened.
- Make sure **the direction of flow arrow** is in accordance with actual flow.
- Make sure the flowmeter is **grounded** with 100 ohm or less ground resistance.
- Make sure the **converter housing covers** are securely tightened.

Placing System On-Stream

- **Let the fluid go through** the detector pipe. (Note 1)
- When the detector is filled with the fluid, **stop** the fluid and keep it still in the detector pipe.

Supplying Electric Power

- Make sure the **power supply** is as specified.

Checking Converter Parameters

- Check the configuration parameter settings. Refer to **Chapter 7, “LCD Display and Controls,” Chapter 8, “Configuration Parameter Setting,” and Chapter 11, “Communications Function.”**

Zero Adjustment

- Wait for 30 minutes to warm up the flowmeter. Then making sure the fluid holds still in the detector pipe before starting the **zero adjustment**.
- Refer to **6.2, “Zero Adjustment.”**

On-line measurement

- After checking the items and conducting the zero adjustment as listed above, let the fluid go through the detector pipe. Output (4–20 mA dc) directly proportional to the flow rate can be obtained.

Note 1: If the detector pipe is not filled with the fluid to be measured, the flow rate will be indefinite and unable to be measured. Before using the flowmeter, be sure to fill the detector pipe the fluid to be measured.

6.2 Zero Adjustment

To conduct zero adjustment of the flowmeter, the fluid **in the detector pipe must be held still**.

There are three different ways to start the zero adjustment:

- (1) **Pressing a combination of control keys for the model with LCD display**
See 8.2.14 “Still Water Zero Adjustment”
- (2) **Sending a command signal from a HART communications device (a communication device such as hand-held terminal AF900 is required)**
See the instruction manual of hand-held terminal you use.
- (3) **PROFIBUS communication (a communication device for PROFIBUS is required)**
See the instruction manual of communication device you use.

7. LCD Display and Controls

7.1 Name and Function of Each Part of LCD Display

The LDC display and infrared switches (hereafter, called "control key") in front of the converter allows you to view or set various constants such as measured values and parameters.

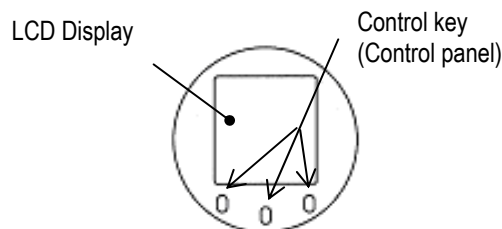

Figure 7.1 Display section of LF546

Instructions

The operation principle of infrared switch is to irradiate infrared to the front of control panel and detect the reflection from finger when operating.

Normal operation is impeded depending on the conditions such as disturbing light from surroundings or stain attached to the control panel. When unable to avoid such condition, operate the EMF converter in the following manner.

Remove the factor to impede proper operation of infrared switch as below:

- Cover the control panel by hand so that light does not shine on it
- Clean the stain attached on the control panel
- Clean the stain on the finger or the gloves to operate the EMF converter, or wear gloves in light color
- When there is a reflecting object placed opposing to the control panel, stand in-between the reflecting object and the control panel to block the light

Following are considered as the factors to impede infrared switch to operate properly.

- Intense light such as direct sunlight and reflected sunlight by window glass or metal plate
- Place where brightness changes always such as ON/OFF of lighting
- Dense smoke or steam near the control panel
- Those attached on the control panel such as rain (dew drop), snow, ice, mud and oil, and haze due to their attachment
- Operation of the control panel by hands wearing gloves in dark color or stained fingers and gloves
- Light reflecting object near the control panel, or reflecting object such as metal plate placed opposing to the control panel

- LCD electronically rotatable display**
8-line × 14-character liquid crystal display. The backlit display provides an **easy-to-read indication even under poor lighting conditions.** Instantaneous flow rates or totalized flow in the measurement mode or configuration parameters in the setting mode can be displayed. (Number of LCD display dots: 128 x 128 dots)

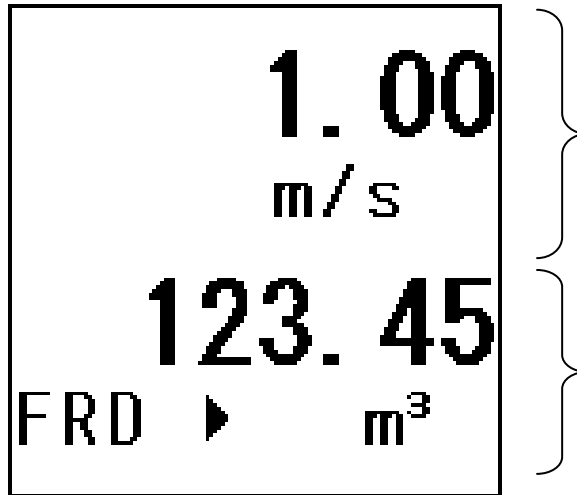

Measured Value Display 1

Displays a measured value of the type the operator has selected.

Measured Vale Display 2

Displays a measured value or setting value of the type the operator has selected or displays an error message. If an error message appears, the measured value or setting value cannot be displayed (error message-precedence display).

- **Setting switch**

The control keys allow you to perform converter control and setting, without opening the converter housing.

These three controls keys function differently depending on the current display screen.

The functions of these control keys are displayed on the display screen.

In this product, the display method can be changed according to the converter installation direction. For example, if the control keys are installed so that they are located above the display, they can be displayed appropriately as shown below, by changing the display method.

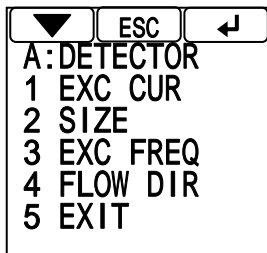

Above the control keys

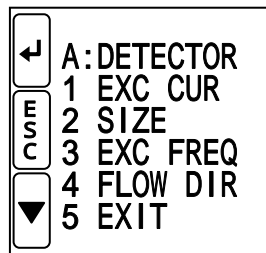

Left of the control keys

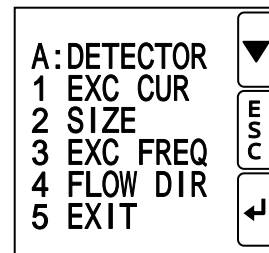

Right of the control keys

7.2 Display Format

In the measurement mode, the measured data is displayed using the menu items set by the Display 1 (DSPL1) and Display 2 (DSPL2).

(For display settings, see 8.2.6 "Display Setting.")

1. Flow rate / Flow velocity display

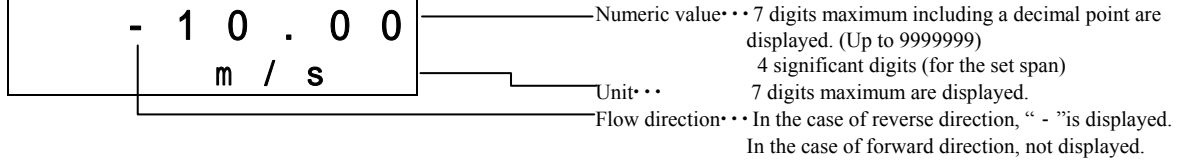

2. Totalized flow count display

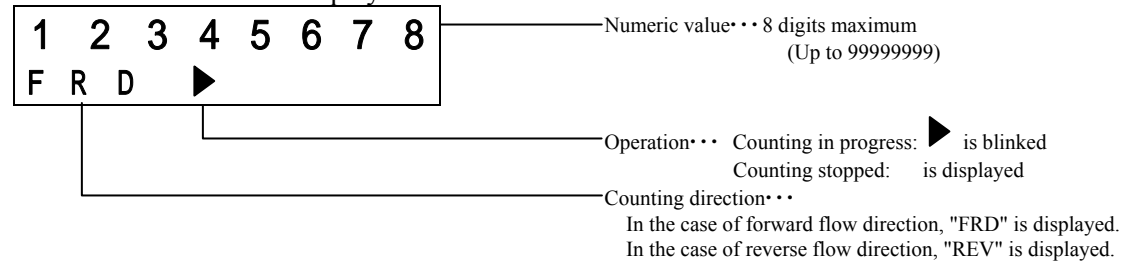

3. Totalized flow volume display

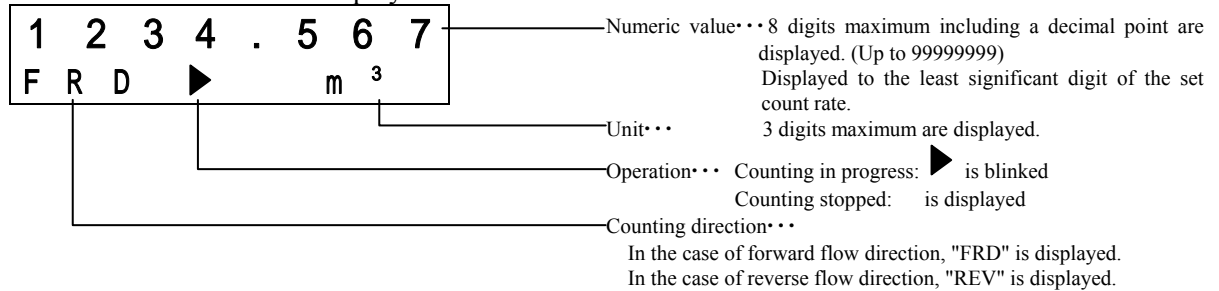

4. Totalized difference flow volume display

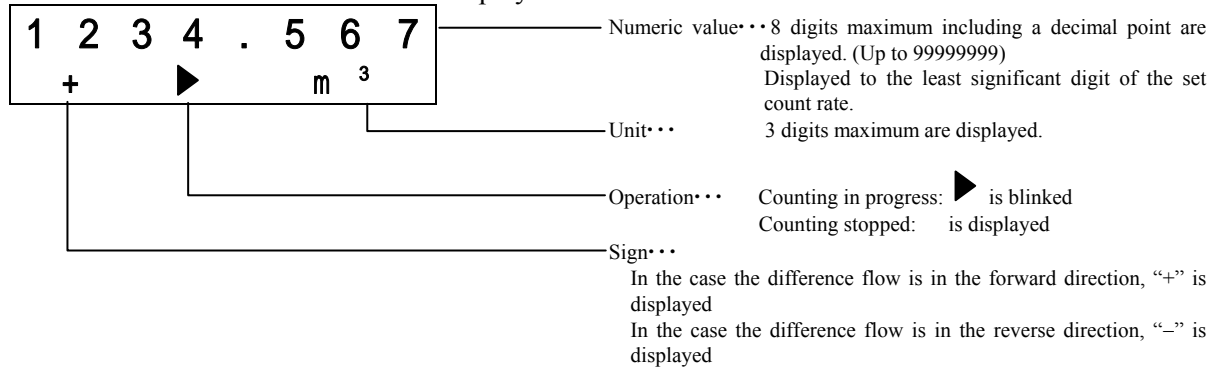

Note 1: Totalized flow volume and totalized difference flow volume are displayed to the least significant digit of the set count rate.

(Example1) When the count rate is 0.0001 m³:
 When the measurement object flows through 0.0001(m³), inside counter counts 1. Because inside counter is 8 digits at the maximum, the maximum of totalized flow is 9999.999(m³). When inside counter exceeds the maximum, inside counter return to 0, and continue totalization.

Inside counter(m ³) Max 8 digits	Totalized flow display(m ³) Max 8 digits (include decimal point)
0	000.0000 m ³
1	000.0001 m ³
1000	000.1000 m ³
1000000	100.0000 m ³
10000000	1000.000 m ³
99999999	9999.999 m ³

(Example2) When the count rate is 10 m³:
 When the measurement object flows through 10(m³), inside counter counts 1. Because inside counter is 8 digits at the maximum, the maximum of totalized flow is 99999999(m³). When inside counter exceeds the maximum, inside counter return to 0, and continue totalization.

Inside counter(m ³) Max 8 digits	Totalized flow display(m ³) Max 8 digits (include decimal point)
0	00000000 m ³
1	00000010 m ³
1000	00010000 m ³
1000000	10000000 m ³
10000000	99999999 m ³
99999999	99999999 m ³

Note 2: Totalized difference flow volume shows the difference between the forward direction volume and the reverse direction volume.

When the forward direction volume reaches the upper limit and returns to zero, the volume is displayed as follows:

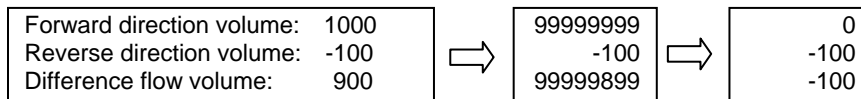

5. Percent display

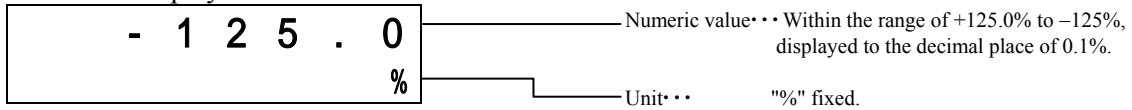

* If the value goes out of the display range, an error message appears.

6. Flow rate (When custom unit is selected)

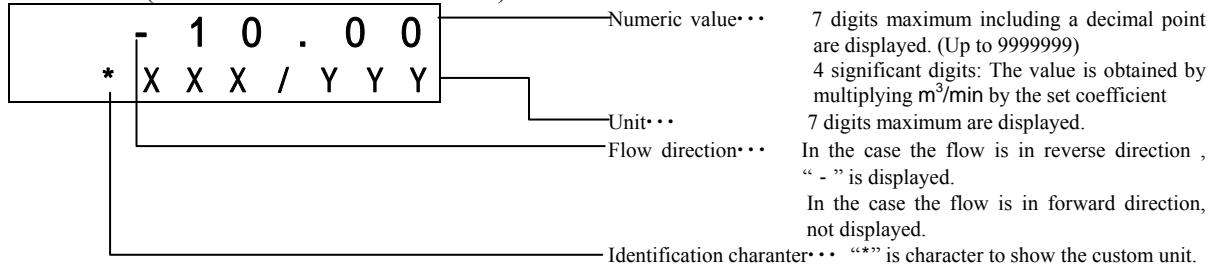

7. Range display

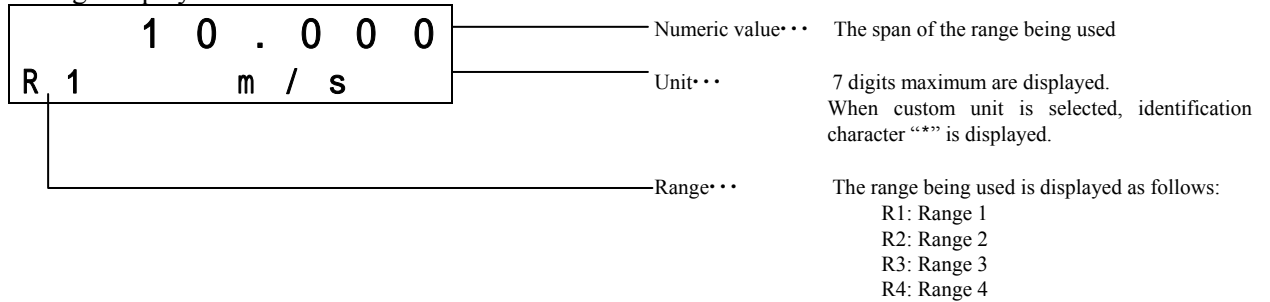

In the range display, the range currently used is displayed (any one of the ranges 1 to 4). The screen example above shows that Range 1 is currently used.

When multi-range is selected, the displayed range changes automatically as the range used is changed.

- 8. Bar graph display
Bar graph can be set only for Display 2.



Graph... The measured value is displayed in bar graph. The left side of the graph is RL (Range Low limit) and the right side of the graph is RH (Range High limit). Scale marks are displayed in increments of 25% inside the graph.

Range... The range number currently used is displayed.

*** About Range type, percent display and percent value when bar graph is displayed**

When percent display is used, the % value displayed depends on the flow direction. However, the % value when bar graph is displayed is as shown in the table below.

Range type	Input signal	% value in percent display	% value in bar graph	4-20mA output
Single(forward)	Forward direction 50%	50%	50%	12mA
Single(forward)	Reverse direction 50%	-50%	0%	4mA (Output low lim value*)
Bidirectional (forward/reverse)	Forward direction 50%	50%	50%	12mA
Bidirectional (forward/reverse)	Reverse direction 50%	-50%	0%	12mA

* The set value in 8.2.17 “Output Low Limit Setting” will be output.

- When communications function is used

When HART communication is used, a mark is displayed in the upper field on the display. When PROFIBUS communication is used, if the communication is made between the PROFIBUS option board and the converter main board, a mark is displayed in the upper field on the display in the same way as in HART communication, while communication between the PROFIBUS option board and the external bus, nothing is displayed.

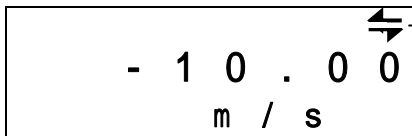

Displayed when communications function is used

7.3 Basic operations

7.3.1 Mode Change

The converter provides the setting mode and calibration mode as well as the measurement mode. To change the mode to the setting mode or to the calibration mode, push the **SET** switch. To return to the measurement mode, push the **ESC** switch from each menu.

- **Measurement mode:** Mode to perform flow measurement.
Flow rate or volume of process fluid is displayed and outputted.
The flowmeter first goes to this mode when power is turned on.
- **Setting mode:** Mode to check or set various parameters.
Various setting values can be displayed on the screen but the output is always the flow rate of process fluid as in the measurement mode.
(See 7.4 “Setting and Calibration Items List” and 8.2 “Parameter Check / Change” for details.)
- **Calibration mode:** Mode to check the converter circuit.
The built-in simulation signal generator circuit can be used to check the span of the range and check the excitation current value. The current output varies in accordance with the simulation signal. Each digital output retains its previous state when the converter is changed to the calibration mode.
See 7.4, “Setting and Calibration Items List” and 9, “Calibration” for details.

oFlow of mode change

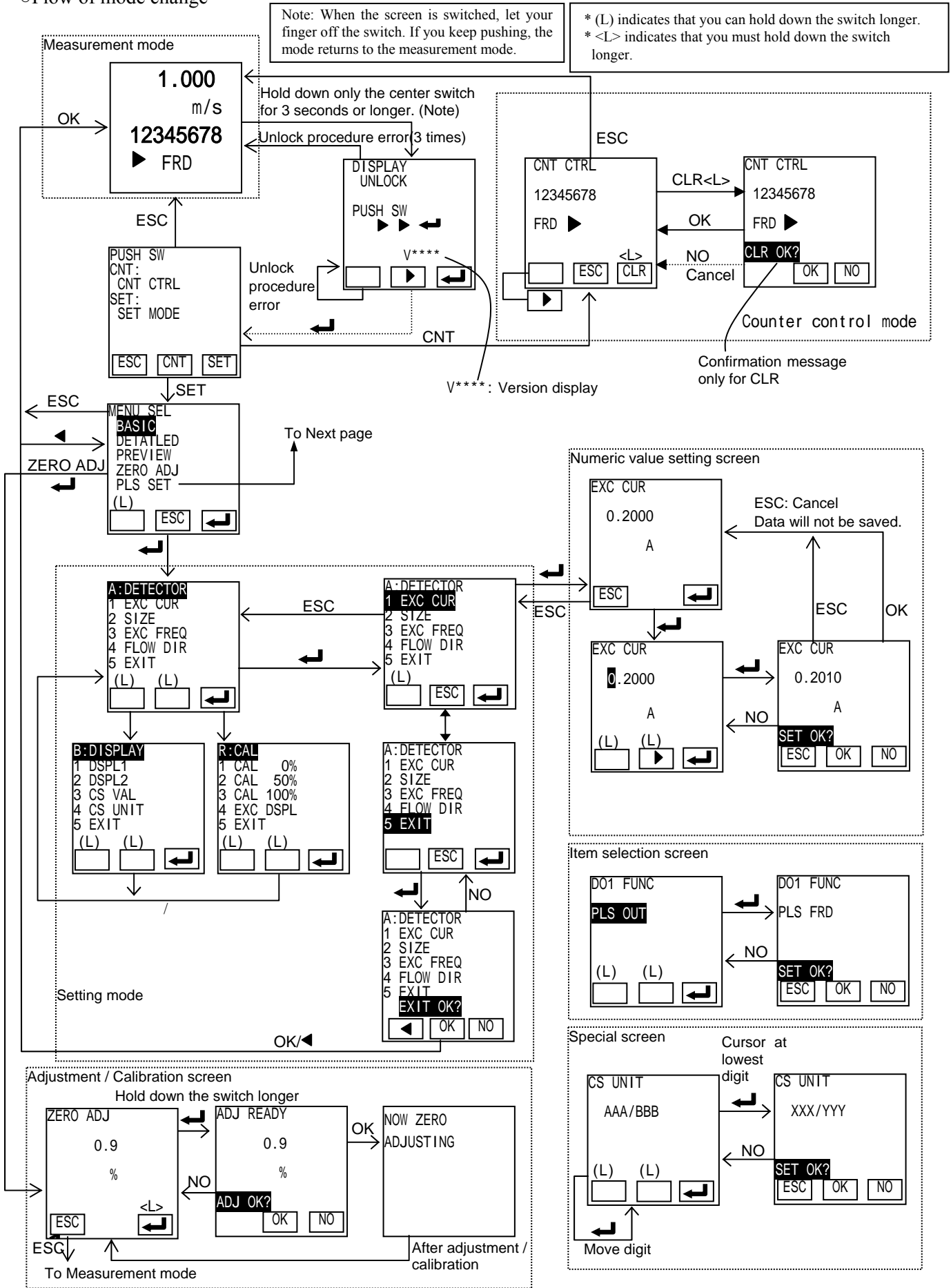

○ Pulse output setting mode

This mode is used to perform continuous parameter settings (automatic operation) regarding pulse outputs. When these parameters are set, pulse output is ready to send out.

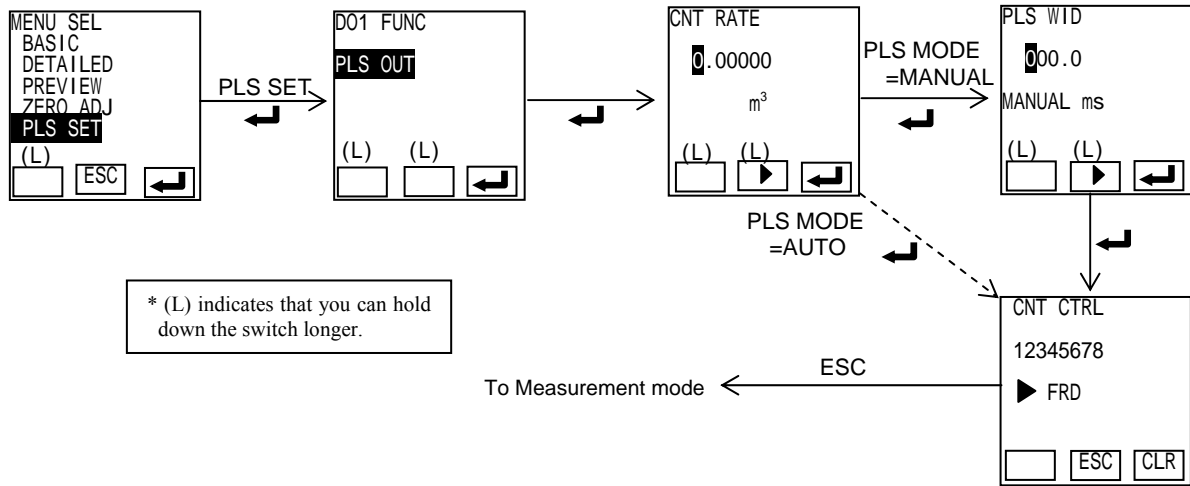

(1) Digital Output 1 selection screen

The function for Digital Output 1 can be selected.
This screen shows functions related to pulse outputs only.
(For details of setting procedure, see 8.2.18.)

- PLS OUT (Pulse output)
- PLS FRD (Forward direction pulse output)
- PLS REV (Reverse direction pulse output)

(2) Count rate setting screen

Count rate can be set.
(For details of setting procedure, see 8.2.20.)

(3) Pulse width setting screen

When pulse width setting mode is MANUAL, the screen moves to Pulse width setting screen.
When pulse width setting mode is AUTO, the screen moves to Totalizer control screen.
(For details of setting procedure, set See 8.2.20.)
Note: Pulse width setting mode is set to AUTO when shipped from the factory.

(4) Counter control screen

This screen is used to start the totalizer.
If **ESC** is pushed, the screen returns to the measurement screen. (End of pulse output setting mode)
(For details of operation procedure, see Section 10.2.)

Note: If **ESC** is pushed to return to the measurement screen while automatic screen sequence in progress, the setting items entered so far are saved.







○ Explanation about mode change

The converter usually works continuously in the measurement mode.

If you want to set parameters or perform calibration or adjustment, you have to go to the setting mode.

To enter the setting mode, push the center switch for 3 seconds or more in the measurement mode.



When you push the switch for 3 seconds or more, the display unlock screen appears.



Switch operation	Display example	Description
	DISPLAY UNLOCK PUSH SW ▲▶▲▶▲▶↵ V**** 	Display unlock screen
	DISPLAY UNLOCK PUSH SW  V**** 	To unlock the display, push the switches in the order indicated on the screen. The pushed switch is highlighted.
	PUSH SW CNT: CNT CTRL SET: SET MODE 	Pushing  at the end, the display will be unlocked and the mode change screen appears.

Note 1: If the order of switches to push was erroneous, UNLOCK FAILURE error message appears and the screen return to the display unlock screen.
 Mode return to the measurement mode in case of the third error.
 When the center switch is pushed during error message indication, mode return to the measurement mode immediately.

Note 2: V**** shows the version number.

When the mode change screen appears, proceed as follows:

	Enters the setting mode (setting configuration selection menu).
	Changes to the counter control screen and you can operate the totalizer.

Note: If password has been set, the password input screen appears when you move from the mode change screen to the setting configuration selection menu (when you push  switch), or when you move to the totalizer control screen (when you push  switch).

If the password you enter does not match, you cannot change some of the parameters. In addition, when you operate the totalizer, you cannot use CLEAR switch. (However, you can start or stop the totalizer.)

○ Operation timeout function

If no operation is made for one minute or more while the converter is in the setting mode, the mode automatically returns to the measurement mode unless the parameters are displayed on the screen.

Menu screen	<p>A·DETECTOR 1 EXC CUR 2 SIZE 3 EXC FREQ 4 FLOW DIR 5 EXIT</p> <p>▼ ESC ↵</p>	When no operation is made for 1 minute, the mode automatically returns to the measurement mode.
Parameter check screen	<p>EXC CUR</p> <p>0.2000</p> <p>A</p> <p>ESC ↵</p>	The screen does not return to the measurement mode.
Parameter change screen (Parameters are being changed.)	<p>EXC CUR</p> <p>0.2000</p> <p>A</p> <p>▲ ▶ ↵</p>	

7.3.2 Setting and Calibration

In the setting mode, you can select items, or check or change the setting values as described below.

When you push ▲ or ▼ to scroll up or down the numeric value or alphabet, or when push ▶ to move the digit, you can execute continuous operation by holding down the relevant switch longer. (Holding down the switch longer automatically executes the operation continuously.)

- Moving to the menu screen





















Switch operation	Display example	Description
	<p>PUSH SW CNT: CNT CTRL SET: SET MODE</p> <p>ESC CNT SET</p>	Mode change screen
SET	<p>MENU SEL BASIC DETAILED PREVIEW ZERO ADJ PLS SET</p> <p>▼ ESC ↵</p>	Pushing SET in the measurement mode takes you to the menu configuration selection screen. For configuration, select BASIC or DETAILED menu.

Switch operation	Display example	Description
	A: DETECTOR 1 EXC CUR 2 SIZE 3 EXC FREQ 4 FLOW DIR 5 EXIT 	Pushing from the menu configuration selection screen takes you to the menu screen. The cursor is positioned at the function display ([A: DETECTOR] in this example). * This screen is an example when the DETAILED menu is selected.
	B: DISPLAY 1 DSPL1 2 DSPL2 3 CS VAL 4 CS UNIT 5 EXIT 	Pushing or while the cursor is positioned at the function display changes to another function display and its corresponding menu item list.
	B: DISPLAY 1 DSPL1 2 DSPL2 3 CS VAL 4 CS UNIT 5 EXIT ESC	When you push , the cursor at the function display disappears and the cursor goes to the display field of the setting items list.
	B: DISPLAY 1 DSPL1 2 DSPL2 3 CS VAL 4 CS UNIT 5 EXIT ESC	Every time you push , the cursor rolls down by one item at a time. Pushing further when the cursor is positioned at the bottom causes the cursor to return to the top item.
	DSPL2 m/s ESC	When you push , the setting screen for the item the cursor positioned appears and enables you to set / check the parameter.

• Checking or changing the setting value

Switch operation	Display example	Description
	C: RANGE 1 R TYPE 2 R1 3 R2 4 R3 5 R4 6 R HYS 7 EXIT ESC	Menu screen for function C Push to move the arrow mark to R1.

Switch operation	Display example	Description
	R1 10.0000 m/s 	Push to select the item you want to check or change. The screen changes and the currently set item appears for you to check. Pushing returns you to the menu screen.
	R1 0.0000 m/s 	When you push , the cursor appears on the setting value and the screen is ready to change the setting value.
	R1 0.0000 m/s 	Ready to change the setting value Pushing increments the number in the place where the cursor is positioned. (Holding down the switch longer causes the operation to continue.) * Pushing when the cursor is positioned below the digit of unit will change the unit to the next unit. In addition, if a natural number is used, a decimal point as well as the numeric value appears.
	R1 1.0000 m/s 	Ready to change the setting value Pushing moves the cursor to the next digit.
	R1 0.0000 m/s 	Ready to change the setting value Change the setting value using and . In this example, 5.000 m/s is set.
	R1 05.0000 m/s 	Pushing sets the data temporarily. The cursor disappears and a message appears to confirm whether it is OK or not.
	R1 0.0000 m/s 	If you want to cancel the operation, for example, because the temporarily set data is incorrect, pushing returns the temporarily set data to the previous value, enabling you to change the setting value again. Pushing cancels the setting operation and exits the setting screen.

Switch operation	Display example	Description
	R1 5.00000 m/s  	Pushing  when data is temporarily set causes the data to be fixed and executed. After the data is set, the cursor disappears, enabling you to check the set value.
	C: RANGE 1 R TYPE 2 R1 3 R2 4 R3 5 R4 6 R HYS 7 EXIT   	Pushing  returns you to the menu screen.
 	C: RANGE 1 R TYPE 2 R1 3 R2 4 R3 5 R4 6 R HYS 7 EXIT EXIT OK?   	Push  and move the cursor to "EXIT" and then push  , a message appears to confirm whether it is OK to exit or not. When you push  here, the screen does not move to the measurement mode and returns to the menu screen. When you push  here, the screen does move to the menu configuration selection screen.
	5.000 m/s 12.345 m ³	If you push  , the setting mode ends and returns to the measurement mode.

7.4 Configuration Items Selection Table

How to check or change each constant of the converter is shown in the table below.

Details of each item are described in the setting items (A to R) of **Chapter 8, "Parameter Settings."**

- Basic configuration (when menu configuration is BASIC)

When you select "BASIC" in the menu configuration screen, the menu to check or change each constant is executed as follows.

Fucntion	1	2	3	4
B DISPLAY	Display1	Display2	Returns to meas. mode	
C RANGE	Range type	Range1	Returns to meas. mode	
D FILTER	Damping value	Returns to meas. mode		
E LOW CUT	Low cut Value	Returns to meas. mode		
F ZERO	Still water zero point adjustment	Returns to meas. mode		
H DO	Digital output 1	Digital output 2	Returns to meas. mode	
I DI	Digital input	Returns to meas. mode		
J CNT/PLS	Count rate	Pulse width setting mode	Pulse width	Returns to meas. mode

When the mode is changed from the measurement mode to the setting mode, Group B is displayed first in the case of Basic configuration. After that, the screen changes as follows:

Group B (Start screen) Group C Group D Group E
 Group F Group H Group I Group J

○ Detailed configuration

When you select "DETAILED" in the menu configuration selection screen, the check/change menu for each constant setting is expanded as shown in the table below.

Function	1	2	3	4	5	6	7
A DETECTOR	Exciting Current *1	Meter size *3	Exciting frequency *3	Flow direction *1	Returns to meas. mode		
B DISPLAY	Display1	Display2	Custom Value *1	Custom Unit *1	Returns to meas. mode		
C RANGE	Range type *1	Range1 *1	Range2 *1	Range3 *1	Range4 *1	Range Hysteresis *1	Returns to meas. mode
D FILTER	Damping value	Limit rate	Limit time	Returns to meas. mode			
E LOW CUT	Low cut value	Display low cut setting	Returns to meas. mode				
F ZERO	Still water zero point adjustment	Manual zero setting	Returns to meas. mode				
G 4-20mA	Current output setting upon alarm occurrence *1	Low limit Value *1	Returns to meas. mode				
H DO	Digital output1 *1	Digital output2 *1	DO1 alarm Status *1	DO2 alarm Status *1	Returns to meas. mode		
I DI	Digital input *1	DI control signal level *1	Returns to meas. mode				
J CNT/PLS	Count rate *1	Pulse width setting mode *1	Pulse width *1	Returns to meas. mode			
K PRESET C	Preset count value *1	Preset output function *1	Returns to meas. mode				
L H/L ALM1	High alarm ON/OFF *1	High alarm Value *1	Low alarm ON/OFF *1	Low alarm value *1	Returns to meas. mode		
M H/L ALM2	HH alarm ON/OFF *1	HH alarm Value *1	LL alarm ON/OFF *1	LL alarm value *1	Returns to meas. mode		
N SELF CHK	Self check ON/OFF *1	Returns to meas. mode					
O FIX OUT	Fix out set *1	Fix current Value *1	Fix pulse Value *1	Returns to meas. mode			
P OTHERS	Password *1	LCD adjustment	Switch position	Returns to meas. mode			
Q COMM	PROFIBUS *1	Returns to meas. mode					
R CAL	0% Flow value calculation *1	50% Flow value calculation *2	100% Flow value calculation *1	Exciting current display *2	Returns to meas. mode		

Note 1: If you enter a wrong password, you are allowed to check the setting value and to perform calibration for the items with *1 mark in the table. However you are not allowed to change the setting and perform calibration for these items.

Note 2: The items with *2, you are only allowed to check the calibration value.

Note 3: The items with *3, you are only allowed to check the setting value.

7.5 Password input

The converter provides the password function to prohibit some functions that affect the flow measurement from being set or adjusted. For the protected functions, see the menu configuration table on the previous page.

- * Password is a 3-digit number. If '000' is set for the password, the password input screen does not appear. If a password is set (other than '000' is set), you have to enter your correct password.
- Limitation of totalizer operation
Start and stop operations only are permitted. (Clear operation is not permitted.)

8. Parameter Settings

8.1 Parameter Setting Items

To check or change each constant of the converter, first select the desired setting item described in 7.3.2 “Setting and Calibration.”

Proceed as follows for settings in the setting mode.

No.	Function item	Display example
8.2.2	Exciting current	EXC CUR
8.2.3	Meter size	SIZE
8.2.4	Exciting frequency	EXC FREQ
8.2.5	Flow direction	FLOW DIR
8.2.6	Display1,2	DSPL1 / DSPL2
8.2.7	Custom value	CS VAL
8.2.8	Custom unit	CS UNIT
8.2.9	Range (Span)	R TYPE, R1(~ R4), R HYS
8.2.10	Damping value	DAMPING
8.2.11	Limit rate, Limit time	LIM RATE / LIM TIME
8.2.12	Low cut value	CUT VAL
8.2.13	Display low cut	DSPL SET
8.2.14	Still water zero point Adjustment	ZERO ADJ
8.2.15	Manual zero	MANUAL
8.2.16	Output at alarm occurrence	ALM 4-20
8.2.17	Output low limit	LOW LIM
8.2.18	Digital output	DO1 FUNC, DO2 FUNC, DO1 STAT, DO2 STAT
8.2.19	Digital input	DI FUNC, DET LVL
8.2.20	Count rate, Pulse width setting mode, Pulse width	CNT RATE, PLS MODE, PLS WID
8.2.21	Preset count value	PRST VAL
8.2.22	Preset output mode	OUT MODE
8.2.23	High / Low alarm limit, HH (High high) LL (Low low) alarm limit	H SET / H VAL L SET / L VAL HH SET / HH VAL LL SET / LL VAL
8.2.24	Self check	SELF CHK
8.2.25	Fix output	FIX SET, CUR VAL, PLS VAL
8.2.26	Password	PASSWORD
8.2.27	LCD adjustment	LCD ADJ
8.2.28	Switich position	SW POSN
8.2.29	Communication	PROFIBUS

8.2 Check/Change of Parameters

8.2.1 Menu Configuration Selection Screen

Display example



You can select the kind of menu configuration.
 For menu items of configuration, see 7.4 "Setting and Calibration Items List."



























BASIC	Only the basic parameters are displayed. Nothing is displayed in the field of other parameters.
DETAILED	All parameters are displayed.
PREVIEW	Only reading of all parameters is possible. When switch is pushed, the screen switches. When switch is pushed, the mode returns to the measurement mode.
ZERO ADJ	Moves directly to the still water zero point adjustment screen. See 8.2.14 "Still Water Zero Point Adjustment."
PLS SET	Moves to the pulse output setting mode. See "Pulse output setting mode" on Page 43.















8.2.2 Exciting Current Value

The exciting current value can be checked/changed by the following procedures.

Be sure to match the exciting current value with **the value specified for the combined detector**.
Specifying any other value may cause an error.

Shown below is an example of changing the exciting current value from 0.1900A to 0.2150A.









Switch operation	Display example	Description
	<p>A-DETECTOR</p> <p>1 EXC CUR</p> <p>2 SIZE</p> <p>3 EXC FREQ</p> <p>4 FLOW DIR</p> <p>5 EXIT</p> <p>  </p>	Select "EX CUR" from the setting item selection menu.
STEP1	<p>EXC CUR</p> <p>0.1900</p> <p>A</p> <p> </p>	<p>The currently set excitation current value (0.1900A in this example) appears.</p> <p>Then push  .</p> <p>* Pushing  returns you to the setting menu.</p>
STEP2	<p>EXC CUR</p> <p>0.1900</p> <p>A</p> <p>  </p>	<p>The switches at the bottom change. (   are shown.)</p> <p>At the same time, the cursor appears. (The digit indicated by the cursor is highlighted.)</p> <p>Then push  .</p>
STEP3	<p>EXC CUR</p> <p>0.1900</p> <p>A</p> <p>  </p>	<p>You can continue to change the setting value. Push  to move the cursor to the digit you want to change. (You can hold down the switch longer for continuous operation.)</p> <p>Then push  .</p>
STEP4	<p>EXC CUR</p> <p>0.12900</p> <p>A</p> <p>  </p>	<p>You can continue to change the setting value. Pushing  increments the number of the digit the cursor is positioned. (You can hold down the switch longer for continuous operation.)</p>
STEP5	<p>EXC CUR</p> <p>0.2150</p> <p>A</p> <p>  </p>	<p>Repeat this operation to change the value to 0.2150A.</p> <p>When the desired value is obtained, push  to set the value temporarily.</p>

Switch operation	Display example	Description
STEP6 	EXC CUR 0.2150 A SET OK?   	Pushing  shows a message to confirm the setting is OK or not. If OK, push  . If you need to redo the setting, push  . Pushing  cancels the setting operation and exits the setting screen.
STEP7(=END) 	EXC CUR 0.2150 A  	When you push  to "SET OK?" message, the set value is fixed. Then pushing  brings you back to the setting menu. If you push  , you can change the current value from 0.2150A again.

Note: The setting range of excitation current value is from 0.0000A to 0.3200A.
 If you try to set an exciting current value larger than 0.3200A, an error message appears and the setting value returns to the previous value.

8.2.3 Meter Size

Proceed as follows to check the meter size of the detector.

Switch operation	Display example	Description
	A: DETECTOR 1 EXC CUR 2 SIZE 3 EXC FREQ 4 FLOW DIR 5 EXIT   	Select "SIZE" from the setting item selection menu.
STEP1 	SIZE 50 mm  	The currently set meter size (50mm in this example) appears. Then push  . Pushing  returns you to the setting menu.

Note 1: The meter size display loops as shown below:

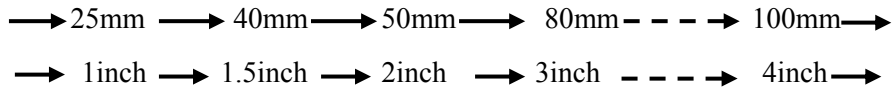

Note 2: When the meter size is changed, range unit and count rate will be forcefully changed as described below. If necessary, change these parameters again.





Range unit	m/s
Count rate	If the count rate goes out of the setting range when the meter size is changed, the count rate will be forcefully set to zero.

Note 3: The exciting frequency setting may become inappropriate for the set value when the meter size of the detector is changed. If the exciting frequency is the value shown below when the meter size is changed, the exciting frequency will be forcefully changed.

Setting meter size		Set exciting frequency
(mm)	(inch)	
25	1	400Hz
40 ~ 80	1.5 ~ 3	200Hz
100	4	100Hz

8.2.4 Exciting Frequency

Proceed as follows to check the Exciting Frequency

Switch operation	Display example	Description
	<pre>A:DETECTOR 1 EXC CUR 2 SIZE 3 EXC FREQ 4 FLOW DIR 5 EXIT</pre> 	Select "EXC FREQ" from the setting item selection menu.
STEP1 	<pre>EXC FREQ 200 Hz</pre> 	<p>The currently set excitation frequency (200Hz in this example) appears.</p> <p>Then push .</p> <p>* Pushing  returns you to the setting menu.</p>





































8.2.5 Flow Direction Setting

In the converter, you can set the flow direction of fluid arbitrarily.

- **Flow direction setting**

Selection item	Contents
NORMAL	When the fluid flows in the direction of the arrow indicating the flow direction that is attached to the detector, the indicator value and electric current output value increase.
SWITCH	When the fluid flows in the reverse direction of the arrow indicating the flow direction that is attached to the detector, the indicator value and electric current output value increases.

Switch operation	Display example	Description
	<pre>A:DETECTOR 1 EXC CUR 2 SIZE 3 EXC FREQ 4 FLOW DIR 5 EXIT</pre> 	Select "FLOW DIR" from the setting item selection menu.

Switch operation	Display example	Description
STEP1 	FLOW DIR NORMAL  	The currently set flow direction (NORMAL in this example) appears. Then push  . * Pushing  returns you to the setting menu.
STEP2 	FLOW DIR NORMAL   	The switches at the bottom change. (   are shown.) At the same time, the cursor appears. (The item indicated by the cursor is highlighted.) Then push   .
STEP3  	FLOW DIR SWITCH   	You can continue to change the setting item. Pushing   changes the selection items.  : Selected item is scrolled up.  : Selected item is scrolled down.
STEP4  	FLOW DIR SWITCH   	Perform this operation to change the setting to SWITCH. When the desired item is obtained, push  to set the item temporarily.
STEP5(=END) 	FLOW DIR SWITCH SET OK?   	Pushing  shows a message to confirm whether the setting is OK or not. If OK, push  . If you need to redo the setting, push  . Pushing  cancel the setting operation and exits the setting screen.

8.2.6 Display Setting

You can select one of the engineering units listed below as a flow measurement unit.

Flow velocity unit	m/s, ft/s
Flow rate unit (Note3)	m ³ /s, m ³ /min, m ³ /h, m ³ /d, L/s, L/min, L/h, L/d, mL/s, mL/min, mL/h, mL/d, gal/s, gal/min, gal/h, gal/d, bbl/s, bbl/min, bbl/h, bbl/d, pt/s, pt/min, pt/h, pt/d, qt/s, qt/min, qt/h, qt/d, ft ³ /s, ft ³ /min, ft ³ /h, ft ³ /d, Mgl/s, Mgl/min, Mgl/h, Mgl/d
Volume unit	m ³ , L, mL, gal, bbl, pt, qt, ft ³ , Mgl
Other units	%, COUNT, RANGE, GRAPH, CUSTOM
Totalized flow direction	Forward direction (when F or B is selected) Reverse direction (when R or B is selected)
Totalized difference flow	Difference between totalized forward flow and totalized reverse flow (when totalized flow direction D is selected)

Note 1: If COUNT, RANGE, GRAPH or CUSTOM is selected, the display is shown below:

COUNT: displays the totalized flow counts (up to 8 digits).
 RANGE: displays the range number being used for measurement (1 to 4).
 GPARH: displays the measured value (% value) in bar graph.
 In addition, the range number being used for measurement is also displayed.
 CUSTOM: displays the result obtained by multiplying m³/min by the custom coefficient.
 The details see **10.10 “Custom unit function”**.

Note 2: GRAPH display can be selected only for Display 2 screen.

For display settings, Display 1 (DSPL1) and Display 2 (DSPL2) can be set independently.

The following is an example to change the Display 1 setting from % to mL/s.

Switch operation	Display example	Description
	B: DISPLAY 1 DSPL1 2 DSPL2 3 CS VAL 4 CS UNIT 5 EXIT ▼ ESC ↵	Select "DSPL1" from the setting item selection menu.
STEP1 ↵	DSPL1 % ESC ↵	The currently set display setting (% in this example) appears. Then push ↵. * Pushing ESC returns you to the setting menu.
STEP2 ↵	DSPL1 % ▲ ▶ ↵	The switches at the bottom change. (▲ ▶ ↵ are shown.) At the same time, the cursor appears.
STEP3 ▲ ▶	DSPL1 mL/s ▲ ▶ ↵	Push ▶ to move the cursor from the second unit to the third unit and change the display unit by pushing ▲. Repeat this operation to change the display unit to mL/s. When the desired display unit is selected, push ↵ to set the display unit temporarily.
STEP4 (=END) ↵	DSPL1 mL/s SET OK? ESC OK NO	Pushing ↵ shows a message to confirm whether the setting is OK or not. If OK, push OK. If you need to redo the setting, push NO. Pushing ESC cancels the setting operation and exits the setting screen.

Note 1: The first unit (volumetric units etc.) changes as shown below:

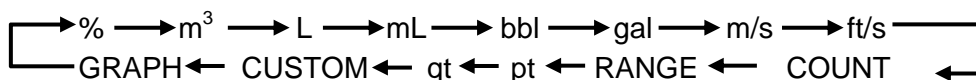

Note 2: The second unit (time unit) changes as shown below:

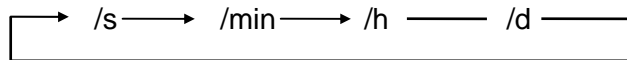

For Display 2 unit setting, select DSPL2 from the setting menu.

• How to select the display digit setting

When you select flow velocity or flow rate (custom unit is included), the screen automatically moves to the display digit setting screen.

Using the display digit setting screen, you can change the decimal places used for the measured value in the measurement mode.

Switch operation	Display example	Description
	<p>DIGIT1</p> <p>1.0</p> <p>m/s</p>	<p>Either one of the flow velocity or flow rate (custom unit is included) is selected, the screen automatically moves to the display digit setting screen.</p> <p>This screen shows the set measured value and unit.</p>
<p>STEP1</p>	<p>DIGIT1</p> <p>1.00</p> <p>m/s</p>	<p>Pushing or changes the setting of display digit and the measured value indication changes accordingly.</p> <p>When the desired item is selected, push to set the item temporarily.</p>
<p>STEP2</p>	<p>DIGIT1</p> <p>1.00</p> <p>m/s</p> <p>SET OK?</p>	<p>Pushing shows a message to confirm whether the setting is OK or not. If OK, push . If you need to redo the setting, push .</p> <p>Pushing cancels the setting operation and exits the setting screen.</p>

Note: If the setting is cancelled without completing the display digit setting, the previously used display digit setting will be used.

For display digit setting screen, the measured value is displayed in the screen based on the display setting in the previous screen (display setting screen) and thus select the display digit setting while observing the displayed measured value.

You can change the display digit with 1/10, 1/100, 1/1000 three phases for the setting range's maximum effective digits. When setting range is more than 1000, a lower digit is not displayed from the decimal point.

For example, if the setting range is 10m/s and display digit setting is 1/100, the measured value will be displayed to the first decimal place.

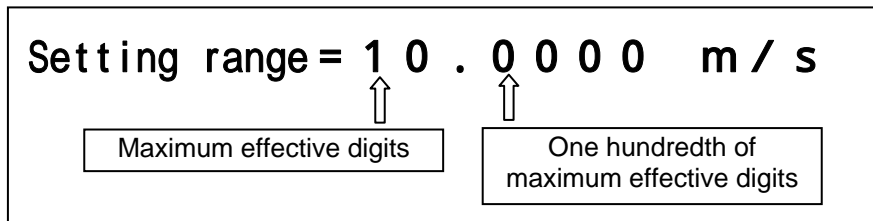

Likewise, when the setting range 1m/s and display digit setting is 1/100, the measured value will be displayed to the second decimal place.

The numbers less than the displayed digits will be rounded.

Note: The maximum display digits for flow velocity, flow rate and custom value are 7 digits.

If the measured value exceeds 7 digits, the displayed value remains fixed at the maximum display value.

• Changing the totalized flow volume direction

You can change the totalized flow volume direction as described below.

The following is an example to change the Display 1 setting from Fixed forward totalized flow (F) to Bidirectional flow (B).

Switch operation	Display example	Description
	<p>DSPL1</p> <p>m³ F</p> <p>ESC ↵</p>	<p>Select "DSPL1" from the setting item selection menu.</p> <p>The currently set display setting (m³ F in this example) appears.</p> <p>Then push </p>
<p>STEP1</p> <p></p>	<p>DSPL1</p> <p> m³ F</p> <p> </p>	<p>The switches at the bottom change. (are shown.)</p> <p>At the same time, the cursor appears.</p>
<p>STEP2</p> <p> </p>	<p>DSPL1</p> <p>m³ B</p> <p> </p>	<p>Push to move the cursor to the third unit (totalized flow direction) and then push to change the direction.</p> <p>Then push to set the display unit temporarily.</p>
<p>STEP3 (=END)</p> <p></p>	<p>DSPL1</p> <p>m³ B</p> <p>SET OK?</p> <p>ESC OK NO</p>	<p>Pushing shows a message to confirm whether the setting is OK or not.</p> <p>If OK, push . If you need to redo the setting, push .</p> <p>Pushing cancel the setting operation and exits the setting screen.</p>

Note: The setting item for the third unit (flow volume direction code) changes cyclically as shown below.

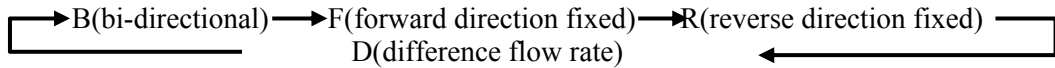

For Display 2 setting, select DSPL2 from the setting menu.

8.2.7 Custom Coefficient Setting









You can set the custom coefficient used when CUSTOM is selected for display setting or span setting. Custom coefficient can be set except 0.

Displayed value when CUSTOM is set	= Measured value in m ³ /min unit × Custom coefficient
Span value when CUSTOM is set	= Span value in m ³ /min unit × Custom coefficient

Note: Custom coefficient is applied when CUSTOM is selected in the display setting or span setting. Other values such as instantaneous flow rate (display unit, such as m/s and m³/min), displayed values such as totalized flow and pulse out will not be applied. The details see **10.10 “Custom unit function”**.

The following is an example to change the custom coefficient from 1.00 to 2.25.

Switch operation	Display example	Description
	B: DISPLAY 1 DSPL1 2 DSPL2 3 CS VAL 4 CS UNIT 5 EXIT [▼] [ESC] [↵]	Select "CS VAL" from the setting item selection menu.
STEP1 [↵]	CS VAL 1.00000 [ESC] [↵]	The currently set custom coefficient (1.00000 in this example) appears. Then push [↵]. * Pushing [ESC] returns you to the setting menu.
STEP2 [↵]	CS VAL 1.00000 [▲] [▶] [↵]	The switches at the bottom change. ([▲] [▶] [↵] are shown.) At the same time, the cursor appears.
STEP3 [▲] [▶]	CS VAL 2.25000 [▲] [▶] [↵]	Push [▶] to move the cursor to the desired digit and push [▲] to change the number of the digit. Repeat this operation to change the value to 2.25. When the value is changed to the desired value, push [↵] to set the custom coefficient temporarily.

Switch operation	Display example	Description
STEP4 (=END) 	CS VAL 2.25000 SET OK?   	Pushing  shows a message to confirm whether the setting is OK or not. If OK, push  . If you need to redo the setting, push  . Pushing  cancels the setting operation and exits the setting screen.



























Note: The custom coefficient setting precision is 5 digits. Therefore, the input value changes as follows depending on the setting value:









(Example) Input value, "85713038" → After the setting is confirmed, "85713040"

8.2.8 Custom Unit Setting

You can set the custom unit used when CUSTOM is selected for display setting. For custom unit setting, you can set any combination of characters within 7 characters.

The following is an example to change the custom unit from AAA/BBB to XXX/ZZZ.

Switch operation	Display example	Description
	B: DISPLAY 1 DSPL1 2 DSPL2 3 CS VAL 4 CS UNIT 5 EXIT   	Select "CS UNIT" from the setting item selection menu.
STEP1 	CS UNIT AAA/BBB  	The currently set custom unit (AAA/BBB in this example) appears. Then push  . * Pushing  returns you to the setting menu.
STEP2 	CS UNIT  AAA/BBB   	The switches at the bottom change. (   are shown.) At the same time, the cursor appears.
STEP3   	CS UNIT  AAA/BBB   	Push  or  to change the character. When the desired character is obtained, push  . The cursor moves to the next character.

Switch operation	Display example	Description
STEP4(=END) 	CS UNIT XXX/ZZZ SET OK?   	Pushing  when the cursor is positioned on the 7th character shows a message to confirm whether the setting is OK or not. If OK, push  . If you want to redo the setting, push  . Pushing  cancels the setting operation and exits the setting screen.

Note : The selectable characters are displayed cyclically as shown below:

Symbol 1	! " # \$ % & ' () * + , - . /
Numeric characters	0 ~ 9
Symbol 1	: ; < = > ? .
Alphabetical characters (uppercase)	A ~ Z
Alphabetical characters (lowercase)	a ~ z
Special character	" " (Space)

8.2.9 Span (Range)

You can set the following constants in this setting item:

- (1) Range type
- (2) Unit of span (can be changed in Range 1)
- (3) Span
- (4) Hysteresis

• Range type

Multiple ranges can be used by selecting the range type. You can select a single range, multiple ranges, or forward/reverse multiple ranges.

Select one from five types shown below:

Selection items (display)	Description
SINGLE	Single range
4F-0R	Unidirectional flow, automatic selection of multiple ranges
2F-2R	Bidirectional flows, automatic selection of multiple ranges
EXT 2F-0R	Unidirectional flow, multiple ranges selected by external signal
EXT 2F-2R	Bidirectional flows, multiple ranges selected by external signal

- Span

You can set the span for actual flow rate or flow velocity.

(1) Setting range

The span can be set within 0.5 m/s to 10 m/s in terms of flow velocity.

If you try to set the span outside of this range, either high limit or low limit error message appears:

HIGH OVER SPEC (if the set value exceeds 10 m/s)

LOW OVER SPEC (if the set value is less than 0.1 m/s)

Try again to set the span within the range.

(2) Limitation of multiple ranges

When multiple ranges are used, the following must be observed:

In the case of unidirectional flow,

Range 1 > Range 2 > Range 3 > Range 4

In the case of bidirectional flows,

Range 1 > Range 2,

Range 3 > Range 4

If you try to set the ranges not conforming to the above, the following message appears:

MULTI RANGE ERROR

Try again to set the ranges as specified above.

(3) Influence on count rate (pulse rate)

If you have changed the range when count rate (pulse rate) is set, the pulse output for 100% output may exceed the maximum allowable range.

If this happens, the following message appears after all ranges are set and the screen goes to the count rate (pulse rate) setting sequence.

HIGH OVER CNT RATE or LOW OVER CNT RATE

In this case, set the count rate (pulse rate) again in accordance with **8.2.20 “Count Rate, Pulse Width Setting Mode and Pulse Width.”**

- Unit of span

The span setting is performed for Range 1.

The same unit as that of Range 1 applies automatically to Ranges 2 to 4 and thus its setting is not needed.

You can select the setting unit from the units below:

Flow velocity unit	m/s, ft/s
Flow rate unit (Note)	m ³ /s, m ³ /min, m ³ /h, m ³ /d, L/s, L/min, L/h, L/d mL/s, mL/min, mL/h, mL/d, gal/s, gal/min, gal/h, gal/d bbl/s, bbl/min, bbl/h, bbl/d, pt/s, pt/min, pt/h, pt/d qt/s, qt/min, qt/h, qt/d ft ³ /s, ft ³ /min, ft ³ /h, ft ³ /d, Mgl/s, Mgl/min, Mgl/h, Mgl/d
Other (Note)	Custom unit

If you have changed the unit, the new span value will be displayed automatically based on the newly set unit. When custom unit is selected, the new span value will be displayed automatically based on the custom coefficient and custom unit of **8.2.7 “Custom Coefficient Setting”** and **8.2.8 “Custom Unit Setting”**. The details see **10.10 “Custom unit function”**.

- Range hysteresis

The hysteresis is the dead band used when multiple ranges are switched. You can set the hysteresis within the range of 0 to 25% in increments of 0.1%.

The hysteresis is set only when automatic selection of multiple ranges is used.

- Setting sequence of span (range)

The following is the setting sequence for span (range).

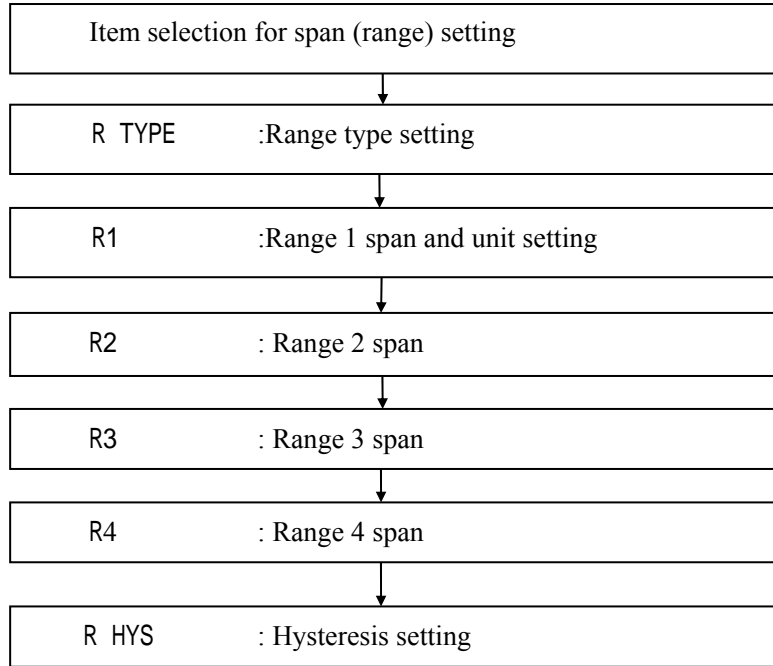





Note: If any type of multiple ranges is selected as range type, the setting screens of Range 1 to Hysteresis forcefully appears one after another. If the setting is cancelled halfway, all of the settings including the ones already set will be cancelled.

You can check or change each constant as described below.

- Checking each constant































Switch operation	Display example	Description
	<pre> C: RANGE 1 R TYPE 2 R1 3 R2 4 R3 5 R4 6 R HYS 7 EXIT </pre> <div style="display: flex; justify-content: space-around; margin-top: 5px;"> ▼ ESC ↵ </div>	Select "R1" from the setting item selection menu.
<div style="display: flex; justify-content: center; align-items: center; margin: 10px 0;"> ↵ </div>	<pre> R1 </pre> <div style="text-align: center; margin: 10px 0;"> <p>5.00000</p> <p>m/s</p> </div> <div style="display: flex; justify-content: space-around; margin-top: 5px;"> ESC ↵ </div>	The currently set span value of Range 1 appears.









Switch operation	Display example	Description
	<p>C:RANGE 1 R TYPE 2 R1 3 R2 4 R3 5 R4 6 R HYS 7 EXIT</p> <p style="text-align: center;">    </p>	<p>Pushing  returns you to the setting menu.</p>

• Changing the range type

The range type should be set before changing the span.

The following is an example to change the range type from Single range (SINGLE) to Bidirectional automatic selection of multiple ranges (2F-2R).



























Switch operation	Display example	Description
	<p>C:RANGE 1 R TYPE 2 R1 3 R2 4 R3 5 R4 6 R HYS 7 EXIT</p> <p style="text-align: center;">    </p>	<p>Select "R TYPE" from the setting item selection menu.</p>
STEP1	<p>R TYPE SINGLE</p> <p style="text-align: center;">  </p> <p style="text-align: center;">   </p>	<p>The currently set range type (SINGLE in this example) appears.</p> <p>Then push  .</p> <p>* Pushing  returns you to the setting menu.</p>
STEP2	<p>R TYPE 4F-0R</p> <p style="text-align: center;">    </p>	<p>The switches at the bottom change. (   are shown.) At the same, the cursor appears. (The item indicated by the cursor is highlighted.)</p> <p>Then push  .</p>
STEP3	<p>R TYPE 2F-2R</p> <p style="text-align: center;">   </p> <p style="text-align: center;">    </p>	<p>You can continue to change the setting item. Push   to change the selection items.</p> <p> : Selected item is scrolled up.  : Selected item is scrolled down.</p>
STEP4	<p>R TYPE 2F-2R</p> <p style="text-align: center;">   </p> <p style="text-align: center;">    </p>	<p>Perform this operation to change the setting to 2F-2R.</p> <p>When the item is changed to the desired item, push  to set the item temporarily.</p>

















Switch operation	Display example	Description
STEP5(=END) 	R TYPE 2F-2R SET OK?   	When you push  , a message appears to confirm whether the setting is OK or not. If OK, push  . If you want to redo the setting, push  . Pushing  cancels the setting operation and exits the setting screen.

• Changing the span

You can set the span value for each range.

The following is an example to change the span of Range 1 from 2.0 m/s to 100 L/min.

Switch operation	Display example	Description
STEP1	R1 2.00000 m/s  	Select "R1" from the setting item selection menu. The currently set span value of Range1 (2.00000 m/s in this example) appears. Then push  .
STEP2	R1  2.00000 m/s   	The switches at the bottom change. ( ,  , ) are shown.) At the same time, the cursor appears.
STEP3	R1 2.00000  m/s   	Push  to move the cursor to the digit of the first unit.
STEP4	R1 3.93000  L/s   	Push  to change the first unit. Push  to move the cursor to the digit of the time unit.
STEP5	R2 236.000 L/  min   	Push  to change the time unit. Push  to move the cursor to the digit of span value.

Switch operation	Display example	Description
STEP6  	R2  36.000 L/min   	Push  to change the number of the digit. Push  to move the digit.
STEP7 (=END) 	R2 100.000 l/min SET OK?   	When you push  , a message appears to confirm whether the setting is OK or not. If OK, push  . If you want to redo the setting, push  . Pushing  cancels the setting operation and exits the setting screen.

Note: Unites of the measuring unit changes as shown below:

First unit

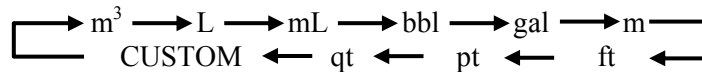

Second unit
(Time unit)

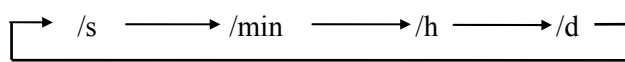



























- However, the following first and second unit combinations cannot be selected:
m/min, m/h, m/d, ft/min, ft/h, ft/d
- In the case of custom unit, time unit is not displayed.
- In the case of custom unit, character string set in 8.2.8 “Custom Unit Setting” is displayed. Identification character “*” showing the custom unit is displayed at the head of custom unit.

• Changing the hysteresis

The hysteresis used for multi-range switching is set to 3% (with respect to Range 1) when the flowmeter is shipped from the factory, unless otherwise specified.

The following is an example to change the hysteresis from 3% to 5%.

Switch operation	Display example	Description
STEP1	R HYS 03.0 %  	Select "R HYS" from the setting item selection menu. The currently set hysteresis (3.0% in this example) appears. Then push  .
STEP2 	R HYS  3.0 %   	The switches at the bottom change. (   are shown.) At the same time, the cursor appears.

Switch operation	Display example	Description
STEP3  	R HYS 05.0 %   	Push  to move the cursor to the desired digit and push  to change the number of the digit.
STEP4 (=END) 	R HYS 05.0 % SET OK?   	When you push  , a message appears to confirm whether the setting is OK or not. If OK, push  . If you want to redo the setting, push  . Pushing  cancels the setting operation and exits the setting screen.

Note: If you try to set a value exceeding 25.0%, HIGH OVER SPEC error appears and the value returns to the previous value. Set a value once again.

8.2.10 Damping Constant

The damping constant is used to moderate output fluctuations. (The larger the damping constant, the more the output is averaged. But the response to an input change will be slower.) The damping constant can be set as follows:

The damping constant is set for 0.0 sec, 0.5 sec and 1 to 200 sec (in increments of 1 second)







Note: 0.0 sec setting will work as equal to 0.1 sec damping constant.























Set 1 sec or more for normal operation.

If you set a value exceeding 200s, it is forcibly changed to 200s before data is written.

Proceed as follows to check or change the damping constant.

Shown below is an example of changing the damping constant from 5.0s to 10s.

Switch operation	Display example	Description
	D-FILTER 1 DAMPING 2 LIM RATE 3 LIM TIME 4 EXIT   	Select "DAMPING" from the setting item selection menu.
STEP1 	DAMPING 05.0 S  	The currently set damping constant (5.0s in this example) appears. Then push  .

Switch operation	Display example	Description
STEP2 	DAMPING 05.0 S   	The switches at the bottom change. (   are shown.) At the same time, the cursor appears.
STEP3  	DAMPING 10.0 S   	Push  to move the cursor to the desired digit and push  to change the number of the digit.
STEP4 (=END) 	DAMPING 10.0 S SET OK?   	When you push  , a message appears to confirm whether the setting is OK or not. If OK, push  . If you want to redo the setting, push  . Pushing  cancels the setting operation and exits the setting screen.

8.2.11 Rate-Of-Change Limit and Control Limit Time

The rate-of-change limit is used to control sudden changes of the converter’s flow rate signal output when excessive noise is contained in the flow rate signal.

The rate-of-change limit (set in percent value to the span of measuring range) and control limit time (set in second) are used, and if the flow rate signal sampling value exceeds the rate-of-change limit value based on the previous average value of the flow rate signal, the converter rejects the sampling value and outputs the average value including the maximum value of the rate-of-change value.

In addition, if the limit-exceeding flow rate sampling value continues for the same flow direction for more than the preset control limit time, the data will be considered as flow rate variation and that sampling value will be used as normal output data.

You can set these two parameters within the ranges shown below:

- Rate-of-change limit 0 to 30% / 50ms (in increments of 0.1%)
- Control limit time: 0 to 20s (in increments of 1s)

Note : If “0” is set in either of these parameters, the rate-of-change limit function is disabled.

• Changing the rate-of-change limit

The following is an example to change the rate-of-change limit value from 10.0% to 15.0%.

Switch operation	Display example	Description
	<p>D:FILTER 1 DAMPING 2 LIM RATE 3 LIM TIME 4 EXIT</p> <p>▼ ESC ↵</p>	Select "LIM RATE" from the setting item selection menu.
STEP1 ↵	<p>LIM RATE</p> <p>10.0</p> <p>%</p> <p>ESC ↵</p>	The currently set value (10.0% in this example) appears. Then push ↵.
STEP2 ↵	<p>LIM RATE</p> <p>10.0</p> <p>%</p> <p>▲ ▶ ↵</p>	The switches at the bottom change. (▲ ▶ ↵ are shown.) At the same time, the cursor appears.
STEP3 ▲ ▶	<p>LIM RATE</p> <p>15.0</p> <p>%</p> <p>▲ ▶ ↵</p>	Push ▶ to move the cursor to the desired digit and push ▲ to change the number of the digit.
STEP4 (=END) ↵	<p>LIM RATE</p> <p>15.0</p> <p>%</p> <p>SET OK?</p> <p>ESC OK NO</p>	When you push ↵, a message appears to confirm whether the setting is OK or not. If OK, push OK. If you want to redo the setting, push NO. Pushing ESC cancels the setting operation and exits the setting screen.

Note : If you try to set a value exceeding 30.0%, HIGH OVER SPEC error appears and the value returns to the previous value. Set a value again.

8.2.12 Low Cutoff

The low cutoff is the function to set the current output to zero forcefully if the flow rate is equal to or less than the low cutoff value set near 0%.

The low cutoff value can be set within the range 0 to 10% in increments of 0.1%.

You can check or change the low cutoff value as described below.

The following is an example to change the low cutoff value from 1.0% to 3.0%.

Switch operation	Display example	Description
	<p>E-LOW CUT 1 CUT VAL 2 DSPL SET 3 EXIT</p> <p> </p>	Select "CUT VAL" from the setting item selection menu.
STEP1	<p>CUT VAL</p> <p>01.0 %</p> <p></p> <p> </p>	The currently set low cutoff value (01.0% in this example) appears. Then push .
STEP2	<p>CUT VAL</p> <p>01.0 %</p> <p></p> <p> </p>	The switches at the bottom change. (are shown.) At the same time, the cursor appears.
STEP3	<p>CUT VAL</p> <p>03.0 %</p> <p> </p> <p> </p>	Push to move the cursor to the desired digit and push to change the number of the digit.
STEP4 (=END)	<p>CUT VAL</p> <p>03.0 %</p> <p>SET OK?</p> <p> </p>	When you push , a message appears to confirm whether the setting is OK or not. If OK, push . If you want to redo the setting, push . Pushing cancels the setting operation and exits the setting screen.

Note: If you try to set a value exceeding 10.0%, HIGH OVER SPEC error appears and the value returns to the previous value. Set a value again.

8.2.13 Display Low Cutoff

When low cutoff is set in 8.2.12 “Low Cutoff,” this function determines whether to use the low cutoff processing for displayed values.

You can select the display low cutoff setting from the items in the table below.

- Display low cutoff setting function

Selection items	Displayed values
LINEAR	Low cutoff processing is not used for displayed values.
LOW CUT	Displayed values are processed with low cutoff.









For example, if the low cutoff is set to 10% and the indicated value of the input from the detector is 5%, the displayed value on the screen becomes as shown below.

Display low cutoff	Displayed value
LINEAR	5.0%
LOW CUT	0.0%

You can check or change the display low cutoff as described below.

The following is an example to change the setting from LINEAR to LOW CUT.

















Switch operation	Display example	Description
	E:LOW CUT 1 CUT VAL 2 DSPL SET 3 EXIT ▼ ESC ↵	Select "DSPL SET" from the setting item selection menu.
STEP1 ↵	DSPL SET LINEAR ESC ↵	The currently set low cutoff setting (LINEAR in this example) appears. Then push ↵ . Pushing ESC returns you to the setting menu.
STEP2 ↵	DSPL SET LINEAR ▼ ▲ ↵	The switches at the bottom change. (▼ ▲ ↵ are shown.) At the same time, the cursor appears. (The item indicated by the cursor is highlighted.) Then push ▼ ▲ .
STEP3 ▲ ▼	DSPL SET LOW CUT ▼ ▲ ↵	You can continue to change the setting item. Push ▼ ▲ to change the selection items. ▲ : Selected item is scrolled up. ▼ : Selected item is scrolled down. When the desired item is selected, push ↵ to set the item temporarily.

Switch operation	Display example	Description
STEP4(=END) 	DSPL SET LOW CUT SET OK?   	When you push  , a message appears to confirm whether the setting is OK or not. If OK, push  . If you want to redo the setting, push  . Pushing  cancels the setting operation and exits the setting screen.

Note: The measured value sent from the converter through communications is the value processed with display low cutoff.

8.2.14 Still Water Zero Adjustment

Zero adjustment is performed with the fluid held still in the detector's measurement pipe.

Switch operation	Display example	Description
	F·ZERO 1 ZERO ADJ 2 MANUAL 3 EXIT   	Select "ZERO ADJ" from the configuration item selection menu.
STEP1 	ZERO ADJ 1.2 %  	The current flow rate measurement value appears. Then push and hold  longer. * Pushing  returns you to the setting menu.
STEP2  Longer	ADJ READY 1.2 %  	The title display changes to ADJ READY, and the converter is ready for zero adjustment. * Pushing  returns you to the previous screen.
STEP3 	NOW ZERO ADJUSTING	Pushing  starts zero adjustment.
STEP4(=END)	ZERO ADJ 0.0 %  	Zero adjustment ends in several seconds and the flow rate measured value appears. Pushing  returns you to the setting menu.

Note 1: To start still water zero adjustment, push and hold  longer.

Note 2: Still water zero adjustment is possible only when the flow rate value is within the range of ±1.25 m/s.

Note 3: If you want to cancel the adjustment when ADJ READY is displayed, push . This returns you to the state showing the flow rate measurement value on the screen.

8.2.15 Manual Zero Adjustment

This function is used to perform zero adjustment simply by comparing the output value of the converter with the process value of other instruments without stopping the process of measurement. If zero adjustment described in 8.2.14, "Still Water Zero Adjustment" can be performed, this manual setting is not needed.

- Changing the manual zero adjustment value
Calculate the adjustment value with the following equation:

$$\text{Adjustment value (\%)} = \{(\text{Actual flow rate}) - (\text{Converter's measured value})\}$$

- * Calculate the manual zero value using the % value for the setting range (Range 1) of the converter. See the following example.















(Example)

	Flow rate	% value to setting span
Actual flow rate obtained from other instrument	10.0 m ³ / min	50.0 %
Converter's measured value	10.5 m ³ / min	52.5 %
Manual zero adjustment value		-2.5 %

(If manual zero adjustment value is set to +2.5 %, the converter output is shifted by -2.5% and the output of 50.0 % will be obtained.)

The following is an example to change the manual zero adjustment value from +1.0% to -2.5%.

Switch operation	Display example	Description
	F: ZERO 1 ZERO ADJ 2 MANUAL 3 EXIT ▼ ESC ↵	Select "MANUAL" from the setting item selection menu.
STEP1	MANUAL +001.0 % ESC ↵	The currently set manual zero value (+1.0% in this example) appears. Then push ↵.
STEP2	MANUAL + 001.0 % ↵ ▲ ▶ ↵	The switches at the bottom change. (▲ ▶ ↵ are shown.) At the same time, the cursor appears.

Switch operation	Display example	Description
STEP3  	MANUAL -002.5 %   	Push  to move the cursor to the desired digit and push  to change the symbol or number of the digit.
STEP4 (=END) 	MANUAL -002.5 % SET OK?   	Pushing  shows a message to confirm whether the setting is OK or not. If OK, push  . If you need to redo the setting, push  . Pushing  cancels the setting operation and exits the setting screen.

Note: The manual zero adjustment value can be set within the range equivalent to ± 1 m/s (± 10 % of the maximum range 10m/s). If you try to set a value out of this range, an error message HIGH OVER SPEC or LOW OVER SPEC appears. If this happen, redo the setting.

In addition, if you perform still water zero adjustment with water held still, the manual zero adjustment value will be cleared to 0.0%.

8.2.16 4–20mA Alarm Output Setting

The 4–20mA alarm output setting is the function to fix the current output to a selected fixed value if an alarm occurs when self-diagnosis function is performed.



The 4–20mA alarm output value can be selected from the following table.

































- The 4–20mA alarm output setting function

Selection items	The 4–20mA alarm output value
UNDER 3mA	3.0mA or less
4mA	4.0mA
HOLD	Fixed to the present value
OVER 24mA	24.0mA or more

You can check or change the 4–20mA alarm output value as described below.

The following is an example to change the setting from UNDER 3.0mA to 4.0mA.

Switch operation	Display example	Description
  	G: 4-20mA 1 ALM 4-20 2 LOW LIM 3 EXIT	Select "ALM 4-20" from the setting item selection menu.

Switch operation	Display example	Description
STEP1 	ALM 4-20 UNDER 3mA  	The currently set value (UNDER 3.0mA in this example) appears. Then push  . * Pushing  returns you to the setting menu.
STEP2 	ALM 4-20 UNDER 3mA   	The switches at the bottom change. (   are shown.) At the same time, the cursor appears. (The item indicated by the cursor is highlighted.) Then push   .
STEP3  	ALM 4-20 4mA   	You can continue to change the setting item. Push   to change the selection items.  : Selected item is scrolled up.  : Selected item is scrolled down. When the desired item is selected, push  to set the item temporarily.
STEP4 (=END) 	ALM 4-20 4mA SET OK?   	When you push  , a message appears to confirm whether the setting is OK or not. If OK, push  . If you want to redo the setting, push  . Pushing  cancels the setting operation and exits the setting screen.

8.2.17 Output Low Limit Setting

The low limit of the current output for converter can be set.
 The output low limit can be selected from the items listed in the table below.

- Output low limit setting function

Selection items	Output low limit
4.0mA	The current value can be outputted up to 4.0mA (0%).
3.2mA	The current value can be outputted up to 3.2mA (-5%).
2.4mA	The current value can be outputted up to 2.4mA (-10%).

Note: If the low cutoff value in 8.2.12 “Low Cutoff” is set to a value other than 0%, the output low limit value will be fixed to 4.0mA, regardless of the set value.

You can check or change the output low limit as described below.
 The following is an example to change the output low limit value from 4.0mA to 2.4mA.

Switch operation	Display example	Description
	G:4-20mA 1 ALM 4-20 2 LOW LIM 3 EXIT ▼ ESC ↵	Select "LOW LIM" from the setting item selection menu.
STEP1 ↵	LOW LIM 4.0mA ESC ↵	The currently set value (4.0mA in this example) appears. Then push ↵ . *Pushing ESC returns you to the setting menu.
STEP2 ↵	LOW LIM 4.0mA ▼ ▲ ↵	The switches at the bottom change. (▼ ▲ ↵ are shown.) At the same time, the cursor appears. (The item indicated by the cursor is highlighted.) Then push ▼ ▲ .
STEP3 ▲ ▼	LOW LIM 2.4mA ▼ ▲ ↵	You can continue to change the setting item. Push ▼ ▲ to change the selection items. ▲ : Selected item is scrolled up. ▼ : Selected item is scrolled down. When the desired item is selected, push ↵ to set the item temporarily.
STEP4 (=END) ↵	LOW LIM 2.4mA SET OK? ESC OK NO	When you push ↵, a message appears to confirm whether the setting is OK or not. If OK, push OK . If you want to redo the setting, push NO . Pushing ESC cancels the setting operation and exits the setting screen.

8.2.18 Digital Output

Digital output functions can be selected.
 You can select the digital output function from the tables shown below.
 For details of digital output functions, see 10, "Functional Description."

●Digital output functions

Selection items	Digital output functions
NO USE	Not used
H ALM	High alarm output
L ALM	Low alarm output
HH ALM	High-High alarm output
LL ALM	Low-Low alarm output
RNG SIG1	Range output No. 1
RNG SIG2	Range output No. 2
PRESET C	Preset count output
CONV ALM	Converter failure alarm output
PLS OUT	Pulse output
PLS FRD	Fixed forward flow pulse output
PLS REV	Fixed reverse flow pulse output
MRH ALM	Multi-range high alarm output (option)
MRL ALM	Multi-range low alarm output (option)

Notes: When the range type is set to Forward/reverse multiple ranges, and if the pulse output (PLS OUT) is selected, pulses of forward and reverse directions will be output.
For setting method of the range type, see 8.2.9, “Span (Range).”



























●Digital output active status (Only when alarm output is set)

Selection items	Alarm output action
NormCLOSE	Normal: Contact closed, Alarm out: Contact open
NormOPEN	Normal: Contact open, Alarm out: Contact closed

●Changing the digital output function

The following is an example to change the Digital Output 1 (DO1) function from High alarm output (H ALM) to Low alarm output (L ALM).

Switch operation	Display example	Description
	H=DO 1 DO1 FUNC 2 DO2 FUNC 3 DO1 STAT 4 DO2 STAT 5 EXIT ▼ ESC ↵	Select "DO1 FUNC" from the setting item selection menu.
STEP1 ↵	DO1 FUNC H ALM ESC ↵	The current setting (H ALM in this example) appears. Then push ↵ . * Pushing ESC returns you to the menu screen.

Switch operation	Display example	Description
STEP2 	D01 FUNC H ALM   	The switches at the bottom change. (   are shown.) At the same time, the cursor appears. (The item indicated by the cursor is highlighted.) Then push   .
STEP3  	D01 FUNC L ALM   	You can continue to change the setting item. Push   to change the selection items.  : Selected item is scrolled up.  : Selected item is scrolled down. When the desired item is selected, push  to set the item temporarily.
STEP4 (=END) 	D01 FUNC L ALM SET OK?   	When you push  , a message appears to confirm whether the setting is OK or not. If OK, push  . If you want to redo the setting, push  . Pushing  cancels the setting operation and exits the setting screen.

8.2.19 Digital Input

Digital input functions can be selected.

You can select the digital input function from the table shown below.

For details of digital input functions, see 10, “Functional Description.”

•Digital input functions

Selection items	Digital input functions
NO USE	Not used
CNT ST/SP	Totalizer Start / Stop
CNT RS/ST	Totalizer Reset / Start
RNG SW	Remote selection switch of multiple ranges
ZERO ADJ	Still water zero adjustment start
FIX OUT	Fixed output mode control

•Digital input control signal

You can select the detective level of the digital input, as shown below, to control the totalizer and pulse output.









(Only when the digital input function is set for totalizer control input)

Selection items	Digital input function setting	Totalizer control signal
L LEVEL	CNT ST/SP (Totalizer START/STOP)	H signal : Totalizer STOP L signal : Totalizer START
	CNT RS/ST (Totalizer RESET/START)	H signal : Totalizer START L signal : Totalizer RESET
H LEVEL	CNT ST/SP (Totalizer START/STOP)	H signal : Totalizer START L signal : Totalizer STOP
	CNT RS/ST (Totalizer RESET/START)	H signal : Totalizer RESET L signal : Totalizer START

•Changing the digital input function

The following is an example to change the Digital Input (DI) function from No use (NO USE) to Totalizer Start / Stop (CNT ST/SP).

Switch operation	Display example	Description
	<p>1 DI FUNC 2 DET LVL 3 EXIT</p> <p>▼ ESC ↵</p>	Select "DI FUNC" from the setting item selection menu.
<p>STEP1</p> <p>↵</p>	<p>DI FUNC</p> <p>NO USE</p> <p>ESC ↵</p>	<p>The current setting (NO USE in this example) appears.</p> <p>Then push ↵ .</p> <p>* Pushing ESC returns you to the menu screen.</p>
<p>STEP2</p> <p>↵</p>	<p>DI FUNC</p> <p>NO USE</p> <p>▼ ▲ ↵</p>	<p>The switches at the bottom change. (▼ ▲ ↵ are shown.)</p> <p>At the same time, the cursor appears. (The item indicated by the cursor is highlighted.)</p> <p>Then push ▼ ▲ .</p>
<p>STEP3</p> <p>▲ ▼</p>	<p>DI FUNC</p> <p>CNT ST/SP</p> <p>▼ ▲ ↵</p>	<p>You can continue to change the setting item. Push ▼ ▲ to change the selection items.</p> <p>▲ : Selected item is scrolled up. ▼ : Selected item is scrolled down.</p> <p>When the desired item is selected, push ↵ to set the item temporarily.</p>

Switch operation	Display example	Description
STEP4 (=END) 	DI FUNC CNT ST/SP SET OK?   	When you push  , a message appears to confirm whether the setting is OK or not. If OK, push  . If you want to redo the setting, push  . Pushing  cancels the setting operation and exits the setting screen.

8.2.20 Count Rate (Pulse Rate), Pulse Width Setting Mode and Pulse Width

In this section, the volume per count (pulse) for totalized flow operation and the pulse width for totalization pulse output can be set.

The totalized flow counts is not affected by the display setting but it is recommended that you set a volume unit for Display 1 or Display 2 to check its operation.

- The count rate must be set so that the pulse output at 100% output is within the range below:

3.6 to 10800000 pulse/h (0.001 to 3000 pulse/s).

If you try to set a value outside of this range, an error message HIGH OVER SPEC or LOW OVER SPEC appears and the value returns to the previous value.

Note: Count rate setting range

Example: In the case the range is 108m³/h (0.03m³/s),

Minimum value (for 10800000 pulse/h):
 $108(\text{m}^3/\text{h}) / 10800000(\text{pulse}/\text{h}) = 0.00001\text{m}^3 = 0.01\text{L (liter)}$.

Maximum value (for 3.6 pulse/h):
 $108(\text{m}^3/\text{h}) / 3.6(\text{pulse}/\text{h}) = 30\text{m}^3$.

- The pulse width must be set to a value within the range of 0.3ms to 500ms.
 If you try to set a value exceeding 500 ms, the value will be forcibly changed to 500ms.
- The pulse width must be set to 40% or less of the period of pulse frequency at 100% output.
 If you try to set a value exceeding the limit, regardless of the setting above, an error message HIGH OVER SPEC appears and the value returns to the previous value.

If the pulse width is set to 0, it will be automatically set to 40% of the period of pulse frequency at 100% output. In this case, the pulse width setting mode remains in the Manual mode. If the calculation result exceeds 100ms, it will be forcibly set to 100ms.

- For pulse width setting mode, you can select either AUTO or MANUAL.

Depending on this setting, the pulse width setting varies as shown in the table below:

Selection item	Pulse width value to be set
AUTO	After the count rate is set, the pulse width is automatically set to 40% of the period of pulse frequency at 100% output.
MANUAL	Even after the count rate is set, the pulse width is not changed. * However, if the pulse width becomes out of the setting range as a result of count rate setting, the screen is automatically switched to the pulse width setting screen after the count rate is set.

Note: If the count rate exceeds 1000 (pulse/s), the pulse width setting mode is limited to the AUTO mode only and you cannot set the width manually.

- Examples of pulse width setting range

Example 1

In the case the range is 108m³/h (0.03m³/s) and the count rate is 0.00003m³:

Since the pulse rate is 108 (m³/h) / 0.00003(m³) = 3600000 pulse/h (1000 pulse/s), the period of pulse frequency at full scale is 1ms.

Therefore, the pulse width can be set only to: 1ms × 40% = 0.4ms only.

Example 2

In the case the range is 108m³/h (0.03m³/s) and the count rate is 30m³:

Since the pulse rate is 108(m³/h) / 30(m³) = 3.6 pulse/h (0.001 pulse/s), the period of pulse frequency at full scale is 1000000ms.

Therefore, the pulse width is: 1000000ms × 40% = 400000ms. However, since the maximum value is 500ms, the pulse width becomes 500ms.



























Example 3

In the case the range is 108m³/h (0.03m³/s), the count rate is 0.03m³ and the pulse width is set to 0ms:

Since the pulse rate is 108(m³/h) × 0.03(m³) = 3600 pulse/h (1 pulse/s), the period of pulse frequency at full scale is 1000ms.

Therefore, the pulse width is: 1000ms × 40% = 400ms. However, since the maximum value is 100ms in the case of Auto setting, the pulse width becomes 100ms.

You can check or change the count rate and pulse width as described below.
 The following is an example to change the count rate from 0.01m³ to 0.9 L.

Switch operation	Display example	Description
STEP1	CNT RATE 0.01000 m ³ ESC ↵	The currently set count rate (0.01m ³ in this example) appears. Then push  .
STEP2 	CNT RATE 0.01000 m ³   	The switches at the bottom change. (   are shown.) At the same time, the cursor appears.
STEP3  	CNT RATE 10.0000 L   	Push  to move the cursor to the digit of the unit and push  to change from “m ³ ” to “L”.
STEP4  	CNT RATE 0.90000 L   	Push  to move the cursor to the digit you want to change and push  to change the number of the digit.
STEP4 (=END) 	CNT RATE 0.90000 L SET OK? ESC OK NO	When you push  , a message appears to confirm whether the setting is OK or not. If OK, push  . If you want to redo the setting, push  . Pushing  cancels the setting operation and exits the setting screen.

To set the pulse width setting mode or pulse width, select the relevant item below from the setting menu.

Pulse width setting mode
Pulse width

PLS MODE
PLS WID

Note 1: The units of count rate change cyclically as shown below:

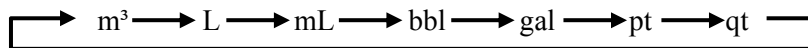

Note 2: After the count rate is set, related parameters are automatically set under the following conditions:

(1) Pulse width

When the pulse width setting mode is **AUTO**:

Pulse width will be automatically set according to the count rate.

When the pulse width setting mode is **MANUAL**:

After the count rate is set, if the pulse width is out of the setting range, the screen changes automatically to the pulse width setting screen.

(2) Digital Output 1 (DO1)

When the count rate is set from zero to other than zero:

If the digital output setting is **NO USE**,

Pulse output (**PLS OUT**) will be automatically set to Digital Output 1 (**DO1**) setting.

Note 3: Relationship between the count rate and totalizer operations

Count rate is set to zero while totalizer is in operation.



Totalizer will be forced to stop.



Count rate is set to other than zero.



Totalizer starts counting again.

* If the count rate is changed from a value other than zero to other value, the operation of totalizer does not change.

Note 4: If the pulse width setting mode is set to **MANUAL**, the screen automatically changes to the pulse width setting screen.

8.2.21 Preset Count

You can set the preset count for the preset counter.

Preset count can be set within the range of 0 to 99999999.

Preset counter will not be affected by the display setting but it is recommended that one of the volume units be set as the display unit so that the operating condition of the counter can be checked.

* Preset mode can be selected. For details, see **8.2.22, "Preset Mode."**

Note: Preset counter works only for forward flow counts.

You can check or change the preset count as described below.

The following is an example to change the preset count value from 500 (count) to 1000 (count).

Switch operation	Display example	Description
	<p>K·PRESET C 1 PRST VAL 2 OUT MODE 3 EXIT</p> <p>▼ ESC ↵</p>	Select "PRST VAL" from the setting item selection menu.
STEP1	<p>PRST VAL</p> <p>0000500</p> <p>ESC ↵</p>	The currently set value (500 in this example) appears. Then push ↵ .
STEP2	<p>PRST VAL</p> <p>0000500</p> <p>↵</p> <p>▲ ▶ ↵</p>	The switches at the bottom change. (▲ ▶ ↵ are shown.) At the same time, the cursor appears.
STEP3	<p>PRST VAL</p> <p>00001000</p> <p>▲ ▶</p> <p>▲ ▶ ↵</p>	Push ▶ to move the cursor to the digit you want to change and ▲ push to change the number of the digit.
STEP4 (=END)	<p>PRST VAL</p> <p>00001000</p> <p>SET OK?</p> <p>ESC OK NO</p> <p>↵</p>	When you push ↵, a message appears to confirm whether the setting is OK or not. If OK, push OK. If you want to redo the setting, push NO. Pushing ESC cancels the setting operation and exits the setting screen.

8.2.22 Preset Mode

The preset mode determines the function when the totalizer reaches the preset count. The present mode can be set from the items shown below.

●Preset mode



























Selection items	Preset mode
HOLD	Holds the output value.
50ms PLS	Outputs a one shot pulse of 50ms width.
500ms PLS	Outputs a one shot pulse of 500ms width.

Note: If you set the preset mode to "50ms PLS" or "500ms PLS", you need to set the preset count to 1, 2, 5, 25, 125 ×10ⁿ. (If you set a value that does not meet this condition, the preset output timing may be shifted when the totalizer overflows.)

You can check or change the preset mode as described below.

The following is an example to change the present mode from Output condition hold (HOLD) to One-shot pulse output with pulse width of 50ms (50ms PLS).

Switch operation	Display example	Description
	<pre> K:PRESET C 1 PRST VAL 2 OUT MODE 3 EXIT </pre> <div style="text-align: center;"> <input type="button" value="▼"/> <input type="button" value="ESC"/> <input type="button" value="↵"/> </div>	Select "OUT MODE" from the setting item selection menu.
<p>STEP1</p> <div style="text-align: center;"> <input type="button" value="↵"/> </div>	<pre> OUT MODE HOLD </pre> <div style="text-align: center;"> <input type="button" value="ESC"/> <input type="button" value="↵"/> </div>	<p>The current setting (HOLD in this example) appears.</p> <p>Then push <input type="button" value="↵"/> .</p> <p>* Pushing <input type="button" value="ESC"/> returns you to the menu screen.</p>

Switch operation	Display example	Description
<p>STEP2</p> 	<p>OUT MODE</p> <p>HOLD</p>   	<p>The switches at the bottom change. (   are shown.)</p> <p>At the same time, the cursor appears. (The item indicated by the cursor is highlighted.)</p> <p>Then push  .</p>
<p>STEP3</p>  	<p>OUT MODE</p> <p>50ms PLS</p>   	<p>You can continue to change the setting item. Push   to change the selection items.</p> <p> : Selected item is scrolled up.</p> <p> : Selected item is scrolled down.</p> <p>When the desired item is selected, push  to set the item temporarily.</p>
<p>STEP4 (=END)</p> 	<p>OUT MODE</p> <p>50ms PLS</p> <p>SET OK?</p>   	<p>When you push , a message appears to confirm whether the setting is OK or not. If OK, push . If you want to redo the setting, push .</p> <p>Pushing  cancels the setting operation and exits the setting screen.</p>









8.2.23 Flow Rate High/Low Alarm and High-High/Low-Low Alarm



























The high/low limit, high-high/low-low limit of the flow rate, at which an alarm is generated, can be set as % value of the span flow rate of the set maximum range.

The high/low alarm, and high-high/low-low alarm values for flow rate can be set within the range of -10% to 110% (percentage to Range 1) in increments of 0.1%.

• Changing the high/low alarm on/off setting













The following is an example to change the high alarm setting from OFF to ON.















Switch operation	Display example	Description
	<p>L-H/L ALM1</p> <p>1 H SET</p> <p>2 H VAL</p> <p>3 L SET</p> <p>4 L VAL</p> <p>5 EXIT</p>   	<p>Select "H SET" from the setting item selection menu.</p>
<p>STEP1</p> 	<p>H SET</p> <p>OFF</p>  	<p>The current setting (OFF in this example) appears.</p> <p>Then push .</p> <p>* Pushing  returns you to the menu screen.</p>

Switch operation	Display example	Description
<p>STEP2</p> 	<p>H SET</p> <p>OFF</p>   	<p>The switches at the bottom change. (   are shown.)</p> <p>At the same time, the cursor appears. (The item indicated by the cursor is highlighted.)</p> <p>Then push  .</p>
<p>STEP3</p>  	<p>H SET</p> <p>ON</p>   	<p>You can continue to change the setting item. Push   to change the selection items.</p> <p> : Selected item is scrolled up.</p> <p> : Selected item is scrolled down.</p> <p>When the desired item is selected, push  to set the item temporarily.</p>
<p>STEP4 (=END)</p> 	<p>H SET</p> <p>ON</p> <p>SET OK?</p>   	<p>When you push , a message appears to confirm whether the setting is OK or not. If OK, push . If you want to redo the setting, push .</p> <p>Pushing  cancels the setting operation and exits the setting screen.</p>

• Changing the high/low alarm value

The following is an example to change the high alarm value from +105% to +103%.

Switch operation	Display example	Description
	<p>L: H/L ALM1</p> <p>1 H SET</p> <p>2 H VAL</p> <p>3 L SET</p> <p>4 L VAL</p> <p>5 EXIT</p>   	<p>Select "H VAL" from the setting item selection menu.</p>
<p>STEP1</p>	<p>H VAL</p> <p>+105.0</p> <p>%</p>  	<p>The currently set value (+105% in this example) appears.</p> <p>Then push .</p>
<p>STEP2</p> 	<p>H VAL</p> <p>+105.0</p> <p>%</p>   	<p>The switches at the bottom change. (   are shown.)</p> <p>At the same time, the cursor appears.</p>

Switch operation	Display example	Description
STEP3  	H VAL +10 3 .0 %   	Push  to move the cursor to the digit you want to change.  push to change the number of the digit.
STEP4 (=END) 	H VAL +103.0 SET OK?   	When you push  , a message appears to confirm whether the setting is OK or not. If OK, push  . If you want to redo the setting, push  . Pushing  cancels the setting operation and exits the setting screen.

Note: If you try to set a value outside of the range -10% to +110%, LOW OVER SPEC or HIGH OVER SPEC error appears and the value returns to the previous value. Set a value once again.

8.2.24 Mag-Prover -Self Diagnosis ON/OFF Setting

You can select on/off setting for Mag-Prover's self-diagnosis function.



































If the self-diagnosis function is set to OFF, no error message is displayed even if any of the errors listed below occurs.

- ROM error
- RAM error
- System parameter error
- Excitation cable is not connected or its wiring is open
- Excitation circuit failure
- ADC circuit error
- Totalizer data is destroyed

Selection items	Description
OFF	Self-diagnosis function is turned off.
ON	Self-diagnosis function is turned on.

If this function is set to ON and an error occurs, an error message appears on the Display 2 measured value screen. If an error occurs, the measurement items specified for Display 2 screen cannot be displayed unless the error is removed.

• Changing the Mag-Prover's self-diagnosis function setting
 The following is an example to change the Mag-Prover's self-diagnosis setting from OFF to ON.

Switch operation	Display example	Description
	N:SELF CHK 1 EMPTY 2 SELF CHK 3 CONV ALM 4 EXIT   	Select "SELF CHK" from the setting item selection menu.
STEP1 	SELF CHK OFF  	The current setting (OFF in this example) appears. Then push  . * Pushing  returns you to the menu screen.
STEP2 	SELF CHK OFF   	The switches at the bottom change. (   are shown.) At the same time, the cursor appears. (The item indicated by the cursor is highlighted.) Then push   .
STEP3  	SELF CHK ON   	You can continue to change the setting item. Push   to change the selection items.  : Selected item is scrolled up.  : Selected item is scrolled down. When the desired item is selected, push  to set the item temporarily.
STEP4 (=END) 	SELF CHK ON SET OK?   	When you push  , a message appears to confirm whether the setting is OK or not. If OK, push  . If you want to redo the setting, push  . Pushing  cancels the setting operation and exits the setting screen.

8.2.25 Fixed Value Output

The fixed value output function is used to output a fixed current and/or a fixed pulse output independently of the flow rate signal. (The fixed pulse output is available only when Digital Output 1 (DO1) or Digital Output 2 (DO2) is used for pulse output function. For DO2, output can be obtained only when fixed pulse output is 100pps or less.

The fixed-value output can be set in the ranges described below. (Current output and pulse output can be set and output at the same time.)

- Fixed current output: 2.4 to 24 mA (can be set in increments of 0.1 mA)
- Fixed pulse output: 0 to 3000 pps (can be set in increments of 1 pps)

If fixed output is set to ON, Display 2 screen is used to indicate the fixed output in the measurement mode.

Operation when fixed output is set to ON

Current output	Output is the fixed current output value.
Pulse output	Output is the fixed pulse rate pulse signal.
Digital output other than pulse output	Status in hold
Display	Display 2 screen: Used to indicate the fixed output (Note)

Display example:

* 3 0 0 0 P P S *
* 2 0 . 0 m A *

First line: Pulse count (5 digits maximum), Unit: (PPS) fixed

Second line: Current output (4 digits including a decimal point), Unit: (mA) fixed

















































This fixed value output function does not work in the calibration mode.

When OFF is selected in the fixed output function, the setting for output is not needed.

• Changing the fixed output function

The following procedure shows how to set the fixed output to ON and set the fixed current value/fixed pulse value. The fixed current value and fixed pulse value can be set independently.

Switch operation	Display example	Description
	<p>0: FIX OUT 1: FIX SET 2: CUR VAL 3: PLS VAL 4: EXIT</p> <p>▼ ESC ↵</p>	Select "FIX SET" from the setting item selection menu.
STEP1 ↵	<p>FIX SET OFF</p> <p>ESC ↵</p>	<p>The current setting (OFF in this example) appears.</p> <p>Then push ↵.</p> <p>* Pushing ESC returns you to the menu screen.</p>
STEP2 ↵	<p>FIX SET OFF</p> <p>▼ ▲ ↵</p>	<p>The switches at the bottom change. (▼ ▲ ↵ are shown.) At the same time, the cursor appears. (The item indicated by the cursor is highlighted.)</p> <p>Then push ▼ ▲.</p>
STEP3 ▲ ▼	<p>FIX SET ON</p> <p>▼ ▲ ↵</p>	<p>You can continue to change the setting item. Push ▼ ▲ to change the selection items.</p> <p>▲ : Selected item is scrolled up. ▼ : Selected item is scrolled down.</p> <p>When the desired item is selected, push ↵ to set the item temporarily.</p>

Switch operation	Display example	Description
STEP4 	FIX SET ON SET OK?   	When you push  , a message appears to confirm whether the setting is OK or not. If OK, push  . If you want to redo the setting, push  . Pushing  cancels the setting operation and exits the setting screen.
STEP5 	CUR VAL  4.0 mA   	The screen automatically changes to the fixed current value setting screen. The currently set value (4.0mA in this example) appears.
STEP6  	CUR VAL 20.0 mA   	Push  to move the cursor to the digit you want to change  push to change the number of the digit.
STEP7 	CUR VAL 20.0 mA SET OK?   	When you push  , a message appears to confirm whether the setting is OK or not. If OK, push  . If you want to redo the setting, push  . Pushing  cancels the setting operation and exits the setting screen.
STEP8 	PLS VAL  0000 PPS   	The screen automatically changes to the fixed pulse rate setting screen. The currently set value (0 PPS in this example) appears.
STEP9  	PLS VAL 00100 PPS   	Push  to move the cursor to the digit you want to change  push to change the number of the digit.
STEP10(=END) 	PLS VAL 00100 PPS SET OK?   	When you push  , a message appears to confirm whether the setting is OK or not. If OK, push  . If you want to redo the setting, push  . Pushing  cancels the setting operation and exits the setting screen.





- Note 1: If you try to set a value outside of the range, 2.4mA or 24mA (in the case of fixed current output) or 3000pps (in the case of fixed pulse output) will be forcibly set.
- Note 2: The pulse width set in **Section 8.2.20** is used for fixed pulse output. The pulse width must not be greater than 40% of the period of the fixed output set frequency. However, if the setting exceeds 1000pps, the pulse width automatically will be set to 40% of the period of the fixed output set frequency.
- Note 3: If the fixed output is set to ON, the screen automatically changes to the fixed output current value and fixed output pulse value setting screen. However, the fixed output actually starts when the fixed output pulse value setting is completed. (If the fixed output current value or fixed output pulse value is set independently, the fixed output starts when either of the setting is completed.)

8.2.26 Password Setting

The password function is provided to prohibit the settings and adjustment for some of the functions affecting the flow measurement. See the setting menu in 7.4 “**Setting and Calibration Items Selection List.**”

You can check or change the password as described below.

•Checking the password











Switch operation	Display example	Description
	P·OTHERS 1 PASSWORD 2 LCD ADJ 3 SW POSN 4 EXIT 	Select "PASSWORD" from the setting item selection menu.
STEP1	PASSWORD 123 	The currently set password appears.
STEP2 (=END) 	P·OTHERS 1 PASSWORD 2 LCD ADJ 3 SW POSN 4 EXIT 	Pushing  returns you to the setting menu.

* However, if a wrong password is entered when the mode is changed from the measuring mode to the setting mode, *** appears and the password cannot be checked.

Switch operation	Display example	Description
	<p>PASSWORD</p> <p>***</p> <p>ESC</p>	<p>The currently set password is displayed as *** and the password cannot be checked.</p>

• Changing the password

The following is an example to change the password from 123 to 453.

Switch operation	Display example	Description
STEP1	<p>PASSWORD</p> <p>123</p> <p>ESC ↵</p>	<p>Select "PASSWORD" from the setting item selection menu.</p> <p>The currently set password (123 in this example) appears.</p> <p>Then push .</p>
STEP2	<p>PASSWORD</p> <p>123</p> <p>↵</p> <p>▲ ▶ ↵</p>	<p>The switches at the bottom change. (   are shown.)</p> <p>At the same time, the cursor appears.</p>
STEP3	<p>PASSWORD</p> <p>453</p> <p>▲ ▶</p> <p>▲ ▶ ↵</p>	<p>Push  to move the cursor to the digit you want to change  push to change the number of the digit.</p>
STEP4 (=END)	<p>PASSWORD</p> <p>453</p> <p>SET OK?</p> <p>ESC OK NO</p> <p>↵</p>	<p>When you push , a message appears to confirm whether the setting is OK or not. If OK, push . If you want to redo the setting, push .</p> <p>Pushing  cancels the setting operation and exits the setting screen.</p>

Note 1: If you set 000 for the password, it is considered as if the password is not used. In this case, the password input confirmation screen does not appear when you move from the measurement mode to the setting mode and all parameter setting items and restrictions on the parameter setting items and calibration screen will be released.

Note 2: When you set your password, please be sure not to forget your password. The password including how to check the password should be managed based on the management standard of the system you use.





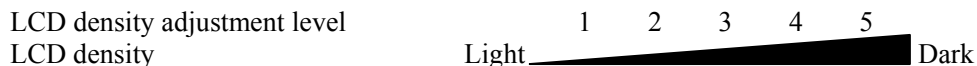

























8.2.27 LCD Adjustment

This section describes how to set the LCD density adjustment value for the converter display. The LCD density can be set in 5 levels.



The LCD density adjustment value is set to "3" when shipped from the factory. The display of the LCD gradually becomes thinner over time. If the display is getting difficult to read, you need to adjust the density level using this parameter.

The following is an example to change the LCD density adjustment level from 3 to 5 DARK.

Switch operation	Display example	Description
	<p>P:OTHERS 1 PASSWORD 2 LCD ADJ 3 SW POSN 4 EXIT</p> <p>  </p>	Select "LCD ADJ" from the setting item selection menu.
STEP1	<p>LCD ADJ</p> <p>3</p> <p></p> <p> </p>	<p>The current setting (3 in this example) appears.</p> <p>Then push  .</p> <p>* Pushing  returns you to the menu screen.</p>
STEP2	<p>LCD ADJ</p> <p>3</p> <p>  </p>	<p>The switches at the bottom change. (   are shown.)</p> <p>At the same time, the cursor appears. (The item indicated by the cursor is highlighted.)</p> <p>Then push   .</p>
STEP3	<p>LCD ADJ</p> <p>5 DARK</p> <p>  </p>	<p>You can continue to change the setting item. Push   to change the selection items.</p> <p> : Selected item is scrolled up.</p> <p> : Selected item is scrolled down.</p> <p>When the desired item is selected, push  to set the item temporarily.</p>
STEP4 (=END)	<p>LCD ADJ</p> <p>5 DARK</p> <p>SET OK?</p> <p>  </p>	<p>When you push  , a message appears to confirm whether the setting is OK or not. If OK, push  . If you want to redo the setting, push  .</p> <p>Pushing  cancels the setting operation and exits the setting screen.</p>

8.2.28 Switch Position Setting

The switch position of the converter display can be set.

The position setting of the switch enables the display remains the same in orientation, regardless of which direction relative to the piping the converter is installed.

You can set the switch position by selecting one from four positions described below.

(1) Switch position: TOP

The infrared switches are located at the top with the front facing you.

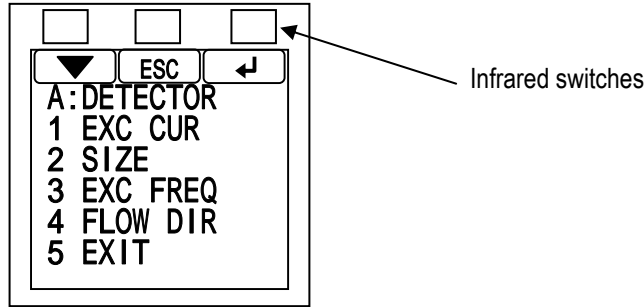

(2) Switch position: BOTTOM (Standard)

The infrared switches are located at the bottom with the front facing you.

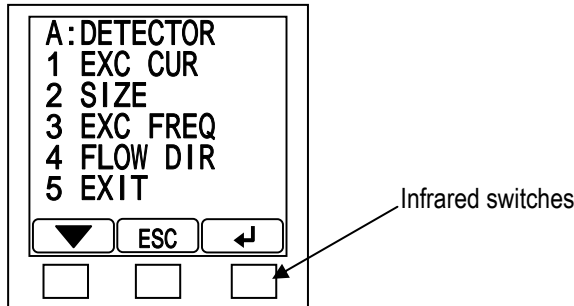

(3) Switch position: LEFT

The infrared switches are located at left with the front facing you.

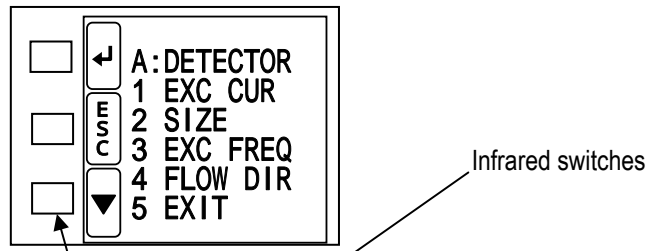





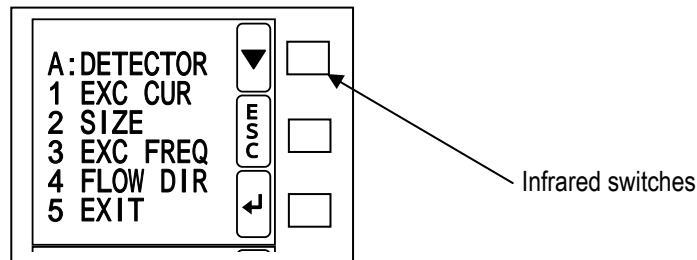





























(4) Switch position : RIGHT

The infrared switches are located at right with the front facing you.



The following is an example to change the switch position setting from BOTTOM to TOP.

Switch operation	Display example	Description
	<p>P:OTHERS 1 PASSWORD 2 LCD ADJ 3 SW POSN 4 EXIT</p> <p>  </p>	Select "SW POSN" from the setting item selection menu.
STEP1 	<p>SW POSN BOTTOM</p> <p> </p>	The current setting (BOTTOM in this example) appears. Then push  . * Pushing  returns you to the menu screen.
STEP2 	<p>SW POSN BOTTOM</p> <p>  </p>	The switches at the bottom change. (   are shown.) At the same time, the cursor appears. (The item indicated by the cursor is highlighted.) Then push   .
STEP3  	<p>SW POSN TOP</p> <p>  </p>	You can continue to change the setting item. Push   to change the selection items.  : Selected item is scrolled up.  : Selected item is scrolled down. When the desired item is selected, push  to set the item temporarily.
STEP4 (=END) 	<p>SW POSN TOP</p> <p>SET OK?</p> <p>  </p>	When you push  , a message appears to confirm whether the setting is OK or not. If OK, push  . If you want to redo the setting, push  . Pushing  cancels the setting operation and exits the setting screen.

8.2.29 Communication Setting

This setting is needed when optional PROFIBUS communication board is installed. For details, refer to the instruction manual of PROFIBUS communication board.

* If communication board is not used, this address setting is not needed.

8.3 Parameter initial settings list

Unless otherwise specified, the default values for each parameter shown below are set when shipped from the factory:

Parameter names	Default value
Excitation frequency	(*1)
Flow direction	NORMAL
Display 1	gal/min
Display 2	COUNT B
Display digit setting (for Display 1 and Display 2)	1/1000
Custom coefficient	1.0
Custom unit	"CUSTOM"(Head of character string is blank)
Range type	Single
Range 1	300 gal/min
Ranges 2 to 4	0 gal/min
Hysteresis	3.0 %
Damping constant	5.0 s
Rate-of-change limit	0.0 %
Control limit time	0.0 s
Low cutoff	1.0 %
Display low cutoff	LINEAR
Manual zero	0.0 %
4-20mADC alarm output	4mA
Output low limit setting	4mA
Digital output 1	NO USE
Digital output 2	NO USE
DO1/DO2 active status	NormOPEN
Digital input	NO USE
DI detective level	H LEVEL
Count rate	100 gal
Pulse width setting mode	AUTO
Pulse width	5 ms
Preset count	00000000
Preset function	HOLD
High alarm On/Off	OFF
High alarm value	0.0 %
Low alarm On/Off	OFF
Low alarm value	0.0 %
High-High alarm On/Off	OFF
High-High alarm value	0.0 %
Low-Low alarm On/Off	OFF
Low-Low alarm value	0.0 %
Empty pipe alarm	NORMAL
Self-diagnosis On/Off	ON
Converter alarm	CONV ONLY
Fixed value output	OFF
Fixed value current	4mA
Fixed value pulse	0 pps
Password	000
LCD density adjustment	3
Switch position setting	BOTTOM

*1: See the setting values for each meter size in the table below.

Setting values for each meter size

Meter Size (mm/inch)	Ex. Freq (Hz)	Range 1 (SI unit)		Range 1 (English unit)		Count rate (gal)
		(m ³ /h)	(m/s)	(gal/min)	(ft/s)	
25 / 1	400	6	3.395	75	31.625	1
40 / 1.5	200	15	3.316	175	28.826	1
50 / 2	200	25	3.537	300	31.625	10
80 / 3	200	60	3.316	650	26.766	10
100 / 4	100	100	3.537	1000	26.354	10

9. Mag-Prover-Calibration

9.1 Calibration Items

When you check or calibrate the converter or check the excitation current, you have to change the mode to the calibration mode.

You can check or change the zero and span of the converter and the excitation current value as described below.

However, calibration is already performed when shipped from the factory. Do not perform change calibration unless it is specificity required.

Items	Function items	Display example
9.2.1	0 % flow rate calibration	CAL 0%
9.2.2	50 % flow rate calibration	CAL 50%
9.2.3	100 % flow rate calibration	CAL 100%
9.2.4	Checking the excitation current output	EXC DSPL

9.2 Calibration Using Mag-Prover's Built-In Signal Source

9.2.1 0 % Flow Rate Calibration (Zero Calibration)

Using Mag-Prover's internal calibration circuit, 0% flow rate calibration (hereafter called zero calibration) can be performed.

•Zero point check / calibration

Switch operation	Display example	Description
	R-CAL 1 CAL 0% 2 CAL 50% 3 CAL 100% 4 EXC DSPL 5 EXIT ▼ ESC ↵	Select "CAL 0" from the setting item selection menu.
STEP1 ↵	CAL 0% 0.1 % ESC ↵	When the calibration screen is selected, the internal simulation circuit starts working and 0% value using the internal simulation signal appears. Then push and hold ↵ longer. * Pushing ESC returns you to the setting menu.
STEP2 ↵ Longer	ADJ READY 0.1 % OK NO	The title of the screen changes to "ADJ READY" and the converter is ready for calibration. Pushing NO returns you to the previous screen.
STEP3 OK	NOW 0% ADJUSTING	Push OK to start calibration for 0% flow rate.
STEP4(=END)	CAL 0% 0.0 % ESC ↵	It takes several seconds to perform calibration for 0% flow rate and the simulated value of 0% after calibration appears. Pushing ESC returns you to the setting menu.

Note 1: To perform calibration, push and hold ↵ longer.

Note 2: To cancel the adjustment when ADJ READY is displayed, push NO .
The screen returns to the zero display using the simulation input.

9.2.2 50 % Flow Rate Calibration

Using Mag-Prover's internal calibration circuit, 50% flow rate calibration can be performed. For calibration procedure, see the calibration procedure for 0% flow rate. (For 50% flow rate calibration, select "CAL 50" from the setting menu.)

9.2.3 100 % Flow Rate Calibration (Span Calibration)

Using Mag-Prover's internal calibration circuit, 100% flow rate calibration can be performed. For calibration procedure, see the calibration procedure for 0% flow rate. (For 100% flow rate calibration, select "CAL 100%" from the setting menu.)

9.2.4 Checking the Excitation Current

You can monitor the exciting current value.

- Checking the exciting current value

Switch operation	Display example	Description
	<pre> R:CAL 1 CAL 0% 2 CAL 50% 3 CAL 100% 4 EXC DSPL 5 EXIT </pre> <div style="display: flex; justify-content: space-around; margin-top: 5px;"> ▼ ESC ↵ </div>	Select "EX DSPL" in the setting item selection screen.
<p>STEP1</p> <div style="text-align: center; margin-top: 20px;"> ↵ </div>	<pre> EXC DSPL 0.1998 A </pre> <div style="text-align: center; margin-top: 20px;"> ESC </div>	<p>The excitation current value appears.</p> <p>Pushing ESC returns you to the setting menu.</p>

10. Functional Description

The LF516/LF546 Electromagnetic Flowmeter is equipped with two contact output terminals (digital output terminals (DO1, DO2)) and one external input terminal (digital input (DI), optional), enabling you to use various functions, such as pulse output and alarm output.

The following functions are provided using the digital I/O functions are described below.

Functions	Required DO, DI	Outline description
Totalization	DO:1 DI:0 or 1	Totalizes the flow volume in volumetric unit. The totalized flow volume can be output (pulse output) for each unit of volume. The totalizer and pulse output can be controlled (start, stop and reset) by an external signal.
Multiple ranges	DO:1 or 2 DI:0 or 1	Multiple measuring ranges can be selected in accordance with the flow rate. The measuring ranges can be selected either automatically or by an external signal.
Forward and reverse ranges	DO:1	Forward and reverse flows can be measured. The forward and reverse flow measurements can be used together with multiple ranges function.
High / Low alarm High-High / Low-Low alarm	DO:1 or 2	Outputs an alarm signal when the flow rate signal exceeds or lowers below the preset values.
Preset counter	DO:1	When the totalizer count exceeds its preset value, the converter outputs a contact output signal.
Remote still water zero adjustment	DI:1	Still water zero adjustment can be started by an external signal.
Remote fixed value output	DI:1	Arbitrarily fixed current output and/or fixed pulse output can be used to check a process loop circuit of output. The fixed output mode can also be selected by an external signal.
Converter failure alarm	DO:1	The converter outputs an alarm signal if an error such as memory error or excitation circuit error occurs.
Multi-range high / low alarm (option)	DO:2 DI:1	Working in line with upper/lower range selection by an external signal, high/low alarm and high-high / low-low alarm can be switched for the flow rate signal to output an alarm signal.

10.1 Digital I/O Specifications

The specifications of the digital I/O terminals for the converter for electromagnetic flowmeter: LF546 are as follows:

■ **Digital Output 1(DO1)**

Output type: Transistor open collector
 Number of outputs: 1
 Capacity: 30 V dc, 200 mA maximum

■ **Digital Output 2(DO2)**

Output type: Solidstate relay (non polarity)
 Number of outputs: 1
 Capacity: 150 V dc, 150 mA maximum
 150 V ac(peal-to-peak), 100 mA maximum

■ **Digital Input (DI)**

Input signal: 20 to 30 V dc voltage signal
 • High input level—20 to 30 V dc
 • Low input level—2 V dc maximum
 Input resistance: Approximately 2.7 kΩ
 Number of inputs: One point

- Each I/O terminal **can be used as a specified function terminal** when selected.
- Terminal COM is the signal **COMMON** for the other three terminals (DO1, DO2 and DI).
- Each terminal is **isolated from the internal circuits**.
 (The output terminals are not isolated from each other.)

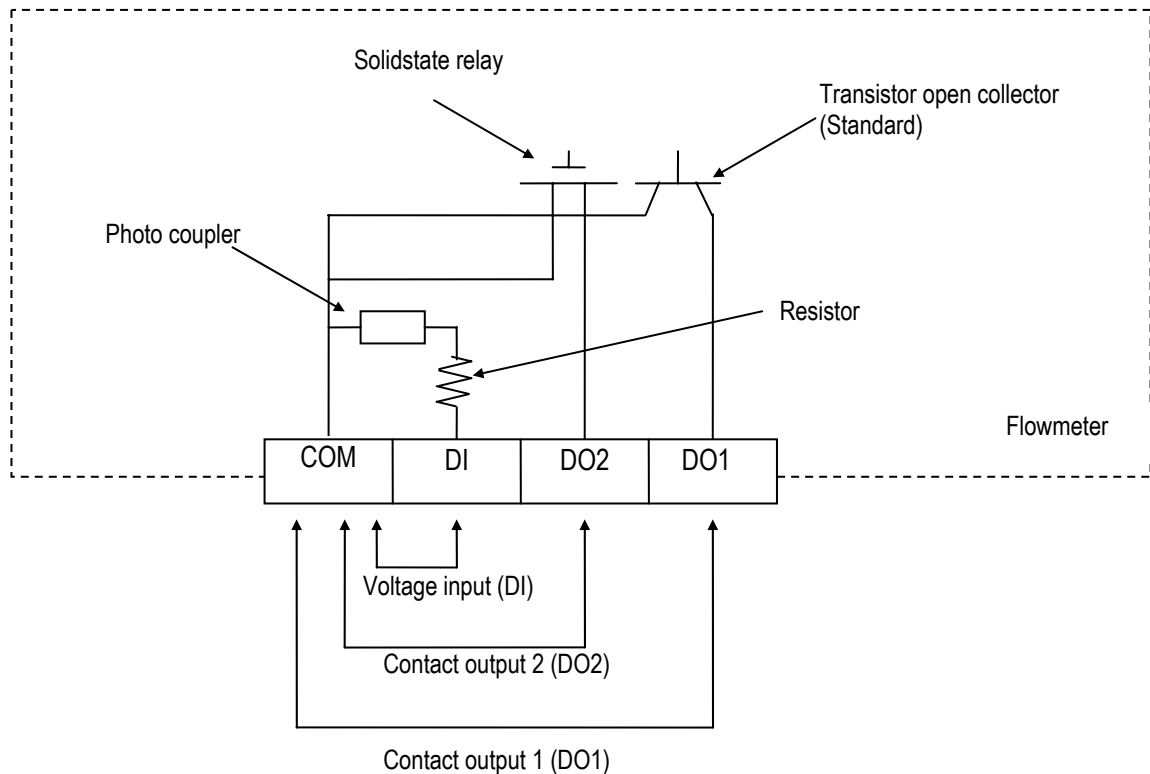

10.2 Totalizer and Pulse Output

To use the totalizer and pulse output for external use, proceed as follows.

Count rate and Pulse Width Setting

Set the flow volume per count (pulse) (count rate) and the pulse width. See **8.2.20, "Count rate, Pulse Width Setting Mode and Pulse Width."**

* The count rate can be set within the range below in reference to the setting range:

3.6 (pulse/s) to 10800000 pulse/h
(1/1000 pulse/s to 3000 pulse/s) (Note 1)

* The pulse width can be set within the range 0.3ms to 500ms.

However, the pulse width must be set to 40% or less of the period of output frequency at full scale. (Note 2)

If the pulse width setting mode is **AUTO**, the pulse width is automatically set. If the pulse width setting mode is **MANUAL**, set it after checking the acceptable signal width of the receiving instruments.

If pulse output is not used, pulse width setting is not needed.

DO setting

Refer to **8.2.18, "Digital Output"** to set the Digital Output 1 (DO1) for Pulse output (PLS OUT).

If the digital output function is not set (**NO USE**) though count rate is set, it will be set to pulse output automatically.

If pulse output is not used, this setting is not needed.

Return to Measurement Mode

Set the operation mode of the system to the measurement mode. Refer to **7.3.1, "Changing the Mode."**

Clear (reset) the totalizer. (Note 3)

Clear the count by pushing and holding **CLR** on the totalizer control screen.

If you have changed the count rate, clear (reset) the totalizer before you start the totalizer.

Start the totalizer. (Note 3)

Start the totalizer by pushing **▶** on the totalizer control screen and check that "▶" is shown on the display indicating that the totalizer is in operation.

Note 1: Example of count rate setting range:

The count rate can be set within the range from the minimum value (36000000 pulse/h) to the maximum value (3.6 pulse/h).

(Example)

In the case of range $108\text{m}^3/\text{h}$ ($0.03\text{m}^3/\text{s}$),

Minimum value (for 10800000 pulse/h):

$$108 (\text{m}^3/\text{h}) / 10800000 (\text{pulses/h}) = 0.00001\text{m}^3 = 0.01 \text{ L (liter)}$$

Maximum value (for 3.6 pulse/h):

$$108 (\text{m}^3/\text{h}) / 3.6 (\text{pulses/h}) = 30\text{m}^3$$

Note 2: Example of pulse width setting range

The pulse width can be set within the range 0.3ms to 500ms in increments of 1ms. However, the pulse width must be set to 40% or less of the period of pulse frequency at full scale because of the setting range and count rate requirements.

If "0" is set, the pulse width automatically will be set to 40% of the period of pulse frequency at full scale. (100ms max.)

(Example 1) Range: $108\text{m}^3/\text{h}$ ($0.03\text{m}^3/\text{s}$)
Count rate: 0.00003m^3

Since the pulse rate is

$$108(\text{m}^3/\text{h}) / 0.00003(\text{m}^3) = 36000000 \text{ pulses/h} = 1000\text{pulses/p},$$

the period of pulse frequency at full scale is 1ms.

Therefore, the pulse width can be set only to

$$1\text{ms} \times 40\% = 0.4\text{ms}$$

(Example 2) Range: $108\text{m}^3/\text{h}$ ($0.03\text{m}^3/\text{s}$)
Count rate: 30m^3

Since the pulse rate is

$$108(\text{m}^3/\text{h}) / 30(\text{m}^3) = 3.6 \text{ pulse/h (0.001 pps)},$$

the period of pulse frequency at full scale is 1000000ms

Therefore, the pulse width = $1000000\text{ms} \times 40\% = 400000\text{ms}$.

However, the maximum pulse width is 500ms,

the pulse width becomes 500ms.

(Example 3) Range: $108\text{m}^3/\text{h}$ ($0.03\text{m}^3/\text{s}$)
Count rate: 0.03m^3
When pulse width is set to 0ms:

Since the pulse rate is

$$108 (\text{m}^3/\text{h}) / 0.03(\text{m}^3) = 3600 \text{ pulse/h (1pps)}$$

the period of pulse frequency at full scale is 1000ms.

Therefore, the pulse width = $1000\text{ms} \times 40\% = 400\text{ms}$.

However, the pulse width that automatically set is 100ms max.

the pulse width becomes 100ms.

Note 3: Model LF546 has a function to start / stop or clear the totalizer. For details of operation, see "Totalizer Operation" below.

Totalizer Operation

- Operation using the operation switches
You can start, stop or clear the totalizer as described below.

Switch operation	Display example	Description
	PUSH SW CNT: CNT CTRL SET: SET MODE [ESC] [CNT] [SET]	Mode change screen
[CNT]	CNT CTRL 12345678 FRD [▶] [ESC] [CLR]	When you push [CNT] in the measurement mode, the screen moves to the totalizer control screen. Totalized flow count (both directions) appears automatically on this screen. In addition, the switches ([▶] [ESC] [CLR] are shown.)
* [] is displayed while the totalizer is in operation and [▶] is displayed when it is stopped. * If an erroneous password is input when password is asked, or if it is a sealed specification, [CLR] is not displayed.		
[▶]	CNT CTRL 12345679 FRD ▶ [] [ESC] [CLR]	When you push [▶], the totalizer starts counting and ▶ appears on the screen. In addition, [▶] changes to [].
[CLR] Longer	CNT CTRL 12345679 FRD ▶ CLR OK? [OK] [NO]	When you push and hold [CLR] longer, a confirmation message appears.
[OK]	CNT CTRL 0 FRD ▶ [] [ESC] [CLR]	Pushing [OK] clears the totalizer and pushing [NO] cancels the clear operation. Pushing [ESC] at the end returns you to the measurement mode.

Note 1: Since the flow volume direction code is B (Bidirectional forward/reverse automatic selection),

- When you select forward/reverse multi-range, forward direction totalized value (count value) is displayed for operation in the forward direction range, and reverse direction totalized value (count value) is displayed for operation in reverse direction range.

Note 2: If you reset the totalizer, flow counts for both directions will be cleared to zero at the same time.

Note 3: Non-volatile memory is used to store the totalizer count. Therefore, the value will be retained in the memory even if power is turned off.

• Operation using the digital input

Remote operations for the totalizer and pulse output can be performed using the digital input. Set the digital input function for this purpose referring to **8.2.19 “Digital Input.”**

Operation with digital input (Default setting: Control signal level is in H level)

Digital input functions	DI input	Totalizer and pulse output operation
Totalizer Start/Stop	L level	Stops the totalizer and pulse output.
	H level	Pulse signal is outputted.
Totalizer Reset/Start	H level	Clears the count and stops the totalizer.
	L level	Pulse signal is outputted.

You can reverse the DI control signal level. See **8.2.19 “Digital Input.”**

- When H level (H LEVEL) is selected:
The operation with the signal level is the same as the default setting above.
- When L level (L LEVEL) is selected:
The operation with the signal level is the same as the one shown below.

Operation with digital input signal (Control signal level: L level)

Digital input functions	DI input	Totalizer and pulse output operation
Totalizer Start/Stop	L level	Pulse signal is outputted.
	H level	Stops the totalizer and pulse output.
Totalizer Reset/Start	H level	Pulse signal is outputted.
	L level	Clears the count and stops the totalizer.

10.3 Multi-range Function

Four types of multiple ranges shown below can be selected by setting the range type:

- (1) Unidirectional flow, automatic selection of multiple ranges
- (2) Bidirectional flows, automatic selection of multiple ranges
- (3) Unidirectional flow, multiple ranges selected by external signal
- (4) Bidirectional flows, multiple ranges selected by external signal

Proceed as follows to use the multi-range function.

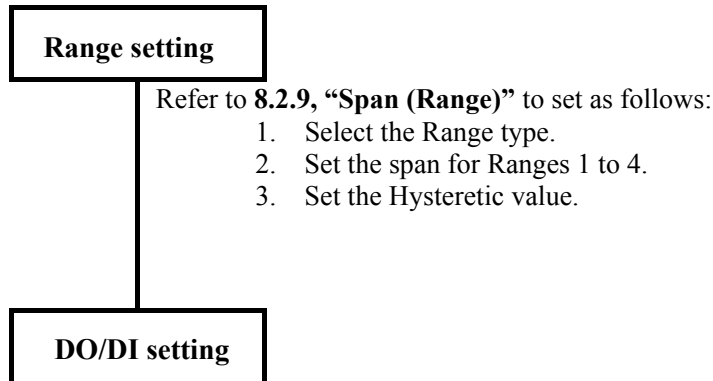

Refer to **8.2.18, “Digital Output”** and **8.2.19, “Digital Input”** to set Digital Output 1 (DO1) and/or Digital Output 2 (DO2) to use them as Range outputs.

To use the multiple ranges selected by external signal, set the Digital Input (DI) as a switch to select the ranges.

■ Output performance of multi-range functions

14. Automatic selection of unidirectional flow multi-range with an internal signal

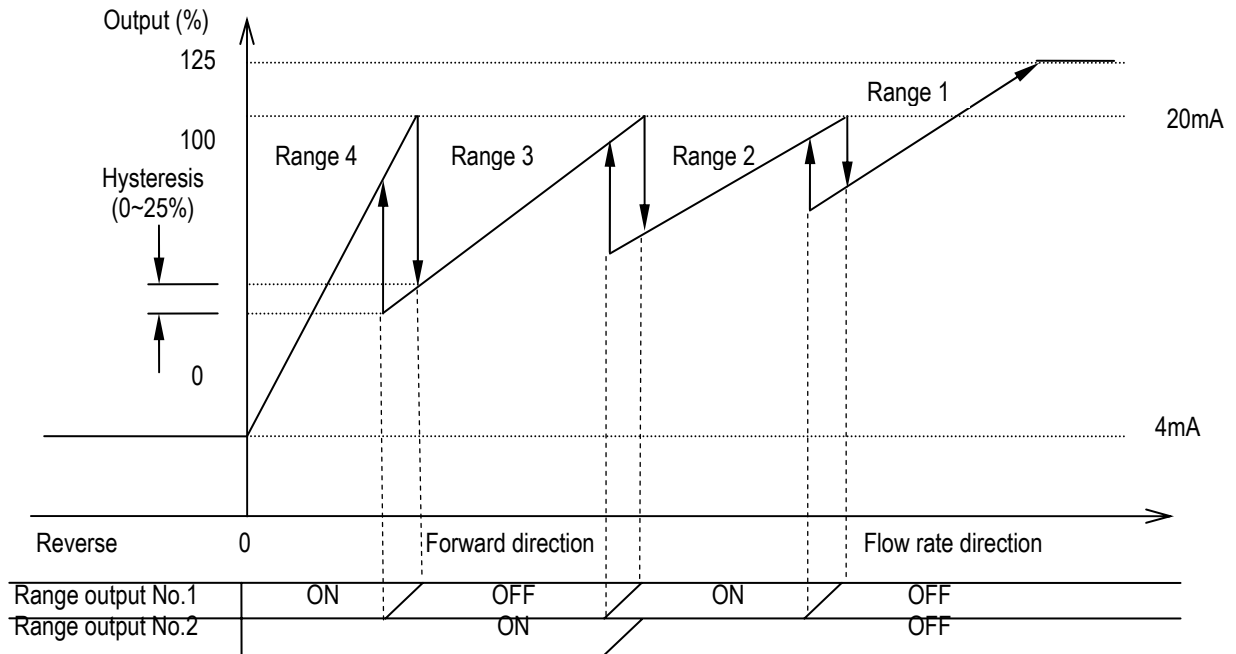

- Current output when fluid flows in the reverse direction is the value set for the output low limit (any one of 2.4/3.2/4.0mA).

(2) Automatic selection of bidirectional flows multi-range with an internal signal

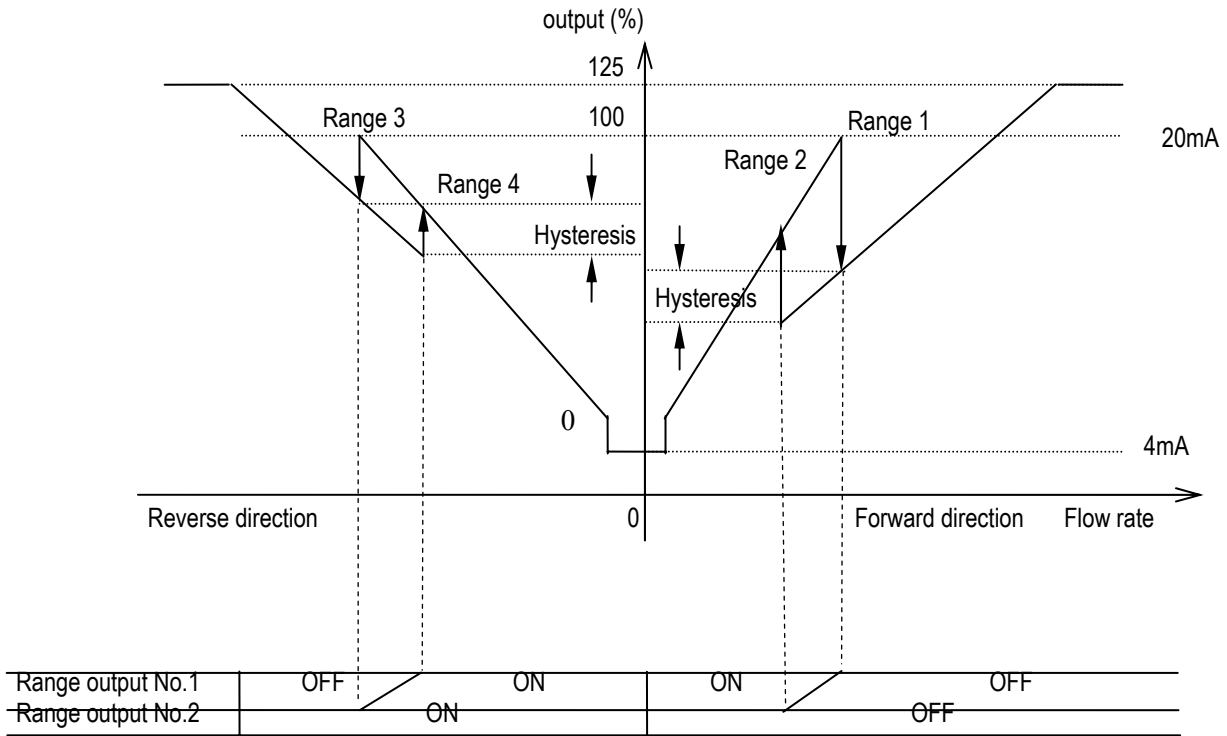

■ **Reverse to Forward direction change**

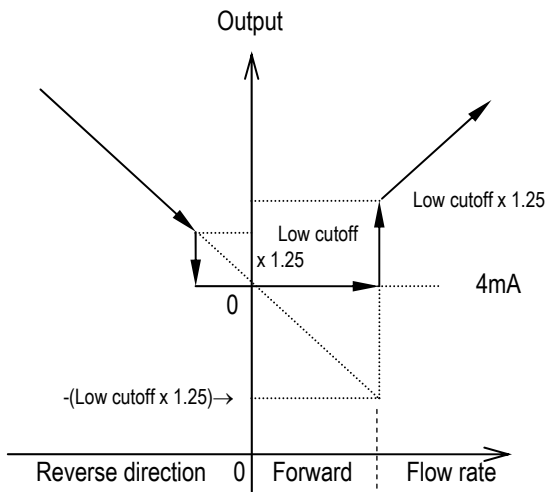

Range output No.2	ON	OFF
-------------------	----	-----

From reverse range to forward range

Forward to Reverse direction change

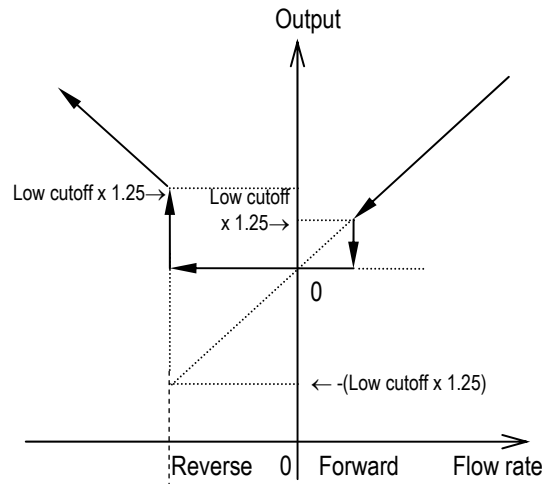

Range output No.2	ON	OFF
-------------------	----	-----

From forward range to reverse range

(3) Remote selection of unidirectional flows multi-range with an external signal

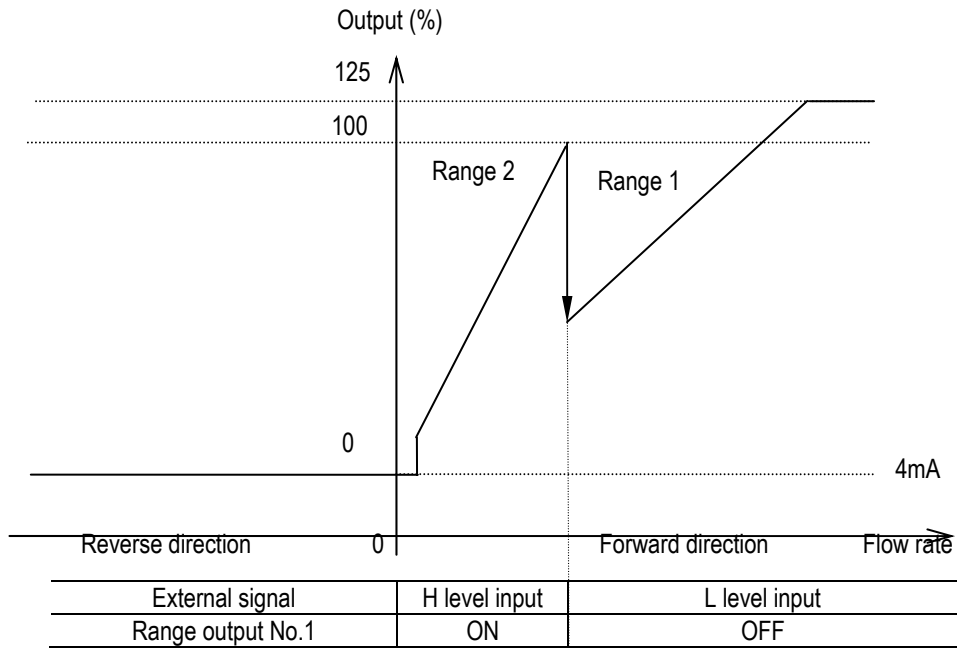

- Current output when fluid flows in reverse direction is the output low limit setting (any one of 2.4 / 3.2 / 4.0mA).

(4) Remote selection of bidirectional flows multi-range with an external signal

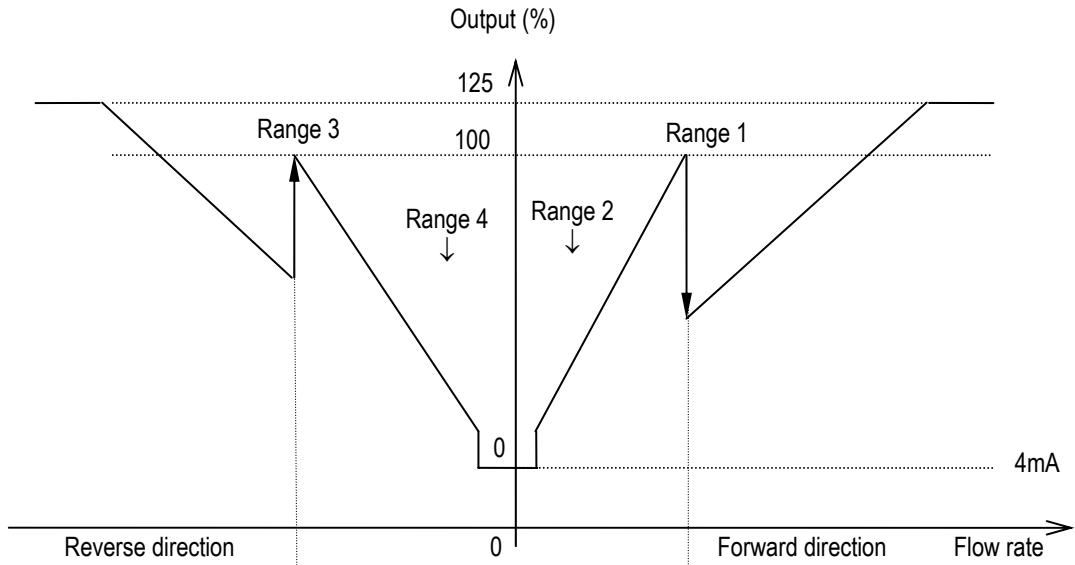

External signal	L level	H level	H level	L level
Range output No.1	OFF	ON	ON	OFF
Range output No.2		ON		OFF

■ **Reverse to Forward direction change**

Forward to Reverse direction change

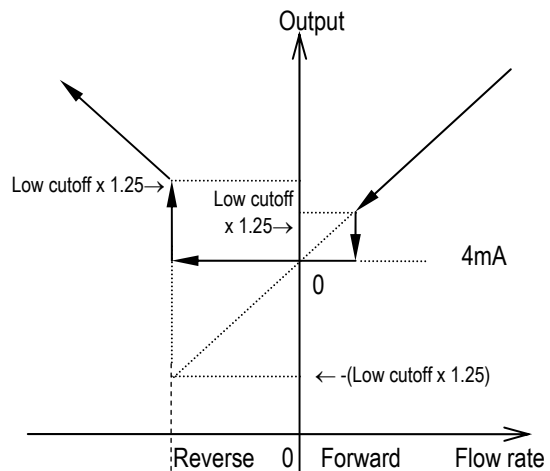
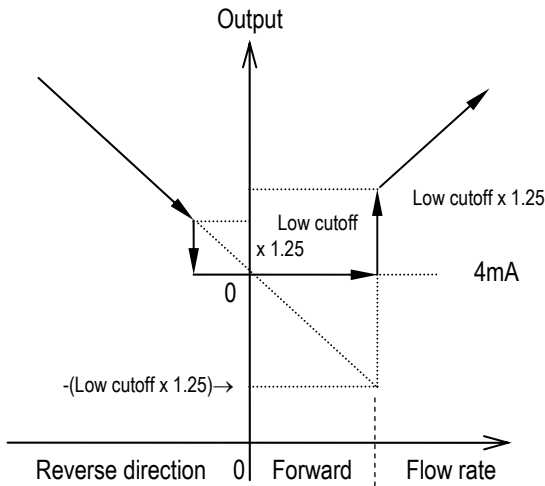

Range output No.2	ON	OFF
-------------------	----	-----

From reverse range to forward range

Range output No.2	ON	OFF
-------------------	----	-----

From forward range to reverse range

10.4 Flow Rate High/Low, High-High/Low-Low Alarm Output

To use the flow rate high/low alarm or high-high/low-low alarm output, follow the procedure below.

High / Low alarm setting

Refer to **8.2.23, "Flow Rate High/Low Alarm and High-High/Low-Low Alarm"** and set the high alarm and/or low alarm to ON and set the limit value for high and/or low alarm.
For alarms not used, set its setting to OFF.

High-High / Low-Low alarm setting

Refer to **8.2.23, "Flow Rate High/Low and High-High/Low-Low Alarm"** and set the high-high alarm and/or low-low alarm to ON and set the limit value for high-high alarm and/or low-low alarm.
For alarms not used, set its setting to OFF.

DO setting

Refer to **8.2.18 "Digital Output"** to set the Digital Output 1 (DO1) and Digital Output 2 functions (DO2) for high alarm output/low output alarm or high-high alarm output/ low-low alarm output.
In addition, set the alarm active status, either Normally Open or Normally Closed.

■ High and Low Limit Alarm Output Performance (Same as for High High/Low Low limit Alarm Output)

• Single range performance

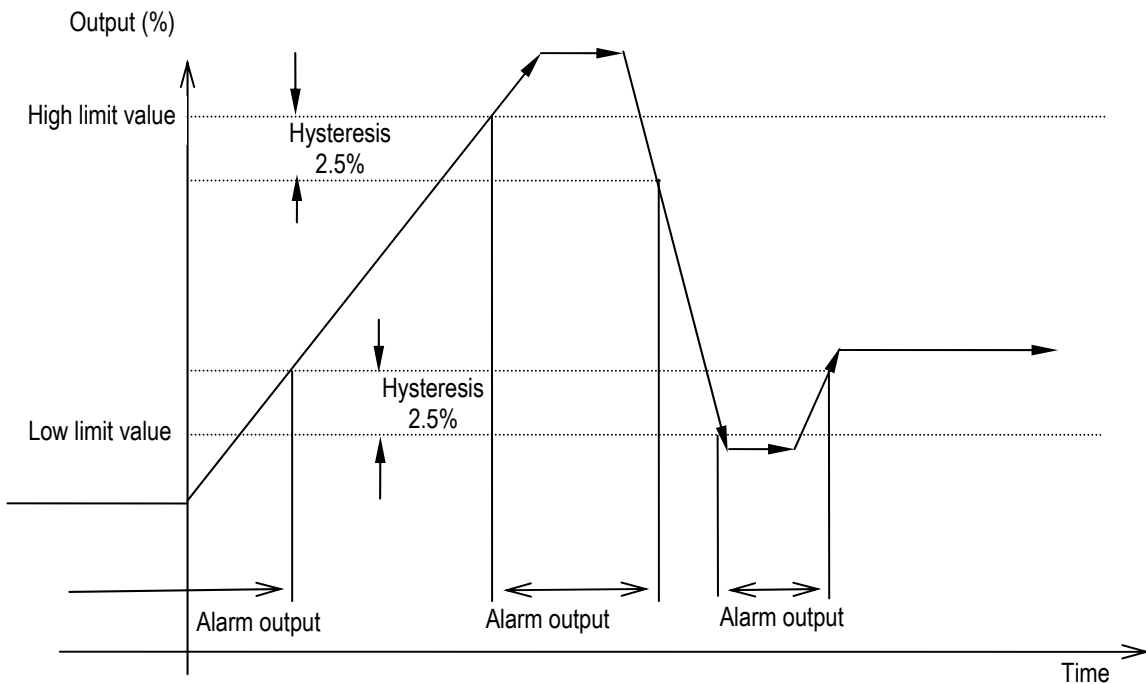

• Multi-range performance

In an example shown below, a low limit alarm is set for the Range 2 and a high limit alarm is set for the Range 1.

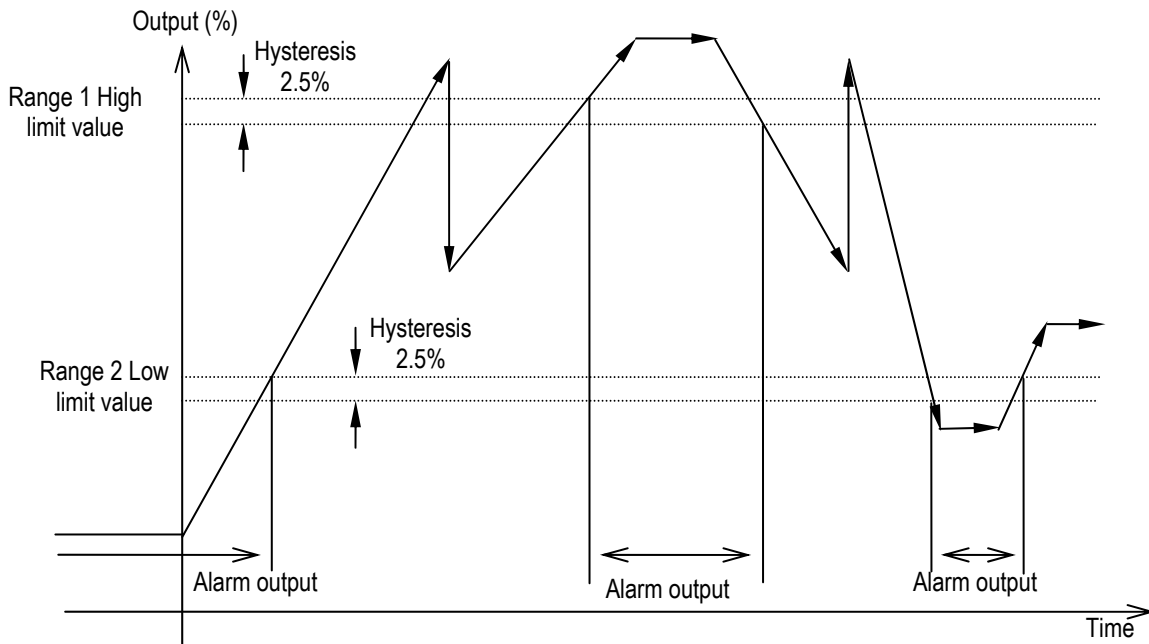

* When an alarm output condition occurs, Digital output 1 and 2 change to the output status set for an alarm output condition. **Alarm output contact is open while the converter is powered off.**

10.5 Preset Count Function

When the totalizer count reaches the preset count value, the converter outputs a contact signal. Proceed as follows to use the preset count function.

Totalizer setting

Refer to **10.2 “Totalizer and Pulse Output”** to set necessary settings for totalizer.

Preset count, Preset count function setting

- Refer to **8.2.21, “Preset Count”** to set the desired preset count.
- Refer to **8.2.22, “Preset Mode”** to select the desired preset output function.

DO/DI setting

- Refer to **8.2.18, “Digital Output”** and **8.2.19, “Digital Input”** to set Digital Output 1 (DO1) or Digital Output 2 (DO2) for use as preset count function output.

In addition, if you want to reset the totalizer by an external signal, set the Digital Input (DI) as totalizer Reset / Start signal. (Set DI FUNC to “CNT RS/ST.”)

Refer to **8.2.19, “Digital Input”** to use the Digital Input (DI) and set the control signal level in accordance with the external input signal.

When the operation switch on the converter is used to reset the totalizer, the digital input function (DI) setting is not needed.

■ **Preset count output performance**

(1) The following is an example for totalizer flow counts output in which the totalizer is reset with an external signal (when preset output status level hold mode is set (contact ON)).

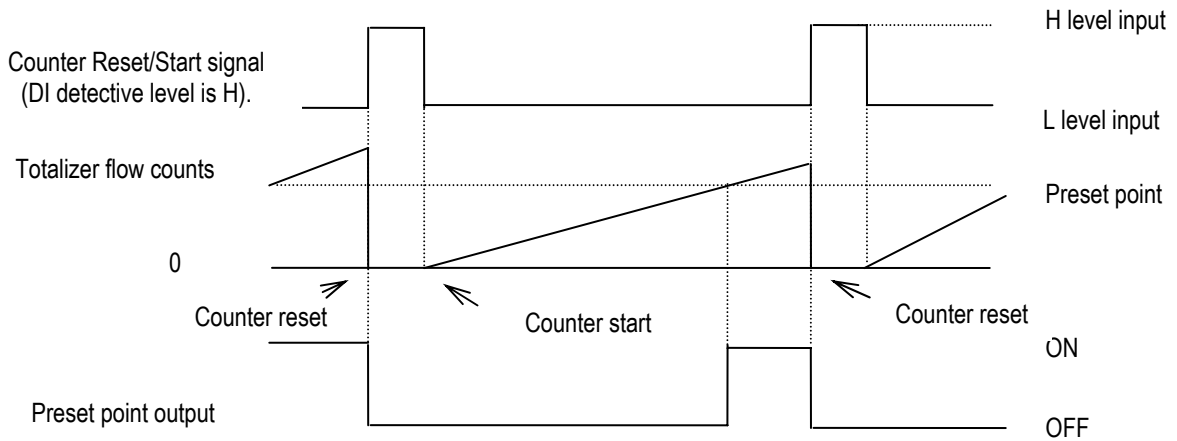

Input/Output signal time chart

*** When the Reset/Start signal is in H level (DI counter control signal level: H), the totalizer is reset to zero and stops counting. When the Reset/Start signal goes to L level, the totalizer starts counting. The preset point output goes ON when the totalizer counts reaches the preset point, and the output goes OFF when the totalizer is reset to zero.**

(2) The following is an example for totalizer flow counts output in which the totalizer is reset with an external signal (when one-shot pulse output mode is set).

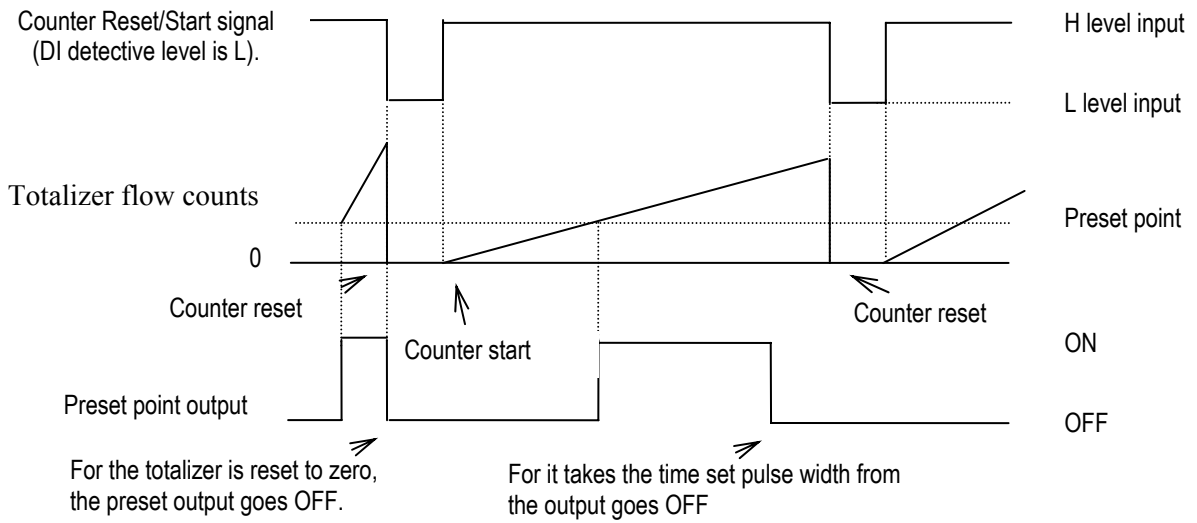

Input/Output signal time chart

*** When the Reset/Start signal is in L level (DI counter control signal level: L), the totalizer is reset to zero and stops counting. When the Reset/Start signal goes to H level, the totalizer starts counting.**

The preset point output goes ON when the totalizer counts reaches the preset point. The output goes OFF when the totalizer is reset to zero or when it takes the time set pulse width from the output goes ON.

(3) The following is an example for one-shot pulse output.

Setting preset count: 100

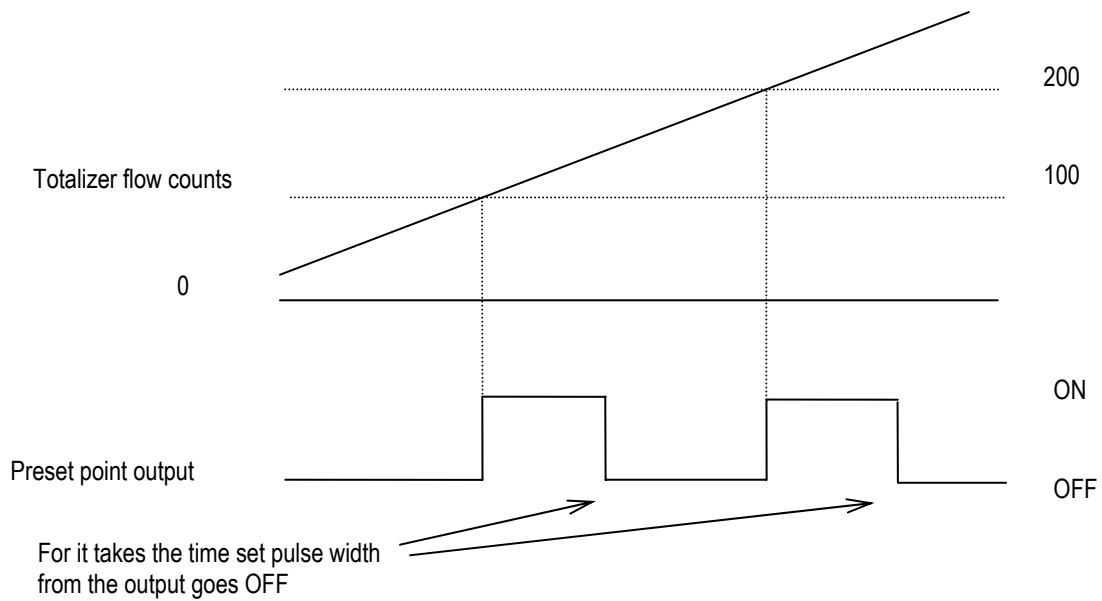

Input/Output signal time chart

* Preset output goes **ON** when the count value exceeds the preset value of 100 and the preset output goes **OFF** when its width reaches the set pulse width.
 When the preset value exceeds 100, the preset value is changed to 200 (adding the preset count of 100 to the current preset value of 100).
 Then, the preset output goes **ON** when the count value exceeds the preset value of 200, and the preset output goes **OFF** when its width reaches the set pulse width.
 When the preset value exceeds 200, the preset value is changed to 300 (adding the preset count of 100 to the current preset value of 200).

Note: When the one-shot pulse output function is selected, if its pulse width is large compared with the update period of the preset value. The output stays ON. To make sure to output as one-shot pulse, set the preset value reach interval to be 2 signals or more of the pulse width setting value.

Preset Pulse Width	The Interval of that Totalizer reaches the Preset Point	Example) Count rate:0.01 l Flow verosity:10 l/s Totalizer count up rate:1ms/COUNT
50ms	More than 100ms	Preset Count: more than 100
500ms	More than 1000ms	Preset Count: more than 1000

10.6 Remote Zero Adjustment

On-stream zero adjustment in a zero flow rate condition can be started with an external signal. To do this, set DI as a zero adjustment start signal. See 8.2.19, “Digital I/O”

[Signal Input Timing]

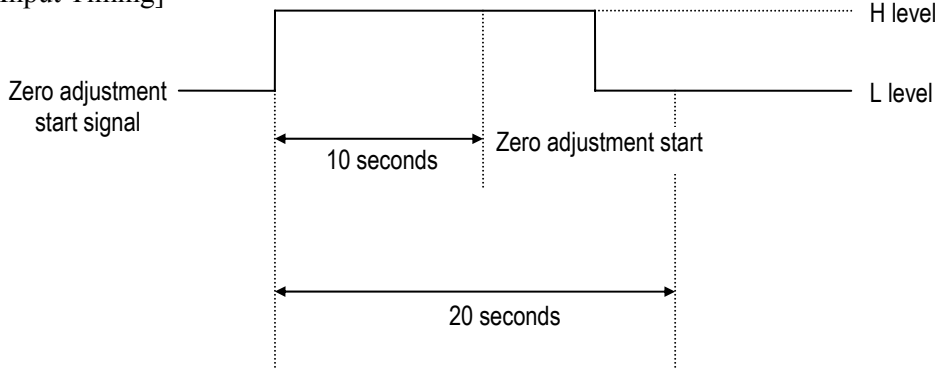

* The start signal must be set to H level first, then it must go to L level after the passage of more than 10 seconds but not more than 20 seconds, as shown above. If the signal does not go to L level within this specified period, it will be ignored.

10.7 Remote Selection of Fixed Value Output

A user-specified 4-20 mA output and pulse output can be selected with a DI signal.

Proceed as follows to use this function:

Fixed-value setting

- Set the fixed-value for current output and for pulse output. See 8.2.25, “Fixed-Value Output.” Set the fixed-value output enable/disable status to “OFF.”
If the pulse output is not used, fixed-value setting for pulse output is not needed.

DI function setting

- Set DI to use as a fixed-value output control signal. See 8.2.19, “Digital Input.”

Control signal input conditions:

Control signal input level	4 –20 mA and pulse output
L level	Outputs the measured value.
H level	Outputs the fixed-value.

10.8 Converter Failure Alarm

If any one of the following errors occurs in a self-diagnosis sequence, the converter issues an alarm using a contact output.

●Self-diagnosis errors

Self-diagnosis errors (LCD display)	Error items
ROM ERROR	ROM error
RAM ERROR	RAM error
PARAMETER FAILURE	System parameter error
EXC CUR OPEN	Excitation circuit not connected or open
EXC CUR ERROR	Excitation current error, excitation circuit error
ADC ERROR	ADC error
INVALID TOTAL	Invalid totalizer counts

Note: A self-diagnosis error message appears on the Display 2 measured value screen. If this happens, the measurement item specified on the Display 2 screen cannot be displayed unless the error is removed. However, if OFF is set to **8.2.24**, “**Self Diagnosis Function Setting**,” an error does not appear even if an error occurs.

If you want to use a converter alarm output, set Digital Output 1 (DO1) or Digital Output 2 (DO2) for converter alarm output (CONV ALM) following **8.2.18**, “**Digital Output**.” In addition, set the alarm output condition to normally open (NormOPEN) or normally closed (NormCLOSE) status.

●Contact output condition

NormOpen; In case an error occurs, contact is closed.
 NormClose; In case an error occurs, contact is open.

Note: Alarm output contact is open when converter power is off.

10.9 Multiple range high/low limit alarm function (option)

The procedure to use multiple range high/low limit alarm is shown below.

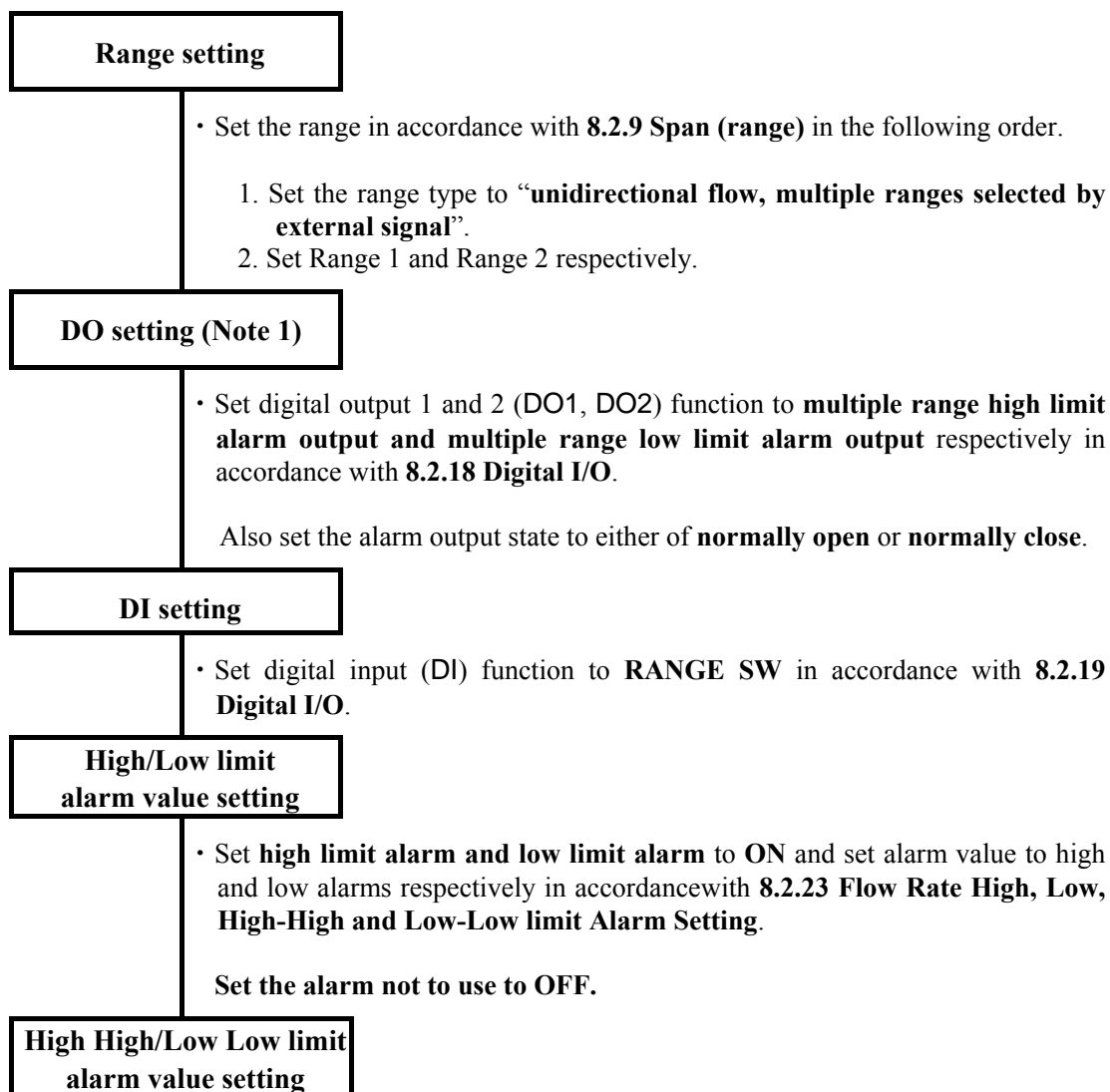

- Set **high-high alarm and low-low alarm** to **ON** and set alarm value to them respectively in accordance with **8.2.23 Flow Rate High, Low, High-High and Low-Low limit Alarm Setting**.

Set the alarm not to use to **OFF**.

(Note 1) When setting **DO** using **HHT AF900 (Ver2.40 or older)**, set alarm outputs as below:

Multiple range high limit alarm output	SPECIAL-B,
Multiple range low limit alarm output	SPECIAL-A

Multiple range high/low limit alarm output

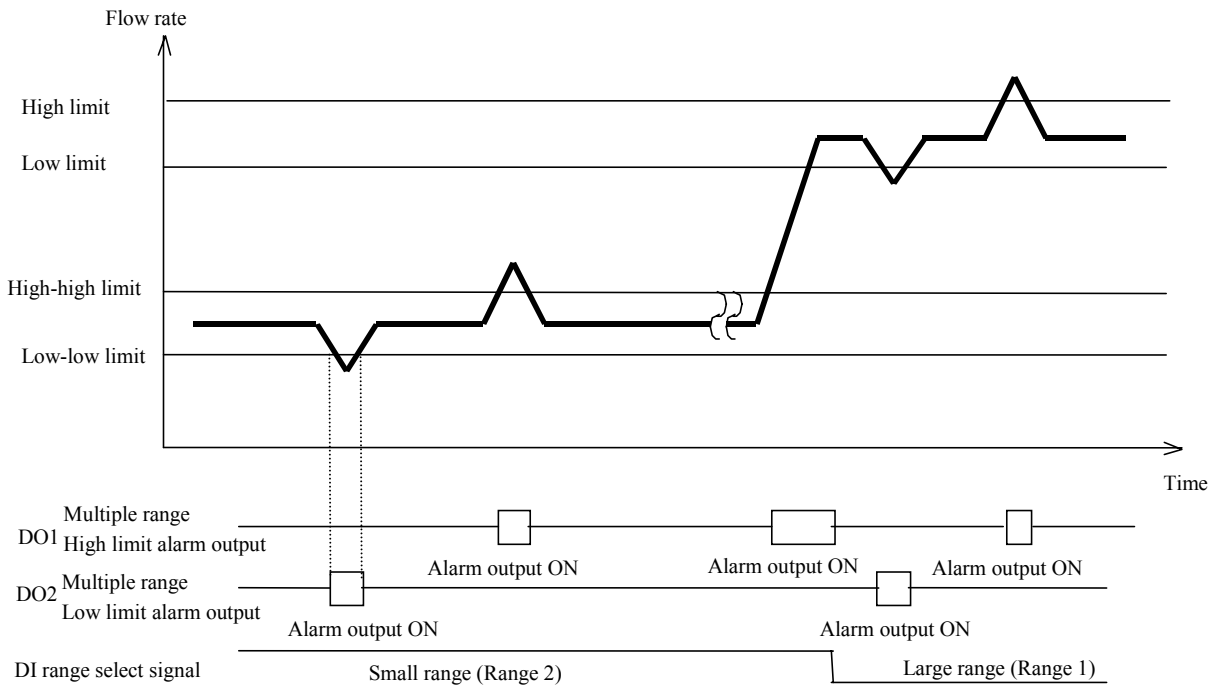

Note 1: Range changes to Small range when range select signal is H level, and to Large range in L level.

Note 2: High-high/low-low limit alarm is activated when Small range is selected. High/low limit alarm is not output to display.

High/low limit alarm is activated when Large range is selected. High-high/low-low limit alarm is not output to display.

Note 3: Alarm output state is the same state to which digital output 1 or 2 is set. When converter power is OFF, contact output is OPEN.

Note 4: Each alarm set value % is the percent set to the first range.

Note 5: Hysteresis of each alarm is 2.5 % for the first range.

Example

When Large range and Small range are set as below:

Large range (Range 1): 1000 m³/h

Small range (Range 2): 500 m³/h

And you want to set alarm values as below:

Large range alarm set values

High limit value: 800 m³/h

Low limit value: 600 m³/h

Small range alarm set values

High-high limit value: 400 m³/h

Low-low limit value: 300 m³/h

Set the alarm set values as below:

High limit value: 80 % (800 m³/h ÷ 1000 m³/h = 0.8)

Low limit value: 60 % (600 m³/h ÷ 1000 m³/h = 0.6)

High-high limit value: 40 % (400 m³/h ÷ 1000 m³/h = 0.4) See Note4.

Low-low limit value: 30 % (300 m³/h ÷ 1000 m³/h = 0.3) See Note4

10.10 Custom unit function

(1) Display of flow rate

The procedure to display flow rate by the custom unit is shown below.

Example : In the case of custom unit [dL(deciliter)/min].

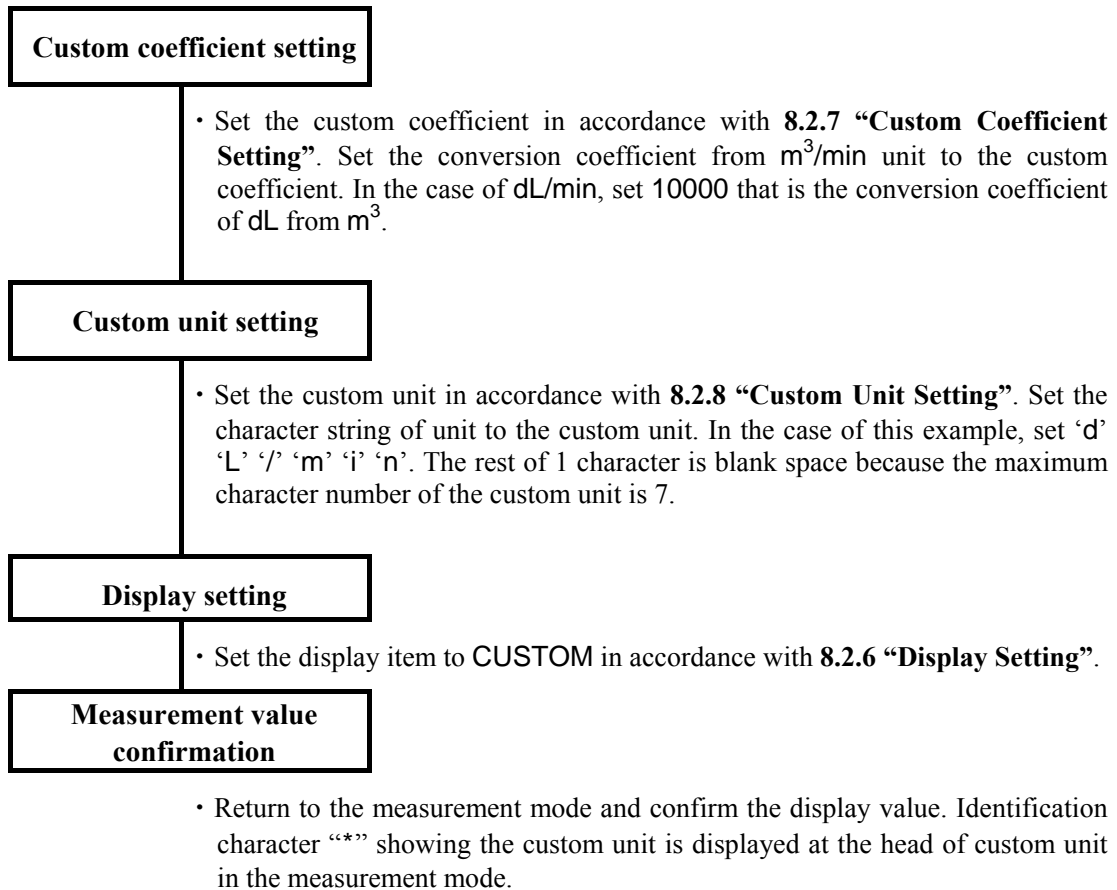

(2) Span setting

Setting of **8.2.7 “Custom Coefficient Setting”** and **8.2.8 “Custom Unit Setting”** is applied to the custom coefficient and unit same as **(1)Display of flow rate**.

Example : In the case of custom unit [dL(deciliter)/min].

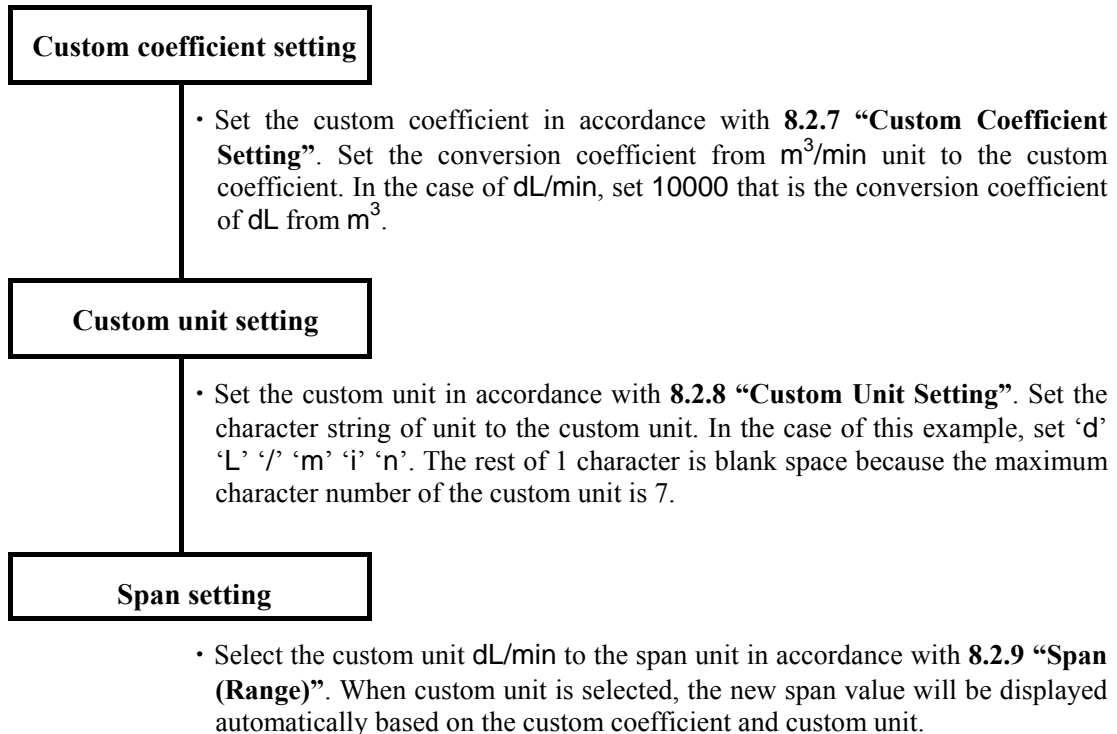

Note1 : Even if the custom unit is selected, the current output does not change unless the span value is changed.

Display example	Description
<p>R1</p> <p>2.00000</p> <p>m³/min</p> <p>▲ ▶ ◀</p>	<p>In the case of span value = 2.00000 m³/min</p>
<p>R1</p> <p>20000.0</p> <p>*dL/min</p> <p>▲ ▶ ◀</p>	<p>When custom unit dL/min is selected, the span value is displayed 20000 automatically based on the custom coefficient.</p> <p>Identification character “*” showing the custom unit is displayed at the head of custom unit.</p> <p>Even if setting is fixed in this state, the current output does not change.</p>
<p>R1</p> <p>10000.0</p> <p>*dL/min</p> <p>▲ ▶ ◀</p>	<p>When the span value was changed after the custom unit selection, the current output changes.</p> <p>The span value is changed into 10000 from 20000 in display example. The percent value doubles when setting is fixed in this state, and the current output changes.</p>

Note2 : Setting range of the span value depends on the custom coefficient.

If the setting high limit of the span value is 1.18 m³/min,
the setting high limit is 11800 dL/min by the custom unit.

Note3 : In the case of the multiple ranges, the custom unit is applied to Range4 from Range2.

11. Communications Function

LF546 Electromagnetic Flowmeter converter uses the HART*1 protocol to transmit digital signals over the 4-20mA output line. The AF900 hand-held terminal is used to communicate with the LF546 using the HART protocol. Through remote operation, you can check or change the various parameters, calibrate the flowmeter or monitor the measurement value.

For detailed operation and specifications of HHT, refer to the instruction manual of the AF900 hand-held terminal for sensor with communication function.

*1 HART protocol:

HART, Highway Addressable Remote Transducer, is a communication protocol for industrial sensors recommended by HCF (HART Communication Foundation).

By adding an optional PROFIBUS communication board to the converter, the converter can be used as a PROFIBUS-PA slave device to communicate digital data with PROFIBUS master device .

For details of PROFIBUS communication, refer to the instruction manual of PROFIBUS communication for LF546.

11.1 Connections with HHT Terminal

Connect the input cable of HHT terminal across the load resistance connected from the current output terminals (+ and -). Since the cable end is a pair of clips, use a junction terminal or terminal block to connect with the load resistance. To connect the HHT directly to the flowmeter, use the terminals + and -. The HHT input cable has no polarity.

See Figures 11.2 and 11.2 for connection examples.

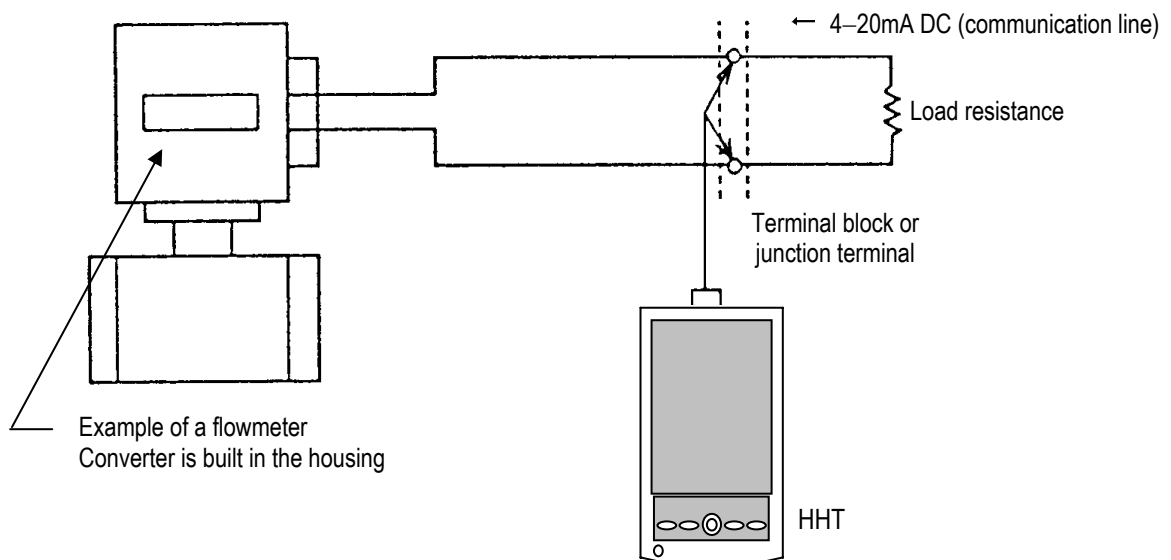

Figure 11.1 Connections to the Current Output Line

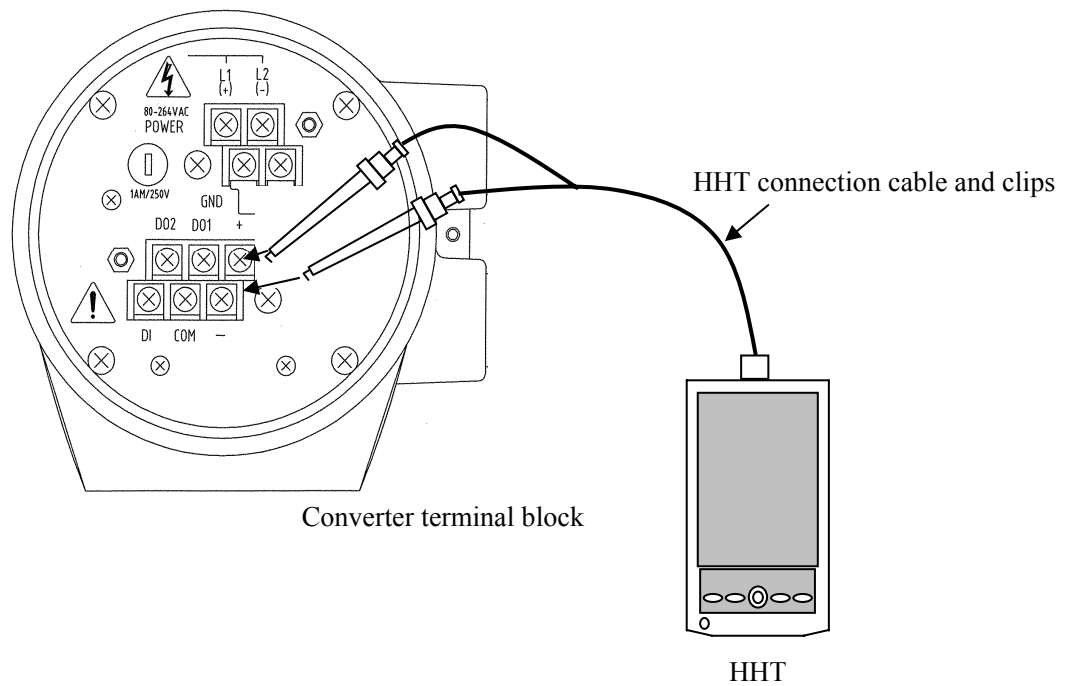

Figure 11.2 Connections to the Converter Unit

11.2 Procedure for Communications with HHT

This section describes the HHT basic operation procedure for communications between the flowmeter and HHT. For details, refer to the HHT instruction manual.

* The following procedure makes a commercially available PDA (OS: Windows Mobile) serve as a HHT.

Procedure	Operation
Prepare a hand-held terminal (1)	Install the AF900 application software to a commercially available PDA (OS: Windows Mobile) main unit. Then insert the serial interface card supplied with AF900 to the card slot of the PDA.
Prepare a hand-held terminal (2)	Connect the HART interface cable and serial interface card supplied with AF900 to each other.
Connect	Connect the alligator clip at the head of the HART interface cable to the current output line of the converter via a load resistor.
Start	Turn on the power supply of the PDA to start the AF900 application software.
Preliminary communication	Execute [sensor communication]. The model of the connected sensor product is automatically identified and the converter menu screen appears.
Check/change data	Press the relevant parameter button and check/change data.
Exit the communication	When all operations are complete, press the [Exist Application] in the top screen to turn off the power supply of the PDA.

11.3 Notes on Communications

- Current output load
 - (1) Load resistance: 240 to 750 Ω (including the communications line resistance)
 - (2) Load capacitance: 0.25 μF maximum (including the communications line capacitance)
 - (3) Load inductance: 4mH maximum (including the communications line inductance)
(The maximum cable length is approx. 2 km when CVV-S 1.25 mm² cable is used under standard installation conditions.)
- Connection method
Use a shielded cable (such as CVV-S) for wiring.
- Interference on 4-20mA current signal
To communicate with the flowmeter, a digital signal with amplitude of 0.4 to 0.8 V (in the case of 500 Ω load resistance) with frequency of 1.2 to 2.2 kHz is superimposed on the 4-20mA current signal. If a high-response receiving instrument is connected to the current output line, the superimposed communications signal may interfere with the instrument. To prevent this interference, as shown in Figure 11.3, it is recommended that you put a low-pass filter with a time constant of about 100 ms into the input circuit of the receiving instrument.

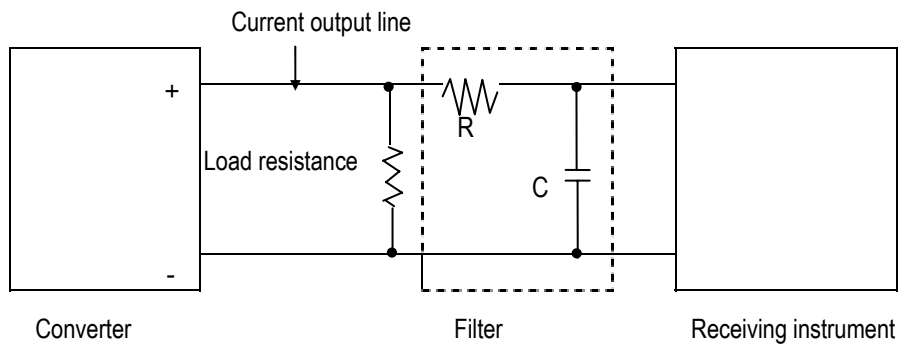

Figure 11.3 Example of Filter Connection

12. Self-Diagnosis and Alarms

12.1 Self-Diagnosis

The converter has a self-diagnosis function to detect errors, such as setting error, I/O error or converter hardware failure, and shows the resulting error or alarm messages on Display 2 of the screen or on the hand-held terminal (HHT) through communications.

The diagnosis messages and their corrective actions are described below.

- Setting error

If you try to set a value or a measuring unit outside of the specified range in the setting mode, one of the following error messages appears to prevent erroneous setting.

LCD display	Description	Corrective action
HIGH OVER SPEC	Setting value exceeds the allowable high limit.	Try to set a value within the specified range.
LOW OVER SPEC	Setting value goes below the allowable low limit.	
HIGH OVER CNT RATE	Count rate exceeds the allowable high limit.	
LOW OVER CNT RATE	Count rate goes below the allowable low limit.	
MULTI RNG ERROR	Span is not appropriate for multi-range configuration.	Try to set the span as specified.

- High/low alarm, high-high/low-low alarm, empty pipe alarm
 One of the following messages appears if the flow rate reading goes out of the set range or an empty alarm is generated.
 If the high or low limit alarm ON/OFF status is set to OFF, its alarm function (high or low) is disabled. See 8.2, “Check/Change of Parameters.”

LCD display	Description	Corrective action
HIGH ALARM	If high alarm is set, the flow rate reading has exceeded the set value.	Take necessary actions for the system.
HIGH HIGH ALARM	If high-high alarm is set, the flow rate reading has exceeded the set value.	
LOW ALARM	If low alarm is set, the flow rate reading is below the set value.	
LOW LOW ALARM	If low-low alarm is set, the flow rate reading is below the set value.	
OVER 125%	The measured value is over 125%.	The setting range for the measurement value is too narrow or the volume of fluid is too large. Check whether the setting is correct or if there is any problem in the process signal.
UNDER -125%	The measure value is below –125%.	

• Converter diagnosis error

The converter checks the internal system when power is turned on and generates an error if abnormality is found.

If multiple errors are found, their messages will be displayed cyclically.

Diagnosis items concerning the excitation circuit are detected using the internal ADC circuit. Thus, if the ADC error of No.6 occurs, No. 4 excitation cable and No. 5 excitation circuit errors cannot be detected correctly. Further, this entire diagnosis and display system is based on the CPU in the flowmeter. Therefore, if the CPU error occurs, normal diagnosis and error display cannot be obtained.

NO.	LCD display	Description	Corrective action
1	ROM ERROR	ROM error	Internal components or printed-circuit board must be repaired or replaced.
2	RAM ERROR	RAM error	
3	PARAMETER FAILURE	System parameter error in the memory	Contact Toshiba's salesperson in charge or distributor in your area.
4	EXC CUR OPEN	Excitation cables are not connected.	Connect the excitation cables correctly.
5	EXC CUR ERROR	An error occurred in the excitation circuit.	Internal components or printed-circuit board must be repaired or replaced.
6	ADC ERROR	ADC error	Contact Toshiba's salesperson in charge or distributor in your area.
7	INVALID TOTAL	Totalizer data in the memory was destroyed due to external noise. (No message appears if data display with volume unit is not used.)	The error message disappears if you clear the totalizer count.

Note 1: No.1 to No.3 diagnosis items are executed only at the time of power-up. The flowmeter does not start measurement if any one of these errors is detected.

Note 2: No.4 to No.6 diagnosis items may not be detected even if the error results in incorrect flowmeter accuracy, due to characteristic differences in components used to detect these errors.

Note 3: CPU error cannot be detected by the diagnosis system. If the CPU stops, the watchdog timer resets the internal circuits and the flowmeter starts again from the initial power-un condition. Depending on the CPU condition, the flowmeter may not indicate and output correct data.

12.2 Output Status for Errors and Alarms







Error indication	Measured value indication	Current output (4-20mA)	Totalization pulse output	Remarks
ROM ERROR (Note 1)	-	(Note 3)	Stopped	After power-up, no measurement starts.
RAM ERROR	-	(Note 3)	Stopped	After power-up, no measurement starts.
PARAMETER FAILURE (Note 2)	Zero	(Note 3)	Stopped	-----
EXC CUR OPEN	Zero	(Note 3)	Stopped	Still water zero adjustment cannot be performed.
EXC CUR ERROR	Zero	(Note 3)	Stopped	Still water zero adjustment cannot be performed.
ADC ERROR	Zero	(Note 3)	Stopped	Still water zero adjustment cannot be performed.
INVALID TOTAL	Measured data	Measured data	Measured data	The error message disappears if you clear (reset) the totalizer count.
HIGH ALARM	Measured data	Measured data	Measured data	-----
LOW ALARM	Measured data	Measured data	Measured data	-----
HIGH HIGH ALARM	Measured data	Measured data	Measured data	-----
LOW LOW ALARM	Measured data	Measured data	Measured data	-----



Note 1: The display and output may not be correct depending on the nature of the ROM error.

Note 2: If a parameter failure relating to the current output occurs, the current output may not become the value as specified by the setting when an alarm occurs.

Note 3: The current output value used in case an alarm occurs will be output. For setting method, see **8.2.16, “4–20mA Alarm Output Setting.”**

13. Maintenance and Troubleshooting

 WARNING	
 DON'T	<p>■ Do not disconnect while circuit is live unless location is known to be nonhazardous.</p> <p>Live part of electric circuit or a high temperature department can cause explosion.</p>
 DON'T	<p>■ Do not modify or disassemble the enclosure.</p> <p>Strength degradation and defects of enclosure can cause explosion.</p>
 DON'T	<p>■ Do not use parts of other products.</p> <p>Protective performance degradation for hazardous location can cause explosion.</p>
 DON'T	<p>■ Do not live circuits While assembly of all components is not over.</p> <p>Protective performance degradation for hazardous location can cause explosion.</p>
 DO	<p>■ Install per the National Electrical Code for the US (NEC, ANSI/NFPA 70) and the Canadian Electrical code for Canada (CEC, CAN/CSA-C22.1) and the drawing 3S8A2699 (Refer to Appendix 2.).</p> <p>Unsuitable conduit connections for hazardous location can cause explosion.</p>

 CAUTION	
<p>■ Do not conduct wiring work when power is applied.</p> <p style="text-align: center;">  DON'T </p> <p>Wiring while power is applied can cause electric shock.</p>	<p>■ Do not touch the LF516/LF546 main body when high temperature fluid is being measured.</p> <p style="text-align: center;">  DON'T </p> <p>The fluid raises the main body temperature and can cause burns.</p>

13.1 Maintenance

■ Calibration

The converter for electromagnetic flowmeter: LF61*F has a built-in internal calibration circuit that can be used to **check the zero and span of the converter for the purpose of instrumentation maintenance, periodic inspection or re-verification of instrument calibration parameters.** See Chapter 9, “Mag-Prover’s built-in Signal Source”

■ Fuse

The fuse can be taken out by unscrewing the cap of the fuse holder. **Check that the fuse is not damaged. The fuse has to be replaced periodically. The recommended replacement period is 3 years.**

Type of fuse used:	Glass tube fuse 1 piece
Rating:	• 0.8A, 250 V for 100 to 240 VAC
Dimensions:	Diameter 5.2 mm × 20 mm

Melting time characteristic:

- Time Lag Fuses for 100 to 240VAC

Note: Use a fuse that complies with the Electrical Appliance and Material Safety Law.

■ Check/Replacement of the display unit

When characters displayed on the LCD display become thin or blots come out, please adjust the setting of LCD's display density. If the display is still not improved, the display unit comes to **the end of its life. Please replace the display unit with a new one.** In order to use the display unit stably for a long time, it is preferable to replace it early. For inspection and replacement, **please contact your nearest Toshiba representative.**

■ Power supply unit (also used for excitation board)

Electronic components **deteriorate faster when the ambient temperature is high. The life of the power supply unit in the converter is 9 to 10 years if the ambient temperature is 40°C, and 5 to 6 years if it is 50° C.** To extend the life of the flowmeter, we recommend you **replace the power supply unit early.**

Contact your nearest Toshiba representative for a flowmeter inspection or unit replacement.

■ Product disposal

The main body or parts of the electromagnetic flowmeter LF516/LF546 must be disposed of, according to the rules and regulations of your local government.

Especially if you dispose of electrolytic capacitors to replace parts, have it done by an agency which is licensed to handle industry waste materials.

■ Operative life

The operative life of this flowmeter is **10 years** from the date of shipment.

The life of the flowmeter differs depending on the environmental conditions and the way it was used. To extend the life of the flowmeter, **inspect the flowmeter periodically and clean or replace components** if necessary.

13.2 Troubleshooting

If a problem occurs while using the flowmeter, you may find the cause of the problem by a simple check. Please follow the flowmeter before you contact a serviceperson.

13.2.1 Flow rate is not indicated.

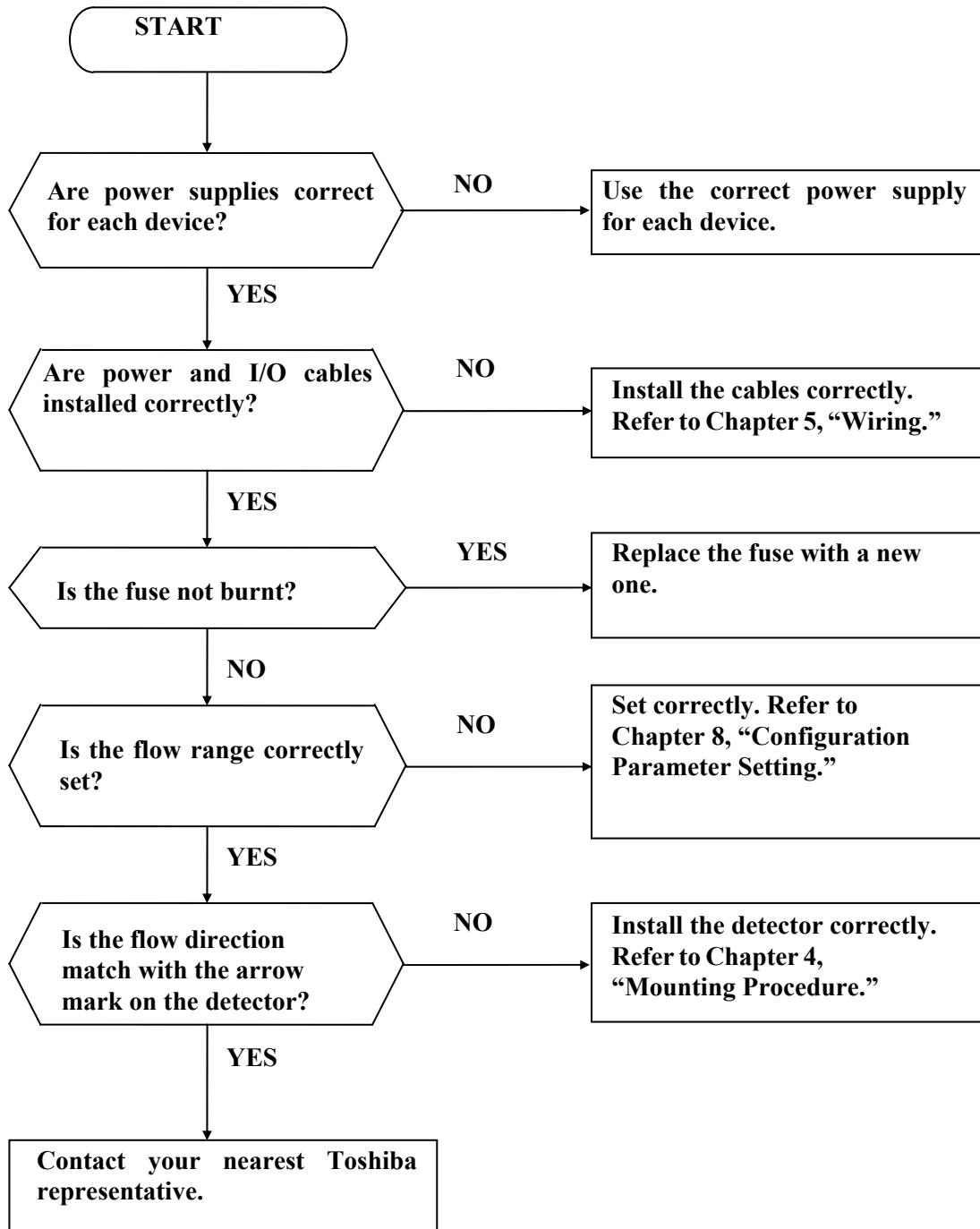

13.2.2 Flow rate indication is not correct.

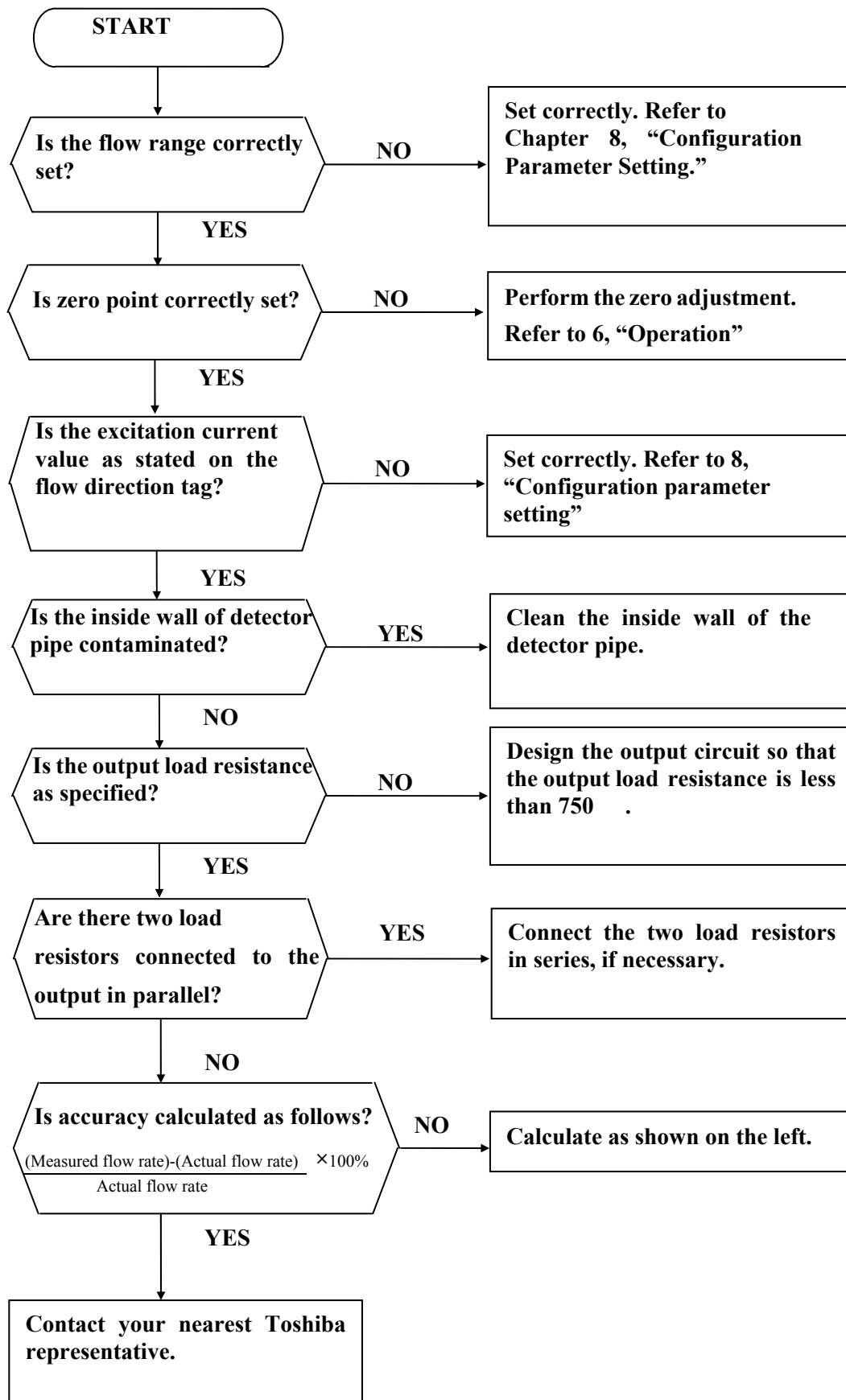

13.2.3 Flow rate indication is not stable.

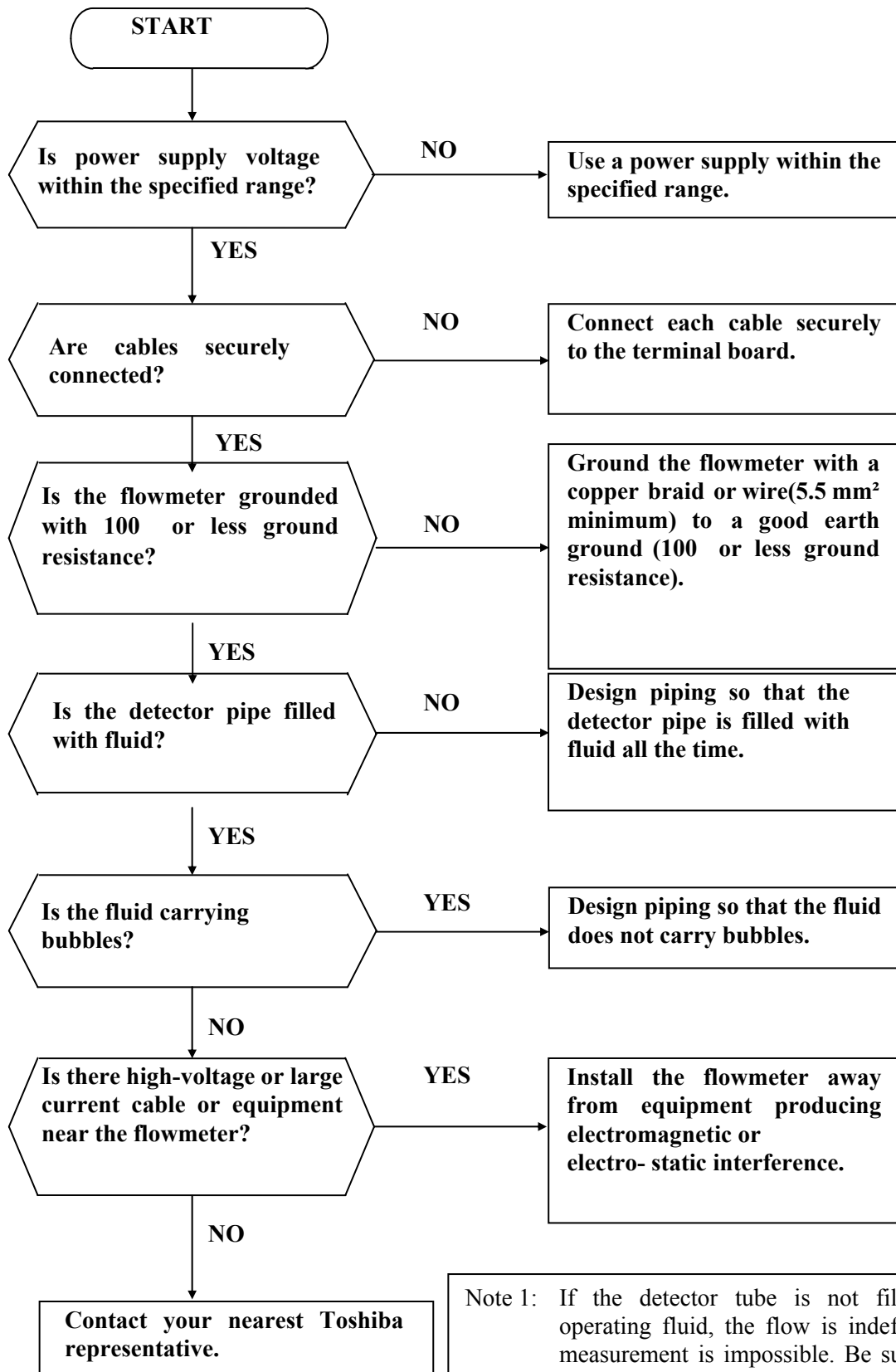

Note 1: If the detector tube is not filled with operating fluid, the flow is indefinite and measurement is impossible. Be sure to fill the detector tube with operating fluid before starting measurement.

13.2.4 When switch operation is unable

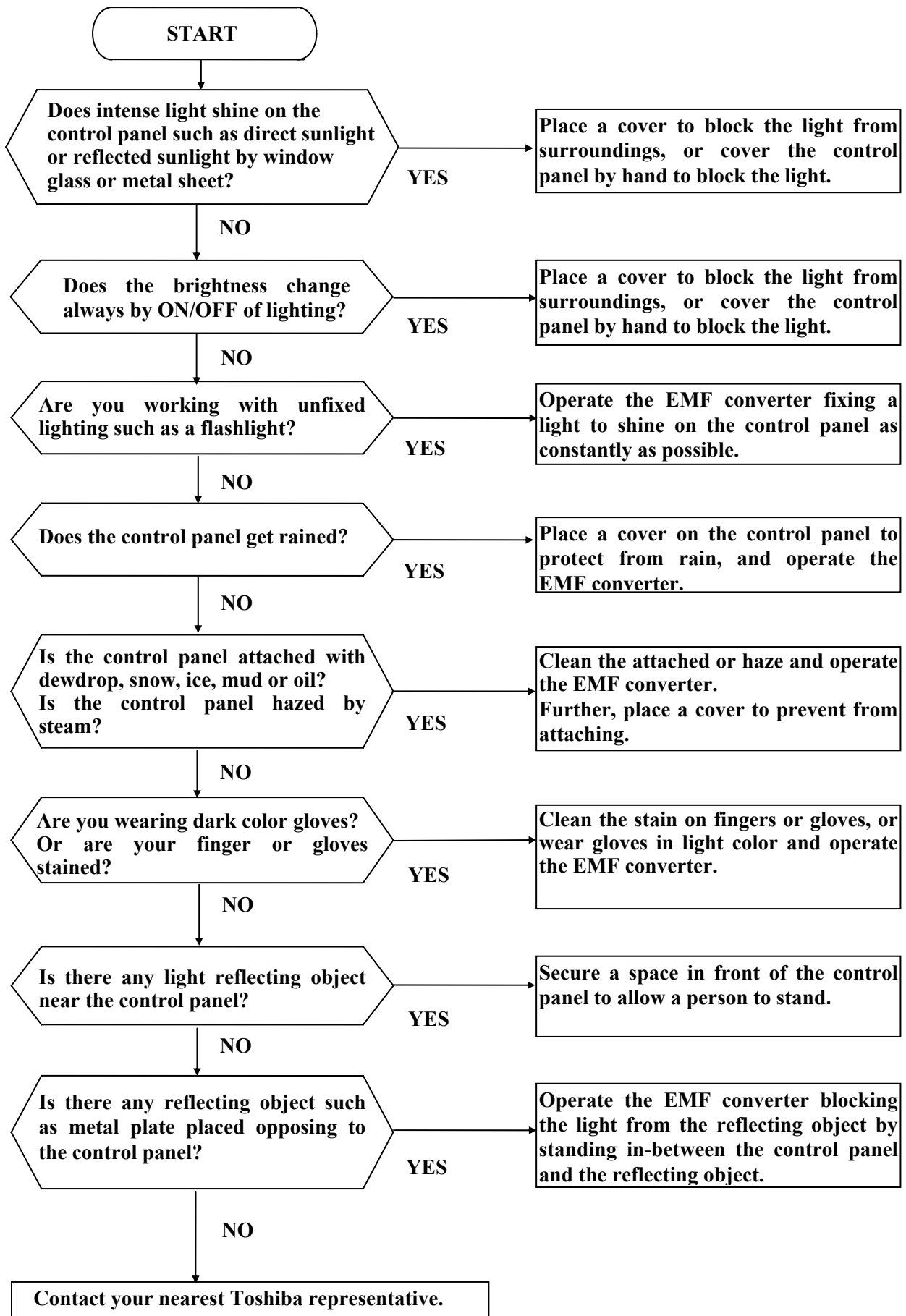

14. Principle of Operation

The operating principle of the electromagnetic flowmeter is based on Faraday's Law of electromagnetic induction and it is designed to measure the volumetric flow rate of fluid. An insulated pipe of diameter D is placed vertically to the direction of a magnetic field with flux density B (see Figure 14.1). When an electrically conductive fluid flows in the pipe, an electrode voltage E is induced between a pair of electrodes placed at right angles to the direction of magnetic field. The electrode voltage E is directly proportional to the average fluid velocity V.

The following expression is applicable to the voltage.

$$E = K \times B \times D \times V \text{ [V] (Eq. 14.1)}$$

Volumetric flow rate Q [m³/s] is:

$$Q = \frac{\pi \times D^2}{4} \times V \text{(Eq. 14.2)}$$

Using the Equation 14.1 and 14.2

$$E = K \times B \times D \times \frac{4}{\pi \times D^2} \times Q$$

$$E = \frac{4 \times K \times B}{\pi \times D} \times Q \text{(Eq. 14.3)}$$

E = induced electrode voltage [V]

K = constant

B = magnetic flux density [T]

D = meter pipe diameter [m]

V = fluid velocity [m/s]

Therefore, volumetric flow rate is directly proportional to the induced voltage.

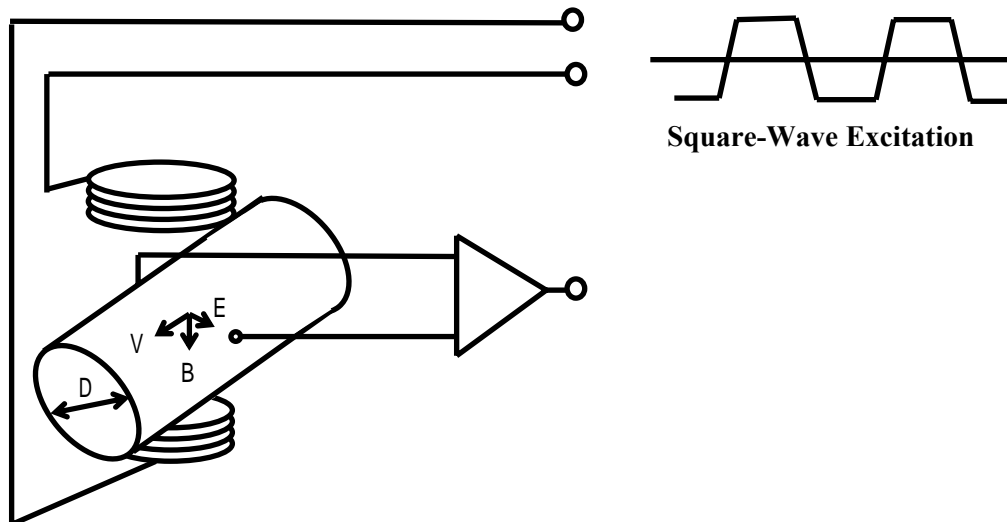

Figure 14.1 Principle of Operation

LF516/LF546 electromagnetic flowmeter uses the square-wave excitation method, which provides long-term stable operation. With square-wave excitation, LF516/LF546 offers reliable measurement without being affected by electrostatic or electromagnetic interference, or electrochemical polarization between the electrodes and the fluid to be measured.

15. Specifications

15.1 Flowmeter Specifications

■ Overall Specifications

Measurement range in terms of flow velocity:

0–0.5 m/s to 0–10 m/s

System accuracy: when fluid conductivity is 0.1 μS/cm or more

Flow rate as a percentage of range	Accuracy	
	Span 0.5 to less than 1m/s	Span 1.0 to 10 m/s
0 to less than 50%	± 0.5%FS	±0.25%FS
50 to 100%		±0.5% of rate

Note: The accuracy above is measured under standard operating conditions at Toshiba's calibration facility.

Fluid conductivity: 0.01 μS/cm minimum

Measurable fluid velocity:

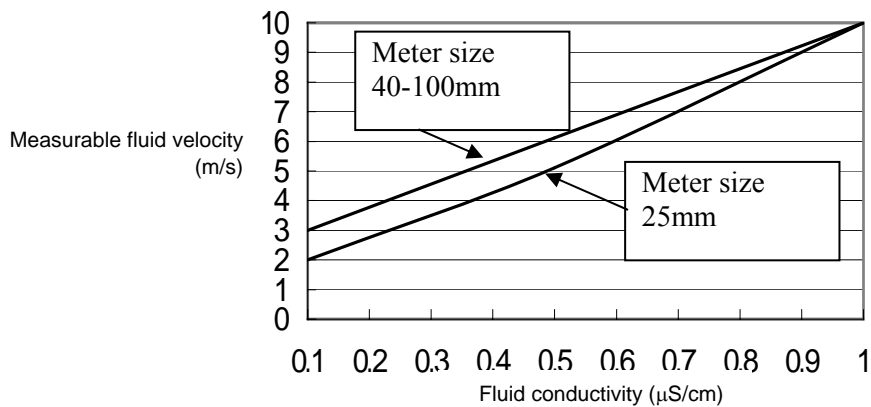

Fluid temperature: –10 to +120 °C

Ambient temperature: –10 to +50 °C

Dimensions and Mass: See Chapter 16, “Outline Dimensions.”

LF516 Detector Specifications

Meter size: 25, 40, 50, 80, 100mm

Fluid pressure: -0.1 ~ 2MPa

Connection flange standard: See Table 15.2 Type Specification Code

Heat shock resistance – for ceramic tube detector

Cooling: ΔT 100 /0.5s

Heating: ΔT 150 /0.5s

Note: Meaning that the ceramic tube detector withstands the shock of sudden cooling (temperature difference 100 or less per 0.5 seconds) at the cooling side.
or sudden heating (temperature difference 150 or less per 0.5 seconds) at the heating side.

Principle materials

Case – Stainless steel

Lining – Ceramic

Grounding rings – 316 stainless steel (standard)

See Type Specification Code for optional materials and other related information.

Structure: IP68 Watertight

Coating: No coating

LF546 Converter Specifications

Input

- Input signal:
- Flow rate proportional signal from the detector
 - Digital input signal
 - Signal type: 20 to 30Vdc voltage signal
 - Input resistance: About 2.7k
 - Number of input points: 1

Digital input function: Select either of the following.

- Range switching input: Large/Small range switching of unidirectional double range, forward/reverse direction double range
- Counter control input: Internal totalization counter start/stop/reset control
- Output hold input: The current output and pulse output are kept to their preset values.
- Zero adjustment input: Start still water zero adjustment.

Output

Current output: 4 to 20mAdc (load resistance 750 or less)

Digital output 1: Output type: Transistor open collector
 Capacity: 30Vdc, Max 200mA
 Number of output points: 1

Digital output 2:

output Output type: Semiconductor contact signal
 (no polarity)
 Capacity: 150Vdc, Max. 150mA
 150Vac (peak value), Max.
 100mA
 Number of output points : 1

Digital output function: Select one of the following:

- Totalization pulse output:

Pulse rate	Max. 3kHz(3000pps) ... DO1
	Max. 100Hz(100pps) ... DO2 (option)
Pulse width	Can be set within a range of 0.3 to 500ms.
	However, must be 40% or less of the full-scale cycle.
	If the full scale 1000pps is exceeded,
	automatically set to 40% of the full-scale cycle.
- Multi-range switching output: In the case of fourfold range or forward/reverse double range, you need to add digital output optionally.
- High and low alarm output
- High-high and low-low alarm output
- Empty alarm output
- Preset counter output
- Converter malfunction alarm output
- Multiple range high and low limit alarm output (option)

Output display: Full-dot matrix 128 x 128-dot LCD (with back light)

Communication signal

Method (protocol): HART or PROFIBUS (option)

Load resistance: 240 to 750 (HART)

Load capacity: 0.25 μ F or less (HART)

Structure

IP67 and NEMA 4X

Housing

Aluminum alloy

Coating

Acrylic resin-baked coating, pearl-gray colored

Cable connection port

1/2-14NPT thread

Cable connections not provided.

Surge arresters

Surge arresters are installed in the power supply and current signal output circuit.

15.2 Model Number Table

Model LF516 Detector Type Specification Code

Model number					Specification code										Contents
1	2	3	4	5	6	7	8	9	10	11	12	13	14		
L	F	5	1												Capacitance Type electromagnetic flowmeter detector
				6											Area of use cFMus, Division 2 approved
					E F G H J										Meter size 25mm 40mm 50mm 80mm 100mm
						L									Mounting structure Detector / Converter combined type (cFMus Approval: Available for FM and CSA)
							C D E F G H J K L								Connection flange standard ANSI 150 ANSI 300 BS PN 10 BS PN 16 DIN PN 10 DIN PN 16 JIS 10K JIS 16K JIS 20K
								A							Standard
									A B						Lining material (Note) Alkali-resistant ceramic tube (alumina)(Standard) Acid-resistant ceramic tube (alumina)
										C D E H					Grounding Ring Material 316 stainless steel (Standard) 316L stainless steel Ti (Titanium) Hastelloy C
											D E F				Settable flow rate range and calibration flow rate range 0.5m/s to 10m/s (Standard range calibration) 0.5m/s to 10m/s (Specified range calibration) 0.5m/s to 10m/s (Standard range calibration with specified setting item)
												A			Standard
													A Z		Coating No coating (Standard) Other

Note: Example of fluids

Alkali fluids: Caustic soda, ammonia etc.

Acid fluids: Hydrochloric acid, sulfuric acid etc.

Model LF546 Detector Type Specification Code

Model number					Specification code									Contents
1	2	3	4	5	6	7	8	9	10	11	12	13	14	
L	F	5	4											Capacitance Type electromagnetic flowmeter converter
				6	A									Area of use cFMus, Division 2 approved Usage General purpose
						A								Mounting Structure Detector / Converter Combined type
							B							Display LCD display provided
								2						Output Current output 4-20 mA + Status I/O (One pulse/status output, one status output and one input)
									1 2					Communication function HART protocol PROFIBUS PA (Note)
										1				Power supply AC100 ~ 240V, 50/60Hz
											A Z			Coating Acryl resin-baked coating pearl-gray colored Other
												A	A	Standard

(Note) When PROFIBUS communication is provided, current output(4-20mA) and HART communication cannot be used.

16. Outline Drawing

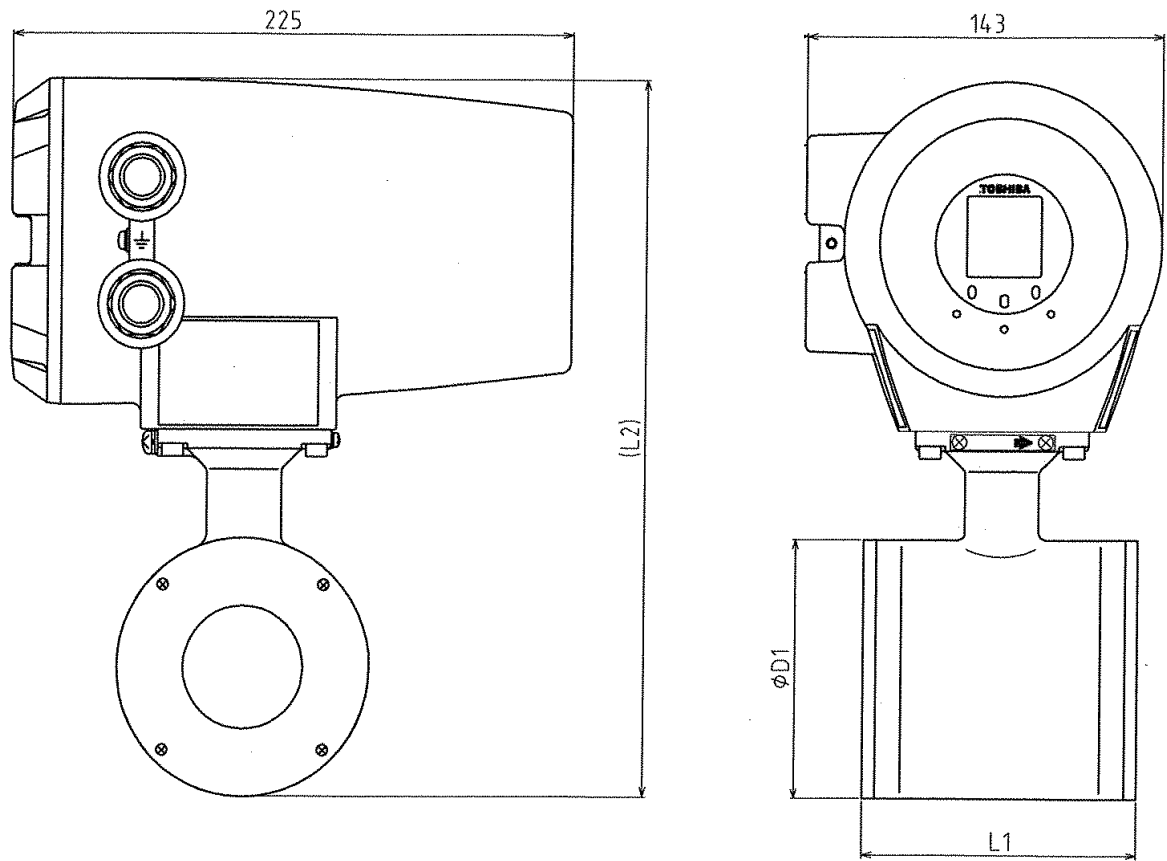

Meter size (mm)	L1(mm)	L2(mm)	D1(mm)	Mass (kg)
25	80	241	66	Approx. 4 kg
40	100	264	85	Approx. 6kg
50	110	280	102	Approx. 7 kg
80	110	306	127	Approx. 8 kg
100	180	338	159	Approx. 10kg

Appendix 1

Factory default standard value table

Parameter names	Default value(SI unit)	Default value(US unit)	Changed value
Excitation frequency	Value(*1)	Value(*1)	
Flow direction	NORMAL	NORMAL	
Display 1	m ³ /h	gal/min	
Display 2	m ³ B	COUNT B	
Display digit setting (for Display 1 and Display 2)	1/1000	1/1000	
Custom coefficient	1.0	1.0	
Custom unit	"CUSTOM" (Head of character string is blank)	"CUSTOM" (Head of character string is blank)	
Range type	SINGLE	SINGLE	
Range 1	Value(*1)	Value(*1)	
Ranges 2 to 4	0.00 m ³ /h	0.00 gal/min	
Hysteresis	3.0 %	3.0 %	
Damping constant	5.0 s	5.0 s	
Rate-of-change limit	0.0 %	0.0 %	
Control limit time	0.0 s	0.0 s	
Low cutoff	1.0 %	1.0 %	
Display low cutoff	LINEAR	LINEAR	
Manual zero	0.0 %	0.0 %	
4-20mADC alarm output	4mA	4mA	
Output low limit setting	4mA	4mA	
Digital output 1	NO USE	NO USE	
Digital output 2	NO USE	NO USE	
DO1/DO2 active status	NormOPEN	NormOPEN	
Digital input	NO USE	NO USE	
DI detective level	H LEVEL	H LEVEL	
Count rate	Value(*1)	Value(*1)	
Pulse width setting mode	AUTO	AUTO	
Pulse width	100 ms	5 ms	
Preset count	00000000	00000000	
Preset function	HOLD	HOLD	
High alarm On/Off	OFF	OFF	
High alarm value	0.0 %	0.0 %	
Low alarm On/Off	OFF	OFF	
Low alarm value	0.0 %	0.0 %	
High-High alarm On/Off	OFF	OFF	
High-High alarm value	0.0 %	0.0 %	
Low-Low alarm On/Off	OFF	OFF	
Low-Low alarm value	0.0 %	0.0 %	
Self-diagnosis On/Off	ON	ON	
Fixed value output	OFF	OFF	
Fixed value current	4mA	4mA	
Fixed value pulse	0 pps	0 pps	
Password	000	000	
LCD density adjustment	3	3	
Switch position setting	BOTTOM	BOTTOM	

*1 : Setting value by meter size please refer to the next list.

When parameter value was appointed in order, parameter value may be different from list.

Setting value in each size

Meter Size (mm/inch)	Ex. Freq (Hz)	Range 1 (SI unit)		Range 1 (English unit)		Count rate (gal)
		(m ³ /h)	(m/s)	(gal/min)	(ft/s)	
25 / 1	400	6	3.395	75	31.625	1
40 / 1.5	200	15	3.316	175	28.826	1
50 / 2	200	25	3.537	300	31.625	10
80 / 3	200	60	3.316	650	26.766	10
100 / 4	100	100	3.537	1000	26.354	10

Appendix 2

System block diagram for LF516/LF546

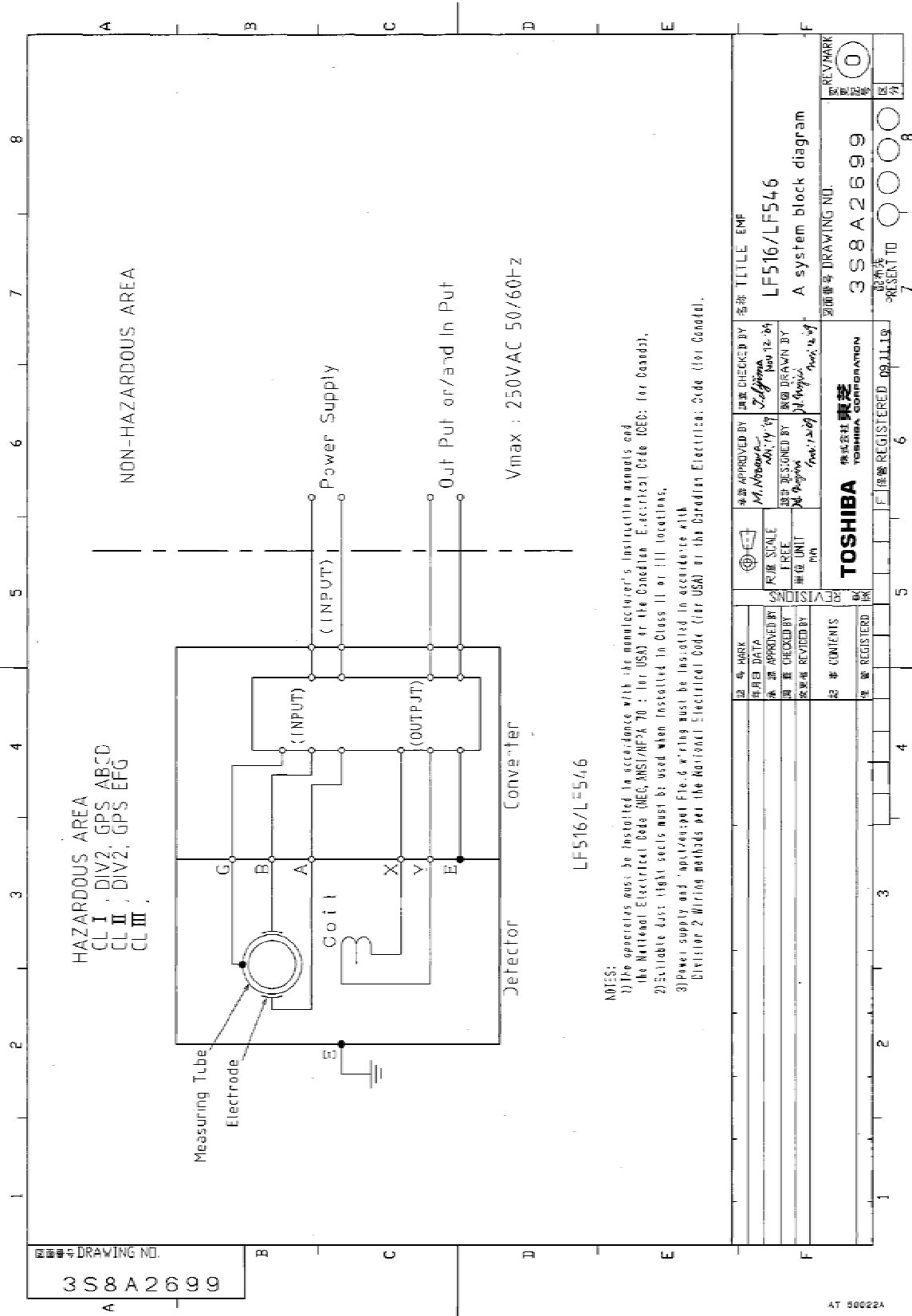

Write down the address and phone number of the distributor from which you purchased this product, the product code, SER.NO. and so on.

Distributor	Address	_____
	Name	_____
	Phone number	() - _____
Product code	<u>LF</u>	_____
SER.NO.		_____

TOSHIBA CORPORATION

Free Manuals Download Website

<http://myh66.com>

<http://usermanuals.us>

<http://www.somanuals.com>

<http://www.4manuals.cc>

<http://www.manual-lib.com>

<http://www.404manual.com>

<http://www.luxmanual.com>

<http://aubethermostatmanual.com>

Golf course search by state

<http://golfingnear.com>

Email search by domain

<http://emailbydomain.com>

Auto manuals search

<http://auto.somanuals.com>

TV manuals search

<http://tv.somanuals.com>