

ELECTROMAGNETIC FLOWMETER

MODEL LF600F and LF602F

INSTRUCTION MANUAL

TOSHIBA CORPORATION**NOTES**

Before using the equipment, please read this manual carefully and understand the contents, and then use the equipment correctly.

- **NEVER attempt to operate the equipment in any ways that are not described in this instruction manual.**
- **After reading this manual, store it with care in a place where it can be referred to whenever needed.**
- **Please be sure that this manual is delivered to the personnel who will use this product.**

NOTICE

We thank you very much for your purchase of our LF600F series electromagnetic flowmeter converter.

Integral type converter LF600F
Separate type converter LF602F

This instruction manual describes the notes on using an electromagnetic flowmeter converter, installation, configuration and maintenance. It is intended for the personnel in charge of installation, operation and maintenance.

To use this product properly and safely, read this manual (6F8A0869) carefully before using this product. After reading this manual, store it in a place where it can be referred to whenever needed.

About a PROFIBUS communication function, please read instruction manual 6F8A0873.

This manual uses the following markers to identify the integral type or separate type when it describes items specific to the integrated type or separate type. Items without this marker are common items to the integral type and separate type.

Integral type converter LF600F:



Separate type converter LF602F:



Toshiba LF60*F electromagnetic flowmeter converters can be used in combination with various types of electromagnetic flowmeter detectors (LF414, LF434 and LF494).

For the notes on usage, piping, installation, configuration and maintenance of the combined detector, check the model number of the combined detector and read the instruction manual of the relevant detector.

About Safety Precautions

Read the **Safety Precautions** described at the front carefully and understand the contents before using this product.

The “**Safely symbols**” used in the “**Safety Precautions**” are shown in a location such as in the margin to the left of the corresponding commentary in the main text.

NOTES

1. **The reproduction of the contents of this Manual in any form, whether wholly or in part, is not permitted without explicit prior consent and approval.**
2. **The information contained in this Manual is subject to change or review without prior notice.**
3. **Be sure to follow all safety, operating and handling precautions described in this Manual and the regulations in force in the country in which this product is to be used.**

10th Edition June, 2007
First Edition September, 2005

SAFETY PRECAUTIONS



Safety signs and labels affixed to the product and/or described in this manual give important information for using the product safely. They help prevent damage to property and obviate hazards for persons using the product.

Make yourself familiar with signal words and symbols used for safety signs and labels. Then read the safety precautions that follow to prevent an accident involving personal injury, death or damage to property.

Explanation of signal words

The signal word or words are used to designate a degree or level of hazard seriousness.

The signal words used for the product described in this manual are **WARNING** and **CAUTION**.



 WARNING	Indicates a potentially hazardous situation, which, if not avoided, could result in death or serious injury .
 CAUTION	Indicates a potentially hazardous situation, which, if not avoided, may result in minor to moderate injuries or in property damage .

Notes:

- 1 “Series injury” refers to **an injury such as loss of sight, physical damage, burns (high temperature or low temperature) electric shock, bone fracture and poisoning and the after effect of the injury remains or the injury requires hospitalization or long periods of outpatient treatment.**
- 2 “Minor to moderate injuries” refers to **burns, electric shocks, and so on, that do not oblige the injured person to be hospitalized or go to a hospital for a long period of time for medical treatment.** “Property damage” includes **all kinds of damage to property, equipment or materials.**

Safety symbols

The following symbols are used in safety signs and labels affixed to a product and/or in the manual for giving safety instructions.

	Indicates an action that is prohibited. Simply DON'T do this action. The prohibited action is indicated by a picture or text inside or next to the circle
	Indicates an action that is mandatory. DO this action. The mandatory action is indicated by a picture or text inside or next to the circle.
	Indicates a potential hazard. The potentially hazardous situation is indicated by a picture or text inside or next to the triangle.







Color explanation

WARNING  Background color: Yellow and Red, Border: Black, Picture display: Black

CAUTION  Background color: Yellow, Border: Black, Picture display: Black











SAFETY PRECAUTIONS (continued)

Safety Precautions for Hazardous Locations

 WARNING	
<p>■ Do not disconnect while circuit is live unless location is known to be nonhazardous.</p> <p> DON'T</p>	<p>Live part of electric circuit or a high temperature department can cause explosion.</p>
<p>■ Do not modify or disassemble the enclosure.</p> <p> DON'T</p>	<p>Strength degradation and defects of enclosure can cause explosion.</p>
<p>■ Do not use parts of other products.</p> <p> DON'T</p>	<p>Protective performance degradation for hazardous location can cause explosion.</p>
<p>■ Do not live circuits While assembly of all components is not over.</p> <p> DON'T</p>	<p>Protective performance degradation for hazardous location can cause explosion.</p>
<p>■ Install per the National Electrical Code for the US (NEC, ANSI/NFPA 70) and the Canadian Electrical code for Canada (CEC, CAN/CSA-C22.1) and the drawing 3S8A2532,3S8A2533 (Refer to Appendix 2.).</p> <p> DO</p>	<p>Unsuitable conduit connections for hazardous location can cause explosion.</p>







SAFETY PRECAUTIONS (continued)

Safety Precautions for Installation and Wiring

 CAUTION	
<p>■ Install a switch and fuse to isolate the LF600F and LF602F from mains power.</p> <p> Power supply from mains power can cause electric shock or circuit break-down.</p> <p>DO</p>	<p>■ Use an appropriate device to carry and install the LF600F and LF602F.</p> <p> If this product falls to the ground, injury, or malfunction of or damage to the product, can be caused.</p> <p>DO</p>
<p>■ Turn off mains power before conducting wiring work.</p> <p> Wiring while power is applied can cause electric shock.</p> <p>DO</p>	<p>■ Do not modify or disassemble the LF600F and LF602F unnecessarily.</p> <p> Modifying or disassembling this product can cause electric shock, malfunction of or damage to this product.</p> <p>DON'T</p>
<p>■ Turn off mains power before working on pipes.</p> <p> Working on pipes while power is applied can cause electric shock.</p> <p>DO</p>	<p>■ Ground the LF600F and LF602F independently from power equipment. (100 ohm or less ground resistance)</p> <p> Operating this product without grounding can cause electric shock or malfunction.</p> <p>DO</p>
<p>■ Do not conduct wiring work with bare hands.</p> <p> Remaining electric charge even if power is turned off can still cause electric shock.</p> <p>DON'T</p>	<p>Use crimped terminal lugs for the terminal board and GND terminal.</p> <p> Loose connections can cause electric shock, fire from excessive current or system malfunction.</p> <p>DO</p>
<p>■ Do not work on piping and wiring with wet hands.</p> <p> Wet hands may result in electric shock.</p> <p>DON'T</p>	
<p> The label shown left is placed near the terminal board for power supply on the converter. (A black border and symbol on yellow triangle) Be alert to electric shock.</p>	

SAFETY PRECAUTIONS (continued)

Safety Precautions for Maintenance and Inspection

 CAUTION	
<p>■ Do not conduct wiring work with wet hands.</p> <div style="display: flex; align-items: center;">  <div style="margin-left: 10px;"> <p>Wet hands may result in electric shock.</p> <p>DON'T</p> </div> </div>	<p>■ Do not conduct wiring work when power is applied.</p> <div style="display: flex; align-items: center;">  <div style="margin-left: 10px;"> <p>Wiring while power is applied can cause electric shock.</p> <p>DON'T</p> </div> </div>
<p>■ Do not use a fuse other than the one specified.</p> <div style="display: flex; align-items: center;">  <div style="margin-left: 10px;"> <p>Using a fuse other than the one specified can cause system failure, damage or malfunction.</p> <p>DON'T</p> </div> </div>	<p>■ Do not touch the LF600F main body when high temperature fluid is being measured.</p> <div style="display: flex; align-items: center;">  <div style="margin-left: 10px;"> <p>The fluid raises the main body temperature and can cause burns when touched.</p> <p>DON'T</p> </div> </div>
<p>Use a rated fuse as follows:</p> <p>Fuse rating:</p> <p>①0.8A(T)/250V for 100 to 240Vac or 110Vdc</p> <p>②2A/150V for 24 V dc</p> <p>Dimensions: Diameter 5 mm × 20 mm</p> <p>Melting time characteristic: ①Time Lag</p> <p style="padding-left: 40px;">②Medium-Arcing (Normal blow)</p>	<div style="display: flex; align-items: center;">  <div style="margin-left: 10px;"> <p>The label shown left is placed near the terminal board for power input. (A black border and symbol on yellow triangle)</p> <p>Be alert to electric shock.</p> </div> </div>

Usage limitation

This product is **not manufactured for applying to a system requiring safety directly involved human life as follows**. Please contact you're nearest Toshiba representative if there is a possibility of using this product for such use.

- **Main control systems of nuclear power plants, safety protection systems in nuclear facilities or other important systems requiring safety**
- **Medical control systems relating to life support**

Warranty and Limitation of Liability

Toshiba does not accept liability for any damage or loss, material or personal, caused as a direct or indirect result of the operation of this product in connection with, or due to, the occurrence of any event of force majored (including fire or earthquake) or the misuse of this product, whether intentional or accidental.

Handling Precautions

To obtain the optimum performance from the LF600F and LF602F converter for years of continuous operation, observe the following precautions.

- (1) **Do not store or install the flowmeter in:**
- **places where there is direct sunlight.**
 - **places where there is snow and ice**
Infrared switches may not function correctly.
 - **places where excessive vibration or mechanical shock occurs.**
 - **places where high temperature or high humidity conditions obtain.**
 - **places where corrosive atmospheres obtain.**
 - **places submerged under water.**
 - **place where there is slop floor.** To put the flowmeter temporarily on the floor, **place it carefully with something, such as stopper, to support it so that the flowmeter will not topple over.**
 - **Places where there is following factors.**
 - ◆ **Factors to impede infrared switch to operate properly**
 - Intense light such as direct sunlight and reflected sunlight by window glass or metal plate
 - Place where brightness changes always such as ON/OFF of lighting
 - Dense smoke or steam near the control panel
 - Those attached on the control panel such as rain (dew drop), snow, ice, mud and oil, and haze due to their attachment
 - Light reflecting object near the control panel, or reflecting object such as metal plate placed opposing to the control panel

When any of above factors is considered, take a measure for the proper operation of infrared switch such as to place a cover or to secure a space for at least a person to stand in front of the control panel.

When unable to avoid above factors, operate the EMF converter removing the factor by covering the control panel by hand so that light does not shine on it, by cleaning those attached on the control panel, or by standing in-between the reflecting object and the control panel to block the light.

- (2) **Wire cables correctly and securely.**
Be sure to ground at the converter side (**grounding resistance 100Ω or less**).
Avoid a common ground **used with other equipment** where earth current may flow. An **independent ground** is preferable
- (3) Select cable paths away from electrical equipment (motors, transformers, or radio transmitters), which causes electromagnetic or electrostatic interference.
- (4) The cable glands is not provided in the conduit port of this apparatus.
Because 1/2-14NPT screw holes are processed to this place, please prepare yourself for the cable glands which could be used in Division2 hazardous locations.
The cable lead-in section must be tightened securely to keep air tightness.

Handling Precautions (continued)

- (5) If the inside of the converter or cable terminals are wetted or humidified, it may cause insulation deterioration, which can result in **fault or noise occurrence**. So do not conduct **wiring in the open air on rainy days**.
Also, be careful not to wet down the converter even in the case of indoor wiring, and complete wiring work in a short period of time.
- (6) **Observe the following precautions when you open the converter housing cover:**
 - **Do not open the cover in the open air unprotected against rain or wind**. This can cause **electric shock** or cause **damage to the flowmeter electronics**.
 - **Do not open the cover under high ambient temperature or high humidity conditions or in corrosive atmospheres**. This can cause **deterioration of system accuracy** or cause **damage to the flowmeter electronics**.
- (7) Since a varistor is built in converter, **do not conduct a withstand voltage test for the converter**.
In addition, the voltage for checking the insulation of the converter must be **250VDC or lower**.
- (8) This product may cause **interference to radio and television sets** if they are used near the installation site. **Use metal conduits etc. for cables to prevent this interference**.
- (9) Radio transmitters such as transceivers or cellular phones may cause interference to the flowmeter if they are used near the installation site. Observe the following precautions when using them:
 - **Close a transmitter cover** before using a transceiver.
 - Do not use a transceiver whose output power is more than **5 W**.
 - Move the antenna of a transceiver or a cellular phone **at least 50 cm** away from the flowmeter and signal cables when using it.
 - **Do not use a radio transmitter or a cellular phone near the flowmeter** while it is operating online. The transmitter or cellular phone's output impulse noise may interfere with the flowmeter.
 - **Do not install a radio transmitter antenna** near the flowmeter and signal cables.
- (10) For reasons of flowmeter failure, inappropriate parameters, unsuitable cable connections or poor installation conditions, the flowmeter may not operate properly. To prevent any of these problems causing a system failure, **it is recommended that you have preventive measures designed and installed on the flowmeter signal receiving side**.
- (11) **For piping and installation of the combined detector, check the model number of detector and read the instruction manual of the relevant detector**.

* We assume no responsibility for nonconformity caused by violation of precautions described in this manual or used in violation of the installation method and the operation method stipulated in a relevant ordinance or other regulations.

Table of Contents

- 1. Product Inspection and Storage 11
 - 1.1 Product Inspection 11
 - 1.2 Storage 11
- 2. Overview 12
- 3. Names of Parts 13
 - 3.1 Appearance 13
 - 3.1.1 Appearance of LF600F Type 13
 - 3.1.2 Appearance of LF602F Type 14
 - 3.2 Construction of the terminal blocks 15
 - 3.2.1 Terminal Block Construction of LF600F Type 15
 - 3.2.2 Terminal Bock Construction of LF602F Type 16
- 4. Installation 17
 - 4.1 Notes on Selecting the Installation Location 18
 - 4.2 How to Install 19
 - 4.2.1 LF600F Type 19
 - 4.2.2 LF602F Type 19
- 5. Wiring 21
 - 5.1 Cables 22
 - 5.2 External Device Connections and Grounding 23
 - 5.2.1 LF600F Type 23
 - 5.2.1 LF602F Type 24
 - 5.3 Notes on Wiring 25
 - 5.3.1 Notes on Instrumentation-Converter Wiring 25
 - 5.3.2 Notes on Wiring of the LF602F Type 25
 - 5.4 Wiring 26
 - 5.4.1 Grounding 26
 - 5.4.2 Terminal Treatment of Cables 28
 - 5.4.3 Cable Connection 30
 - 5.5 Digital I/O Connections 31
- 6. Operation 32
 - 6.1 Preparatory check 32
 - 6.2 Zero Adjustment 33
- 7. LCD Display and Controls 34
 - 7.1 Name and Function of Each Part of LCD Display 34
 - 7.2 Display Format 36
 - 7.3 Basic operations 42
 - 7.3.1 Mode Change 42
 - 7.3.2 Setting and Calibration 46
 - 7.4 Configuration Items Selection Table 50
 - 7.5 Password input 52

8. Configuration Parameter Setting.....	53
8.1 Configuration Items.....	53
8.2 Check/Change of Parameters.....	54
8.2.1 Menu Configuration Selection Screen.....	54
8.2.2 Exciting Current Value.....	55
8.2.3 Meter Size.....	57
8.2.4 Exciting Frequency.....	59
8.2.5 Flow Direction Setting.....	61
8.2.6 Password Setting.....	63
8.2.7 Address Setting.....	65
8.2.8 Indicating Unit.....	65
8.2.9 Custom Coefficient Setting.....	69
8.2.10 Custom Unit Setting.....	70
8.2.11 LCD Density Adjustment.....	72
8.2.12 Switch Position Setting.....	73
8.2.13 Span (range).....	76
8.2.14 Damping Constant.....	83
8.2.15 Low Cutoff.....	84
8.2.16 Current Output Setting Used When an Alarm Occurs.....	85
8.2.17 Display Low Cut Setting.....	86
8.2.18 Output Low Limit Setting.....	88
8.2.19 Still Water Zero Adjustment.....	89
8.2.20 Digital I/O.....	90
8.2.21 Count Rate (Pulse Rate), Pulse Width Setting Mode, Pulse Width.....	93
8.2.22 Preset Count Value.....	96
8.2.23 Preset Point Output Function.....	97
8.2.24 Flow Rate High, Low, High-High and Low-Low limit Alarm Setting.....	98
8.2.25 Empty Alarm Setting.....	100
8.2.26 Self-diagnosis ON/OFF Setting.....	101
8.2.27 Alarm Output Preset Function Setting.....	102
8.2.28 Rate-Of-Change Limit and Control Limit Time.....	103
8.2.29 Fixed-Value Output.....	105
8.2.30 Zero Offset Adjustment.....	108
8.2.31 Parameter initial settings list.....	110
9. Calibration.....	111
9.1 Calibration Items.....	111
9.2 Calibration Using Converter Signal Source.....	112
9.2.1 0 % Flow Rate Calibration (zero point calibration).....	112
9.2.2 50 % Flow Rate Calibration.....	113
9.2.3 100 % Flow Rate (Span) Calibration.....	113
9.2.4 Checking the Excitation Current Value.....	113
10. Digital I/O Functions.....	114
10.1 Digital I/O Specifications.....	115
10.2 Totalizer and Pulse Output.....	116
10.3 Multi-range Functions.....	120
10.4 High/Low, High-high or Low-low Limit Alarm.....	125
10.5 Preset Count Output.....	127
10.6 Remote Zero Adjustment.....	130

10.7 Remote Selection of Fixed Value Output	131
10.8 Converter Failure Alarm	132
10.9 Multiple range high/low limit alarm function (option)	133
11. Communications Function.....	135
11.1 Connections with the HHT Terminal.....	136
11.2 Procedures for Communication with HHT.....	137
11.3 Cautionary Notes on Communications.....	138
12. Self-Diagnostics and Alarms.....	139
12.1 Self-diagnostics	139
12.2 Output Status for Errors and Alarms	142
13. Maintenance and Troubleshooting.....	143
13.1 Maintenance	144
13.2 Troubleshooting.....	145
13.2.1 Flow rate is not indicated.....	145
13.2.2 Flow rate indication is not correct.....	146
13.2.3 Flow rate indication is not stable.....	147
13.2.4 When switch operation is unable	148
14. Principle of Operation.....	149
15. Specifications	150
15.1 Specifications.....	150
15.2 Model Number Table	150
16. Outline Drawing.....	153
16.1 LF600F Type.....	153
16.2 LF602F Type.....	154
Appendix 1 (Factory default standard value table)	155
Appendix 2.....	157
2-1 A system block diagram for LF600F	157
2-2 A system block diagram for LF602F	158
Appendix 3 (Electromagnetic Compatibility and Low Voltage Safety)	159

1. Product Inspection and Storage

1.1 Product Inspection

LF60*F series electromagnetic flowmeter is shipped in a cardboard container filled with shock-absorbing materials. Open the package carefully and check as follows:

- Make sure the following items are included in the package.

For the **integral type** (when a converter and detector are united)



Electromagnetic flowmeter main unit -----	1 unit
Instruction manual -----	One each for the converter and detector

For the **separate type** (when a converter and detector are separated)



Electromagnetic flowmeter converter -----	1 unit
Electromagnetic flowmeter detector -----	1 unit
Instruction manual -----	Once each for the converter and detector

For a **converter unit only**



Electromagnetic flowmeter converter -----	One unit
Instruction manual -----	One for the converter

- Inspect the flowmeter for indications of **damage** that may have occurred during shipment.
- Make sure the type and specifications of the flowmeter are in accordance with the **ordered specifications**.

If you cannot find the items listed above or any problem exists, contact you're nearest Toshiba representative.

1.2 Storage

To store the electromagnetic flowmeter after opening the package, select a storing place as follows and keep it under the conditions described below:

CAUTION

- (1) Avoid places where there is **direct sunlight, rain or wind**.
- (2) Store the product in a well-ventilated place. Avoid places of **extremely high humidity** or **extremely high or low temperature**. The following environment is recommended:
 - **Humidity range: 10 to 90% RH (no condensation)**
 - **Storage temperature: -25 to +65° C**
- (3) Avoid places where **vibrations or mechanical shock occur**.
- (4) If it leaves the cover of converter open while being stored, gradual deterioration of circuit isolation can be caused. And then **don't open the cover** until it is connected with wires.
- (5) To put the flowmeter temporarily on the floor, **place it carefully with something, such as stopper, to support it so that the flowmeter will not topple over**.

2. Overview

The LF600F and LF602F electromagnetic flowmeter converter can be use in the following hazardous (classified) locations.

Class I , Division 2, Groups A, B, C and D,
Class II , Division 2, Groups E, F and G
Class III

This product is a converter used for electric flowmeters that measure the volumetric flow rate of conductive fluid using Faraday's law of electromagnetic induction.

You can bring out the functions of the converter when you place it in the converter housing you prepare and use it in combination with a fluid rate measurement detector.

The converter sends out a signal to drive the detector exciting coil, which generates a magnetic field inside the detector. The converter receives the signal electromotive force obtained by the detector, as signal electromotive force in proportion to the generated flow rate in the fluid using Faraday's law of electromagnetic induction. After carrying out operation, the converter converts the signal electromotive force to an analog signal instrumentation unified signal output and displays the status, as a flow rate value.

Features

With a **linear relationship between the flow rate and output signal**, the electromagnetic flowmeter is featured as an easy-to-read indicator. In addition to this feature, it has the following outstanding features:

- (1) Wide flow velocity range setting, such as a flow velocity range of 0~0.1 and 0~10m/s, is achieved.
- (2) **The unique noise filter-out circuit and arithmetic operation processor** enables you to obtain **stable output**.
- (3) Full graphic LCD that enables display of a large amount of information
 - With a large amount of a maximum of 14 characters x 8 lines, you can easily check various displays including bar graphs and alarm indications.
 - The backlight allows you to read the indicator easily.
- (4) Use of infrared switches
 - Use of infrared switches allows you to perform various operations, without opening the converter housing cover.
- (5) **Intelligent functions**
 - The widely used **HART protocol communications system** is used as a standard feature.
 - This product supports **PROFIBUS^{*2} communication** by option.

* 1 HART protocol: "HART" stands for Highway Addressable Remote Transducer and is a communication protocol recommended by HCF (HART communication Foundation) for industrial sensors.

* 2 PROFIBUS: PROFIBUS, which stands for PROCESS FIELDBUS, is a kind of field bus that is approved by international standard IEC61158. The electromagnetic flowmeter supports PRFIBUS PA for process automation.

3. Names of Parts

IMPORTANT

The cable glands is not provided in the conduit port of this apparatus.
Please prepare yourself for the cable glands, which could be used in Division2 hazardous locations.

3.1 Appearance

3.1.1 Appearance of LF600F Type

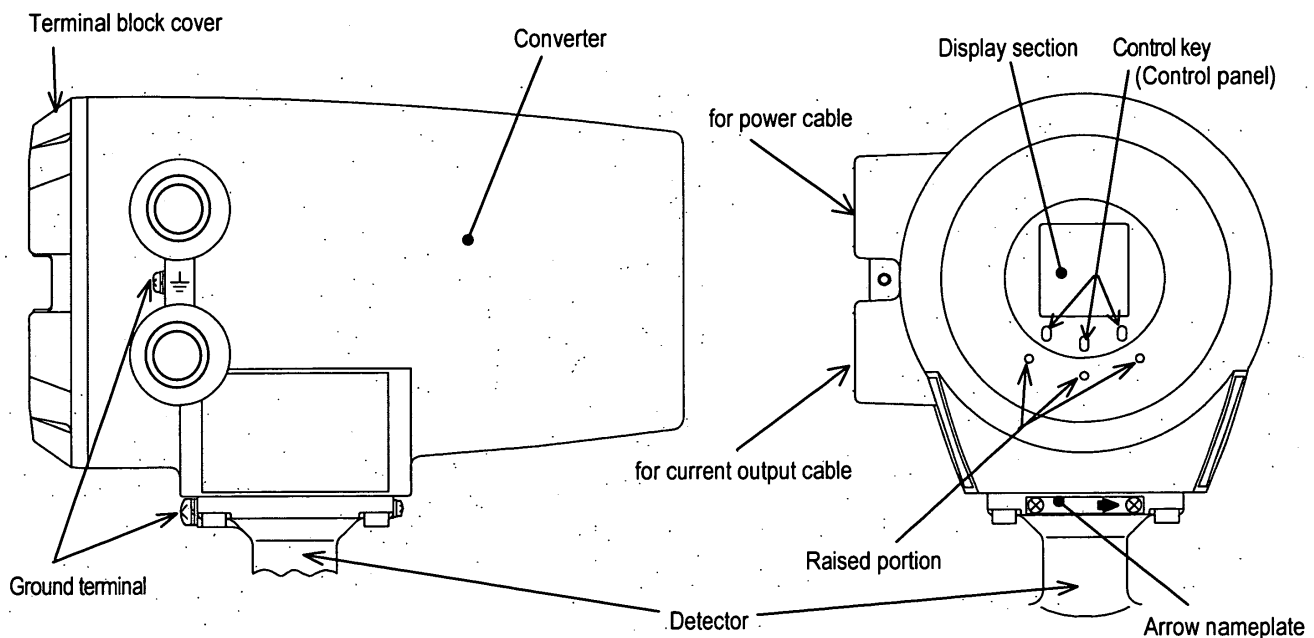

Figure 3.1.1 Appearance of LF600F

3.1.2 Appearance of LF602F Type

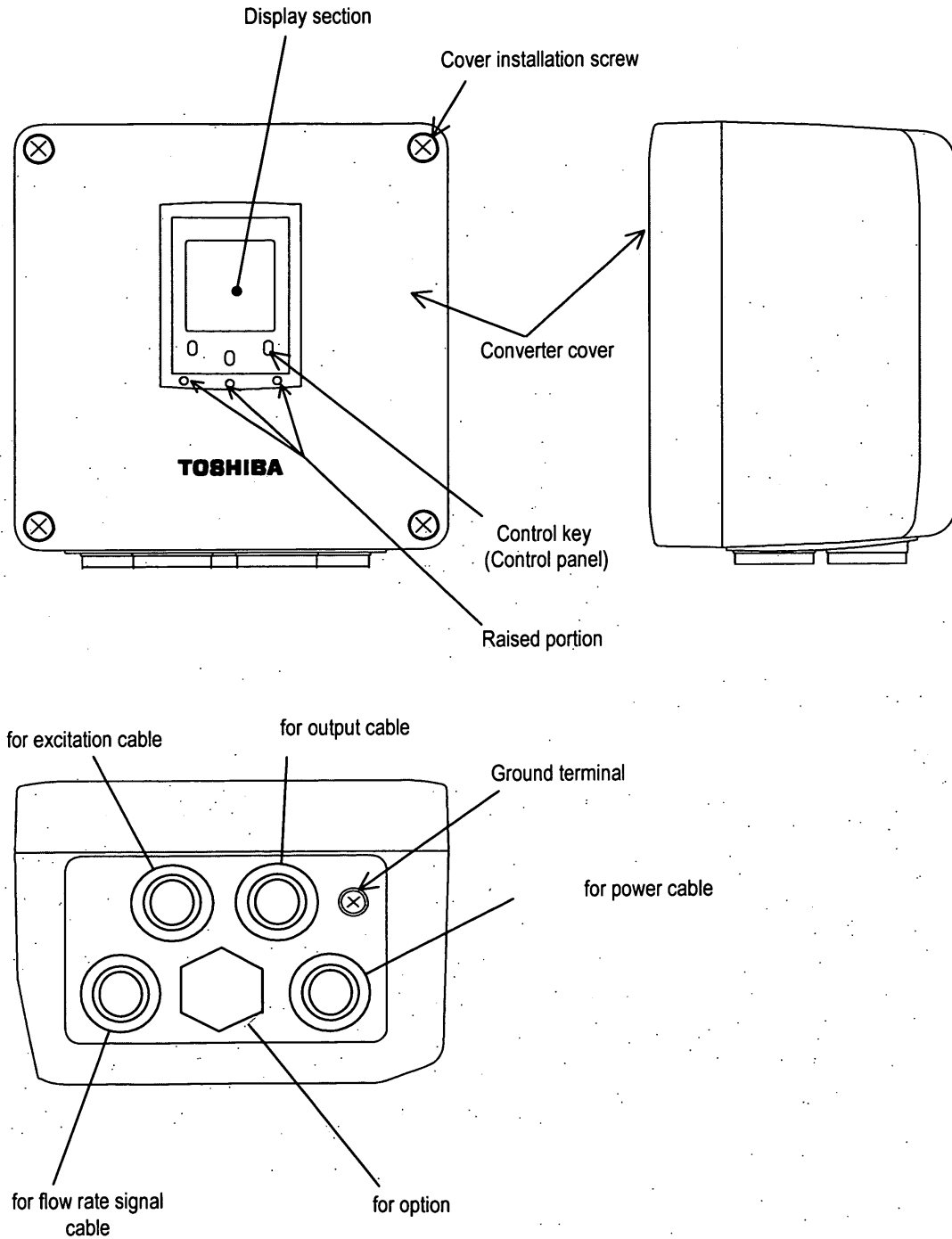

Figure 3.1.2 Appearance of LF602F

3.2 Construction of the terminal blocks

3.2.1 Terminal Block Construction of LF600F Type

When you remove the terminal block cover shown in the figure "Appearance of LF600F Type", you can see the converter terminal block as shown below.

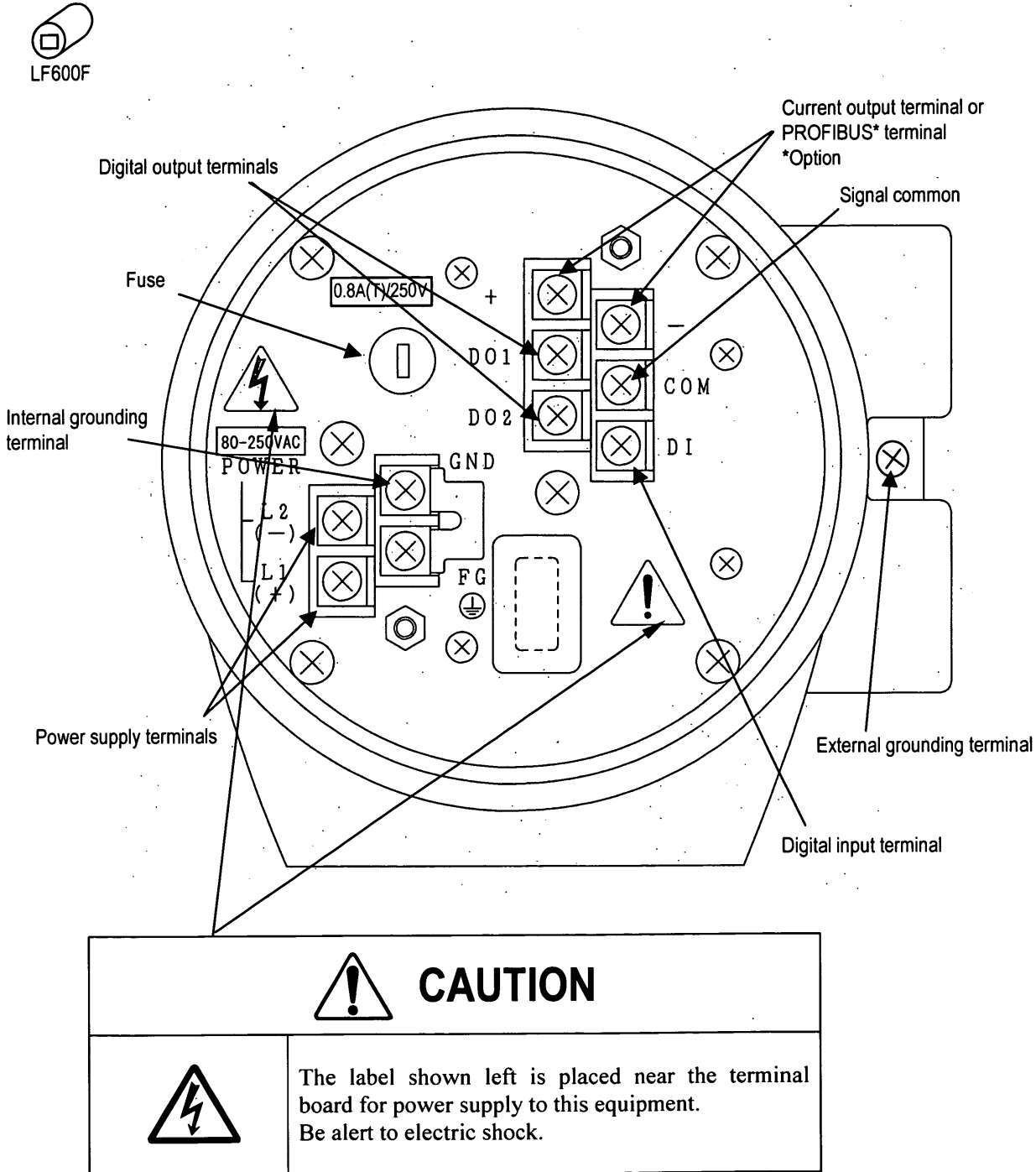

Figure 3.2.1 Terminal Block Construction of LF600F

3.2.2 Terminal Block Construction of LF602F Type



CAUTION

The label shown left is placed near the terminal board for power supply to this equipment. Be alert to electric shock.

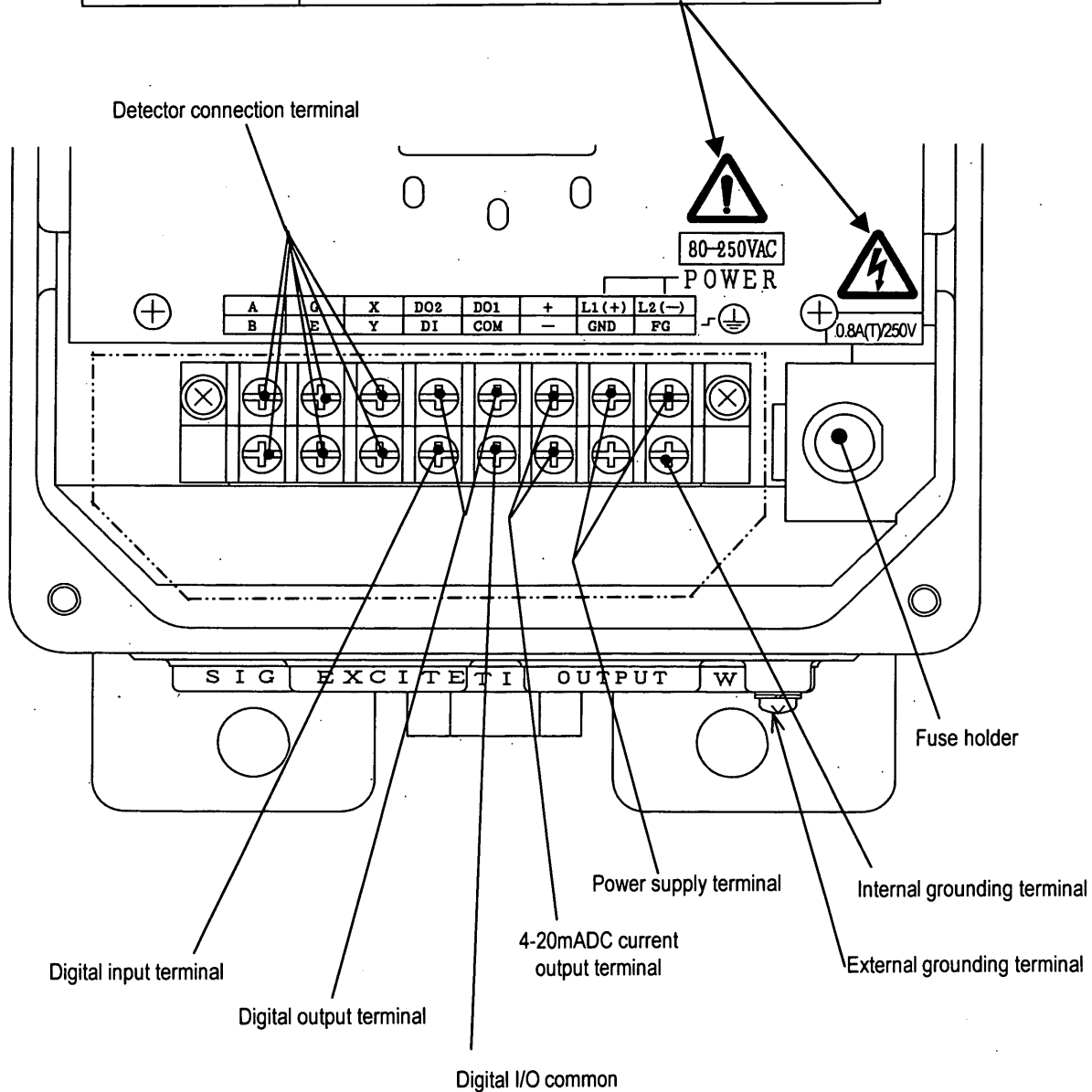













Figure 3.2.2 Terminal Block Construction of LF602F

4. Installation

Safety Precautions for Installation

 WARNING	
<p>■ Do not live circuits under environment of explosive atmospheres.</p> <p> Live part of electric circuit or a high temperature department can cause explosion.</p> <p>DON'T</p>	
<p>■ Do not use parts of other products.</p> <p> Protective performance degradation for hazardous location can cause explosion.</p> <p>DON'T</p>	
<p>■ Do not live circuits While assembly of all components is not over.</p> <p> Protective performance degradation for hazardous location can cause explosion.</p> <p>DON'T</p>	
<p>■ Install per the National Electrical Code for the US (NEC, ANSI/NFPA 70) and the Canadian Electrical code for Canada (CEC, CAN/CSA-C22.1) and the drawing 3S8A2532,3S8A2533 (Refer to Appendix 2.).</p> <p> Unsuitable conduit connections for hazardous location can cause explosion.</p> <p>DO</p>	

 CAUTION	
<p>■ Ground the LF600F and LF602F independently from power equipment. (100 ohm or less ground resistance)</p> <p> Operating this product without grounding can cause electric shock or malfunction.</p> <p>DO</p>	<p>■ Use an appropriate device to carry and install the LF600F and LF602F.</p> <p> If his product falls to the ground, injury, or malfunction of or damage to the product, can be caused.</p> <p>DO</p>
<p>■ Install a switch and fuse to isolate the LF600FF and LF602FF from mains power.</p> <p> Power supply from mains power can cause electric shock or circuit break-down.</p> <p>DO</p>	<p>■ Do not modify or disassemble the LF600F and LF602F unnecessarily.</p> <p> Modifying or disassembling this product can cause electric shock, malfunction or damage to this product.</p> <p>DON'T</p>
<p>■ Do not work on piping and wiring with wet hands.</p> <p> Wet hands may result in electric shock</p> <p>DON'T</p>	<p> The label shown left is placed near the terminal board for power supply to the converter. Be alert to electric shock</p>

4.1 Notes on Selecting the Installation Location

This product is designed for the following environment.

- Indoor and outdoor installation
- Ambient temperature: -20 to $+60^{\circ}\text{C}$
- Altitude: Up to 2000m
- Humidity range: 10 to 90%(no condensation)
- Regulation of power voltage: $\pm 10\%$
- Pollution degree 2
- Structure: IP67 (NEMA 4X)

Do not store or install the flowmeter in :

1. Places within the immediate proximity of equipment producing electrical interference (such as **motors, transformers, radio transmitters, electrolytic cells, or other equipment causing electromagnetic or electrostatic interference**).
2. **Places where there is direct sunlight.**
3. Places where **excessive vibration or mechanical shock occurs.**
4. Places where **high temperature or high humidity** conditions obtain.
5. Places where **corrosive atmospheres** obtain.
6. **Places submerged under water.**
7. **Place where there is slop floor.** To put the flowmeter temporarily on the floor, place it **carefully with something, such as stopper, to support it so that the flowmeter will not topple over.**
8. Places of **too great an elevation or constricted areas** where clearance for installation or maintenance work is not provided.
9. The standard length of the cable that connects **the detector and converter is 30m.** Select the converter installation location so that the distance of the detector and converter will not exceed 30m.
10. **Places where there is following factors.**
 - ◆ Factors to impede infrared switch to operate properly
 - Intense light such as direct sunlight and reflected sunlight by window glass or metal plate
 - Place where brightness changes always such as ON/OFF of lighting
 - Dense smoke or steam near the control panel
 - Those attached on the control panel such as rain (dew drop), snow, ice, mud and oil, and haze due to their attachment
 - Light reflecting object near the control panel, or reflecting object such as metal plate placed opposing to the control panel



LF602F

When any of above factors is considered, take a measure for the proper operation of infrared switch such as to place a cover or to secure a space for at least a person to stand in front of the control panel.

When unable to avoid above factors, operate the EMF converter removing the factor by covering the control panel by hand so that light does not shine on it, by cleaning those attached on the control panel, or by standing in-between the reflecting object and the control panel to block the light.

4.2 How to Install

4.2.1 LF600F Type



The LF600F type converter is used as one united body. The LF600F type is not installed by itself. For how to install the LF600F type converter and a detector, check the type of the combined detector and follow the instruction manual of the relevant detector.

4.2.2 LF602F Type



The LF602F type can be installed on a wall or to a pipe stand. Install the converter so that the front of the cover is positioned on the vertical plane. Be sure to install it so that the conduit opening of the converter will face the bottom.

Figure 4.1 shows examples of installation to a panel and wall. Figure 4.2 shows an example of installation to a pipe stand.

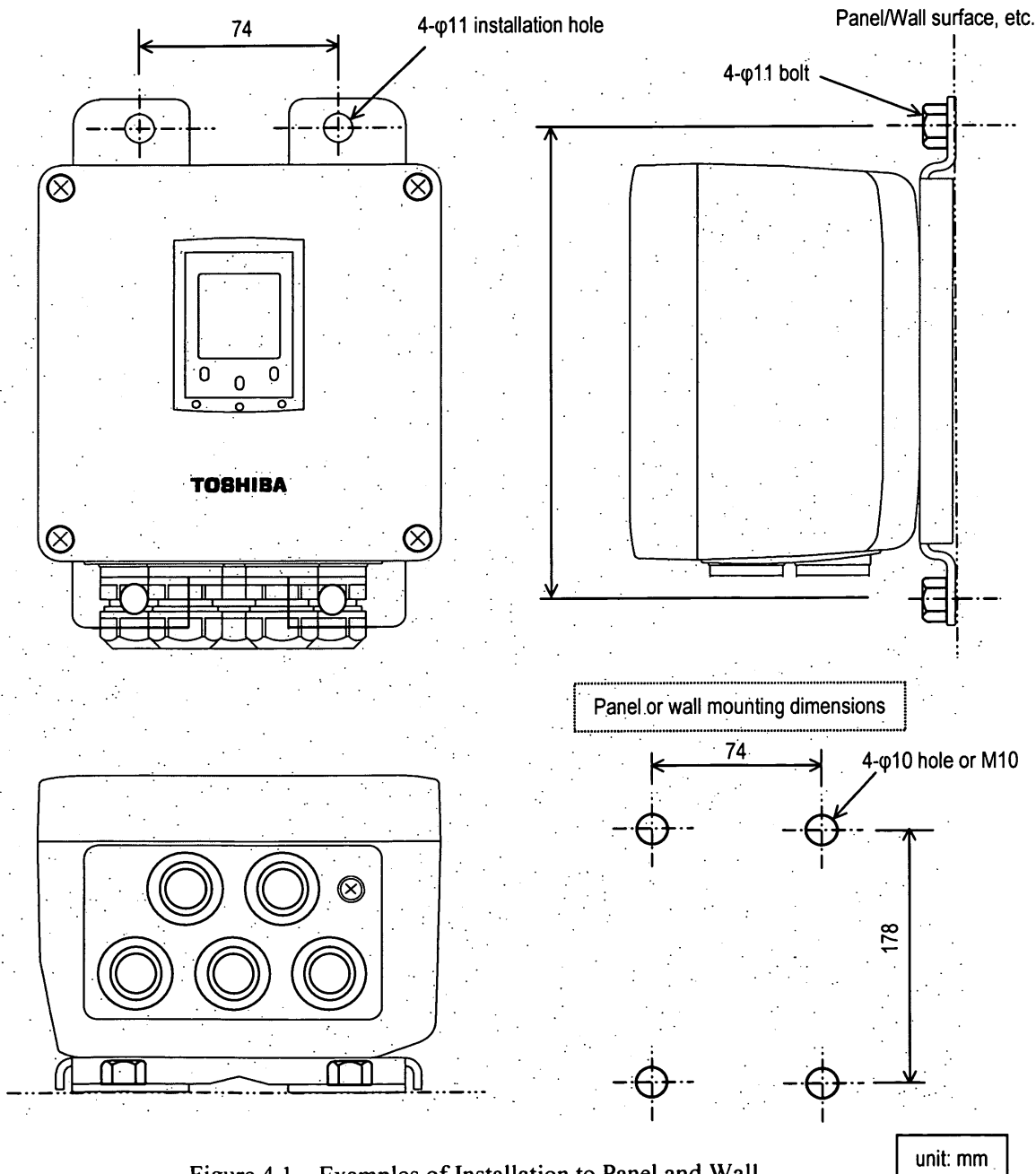

Figure 4.1 Examples of Installation to Panel and Wall

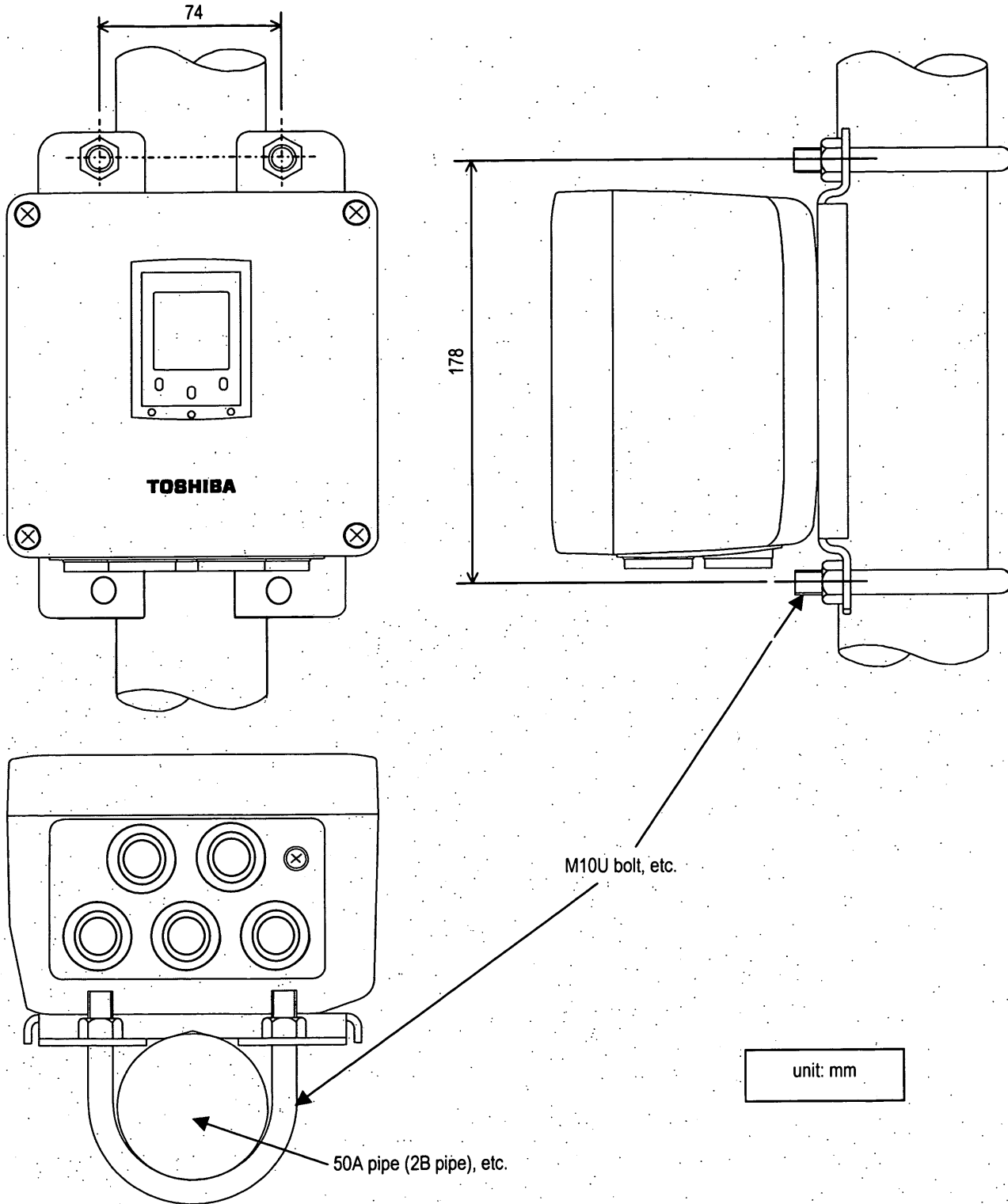















Figure 4.2 Example of Pipestand Mounting

5. Wiring

 WARNING	
<p>■ DO NOT DISCONNECT WHILE CIRCUIT IS LIVE UNLESS LOCATION IS KNOWN TO BE NONHAZARDOUS.</p> <p> Live part of electric circuit or a high temperature department can cause explosion.</p> <p>DON'T</p>	
<p>■ Do not live circuits While assembly of all components is not over.</p> <p> Protective performance degradation for hazardous location can cause explosion.</p> <p>DON'T</p>	
<p>■ Install per the National Electrical Code for the US (NEC, ANSI/NFPA 70) and the Canadian Electrical code for Canada (CEC, CAN/CSA-C22.1) and the drawing 3S8A2532,3S8A2533 (Refer to Appendix 2.).</p> <p> Unsuitable conduit connections for hazardous location can cause explosion.</p> <p>DO</p>	

 CAUTION	
<p>■ Install a switch and fuse to isolate the LF600F and LF602F from mains power.</p> <p> Power supply from mains power can cause electric shock or circuit break-down.</p> <p>DO</p>	<p>■ Turn off mains power before conducting wiring work.</p> <p> Wiring while power is applied can cause electric shock.</p> <p>DO</p>
<p>■ Do not work on piping and wiring with wet hands.</p> <p> Wet hands may result in electric shock</p> <p>DON'T</p>	<p>■ Ground the LF600F independently from power equipment. (100 ohm or less ground resistance)</p> <p> Operating this product without grounding can cause electric shock or malfunction.</p> <p>DO</p>
<p>■ Do not conduct wiring work with bare hands.</p> <p> Remaining electric charge even if power is turned off can still cause electric shock.</p> <p>DON'T</p>	<p>■ For the power supply wiring and grounding wiring, use crimping terminals with insulated sleeve.</p> <p> There is a risk of electric shock due to drop-off or loosing, and a risk of fire and equipment trouble due to heat generation.</p> <p>DO</p>
<p>Do not modify or disassemble the LF600F and LF602F unnecessarily.</p> <p> Modifying or disassembling this product can cause electric shock, malfunction of or damage to this product.</p> <p>DON'T</p>	<p> The label shown left is placed near the power supply terminal on the converter.</p> <p>Be alert to electric shock.</p>

Flowmeter accuracy may be affected by the way wiring is executed. Proceed with correct wiring taking the precautions in following pages.

Notes on wiring

CAUTION

- (1) Select the cable runs **away from electrical equipment (motors, transformers, or radio transmitters) which causes electromagnetic or electrostatic interference.**
- (2) Deterioration of flowmeter circuit insulation occurs if the converter interior or cable ends get wet or humidified. This in turn causes **malfunction of flowmeter or noise problems.** **Avoid a rainy day if the flowmeter is to be installed outdoors.** Even indoors, prevent water from splashing over the flowmeter. Try to finish the wiring as quickly as possible
- (3) The converter has an arrestor installed inside. Therefore, **do not conduct a withstand voltage test for the converter.** To check the insulation of the converter, use a voltage of **250Vdc or less.**
- (4) After wiring, be sure to install the terminal block protection cover.
- (5) Because the excitation cable and flow rate signal cable transmit very delicate signals, pass each of them separately through a thick steel conduit tube, keep them away from the large current wiring as far as possible, and do not install them in parallel.



LF602F

5.1 Cables

Use the kind of cables shown in Table 5.1 to wire the converter.

Table 5.1 Installation Cables

Name	Cable name	Nominal cross-sectional area	Finished outer diameter	Description
Power cable	3-core vinyl sheathed cable or 2-core vinyl sheathed cable	2 mm ²	11~13mm	CVV -JIS C 3401, IEC60695, IEC60754, IEC60227, IEC60245 or equivalent
Output signal cable	The number of conductors the cable contains differs depending on the specification of the output signal cable. Use a shielded cable of finished outer diameter 11 to 13mm and nominal cross-sectional area 1.25mm ² .			CVV-S JIS -258-C or equivalent
Flow rate signal cable	2-core shielded chloroprene cabtyre cable	0.75 mm ²	11~13m m	2PNCT-S JIS C 3327 or equivalent
Excitation cable	3-core shielded chloroprene cabtyre cable	2 mm ² 1.25 m ²	11~13m m	2PNCT JIS C 3327 or equivalent



LF602F



LF602F

5.2 External Device Connections and Grounding

5.2.1 LF600F Type



The terminal board connections of an integral type converter LF600F are shown in Figure 5.1. Proceed with wiring as described in Section 5.4, "Wiring Procedure."

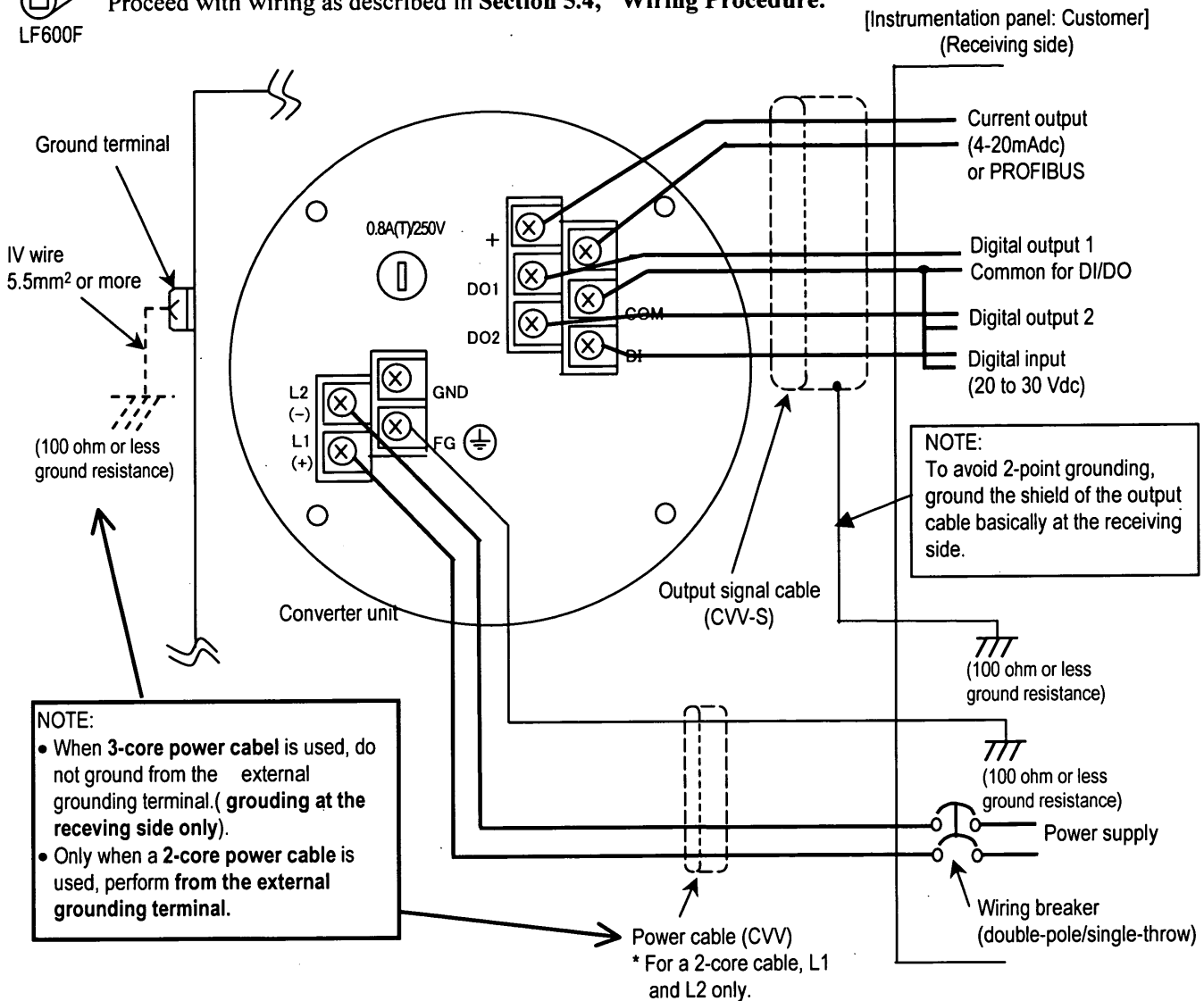

Figure 5.1 External Wiring Schematic Diagram

* Use a heavy copper braid or wire (cross-sectional area **5.5 mm² minimum**) to ground the terminal and make it as **short as possible** as shown in Figure 5.1 for **grounding**. Also, **Avoid a common ground** where earth current may flow. (An **independent ground** is preferable.)

* The converter has no power switch. Install the power switch at the system side. **Be sure to use a double-pole/single-throw (both disconnection) wiring breaker.**

5.2.2 LF602F Type

The terminal board connections of separate type converter LF602F are shown in Figure 5.1. Proceed with wiring as described in Section 5.4, "Wiring Procedure."

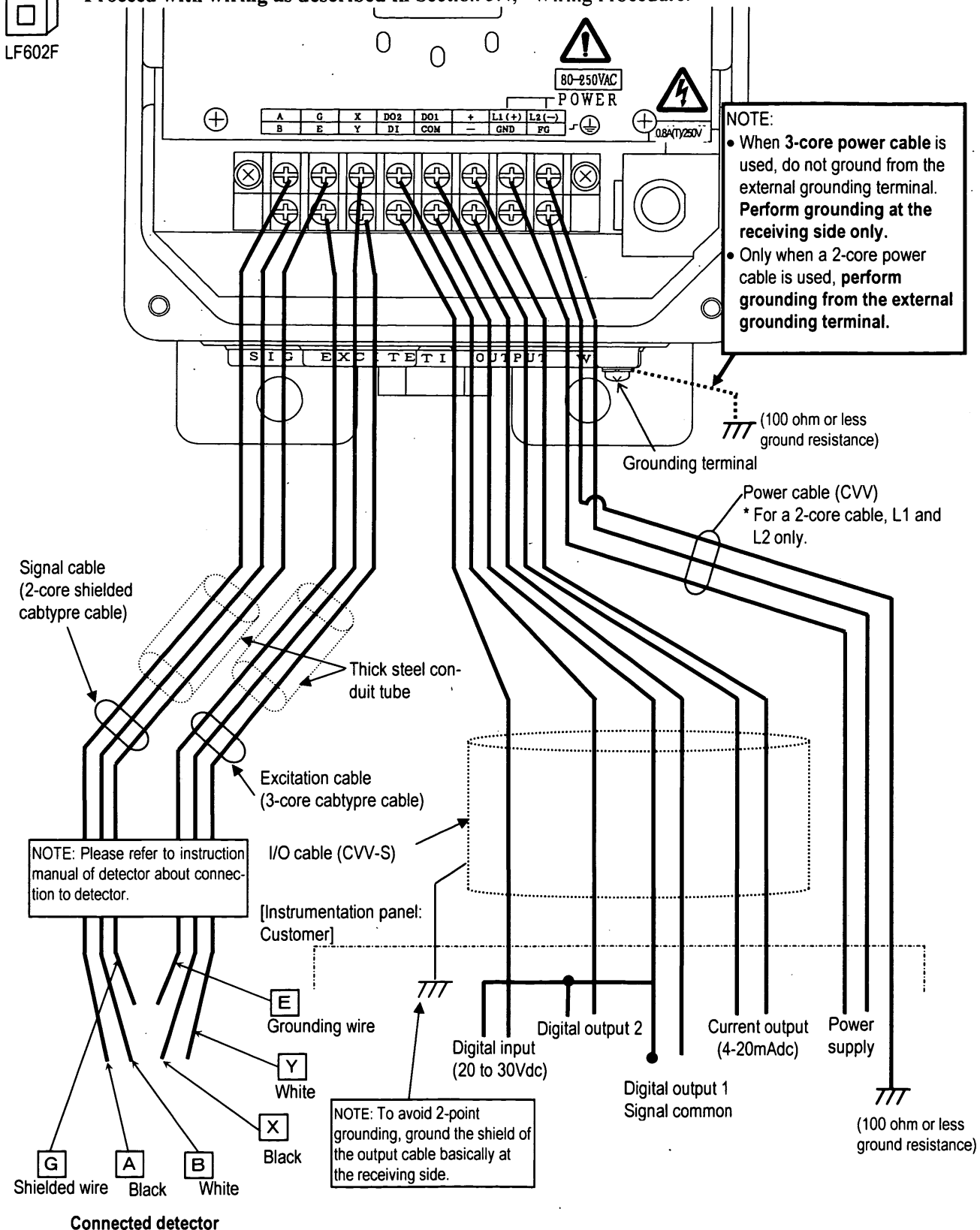

Figure 5.2 External Wiring Schematic Diagram

5.3 Notes on Wiring

5.3.1 Notes on Instrumentation-Converter Wiring

- To avoid 2-point grounding, **ground the shield of output cable basically at the receiving side.**
- Use a grounding wire of IV wire 5.5mm² or more. The size of the external grounding terminal screws is M4. **Do not share a grounding wire with other instruments where grounding current may flow. (An independent grounding is preferable.)**
- Power cable
When a 3-core cable is used: **Ground with the FG terminal.**
When a 2-core cable is used: Use an external grounding terminal and make the cable as short as possible.
Note that, for a replacement from the Toshiba electromagnetic flowmeter converter LF220 type, the cable grounding position differs.



LF602F

5.3.2 Notes on Wiring of the LF602F Type

- The detector is shipped with a flow rate signal cable and excitation cable. Be sure to use those cables coming with the detector.
Note: When the cable length exceeds 30m, cables may not be supplied. Check whether the cable is supplied with the specs.
- The allowable cable length between the detector and converter varies depending on the conductivity of the operating fluid. **Refer to the instruction manual of the combined detector.**
- When connecting with the detector, wire the cables in the order of the excitation cable and flow rate signal cable.
- Because the input cables transmit very delicate signals, pass the excitation cable and input signal cable **separately through a thick steel conduit tube, keep them away from the large current wiring as far as possible, and do not install them in parallel.**
- When replacing the flow rate signal cable and excitation cable, also refer to the instruction manual of the relevant detector. Order the detector terminal box cover packing from Toshiba or a Toshiba distributor.

5.4 Wiring

IMPORTANT

The cable glands is not provided in the conduit port of this apparatus.
Please prepare yourself for the cable glands which could be used in Division2 hazardous locations.

⚠ CAUTION

■ Do not wire cables and replace parts when power is supplied.



DON'T

Wiring work and replacing parts in the power-on state may cause electric shock.

■ Do not work on piping and wiring with wet hands.



DON'T

Wet hands may result in electric shock.

5.4.1 Grounding



(1) Grounding the LF600F type

Ground as shown in Figure 5.3. Make the grounding wire as short as possible. Use **grounding wire material of IV wire 5.5mm² or more**. Do not share a grounding wire with other instruments where grounding current may flow. (An independent grounding is preferable.)

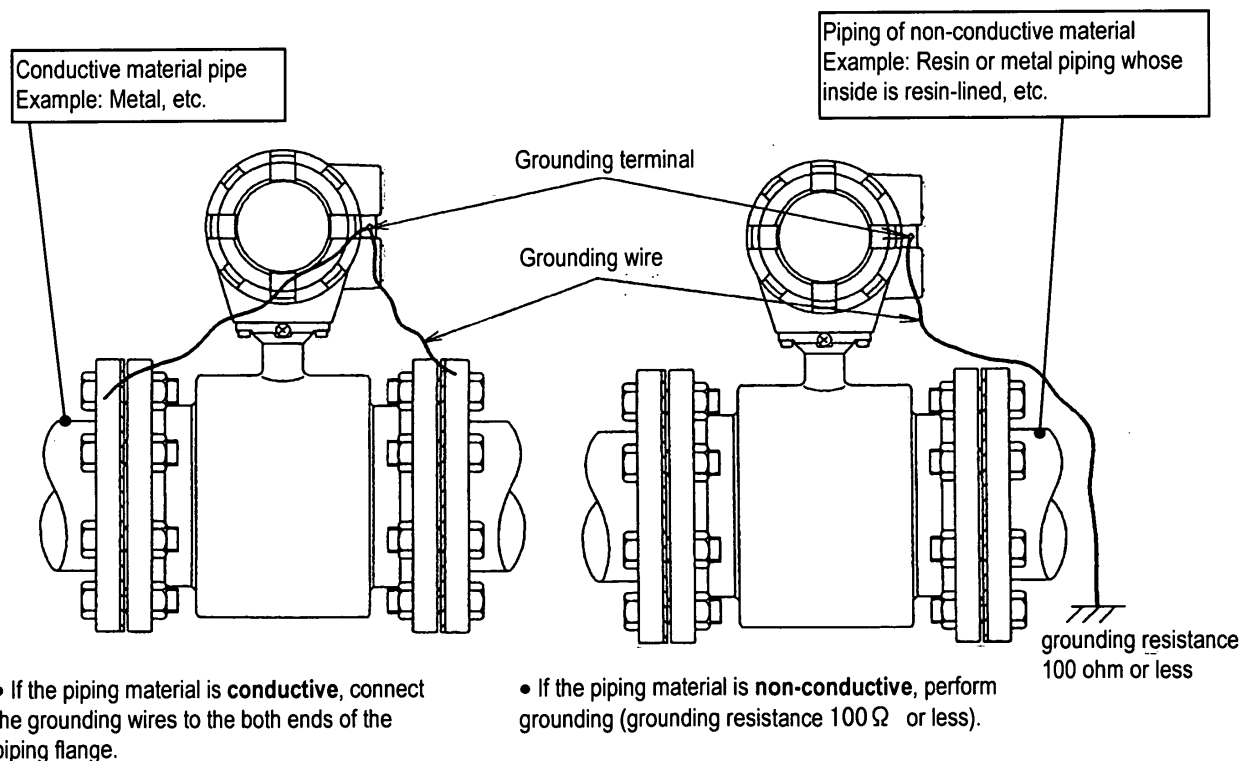

Figure 5.3 Grounding the LF600F Type



(2) Grounding the LF602F type

Ground the external grounding terminal of the detector and the FG terminal of the converter (or external grounding terminal of the converter) securely (**grounding resistance 100Ω or lower**). Use grounding wire material of **IV wire 5.5mm² or more**. **Do not share a grounding wire with other instruments where grounding current may flow. (An independent grounding is preferable.)**

If it is difficult to perform grounding work at the detector side because of a pit installation or other reasons, use a 3-core cable for the excitation cable and connect the E terminal of the detector to the E terminal of the converter. (The E terminal of the converter is internally connected with the FG terminal and the converter case.)

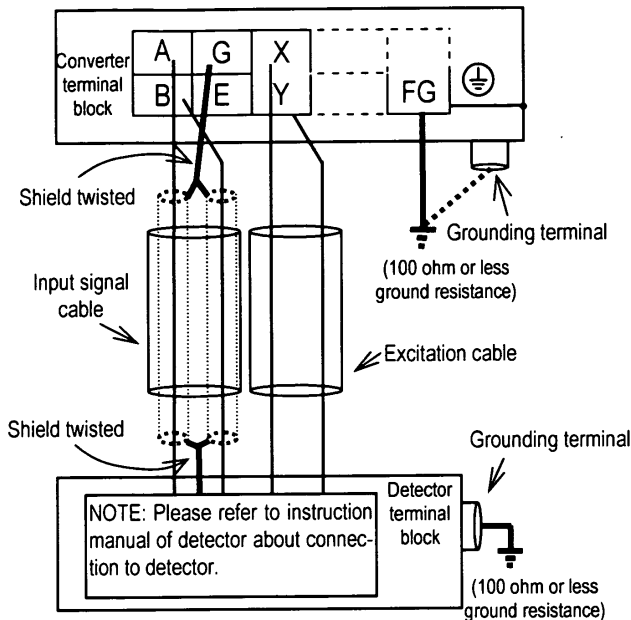

Figure 5.4 (a)

Wiring between Detector and Converter (For grounding the detector, see Figure 5.5 below.)

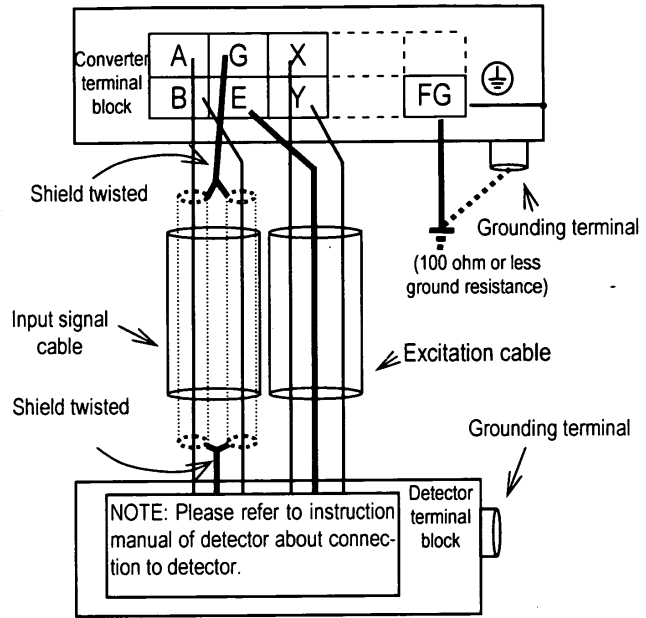
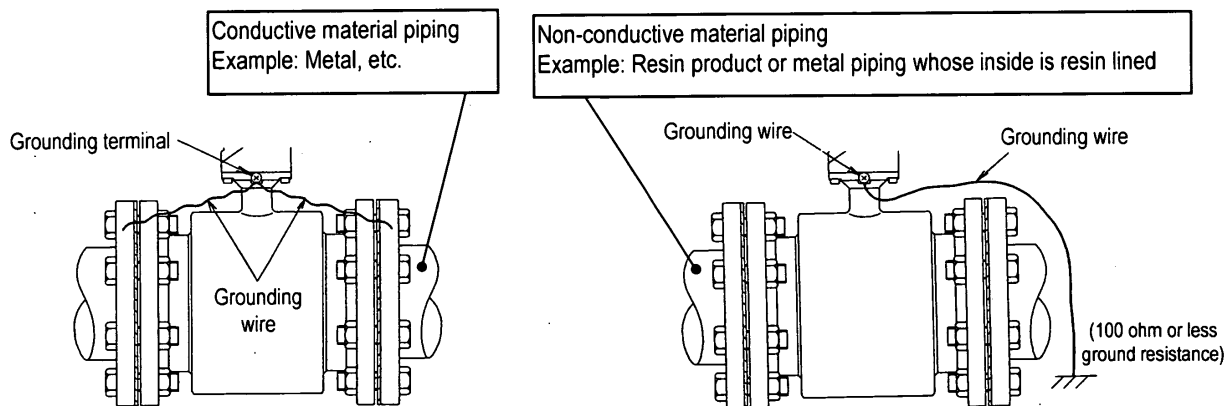

Figure 5.4 (b)

Wiring between Detector and Converter (when grounding of the detector is difficult)



- If the piping material is **conductive**, connect the grounding wires to the both ends of the piping flange.

- If the piping material is **non-conductive**, perform grounding resistance 100Ω or less.

Figure 5.5 Grounding the Separate Type Detector

5.4.2 Terminal Treatment of Cables

Follow the procedures below to treat the terminals (at the converter side) of various cables and install the cables to the terminal block. Use appropriate cables based on the description in Section 5.1 "Cables." Crimp a **round type insulated crimp-type terminal** to the end of the cables.

(1) Power cable, current output cable, digital I/O cables

The necessary cables should be ordered from the person responsible for the installation. Strip the sheath of each conductor as shown in Figure 5.6 and attach a crimping terminal with insulated sleeve to it. The size of the crimping terminal is as follows:

Integral type **LF600F: M4**

Separate type **LF602F: M3.5**

- Connect the power cable to terminal blocks L1 and L2.
- Connect the current output cable to terminal blocks + and -.
- Connect the digital I/O cable to terminal blocks D1, D01, D02 and COM, as required.

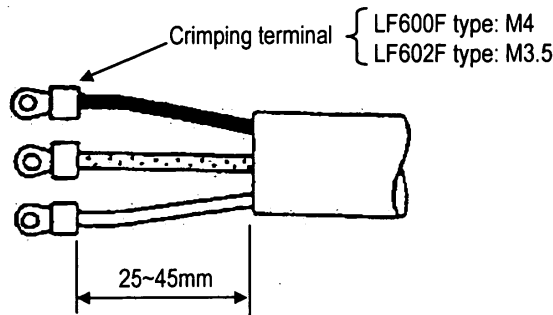

Figure 5.6 Terminal Treatment of Power Cable, Current Output Cable and Digital I/O cable



(2) Excitation cable

Strip the sheath from the end of each conductor as shown in Figure 5.7, attach an M3.5 crimping terminal with insulated sleeve, and connect it to the terminal blocks X and Y. Connect the red conductor to terminal block E.

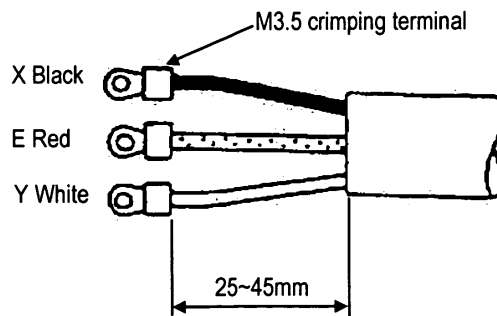

Figure 5.7 Terminal Treatment of Excitation Cable



(3) Connecting the input signal cable:

Strip the sheath from the end of each conductor of a 2-core individually shielded cable as shown in Figure 5.9. Twist those shields and cover them with a thermal contraction tube or vinyl tube not to make contact with the case or core wires. Then attach an M3.5 crimping terminal with insulated sleeve as shown in Figure 5.8. Connect a crimping terminal to the A and B terminals on the terminal block and connect to each G terminal of the detector and converter.

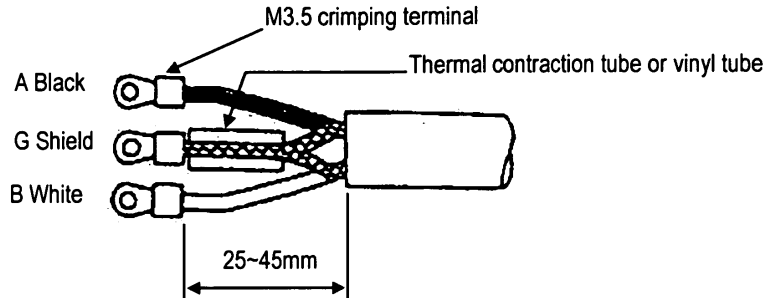
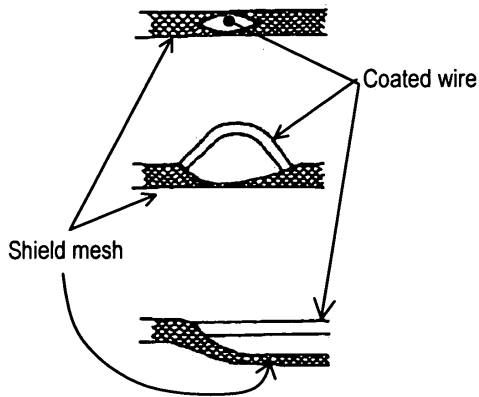

Figure 5.8 Terminal Treatment of Flow Rate Signal Cable

● **Notes on signal cable shield processing work**

When stripping an external sheath, intermediate and insulated sheath, be careful not to scratch or cut the internal conductors and shield mesh. Do not disjoint the shield mesh but treat it as shown in Figure 5.9.



- a. Open the shield mesh with a pincette or the like.
- b. Pull out the internal coated wires from the hole of the shielded mesh.
- c. Pull out all internal coated wires and extend the shield mesh wire.

Figure 5.9 Treating the Signal Cable Shield Mesh

5.4.3 Cable Connection

(1) Connect and install the terminal-treated cables to the terminal block.

*Connect the cables to the terminal block securely. A loose connection may cause incorrect measurement. After connecting a cable, try to pull it to check whether it has been connected securely.

Referring to Section 5.2 "External Device Connections and Grounding", connect each cable to the terminal block. **Tighten the screws of the terminal block tightly to ensure the secure connection.** A loose connection may cause incorrect measurement. **After connecting a cable, try to pull it to see whether it has been connected securely.**

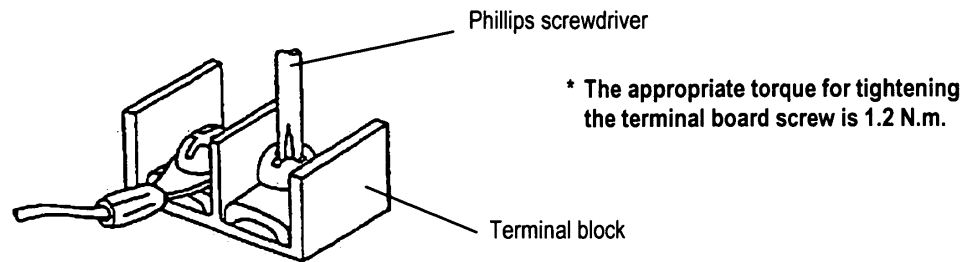

Figure 5.10 Connecting a Cable to Terminal Block

5.5 Digital I/O Connections

Digital I/O terminals consist of contact output terminals (DO1 and DO2), voltage signal input terminal (DI, optional), and signal common terminal (COM). Each terminal (DO1, DO2 and DI) is isolated from internal circuits. Terminal (COM) is the signal common for the other three terminals (DO1, DO2 and DI).

Functions can be assigned for each terminal with the LCD control keys. See **Chapter 10, "Digital I/O Functions."**

To connect an electromagnetic relay or counter to the contact output terminal (DO1 or DO2), put a surge-absorbing diode into the input circuit of the relay or counter. See Figure 5.11 for an example of electromagnetic counter connection.

*1...Digital output D02 and voltage signal input DI are optional.

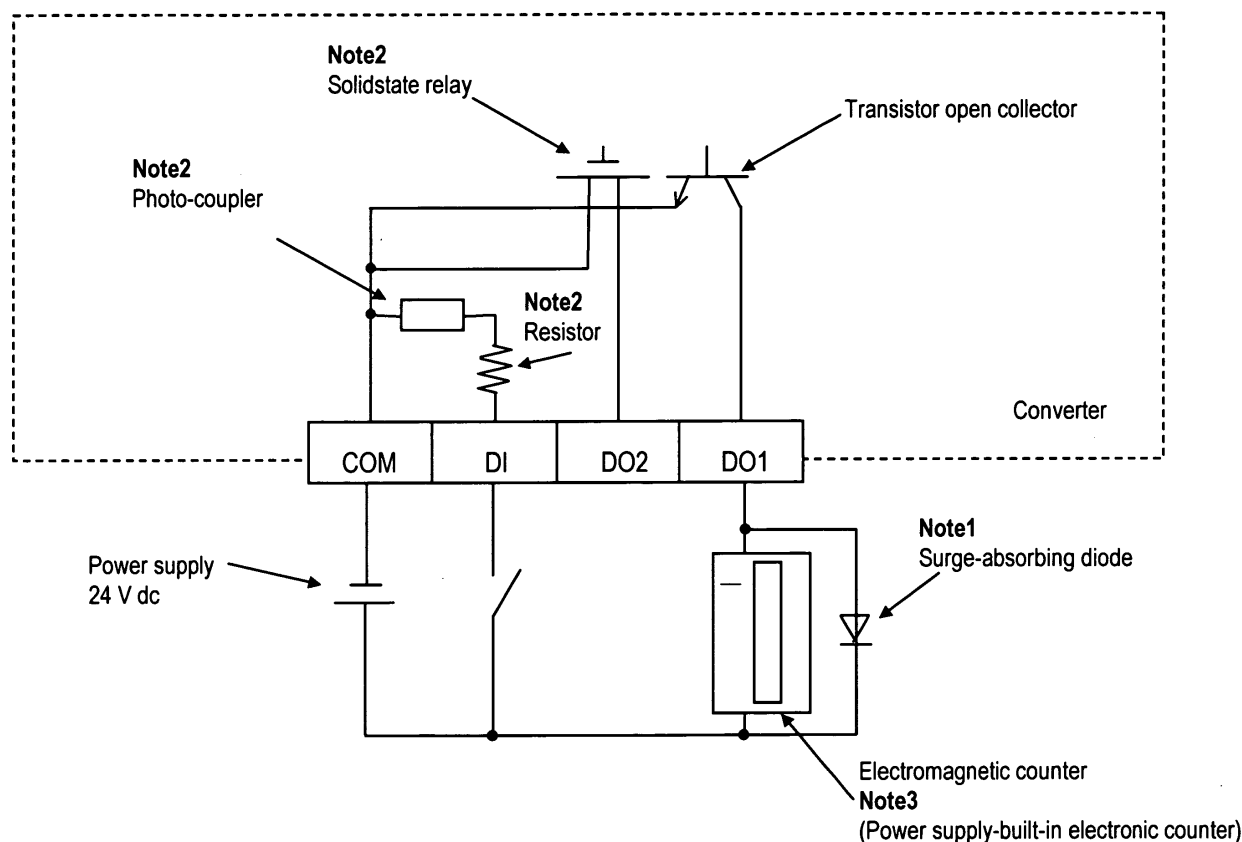





Figure 5.11 Electromagnetic Counter Connection Example

- Note 1:** Use a surge-absorbing diode of the rating: **current rating 1A and voltage rating 200 V minimum.**
- Note 2:** In the case of standard specification (digital input DI, no output DO2), the semiconductor contact point, photo coupler and resistor are not built in. Leave DI and DO2 disconnected.
- Note 3:** **When a power supply-built-in electronic counter is used, the surge-absorbing diode is not required.**

6. Operation

 CAUTION	
<ul style="list-style-type: none"> ■ Do not touch the terminal board when power is supplied. <div style="display: flex; align-items: center;">  <p style="margin: 0;">Touching the terminal board when power is supplied can cause electric shock.</p> </div> <p style="text-align: center;">DON'T</p>	<ul style="list-style-type: none"> ■ Do not touch the main body when high temperature fluid is being measured. <div style="display: flex; align-items: center;">  <p style="margin: 0;">The fluid raises the main body temperature and can cause burns.</p> </div> <p style="text-align: center;">DON'T</p>

6.1 Preparatory check

Follow the procedure described below to prepare before starting the flow measurement (described with regard to the entire flowmeter).

System Check

Check the items listed below

- Check the wiring between the converter and related instruments.
- Make sure all the bolts of connection flanges on which the flowmeter is mounted securely tightened.
- Make sure the direction of flow arrow is in accordance with actual flow.
- Make sure the flowmeter is grounded with 100 ohm or less ground resistance.
- Make sure the converter housing covers are securely tightened.

Placing System On-Stream

- Let the fluid go through the detector pipe. (Note 1)
- When the detector is filled with the fluid, stop the fluid and keep it still in the detector pipe.

Supplying Electric Power

- Make sure the power supply is as specified.

Checking Converter Parameters

- Check the configuration parameter settings. Refer to Chapter 7, "LCD Display and Controls," Chapter 8, "Configuration Parameter Setting," and Chapter 11, "Communications Function."

Zero Adjustment

- Wait for 30 minutes to warm up the flowmeter. Then making sure the fluid holds still in the detector pipe, starts the zero adjustment.
- Refer to 6.2, "Zero Adjustment."

On-line measurement

- After checking the items and conducting the zero adjustment as listed above, let the fluid go through the detector pipe. Output (4–20 mA dc) directly proportional to the flow rate can be obtained.

Note 1: If the detector pipe is not filled with the fluid to be measured, the flow rate will be indefinite and unable to be measured. Before using the flowmeter, be sure to fill the detector pipe the fluid to be measured.

6.2 Zero Adjustment

To conduct zero adjustment of the flowmeter, the fluid in the detector pipe must be held still.

There are three different ways to start the zero adjustment:

- (1) **Pressing a combination of control keys for the model with LCD display**
See 8.2.19 "Still Water Zero Adjustment"
- (2) **Sending a command signal from a HART communications device (a communication device such as hand-held terminal AF900 is required)**
See the instruction manual of hand-held terminal you use.
- (3) **PROFIBUS communication (a communication device for PROFIBUS is required)**
See the instruction manual of communication device you use.

7. LCD Display and Controls

7.1 Name and Function of Each Part of LCD Display

The LDC display and infrared switches (hereafter, called "control key") in front of the converter allows you to view or set various constants such as measured values and parameters.

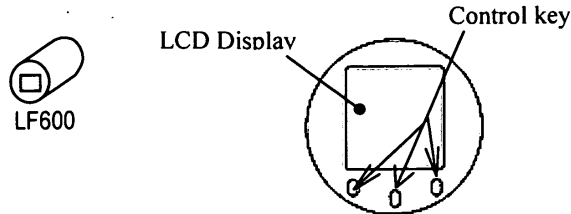

Figure 7.1 Display section of LF600

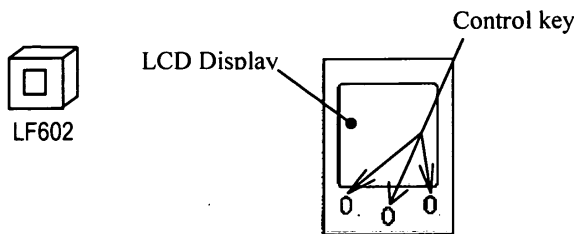

Figure 7.2 Display section of LF602

Instructions

The operation principle of infrared switch is to irradiate infrared to the front of control panel and detect the reflection from finger when operating.

Normal operation is impeded depending on the conditions such as disturbing light from surroundings or stain attached to the control panel. When unable to avoid such condition, operate the EMF converter in the following manner.

Remove the factor to impede proper operation of infrared switch as below:

- Cover the control panel by hand so that light does not shine on it
- Clean the stain attached on the control panel
- Clean the stain on the finger or the gloves to operate the EMF converter, or wear gloves in light color
- When there is a reflecting object placed opposing to the control panel, stand in-between the reflecting object and the control panel to block the light

Following are considered as the factors to impede infrared switch to operate properly.

- Intense light such as direct sunlight and reflected sunlight by window glass or metal plate
- Place where brightness changes always such as ON/OFF of lighting
- Dense smoke or steam near the control panel
- Those attached on the control panel such as rain (dew drop), snow, ice, mud and oil, and haze due to their attachment
- Operation of the control panel by hands wearing gloves in dark color or stained fingers and gloves
- Light reflecting object near the control panel, or reflecting object such as metal plate placed opposing to the control panel

● **LCD display**

An 8-line × 14-character liquid crystal display. The backlit display enables an easy-to-read indication even under poor lighting conditions. Instantaneous flow rates or totalized flow in the measurement mode, or configuration parameters in the setting mode can be displayed. (Number of LCD display dots: 128 x 128 dots)

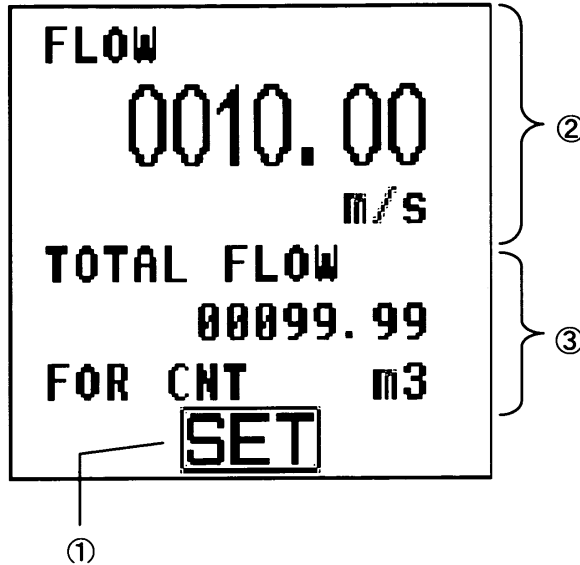

① **Control key indicator**

Indicates the function (on the current screen) of the key switches around the LCD. This indicator is usually turned off. It turns on when you hold down any of the three control keys for 3 seconds or longer.

② **Measured value main display**

Displays a measured value of the type the operator has selected. In the main display, a numeric value is displayed in large size.

③ **Measured value sub display**

Displays a measured value/setting value of the type the operator has selected. Or displays an error message. When an error message is displayed, no measured value/setting value is displayed (error message-precedence display).

● **Setting switch**

The control keys allow you to perform converter control and setting, without opening the converter housing.

These three controls keys function differently depending on the current display screen.

The functions of these control keys are displayed on the display screen.

In this product, the display method can be changed according to the converter installation direction. For example, if the control keys are installed so that they are located above the display, they can be displayed appropriately as shown below, by changing the display method.

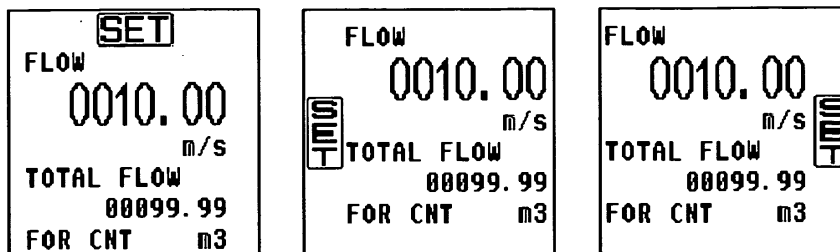

Above the control keys Left of the control keys Right of the control keys

7.2 Display Format

In the measurement mode, measured data is displayed for the item set by the main display setting (MAIN DSP) and sub display setting (SUB DSP).

(For display setting, see 8.1.5 "Display Setting.")

[Format of main display]

• Flow rate value display

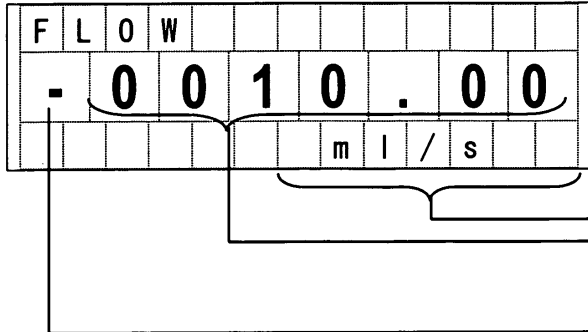

Unit: The unit is displayed right aligned (up to 7 digits)
 Numeric value: Up to 7 digits including a decimal point are displayed. (Up to 9999999)
 4 significant digits: For the set span
 Flow direction: When the flow direction is forward direction, " " (blank) is displayed. When the flow direction is reverse direction: "-" is displayed.

• Total count value display

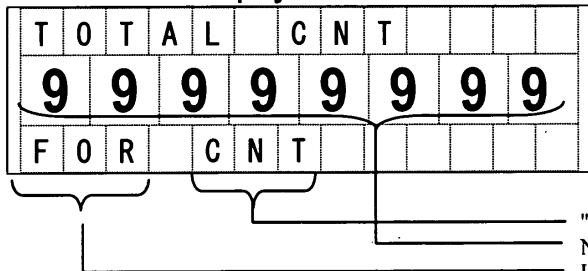

"CNT" is displayed during total counting.
 Numeric value: Up to 99999999.
 In the case of forward flow direction, "FOR" is displayed.
 In the case of reverse flow direction, "REV" is displayed.

• Total flow value display

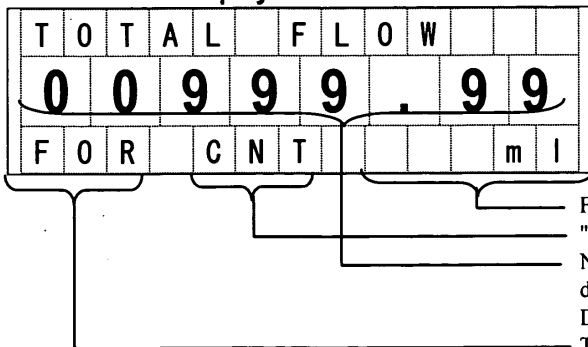

Flow rate unit: Displayed right aligned (up to 5 digits).
 "CNT" is displayed during total counting.
 Numeric value: Up to 8 digits including a decimal point are displayed. (Up to 99999999)
 Displayed to the least significant digit of the set pulse rate.
 Total value for the forward flow direction: "FOR" is displayed.
 Total value for the reverse flow direction: "REV" is displayed.

• Total difference flow value display

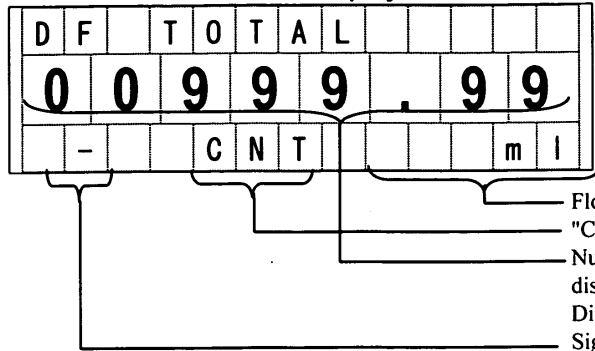

Flow rate unit: Displayed right aligned (up to 5 digits).
 "CNT" is displayed during total counting.
 Numeric value: Up to 8 digits including a decimal point are displayed. (Up to 99999999)
 Displayed to the least significant digit of the set pulse rate.
 Sign: When the difference flow rate is in the forward direction: + (plus) display
 When the difference flow rate is in the reverse direction: -(minus) display

Note: The total flow value and the total difference flow value are displayed to the least significant digit of the set count rate.

Example: When the set count rate is 0.0001 m^3

The total flow / total difference flow display becomes 000.0000m^3 and the value increases in the unit of 0.0001 m^3 .

If the values reaches 999.9999 m^3 , the display changes to 1000.000 m^3 at the next count

In the end, the display becomes 99999999 m^3 .

When the set count rate is 10 m^3

The display becomes 00000000 m^3 and the value increases in the unit of 10 m^3 .

• Percent display

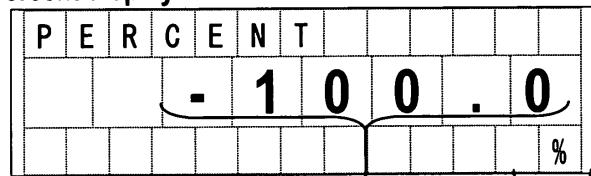

Unit: Fixed to "%".
 Numeric value: A percent value of max.125.0% is displayed.
 Displayed to one decimal place (0.1%).
 The sign position is fixed.

• Custom value display

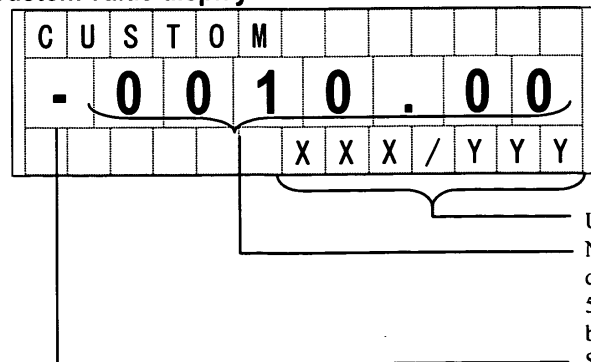

Unit: The unit consists of a maximum of 7 digits.
 Numeric value: Up to 7 digits including a decimal point are displayed. (Up to 9999999)
 5 significant digits: value obtained by multiplying m^3/min by the set coefficient
 Sign:
 In the case of forward direction: "+"
 In the case of reverse direction: "-"

• Range display

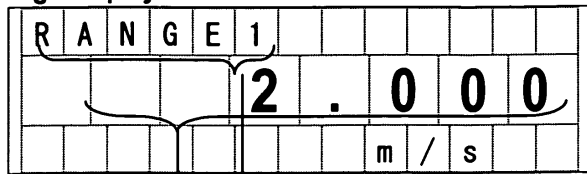

Unit: Displayed right aligned (up to 7 digits)
 Numeric value: Span value of the range used.
 Range used

In the range display, the range currently being used is displayed (any one of ranges 1 to 4). The screen example above shows that range 1 is currently being used.

If multiple ranges have been set, the range displayed is switched automatically as the range used is changed.

• During communication

During HART communication, a mark is displayed in the rightmost column of the item name display field in the main display section. During PRFIBUS communication, nothing is displayed.

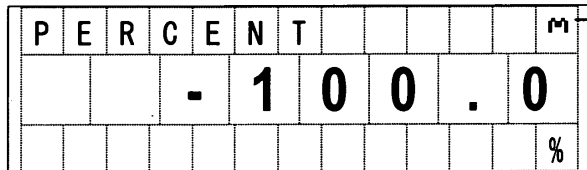

Displayed during HART communication.

[Format of sub display]

• Flow rate value display

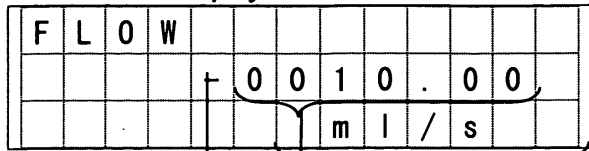

Unit: The unit is displayed right aligned (up to 7 digits).
 Numeric value: Up to 7 digits including a decimal point are displayed.
 (Up to 9999999)
 4 significant digits: For the set span
 Flow direction:
 Forward direction: " W"(blank) is displayed.
 Reverse direction: "-" is displayed.

• Total count value display

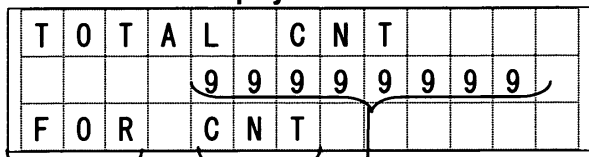

"CNT" is displayed during total counting.
 Numeric value: Up to 99999999
 In the case of total value for the forward flow direction, "FOR" is displayed.
 In the case of the total value for the reverse flow direction, "REV" is displayed.

• Total flow value display



Flow rate unit: Displayed right aligned (up to 5 digits).
 "CNT" is displayed during total counting.
 Numeric value: Up to 8 digits including a decimal point are displayed.
 (Up to 99999999)
 Displayed to the least significant digit of the set pulse rate.
 In the case of total value for the forward direction, "FOR" is displayed.
 In the case of total value for the reverse direction, "REV" is displayed.

• Total difference flow value display

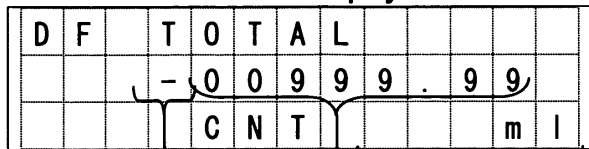

Flow rate unit: Displayed right aligned (up to 5 digits).
 "CNT" is displayed during total counting.
 Numeric value: Up to 8 digits including a decimal point are displayed.
 (Up to 99999999)
 Displayed to the least significant digit of the set pulse rate.
 Sign: When the difference flow rate is for the forward direct: + (plus) display. When the difference flow rate is for the reverse direction: - (minus) is displayed.

• Percent display

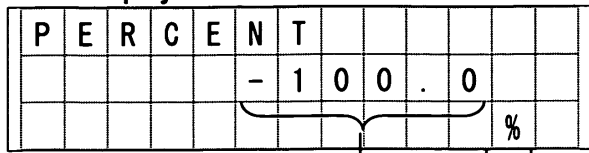

Unit: Fixed to "%".
 Numeric value: A value of 125.0% to -125.0 is displayed.
 Displayed to one decimal place (0.1%).
 The sign position is fixed.

• Range display

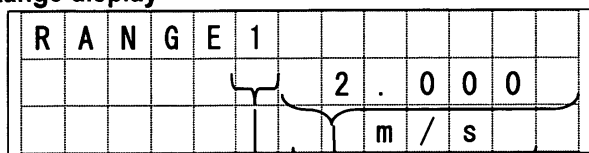

Unit: Displayed right aligned (up to 7 digits).
 Numeric value: Span value of the range used
 Range used

In the range display, the range currently being used is displayed (any one of ranges 1 to 4). The screen example above shows that range 1 is currently being used.

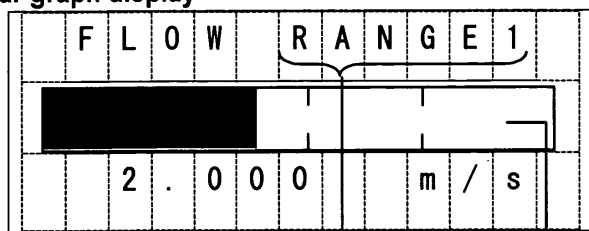

If multiple ranges have been set, the displayed range is switched automatically as the range used is changed.

• Bar graph display

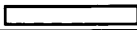

The measured value is displayed as a bar graph (12 digits, 100 dots).
 The left of the graph is RL and the left of the graph is RH.
 a scale is displayed in increments of 25% inside the graph.
 Range unit.
 Range H: Span value of the range currently being used.
 Display of the range used

* In the percent value display in the case of range type, percent display, and graph indication, the % value to be displayed depends on the flow direction. However, the % value in the graph indication is displayed as shown in the table below.

Range type	Input signal	% value in percent display	% value in graph display	4-20mA output
Forward direction only	Forward direction 50%	50%	50% 	12mA
Forward direction only	Reverse direction 50%	- 50%	0% 	4mA (lower limit)
Forward/Reverse	Forward direction 50%	50%	50% 	12mA
Forward/Reverse	Reverse direction 50%	- 50%	50% 	12mA

• Custom value display

C	U	S	T	O	M												
				-	0	0	1	0	.	0	0						
					X	X	X	/	Y	Y	Y						

Unit: The unit consists of max.7 digits.
 Numeric value: Up to 7 digits including a decimal point are displayed.
 (Up to 9999999)
 5 significant digits: Value obtained by multiplying m3/min by the set coefficient.
 Sign: "+" for the forward direction, "-" for the reverse direction.

7.3 Basic operations

7.3.1 Mode Change

The converter provides the setting mode and calibration mode, in addition to the measurement mode. When you want to move to the setting mode or calibration mode, use the "SET" key. To return to the measurement mode, select "MEAS MODE" from menu items (A to N).

Measurement mode:

measures the process flow and displays and outputs the measured process values. The flowmeter can measure the flow velocity, flow rates, or totalized flow. The flowmeter first goes into this mode when power is turned on.

Setting mode:

used to check or change various configuration parameters used in the measurement mode. These parameter values are displayed while checking or changing these values but the flowmeter outputs the measured process values as in the measurement mode. See 7.4, "Configuration Items Selection Table" and 8.2, "Checking or Changing Parameters" for details. Configuration items are from A1, A2, A3 to M1.

Calibration mode:

used to check the converter internal circuits. The internally generated simulation signal is used to check the measuring span and excitation current value. The current output of the flowmeter changes in accordance with the simulation signal. The status of each digital output is held to the value just before the system moved into the calibration mode. See 7.4, "Configuration Items Selection Table" and Chapter 9, "Calibration" for details. Configuration items are from N1 to N4.

○Change mode flow

[SET] [SEL] [ENT] in the flow chart describe the switch operation, and by pressing the switches described below, you are allowed to move to the items, which are directed by arrows. →

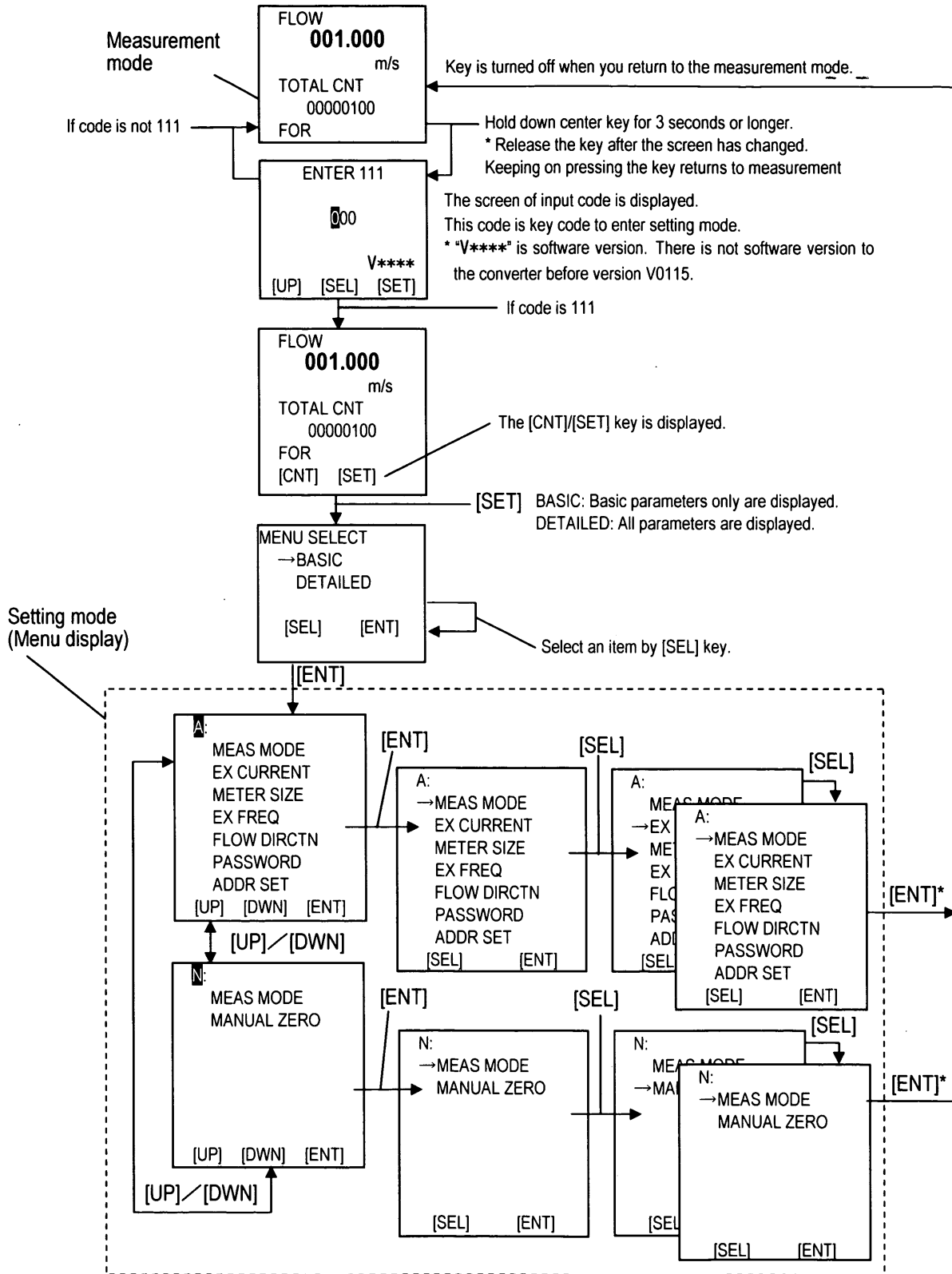

* When the mode shifts to measurement mode from setting mode, confirmation message is displayed. You can cancel operation then.

○Mode switching

The electromagnetic flowmeter usually operates in the measurement mode.

When you need to perform parameter setting, calibration and adjustment, you enter the setting mode.

To enter the setting mode, hold down center key for 3 seconds or longer.

Holding down the desired key for 3 seconds or longer will display screen of code input. When "111" was input with this screen, [SET] and [CNT] (for switch operation) are displayed in the measurement screen. When the code except "111" was input, label is not displayed.

Please operate it as follows after label was displayed.

[SET] key	You enter the setting mode (the menu configuration setting screen is displayed).
[CNT] key	The screen is switched to the total count control screen, enabling you to manipulate the total counter.

Note: If password has been set, the password input screen appears when you move from the measurement mode to the menu configuration setting screen (when you press the [SET] key) and when you move to the total count control screen (when you press the [CNT] key).

If the password you enter does not match, you will be unable to change some of the parameters. Also you will be unable to clear the total count when you are manipulating the total counter.

○Function of operation time-out

When a converter is state of the setting mode, and there is not operation more than 1 minute, mode returns to the measurement mode automatically.

Menu display	A: MEAS MODE →EX CURRENT METER SIZE EX FREQ FLOW DIRECTN PASSWORD ADDR SET [SEL] [ENT]	Mode returns to the measurement mode automatically
Parameter confirmation display	A1: EX CURRENT 0.19000 A [EXT] [ENT]	
Parameter change display	A1: EX CURRENT 0.1900 A [UP] [SEL] [SET]	Mode does not return to the measurement mode

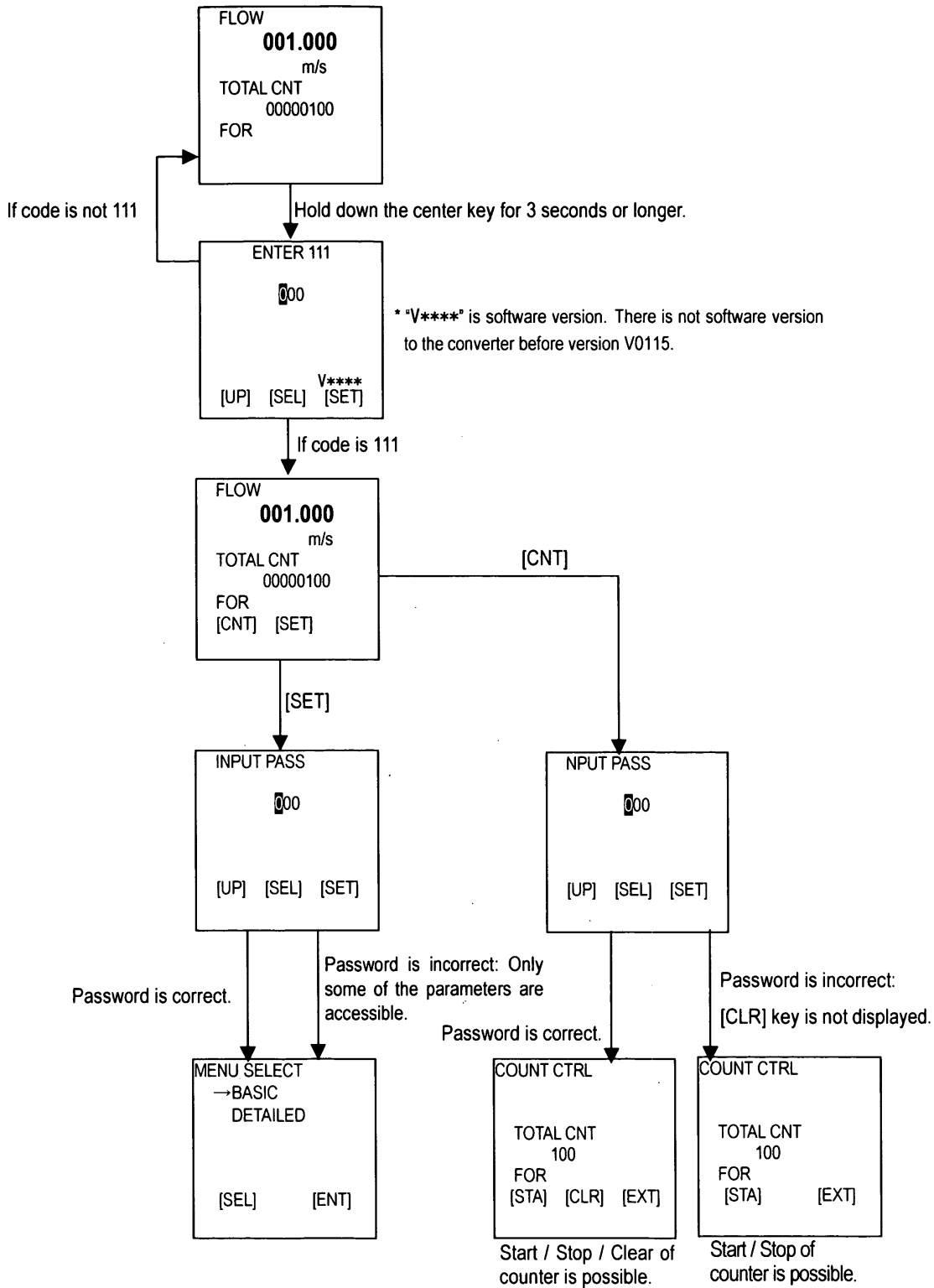

7.3.2 Setting and Calibration

Process as follows to select the desired items, to check or change the item setting value.

“Key operation” indicates the key to be pressed.

When you are incrementing the numeric counter by pressing the [UP] key or when you are incrementing or decrementing the numeric and alphabet counter by pressing the [UP] key/[DWN] key, you can perform continuous operation by holding down the relevant key (Holding down the key causes the numeric or alphabetic character count to be increased/decreased).

● Moving to the menu display

Key operation	Display example	Description
	FLOW 002.000 m/s RANGE1 5.000 m/s [CNT] [SET]	Measured value being displayed (measurement mode)
[SET]	MENU SELECT →BASIC DETAILED [SEL] [ENT]	Pressing the [SET] button when you are in the measurement mode takes you to the menu configuration selection screen. Select BASIC or DETAILED configuration.
[ENT]	A: MEAS MODE EX CURRENT METER SIZE EX FREQ FLOW DIRCTN PASSWORD ADDR SET [U P] [DWN] [ENT]	Pressing the [ENT] key in the menu configuration selection screen takes you to the menu display screen. The cursor is positioned on an alphabetical character representing a group name ([A] in this example). * This screen is an example of display that appears when you select the DETAILED menu.
[UP]	B: MEAS MODE MAIN DISP SUB DISP CUSTOM DATA CUSTOM UNIT LCD ADJUST SW POSITION [U P] [DWN] [ENT]	Pressing the [UP] key when the cursor is positioned on an alphabetical character causes the alphabetical character to be incremented. (Pressing the [DWN] key causes the alphabetical character to be decremented.) In addition, the display contents are switched to the menu list associated with the alphabetical character.
[ENT]	B: MEAS MODE →MAIN DISP SUB DISP CUSTOM DATA CUSTOM UNIT LCD ADJUST SW POSITION [SEL] [ENT]	When you press the [ENT] key, the cursor on the alphabetical character disappears and an arrow mark is displayed in the item list display field. In addition, the [UP] key changes to the [SEL] key.
[SEL]	B: MEAS MODE MAIN DISP SUB DISP CUSTOM DATA →CUSTOM UNIT LCD ADJUST SW POSITION [SEL] [ENT]	Every time you press the [SEL] key, the arrow mark comes down one line at a time. Pressing the [SEL] key further when the arrow mark is positioned on the bottom item line causes the arrow mark to return to the top item line.
[ENT]	B4: CUSTOM UNIT XXX/YYY [EXT] [ENT]	When you press the [ENT] key, the setting screen for the setting item that the arrow mark points to appears and enables you to set/check the parameter.

●Checking/setting of setting value

Key operation	Display example	Description
	C: MEAS MODE RANGE TYPE →RANGE 1 RANGE 2 RANGE 3 RANGE 4 RANGE HYS [SEL] [ENT]	Menu display for group C Use the [SEL] key to move the arrow mark to RANGE 1.
[ENT]	C2: RANGE1 2.000 m/s [EXT] [ENT]	Use the [ENT] key to select the item you want to check/change. The screen is changed to a screen where the current setting value is displayed, enabling you to check the setting value. Pressing the [EXT] key will return you to the menu screen.
[ENT]	C2: RANGE1 2.00000 m/s [U P] [SEL] [SET]	When you press the [ENT] key, the cursor appears on the setting value and you are ready to change the setting value.
[UP]	C2: RANGE1 3.00000 m/s [U P] [SEL] [SET]	Ready to change the setting value. Pressing the [UP] key increments the numeric character in the place where the cursor is currently positioned. (Holding down this key causes the increment operation to be continued.) * Pressing the [UP] key when the cursor is positioned below the unit will change the unit to the next one. In addition, when you set a natural number, a decimal point appears in addition to numeric characters (except for the most significant digit).

Key operation	Display example	Description
[SEL]	C2: RANGE1 3.00000 m/s [U P] [SEL] [SET]	Ready to change the setting value. Pressing the [SEL] key causes the cursor to move to the next digit.
[UP] [SEL]	C2: RANGE1 5.00000 m/s [U P] [SEL] [SET]	Ready to change the setting value. You can change the setting value by using the [UP] and [SEL] keys. In this example, 5.000 m/s is selected.
[SET]	C2: RANGE1 5.00000 m/s OK? [N O] [SET]	Pressing the [SET] key causes the data to be set temporarily. The cursor disappears and a confirmation message is displayed.
[NO]	C2: RANGE1 2.00000 m/s [U P] [SEL] [SET]	If you want to cancel the data change here, for example, because the temporarily set data is incorrect, press the [NO] key, which causes the temporarily set data to return to the original setting value and enables you to change the setting value again.
[SET]	C2: RANGE1 5.000 m/s [EXT] [ENT]	Pressing the [SET] key when data is temporarily set causes the data to be determined and set. After the data is set, the cursor disappears, enabling you to check the setting value. *In the case of the flow velocity unit, the value is automatically rounded to 3 decimal places. In the case of the actual flow rate unit, the value is automatically rounded to 3 significant digits.
[EXT]	C: MEAS MODE →RANGE TYPE RANGE 1 RANGE 2 RANGE 3 RANGE 4 RANGE HYS [SEL] [ENT]	Pressing the [EXT] key returns you to the menu display screen.
[SEL] [ENT]	C: MEAS MODE OK? [N O] [SET]	By pressing the [SEL] key to move an arrow mark to MEAS MODE and pressing the [ENT] key, confirmation message is displayed. If [NO] key is pushed, operation of shift to measurement mode is canceled.
[SET]	FLOW 002.000 m/s RANGE1 5.000 m/s	By pressing the [SEL] key, you can terminate the setting mode and return to the measurement mode.

7.4 Configuration Items Selection Table

The check/change menu for each constant to be set for the converter is expanded as shown in the table below.

Details of each item are described in the configuration items (A to M) in Chapter 8 "Configuration Parameter Setting."

○ Basic configuration (when the menu configuration is BASIC)

When you select "BASIC" in the menu configuration selection screen, the check/change menu for each constant setting is expanded as shown in the table below.

	0	1	2	3
B	Return to the measurement mode	Main display setting	Sub display setting	
C		Range type	Range 1	
D		Damping constant	Low cut value	
F		Digital output 1	Digital output 2	Digital input 1
G		Count rate	Pulse width Setting mode	Pulse width

When the operation mode is switched from the measurement mode to the setting mode, group B is displayed first in the case of basic configuration. >

After that, the screen changes as follows:

Group B (start screen) ⇔ Group C ⇔ Group D ⇔ Group F ⇔ Group G ⇔ Group B

→:When the [U P] key is pressed (the group is incremented).

←:When the [DWN] key is pressed (the group is decremented).

○ Detailed configuration

When you select "DETAILED" in the menu configuration selection screen, the check/change menu for each constant setting is expanded as shown in the table below.

	0	1	2	3	4	5	6
A	Return to the measurement mode	Exciting current setting *1	Meter size *1	Exciting frequency *1	Flow direction setting *1	Password *1	Address setting *1
B		Main display setting	Sub display setting	Custom (coefficient) *1	Custom (unit) *1	LCD density adjustment	Switch position setting
C		Range type *1	Range 1 *1	Range 2 *1	Range 3 *1	Range 4 *1	Range hysteresis *1
D		Damping constant	Low cut value	Current output setting upon alarm occurrence *1	Display low cut Yes/No	Output low limit setting *1	
E		Still water zero point adjustment					
F		Digital output 1 *1	Digital output 2 *1	Digital input 1 *1	DO1 alarm output state *1	DO2 alarm output state *1	DI control signal level setting *1
G		Count rate *1	Pulse width setting mode *1	Pulse width*1			
H		Preset count value *1	Preset output setting *1				
I		High limit alarm ON/OFF *1	High limit value setting *1	Low limit alarm ON/OFF *1	Low limit value setting *1		
J		High high limit alarm ON/OFF *1	High high limit value setting *1	Low low limit value ON/OFF *1	Low low limit value setting *1		
K		Fluid empty alarm *1	Self-diagnosis Yes/No *1	Alarm output preset *1			
L		Limit rate	Limit time				
M		Fixed output *1	Fixed current *1	Fixed pulse *1			
N		Manual zero					
O		0% Flow value calculation *1	50% Flow value calculation *2	100% Flow value calculation *1	Exciting current display *2		

Note 1 If you enter a wrong password, you are allowed to check the setting value and to perform calibration for the items with *1 mark in the table. However you are not allowed to change the setting and perform calibration for these items.

Note 2 The items with*2, you are only allowed to check the calibration value.

Note 3 For function A2, you are only allowed to check the setting value.

7.5 Password input

The converter provides the password function to prevent some functions that affect the flow rate measurement from being set or adjusted. For the limited functions, see Chapter 5 "Items Protected with Password."

- * If a password '000' is set, the password input screen does not appear. If a password other than '000' is set, you can enter your password following the procedures below.
- * You can also use the following procedures to enter a password for releasing adjustment menu protection.

● An example of entering a password (when the password is 123)

Key operation	Display example	Description
	FLOW 002.000 m/s RANGE1 5.000 m/s [CNT] [SET]	The measured value being displayed (measurement mode)
[SET]	INPUT PASS 000 [UP] [SEL] [SET]	When you switch the measurement mode to the setting mode by pressing the [SET] key, the password input screen is displayed if the password has been set.
[UP]	INPUT PASS 100 [UP] [SEL] [SET]	Press the [UP] key to increment the digit in a place where the cursor is positioned (Holding down this key causes this increment operation to be continued.) In this example, 1 is set.
[UP] [SEL]	INPUT PASS 123 [UP] [SEL] [SET]	Pressing the [SEL] key changes the position of the cursor. By pressing the [UP] and [SEL] keys, change the password to 123.
[SET]	MENU SELECT →BASIC DETAILED [SEL] [ENT]	Pressing the [SET] key causes the password to be written and the menu configuration selection screen to appear. The menu configuration selection screen appears, regardless of whether the entered password is correct or wrong. However, if the entered password is wrong, you are not allowed to change the setting value or perform calibration. For more information, see Chapter 5 "Items Protected with Password."

8. Configuration Parameter Setting

8.1 Configuration Items

To check/change menu for each constant to be set for the converter, first select the desired configuration item as described in 7.3.2. The configuration items are listed below. See each section for detailed procedure.

No.	Function item	Display example
8.2.2	Exciting current setting	EX CURRENT
8.2.3	Meter size	METER SIZE
8.2.4	Exciting frequency	EX FREQ
8.2.5	Flow direction setting	FLOW DIRCTN
8.2.6	Password	PASSWORD
8.2.7	Address setting	ADDR SET
8.2.8	Display setting	MAIN DSP / SUB DSP
8.2.9	Custom coefficient setting	CUSTOM DATA
8.2.10	Custom unit setting	CUSTOM UNIT
8.2.11	LCD density adjustment	LCD ADJUST
8.2.12	Switch position setting	SW POSITION
8.2.13	Span (Range)	RANGE TYPE, RANGE1 (~RANGE4), RANGE HYS
8.2.14	Damping constant	DAMPING
8.2.15	Low cut value	LOW CUT
8.2.16	Output at alarm occurrence	ALM mA SET
8.2.17	Display low cut Yes/No	DSP LOW CUT
8.2.18	Output low limit setting	LOW LIMIT
8.2.19	Still water zero point adjustment	ZERO ADJUST
8.2.20	Digital input/output	DO1 FUNCTN, DI FUNCTN, DO1 ALM STS, DI DET LV
8.2.21	Count rate Pulse width setting mode Pulse width	COUNT RATE, PLS MODE, PLS WIDTH
8.2.22	Preset count value	PRESET CNT
8.2.23	Preset output state	PRESET FNC
8.2.24	High/Low limit alarm ON/OFF High high/Low low limit alarm ON/OFF	H ALM SET / H ALM VAL, L ALM SET / L ALM VAL, HH ALM SET / HH ALM VAL, LL ALM SET / LL ALM VAL,
8.2.25	Fluid empty alarm	EMPTY ALM
8.2.26	Self-diagnosis Yes/No	SELF CHECK
8.2.27	Alarm output preset	ALM PRESET
8.2.28	Limit rate Limit time	LIMIT RATE / LIMIT TIME
8.2.29	Fixed output	FIXED OUT, FIXED CURR, FIXED PULSE
8.2.30	Manual zero	MANUAL ZERO

8.2 Check/Change of Parameters

8.2.1 Menu Configuration Selection Screen

○ Menu configuration selection screen

Display example

	M	E	N	U		S	E	L	E	C	T	
→	B	A	S	I	C							
	D	E	T	A	I	L	E	D				

This screen allows you to select the menu construction you want to use.

For the menu contents to be expanded according to the selected configuration, see 7.4 "Configuration Items Selection Table."

BASIC: Only the basic parameters are displayed.
Nothing is displayed in the other parameter display field.

DETAILED: All parameters are displayed.

8.2.2 Exciting Current Value

The exciting current value can be checked/changed by the following procedures.

Be sure to match the exciting current value with **the value specified for the combined detector**.
Specifying any other value may cause an error.

Shown below is an example of changing the exciting current value from 0.1900A to 0.2150A.

Key operation	Display example	Description
	A: MEAS MODE →EX CURRENT METER SIZE EX FREQ FLOW DIRECTN PASSWORD ADDR SET [SEL] [ENT]	In the configuration items selection screen, select "EX CURRENT."
STEP1 [ENT]	A1: EX CURRENT 0.20000 A [EXT] [ENT]	The currently set exciting current value (in this example 0.1900A) is displayed. Then press the [ENT] key. * Pressing the [EXT] key returns you to the menu screen.
STEP2 [ENT]	A1: EX CURRENT 0.1900 A [UP] [SEL] [SET]	The switch name display at the bottom changes. (three keys [UP], [SEL] and [SET]) At the same time, the cursor appears. (The digit in the place the cursor position is currently positioned is reverse-displayed.) Then press the [SEL] key.
STEP3 [SEL]	A1: EX CURRENT 0.1900 A [UP] [SEL] [SET]	You can continue to change the setting value. Press the [SEL] key to move the cursor to the digit you want to change. Then press the [UP] key.
STEP4 [UP]	A1: EX CURRENT 0.2900 A [UP] [SEL] [SET]	You can continue to change the setting value. Pressing the [UP] key increments the digit in the place the cursor is currently positioned. (Holding down this key causes this increment operation to be continued).

Key operation	Display example	Description
STEP5 [SEL]⇔[UP]	A1: EX CURRENT 0.2150 A [U P] [SEL] [SET]	Repeat this operation to change the setting value to 0.2150A. When the value changes to the desired value, press the [SET] key to set the numeric value temporarily.
STEP6 [SET]	A1: EX CURRENT 0.2150 A OK?  [N O] [SET]	Pressing the [SET] key displays a message asking you to confirm whether the setting is OK. If OK, press the [SET] key. If you need to redo the setting, press the [NO] key.
STEP7-1 [NO]	A1: EX CURRENT 0.1900 A [U P] [SEL] [SET]	Pressing the [No] key when you are asked "OK?" causes the numeric value to return to the previous value and enables you to redo the setting.
STEP7-2(=END) [SET]	A1: EX CURRENT 0.2150 A [EXT] [ENT]	Pressing the [SET] key when you are asked "OK?" causes the setting value to be determined. Then if you press the [EXT] key, you return to the menu screen. If you press the [ENT] key, you can restart electric current value change operation from a state of 0.2150A.

(Note) The exciting current value must be a value from 0.0000A and 0.2500A.

If you set an exciting current value higher than 0.2500A, *HIGH OVER SPEC.* is displayed and the set value is returned to the value before change. In this case you have to set a value once again.

8.2.3 Meter Size

Proceed as follows to check or change the meter size of the detector.

Key operation	Display example	Description
	A: MEAS MODE EX CURRENT →METER SIZE EX FREQ FLOW DIRECTN PASSWORD ADDR SET [SEL] [ENT]	Select "METER SIZE" in the configuration item selection screen.
STEP1 [ENT]	A2: METER SIZE 50 mm [EXT] [ENT]	The currently set meter size (50mm in this example) is displayed. Then press the [ENT] key. * Pressing the [EXT] key returns you to the menu screen.
STEP2 [ENT]	A2: METER SIZE 50 mm [U P] [DWN] [SET]	The switch name display at the bottom changes. (Three keys [UP], [DWN] and [SET] are displayed) At the same time, the cursor appears. Then press either [UP] or [DWN].
STEP3 [UP]/[DWN]	A2: METER SIZE 65 mm [U P] [DWN] [SET]	You can continue to change the setting value. Pressing [UP] or [DWN] key changes the selection item. [UP]: Selection item count increases [DWN]: Selection item count decreases
STEP4 [UP]/[DWN]	A2: METER SIZE 150 mm [U P] [DWN] [SET]	Repeat this operation to change the setting value to 150mm. When the desired selection item appears, press the [SET] key to temporarily set the item.
STEP5 [SET]	A2: METER SIZE 150 mm OK?  [N O] [SET]	Pressing the [SET] key displays a message asking you to confirm whether the setting is OK or not. If OK, press the [SET] key. If you need to redo the setting, press the [NO] key.

Key operation	Display example	Description
STEP6-1 [NO]	A2: METER SIZE 50 mm [U P] [SEL] [SET]	Pressing the [NO] key when you are asked "OK?" causes the number value to return to the previous value and enables you to redo the setting.
STEP6-2(=END) [SET]	A2: METER SIZE 150 mm [EXT] [ENT]	Pressing the [SET] key when you are asked "OK?" confirms the setting at this point. Then if you press the [EXT] key, you return to the menu screen. If you press the [ENT] key, you can go to the frequency change operation starting from the condition of 150mm.

Note 1: The meter size display loops as shown below:

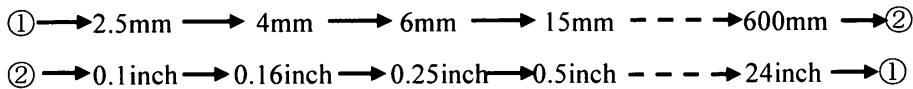

Note 2: The range unit and the count rate will be forcefully set as shown below when the meter size is changed. Set each parameter again, if necessary.

Range unit	"m/s"
Count rate	If the count rate goes out of the setting range when the meter size is changed, the set value will be forcefully set to zero.

Note 3: The exciting frequency setting may become inappropriate for the set value when the meter size of the detector is changed. If the exciting frequency is the value shown below when the meter size is changed, the exciting frequency will be forcefully changed.

Setting meter size		Set exciting frequency	Forcefully set exciting frequency
(mm)	(inch)		
2.5 ~ 200	0.1 ~ 8	—	Not forcefully set
250 ~ 450	10 ~ 18	24Hz	12Hz
500, 600	20, 24	12Hz, 24Hz	6Hz

8.2.4 Exciting Frequency

You can select an exciting frequency of 6Hz, 12Hz or 24Hz.

Since each exciting frequency value has its own characteristics, you should select an appropriate exciting frequency (24Hz is set at shipment. **Depending on the characteristics of the detector, a large frequency may result in excitation failure.** When a large frequency value is set and it changes the indicator value, decrease the frequency to a value that will not change the indicator value.)

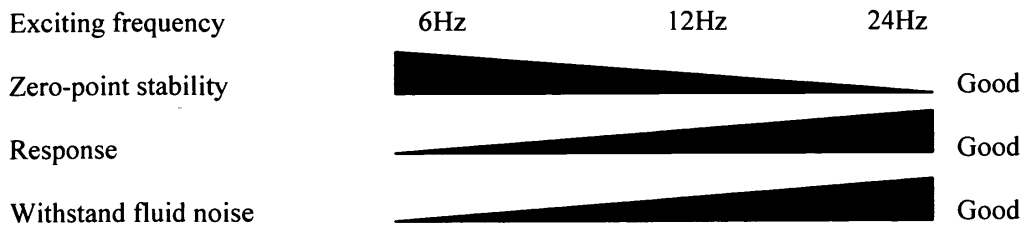

Shown below is an example of changing the exciting frequency from 24Hz to 12Hz.

Key operation	Display example	Description
	A: MEAS MODE EX CURRENT METER SIZE →EX FREQ FLOW DIRECTN PASSWORD ADDR SET [SEL] [ENT]	Select "EXFREQ" in the configuration item selection screen.
STEP1 [ENT]	A3: EX FREQ 24 Hz [EXT] [ENT]	The currently set exciting frequency value (24Hz in this example) is displayed. Then press the [ENT] key. * Pressing the [EXT] key returns you to the menu screen.
STEP2 [ENT]	A3: EX FREQ 24 Hz [U P] [DWN] [SET]	The switch name display at the bottom changes (three keys [UP], [DWN] and [SET]) At the same time, the cursor appears. Then press the [UP] or [DWN] key.
STEP3 [UP]/[DWN]	A3: EX FREQ 6 Hz [U P] [DWN] [SET]	You can continue to change the setting value. Pressing the [UP] or [DWN] key switches the selection item. [U P]: The selection item is incremented. [DWN]: The selection item is decremented.

Key operation	Display example	Description
STEP4 [UP]/[DWN]	A3: EX FREQ 12 Hz [U P] [DWN] [SET]	Repeat this operation to change the setting value to 12Hz. When the value changes to the desired selection item, press the [SET] key to set the item temporarily.
STEP5 [SET]	A3: EX FREQ 12 Hz OK?  [N O] [SET]	Pressing the [SET] key displays a message asking you to confirm whether the setting is OK. If OK, press the [SET] key. If you need to redo the setting, press the [NO] key.
STEP6-1 [NO]	A3: EX FREQ 24 Hz [U P] [SEL] [SET]	Pressing the [No] key when you are asked "OK?" causes the numeric value to return to the previous value and enables you to redo the setting.
STEP6-2(=END) [SET]	A3: EX FREQ 12 Hz [EXT] [ENT]	Pressing the [SET] key when you are asked "OK?" causes the setting value to be determined. Then if you press the [EXT] key, you return to the menu screen. If you press the [ENT] key, you can restart frequency value change operation from a state of 12Hz.

(Note 1) The exciting frequency is displayed cyclically, as shown below.

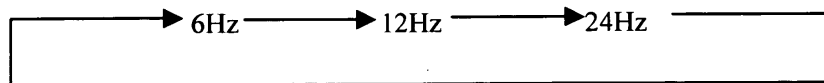

8.2.5 Flow Direction Setting

In the converter, you can set the flow direction of fluid arbitrarily.

● Flow direction setting

Selection item	Contents
NORMAL	When the fluid flows in the direction of the arrow indicating the flow direction that is attached to the detector, the indicator value and electric current output value increase.
SWITCH	When the fluid flows in the reverse direction of the arrow indicating the flow direction that is attached to the detector, the indicator value and electric current output value increases.

Key operation	Display example	Description
	A: MEAS MODE EX CURRENT METER SIZE EX FREQ →FLOW DIRCTN PASSWORD ADDR SET [SEL] [ENT]	Select "FLOW DIRECTN" in the configuration item selection screen.
STEP1 [ENT]	A4: FLOW DIRCTN NORMAL [EXT] [ENT]	The currently set flow direction (NORMAL in this example) is displayed. Then press the [ENT] key. * Pressing the [EXT] key returns you to the menu screen.
STEP2 [ENT]	A4: FLOW DIRCTN NORMAL [U P] [DWN] [SET]	The switch name display at the bottom changes (three keys [UP], [DWN] and [SET]) At the same time, the cursor appears. Then press the [UP] or [DWN] key.
STEP3 [UP]/[DWN]	A4: FLOW DIRCTN SWITCH [U P] [DWN] [SET]	You can continue to change the setting value. Pressing the [UP] or [DWN] key switches the selection item. [U P]: The selection item is incremented. [DWN]: The selection item is decremented.

Key operation	Display example	Description
<p>STEP4</p> <p>[UP]/[DWN]</p>	<p>A4: FLOW DIRCTN SWITCH</p> <p>[U P] [DWN] [SET]</p>	<p>By this operation, change the setting to SWITCH.</p> <p>When the desired selection item is displayed, press the [SET] key to set the item temporarily.</p>
<p>STEP5</p> <p>[SET]</p>	<p>A4: FLOW DIRCTN SWITCH</p>  <p>OK? [N O] [SET]</p>	<p>Pressing the [SET] key displays a message asking you to confirm whether the setting is OK. If OK, press the [SET] key. If you need to redo the setting, press the [NO] key.</p>
<p>STEP6-1</p> <p>[NO]</p>	<p>A4: FLOW DIRCTN NORMAL</p> <p>[U P] [SEL] [SET]</p>	<p>Pressing the [No] key when you are asked "OK?" causes the numeric value to return to the previous value and enables you to redo the setting.</p>
<p>STEP6-2(=END)</p> <p>[SET]</p>	<p>A4: FLOW DIRCTN SWITCH</p> <p>[EXT] [ENT]</p>	<p>Pressing the [SET] key when you are asked "OK?" causes the setting value to be determined. Then if you press the [EXT] key, you return to the menu screen. If you press the [ENT] key, you can restart frequency value change operation from a state of SWITCH.</p>

8.2.6 Password Setting

The password function is provided to **protect the settings and adjustment of the functions affecting the flow rate measurement**. See 7.4 “Configuration Items Selection Table” for limited functions.

Proceed as follows to check or change the password.

• **To check the password:**

Key operation	Display example	Description
	A: MEAS MODE EX CURRENT METER SIZE EX FREQ FLOW DIRECTN →PASSWORD ADDR SET [SEL] [ENT]	Select "PASSWORD" in the configuration item selection screen.
[ENT]	A5: PASSWORD 123 [EXT] [ENT]	The currently set password is displayed.
[EXT]	A: MEAS MODE →EX CURRENT METER SIZE EX FREQ FLOW DIRECTN PASSWORD ADDR SET [SEL] [ENT]	You return to the configuration item selection screen.

* However, if a wrong password is entered when the mode is changed from the measuring mode to the setting mode, *** appears.

Key operation	Display example	Description
[ENT]	A5: PASSWORD *** [EXT] [ENT]	The currently set password is displayed as ***.

● **To change the password:**

The following example shows how to change the password from 123 to 453.

Key operation	Display example	Description
	A5: PASSWORD 123 [EXT] [ENT]	Select "PASSWORD" in the configuration item selection screen. The currently set password (123 in this example) is displayed. Then press the [ENT] key.
STEP1 [ENT]	A5: PASSWORD 123 [U P] [SEL] [SET]	The switch name display at the bottom changes (three keys [UP], [SEL] and [SET]) At the same time, the cursor appears. (The digit on which the cursor is positioned is reverse-displayed.)
STEP2 [SEL]↔[UP]	A5: PASSWORD 453 [U P] [SEL] [SET]	Use the [SEL] key to move the cursor to the desired digit and press the [UP] key to change the numeric value. Repeat this operation to change the setting value to 453. When the desired value is displayed, press the [SET] key to set the numeric value temporarily.
STEP3 [SET]	A5: PASSWORD 453 OK? [N O] [SET]	Pressing the [SET] key displays a message asking you to confirm whether the setting is OK. If OK, press the [SET] key. If you need to redo the setting, press the [NO] key.
STEP4-1 [NO]	A5: PASSWORD 123 [U P] [SEL] [SET]	Pressing the [No] key when you are asked "OK?" causes the numeric value to return to the previous value and enables you to redo the setting.
STEP4-2(=END) [SET]	A5: PASSWORD 453 [EXT] [ENT]	Pressing the [SET] key when you are asked "OK?" causes the setting value to be determined. Then if you press the [EXT] key, you return to the menu screen. If you press the [ENT] key, you can restart password change operation from a state of 453.

(Note 1) If you set 000 for the password, it is considered as that the password is not used. In this case, the password input confirmation screen is not displayed when you move from the measurement mode to the setting mode and all parameter setting items and restrictions on the calibration screen are released.

(Note 2) If you set your password, manage it not to forget it.
The password should be managed based on the management standard of the system you use.

8.2.7 Address Setting

Address setting described here is needed if optional PROFIBUS communication board is installed. For details, refer to PROFIBUS communication instruction manual.

*** Address setting is not necessary if PROFIBUS communication board is not installed.**

8.2.8 Indicating Unit

You can select one of the engineering units listed below as an indicating unit.

- **Flow velocity:** m/s, ft/s
- **Flow rate:** m³/s, m³/min, m³/h, m³/d
l/s, l/min, l/h, l/d
ml/s, ml/min, ml/h, ml/d
gal/s, gal/min, gal/h, gal/d
bbl/s, bbl/min, bbl/h, bbl/d
pt/s, pt/min, pt/h, pt/d
qt/s, qt/min, qt/h, qt/d
- **Volumetric flow:** m³, l, ml, gal, bbl, pt, qt
- **Other units:** %, COUNT, RANGE, GRAPH, CUSTOM
- **Code of volumetric flow direction:**
Forward direction (when F or B is selected)
Reverse direction (when R or B is selected)
- **Total difference flow:**
Difference between total forward direction flow and reverse direction flow (when total flow direction D is selected)

Note 1

If COUNT, RANGE, GRAPH or CUSTOM is selected, the display is shown as follows:

COUNT: displays totalized flow counts (8 digits) without a unit.

RANGE: displays the range number (1 to 4).

GRAPH: The measured value (% value) is displayed as a bar graph.
In addition, the range No. of the range being measured.

CUSTOM: Displays the result obtained by multiplying m³/min by the custom coefficient.

Note 2

GRAPH display can be selected only in the sub screen.

In display setting, you can select either one of the two types, main (MAIN DSP) or/Sub (SUB DSP).
 The main display setting and sub display setting are switched by the configuration item number.

B1: MAIN DSP Main display unit (display setting for the upper part of the screen)

B2: SUB DSP Sub display unit (display setting for the lower part of the screen)

The display setting can be checked/set by the following procedures.

Shown below is an example of changing the main display setting from % to ml/s.

Key operation	Display example	Description
	B: MEAS MODE →MAIN DSP SUB DSP CUSTOM DATA CUSTOM UNIT LCD ADJUST SW POSITION [SEL] [ENT]	Select "MAIN DSP" in the configuration item selection screen.
STEP1 [ENT]	B1: MAIN DSP % [EXT] [ENT]	The currently set display setting (% in this example) is displayed. Then press the [ENT] key. * Pressing the [EXT] key returns you to the menu screen.
STEP2 [ENT]	B1: MAIN DSP % [U P] [SEL] [SET]	The switch name display at the bottom changes (three keys [UP], [SEL] and [SET]) At the same time, the cursor appears. (The digit on which the cursor is positioned is reverse-displayed.)
STEP3 [SEL]↔[UP]	B1: MAIN DSP ml / s [U P] [SEL] [SET]	Use the [SEL] key to move the cursor to the second unit → the third unit and change the display unit by pressing the [UP] key. Repeat this operation to change the display unit to ml/s. When the desired display unit is selected, press the [SET] key to set the display unit temporarily.
STEP4 [SET]	B1: MAIN DSP ml / s OK? [NO] [SET]	Pressing the [SET] key displays a message asking you to confirm whether the setting is OK. If OK, press the [SET] key. If you need to redo the setting, press the [NO] key.

<p>STEP5-1</p> <p>[NO]</p>	<p>B1: MAIN DSP %</p> <p>[U P] [SEL] [SET]</p>	<p>Pressing the [No] key when you are asked "OK?" causes the display unit to return to the previous value and enables you to redo the setting.</p>
<p>STEP5-2(=END)</p> <p>[SET]</p>	<p>B1: MAIN DSP ml / s</p> <p>[EXT] [ENT]</p>	<p>Pressing the [SET] key when you are asked "OK?" causes the setting value to be determined. Then if you press the [EXT] key, you return to the menu screen. If you press the [ENT] key, you can restart display unit setting change operation from a state of ml/s.</p>

Note 1:

The first unit (volumetric units etc.) changes as shown below:

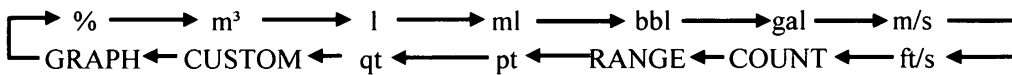

Note 2:

The second unit (time unit) changes as shown below:

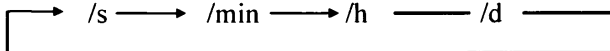

For sub indicating unit, select SUB DSP with setting items.

■ **To change the total flow value direction**

The total flow value direction is changed as following procedure.

The following example shows how to change the main indicating setting from fixed forward flow (F) to bi-directional flow (B).

Key operation	Display example	Description
	B1: MAIN DSP m3 F [EXT] [ENT]	Select "MAIN DSP" in the configuration item selection screen. The currently set display setting (m3 F in this example) is displayed. Then press the [ENT] key.
STEP1 [ENT]	B1: MAIN DSP m3 F [U P] [SEL] [SET]	The switch name display at the bottom changes (three keys [UP], [SEL] and [SET]) At the same time, the cursor appears. (The digit on which the cursor is positioned is reverse-displayed.)
STEP2 [SEL]⇔[UP]	B1: MAIN DSP m3 B [U P] [SEL] [SET]	Use the [SEL] key to move the cursor to the third unit (total flow value direction) and then press the [UP] key to change the direction. Then press the [SET] key to set the display unit temporarily.
STEP3 [SET]	B1: MAIN DSP m3 B OK?  [N O] [SET]	Pressing the [SET] key displays a message asking you to confirm whether the setting is OK. If OK, press the [SET] key. If you need to redo the setting, press the [NO] key.
STEP4-1 [NO]	B1: MAIN DSP m3 F [U P] [SEL] [SET]	Pressing the [No] key when you are asked "OK?" causes the display unit to return to the previous value and enables you to redo the setting.
STEP4-2(=END) [SET]	B1: MAIN DSP m3 B [EXT] [ENT]	Pressing the [SET] key when you are asked "OK?" causes the setting value to be determined. Then if you press the [EXT] key, you return to the menu screen. If you press the [ENT] key, you can restart display unit setting change operation from a state of m3 B.

Note 1 The content of the third unit (flow rate direction code) is cyclically shifted as shown below.

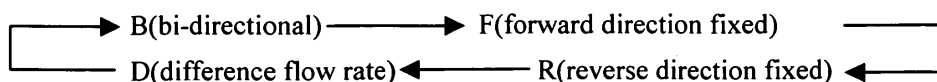

For sub indicating unit, select **B2: SUB DSP** with setting items.

8.2.9 Custom Coefficient Setting

Set a coefficient for the custom value displayed when you have selected CUSTOM at display setting.
Displayed value at CUSTOM setting = measured value in m³/min unit × custom coefficient
 Shown below is an example of changing the custom coefficient value from 1.00 to 2.25.

Key operation	Display example	Description
	B: MEAS MODE MAIN DSP SUB DSP →CUSTOM DATA CUSTOM UNIT LCD ADJUST SW POSITION [SEL] [ENT]	Select "CUSTOM DATA" in the configuration item selection screen.
STEP1 [ENT]	B3: CUSTOM DATA 1.00000 [EXT] [ENT]	The currently set custom coefficient (1.00000 in this example) is displayed. Then press the [ENT] key. * Pressing the [EXT] key returns you to the menu screen.
STEP2 [ENT]	B3: CUSTOM DATA 1.00000 [U P] [SEL] [SET]	The switch name display at the bottom changes (three keys [UP], [SEL] and [SET]) At the same time, the cursor appears. (The digit on which the cursor is positioned is reverse-displayed.)
STEP3 [SEL]↔[UP]	B3: CUSTOM DATA 2.25000 [U P] [SEL] [SET]	Use the [SEL] key to move the cursor to the desired digit and press the [UP] key to change the numeric value. Repeat this operation to change the setting value to 2.25. When the value changes to the desired value, press the [SET] key to set the custom coefficient temporarily.
STEP4 [SET]	B3: CUSTOM DATA 2.25000 OK?  [N O] [SET]	Pressing the [SET] key displays a message asking you to confirm whether the setting is OK. If OK, press the [SET] key. If you need to redo the setting, press the [NO] key.
STEP5-1 [NO]	B3: CUSTOM DATA 1.00000 [U P] [SEL] [SET]	Pressing the [No] key when you are asked "OK?" causes the custom coefficient to return to the previous value and enables you to redo the setting.
STEP5-2(=END) [SET]	B3: CUSTOM DATA 2.25000 [EXT] [ENT]	Pressing the [SET] key when you are asked "OK?" causes the setting value to be determined. Then if you press the [EXT] key, you return to the menu screen. If you press the [ENT] key, you can restart custom coefficient change operation from a state of 2.25.

* The custom coefficient setting precision is 5 digits. Therefore, the input value changes as follows depending on the setting value:

Example) Input value, "85713038" → After the setting is confirmed, "85713040"

8.2.10 Custom Unit Setting

Set the unit of the custom value to be displayed when you select CUSTOM at display setting.

The custom value unit must be within 7 characters. You can set any combination of the following character codes:

Alphabetical character (lowercase)	:	a ~ z
alphabetical character (uppercase)	:	A ~ Z
Numeric character	:	0 ~ 9
Symbol	:	() ...Parentheses
	:	% ...Percent
	:Period
	:	• ...Point
	:	: ...Colon
	:	= ...Equal
	:	- ...Minus
	:	* ...Asterisk
	:	/ ...Slash
	:	_ ...Space (blank)

Shown below is an example of changing the custom unit from AAA/BBB to XXX/ZZZ.

Key operation	Display example	Description
	B: MEAS MODE MAIN DSP SUB DSP CUSTOM DATA →CUSTOM UNIT LCD ADJUST SW POSITION [SEL] [ENT]	Select "CUSTOM UNIT" in the configuration item selection screen.
STEP1 [ENT]	B4: CUSTOM UNIT AAA/BBB [EXT] [ENT]	The currently set custom unit (AAA/BBB in this example) is displayed. Then press the [ENT] key. * Pressing the [EXT] key returns you to the menu screen.
STEP2 [ENT]	B4: CUSTOM UNIT AAA/BBB [U P] [DWN] [SET]	The switch name display at the bottom changes. (three keys [UP], [DOWN] and [SET]) At the same time, the cursor appears. (The digit in the place the cursor position is currently positioned is reverse-displayed.)
STEP3 [UP]/[DWN] [SET]	B4: CUSTOM UNIT AA/BBB [U P] [DWN] [SET]	Using the [UP]/[DWN] key, change the character. When the desired character is displayed, press the [SET] key. The cursor moves to the next character.
STEP4 [UP]/[DWN] [SET]	B4: CUSTOM UNIT XXX/YY [U P] [DWN] [SET]	Repeat this operation to select all characters to the 7th character.
STEP5 [SET]	B4: CUSTOM UNIT XXX/YYY OK?  [N O] [SET]	Pressing the [SET] key when the cursor is positioned on the 7th character causes the selected unit characters to be set temporarily. And a message to confirm whether the setting is OK is displayed. If OK, press the [SET] key. If you want to redo the setting, press the [NO] key.
STEP6-1 [NO]	B4: CUSTOM UNIT AAA/BBB [U P] [DWN] [SET]	Pressing the [NO] key when you are asked "OK?" causes the custom unit to return to the previous state and enables you to redo the setting.
STEP6-2(=END) [SET]	B4: CUSTOM UNIT XXX/YYY [EXT] [ENT]	Pressing the [SET] key when you are asked "OK?" causes the setting value to be determined. Then if you press the [EXT] key, you will return to the menu screen. If you press the [ENT] key, you can restart custom unit change operation from a state of XXX/YYY.

(Note 1) The selectable characters are displayed cyclically as shown below.

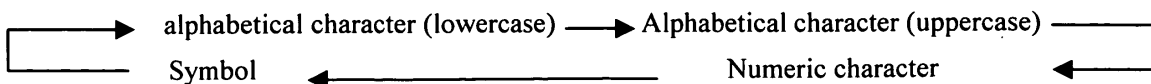

8.2.11 LCD Density Adjustment

This section describes how to set the LCD density adjustment value for the converter display. The LCD density can be set in 5 levels.

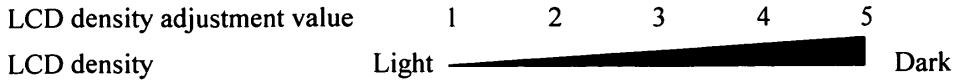

The LCD density adjustment value is set to "3" at factory. The display of the LCD, by its natural characteristics, gradually becomes lighter over time. If the display becomes too dark, you need to adjust the density by using this parameter. Shown below is an example of changing the LCD density adjustment value from 3 to 5 DARK.

Key operation	Display example	Description
	B: MEAS MODE MAIN DSP SUB DSP CUSTOM DATA CUSTOM UNIT →LCD ADJUST SW POSITION [SEL] [ENT]	Select "LCD ADJUST" in the configuration item selection screen.
STEP1 [ENT]	B5: LCD ADJUST 3 [EXT] [ENT]	The currently set LCD density adjustment value (3 in this example) is displayed. Then press the [ENT] key. * Pressing the [EXT] key returns you to the menu screen.
STEP2 [ENT]	B5: LCD ADJUST 3 [U P] [DWN] [SET]	The switch name display at the bottom changes (three keys [UP], [DWN] and [SET]). At the same time, the cursor appears. (The digit on which the cursor is positioned is reverse-displayed).
STEP3 [UP]/[DWN]	B5: LCD ADJUST 5 DARK [U P] [DWN] [SET]	Change the setting item using the [UP]/[DWN] key. When the desired item is displayed, press the [SET] key.
STEP4 [SET]	B5: LCD ADJUST 5 DARK OK?  [N O] [SET]	When you press the [SET] key, the selected item is set temporarily and a message confirming you whether the setting is OK is displayed. If OK, press the [SET] key. If you want to redo the setting, press the [NO] key.
STEP5-1 [NO]	B5: LCD ADJUST 3 [U P] [DWN] [SET]	Pressing the [NO] key when you are asked "OK?" causes the LCD density adjustment value to return to the previous value and enables you to redo the setting.
STEP5-2(=END) [SET]	B5: LCD ADJUST 5 DARK [EXT] [ENT]	Pressing the [SET] key when you are asked "OK?" causes the setting to be determined. Then, press the [EXT] key. You return to the menu screen. Pressing the [ENT] key enables you to restart LCD density adjustment from a state of 5 DARK.

8.2.12 Switch Position Setting

This section describes how to set the switch position of the converter display.

Setting the switch position enables the display orientation to be kept fixed, regardless of in which direction relative to the piping the converter is installed.

You can set the switch position by selecting one from four items below.

(1) Switch position: TOP

The infrared switches are located at the top.

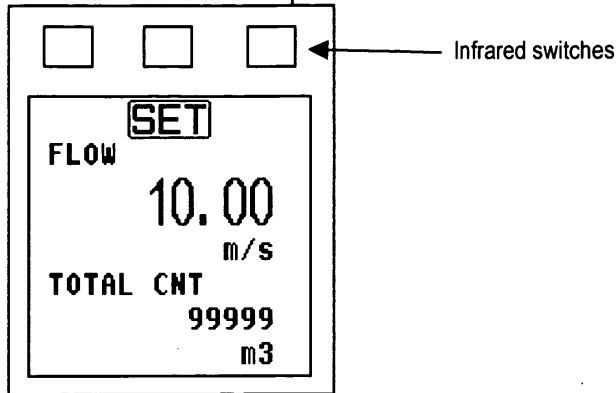

(2) Switch position: BOTTOM

The infrared switches are located at the bottom.

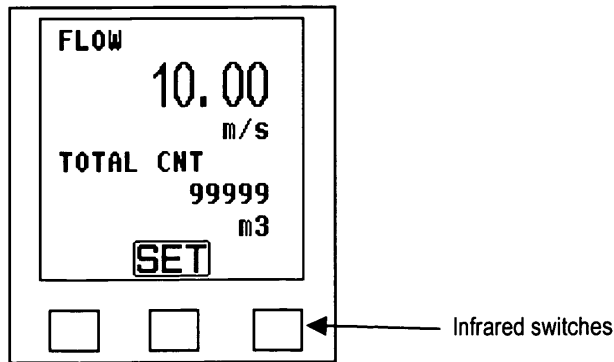

(3) Switch position: LEFT

The infrared switches are located in the left.

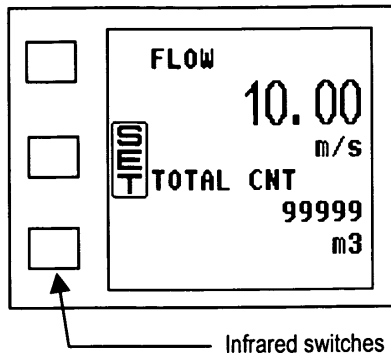

(4) Switch position : RIGHT

The infrared switches are located in the right

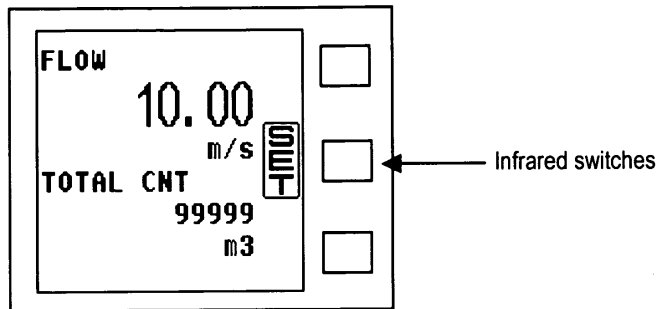

Shown below is an example of changing the switch position setting from BOTTOM to TOP.

Key operation	Display example	Description
	B: MEAS MODE MAIN DSP SUB DSP CUSTOM DATA CUSTOM UNIT LCD ADJUST →SW POSITION [SEL] [ENT]	Select "SW POSITION" in the configuration item selection screen.
STEP1 [ENT]	B6: SW POSITION BOTTOM [EXT] [ENT]	The currently set switch position (BOTTOM in this example) is displayed. Then press the [ENT] key. * If you press the [EXT] switch, you return to the menu screen.
STEP2 [ENT]	B6: SW POSITION BOTTOM [UP] [DWN] [SET]	The switch name display at the bottom changes (three keys [UP], [DWN] and [SET]). At the same time, the cursor appears. (The digit on which the cursor is positioned is reverse-displayed.)
STEP3 [UP]/[DWN]	B6: SW POSITION TOP [UP] [DWN] [SET]	Change the selection item using the [UP]/[DWN] key. When you have selected the desired item, press the [SET] key.
STEP4 [SET]	B6: SW POSITION TOP OK?  [NO] [SET]	When you press the [SET] key, the selected item is set temporarily and a message confirming you whether the setting is OK is displayed. If OK, press the [SET] key. If you want to redo the setting, press the [NO] key.
STEP5-1 [NO]	B6: SW POSITION BOTTOM [UP] [DWN] [SET]	Pressing the [NO] key when you are asked "OK?" causes the switch position setting to return to the previous setting and enables you to redo the setting.
STEP5-2(=END) [SET]	B6: SW POSITION TOP [EXT] [ENT]	Pressing the [SET] key when you are asked "OK?" causes the setting to be determined. Then press the [EXT] key. You return to the menu screen. Pressing the [ENT] key enables you to restart switch position setting from a state of TOP.

8.2.13 Span (range)

You can set the following constants in this setting item:

- (1) Range type
- (2) Unit of span (can be changed only in range 1)
- (3) Span
- (4) Hysteresis

• Range type

You can use multiple ranges by selecting range type. You can select a **single range**, **multiple ranges**, or **forward/reverse multi-ranges**. Select one from five types shown below:

Range type	Description
SINGLE	Single range
4F-0R	Unidirectional flow, automatic selection of multiple ranges by internal signal
2F-2R	Bidirectional flows, automatic selection of multiple ranges by internal signal
EXT.2F-0R	Unidirectional flow, multiple ranges selected by external signal
EXT.2F-2R	Bidirectional flows, multiple ranges selected by external signal

• Span (range)

- Span can be set for flow velocity and flow rates:

(1) Setting range

Valid range of span is **0.3 m/s to 10 m/s** in terms of flow velocity.

If you try to set the span outside of this range, one of the following messages appears:

- * **HIGH OVER SPEC.** (if the set value exceeds 10 m/s)
- * **LOW OVER SPEC.** (if the set value is less than 0.3 m/s)

Try again to set the span within the specified range.

(2) Limitation of multiple ranges

When multiple ranges are used, the following must be observed:

- **Range 1 > Range 2 > Range 3 > Range 4 (unidirectional flow, multiple ranges)**
- **Range 1 > Range 2, Range 3 > Range 4 (bidirectional flows, multiple ranges)**

If you try to set the ranges not conforming to the above, the following message appears:

- * **MULTI RANGE ERROR ***

Try again to set the ranges as specified above.

(3) Influence on Totalization counting rate (pulse rate)

If you have changed the span while the counting rate is set for totalization (pulse rate), the counting rate for 100% output may have exceeded the maximum counting capacity.

In this kind of event, the following message appears and the system goes to the counting rate setting sequence after all ranges are set.

- * **H. OVER CNT RATE** or
- * **L. OVER CNT RATE**

Set the counting rate (pulse rate) in accordance with 8.2.21 "Counting Rate (pulse rate) and Pulse Width" for the newly set span.

• Unit of span

One of the following engineering units as a unit for the span can be selected. The unit is set for the **range 1** and **the same unit applies automatically to other ranges** - range 2, range 3 and range 4.

- **Flow velocity:** m/s, ft/s
- **Flow rate:** m³/s, m³/min, m³/h, m³/d
l/s, l/min, l/h, l/d
ml/s, ml/min, ml/h, ml/d
gal/s, gal/min, gal/h, gal/d
bbl/s, bbl/min, bbl/h, bbl/d
pt/s, pt/min, pt/h, pt/d
qt/s, qt/min, qt/h, qt/d

If you change the unit, **the new span based on the newly set unit will be automatically displayed.**

• Hysteresis

The hysteresis is the **dead band** used when multiple ranges are switched. The hysteresis can be set from **0 to 25% in increments of 0.1%**. The hysteresis setting is **needed only when automatic selection of multiple ranges is used.**

• Setting sequence of the span(range)

The following is the setting sequence of span (range).

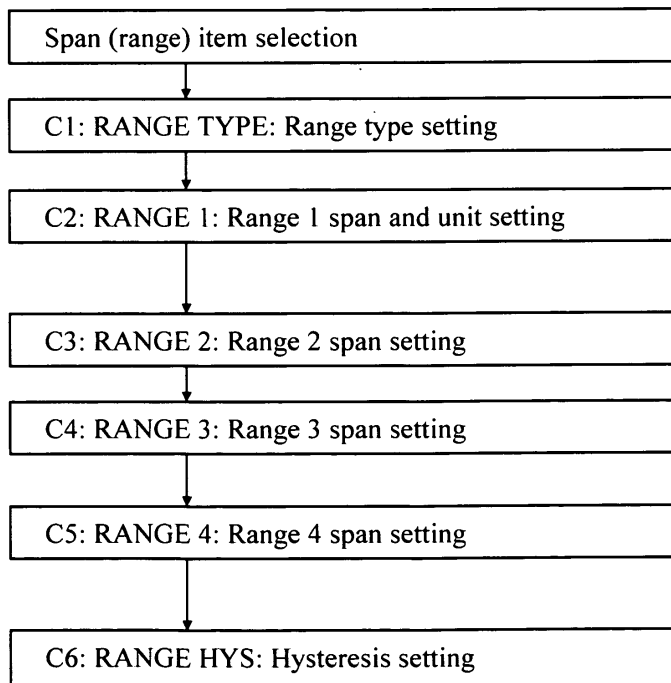

* **If multiple range is selected, compulsory range 1 to range 4 and hysteresis settings are displayed.**

Range type, Span, Hysteresis can be selected by the configuration items as follows:

- Range type C1: RANGE TYPE
- Span of Range 1 C2: RANGE 1
- Span of Range 2 C3: RANGE 2
- Span of Range 3 C4: RANGE 3
- Span of Range 4 C5: RANGE 4
- Hysteresis C6: RANGE HYS

Each constant can be checked/changed by the following procedure.

• **Checking each constant**

Key operation	Display example	Description
	C: MEAS MODE RANGE TYPE →RANGE1 RANGE2 RANGE3 RANGE4 RANGE HYS [SEL] [ENT]	Select "RANGE1" in the configuration item selection screen.
[ENT]	C2: RANGE1 2.00000 m/s [EXT] [ENT]	The currently set span value of Range 1 is displayed.
[EXT]	C: MEAS MODE →RANGE TYPE RANGE1 RANGE2 RANGE3 RANGE4 RANGE HYS [SEL] [ENT]	You return to the configuration item selection screen.

■ **To change the range type:**

Range type should be changed before changing the span.

The following example shows how to change the range type from the single range (SINGLE) to bi-directional internal signal selection multi-range (2F-2R).

Key operation	Display example	Description
	C1: RANGE TYPE SINGLE [EXT] [ENT]	Select "RANGE TYPE" in the configuration item selection screen. The currently set range type (SINGLE in this example) is displayed. Then press the [ENT] key.
STEP1 [ENT]	C1: RANGE TYPE SINGLE [U P] [DWN] [SET]	The switch name display at the bottom changes (three keys [UP], [DWN] and [SET]). At the same, the cursor appears. (The digit on which the cursor is positioned is reversed-displayed.)
STEP2 [UP]/[DWN]	C1: RANGE TYPE 2F-2R [U P] [DWN] [SET]	Change the selection item using the [UP]/[DWN] key. When the selection item has changed to the desired item, press the [SET] key.
STEP3 [SET]	C1: RANGE TYPE 2F-2R OK?  [N O] [SET]	When you press the [SET] key, the item you have selected is set temporarily and a message confirming you whether the setting is OK is displayed. If OK, press the [SET] key. If you want to redo the setting, press the [NO] key.
STEP4-1 [NO]	C1: RANGE TYPE SINGLE [U P] [DWN] [SET]	Pressing the [NO] key when you are asked "OK?" returns the range type setting to the previous setting and enables you to redo the setting.
STEP4-2(=END) [SET]	C1: RANGE TYPE 2F-2R [EXT] [ENT]	Pressing the [SET] key when you are asked "OK?" causes the setting to be determined. Then, press the [EXT] key. You return to the menu screen. Pressing the [ENT] key enables you to restart switch range type setting from the position setting from a state of 2F-2R.

■ **To change the span (range):**

The following example shows how to change the span of Range 1 from 2.0 m/s to 100 l/min.

Key operation	Display example	Description
	C2: RANGE1 2.00000 m/s [EXT] [ENT]	Select "RANGE1" in the configuration item selection screen. The currently set span value of Range1 (2.00000 in this example) is displayed. Then press the [ENT] key.
STEP1 [ENT]	C2: RANGE1 2.00000 m/s [U P] [SEL] [SET]	The switch name display at the bottom changes (three keys [UP], [SEL] and [SET]). At the same time, the cursor appears. (The digit on which the cursor is positioned is reverse-displayed.)
STEP2 [SEL]	C2: RANGE1 2.00000 m/s [U P] [SEL] [SET]	Move the cursor to the digit of the first unit using the [SEL] key.
STEP3 [UP] [SEL]	C2: RANGE1 3.93000 l/s [U P] [SEL] [SET]	Change the first unit to 1 using the [UP] key. Next, move the cursor to the digit of the second unit using the [SEL] key.
STEP4 [UP] [SEL]	C2: RANGE1 236.000 l/min [U P] [SEL] [SET]	Change the second unit to "min" using the [UP] key. Next, move the cursor to the digit you want to change, using the [SEL] key.
STEP5 [UP]↔[SEL]	C2: RANGE1 136.000 l/min [U P] [SEL] [SET]	Change the numeric value using the [UP] key. Repeat this operation until the setting value changes to the desired numeric value and press the [SET] key.
STEP6 [SET]	C2: RANGE1 100.000 l/min OK? [N O] [SET]	When you press the [SET] key, a message confirming you whether the setting is OK is displayed. If OK, press the [SET] key. If you want to redo the setting, press the [NO] key.

Key operation	Display example	Description
STEP7-1 [NO]	C2: RANGE1 2.00000 m/s [U P] [SEL] [SET]	Pressing the [NO] when you are asked "OK?" causes the span value to return to the previous value and enables you to redo the setting.
STEP7-2(=END) [SET]	C2: RANGE1 100.000 l/min [EXT] [ENT]	Pressing the [SET] key when you are asked "OK?" causes the setting to be determined. Then press the [EXT] key. You return to the menu screen. Pressing the [ENT] key enables you to restart span value change operation from a state of 100.000 l/min.

Note Unites of the measuring unit changes as shown below:

First unit

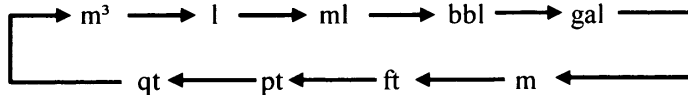

Second unit
(Time unit)



- However, the following first and second unit combinations cannot be selected:
m/min, m/h, m/d, ft/min, ft/h, ft/d

• **Changing the hysteresis**

The hysteresis is set to 3% at factory, unless otherwise specified.

Shown below is an example of changing the hysteresis from 3% to 5%.

Key operation	Display example	Description
	C6: RANGE HYS 03.0 %	Select "RANGE HYS" in the configuration item selection screen. The currently set hysteresis (3.0% in this example) is displayed. Then press the [ENT] key.
STEP1 [ENT]	C6: RANGE HYS 03.0 % [U P] [SEL] [SET]	The switch name display at the bottom changes (three keys [UP], [SEL] and [SET]) At the same time, the cursor appears. (The digit on which the cursor is positioned is reverse-displayed.)
STEP2 [SEL]⇔[UP]	C6: RANGE HYS 05.0 % [U P] [SEL] [SET]	Move the cursor to the desired digit using the [SEL] key and change the numeric value using the [UP] key. Repeat this operation to change the value to 5.0%. When the setting has changed to the desired numeric value, press the [SET] key to set the hysteresis temporarily.
STEP3 [SET]	C6: RANGE HYS 05.0 % OK?  [N O] [SET]	When you press the [SET] key, a message confirming you whether the setting is OK is displayed. If OK, press the [SET] key. If you want to redo the setting, press the [NO] key.
STEP4-1 [NO]	C6: RANGE HYS 03.0 % [U P] [SEL] [SET]	Pressing the [NO] when you are asked "OK?" causes the span hysteresis to return to the previous setting and enables you to redo the setting.
STEP4-2(=END) [SET]	C6: RANGE HYS 05.0 % [EXT] [ENT]	Pressing the [SET] key when you are asked "OK?" causes the setting to be determined. Then press the [EXT] key. You return to the menu screen. Pressing the [ENT] key enables you to restart hysteresis change operation from a state of 5.0%.

Note If you set a value exceeding 25.0%, *HIGH OVER SPEC.* is displayed and the setting returns to the one before change. Set a value once again.

8.2.14 Damping Constant

The damping constant is used to **moderate output fluctuations**. (The larger the damping constant, the more the output is averaged. But the **response to an input change will be slower**.) The damping constant can be set as follows:

The damping constant is set for **0.0 sec, 0.5 sec and 1 to 60 sec (in increments of 1 second)**

Note: 0.0 sec setting will work as equal to 0.1 sec damping constant.

Set 1 sec or more for normal operation.

If you set a value exceeding 60s, it is forcibly changed to 60s before data is written.

Proceed as follows to check or change the damping constant.

Shown below is an example of changing the damping constant from 0.0s to 10s.

Key operation	Display example	Description
	D: MEAS MODE →DAMPING LOW CUT ALM mA SET DSP LOW CUT LOW LIMIT [SEL] [ENT]	Select "DAMPING" in the configuration item selection screen.
STEP1 [ENT]	D1: DAMPING 02.0 s [EXT] [ENT]	The currently set damping constant (2.0s in this example) is displayed. Then press the [ENT] key. * Pressing the [EXT] key returns you to the menu screen.
STEP2 [ENT]	D1: DAMPING 02.0 s [U P] [SEL] [SET]	The switch name display at the bottom changes (three keys [UP], [SEL] and [SET]). At the same time, the cursor appears. (The digit on which the cursor is positioned is reverse-displayed.)
STEP3 [SEL]⇔[UP]	D1: DAMPING 10.0 s [U P] [SEL] [SET]	Move the cursor to the desired digit using the [SEL] key and change the numeric value using the [UP] key. Repeat this operation until the value changes to 10.0 s. When the value has changed to the desired value, press the [SET] key to set the damping constant temporarily.
STEP4 [SET]	D1: DAMPING 10.0 s OK?  [NO] [SET]	When you press the [SET] key, a message confirming you whether the setting is OK is displayed. If OK, press the [SET] key. If you want to redo the setting, press the [NO] key.
STEP5-1 [NO]	D1: DAMPING 02.0 s [U P] [SEL] [SET]	Pressing the [NO] key when you are asked "OK?" causes the damping constant to return to the previous value and enables you redo the setting.
STEP5-2(=END) [SET]	D1: DAMPING 10.0 s [EXT] [ENT]	Pressing the [SET] key when you are asked "OK?" causes the setting to be determined. Then press the [EXT] switch to return to the menu screen. Pressing the [ENT] key enables you to restart damping constant change operation from a state of 10.0s.

Note If you set a value exceeding 60s, it is forcibly changed to 60s before data is written.

8.2.15 Low Cutoff

The low cutoff is the value set just above 0% flow rate. **Flow rates below this level are treated as 0%, i.e. the current output is forcibly changed and fixed to 0%.**

The low cutoff can be set **from 0 to 10%** of the span and **in increments of 0.1%**.

Proceed as follows to check or change the low cutoff value.

Shown below is an example of changing the low cut value from 1.0% to 3.0%.

Key operation	Display example	Description
	D: MEAS MODE DAMPING →LOW CUT ALM mA SET DSP LOW CUT LOW LIMIT [SEL] [ENT]	Select "LOW CUT" in the configuration item selection screen.
STEP1 [ENT]	D2: LOW CUT 01.0 % [EXT] [ENT]	The currently set low cut value (1.0% in this example) is displayed. Then press the [ENT] key. * Pressing the [EXT] key returns you to the menu screen.
STEP2 [ENT]	D2: LOW CUT 01.0 % [U P] [SEL] [SET]	The switch name display at the bottom changes (three keys [UP], [SEL] and [SET]) At the same time, the cursor appears. (The digit on which the cursor is positioned is reverse-displayed.)
STEP3 [SEL]⇔[UP]	D2: LOW CUT 03.0 % [U P] [SEL] [SET]	Move the cursor to the desired digit using the [SEL] key and change the numeric value using [UP] key. Repeat this operation to change the setting value to 3.0%. When the value has changed to the desired value, press the [SET] key to set the low cut value temporarily.
STEP4 [SET]	D2: LOW CUT 03.0 % OK?  [N O] [SET]	When you press the [SET] key, a message confirming you whether the setting is OK is displayed. If OK, press the [SET] key. If you want to redo the setting, press the [NO] key.
STEP5-1 [NO]	D2: LOW CUT 01.0 % [U P] [SEL] [SET]	Pressing the [NO] key when you are asked "OK?" causes the low cut value to return to the previous value and enables you to redo the setting.
STEP5-2(=END) [SET]	D2: LOW CUT 03.0 % [EXT] [ENT]	Pressing the [SET] key when you are asked "OK?" causes the setting to be determined. Then press the [EXT] key, You return to the menu screen. Pressing the [ENT] key enables you to restart low cut value change operation from a state of 3.0%.

Note If you set a value exceeding 10.0%, *HIGH OVER SPEC.* is displayed and the setting returns to the one before change. Set a value once again.

8.2.16 Current Output Setting Used When an Alarm Occurs

In case an alarm occurs with the self-diagnostic function, the current output value will be fixed to the selected value.

Select the current output value used in case an alarm occurs from the following table.

● **Current output setting function in case an alarm occurs**

Selection	Current output setting used when an alarm occurs
UNDER 3.0mA	3.0mA or less
4.0mA	4.0mA
HOLD	Fixed to the selected value
OVER 24.0mA	24.0mA or more

The current output value at alarm generation can be checked/changed by the following procedure. Shown below is an example of changing the setting from UNDER 3.0mA to 4.0mA.

Key operation	Display example	Description
	D: MEAS MODE DAMPING LOW CUT →ALM mA SET DSP LOW CUT LOW LIMIT [SEL] [ENT]	Select "ALM mA SET" in the configuration item selection screen.
STEP1 [ENT]	D3: ALM mA SET UNDER 3.0mA [EXT] [ENT]	The current setting value (UNDER 3.0mA in this example) is displayed. Then press the [ENT] key. * Pressing the [EXT] key returns you to the menu screen.
STEP2 [ENT]	D3: ALM mA SET UNDER 3.0mA [U P] [DWN] [SET]	The switch name display at the bottom changes (three keys [UP], [DWN] and [SET]) At the same time, the cursor appears. (The digit on which the cursor is positioned is reverse-displayed.)
STEP3 [UP]/[DWN]	D3: ALM mA SET 4.0mA [U P] [DWN] [SET]	Change the selection item using the [UP]/[DWN] key. When you have selected the desired item, press the [SET] key.
STEP4 [SET]	D3: ALM mA SET 4.0mA OK?  [N O] [SET]	When you press the [SET] key, the selected item is set temporarily and a message confirming you whether the setting is OK is displayed. If OK, press the [SET] key. If you want to redo the setting, press the [NO] key.
STEP5-1 [NO]	D3: ALM mA SET UNDER 3.0mA [U P] [DWN] [SET]	Pressing the [NO] key when you are asked "OK?" causes the setting value to return to the previous value and enables you to redo the setting.
STEP5-2(=END) [SET]	D3: ALM mA SET 4.0mA [EXT] [ENT]	Pressing the [SET] key when you are asked "OK?" causes the setting to be determined. Then, press the [EXT] key. You return to the menu screen. Pressing the [ENT] key enables you to restart setting operation from a state of 4.0mA.

8.2.17 Display Low Cut Setting

The display low cut setting function enables you to set whether low cut treatment is to be reflected on the display value when you set the low cut value in 0.

To set the display low cut, select either of the following items listed in the table below.

- **Display low cut setting function**

Selection item	Display value
ON	Low cut treatment is applied to the display value.
OFF	Low cut treatment is not applied to the display value.

For example, if the low cut value is set to 10% and the input value from the detector is 5%, the display value will be as follows, depending on the display low cut setting:

Display low cut	Display value
ON	0.0%
OFF	5.0%

The display low cut setting can be checked/changed by the following procedure.
 Shown below is an example of changing the display cut setting from OFF to ON.

Key operation	Display example	Description
	D: MEAS MODE DAMPING LOW CUT ALM mA SET →DSP LOW CUT LOW LIMIT [SEL] [ENT]	Select "DSP LOW CUT" In the configuration item selection screen.
STEP1 [ENT]	D4: DSP LOW CUT OFF [EXT] [ENT]	The current setting value (OFF in this example) is displayed. Then press the [ENT] key. * Pressing the [EXT] key returns you to the menu screen.
STEP2 [ENT]	D4: DSP LOW CUT OFF [U P] [DWN] [SET]	The switch name display at the bottom changes (three keys [UP], [DOWN] and [SET]). At the same time, the cursor appears. (The digit on which the cursor is positioned is reverse-displayed.)
STEP3 [UP]/[DWN]	D4: DSP LOW CUT ON [U P] [DWN] [SET]	Change the selection item using the [UP]/[DWN] key. When you have selected the desired item, press the [SET] key.
STEP4 [SET]	D4: DSP LOW CUT ON OK?  [N O] [SET]	When you press the [SET] key, the selected item is set temporarily and a message confirming you whether the setting is OK is displayed. If OK, press the [SET] key. If you want to redo the setting, press the [NO] key.
STEP5-1 [NO]	D4: DSP LOW CUT OFF [U P] [DWN] [SET]	Pressing the [NO] key when you are asked "OK?" causes the setting value to return to the previous value and enables you to redo the setting.
STEP5-2(=END) [SET]	D4: DSP LOW CUT ON [EXT] [ENT]	Pressing the [SET] key when you are asked "OK?" causes the setting to be determined. Then press the [EXT] key. You return to the menu screen. Pressing the [ENT] key enables you to restart setting operation from a state of ON.

* The measurement value transmitted from the converter by communication is data after display low cut processing.

8.2.18 Output Low Limit Setting

This function enables you to set the current output low limit value.
To set the output low limit, select one of the items listed in the table below.

● **Output low limit setting function**

Selection item	Output low limit
4.0mA	Current not lower than 4.0mA (0%) is output.
3.2mA	Current not lower than 3.2mA (-5%) is output.
2.4mA	Current not lower than 2.4mA (-10%) is output.

* If the low cut value (0) has been set to a value **other than 0%**, the output low limit value is fixed to **4.0mA**, regardless of which value you have set.

The output low limit can be checked/changed by the following procedure.
Shown below is an example of changing the output low limit value **from 4.0mA to 2.4mA**.

Key operation	Display example	Description
	D: MEAS MODE DAMPING LOW CUT ALM mA SET DSP LOW CUT →LOW LIMIT [SEL] [ENT]	Select "LOW LIMIT" in the configuration item selection screen.
STEP1 [ENT]	D5: LOW LIMIT 4.0mA [EXT] [ENT]	The current setting value (4.0mA in this example) is displayed. Then press the [ENT] key. *Pressing the [EXT] key returns you to the menu screen.
STEP2 [ENT]	D5: LOW LIMIT 4.0mA [U P] [DWN] [SET]	The switch name display at the bottom changes (three keys [UP], [DWN] and [SET]). At the same time, the cursor appears. (The digit on which the cursor is positioned is reverse-displayed.)
STEP3 [UP]/[DWN]	D5: LOW LIMIT 2.4mA [U P] [DWN] [SET]	Change the selection item using the [UP]/[DWN] key. When you have selected the desired item, press the [SET] key.
STEP4 [SET]	D5: LOW LIMIT 2.4mA OK?  [N O] [SET]	When you press the [SET] key, the selected item is set temporarily and a message confirming you whether the setting is OK is displayed. If OK, press the [SET] key. If you want to redo the setting, press the [NO] key.
STEP5-1 [NO]	D5: LOW LIMIT 4.0mA [U P] [DWN] [SET]	Pressing the [NO] key when you are asked "OK?" causes the setting value to return to the previous value and enables you to redo the setting.
STEP5-2(=END) [SET]	D5: LOW LIMIT 2.4mA [EXT] [ENT]	Pressing the [SET] key when you are asked "OK?" causes the setting to be determined. Then press the [EXT] key. You return to the menu screen. Pressing the [ENT] key enables you to restart setting operation from a state of 2.4mA.

8.2.19 Still Water Zero Adjustment

Zero point adjustment must be performed in the state the fluid in the detector's measurement tube is held still.

Key operation	Display example	Description
	E: MEAS MODE →ZERO ADJUST [SEL] [ENT]	Select "ZERO ADJUST" in the configuration item selection screen.
STEP1 [ENT]	E1: ZERO ADJUST 01.0 % [EXT] [SET]	The current flow rate measurement value is displayed. Then press the [SET] switch. * Pressing the [EXT] key returns you to the menu screen.
STEP2 [SET]	E1: ADJUST READY 01.0 % [EXT] [SET]	When you press the [SET] key, the title display changes to ADJUST READY, enabling you to perform adjustment. * Pressing the [EXT] key returns you to the previous screen.
STEP3 [SET]Hold down	E1: ZERO ADJUST *ZERO ADJUST*	Hold down the [SET] key when ADJUST READY is displayed causes "ZERO ADJUST" to be displayed and still water zero adjustment to start. Switch operation is disabled during adjustment.
STEP4	E1: ZERO ADJUST 00.0 % [EXT] [SET]	After approximately 30 seconds, still water zero adjustment is completed and the flow rate measurement value after adjustment is displayed. Press the [EXT] to return to the menu screen.

Note 1: To start still water zero adjustment, **hold down the [SET] key.**

Note 2: Still water zero point adjustment is possible only when the flow rate value is within a **range of ± 1.25 m/s.**

Note 3: If you want to cancel the adjustment when **ADJUST READY** is displayed, press the **[EXT] key.** This returns you to the flow rate measurement value display screen.

8.2.20 Digital I/O

You can select the various digital I/O functions shown below.
See Chapter 10, "Digital I/O Functions." for details.

■ Digital Output Functions (DO1 is standard and DO2 is optional)

Selection item	Digital output functions
NO USE	Not used
H ALM	High limit alarm output
L ALM	Low limit alarm output
HH ALM	High-high limit alarm output
LL ALM	Low-low limit alarm output
EMPTY ALM	Empty alarm output
RNG SIG 1	Range output No. 1
RNG SIG 2	Range output No. 2
PRESET	Preset counter output
CONV. ALM	Converter failure alarm output
PULSE OUT	Pulse output
PULSE OUT FRD.	Pulse output (fixed forward flow)
PULSE OUT REV.	Pulse output (fixed reverse flow)
MRH ALM	Multiple range high limit alarm(option)
MRL ALM	Multiple range low limit alarm(option)

Notes:

- 1: When the range type is set to the forward/reverse multi-range, **if the pulse output (PULSE OUT) is selected, pulses of forward and reverse directions will be output.**
For setting method of the range type, see 0, "Span (range)."

■ Digital Input Function (optional)

Selection item	Digital input function
NO USE	Not used
CNT STA/STP	Totalizer Start/Stop
CNT RES/STA	Totalizer Reset/Start
RANGE SW	Remote selection of multi-range
ZERO ADJ.	Zero adjustment start
FIXED OUT	Fixed-value output control

■ Digital Output Active Status (Only for Alarm outputs)

Selection item	Alarm Output Action
NORMAL CLOSE	Normal; contact close, Alarm out; contact open
NORMAL OPEN	Normal; contact open, Alarm out; contact close

■ Digital Input Detective Level

You can select the level of the control signal used for controlling the total counter and pulse output with digital input, as shown below.

(Only when the digital input function is set to total counter control input)

Selection item	Digital input function setting	Total counter control signal
L LEVEL	CNT STA/STP (Total counter START/STOP)	H signal: Totalization STOP L signal: Totalization START
	CNT RES/STA (Total counter RESET/START)	H signal: Totalization START L signal: Totalization RESET
H LEVEL	CNT STA/STP (Total counter START/STOP)	H signal: Totalization START L signal: Totalization STOP
	CNT RES/STA (Total counter RESET/START)	H signal: Totalization RESET L signal: Totalization START

Digital output 1 (DO1), digital output 2 (DO2) and digital input (DI) can be selected by the configuration items as follows:

Digital output 1 (DO1)	DO1 FUNCTN
Digital output 2 (DO2)	DO2 FUNCTN
Digital input	DI FUNCTN
Active status of DO1	DO1 ALM STS
Active status of DO2	DO2 ALM STS
Digital input control signal	DI DET LV

■ To change the digital I/O functions:

The following example shows how to change the digital output 1 function from high alarm output (H ALM) to low alarm output (L ALM).

Key operation	Display example	Description
	F: MEAS MODE →DO1 FNUCTN DO2 FNUCTN DI FUNCTN DO1 ALM STS DO2 ALM STS DI DET LV [SEL] [ENT]	Select "DO1 FNUCTN" from the configuration item selection screen.
STEP1 [ENT]	F1: DO1 FNUCTN H ALM [EXT] [ENT]	The current setting value (H ALM in this example) is displayed. Then press the [ENT] key. * Pressing the [EXT] key returns you to the menu screen.
STEP2 [ENT]	F1: DO1 FNUCTN H ALM [U P] [DWN] [SET]	The switch name display at the bottom changes (three keys [UP], [DWN] and [SET]) At the same time, the cursor appears. (The digit on which the cursor is positioned is reverse-displayed.)
STEP3 [UP]/[DWN]	F1: DO1 FNUCTN L ALM [U P] [DWN] [SET]	Change the selection item using the [UP]/[DWN] key. When you have selected the desired item, press the [SET] key.
STEP4 [SET]	F1: DO1 FNUCTN L ALM OK?  [N O] [SET]	When you press the [SET] key, the selected item is set temporarily and a message confirming you whether the setting is OK is displayed. If OK, press the [SET] key. If you want to redo the setting, press the [NO] key.
STEP5-1 [NO]	F1: DO1 FNUCTN H ALM [U P] [DWN] [SET]	Pressing the [NO] key when you are asked "OK?" causes the setting value to return the previous value and enables you to redo the setting.
STEP5-2(=END) [SET]	F1: DO1 FNUCTN L ALM [EXT] [ENT]	Pressing the [SET] key when you are asked "OK?" causes the setting value to be determined. Press the [EXT] key. You return to the menu screen. Pressing the [ENT] key enables you to restart setting from a state of LALM.

8.2.21 Count Rate (Pulse Rate), Pulse Width Setting Mode, Pulse Width

You can set the **volume (count rate) per count (pulse)** for when the total count is output and the **pulse width** for when the total pulse is output to the external.

Total count output is not affected by the display setting but it is preferable to set total display for the main display setting or sub display setting, for checking the operation status.

You can switch between the count rate, pulse width setting mode and pulse width by the setting item number.

Count rate	COUNT RATE
Pulse width setting mode	PLS MODE
Pulse width	PLS WIDTH

- The count rate must be set so that the pulse output at 100% output will be within a range of **3.6 to 36000000 pulse/h (0.001 to 10000 pulse/s)**. If you set a value out of this range, an error message

HIGH OVER SPEC* or *LOW OVER SPEC

is displayed and the value changes to the one before change. Set a value once again.

Note: Count rate setting range

Example When the range is 3600m³/h (1m³/s)

Since the minimum value is 36000000 pulse/h,

$$3600(\text{m}^3/\text{h}) / 36000000(\text{pulse}/\text{h}) = 0.0001\text{m}^3 = 0.1\ell.$$

Since the maximum value is 3.6 pulse/h,

$$3600(\text{m}^3/\text{h})/3.6(\text{pulse}/\text{h}) = 1000\text{m}^3.$$

- The pulse width must be set to a value within a range of 0.3ms to 500ms. If you set a value exceeding 500 ms, the value is **forcibly changed to 500ms**.
- The pulse width must be **one half of the 100% output pulse frequency**. If a value exceeding the limit, regardless of the limit described in the section above, an error message

*** HIGH OVER SPEC ***

is displayed and the value returns to the one before change. Set a value once again.

If the pulse width is set to 0, it is **automatically** set to one half of the pulse frequency at 100% output. However, if the calculation result exceeds 100ms, it is **forcibly set to 100ms**.

- Either **AUTO** or **MANUAL** can be set for the pulse width setting mode.
Depending on the pulse width mode, the pulse width to be set varies as shown in the table below:

Selection item	Pulse width value to be set
AUTO	After the count rate is set, the pulse width is automatically set to one half of the pulse frequency at 100% output.
MANUAL	Even after the count rate is set, the pulse width is not changed. * However, if the pulse width is out of the setting range as a result of count rate setting, the screen is automatically switched to the pulse width setting screen after the count rate setting.

* If the count rate exceeds **1000 (pulse/s)**, the pulse width setting mode is limited to the **AUTO mode** only and you cannot perform manual setting.

Note: Pulse width setting range

Example 1 When the range is 3600m³/h (1m³/s) and the count rate is 0.001m³
Since the pulse rate is 3600 (m³/h) / 0.001(m³) = 3600000 pulse/h (1000 pulse/s),
the full scale frequency is 1ms.
Therefore, the pulse width can be set to 1ms x 40% = **0.4ms only**.

Example 2 When the range is 3600m³/h (1m³/s) and the count rate is 1000m³
Since the pulse rate is 3600(m³/h) / 1000(m³) = 3.6 pulse/h
(0.001 pulse/s), the full scale frequency is 1000000ms.
Therefore, the pulse width 1000000ms x 40% = 400000ms. However,
since the maximum value is 500ms, the pulse width **will be 500ms**.

Example 3 When the range is 3600m³/h (1m³/s), the count rate is 1m³ and the pulse width is set to 0ms
Since the pulse rate is 3600(m³/h) / 1(m³) = 3600 pulse/h (1 pulse/s),
the full scale frequency is 1000ms.
Therefore, the pulse width is 1000ms x 40% = 400ms. However, since the
maximum value is 100ms in the case of AUTO setting, the pulse width **becomes 100ms**.

The count rate and pulse width can be checked/changed by the following procedure.
 Shown below is an example of changing the count rate from 0.01m³ to 0.9 l.

Key operation	Display example	Description
	G1: COUNT RATE 0.01000 m3 [EXT] [ENT]	Select "COUNT RATE" in the configuration item selection screen. The currently set count rate (0.01m ³ in this example) is displayed. Then press the [ENT] key.
STEP1 [ENT]	G1: COUNT RATE 0.01000 m3 [U P] [SEL] [SET]	The switch name display at the bottom changes (three keys [UP], [SEL] and [SET]). At the same time, the cursor appears. (The digit on which the cursor is positioned is reverse-displayed.)
STEP2 [SEL]	G1: COUNT RATE 0.01000 m3 [U P] [SEL] [SET]	Move the cursor to the digit of the unit using the [SEL] key.
STEP3 [UP] [SEL]	G1: COUNT RATE 10.0000 [U P] [SEL] [SET]	Change the unit to l using the [UP] key. Next, move the cursor to the digit you want to change using the [SEL] key.
STEP4 [UP]↔[SEL]	G1: COUNT RATE 0.90000 [U P] [SEL] [SET]	Change the numeric value using the [UP] key. Repeat this operation to change the setting value to the desired numeric value and press the [SET] key.
STEP5 [SET]	G1: COUNT RATE 0.90000 OK? [NO] [SET]	When you press the [SET] key, a message confirming you whether the setting is OK is displayed. If OK, press the [SET] key. If you want to redo the setting, press the [NO] key.
STEP6-1 [NO]	G1: COUNT RATE 0.01000 m3 [U P] [SEL] [SET]	Pressing the [No] key when you are asked "OK?" causes the count rate to return to the previous value and enables you to redo the setting.
STEP6-2(=END) [SET]	G1: COUNT RATE 0.90000 [EXT] [ENT]	Pressing the [SET] key when you are asked "OK?" causes the setting value to be determined. Then press the [EXT] key. You return to the menu screen. Pressing the [ENT] key enables you to restart count rate change operation from a state of 0.9 l.

To set the pulse width setting mode or pulse width, select the relevant item shown below.
 Pulse width setting mode PLS MODE
 Pulse width PLS WIDTH

Note: The unit changes as shown below by pressing [▲].

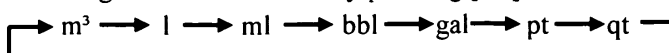

8.2.22 Preset Count Value

Preset value for the preset counter can be set.
 Preset count value can be set within 0 to 99999999.

Preset counter will not be affected by the indicating unit but it is recommended that one of the integrating units be set as the indicating unit so that the operating condition of the counter can be checked.

* Preset output function can be selected. For details, see 0, "Preset Output Function."

Note Preset counter operates only for forward direction counts.

Proceed as follows to check or change the preset count value.

■ **To change the preset count value:**

The following example shows how to change the preset count value from 500 to 1000.

Key operation	Display example	Description
	H1: MEAS MODE →PRESET CNT PRESET FNC [SEL] [ENT]	Select "PRESET CNT" in the configuration item selection screen.
STEP1 [ENT]	H1: PRESET CNT 00000500 [EXT] [ENT]	The currently set value (500 in this example) is displayed. Then press the [ENT] key. * Pressing the [EXT] key returns you to the menu screen.
STEP2 [ENT]	H1: PRESET CNT 00000500 [U P] [SEL] [SET]	The switch name display at the bottom changes (three keys [UP], [SEL] and [SET]). At the same time, the cursor appears. (The digit on which the cursor is positioned is reverse-displayed.)
STEP3 [SEL]↔[UP]	H1: PRESET CNT 00001000 [U P] [SEL] [SET]	Move the cursor to the desired digit using the [SEL] key and change the numeric value using the [UP] key. Repeat this operation to change the value the to 1000. When the value has changed to the desired numeric value, press the [SET] key to set the value temporarily.
STEP4 [SET]	H1: PRESET CNT 00001000 OK?  [N O] [SET]	When you press the [SET] key, a message confirming you whether the setting is OK is displayed. If OK, press the [SET] key. If you want to redo the setting, press the [NO] key.
STEP5-1 [NO]	H1: PRESET CNT 00000500 [U P] [SEL] [SET]	Pressing the [NO] key when you are asked "OK?" causes the setting value to return to the previous value and enables you to redo the setting.
STEP5-2(=END) [SET]	H1: PRESET CNT 00001000 [EXT] [ENT]	Pressing the [SET] key when you are asked "OK?" causes the setting value to be determined. Then press the [EXT] key. You return to the menu screen. Pressing the [ENT] key enables you to restart setting value change operation from a state of 1000.

8.2.23 Preset Point Output Function

The output function when a preset counter becomes the preset value can be set.
The various preset point output functions shown below can be selected.

■ **Preset Point Output Functions**

DI function	Preset point output level function
HOLD	Output status level hold
50ms PULSE	Pulse out (pulse width 50ms)
500ms PULSE	Pulse out (pulse width 500ms)

Note: If you set the preset point output function to "50ms PULSE" or "500ms PULSE", you need to set the preset count value to 1, 2, 5, 25, 125x10ⁿ. (If you set a value that does not meet this condition, the preset point output timing may be shifted when a total counter overflow occurs.)

Proceed as follows to check or change the preset point output functions.

● **To change the preset output function**

The following example shows how to change the present output function from Output condition hold (HOLD) to One-shot pulse output with pulse width of 50ms (**50ms PULSE**) .

Key operation	Display example	Description
	H: MEAS MODE PRESET CNT →PRESET FNC [SEL] [ENT]	Select "PRESET FNC" in the configuration item selection screen.
STEP1 [ENT]	H2: PRESET FNC HOLD [EXT] [ENT]	The current setting value is displayed (HOLD in this example). Then press the [ENT] key. * Pressing the [EXT] key returns you to the menu screen.
STEP2 [ENT]	H2: PRESET FNC HOLD [U P] [DWN] [SET]	The switch name display at the bottom changes (three keys [UP], [DOWN] and [SET]). At the same time, the cursor appears. (The digit on which the cursor is positioned is reverse-displayed.)
STEP3 [UP]/[DWN]	H2: PRESET FNC 50ms PULSE [U P] [DWN] [SET]	Change the selection item using the [UP]/[DWN] key. When you have selected the desired item, press the [SET] key.
STEP4 [SET]	H2: PRESET FNC 50ms PULSE OK?  [N O] [SET]	When you press the [SET] key, the selected item is set temporarily and a message confirming you whether the setting is OK is displayed. If OK, press the [SET] key. If you want to redo the setting, press the [NO] key.
STEP5-1 [NO]	H2: PRESET FNC HOLD [U P] [DWN] [SET]	Pressing the [NO] key when you are asked "OK?" causes the setting to return to the previous state and enables you to redo the setting.
STEP5-2(=END) [SET]	H2: PRESET FNC 50ms PULSE [EXT] [ENT]	Pressing the [SET] key when you are asked "OK?" causes the setting to be determined. Then, press the [EXT] key. You return to the menu screen. Pressing the [ENT] key enables you to restart setting operation from a state of 50ms PULSE.

8.2.24 Flow Rate High, Low, High-High and Low-Low limit Alarm Setting

You can set the high, low, high-high, or low-low limit of the flow rate at which an alarm is generated, as % value of the span flow rate of the set maximum range.

Flow rate high, low, high-high, and low-low limit alarm values can be set within a range of -10% to 110% (percentage to Range 1), in increments of 0.5%.

You can use the setting item number to switch between the flow rate high, low, high-high and low-low limit alarms ON/OFF and the flow rate high, low, high-high and low-low limit alarm values.

- | | |
|--|------------------|
| Flow rate high limit alarm ON/OFF | I1: H ALARM SET |
| Flow rate high limit alarm value | I2: H ALARM VAL |
| Flow rate low limit alarm ON/OFF | I3: L ALARM SET |
| Flow rate low limit alarm value | I4: L ALARM VAL |
| Flow rate high-high limit alarm ON/OFF | J1: HH ALARM SET |
| Flow rate high-high limit alarm value | J2: HH ALARM VAL |
| Flow rate low-low alarm ON/OFF | J3: LL ALARM SET |
| Flow rate low-low limit value | J4: LL ALARM VAL |

● **High and low limit (high-high and low-low limit) alarms ON/OFF**

Shown below is an example of switching the high limit alarm setting from OFF to ON.

Key operation	Display example	Description
	I: MEAS MODE →H ALM SET H ALM VAL L ALM SET L ALM VAL [SEL] [ENT]	Select "H ALM SET" in the configuration item selection screen.
STEP1 [ENT]	I1: H ALM SET OFF [EXT] [ENT]	The current setting value (OFF in this example) is displayed. Then press the [ENT] key. * Pressing the [EXT] key returns you to the menu screen.
STEP2 [ENT]	I1: H ALM SET OFF [UP] [DWN] [SET]	The switch name display at the bottom changes (three keys [UP], [DOWN] and [SET]). At the same time, the cursor appears. (The digit on which the cursor is positioned is reverse-displayed.)
STEP3 [UP]/[DWN]	I1: H ALM SET ON [UP] [DWN] [SET]	Change the selection item using the [UP]/[DWN] key. When you have selected the desired item, press the [SET] key.
STEP4 [SET]	I1: H ALM SET ON OK?  [NO] [SET]	When you press the [SET] key, the selected item is set temporarily and a message confirming you whether the setting is OK is displayed. If OK, press the [SET] key. If you want to redo the setting, press the [NO] switch.
STEP5-1 [NO]	I1: H ALM SET OFF [UP] [DWN] [SET]	Pressing the [NO] key when you are asked "OK?" causes the setting value to return to the previous value and enables you to redo the setting.
STEP5-2(=END) [SET]	I1: H ALM SET ON [EXT] [ENT]	Pressing the [SET] key when you are asked "OK?" causes the setting to be determined. Press the [EXT] key. You will return to the menu screen. Pressing the [ENT] key enables you to restart setting operation from a state of ON.

● **Changing the high, low, high-high, or low-low limit alarm value**

Shown below is an example of changing the high limit alarm value from +105% to +103%.

Key operation	Display example	Description
	I: MEAS MODE H ALM SET →H ALM VAL L ALM SET L ALM VAL [SEL] [ENT]	Select "HALM VAL" in the configuration item selection screen.
STEP1 [ENT]	I2: H ALM VAL +105.0 % [EXT] [ENT]	The currently set value (+105.0 in this example) is displayed. Then press the [ENT] key. * Pressing the [EXT] key returns you to the menu screen.
STEP2 [ENT]	I2: H ALM VAL █105.0 % [U P] [SEL] [SET]	The switch name display at the bottom changes (three keys [UP], [SEL] and [SET]). At the same time, the cursor appears. (The digit on which the cursor is positioned is reverse-displayed.)
STEP3 [SEL]⇔[UP]	I2: H ALM VAL +10█.0 % [U P] [SEL] [SET]	Move the cursor to the desired digit using the [SEL] key and change the numeric value using the [UP] switch. Repeat this operation to change the value to +103.0%. When you have selected the desired item, press the [SET] key to set the value temporarily.
STEP4 [SET]	I2: H ALM VAL +103.0 % OK? █ [N O] [SET]	When you press the [SET] key, a message confirming you whether the setting is OK is displayed. If OK, press the [SET] key. If you want to redo the setting, press the [NO] key.
STEP5-1 [NO]	I2: H ALM VAL █105.0 % [U P] [SEL] [SET]	Pressing the [NO] key when you are asked "OK?" causes the numeric value to return to the previous value and enables you to redo the setting.
STEP5-2(=END) [SET]	I2: H ALM VAL +103.0 % [EXT] [ENT]	Pressing the [SET] key when you are asked "OK?" causes the setting to be determined. Press the [EXT] key. You return to the menu screen. Pressing the [ENT] key enables you to restart setting value change operation from a state of +103.0%.

Note: If you set a value that is not within a range of -10% to +110%, * LOW OVER SPEC* or *HIGH OVER SPEC* is displayed and the value returns to the one before change. Set a value once again.

8.2.25 Empty Alarm Setting

You can set the empty alarm to detect an empty condition in the pipe. If the fluid is run out when the empty alarm is set to "On", **EMPTY ALARM** is displayed.

● Fluid empty alarm setting

Selection item	Contents
OFF	Fluid empty alarm disabled
NORMAL	Fluid empty alarm enabled Sensitivity level Low
SENSITIVE	Fluid empty alarm enabled Sensitivity level Middle
SENSITIVE-H	Fluid empty alarm enabled Sensitivity level High

* When setting the fluid empty alarm to be "enabled", usually set **NORMAL** (sensitivity level Low). Set a sensitivity level of SENSITIVE or SENSITIVE-H only when it is difficult to detect an empty condition due to the status of the operating fluid and the piping.

● Changing the empty alarm setting

Shown below is an example of changing the alarm setting from OFF to SENSITIVE-H.

Key operation	Display example	Description
	K: MEAS MODE →EMPTY ALM SELF CHECK ALM PRESET [SEL] [ENT]	Select "EMPTY ALM" in the configuration item selection screen.
STEP1 [ENT]	K1: EMPTY ALM OFF [EXT] [ENT]	The current setting value (OFF in this example) is displayed. Then press the [ENT] key. * Pressing the [EXT] key returns you to the menu screen.
STEP2 [ENT]	K1: EMPTY ALM OFF [U P] [DWN] [SET]	The switch name display at the bottom changes (three keys [UP], [DOWN] and [SET]). At the same time, the cursor appears. (The digit on which the cursor is positioned is reverse-displayed.)
STEP3 [UP]/[DWN]	K1: EMPTY ALM SENSITIVE-H [U P] [DWN] [SET]	Change the selection item using the [UP]/[DWN] key. When you have selected the desired item, press the [SET] key.
STEP4 [SET]	K1: EMPTY ALM SENSITIVE-H OK?  [NO] [SET]	When you press the [SET] key, the selected item is set temporarily and a message confirming you whether the setting is OK is displayed. If OK, press the [SET] key. If you want to redo the setting, press the [NO] key.
STEP5-1 [NO]	K1: EMPTY ALM OFF [U P] [DWN] [SET]	Pressing the [NO] key when you are asked "OK?" causes the setting value to return to the previous value and enables you to redo the setting.
STEP5-2(=END) [SET]	K1: EMPTY ALM SENSITIVE-H [EXT] [ENT]	Pressing the [SET] key when you are asked "OK?" causes the setting to be determined. Then press the [EXT] key. You return to the menu screen. Pressing the [ENT] key enables you to restart setting operation from a state of SENSITIVE-H.

8.2.26 Self-diagnosis ON/OFF Setting

You can set the self-diagnosis function to be "enabled" or "disabled."
 If the self-diagnosis function is disabled, no error message is displayed even if any of the errors listed below occurs.

- ROM defect
- RAM defect
- Own parameter error
- Excitation cable is not connected or it is disconnected
- Excitation circuit fault
- ADC circuit fault
- Total data destroy

Selection item	Description
OFF	Self-diagnosis function is disabled.
ON	Self-diagnosis function is enabled.

Error message is displayed in measurement sub screen.

● **Changing the self-diagnosis function setting**

Shown below is an example of changing the self-diagnosis setting from OFF to ON.

Key operation	Display example	Description
	K: MEAS MODE EMPTY ALM →SELF CHECK ALM PRESET [SEL] [ENT]	Select "SELF CHECK" in the configuration item selection screen.
STEP1 [ENT]	K2: SELF CHECK OFF [EXT] [ENT]	The current setting value (OFF in this example) is displayed. Then press the [ENT] key. * Pressing the [EXT] key returns you to the menu screen.
STEP2 [ENT]	K2: SELF CHECK OFF [U P] [DWN] [SET]	The switch name display at the bottom changes (three keys [UP], [DWN] and [SET]). At the same time, the cursor appears. (The digit on which the cursor is positioned is reverse-displayed.)
STEP3 [UP]/[DWN]	K2: SELF CHECK ON [U P] [DWN] [SET]	Change the selection item using the [UP]/[DWN] key. When you have selected the desired item, press the [SET] key.
STEP4 [SET]	K2: SELF CHECK ON OK?  [N O] [SET]	When you press the [SET] key, the selected item is set temporarily and a message confirming you whether the setting is OK is displayed. If OK, press the [SET] key. If you want to redo the setting, press the [NO] key.
STEP5-1 [NO]	K2: SELF CHECK OFF [U P] [DWN] [SET]	Pressing the [NO] key when you are asked "OK?" causes the setting value to return to the previous value and enables you to redo the setting.
STEP5-2(=END) [SET]	K2: SELF CHECK ON [EXT] [ENT]	Pressing the [SET] key when you are asked "OK?" causes the setting to be determined. Then press the [EXT] key. You return to the menu screen. Pressing the [ENT] key enables you to restart setting operation from a state of ON.

8.2.27 Alarm Output Preset Function Setting

Setting the digital output to "failure alarm output" enables a digital signal to be output when the converter self-diagnosis function detects a defect.

When setting the digital output, you specify **whether empty alarm is to be included** in the failure alarm output targets.

Selection item	Description
WITHOUT EMP	Empty alarm is not included in failure alarm output.
WITH EMP	Empty alarm is included in failure alarm output.

* For other failure alarm targets, see 0 "Self-diagnosis Function Setting."

● Changing the alarm output preset function

Shown below is an example of changing the alarm output preset function from WITH EMP to WITHOUT EMP.

Key operation	Display example	Description
	K: MEAS MODE EMPTY ALM SELF CHECK →ALM PRESET [SEL] [ENT]	Select "ALM PRESET" in the configuration item selection screen.
STEP1 [ENT]	K3: ALM PRESET WITH EMP [EXT] [ENT]	The current setting value (WITH EMP in this example) is displayed. Then press the [ENT] key. * Pressing the [EXT] key returns you to the menu screen.
STEP2 [ENT]	K3: ALM PRESET WITH EMP [UP] [DWN] [SET]	The switch name display at the bottom changes (three keys [UP], [DWN] and [SET]). At the same time, the cursor appears. (The digit on which the cursor is positioned is reverse-displayed.)
STEP3 [UP]/[DWN]	K3: ALM PRESET WITHOUT EMP [UP] [DWN] [SET]	Change the selection item using the [UP]/[DWN] key. When you have selected the desired item, press the [SET] key.
STEP4 [SET]	K3: ALM PRESET WITHOUT EMP OK?  [NO] [SET]	When you press the [SET] key, the selected item is set temporarily and a message confirming you whether the setting is OK is displayed. If OK, press the [SET] key. If you want to redo the setting, press the [NO] key.
STEP5-1 [NO]	K3: ALM PRESET WITH EMP [UP] [DWN] [SET]	Pressing the [NO] key when you are asked "OK?" causes the setting value to return to the previous value and enables you to redo the setting.
STEP5-2(=END) [SET]	K3: ALM PRESET WITHOUT EMP [EXT] [ENT]	Pressing the [SET] key when you are asked "OK?" causes the setting to be determined. Then press the [EXT] key. You return to the menu screen. Pressing the [ENT] key enables you to restart setting operation from a state of WITHOUT EMP.

8.2.28 Rate-Of-Change Limit and Control Limit Time

The rate-of-change limit is used to **eliminate high electrical noise** contained in the process flow signal.

To check electrical noise, two parameters are defined: **rate-of-change limit** (set in percent value of the span) and **control limit time** (set in units of seconds). Normally the flowmeter produces the analog output signal by sampling the flow rate signal at 1/24 (or 1/12) of a second sampling rate. If the sampled value **exceeds the set rate-of-change limit value based on the averaged flow rate value up until the sampled time, the system will reject that sampled value and instead the averaged value including the rate-of-change limit value in place of the rejected sampled value will be output.**

However, if the limit-exceeding sampled value continues for the same flow direction **for more than the preset control limit time, which data will be used as the output signal.** The setting ranges for these two parameters are as follows:

- **Rate-of-change limit** 0 to 30% / 50ms (in increments of 0.1%)
- **Control limit time:** 0 to 20 sec (in increments of 1 second)

Note

If "0" is set in either of these parameters, **the rate-of-change limit function is disabled.**

You can switch between the rate-of-change limit value and control limit time by the setting item number.

Rate-of-change limit	L1: LIMIT RATE
Control limit time	L2: LIMIT TIME

● Changing the rate of change limit

Shown below is an example of changing the rate-of-change limit value from 10.0% to 15.0%.

Key operation	Display example	Description
	L1: MEAS MODE →LIMIT RATE LIMIT TIME [SEL] [ENT]	Select "LIMIT RATE" in the configuration item selection screen.
STEP1 [ENT]	L1: LIMIT RATE 10.0 % [EXT] [ENT]	The current setting value (10.0% in this example) is displayed. Then press the [ENT] key. * Pressing the [EXT] switch returns you to the menu screen.
STEP2 [ENT]	L1: LIMIT RATE 10.0 % [U P] [SEL] [SET]	The switch name display at the bottom changes (three keys [UP], [SEL] and [SET]). At the same time, the cursor appears. (The digit on which the cursor is positioned is reverse-displayed.)
STEP3 [SEL]↔[UP]	L1: LIMIT RATE 15.0 % [U P] [SEL] [SET]	Move the cursor to the desired digit using the [SEL] key and change the numeric value using the [UP] key. Repeat this operation to change the value the to 15.0%. When you have selected the desired numeric value, press the [SET] key to set the value temporarily.
STEP4 [SET]	L1: LIMIT RATE 15.0 % OK?  [NO] [SET]	When you press the [SET] key, a message confirming you whether the setting is OK is displayed. If OK, press the [SET] key. If you want to redo the setting, press the [NO] key.
STEP5-1 [NO]	L1: LIMIT RATE 10.0 % [U P] [SEL] [SET]	Pressing the [NO] key when you are asked "OK?" causes the numeric value to return to the previous value and enables you to redo the setting.
STEP5-2(=END) [SET]	L1: LIMIT RATE 15.0 % [EXT] [ENT]	Pressing the [SET] key when you are asked "OK?" causes the setting value to be determined. Press the [EXT] key. You return to the menu screen. Pressing the [ENT] key enables you to restart setting value change operation from a state of +103.0%.

Note 1: If you try to set the value **more than 30.0%**, an error message *** HIGH OVER SPEC*** appears. Set the value within the specified range.

8.2.29 Fixed-Value Output

The fixed-value output is used to **output a fixed current and a fixed pulse output independently of the flow rate signal**. (The fixed pulse output is available only when DO1 is used for PULSE OUT function.) Fixed pulse cannot be output from D02 (optional).

The fixed-value output can be set in the ranges described below. (Current output and pulse output can be set and output at the same time.)

- **Fixed current output:** 2.4 to 24 mA (in increments of 0.1 mA)
- **Fixed pulse output:** 0 to 1000pps (in increments of 1 pps)

If fixed output is ON, the sub display is used for fixed output display in the measurement mode.

Operation when fixed output is ON

Current output	Set current output
Pulse output	Pulse output at the set pulse rate
Digital output other than pulse	State held
Display	Sub display: Used for fixed output display (Totalization is not performed.)

Display example:

*	F	I	X	E	D		O	U	T		*
*			1	0	0	0	0	P	P	S	*
*			2	0	.	0	m	A			*

Current output value (4-digit display including decimal point).
The unit is (mA) fixed.

Pulse display (max. 5 digits). The unit is (PPS) fixed.

This fixed-value output function **does not work in the calibration mode**.

When OFF is selected in the fixed output function, setting for output is not needed.

Proceed as follows to check or change the enable/disable status of the fixed-value output and its output values.



Fixed-value output enable/disable status and its output values, fixed current output and fixed pulse output can be selected by the configuration items as follows:

- | | |
|--|------------------------|
| Fixed-value enable/disable status | L1: FIXED OUT |
| Fixed current output | L2: FIXED CURR |
| Fixed pulse output | L3: FIXED PULSE |

● **Changing the fixed output function**

Shown below are the procedures for setting the fixed output to ON and setting the fixed current value/fixed pulse value. The fixed current value and fixed pulse value can be set independently.

Key operation	Display example	Description
	M: MEAS MODE →FIXED OUT FIXED CURR FIXED PULSE [SEL] [ENT]	Select "FIXED OUT" in the configuration item selection screen.
STEP1 [ENT]	M1: FIXED OUT OFF [EXT] [ENT]	The current setting value (OFF in this example) is set. Then press the [ENT] key. * Pressing the [EXT] key returns you to the menu screen.
STEP2 [ENT]	M1: FIXED OUT OFF [U P] [DWN] [SET]	The switch name display at the bottom changes (three keys [UP], [DWN] and [SET]). At the same time, the cursor appears. (The digit on which the cursor is positioned is reverse-displayed.)
STEP3 [UP]/[DWN]	M1: FIXED OUT ON [U P] [DWN] [SET]	Change the selection item using the [UP]/[DWN] key. When you have selected the desired item, press the [SET] key.
STEP4 [SET]	M1: FIXED OUT ON OK?  [N O] [SET]	When you press the [SET] key, the selected item is set temporarily and a message confirming you whether the setting is OK is displayed. If OK, press the [SET] key. If you want to redo the setting, press the [NO] key.
STEP5-1 [NO]	M1: FIXED OUT OFF [U P] [DWN] [SET]	Pressing the [NO] key when you are asked "OK?" causes the numeric value to return to the previous value and enables you to redo the setting.
STEP5-2 [SET]	M2: FIXED CURR 20.0 mA [EXT] [ENT]	Pressing the [SET] key when you are asked "OK?" causes the fixed current output ON setting to be determined and the fixed current value setting screen to be automatically developed. At the same time, the cursor appears. (The digit on which the cursor is positioned is reverse-displayed.)
STEP6 [SEL]↔[UP]	M2: FIXED CURR 12.0 mA [U P] [SEL] [SET]	Move the cursor to the desired digit using the [SEL] key and change the numeric value using the [UP] key. Repeat this operation to change the value to 12.0mA. When the value has changed to the desired numeric value, press the [SET] key to set the value temporarily.

Key operation	Display example	Description
STEP6 [SEL]⇔[UP]	M2: FIXED CURR 12.0 mA [U P] [SEL] [SET]	Move the cursor to the desired digit using the [SEL] key and change the numeric value using the [UP] key. Repeat this operation to change the value to 12.0mA. When the value has changed to the desired numeric value, press the [SET] key to set the value temporarily.
STEP7 [SET]	M2: FIXED CURR 12.0 mA  OK? [N O] [SET]	When you press the [SET] key, the selected item is set temporarily and a message confirming you whether the setting is OK is displayed. If OK, press the [SET] key. If you want to redo the setting, press the [NO] key.
STEP8-1 [NO]	M2: FIXED CURR 20.0 mA [U P] [SEL] [SET]	Pressing the [NO] key when you are asked "OK?" causes the numeric value to return to the previous value and enables you to redo the setting.
STEP8-2 [SET]	M3: FIXED PULSE 00000 PPS [EXT] [ENT]	Pressing the [SET] key when you are asked "OK?" causes the fixed output current value setting to be determined and the fixed output pulse setting screen to be developed automatically. At the same time, the cursor appears. (The digit on which the cursor is positioned is reverse-displayed.)
STEP9 [SEL]⇔[UP]	M3: FIXED PULSE 00100 PPS [U P] [SEL] [SET]	Move the cursor to the desired digit using the [SEL] key and change the numeric value using the [UP] key. Repeat this operation to change the value to 100 PPS. When the value has changed to the desired numeric value, press the [SET] key to set the value temporarily.
STEP10 [SET]	M3: FIXED PULSE 00100 PPS  OK? [N O] [SET]	When you press the [SET] key, a message confirming you whether the setting is OK is displayed. If OK, press the [SET] key. If you want to redo the setting, press the [NO] key.
STEP11-1 [NO]	M3: FIXED PULSE 00000 PPS [U P] [SEL] [SET]	Pressing the [No] key when you are asked "OK?" causes the numeric value to return to the previous value and enables you to redo the setting.
STEP11-2(=END) [SET]	M3: FIXED PULSE 00100 PPS [EXT] [ENT]	Pressing the [SET] key when you are asked "OK?" causes the setting value to be determined. Then press the [EXT] key. You return to the menu screen.

- Note 1:** If you set a value beyond the allowable range, 2.4mA or 24mA (in the case of fixed current output) or **24mA or 1000pps** (in the case of fixed pulse output) is forcibly set.
- Note 2:** The pulse width set in Section 8.2.13 is used for fixed pulse output. The pulse width must not be greater than one half of the fixed output setting frequency. However, the pulse width will be 40% of fixed output setting frequency if it **exceeds 1000pps**.
- Note 3:** If the fixed output is set to ON, the fixed output current value and fixed output pulse value setting screen is automatically developed. However, fixed output actually starts **when the fixed output pulse value setting is determined**. (If the fixed output current value and fixed output pulse value are set independently, fixed output starts when the relevant setting is determined independently.)

8.2.30 Zero Offset Adjustment

Zero offset can be easily applied to make the flowmeter outputs comparable to process values measured by other instruments.

If the zero adjustment described in “0 Still Water Zero Adjustment” can be performed, **this zero offset adjustment is not needed.**

■ **To change the zero offset value:**

Calculate the zero offset value with the following equation:

$$\text{Zero offset value (\%)} = \{(\text{actual flow rate}) - (\text{LF600F measured value})\}$$

* The zero offset value should be calculated in percent value for Range 1 of converter. See the following example.

(Example)

Measured condition	Flow rate	% in measuring span
Actual flow rate obtained from other instrument.	10.0 m ³ /min	50 %
LF600F measured value	10.5 m ³ /min	52.5 %
Zero offset	—————	-2.5 %

(If zero offset is set to -2.5 %, the converter will output 50.0 % flow rate instead of -2.5%.)

The following example shows how to change the zero offset value from +1.0% to -2.5%.

Key operation	Display example	Description
	N1: MEAS MODE →MANUAL ZERO [SEL] [ENT]	Select "MANUAL ZERO" in the configuration item selection screen.
STEP1 [ENT]	N1: MANUAL ZERO +001.0 % [EXT] [ENT]	The current setting value (+1.0% in this example) is displayed. Then press the [ENT] key. * Pressing the [EXT] key returns you to the menu screen.
STEP2 [ENT]	N1: MANUAL ZERO 001.0 % [U P] [SEL] [SET]	The switch name display at the bottom changes (three keys ([UP], [SEL] and [SET])). At the same time, the cursor appears. (The digit on which the cursor is positioned is reverse-displayed.)
STEP3 [SEL]↔[UP]	N1: MANUAL ZERO -002.5 % [U P] [SEL] [SET]	Move the cursor to the desired digit using the [SEL] key and change the numeric value using the [UP] key. Repeat this operation to change the value to -2.5%. When the value has changed to the desired numeric value, press the [SET] key to set it temporarily.
STEP4 [SET]	N1: MANUAL ZERO -002.5 % OK?  [N O] [SET]	When you press the [SET] key, a message confirming you whether the setting is OK is displayed. If OK, press the [SET] key. If you want to redo the setting, press the [NO] key.
STEP5-1 [NO]	N1: MANUAL ZERO 001.0 % [U P] [SEL] [SET]	Pressing the [NO] key when you are asked "OK?" causes the numeric value to return to the previous value and enables you to redo the setting.
STEP5-2(=END) [SET]	N1: MANUAL ZERO -002.5 % [EXT] [ENT]	Pressing the [SET] key when you are asked "OK?" causes the setting value to be determined. Then press the [EXT] key. You return to the menu screen. Pressing the [ENT] key enables you to restart setting value change operation from a state of +2.5%.

Note: The manual zero adjustment value can be set within a range of ± 1 m/s equivalent (± 10 % of the maximum range). If you set a value out of this range, an error message * HIGH OVER SPEC * or * LOW OVER SPEC * is displayed. In this case, **redo the setting**.

In addition, you perform zero adjustment with one-push key while the detector is filled with still water; the zero offset adjustment value will be **automatically cleared to 0.0%**.

8.2.31 Parameter initial settings list

The list of initial parameter settings is shown in the table below.

Parameter name	Initial setting value
Exciting current	Adjusted value when the product is shipped from the factory (described on the detector nameplate)
Meter size	Value requested when ordered.
Exciting frequency	24Hz * When meter size is 250 to 450mm: 12Hz When meter size is 500 or 600mm: 6Hz
Flow direction	NORMAL
Password	000
Address setting	126
Main display setting	gal/min
Sub display setting	COUNT B
Custom (coefficient)	0
Custom (unit)	" (7 characters are all blank spaces)
LCD density	3
Switch position	BOTTOM (screen bottom)
Range type	Value requested when ordered
Range 1 to Range 4	Value requested when ordered
Hysteresis	3.0 %
Damping constant	5.0 s
Low cut value	1.0 %
Output setting at alarm occurrence	4mA output
Display low cut	OFF
Output low limit setting	4mA
Digital output 1	PULSE OUT (Pulse output)
Digital output 2	EMPTY ALM (Empty alarm output)
Digital input	C RES/STA (Counter reset/start)
Digital output 1 status	NORMAL OPEN
Digital output 2 status	NORMAL OPEN
Digital input detection level	HIGH LEVEL
Count rate	100 gal
Pulse width setting mode	MANUAL
Pulse width	5 ms
Preset count value	00000000
Preset output function	HOLD
High limit alarm setting	OFF
High limit value	0.0 %
Low limit alarm setting	OFF
Low limit value	0.0 %
High high limit alarm setting	OFF
High high limit value	0.0 %
Low low limit alarm setting	OFF
Low low limit value	0.0 %
Fluid empty alarm	ON detection: NORMAL
Self-disgnosis function	ON
Alarm output preset	WITHOUT EMP (excluding the fuild empty alam)
Rate-of-change limit	0.0 %
Control time	0 s
Fixed output function	OFF
Manual zero	0.0 %

Note 1: Parameters specified separately when ordered are set as instructed.

Note 2: If an option board is not provided, Digital output 2 and Digital input functions do not work.

9. Calibration

9.1 Calibration Items

You can conduct the following in the calibration mode:

- Checks or calibrates the zero and span of the converter by using a simulation signal.
- Checks of the excitation current.

To change the mode to the calibration mode, see 0, “Mode Change.”

To check or change the zero and span of the converter and the excitation current value, follow the procedure described below.

**However, these are already checked and calibrated when shipped from the factory.
Do not change these settings unless it is necessary to calibrate in the field.**

Section	Configuration item	Display example
9.2.1	0 % flow rate calibration	FLOW CAL 0
9.2.2	50 % flow rate calibration	FLOW CAL 50
9.2.3	100 % flow rate calibration	FLOW CAL100
9.2.4	Checking the excitation current value	EX CURR DSP

9.2 Calibration Using Converter Signal Source

9.2.1 0 % Flow Rate Calibration (zero point calibration)

Using the converter's internal calibration circuit, 0% flow rate (hereafter called zero point) calibration can be made.

■ To check the zero point of flow measurement:

Key operation	Display example	Description
	O: MEAS MODE →FLOW CAL 0 FLOW CAL 50 FLOW CAL100 EX CURR DSP [SEL] [ENT]	Select "FLOW CAL 0" in the configuration setting item selection screen.
STEP1 [ENT]	O1: FLOW CAL 0 0.1 % [EXT] [SET]	The zero point by simulation input is displayed. Then press the [SET] key. * Pressing the [EXT] key returns you to the menu.
STEP2 [SET]	O1: ADJUST READY 0.1 % [EXT] [SET]	When you press the [SET] switch, the title display changes to ADJUST READY and enables you to perform calibration. * Pressing the [EXT] key returns you to the previous screen.
STEP3 [SET]Hold down	O1: FLOW CAL 0 *CAL 0% ADJ	<u>Holding down</u> the [SET] key when ADJUST READY is displayed, "**CAL 0% ADJ" is displayed and <u>zero point calibration starts</u> . Switch operation is disabled during calibration.
STEP4	O1: FLOW CAL 0 0.0 % [EXT] [SET]	After approximately 4 seconds, zero point calibration is completed and a new zero point is displayed. Press the [EXT] key. You return to the menu screen.

Note 1: To start calibration, hold down the [SET] key.

Note 2: To cancel the adjustment when ADJUST READY is displayed, press the [EXT] key. You return to the screen displaying the zero point by simulation input.

9.2.2 50 % Flow Rate Calibration

Using the converter's internal calibration circuit, **50% flow rate calibration** can be performed. For the calibration procedure, refer to the calibration procedure for 0% flow rate calibration (Or select the "FLOW CAL 50" from the menu).

9.2.3 100 % Flow Rate (Span) Calibration

Using the converter's internal calibration circuit, 100% flow rate calibration can be performed. For the calibration procedure, refer to the calibration procedure for 0% (Or select the "FLOW CAL100" from the menu.).

9.2.4 Checking the Excitation Current Value

You can monitor the exciting current value.

- To check the exciting current value:

Key operation	Display example	Description
	O: MEAS MODE FLOW CAL 0 FLOW CAL 50 FLOW CAL100 →EX CURR DSP [SEL] [ENT]	Select "EX CURR DSP" in the configuration item selection screen.
[ENT]	O4: EX CURR DSP 0.2000 A [EXT]	The excitation current value is displayed. Pressing the [EXT] key returns you to the menu screen.

- * The excitation current value is factory adjusted when shipped. Contact you're nearest Toshiba representative if any change is necessary.

10. Digital I/O Functions

The LF60*F series electromagnetic flowmeter is equipped with two-contact-point terminals (digital output terminals: one of them is optional), enabling you to use various functions including pulse output and alarm output.

Digital I/O functions are described below.

Functions	Necessary DO/DI	Description
Totalization	DO: 1 point DI: None to 1 point	<ul style="list-style-type: none"> ■ The converter totalizes volumetric flow rate. ■ The totalized volumetric flow can be output (pulse output) for each unit flow. ■ The totalizer and pulse signal (DO1 only) can be controlled (starts, stops and resets) with an external signal (DI).
Multiple Ranges	DO: 1 to 2 points DI: None to 1 point	Multiple measuring ranges can be switched according to the process flow rates either automatically or by an external signal (DI) .
Forward and Reverse flow measurements	DO: 1 point	■ Forward and reverse flows can be measured. The forward and reverse flow measurements can be used together with multiple range switching function.
High and Low Limit Alarms	DO: 1 to 2 points	■ Outputs an alarm signal (DO1 or DO2) when the process signal exceeds or stays below the limit values.
Totalizer Preset Point	DO: 1 point	■ When the totalized flow exceeds its preset count value, the converter outputs a contact output signal (DO1 or DO2) .
Remote Zero Adjustment	DI: 1 point	■ Zero adjustment (on-stream at zero flow rate) can be started by an external signal (DI).
Fixed-value Output	DI: 1 point	■ Fixed current output and fixed pulse output can be used to check a process loop circuit. An external signal (DI) can also be used to control this fixed-value output.
Converter Failure Alarm	DO: 1 point	■ The converter outputs an alarm signal (DO1 or DO2) if an error such as memory error or excitation circuit error occurs .
Multiple range High/Low alarm (option)	DO: 2 points DI: 1 point	■ Flow rate high/low alarm and high-high/low-low alarm are switched interlocking with the switching of high/low range by external input signal, and output HH/LL alarm .

10.1 Digital I/O Specifications

The specifications of the digital I/O terminals for the converter for electromagnetic flowmeter: LF600F are as follows:

■ **Digital Output 1(DO1) (standard)**

Output type: Transistor open collector
 Number of outputs: 1
 Capacity: 30 V dc, 200 mA maximum

■ **Digital Output 2(DO2)**

Output type: Solidstate relay (non polarity)
 Number of outputs: 1
 Capacity: 150 V dc, 150 mA maximum
 150 V ac(peal-to-peak), 100 mA maximum

■ **Digital Input (DI)**

Input signal: 20 to 30 V dc voltage signal
 • High input level—20 to 30 V dc
 • Low input level—2 V dc maximum
 Input resistance: Approximately 2.7 kΩ
 Number of inputs: One point

- Each I/O terminal can be used as a specified function terminal when selected.
- Terminal COM is the signal COMMON for the other three terminals (DO1, DO2 and DI).
- Each terminal is isolated from the internal circuits.
 (The output terminals are not isolated from each other.)
- In standard specification (without digital I/O), semiconductor contact, photo coupler, and resistor are not built in. Left DO2 and DI unconnected.

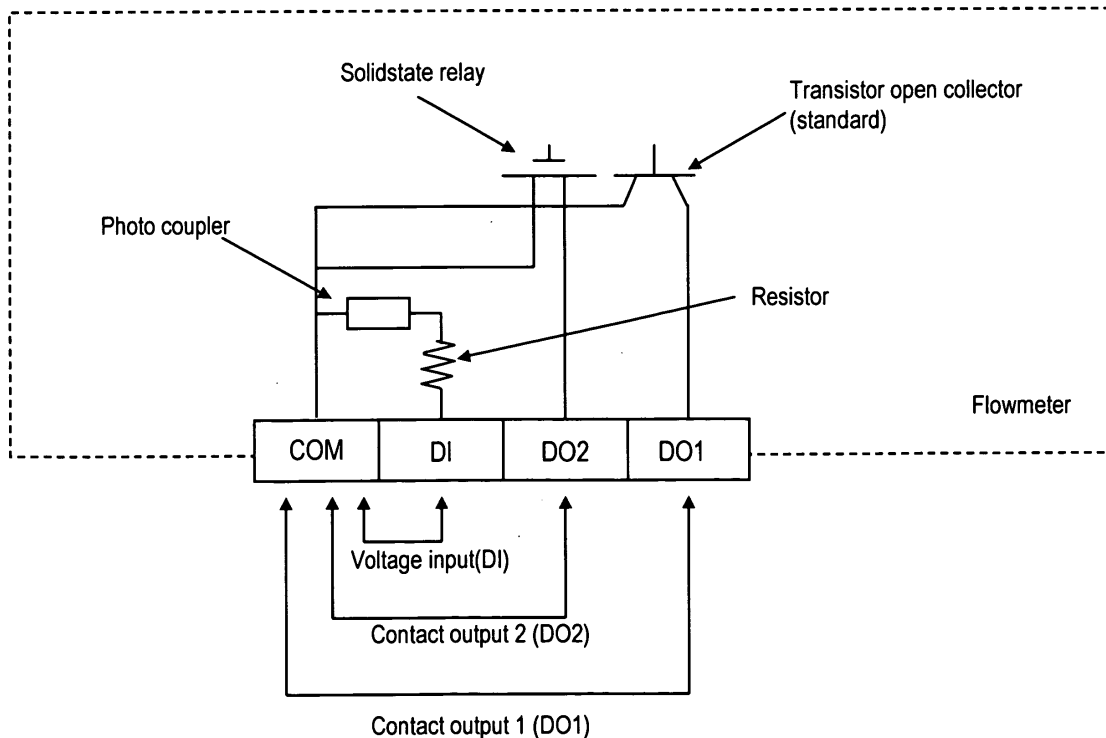

10.2 Totalizer and Pulse Output

To use the totalizer and pulse output for external use, proceed as follows.

Counting Rate and Pulse Width Settings

- Set the counting rate (flow volume per count) and the pulse width. Refer to 0, "Counting Rate".
 - * The counting rate should be set so that its rate for 100% flow rate output is within the range from 3.6 to 3600000 pulses/h (1/1000 to 1000 pulses/s) (Note 2)
 - * The pulse width can be set from 0.3ms to 500ms. The pulse width should be set to less than half of the pulse rate for 100% flow rate output. (Note 3)
- If the pulse width setting mode is AUTO, the pulse width is automatically set. If the pulse width setting mode is MANUAL, set it after checking the receivable signal width of the receiving measuring meter.
If the pulse output is not used, pulse width setting is not needed.

DO function setting

- According to Section 8.2.20 "Digital I/O", set the digital output 1 (DO1) to pulse output (PULSE OUT).
- If the digital output function has been disabled at count rate setting (no use), it is automatically set to pulse output.
- This is not needed if the pulse output is not used.

Measurement Mode

- Set the operation mode of the system to the measurement mode. Refer to 7.3.1, "Mode Change."

Continued to next page

Continued from previous page

Clear (reset) the totalizer. (note1)

- Clear the count value by the [CLR] key on the totalization control screen.
- If you have changed the counting rate, clear (reset) the totalizer before you start the totalizer.

Start the totalizer. (note1)

- Start counting by the [STA] key on the totalization control screen and make sure "CNT" is shown on the display.

- Notes
1. The LF600F converter has a function to stat/stop the counter operation or clear the internal counter.
For details of the operation method, see "Totalizer Operation."
 2. Example for counting rate:
The counting rate should be set so that its rate for 100% flow rate output is within the range from the minimum value (36000000 pulses/h) to the maximum value (3.6 pulses/h).

Example

In the case of range 3600m³/h (1m³/s),

Minimum value: Since the counting rate is 36000000 pulses/h,
3600 (m³/h) / 36000000 (pulses/h) = 0.001m³ = 0.1 L

Maximum value: Since the counting rate is 3.6 pulses/h,
3600 (m³/h) / 3.6 (pulses/h) = 1000m³

3. Example for pulse width:

The pulse width can be set from 0.3ms to 500ms in increments of 1ms. However, the pulse width should be set to less than 40% of the pulse rate due to the setting range and counting rate.

If "0" is set, the pulse width automatically will be set to 40% of the pulse rate (100ms max.)

Example1

Case	Range	:3600m ³ /h (1m ³ /s)
	Counting rate(pulse rate)	:0.001m ³

the pulse rate

: $3600(\text{m}^3/\text{h}) / 0.001(\text{m}^3) = 36000000 \text{ pulses/h}$
 $= 1000 \text{ pulses/p}$

the pulse rate for full scale = 1ms

*the pulse width = 1ms x 40% = 0.4ms

Example2

Case	Range	:3600m ³ /h (1m ³ /s)
	Counting rate (pulse rate)	:1000m ³

the pulse rate

: $3600(\text{m}^3/\text{h}) / 1000(\text{m}^3) = 3.6 \text{ pulses/h} = 0.001 \text{ pulses/p}$

the pulse rate for full scale = 1000000ms

the pulse width(Max.) = 1000000ms x 40% = 400000ms

but, the pulse width is 500ms Max.

* the pulse width(Max.) = **500ms**

Example3

Case	Range	:3600m ³ /h (1m ³ /s)
	Counting rate (pulse rate)	:1m ³
	Setting pulse width	:0ms (automatically set)

the pulse rate

: $3600(\text{m}^3/\text{h}) / 1(\text{m}^3) = 3600 \text{ pulses/h} = 1 \text{ pulses/p}$

the pulse rate for full scale = 1000ms

the pulse width(Max.) = 1000ms x 40% = 400ms

but, the pulse width that automatically set is 100ms Max.

* the pulse width (Max.) = **100ms**

Totalizer Operation

- Using control keys on the panel (option)

To start, stop or clear (reset) the totalizer, follow the procedure described below:

Key operation	Display example	Description
	FLOW 2.000 m/s RANGE1 5.000 m/s [CNT] [SET]	The measured value is displayed (measurement mode).
[CNT]	COUNT CTRL TOTAL CNT 100 FOR [STA] [CLR] [EXT]	Pressing the [CNT] key when you are in the measurement mode causes the screen to switch to the total counter operation screen. In the sub display area of this screen, the total counter value (both sides) is automatically displayed. In addition, the [STA], [CLR] and [EXT] keys are displayed.
* When the total counter is operating, [STP] is displayed. While the total counter is stopped, [STA] is displayed. * If you enter a wrong password at password setting, the [CLR] key is not displayed.		
[STA]	COUNT CTRL TOTAL CNT 100 FOR CNT [STP] [CLR] [EXT]	Pressing the [STA] key causes the total counting to start and "CNT" to be displayed on the screen. In addition, the [STA] key changes to the [STP] key.
[CLR]	COUNT CTRL TOTAL CNT 0 FOR CNT [STP] [CLR] [EXT]	Pressing the [CLR] key causes the total counter value to be cleared.
[EXT]	FLOW 2.000 m/s RANGE1 5.000 m/s	Pressing the [EXT] key causes you to return to the measurement mode.

- Notes: 1. Since the flow direction code is B (bidirectional flow (Forward/Reverse directions) automatic switching),
- When you select forward/reverse multi-range,
 - the forward direction totalized value (count value) is displayed for operation in the forward direction range.
 - the reverse direction totalized value (count value) is displayed for operation in reverse direction range.
2. When you reset the counter, the flow counts for **both directions will be cleared to zero.**
3. Non-volatile memory is used to store the totalizer counter value. Therefore, the value **will be retained** in the memory even if the power is cut off.

■ **Using the digital input signal**

Remote operations for the totalizer and pulse output can be conducted using the digital input signal. The following functions in the table can be performed. See 0 “Digital I/O” to select these functions.

Operation with the digital input signal (Initial setting: H level in control level)

Digital input (DI) Functions	DI voltage level	Totalizer and pulse output
Totalizer Start/Stop	L level	Stops the totalizer and the pulse output.
	H level	Start the totalizer and the pulse output.
Totalizer Reset/Start	H level	Stops and clears (resets) the totalizer.
	L level	Start the totalizer and the pulse output.

You can reverse the digital input detective level. For detail, see 8.2.12 “Digital Input Detective Level.”

- * Select H level (1:H LEVEL) : The operation with the digital input signal is same as the standard converter shown in the above table.
- * Select L level (0:L LEVEL) : The operation with the digital input signal is same as the standard converter shown in the below table.

Operation with the digital input signal (Control signal level: L level in control level)

Digital input (DI) Functions	DI voltage level	Totalizer and pulse output
Totalizer Start/Stop	L level	Start the totalizer and the pulse output.
	H level	Stops the totalizer and the pulse output.
Totalizer Reset/Start	H level	Start the totalizer and the pulse output.
	L level	Stops and clears (resets) the totalizer.

10.3 Multi-range Functions

Multi-range functions can be set under the configuration item "RANGE TYPE." Four types of multi-range configurations are available as shown below:

- (1) Automatic selection of unidirectional flow multi-range
- (2) Automatic selection of bidirectional flows multi-range
- (3) Remote selection of unidirectional flow multi-range with an external signal
- (4) Remote selection of bidirectional flows multi-range with an external signal

Proceed as follows to use the multi-range functions.

Range setting

- Set as follows referring to 0, "Span (Range),"
 1. Select "RANGE TYPE."
 2. Set the span for ranges 1 to 4.
 3. Set the hysteretic value.

DO/DI function setting

- Set DO1 and/or DO2 to use them as range outputs. Refer to 0, "Digital I/O"
- To use multi-range selected with a remote signal, **set the switch to multi-range selected by external signal in DI.**

■ Output performance of multi-range functions

(1) Automatic selection of unidirectional flow multi-range with an internal signal

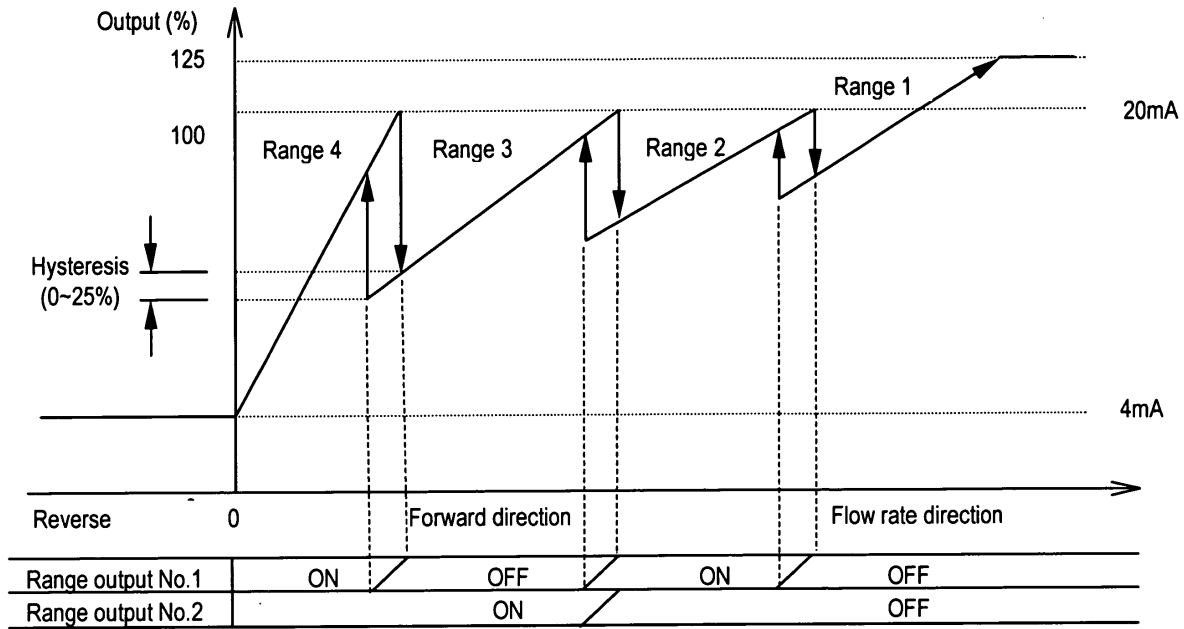

- Current output when fluid flows in the reverse direction is the value set for the output low limit (any one of 2.4/3.2/4.0mA).

(2) Automatic selection of bidirectional flows multi-range with an internal signal

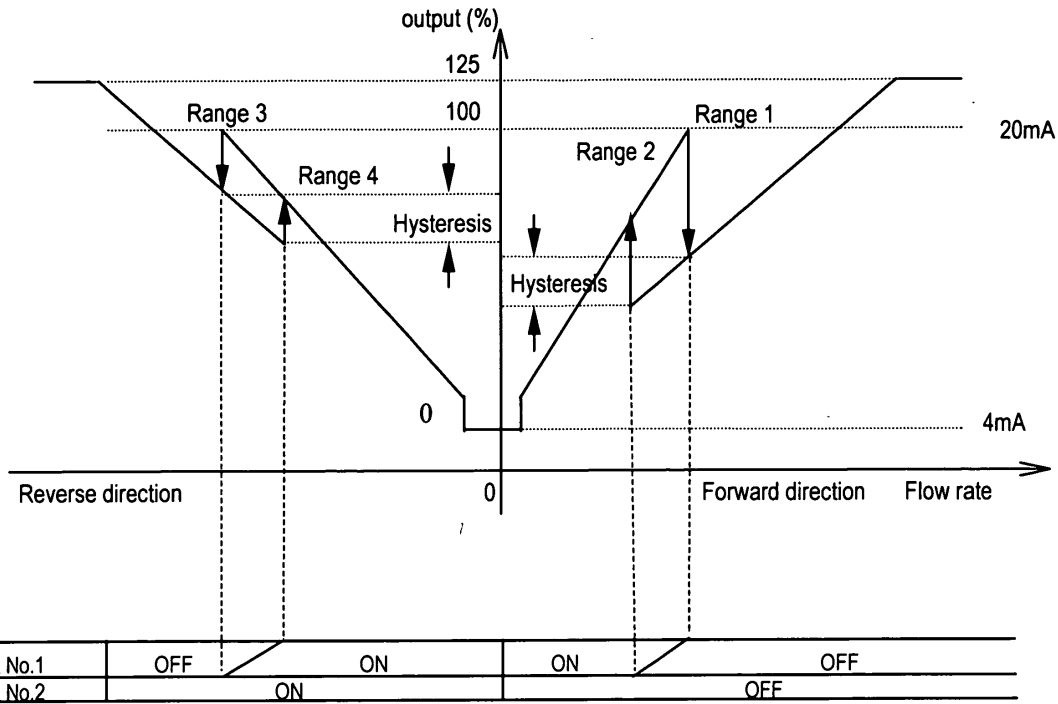

■ Reverse to Forward direction change

■ Forward to Reverse direction change

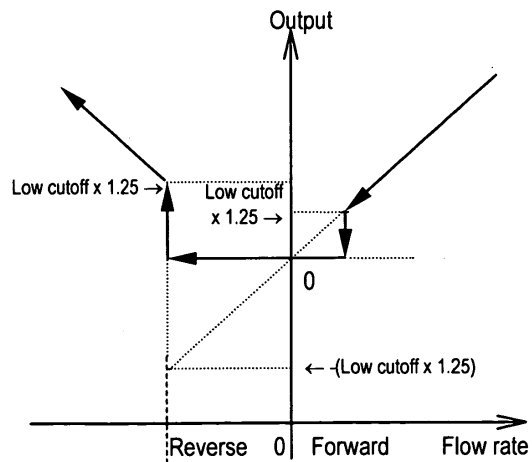
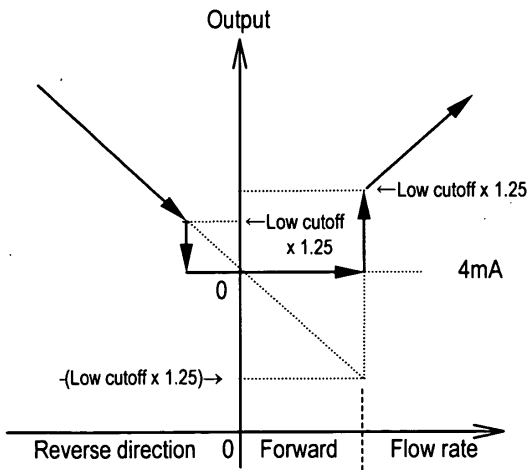

From forward range to reverse range

(3) Remote selection of unidirectional flows multi-range with an external signal

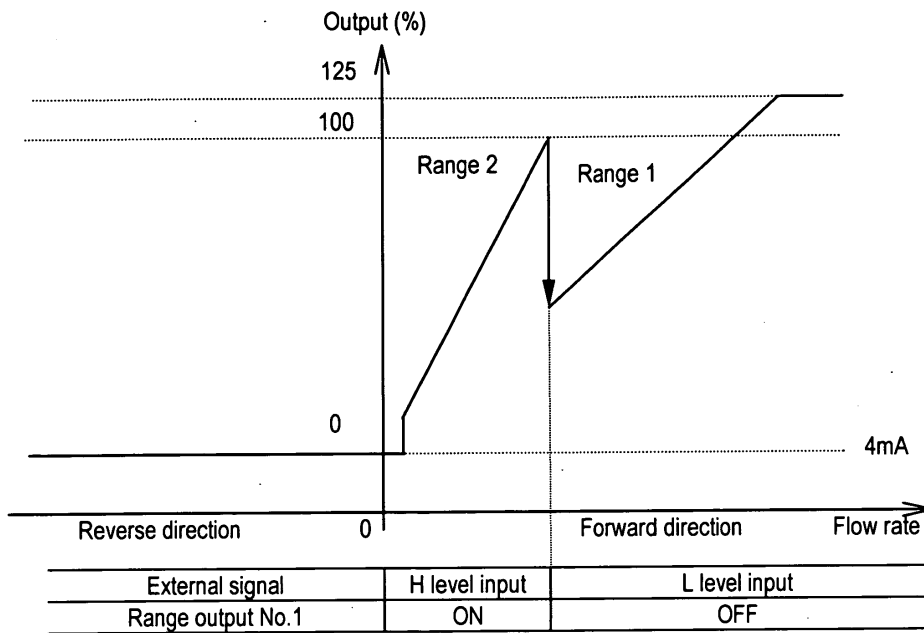

- Current output when fluid flows in reverse direction is the output low limit setting (any one of 2.4 / 3.2 / 4.0mA).

(4) Remote selection of bidirectional flows multi-range with an external signal

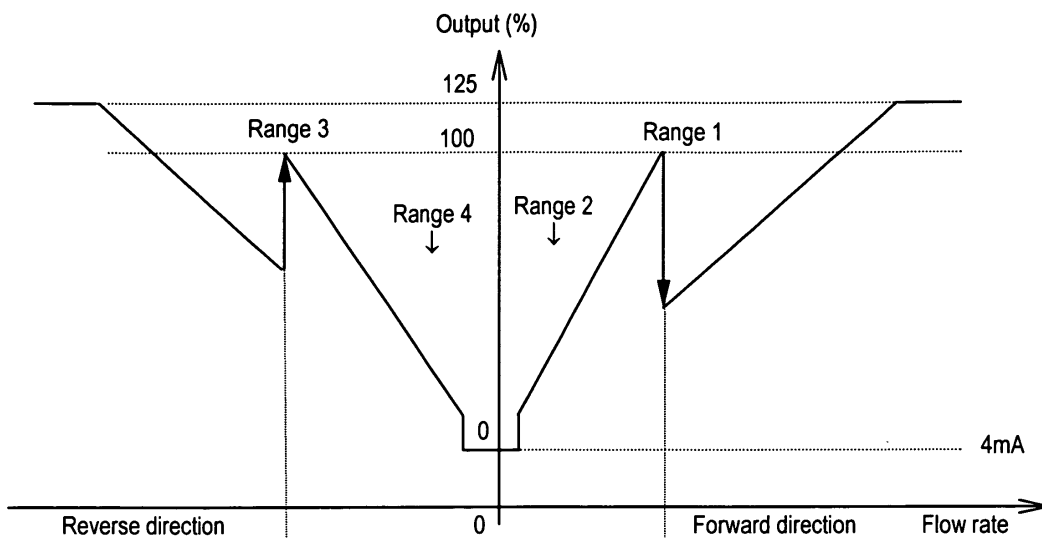

External signal	L level	H level	H level	L level
Range output No.1	OFF	ON	ON	OFF
Range output No.2	ON		OFF	

■ Reverse to Forward direction change

■ Forward to Reverse direction change

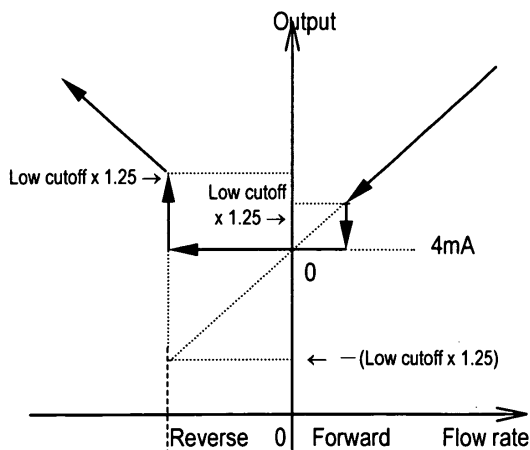
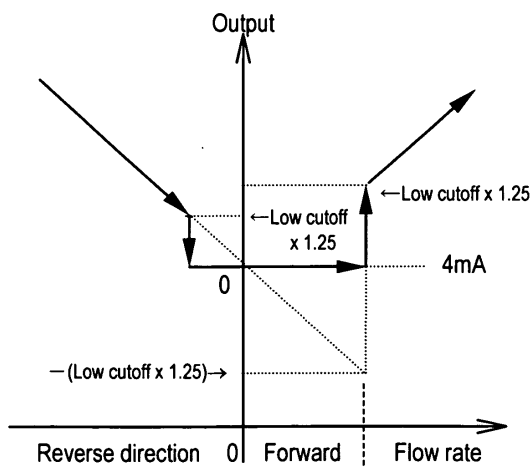

Range output No.2	ON	OFF
-------------------	----	-----

From reverse range to forward range

Range output No.2	ON	OFF
-------------------	----	-----

From forward range to reverse range

10.4 High/Low, High-high or Low-low Limit Alarm

To use the flow rate high, low, high-high or low-low limit alarm, follow the procedure below.

High and Low limit value setting

- Set the high and/or low limit alarm enable/disable status to ON and set the limit value for high and/or low alarm. See 0, “**Flow Rate High, Low, High-High and Low-Low limit Alarm Setting.**”
To disable the high or low limit alarm, set its enable/disable status to OFF.

High-high or low-low limit alarm value setting

- Set the high-high and/or low-low limit alarm enable/disable status to ON and set the limit value for high and/or low alarm. See 0, “**Flow Rate High, Low, High-High and Low-Low limit Alarm Setting.**”
To disable the high or low limit alarm, set its enable/disable status to OFF.

DO function setting

- According to 0 "Digital I/O", set the digital output 1 and 2 functions (DO1, D02) to high limit alarm output/low limit output alarm or high-high limit alarm output/low-low limit alarm output and select the active status for alarm output, **Normal Open or Normal Close.**

■ High and Low Limit Alarm Output Performance (Same as for High High/Low Low limit Alarm Output)

• Single range performance

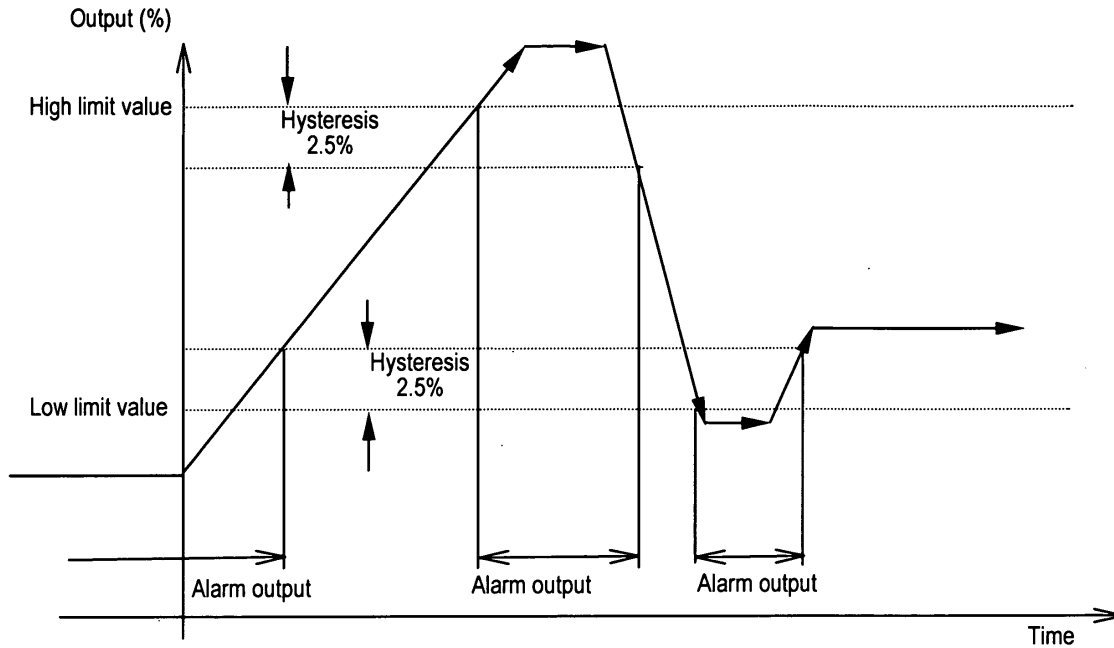

• Multi-range performance

In an example shown below, a low limit alarm is set for the Range 2 and a high limit alarm is set for the Range 1.

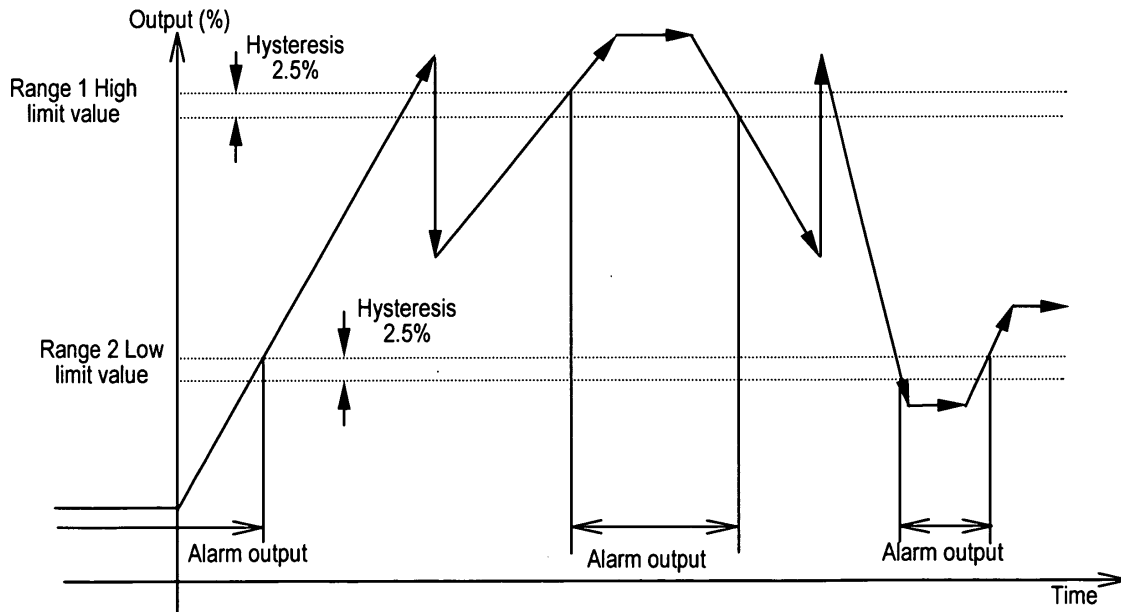

* When an alarm output condition occurs, Digital output 1 and 2 change to the output status set for an alarm output condition. **Alarm output contact is open while the converter is powered off.**

10.5 Preset Count Output

Using this preset count output function, the converter can output a contact signal when the totalized flow reaches its preset value (preset count value). Proceed as follows to use this function.

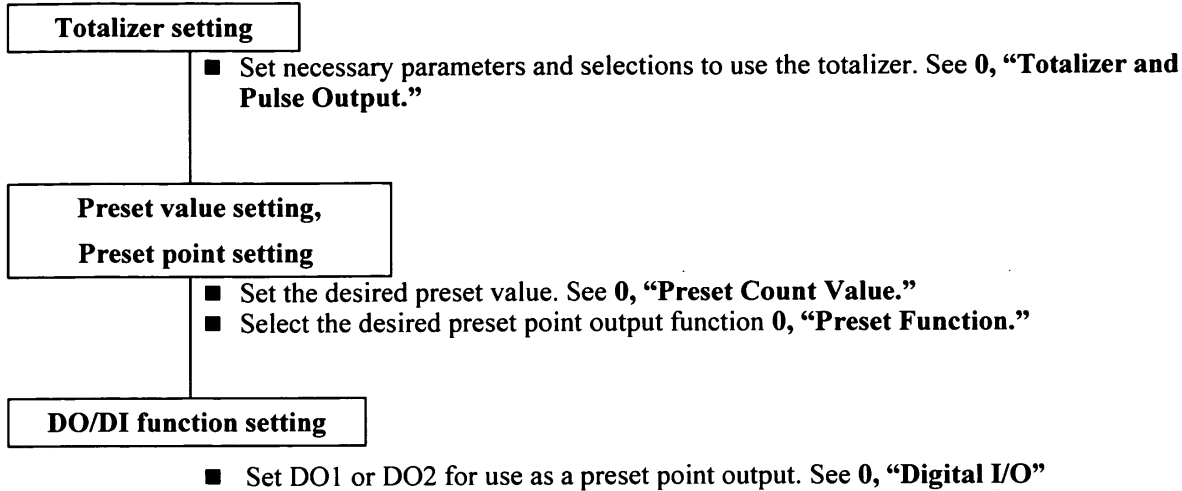

In addition, if you want to reset the totalizer by an external signal input, set DI to the totalizer counter **RESET/START**. (Set F3: DI FUNCTN to 2: C RES/STA.)

Set the DI control signal level in accordance with the external input signal following 8.2.20, “Digital Input Control signal Level.”

When the key switch in the converter is used to reset the counter, the digital input function (DI) setting is not needed.

■ Preset count output performance

(1) The following is an example for totalizer flow counts output in which the totalizer is reset with an external signal (when preset output status level hold mode is set (contact ON)).

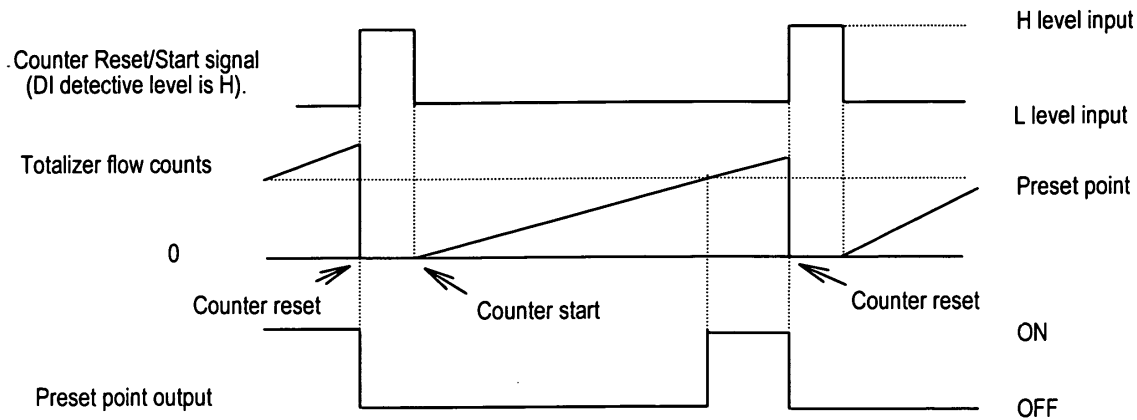

Input/Output signal time chart

* When the Reset/Start signal is in H level (DI counter control signal level: H), the totalizer is reset to zero and stops counting. When the Reset/Start signal goes to L level, the totalizer starts counting. The preset point output goes ON when the totalizer counts reaches the preset point, and the output goes OFF when the totalizer is reset to zero.

(2) The following is an example for totalizer flow counts output in which the totalizer is reset with an external signal (when one-shot pulse output mode is set).

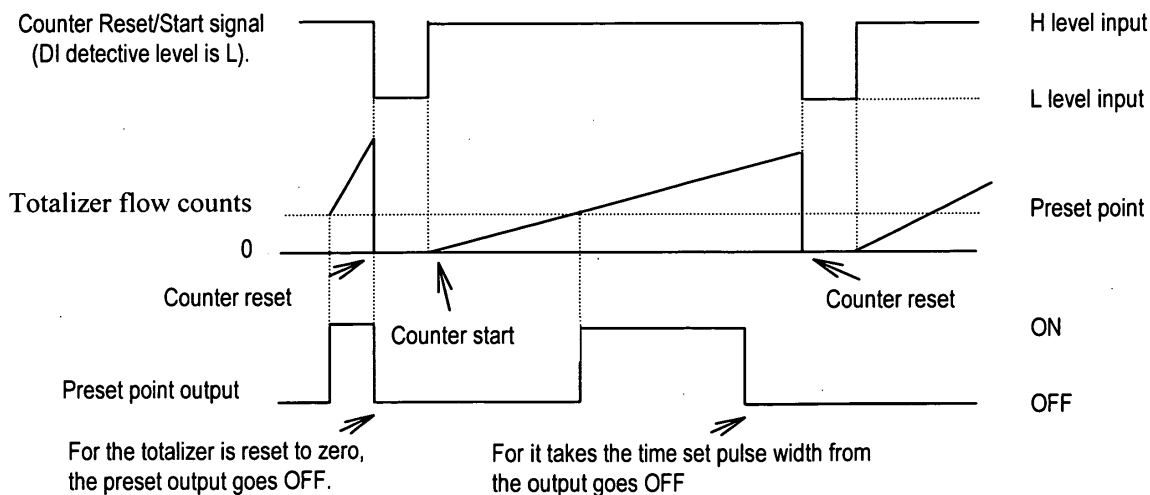

Input/Output signal time chart

* When the Reset/Start signal is in L level (DI counter control signal level: L), the totalizer is reset to zero and stops counting. When the Reset/Start signal goes to H level, the totalizer starts counting.

The preset point output goes ON when the totalizer counts reaches the preset point. The output goes OFF when the totalizer is reset to zero or when it takes the time set pulse width from the output goes ON.

(3) The following is an example for one-shot pulse output.

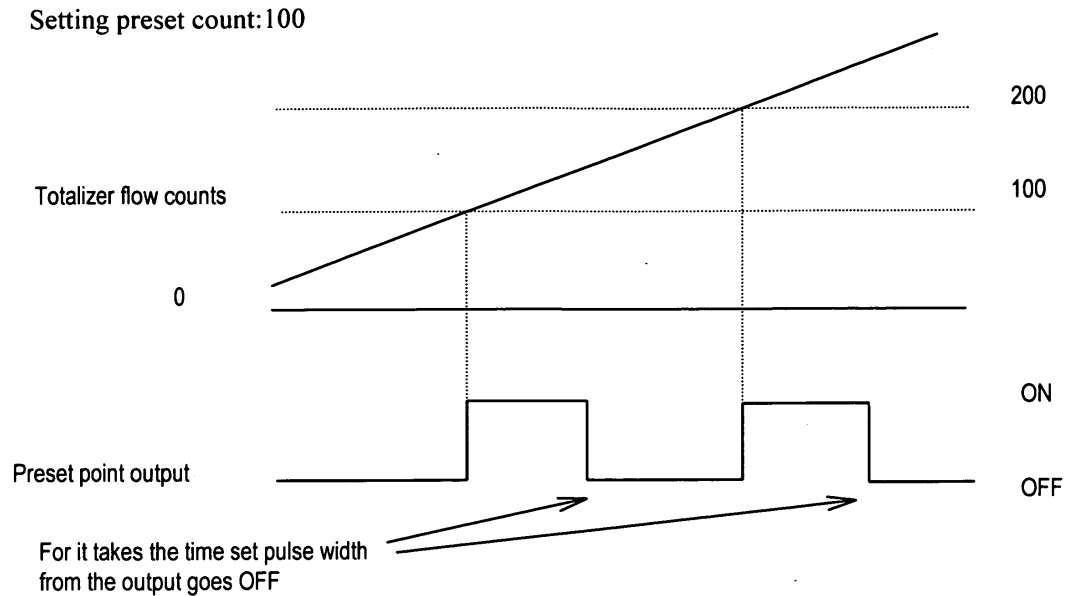

Input/Output signal time chart

* Preset output goes **ON** when the count value exceeds the preset value of 100 and the preset output goes **OFF** when its width reaches the set pulse width.
 When the preset value exceeds 100, the preset value is changed to 200 (adding the preset count of 100 to the current preset value of 100).
 Then, the preset output goes **ON** when the count value exceeds the preset value of 200, and the preset output goes **OFF** when its width reaches the set pulse width.
 When the preset value exceeds 200, the preset value is changed to 300 (adding the preset count of 100 to the current preset value of 200).

Note: When the one-shot pulse output function is selected, if its pulse width is large compared with the update period of the preset value. The output stays ON. To make sure to output as one-shot pulse, set the preset value reach interval to be 2 signals or more of the pulse width setting value.

Preset Pulse Width	The Interval of that Totalizer reaches the Preset Point	Example) Count rate:0.01 l Flow verosity:10 l/s Totalizer count up rate:1ms/COUNT
50ms	More than 100ms	Preset Count: more than 100
500ms	More than 1000ms	Preset Count: more than 1000

10.6 Remote Zero Adjustment

On-stream zero adjustment in a zero flow rate condition can be started with an external signal.

To do this, set DI as a zero adjustment start signal. See 8.2.20, "Digital I/O"

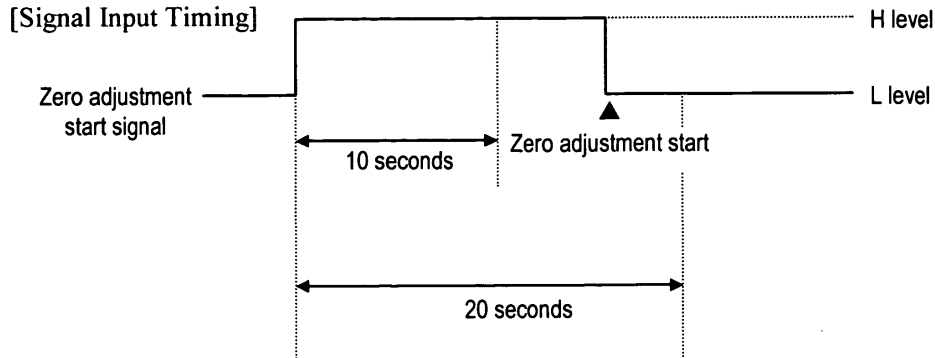

* The start signal must be set to H level first, then it must go to L level after the passage of more than 10 seconds but not more than 20 seconds, as shown above.
If the signal does not go to L level within this specified period, it will be ignored.

10.7 Remote Selection of Fixed Value Output

A user-specified 4-20 mA output and pulse output can be selected with a DI signal.

Proceed as follows to use this function:

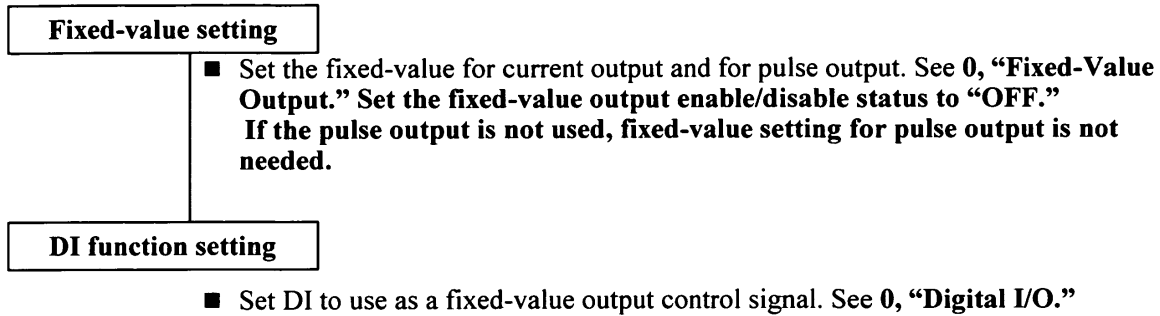

Control signal input conditions:

Control signal input level	4 –20 mA and pulse output
L level	Outputs the measured value.
H level	Outputs the fixed-value.

10.8 Converter Failure Alarm

When one or more of the following converter errors occur in a self-diagnostics sequence, an alarm signal can be output. See Chapter 12, "Self-Diagnostics and Warning Functions" for details of each alarm status.

■ Self-diagnostics errors

Self-diagnostics error (LCD display)											Error contents
*	R	O	M	E	R	R	O	R	*		ROM error
*	R	A	M	E	R	R	O	R	*		RAM error
	P	A	R	A	M	E	T	E	R		System parameter error
				F	A	I	L	U	R	E	
	E	X	C	U	R	R	E	N	T		Excitation circuit open or disconnection
							O	P	E	N	
	E	X	C	U	R	R	E	N	T		Excitation current error, excitation circuit fault
							E	R	R	O	
	A	D	C	E	R	R	O	R			ADC error
	I	N	V	A	L	I	D				Invalid totalizer counts
							T	O	T	A	

* Error message is displayed in measurement sub screen.

If you want to use a converter error alarm output, set digital output 1 or 2 (DO1 or DO2) to the error alarm output of the converter following 0, "Digital Input/Output."

In addition, set the alarm output condition to normally open (NORMAL OPEN) or normally close (NORMAL CLOSE) status.

■ Output conditions

- **Normal Open;** transistor / relay contact is closed when an error occurs.
- **Normal Close;** transistor/relay contact is open when an error occurs.

Note: Alarm output contacts are open while the converter is powered off.

10.9 Multiple range high/low limit alarm function (option)

The procedure to use multiple range high/low limit alarm is shown below.

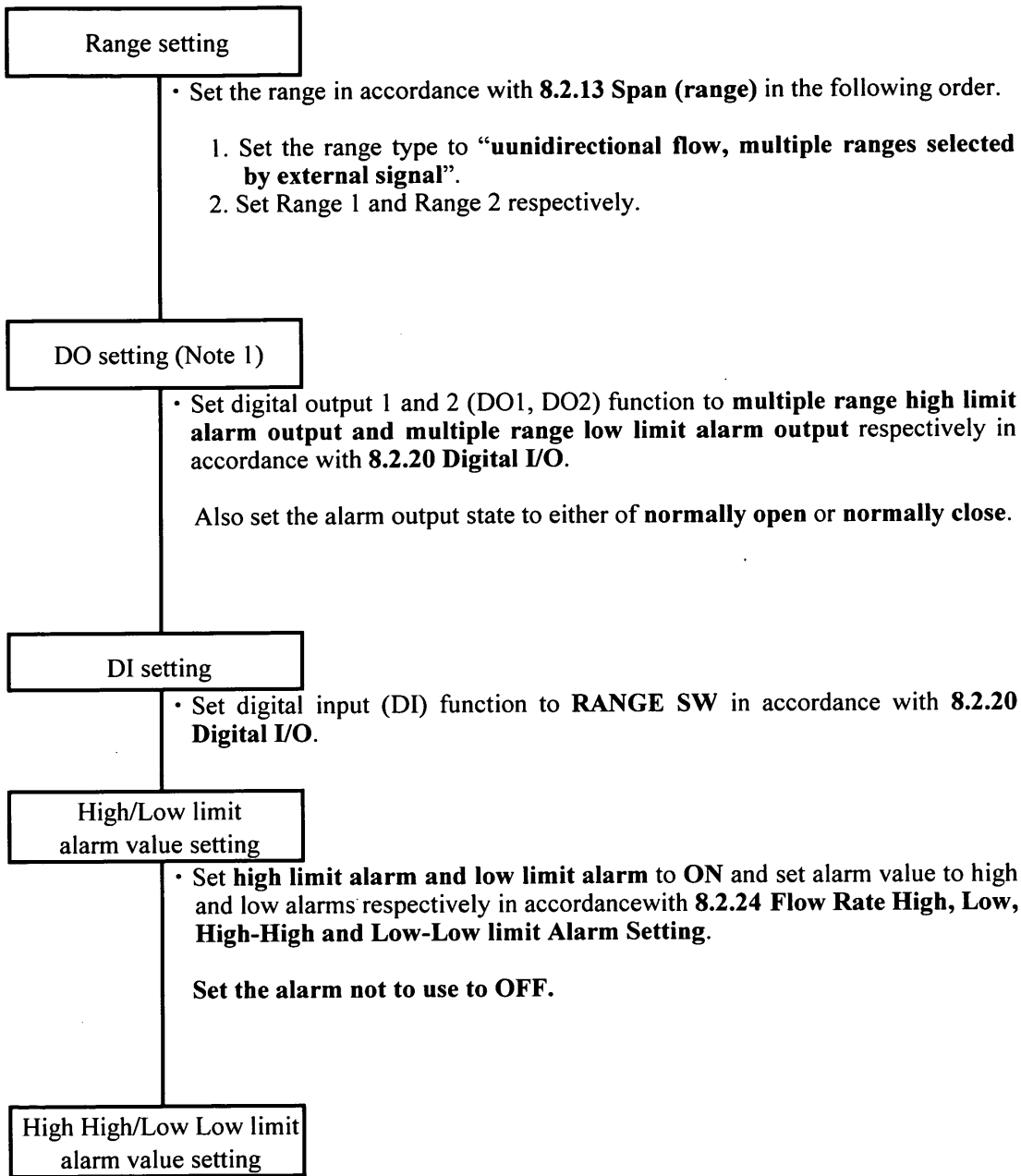

- Set **high-high alarm and low-low alarm** to **ON** and set alarm value to them respectively in accordance with **8.2.24 Flow Rate High, Low, High-High and Low-Low limit Alarm Setting**.

Set the alarm not to use to **OFF**.

(Note 1) When setting DO using HHT AF900 (Ver2.40 or older), set alarm outputs as below:

Multiple range high limit alarm output	SPECIAL-B,
Multiple range low limit alarm output	SPECIAL-A

Multiple range high/low limit alarm output

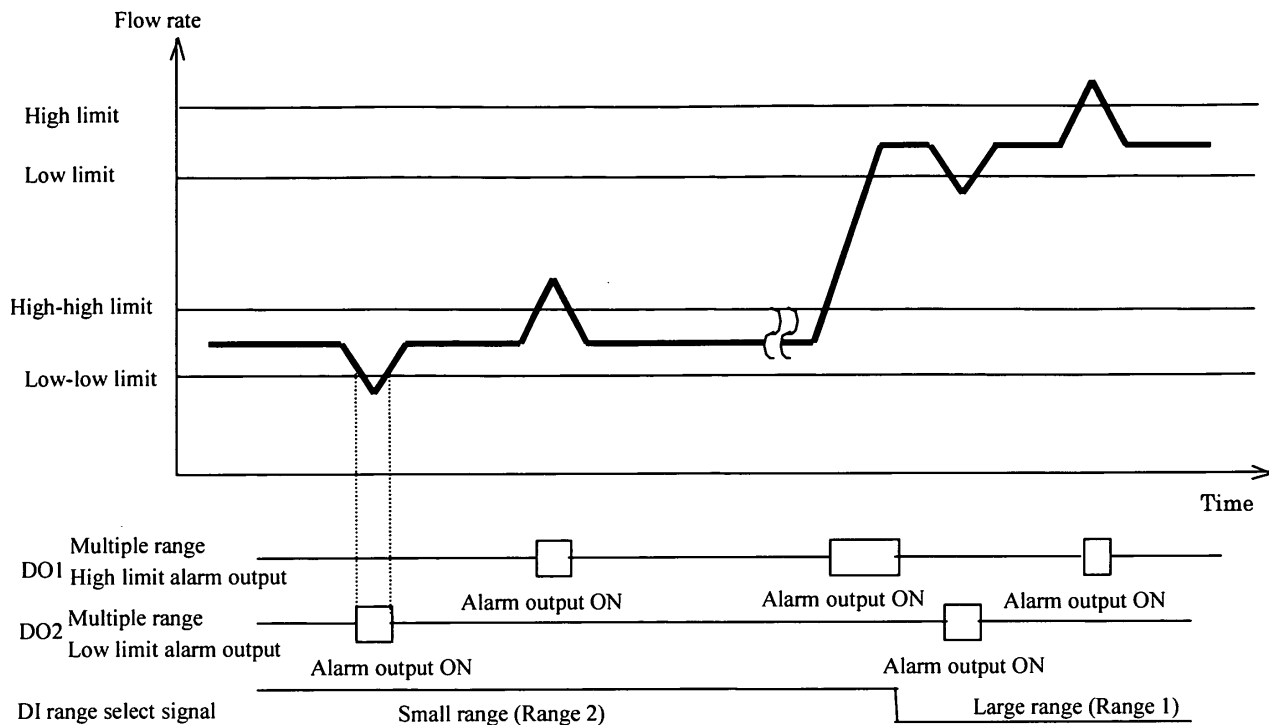

Note 1: Range changes to Small range when range select signal is H level, and to Large range in L level.

Note 2: High-high/low-low limit alarm is activated when Small range is selected. High/low limit alarm is not output to display.
High/low limit alarm is activated when Large range is selected. High-high/low-low limit alarm is not output to display.

Note 3: Alarm output state is the same state to which digital output 1 or 2 is set. When converter power is OFF, contact output is OPEN.

Note 4: Each alarm set value % is the percent set to the first range.

Note 5: Hysteresis of each alarm is 2.5 % for the first range.

Example

When Large range and Small range are set as below:

Large range (Range 1): 1000 m³/h

Small range (Range 2): 500 m³/h

And you want to set alarm values as below:

Large range alarm set values

High limit value: 800 m³/h

Low limit value: 600 m³/h

Small range alarm set values

High-high limit value: 400 m³/h

Low-low limit value: 300 m³/h

Set the alarm set values as below:

High limit value: 80 % (800 m³/h ÷ 1000 m³/h = 0.8)

Low limit value: 60 % (600 m³/h ÷ 1000 m³/h = 0.6)

High-high limit value: 40 % (400 m³/h ÷ 1000 m³/h = 0.4) See Note4.

Low-low limit value: 30 % (300 m³/h ÷ 1000 m³/h = 0.3) See Note4

11. Communications Function

The LF60*F series electromagnetic flowmeter uses the **HART^{*1}** protocol to transmit digital signals over the 4-20mA output line. The AF900 hand-held terminal is used to communicate with the LF60*F using the HART protocol. **You can check or change configuration parameters, calibrate the flowmeter or monitor the flowmeter measuring value from a remote place.**

For the detailed operation and specification of HHT, refer to the "Hand-held Terminal for Sensor with Communication Function AF900 Instruction Manual" (6F8A2195).

*1 HART protocol:

The "HART protocol", which stands for Highway Addressable Remote Transducer, is the name of the communication protocol for industry sensors that is recommended by HCF (HART Communication Foundation).

By adding an optional PROFIBUS communication board to the converter for electromagnetic flowmeter converter: LF60*F, the converter can be used as the PROFIBUS-PA slave device for digital data communication with the PROFIBUS master device.

For details of PROFIBUS communication, refer to the "PROFIBUS Communication Instruction Manual".

To perform HART communication by connecting the converter for electromagnetic flowmeter: LF60*F and Emerson HHT MODEL273/375, the following device descriptor is required. If the MODEL273/375 you use does not support the device descriptor, update the internal software of MODEL273/375. For details, refer to the MODEL275/375 instruction manual.

Item	Contents
MODEL	LF R71
Manufacturer Code	2C (TOSHIBA)
Device Revision	7
DD Revision	1~

11.1 Connections with the HHT Terminal

Connect the probe cable of the HHT terminal in parallel with the load resistance which is wired from the current output terminals (+ and -). Use points such as pins of terminal board or junction terminal to connect with the clip of the probe. To connect the HHT directly to the flowmeter, use the terminals + and -. The HHT connection cable has no polarity.

See Figure 11.2 and 11.2.

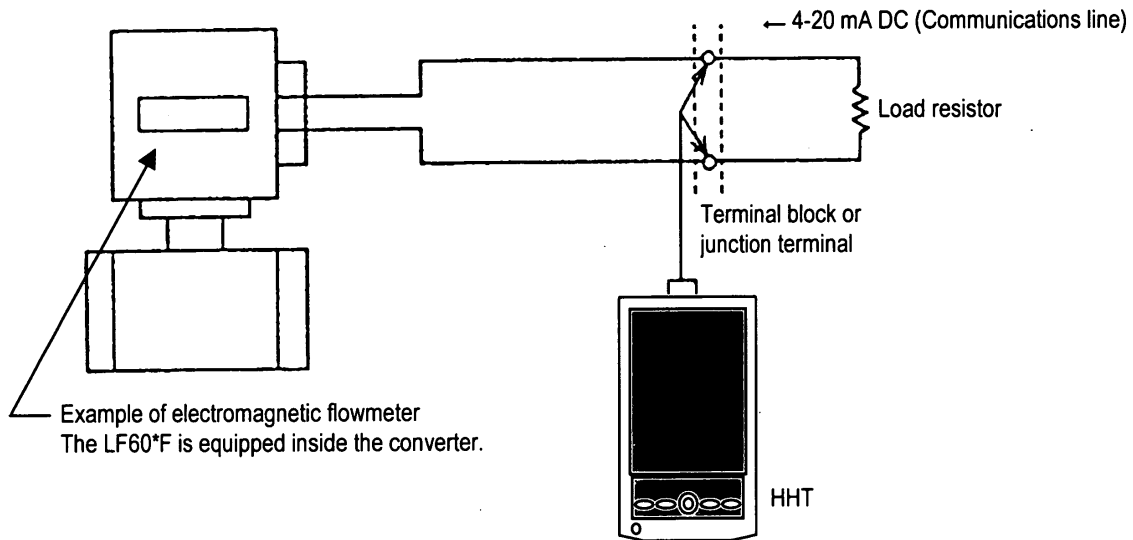

Figure 11.1 Connections to the current output line

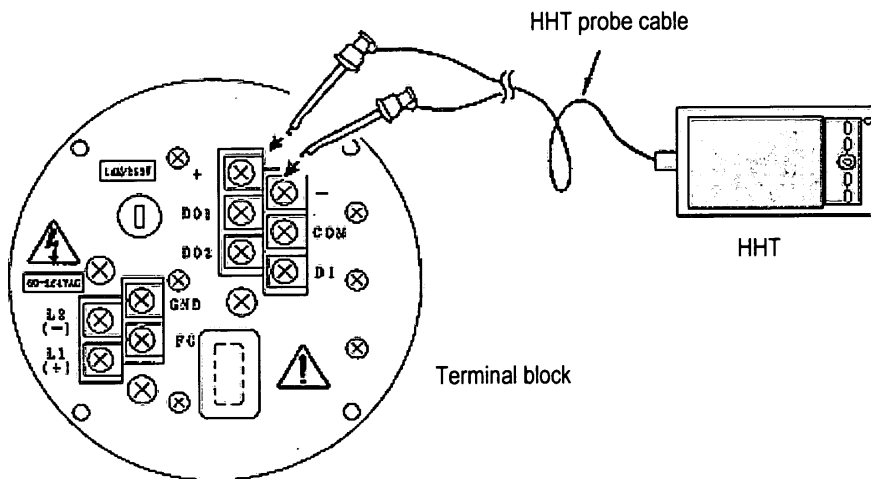

Figure 11.2 Connections to the terminal block

11.2 Procedures for Communication with HHT

This section describes the HHT basic operation procedures for communication between the electromagnetic flowmeter and HHT. For details, refer to the HHT instruction manual.

* Applying the following preparatory operations to a commercially available PDA (OS: WindowsCE) makes the PDA serve as a HHT.

Procedure	Operation
①Prepare a hand-held terminal (1)	Install the AF900 application software to a commercially available PDA (OS: WindowsCE) main unit. Then insert the serial interface card supplied with AF900 to the card slot of the PDA.
②Prepare a hand-held terminal (2)	Connect the HART interface cable and serial interface card supplied with AF900 to each other.
③Connect	Connect the alligator clip at the head of the HART interface cable to the current output line of the converter via a load resistor.
④Start	Turn on the power supply of the PDA to start the AF900 application software.
⑤Preliminary communication	Execute [sensor communication]. The model of the connected sensor product is automatically identified and the converter menu screen appears.
⑥Check/change data	Press the relevant parameter button and check/change data.
⑥Exit the communication	When all operations are complete, press the [Exist Application] in the top screen to turn off the power supply of the PDA.

11.3 Cautionary Notes on Communications

Observe the following notes and limitations when you use the communications function.

■ Current output load

- Load resistance: 240 to 750 Ω (including communications line resistance)
- Load capacitance: 0.25 μF maximum (including communications line capacitance)
- Load inductance: 4mH maximum (including communications line inductance)
- Cable length: 2 km maximum (approximate value when 1.25 mm² shielded cable is used under standard operating conditions.)

■ Wiring cable

Use a shielded cable (CVV-S, etc) for wiring.

■ Interference on 4-20mA current signal

To communicate with the flowmeter, a digital signal (amplitude 0.4 to 0.8 V in the case of 500 Ω load resistance) with a frequency of 1.2 to 2.2 kHz is superimposed on the 4-20mA current signal. If a high-response receiving instrument is connected to the current output line, the superimposed communications signal may interfere with the instrument. To prevent this interference, put a low-pass filter with a time constant of about 100 ms into the input circuit of the receiving instrument.

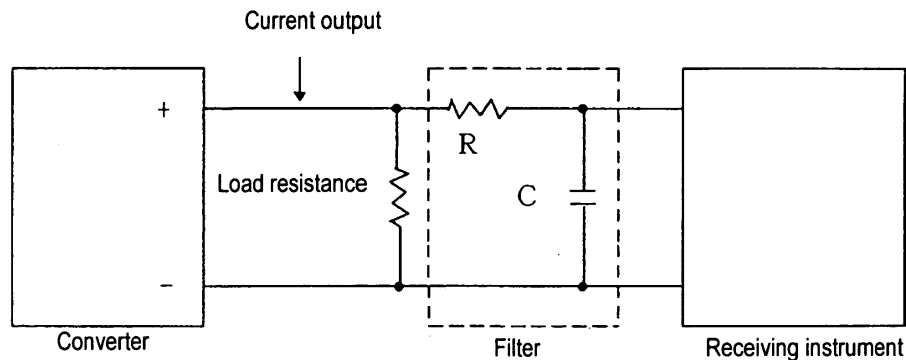

Figure 11.3 Filter connection example

12. Self-Diagnostics and Alarms

12.1 Self-diagnostics

The converter for electromagnetic flowmeter: LF60*F has a **self-diagnostics function to detect such problems as setting error, I/O error or converter hardware failure and shows the resulting error or alarm messages on the LCD sub display or on the Hand held terminal (HHT) hand-held terminal through the HART protocol communications.** The error or alarm messages and their corrective actions are described below.

■ Setting error

If you try to set the value or measuring unit **out of the range specified** for each item, one of the following error messages appears.

LCD display										Description	Corrective action			
*	H	I	G	H		O	V	E	R	*	Setting value exceeds the allowable high limit.	Try to set the value within the specified range.		
*						S	P	E	C	*				
*	L	O	W		O	V	E	R		*	Setting value goes below the allowable low limit.			
*						S	P	E	C	*				
*	H	I	G	H		O	V	E	R	*	Counting rate exceeds the allowable high limit.			
*				C	N	T		R	A	T			E	*
*	L	O	W		O	V	E	R		*	Counting rate goes below the allowable low limit.			
*				C	N	T		R	A	T		E	*	
*	M	U	L	T	I		R	A	N	G	E	*	Span is not appropriate for multi-range configuration.	Try to set the span as specified.
*						E	R	R	O	R	*			

● **High and low limit alarms, high-high and low-low limit alarms, empty alarm**

One of the following messages appears if the flow rate reading goes out of the set range or an empty alarm is generated.

If the high or low limit alarm enable/disable status is set to OFF, its alarm function (high or low) is disabled. See 0, "Check/Change of Parameters."

LCD display	Description	Corrective action																						
<table border="1"> <tr><td>H</td><td>I</td><td>G</td><td>H</td><td>A</td><td>L</td><td>A</td><td>R</td><td>M</td><td></td><td></td></tr> <tr><td></td><td></td><td></td><td></td><td></td><td></td><td></td><td></td><td></td><td></td><td></td></tr> </table>	H	I	G	H	A	L	A	R	M														If high limit alarm is set, the flow rate reading exceeds the setting value.	Adjust so that the reading stays below the high limit.
H	I	G	H	A	L	A	R	M																
<table border="1"> <tr><td>L</td><td>O</td><td>W</td><td>A</td><td>L</td><td>A</td><td>R</td><td>M</td><td></td><td></td><td></td></tr> <tr><td></td><td></td><td></td><td></td><td></td><td></td><td></td><td></td><td></td><td></td><td></td></tr> </table>	L	O	W	A	L	A	R	M															If low limit alarm is set, the flow rate reading is below the setting value.	Adjust so that the reading stays above the low limit.
L	O	W	A	L	A	R	M																	
<table border="1"> <tr><td>H</td><td>I</td><td>G</td><td>H</td><td>H</td><td>I</td><td>G</td><td>H</td><td></td><td></td><td></td></tr> <tr><td></td><td></td><td></td><td></td><td>A</td><td>L</td><td>A</td><td>R</td><td>M</td><td></td><td></td></tr> </table>	H	I	G	H	H	I	G	H								A	L	A	R	M			If high-high limit alarm is set, the flow rate reading exceeds the setting value.	Adjust so that the reading stays below the setting value.
H	I	G	H	H	I	G	H																	
				A	L	A	R	M																
<table border="1"> <tr><td>L</td><td>O</td><td>W</td><td>L</td><td>O</td><td>W</td><td></td><td></td><td></td><td></td><td></td></tr> <tr><td></td><td></td><td></td><td></td><td>A</td><td>L</td><td>A</td><td>R</td><td>M</td><td></td><td></td></tr> </table>	L	O	W	L	O	W										A	L	A	R	M			If low-low limit alarm is set, the flow rate reading is below the setting value.	Adjust so that the reading stays above the setting value.
L	O	W	L	O	W																			
				A	L	A	R	M																
<table border="1"> <tr><td>E</td><td>M</td><td>P</td><td>T</td><td>Y</td><td>A</td><td>L</td><td>A</td><td>R</td><td>M</td><td></td></tr> <tr><td></td><td></td><td></td><td></td><td></td><td></td><td></td><td></td><td></td><td></td><td></td></tr> </table>	E	M	P	T	Y	A	L	A	R	M													Indicates that the detector pipe is empty.	Fill the pipe with fluid.
E	M	P	T	Y	A	L	A	R	M															
<table border="1"> <tr><td>O</td><td>V</td><td>E</td><td>R</td><td></td><td>1</td><td>2</td><td>5</td><td>%</td><td></td><td></td></tr> <tr><td></td><td></td><td></td><td></td><td></td><td></td><td></td><td></td><td></td><td></td><td></td></tr> </table>	O	V	E	R		1	2	5	%														The measured value is over 125%.	The measurement value setting range is too narrow or a larger volume of fluid is flowing. Check whether the setting is correct or if there is any problem in processing.
O	V	E	R		1	2	5	%																
<table border="1"> <tr><td>U</td><td>N</td><td>D</td><td>E</td><td>R</td><td>-</td><td>1</td><td>2</td><td>5</td><td>%</td><td></td></tr> <tr><td></td><td></td><td></td><td></td><td></td><td></td><td></td><td></td><td></td><td></td><td></td></tr> </table>	U	N	D	E	R	-	1	2	5	%													The measure value is below -125%.	The measurement value setting range is too narrow or a larger volume of fluid is flowing. Check whether the setting is correct or if there is any problem in processing.
U	N	D	E	R	-	1	2	5	%															

■ **Converter hardware failure**

The system checks the internal circuitry at the time of power-up for all error items and checks continuously for the specified items as described below. **If an error is detected, one of the messages shown in the table below will be displayed.**

If multiple errors occur, **their messages will be displayed cyclically.** The diagnostics items concerning the excitation cable and excitation circuit are detected using the ADC circuit.

Thus, **if the ADC fails (No.6), No. 4 (excitation cable) and No. 5 (excitation circuit) errors cannot be detected correctly.** Further, this entire checking system is based on the CPU in the flowmeter. Therefore, **if the CPU fails, no accurate diagnostics or error message display can be obtained.**

NO.	LCD display										Description	Corrective action			
1	*	R	O	M	E	R	R	O	R	*	ROM error	Internal components or printed-circuit board must be repaired or replaced. Contact you're nearest Toshiba representative.			
2	*	R	A	M	E	R	R	O	R	*	RAM error				
3		P	A	R	A	M	E	T	E	R	System parameter error				
					F	A	I	L	U	R			E		
4		E	X		C	U	R	R	E	N	Excitation cables are not connected.		Connect the excitation cables correctly.		
								O	P	E		N			
5		E	X		C	U	R	R	E	N	An error occurred in the excitation circuit.	Internal components or printed-circuit board must be repaired or replaced. Contact you're nearest Toshiba representative.			
								E	R	R			O	R	
6		A	D	C	E	R	R	O	R		ADC error				
7		I	N	V	A	L	I	D			Totalizer data was destroyed due to external noise. (No message appears if totalization is not used.)		The error message disappears if you press the reset key.		
								T	O	T				A	L

Notes

- Errors No. 1 to No. 3 can be detected **only at the time of power-on. The flowmeter does not start measurement** if any one of these errors is detected. If these errors occur after power-on, the flowmeter cannot detect these errors, and thus **may indicate and output incorrect data.**
- Errors No. 4 to No. 6 **may not be detected even if the errors result in incorrect flowmeter accuracy, because of characteristic differences in components used to detect these errors.**
- CPU error cannot be detected.** If the CPU stops, the watchdog timer resets the internal circuits and the flowmeter starts again from the initial power-on condition. Depending on CPU condition, the flowmeter **may not indicate and output correct data.**

12.2 Output Status for Errors and Alarms







The flowmeter data display, current and pulse outputs will become as follows if an error or alarm occurs.



Error or alarm message	Data display	Current output (4–20mA)	Totalizer and pulse output	Remarks
ROM ERROR (Note 1)	—	(Note 3)	Stopped	After power-up, no measurement starts.
RAM ERROR	—	(Note 3)	Stopped	
PARAMETER FAIL (Note 2)	Zero	(Note 3)	Stopped	—
EX. CURR OPEN	Zero	(Note 3)	Stopped	Zero adjustment (on-stream at zero flow rate) cannot be conducted.
EX. CURR ERROR	Zero	(Note 3)	Stopped	Zero adjustment (on-stream at zero flow rate) cannot be conducted.
ADC. ERROR	Zero	(Note 3)	Stopped	Zero adjustment (on-stream at zero flow rate) cannot be conducted.
INVALID TOTAL	Measured data	Measured data	Measured data	The error message disappears if you clear (reset) the totalizer.
HIGH ALARM	Measured data	Measured data	Measured data	—
LOW ALARM	Measured data	Measured data	Measured data	—
HIGH HIGH ALARM	Measured data	Measured data	Measured data	—
LOW LOW ALARM	Measured data	Measured data	Measured data	—

Notes

1. The display and output may not be as indicated depending on the nature of the ROM error.
2. If a parameter failure relating to current output occurs, the current output may not become exactly the setting value of the current output when an alarm occurs.
3. The current output set value used in case an alarm occurs will be output. For setting method, see 0, “Current Output Setting Used When an Alarm Occurs.”

13. Maintenance and Troubleshooting

 WARNING	
 DON'T	<p>■ Do not disconnect while circuit is live unless location is known to be nonhazardous.</p> <p>Live part of electric circuit or a high temperature department can cause explosion.</p>
 DON'T	<p>■ Do not modify or disassemble the enclosure.</p> <p>Strength degradation and defects of enclosure can cause explosion.</p>
 DON'T	<p>■ Do not use parts of other products.</p> <p>Protective performance degradation for hazardous location can cause explosion.</p>
 DON'T	<p>■ Do not live circuits While assembly of all components is not over.</p> <p>Protective performance degradation for hazardous location can cause explosion.</p>
 DO	<p>■ Install per the National Electrical Code for the US (NEC, ANSI/NFPA 70) and the Canadian Electrical code for Canada (CEC, CAN/CSA-C22.1) and the drawing 3S8A2532,3S8A2533 (Refer to Appendix 2.).</p> <p>Unsuitable conduit connections for hazardous location can cause explosion.</p>

 CAUTION	
<p>■ Do not conduct wiring work when power is applied.</p> <p style="text-align: center;">  DON'T </p> <p>Wiring while power is applied can cause electric shock.</p>	<p>■ Do not touch the LF600F main body when high temperature fluid is being measured.</p> <p style="text-align: center;">  DON'T </p> <p>The fluid raises the main body temperature and can cause burns.</p>

13.1 Maintenance

■ Calibration

The converter for electromagnetic flowmeter: LF60*F has a built-in reference signal generation circuit that generates dummy flow rate signals. **This reference signal can be used to check the zero and span of the converter for the purpose of instrumentation maintenance or periodical inspection. See Chapter 9, "Calibration."**

■ Fuse

The fuse can be taken out by unscrewing the cap of the fuse holder. **Check that the fuse is not damaged. The fuse has to be replaced periodically. The recommended replacement period is 3 years.**

Type of fuse used:	Glass tube fuse	1 piece
Rating:	①0.8A(T)/250V	for 100 to 240 Vac or 110Vdc power supply
	②2A/150V	for 24Vdc power supply
Dimensions:	Diameter 5mm × 20 mm	
Melting time characteristic:	①Time Lag	
	②Medium-Acting (Normal blow)	

Note: Use a fuse that complies with the Electrical Appliance and Material Safety Law.

■ Check/Replacement of the display unit

When characters displayed on the LCD display become thin or blots come out, please adjust the setting of LCD's display density. If the display is still not improved, the display unit comes to **the end of its life. Please replace the display unit with a new one.** In order to use the display unit stably for a long time, it is preferable to replace it early. For inspection and replacement, **please contact you're nearest Toshiba representative.**

■ Power supply unit (also used for excitation board)

Electronic components **deteriorate faster when the ambient temperature is high. The life of the power supply unit in the converter is 9 to 10 years if the ambient temperature is 40°C, and 5 to 6 years if it is 50° C.** To extend the life of the flowmeter, we recommend you **replace the power supply unit early.**

Contact you're nearest Toshiba representative for a flowmeter inspection or unit replacement.

■ Product disposal

The main body or parts of the converter for electromagnetic flowmeter I: LF60*F must be disposed of, according to the rules and regulations of your local government.

Especially if you dispose of electrolytic capacitors to replace parts, have it done by an agency which is licensed to handle industry waste materials.

■ Operative life

The operative life of this flowmeter is **10 years** from the date of shipment.

The life of the flowmeter differs depending on the environmental conditions and the way it was used. To extend the life of the flowmeter, **inspect the flowmeter periodically and clean or replace components** if necessary.

13.2 Troubleshooting

If a problem occurs while using the LF60*F, follow the flowcharts described below. You may find a way to solve the problem. The flowcharts are based on three symptoms (1) to (3). If you cannot solve the problem, contact you're nearest Toshiba representative.

13.2.1 Flow rate is not indicated.

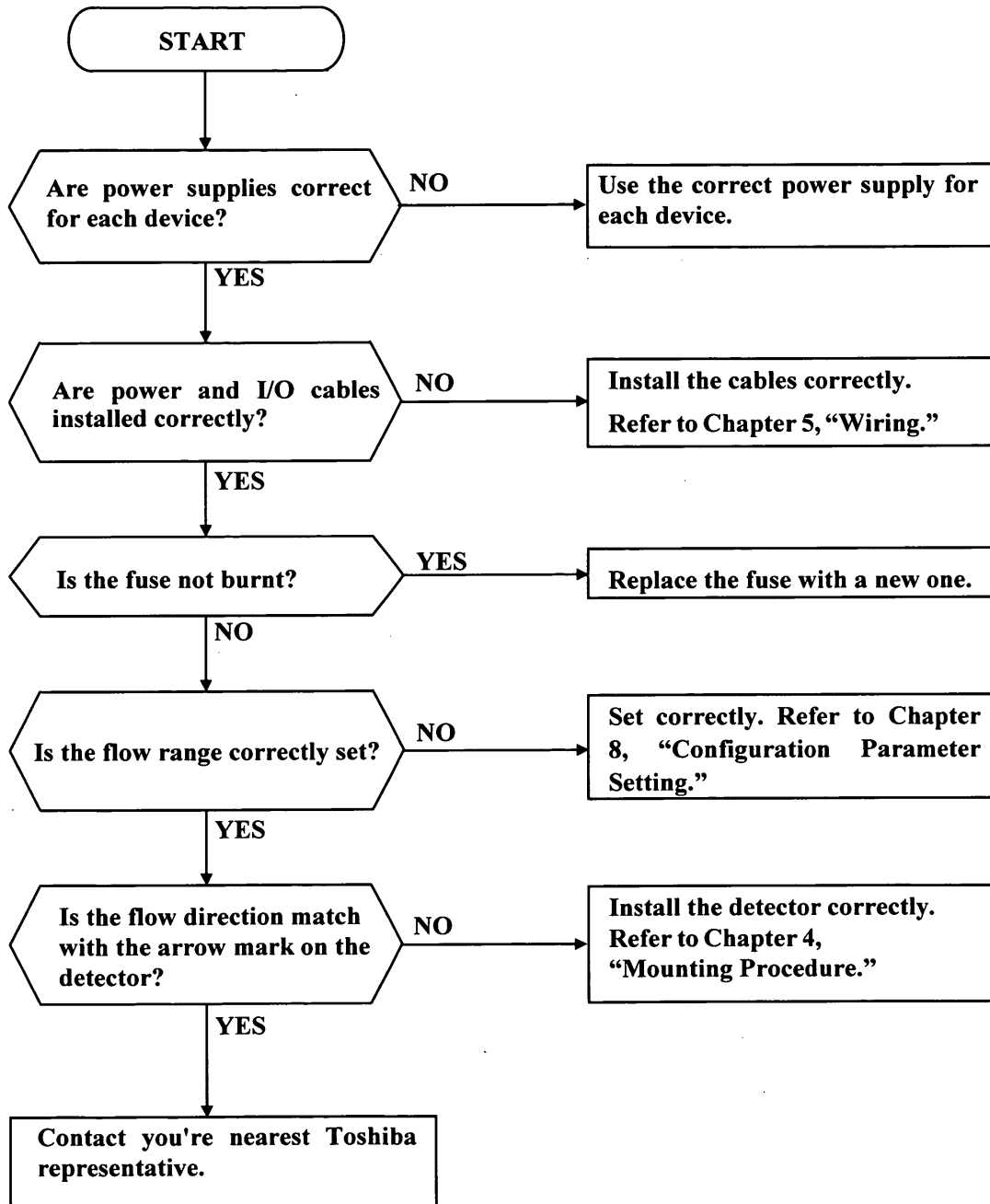

13.2.2 Flow rate indication is not correct.

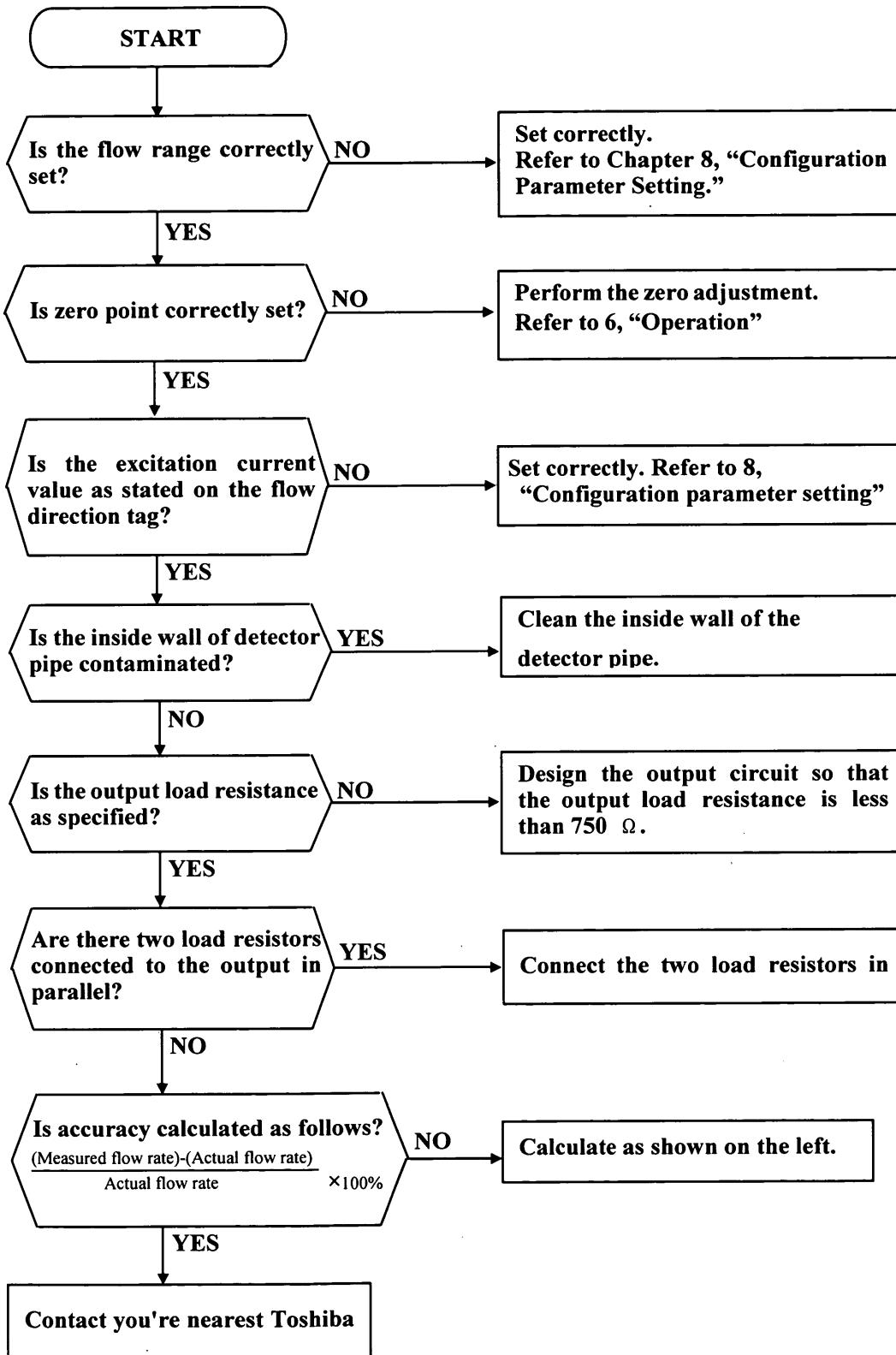

13.2.3 Flow rate indication is not stable.

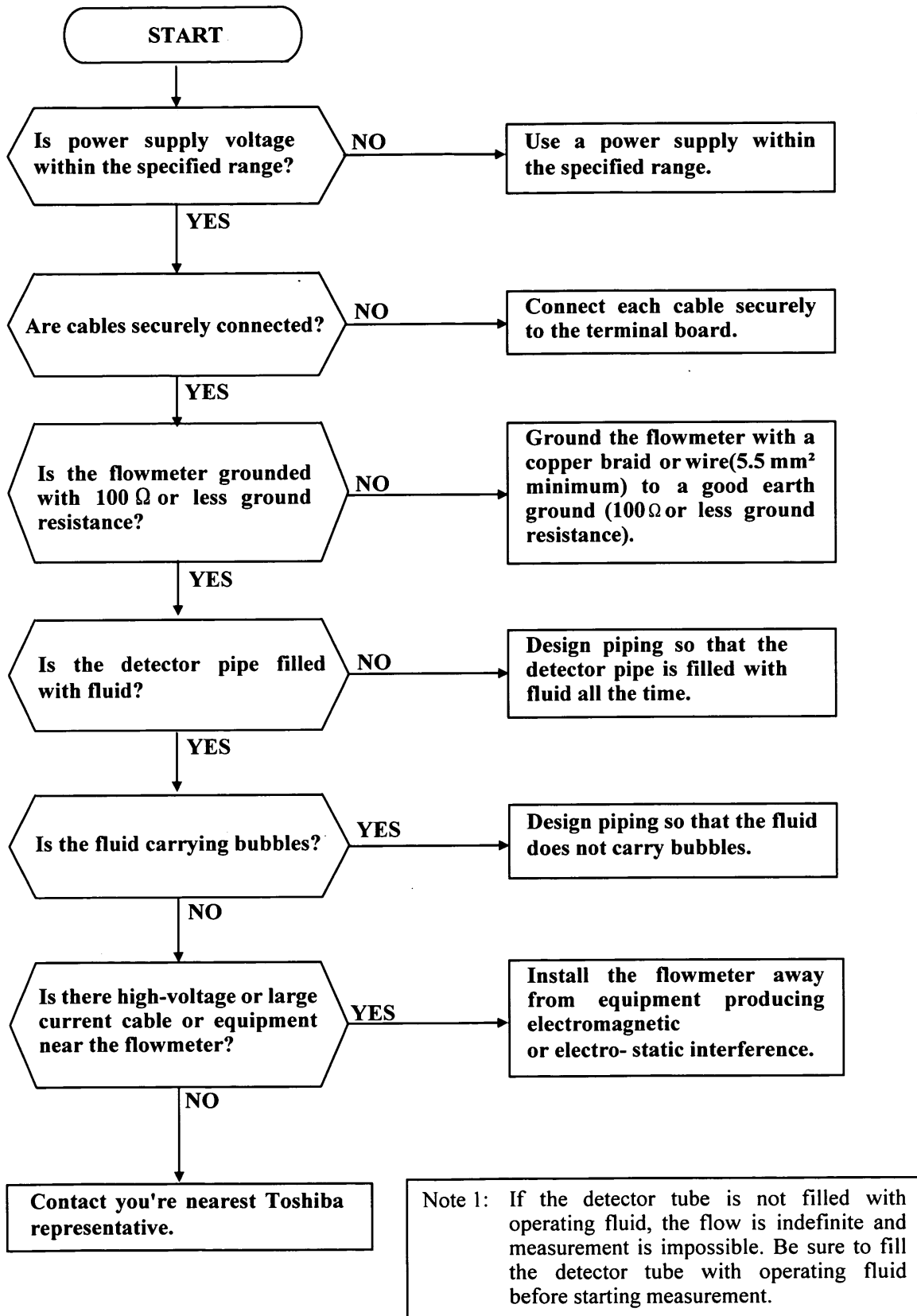

13.2.4 When switch operation is unable

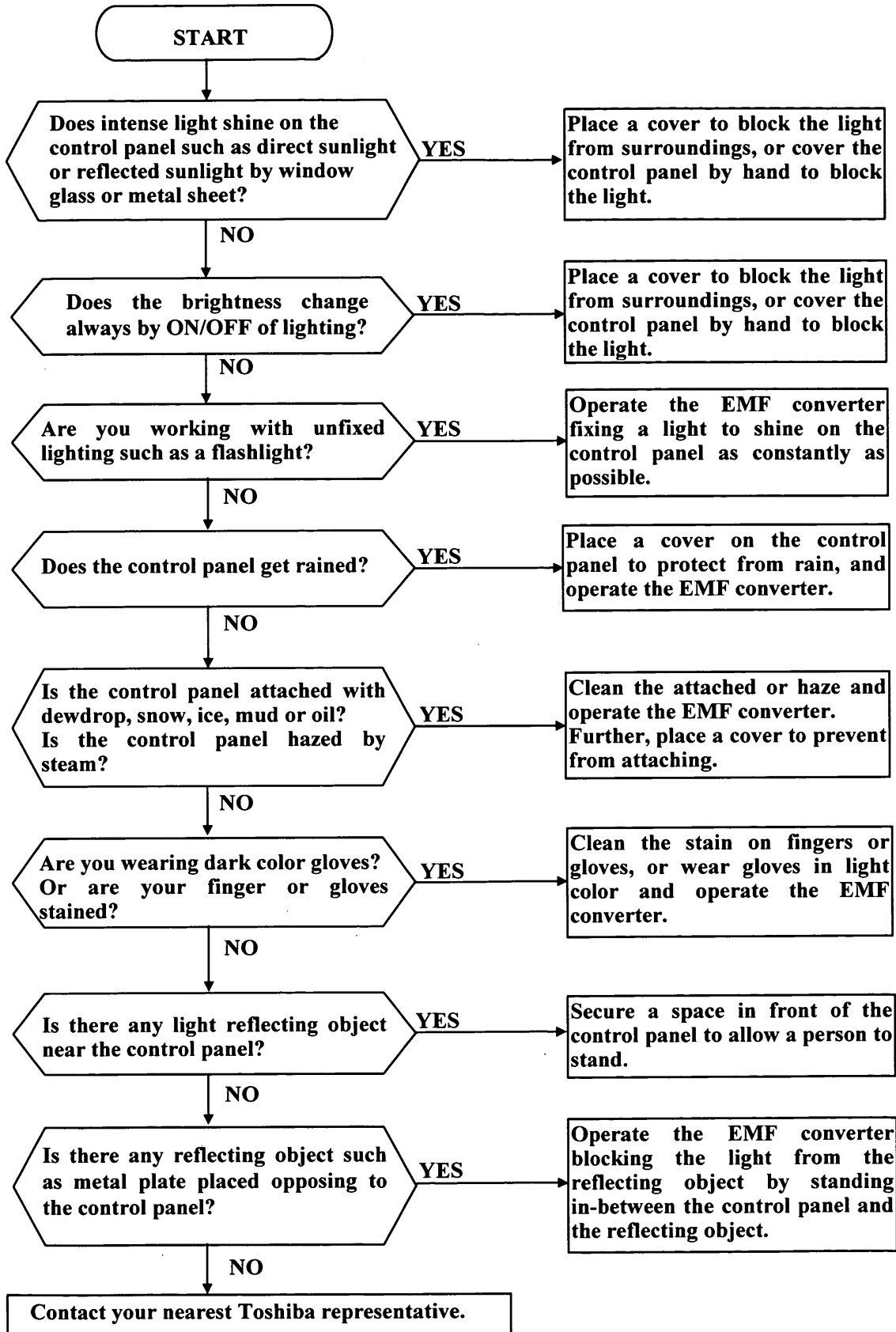

14. Principle of Operation

The operating principle of the electromagnetic flowmeter is based on Faraday's Law of electromagnetic induction and it is designed to measure the volumetric flow rate of fluid. An insulated pipe of diameter D is placed vertically to the direction of a magnetic field with flux density B (see Figure 14.1). When an electrically conductive fluid flows in the pipe, an electrode voltage E is induced between a pair of electrodes placed at right angles to the direction of magnetic field. The electrode voltage E is directly proportional to the average fluid velocity V.

The following expression is applicable to the voltage.

$$E = K \times B \times D \times V \text{ [V] (Eq. 14.1)}$$

Volumetric flow rate Q [m³/s] is:

$$Q = \frac{\pi \times D^2}{4} \times V \text{(Eq. 14.2)}$$

Using the Equation 14.1 and 14.2

$$E = K \times B \times D \times \frac{4}{\pi \times D^2} \times Q$$

$$E = \frac{4 \times K \times B}{\pi \times D} \times Q \text{(Eq. 14.3)}$$

Therefore, volumetric flow rate is directly proportional to the induced voltage.

E = induced electrode voltage [V]

K = constant

B = magnetic flux density [T]

D = meter pipe diameter [m]

V = fluid velocity [m/s]

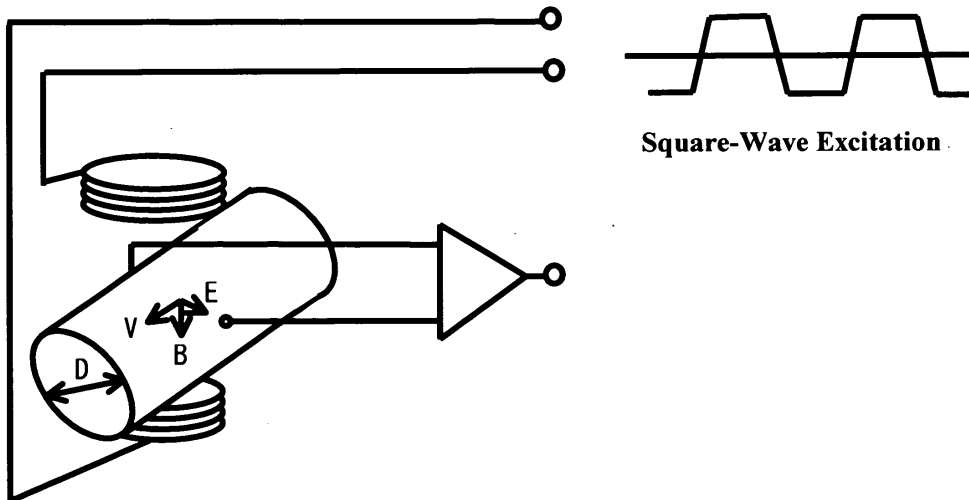

Figure 14.1 Principle of Operation

The LF60*F electromagnetic flowmeter uses the square-wave excitation method, which provides long-term stable operation. With square-wave excitation, the LF60*F offers reliable measurement without being affected by electrostatic or electromagnetic interference, or electrochemical polarization between the electrodes and the fluid to be measured.

15. Specifications

15.1 Specifications

■ General Specifications

Measuring range: (measuring range by flow rate conversion)

0-0.3m/s to 0-10m/s

(A range of 0-0.1m/s to 0-0.3m/s can be dealt with by an option specified at order time.)

Accuracy: (Accuracy when combined with the detector)

Flow rate to the range (%)	Accuracy		
	0.1 ~ less than 0.3 m/s	0.3 ~ less than 1.0 m/s	1.010 m/s
0 ~ 20 %	—	—	±0.1 % FS
20 ~100 %	—	—	±0.5 % of rate
0 ~ 50 %	±0.25 % FS	±0.25 % FS	—
50 ~100 %	±0.5 % of rate	±0.5 % of rate	—

(Note) Accuracy under the basic operation conditions with Toshiba calibration facility)

Conductivity : 5 μ S/cm or more

Ambient temperature: -20 to +60°C

Storage temperature : -25 to +65°C

Power supply : 100 to 240Vac (allowable voltage range: 80 to 250Vac 50/60Hz)
 24Vdc (allowable voltage range: 18 to 36Vdc) or
 110Vdc (allowable voltage range: 90 to 130Vdc)

Power consumption : 27VA (17W) or less

■ Input

Input signal: • Flow rate proportional signal from the detector

• Digital input signal (option)

Signal type: 20 to 30Vdc voltage signal

Input resistance: About 2.7k Ω

Number of input points: 1

Digital input function (option): Select either of the following.

- Range switching input: Large/Small range switching of unidirectional double range, forward/reverse direction double range
- Counter control input: Internal totalization counter start/stop/reset control
- Output hold input: The current output and pulse output are kept to their preset values.
- Zero adjustment input: Start still water zero adjustment.

■ Output

Current output: 4 to 20mA_{dc} (load resistance 750 Ω or less)
 Digital output 1: Output type: Transistor open collector
 Capacity: 30V_{dc}, Max 200mA
 Number of output points: 1
 Digital output 2: (Option)
 Output type: Semiconductor contact signal output (no polarity)
 Capacity: 150V_{dc}, Max. 150mA
 150V_{ac} (peak value), Max. 100mA
 Number of output points : 1

Digital output function: Select one of the following:

- Totalization pulse output:
 - Pulse rate Max. 10kHz(10000pps) ... DO1
Max. 100Hz(100pps) ... DO2 (option)
 - Pulse width Can be set within a range of 0.3 to 500ms.
However, must be 1/2 or less of the full-scale cycle.
If the full scale 1000pps is exceeded,
automatically set to 40% of the full-scale cycle.
- Multi-range switching output: In the case of fourfold range or forward/reverse double range, you need to add digital output optionally.
- High and low alarm output
- High-high and low-low alarm output
- Empty alarm output
- Preset counter output
- Converter malfunction alarm output
- Multiple range high and low limit alarm output (option)

Output display: Full-dot matrix 128 x 128-dot LCD (with back light)

■ Communication signal

Method (protocol): HART or PROFIBUS (option)
 Load resistance: 240 to 750 Ω (HART)
 Load capacity: 0.25 μ F or less (HART)

■ **Structure:** IP67 (NEMA 4X)

■ **Housing:** Aluminum alloy

■ **Coating:** Acrylic resin-baked coating, pearl-gray colored

■ **Cable connection port:** 1/2-14NPT thread

Cable glands not provided.

■ **Arrester:** Arresters are installed in the power supply and current signal output circuit.

15.2 Model Number Table

Converter Model Number Table

Model number					Specification code										Contents	LF600F	LF602F
1	2	3	4	5	6	7	8	9	10	11	12	13	14				
L	F	6	0												LF600 series electromagnetic flowmeter converter	○	○
				0 2											Usage Combined type Separate type	○ —	— ○
					F										Area of use FM Approval and CSA Certification (Division 2 Hazardous Locations)	○	○
						A B									Shape Round for combined type Square for separate type	○ —	— ○
							A C E								Installation fitting Not provided Wall-mounting fitting available (Bolts and Nuts material: 304 stainless steel) Pipe-mounting fitting available (Bolts and Nuts material: 304 stainless steel)	○ — —	○ ○ ○
								1 2							I/O and Communication function Digital output points 1(DO1) Digital output points 2(DO1+DO2)+Digital input point 1(DI)	○ ○	○ ○
									1 2						Current output and Communication function Current output + HART communication PROFIBUS communication (Current output is not usable)	○ ○	○ ○
										1 2 3					Power supply 80 to 250Vac, 50/60Hz 18 to 36Vdc 90 to 130Vdc	○ ○ ○	○ ○ ○
											E				Language English	○	○
											*	*			No use	—	—

○: Selectable —: Unselectable

16. Outline Drawing

16.1 LF600F Type

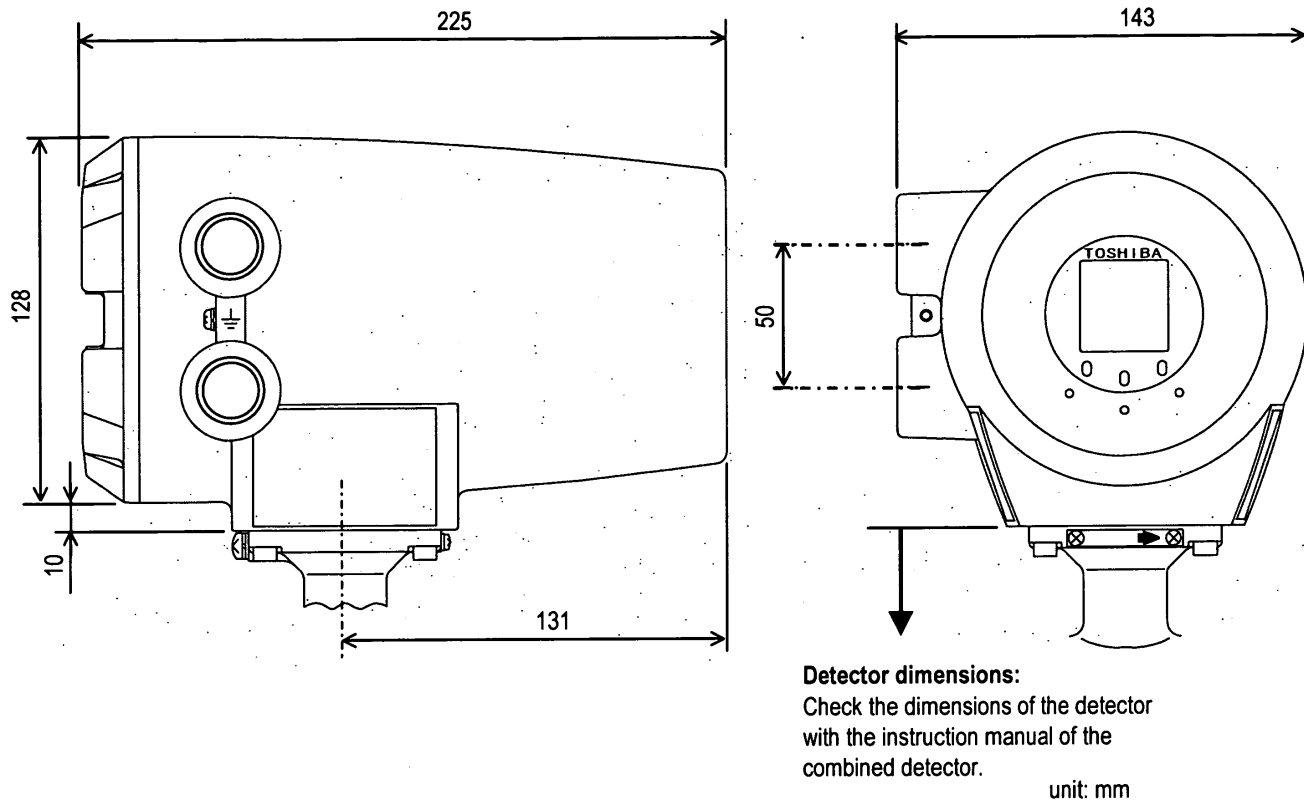

Figure 16.1 Outline of LF600F Type

16.2 LF602F Type

Total weight: About 3.5kg (including the installation plate).

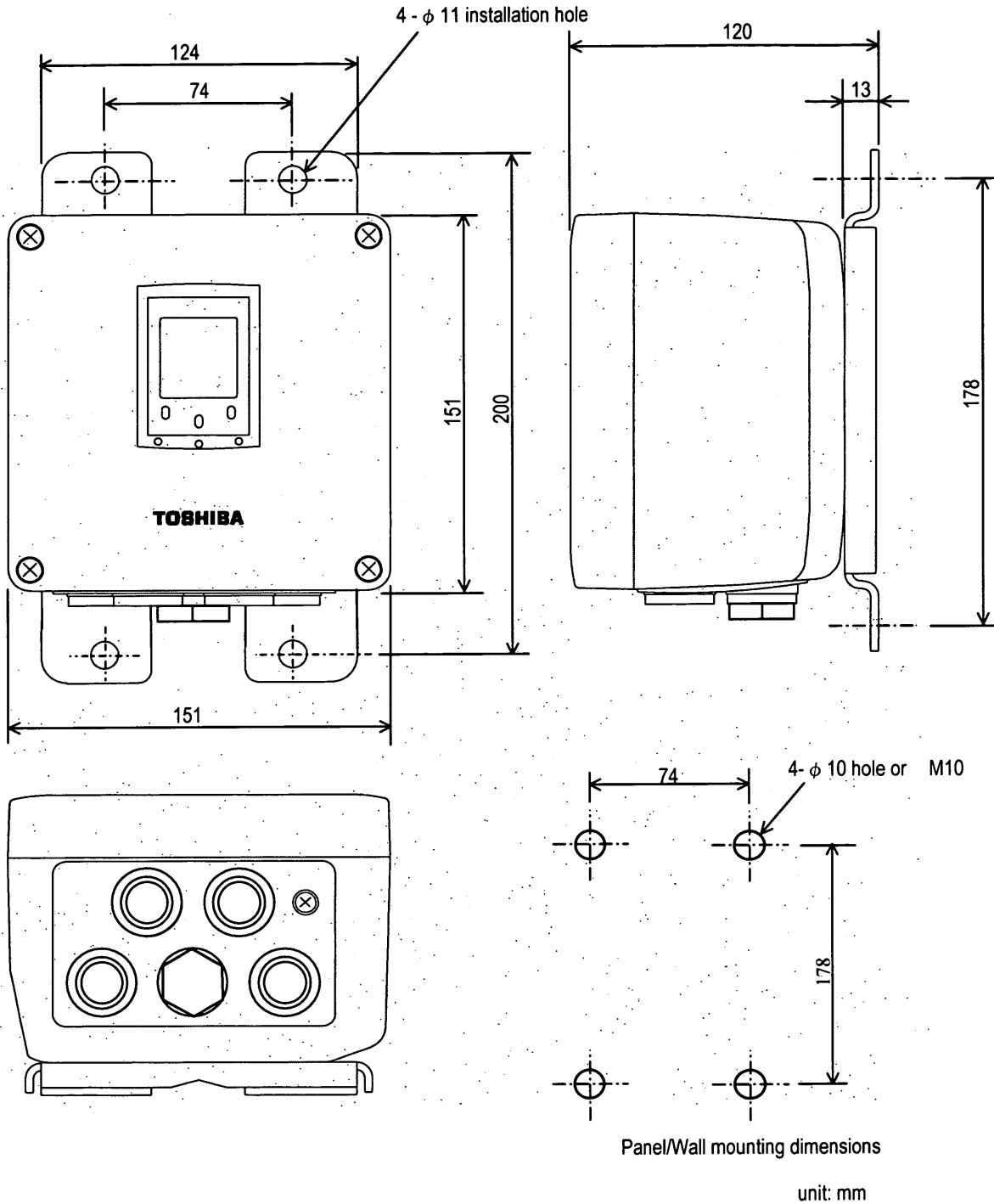

Figure 16.2 Outline of LF602F Type

Appendix 1

Factory default standard value table

When parameter value was appointed in order, parameter value may be different from list.

Item	Default value (SI unit)	Default value (English unit)	Changed value
Exciting current setting	Value(*1)	Value(*1)	
Flow direction setting	NORMAL	NORMAL	
Password	000	000	
Address setting	126	126	
Main display setting	m ³ /h	gal/min	
Sub display setting	m ³	COUNT B	
Custom (coefficient)	0	0	
Custom (unit)	(all blanks)	(all blanks)	
LCD density adjustment	3	3	
Switch position setting	BOTTOM	BOTTOM	
Range type	SINGLE	SINGLE	
Range 1	Value(*1)	Value(*1)	
Range 2 to 4	0.00 m ³ /h	0.00 gal/min	
Range hysteresis	3.0 %	3.0 %	
Damping constant	1.0 s	5.0 s	
Low cut value	1.0 %	1.0 %	
Current output setting upon alarm occurrence	4mA	4mA	
Display low cut Yes/No	OFF	OFF	
Output low limit setting	4mA	4mA	
Digital output 1	PULSE OUT	PULSE OUT	
Digital output 2 (*2)	NO USE	EMPTY	
Digital input 1(*2)	C RES/STA	C RES/STA	
DO1/DO2 alarm output state(*2)	NORMAL OPEN	NORMAL OPEN	
DI control signal level setting(*2)	H LEVEL	H LEVEL	
Count rate	1 m ³	Value(*1)	
Pulse width setting mode	AUTO	MANUAL	
Pulse width	100 ms	5 ms	
Preset count value	00000000	00000000	
Preset output setting	HOLD	HOLD	
High limit alarm ON/OFF	OFF	OFF	
High limit value setting	0.0 %	0.0 %	
Low limit alarm ON/OFF	OFF	OFF	
Low limit value setting	0.0 %	0.0 %	
High high limit alarm ON/OFF	OFF	OFF	
High high limit value setting	0.0 %	0.0 %	
Low low limit alarm ON/OFF	OFF	OFF	
Low low limit value setting	0.0 %	0.0 %	
Fluid empty alarm	NORMAL	NORMAL	

Factory default standard value table (continuance)

Item	Default value (SI unit)	Default value (English unit)	Changed value
Self-diagnosis Yes/No	ON	ON	
Alarm output preset	WITHOUT EMP	WITHOUT EMP	
Limit rate	0.0 %	0.0 %	
Limit time	0.0 s	0.0 s	
Fixed output	OFF	OFF	
Fixed current	4mA	4mA	
Fixed pulse	0 pps	0 pps	
Manual zero	0.0 %	0.0 %	

*1 : Setting value by meter size please refer to the next list.

*2 : Digital output2 and digital input are option.

Setting value in each size

Meter Size (mm/inch)	Ex. Freq (Hz)	Range 1(SI unit)		Range 1(English unit)		Count rate (gal)
		(m ³ /h)	(m/s)	(gal/min)	(ft/s)	
15 / 0.5	24	2	3.144	25	29.283	1
25 / 1	24	6	3.395	75	31.625	1
32 / 1.25	24	10	3.454	125	32.171	1
40 / 1.5	24	15	3.316	175	28.826	1
50 / 2	24	25	3.537	300	31.625	10
80 / 3	24	60	3.316	650	26.766	10
100 / 4	24	100	3.537	1000	26.354	10
150 / 6	24	200	3.144	2500	29.283	100
200 / 8	24	300	2.653	4500	29.649	100
250 / 10	12	600	3.395	7000	29.517	100
300 / 12	12	900	3.537	10000	28.283	100
350 / 14	12	1200	3.465	12000	25.817	100
400 / 16	12	1600	3.537	16000	26.354	100
450 / 18	12	2000	3.493	20000	26.029	100
500 / 20	6	3000	4.244	25000	26.354	100
600 / 24	6	4000	3.930	40000	29.283	100

Appendix 2

2-1 A system block diagram for LF600F

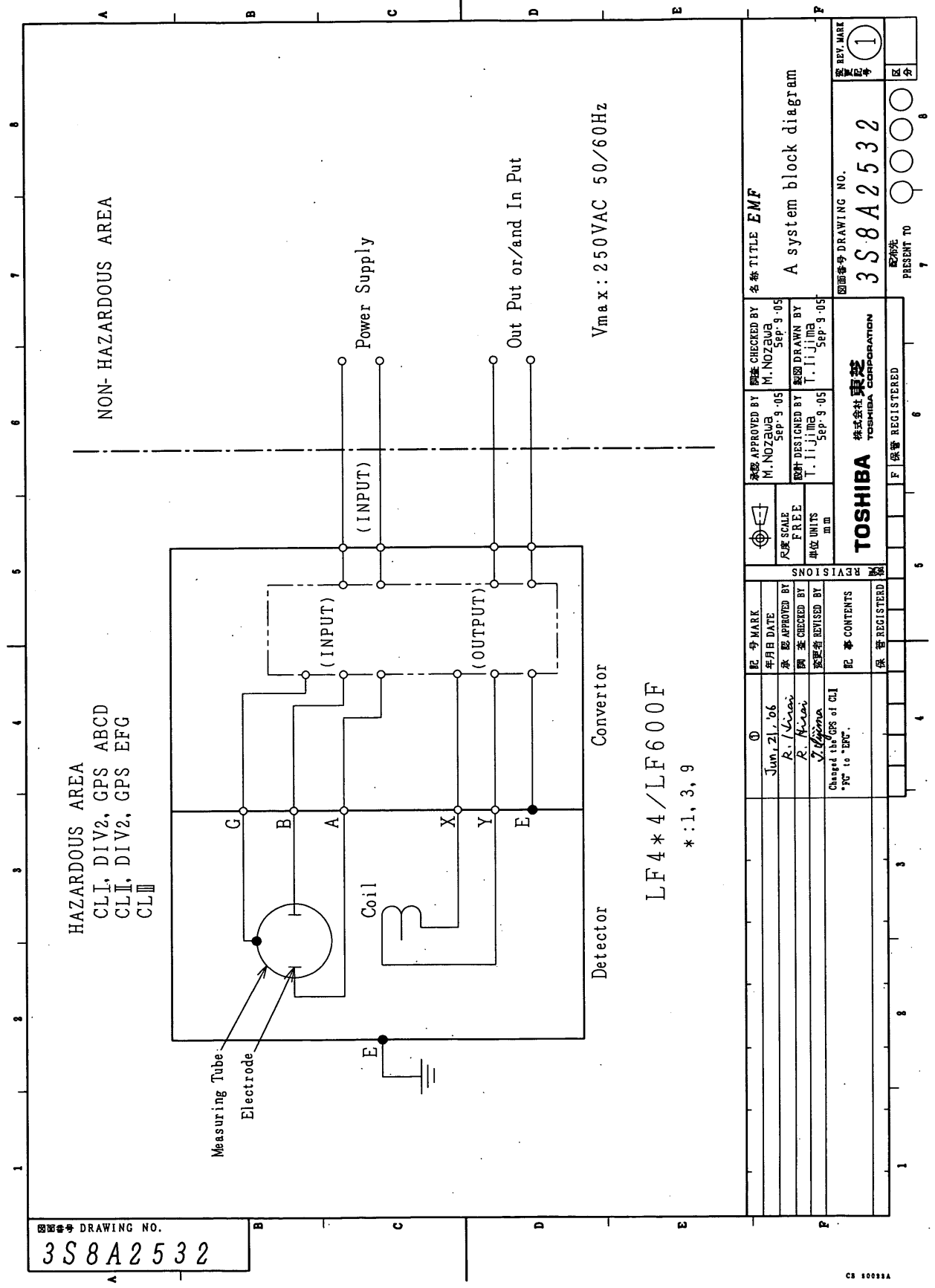

2-2 A system block diagram for LF602F

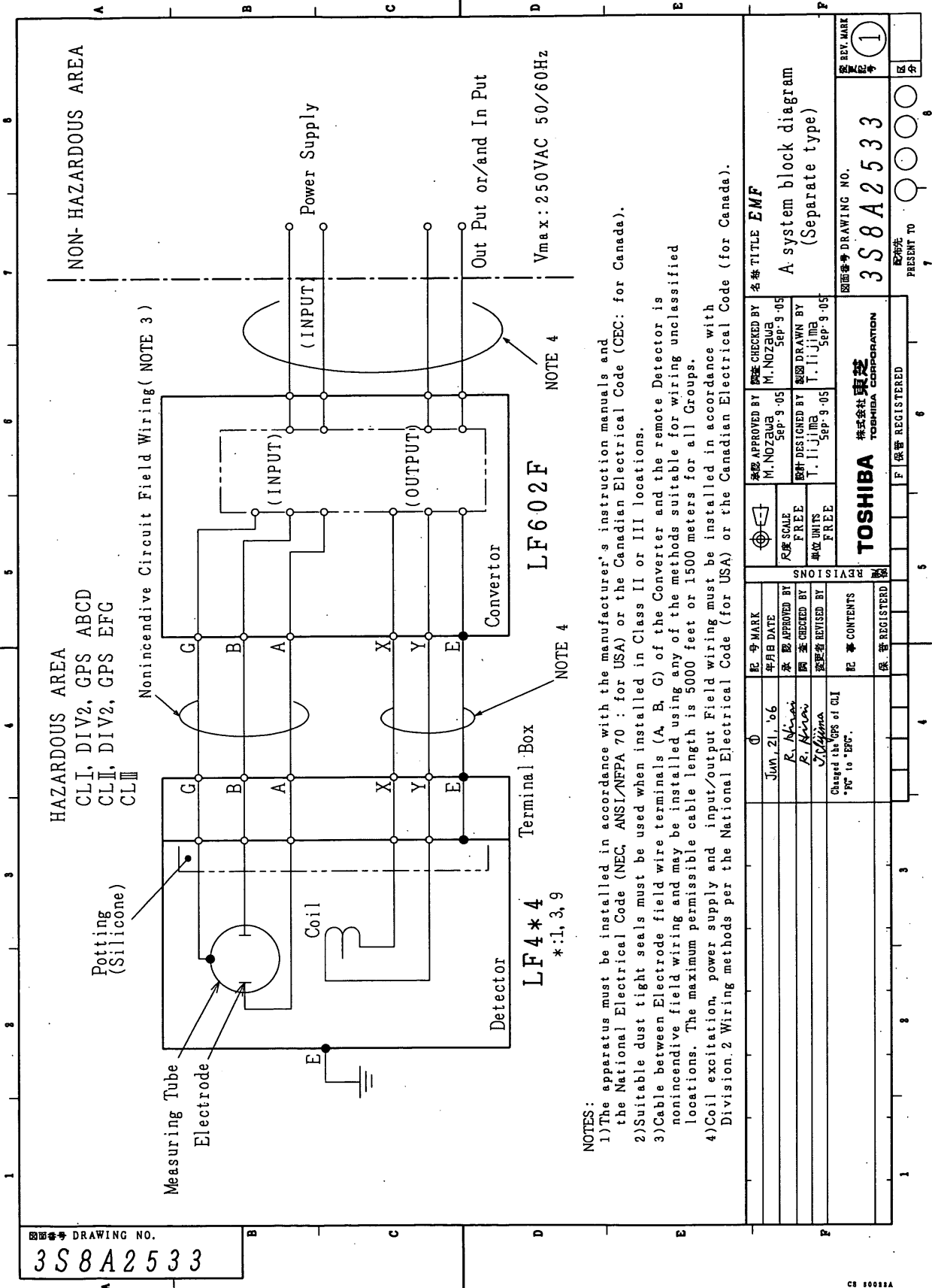

Appendix 3**Electromagnetic Compatibility and Low Voltage Safety**

LF600F and LF602F electromagnetic flowmeter converter has been confirmed to comply with the requirements of the EMC directive 89/336/EEC and the low voltage directive 93/68/EEC.

EMC directive

This device has been tested in a typical configuration in accordance with the following standards in an industrial environment.

• Generic emission standard	EN50081-2
Conducted RF emissions	EN55011
Radiated RF emissions	EN55011
• Generic immunity standard	EN50082-2
Conducted RF immunity	ENV50141
Radiated RF immunity	ENV50140/ENV50204
Electrostatic discharge	EN61000-4-2
Fast transient burst	EN61000-4-4

The above EMC tests have been carried out with the flowmeter installed properly in accordance with this instruction manual. However, there is no guarantee that interference will not occur in a particular installation.

To reduce interference to or from other equipment, please check the following installation points.

- (1) Use shielded cables for all I/O cables. When the flowmeter is the separated type, the signal cable and excitation cable for the connection between the detector and the converter are supplied by Toshiba. To improve immunity, pass each cable through a thick steel conduit tube.
- (2) If this device is installed in an area where RFI exists, deviation of the current output signal may be caused. In this case, ferrite cores will be required on each I/O cable. Please contact Toshiba or the agency if required.
- (3) This device is designed to be used in an industrial environment and may cause reception interference to radio, television or wireless communications. In this case, relocate the receiving antenna.
- (4) The use of a transceiver or wireless equipment near this device may cause interference to the accurate measurement. If deviation of the output signal appears during use of a radio, increase the distance between the converter or the signal cable and the antenna.

Low voltage directive

Low voltage standards EN61010-1

Environmental conditions:

 Installation category II

 Pollution degree 2

 Altitude Up to 2000 m

 Other conditions are specified in Chapter 15, "Specifications."

Write down the address and phone number of the distributor from which you purchased this product, the product code, SER.NO. and so on.

Distributor Address _____
Name _____
Phone number () —
Product code _____
SER.NO. _____

TOSHIBA CORPORATION

Free Manuals Download Website

<http://myh66.com>

<http://usermanuals.us>

<http://www.somanuals.com>

<http://www.4manuals.cc>

<http://www.manual-lib.com>

<http://www.404manual.com>

<http://www.luxmanual.com>

<http://aubethermostatmanual.com>

Golf course search by state

<http://golfingnear.com>

Email search by domain

<http://emailbydomain.com>

Auto manuals search

<http://auto.somanuals.com>

TV manuals search

<http://tv.somanuals.com>