

TOSHIBA

Blu-ray Disc™/DVD Player
BDX5200KU

OWNER'S MANUAL



- INTRODUCTION
- CONNECTIONS
- PLAYBACK
- FUNCTION SETUP
- OTHERS



Owner's Record

The model number and serial number are on the back of the unit. Record these numbers in the spaces below. Refer to these numbers whenever you communicate with your Toshiba dealer about this unit.

Model number:

Serial number:

© 2011 Toshiba Corporation

SAFETY PRECAUTIONS

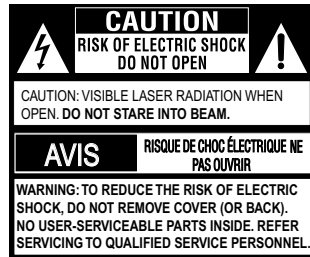

The lightning flash with an arrowhead symbol, within the equilateral triangle, is intended to alert the user to the presence of uninsulated "dangerous voltage" within the product's enclosure that may be of sufficient magnitude to constitute a risk of electric shock to persons.



The exclamation point within the equilateral triangle is intended to alert the user to the presence of important operating and maintenance (servicing) instructions in this owner's manual.

WARNING: TO REDUCE THE RISK OF FIRE OR ELECTRIC SHOCK, DO NOT EXPOSE THIS APPLIANCE TO RAIN OR MOISTURE. DANGEROUS HIGH VOLTAGES ARE PRESENT INSIDE THE ENCLOSURE. DO NOT OPEN THE CABINET. REFER SERVICING TO QUALIFIED PERSONNEL ONLY.



The symbol for Class II (Double Insulation)

IMPORTANT SAFETY INSTRUCTIONS

1. Read these instructions.
2. Keep these instructions.
3. Heed all warnings.
4. Follow all instructions.
5. Do not use this apparatus near water.
6. Clean only with a dry cloth.
7. Do not block any of the ventilation openings. Install in accordance with the manufacturer's instructions.
8. Do not install near any heat sources such as radiators, heat registers, stoves, or other apparatus (including amplifiers) that produce heat.
9. Do not defeat the safety purpose of the polarized or grounding-type plug. A polarized plug has two blades with one wider than the other. A grounding type plug has two blades and a third grounding prong. The wide blade or the third prong is provided for your safety. If the provided plug does not fit into your outlet, consult an electrician for replacement of the obsolete outlet.
10. Protect the power cord from being walked on or pinched particularly at plugs, convenience receptacles, and the point where they exit from the apparatus.
11. Only use attachments/accessories specified by the manufacturer.
12. Use only with the cart, stand, tripod, bracket, or table specified by the manufacturer, or sold with the apparatus. When a cart is used, use caution when moving the cart/apparatus combination to avoid injury from tip-over.
13. Unplug this apparatus during lightning storms or when unused for long periods of time.
14. Refer all servicing to qualified service personnel. Servicing is required when the apparatus has been damaged in any way, such as the power-supply cord or plug is damaged, liquid has been spilled or objects have fallen into the apparatus, the apparatus has been exposed to rain or moisture, does not operate normally, or has been dropped.



ADDITIONAL SAFETY INSTRUCTIONS

15. Do not overload wall outlets; extension cords, or integral convenience receptacles as this can result in a risk of fire or electric shock.
16. Never expose the apparatus to dripping or splashing or place items such as vases, aquariums, any other item filled with liquid, or candles on top of the unit.
17. Keep your fingers well clear of the disc tray as it is closing. Neglecting to do so may cause serious personal injury.
18. Do not place anything on top of this unit.
19. Do not place the apparatus on amplifiers or equipment that may produce heat.
20. Never block or cover the slots or openings in the unit.
Never place the unit: 1) on a bed, sofa, rug or similar surface; 2) too close to drapes, curtains, or walls; or 3) in a confined space such as a bookcase, built-in cabinet, or any other place with poor ventilation.
The slots and openings are provided to protect the unit from overheating and to help maintain reliable operation.
21. Do not use a cracked, deformed, or repaired disc. These discs are easily broken and may cause serious personal injury and apparatus malfunction.
22. If the apparatus should emit smoke or an unusual odor, immediately disconnect the power cord from the wall outlet. Wait until the smoke or smell stops, then ask your dealer for a check and repair. Neglecting to do so may cause fire.
23. During thunderstorms, do not touch the connecting cables or the apparatus.
24. Warning: To prevent spread of fire, keep candles or other open flames away from this product at all times.
25. Main plug is used as disconnect device and it should remain readily operable during intended use. In order to disconnect the apparatus from the mains completely, the mains plug should be disconnected from the mains socket outlet completely.

PRECAUTIONS

CAUTION:

- To prevent direct exposure to laser beam, do not try to open the enclosure. Visible and invisible laser radiation when open and interlocks defeated. DO NOT STARE INTO BEAM.
- Use of controls or adjustments or performance of procedures other than those specified may result in hazardous radiation exposure.
- Danger of explosion if battery is incorrectly replaced. Replace only with the same or equivalent type.

Warning: Batteries shall not be exposed to excessive heat such as sunshine, fire or the like.

FCC Information

This device complies with Part 15 of the FCC Rules. Operation is subject to the following two conditions: (1) this device may not cause harmful interference, and (2) this device must accept any interference received, including interference that may cause undesired operation.

The party responsible for compliance to these rules is:

Toshiba America Information Systems, Inc.
9740 Irvine Blvd., Irvine, CA 92618.
Ph: 1-800-631-3811

Note: This equipment has been tested and found to comply with the limits for a Class B digital device, pursuant to part 15 of the FCC Rules. These limits are designed to provide reasonable protection against harmful interference in a residential installation. This equipment generates, uses, and can radiate radio frequency energy and, if not installed and used in accordance with the instructions, may cause harmful interference to radio communications.

However, there is no guarantee that interference will not occur in a particular installation. If this equipment does cause harmful interference to radio or television reception, which can be determined by turning the equipment off and on, the user is encouraged to try to correct the interference by one or more of the following measures:

- Reorient or relocate the receiving antenna.
- Increase the separation between the equipment and receiver.
- Connect the equipment into an outlet on a circuit different from that to which the receiver is connected.
- Consult the dealer or an experienced radio/TV technician for help.

FCC Radiation Exposure Statement:

This equipment complies with FCC radiation exposure limits set forth for an uncontrolled environment.

This equipment should be installed and operated with minimum distance 20cm between the radiator and your body.

This class B digital apparatus complies with Canadian ICES-003.

Cet appareil numérique de la classe B est conforme à la norme NMB-003 du Canada.

WARNING: Changes or modifications to this unit not expressly approved by Toshiba, or parties authorized by Toshiba, could void the user's authority to operate the equipment.

Notes On Copyright

This product incorporates copyright protection technology that is protected by U.S. patents and other intellectual property rights. Use of this copyright protection technology must be authorized by Rovi Corporation, and is intended for home and other limited viewing uses only unless otherwise authorized by Rovi Corporation. Reverse engineering or disassembly is prohibited.

On Placement

- Do not use this unit in places which are extremely hot, cold, dusty or humid.
- Do not restrict the air flow of this unit by placing it somewhere with poor air flow, by covering it with a cloth, or by placing it on bedding or carpeting.
- Be sure to remove the disc and unplug the AC power cord from the outlet before carrying the unit.

On Safety

- Do not handle the AC power cord with wet hands and do not put your fingers or objects into the unit.
- When connecting or disconnecting the AC power cord, grip the plug and not the cord itself. Pulling the cord may damage it and create a hazard.
- When you are not going to use the unit for a long period of time, disconnect the AC power cord.

On Condensation

- When left in a heated room where it is warm and damp, water droplets or condensation may form inside the equipment. When there is condensation inside the unit, the unit may not function normally. Let the unit stand for 1-2 hours before turning the power on or gradually heat the room and allow the unit to dry before use.

On Recycling

- This unit's packaging materials are recyclable and can be reused. Please dispose of any materials in accordance with your local recycling regulations.
- Batteries should never be thrown away or incinerated but disposed of in accordance with your local regulations concerning chemical wastes.



Products that earn the ENERGY STAR® prevent greenhouse gas emissions by meeting strict energy efficiency guidelines set by the U.S. Environmental Protection Agency and the U.S. Department of Energy. ENERGY STAR and the ENERGY STAR mark are registered U.S. marks.

Supplied Accessories

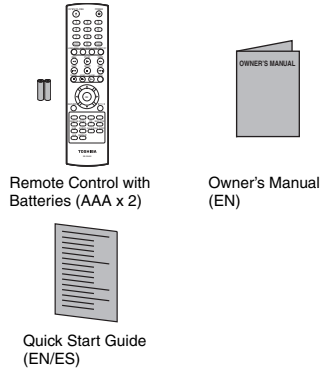

Remote Control with
Batteries (AAA x 2)

Owner's Manual
(EN)

Quick Start Guide
(EN/ES)

Symbols Used in this Manual

To specify for which media type each function is, we put the following symbols at the beginning of each item to operate.

Symbol	Description
	Description refers to BD-video and BD-RE / BD-R recorded in BDMV format
	Description refers to DVD-video
	Description refers to Audio CD / DTS-CD
	Description refers to DVD-RW/R with AVCHD files
	Description refers to BD-RE/R, DVD-RW/R, CD-RW/R and SD Memory Card with MP3 files
	Description refers to BD-RE/R, DVD-RW/R, CD-RW/R and SD Memory Card with Windows Media™ Audio files
	Description refers to BD-RE/R, DVD-RW/R, CD-RW/R and SD Memory Card with JPEG files

If you do not find any of the symbols listed above under the function heading, the operation is applicable to all media.

Trademark Information

Blockbuster is a registered trademark of Blockbuster, Inc.
Netflix is a registered trademark of Netflix Inc.
VUDU is a trademark of VUDU, Inc.
ChinernaNow is a registered trademark of Best Buy, Inc.
YouTube is a registered trademark of Google, Inc.
Pandora is a registered trademark of Pandora Media, Inc.

	"Wi-Fi CERTIFIED" logo is a registered trademark of Wi-Fi Alliance. "Wi-Fi PROTECTED SETUP" logo is a trademark of Wi-Fi Alliance.
	"DVD" is a trademark of DVD Format / Logo Licensing Corporation.
	HDMI, the HDMI logo, and High-Definition Multimedia Interface are trademarks or registered trademarks of HDMI Licensing LLC in the United States and other countries.
	Manufactured under license from Dolby Laboratories. Dolby and the double-D symbol are registered trademarks of Dolby Laboratories.
	Manufactured under license under U.S. Patent #'s: 5,451,942; 5,956,674; 5,974,380; 5,978,762; 6,226,616; 6,487,535; 7,392,195; 7,272,567; 7,333,929; 7,212,872 & other U.S. and worldwide patents issued & pending. DTS and the Symbol are registered trademarks, & DTS-HD, DTS-HD Master Audio Essential and the DTS logos are trademarks of DTS, Inc. Product includes software. © DTS, Inc. All Rights Reserved.
	x.v.Color and x.v.Color logo are registered trademarks of Sony Corporation.
	AVCHD and the AVCHD logo are trademarks of Panasonic Corporation and Sony Corporation.
	Oracle and Java are registered trademarks of Oracle and/or its affiliates. Other names may be trademarks of their respective owners.
	"Blu-ray Disc™", "Blu-ray™", "Blu-ray 3D™", "BD-LIVE™" and "BONUSVIEW™" and the logos are trademarks of Blu-ray Disc Association.
	Windows Media and the Windows logo are trademarks or registered trademarks of Microsoft Corporation in the United States and/or other countries.

Table of Contents

Introduction	
● SAFETY PRECAUTIONS	2
● IMPORTANT SAFETY INSTRUCTIONS	2
● PRECAUTIONS	3
● Supplied Accessories	4
● Symbols Used in this Manual	4
● Trademark Information	4
● Table of Contents	5
● Features	6
● Identification of Controls	7
Front panel	7
Rear panel	7
● Using the Remote Control	8
Remote Control	8
Installing batteries	9
Operating with the remote control	10
Connections	
● Connecting to a TV	11
Connecting to a TV using an HDMI® cable	11
Connecting to a TV using an A/V cable	11
● Connecting to an Audio System	12
Via 2-Channel Analog Audio Output	12
Via Digital Audio Output	12
Via HDMI® Audio Output	12
● Network Connection	13
Connecting your player to a wired router	13
Connecting your player to a wireless access point or router	13
Playback	
● Information on Playback	14
Playable Discs and Files	14
Unplayable Discs and Files	14
Color Systems	15
Region Codes	15
Structure of Disc/SD Card Contents	15
● Playing a Disc	16
Basic playback	16
● Variable Speed Playback	17
Playing in fast reverse / forward directions	17
Playing frame by frame	17
Playing in slow motion	17
● Locating a Desired Section	17
Locating a title using the pop/top menu	17
Locating a specific chapter or track	18
● Accessing a Specific Location Directly	18
Locating a specific title/chapter/time	18
● Repeating a Title, Chapter, Track or Specific Segment	19
Repeating a title, chapter or track	19
Repeating a specific segment	19
● Playing in a Random Order	19
Playing tracks or files in a random order	19
● PIP(BONUSVIEW™) Setting	20
● Camera Angle	20
● Audio Selection	20
● Subtitle Selection	21
● Displaying On-screen Information	21
● Playing AVCHD/MP3/WMA/JPEG Files	22
Playing files on a data disc	22
● Using an SD Card	23
Inserting an SD card	23
● Using a USB Device	23
Operating a USB device	23
● Using Media Player function	24
Operating Media Player function	24
Customizing the Function Settings	
● General Operations	25
● Info Menu	25
● Performing Quick-Setup	25
● Using BD-Live™ Features	26
● Display Setting	27
● Audio Setting	28
● Language Setting	29
● Parental Control	29
● System Setting	30
● Network Connection Setting	31
● Upgrading Your Player's Firmware	33
● Using the Connected Applications	34
Watching Movies with Blockbuster®	34
Watching Movies with CinemaNow®	34
Watching Movies with Netflix®	35
Listening to Music with Pandora®	36
Watching Movies with VUDU™	36
Watching Movies with YouTube®	36
Others	
● Troubleshooting & Maintenance	37
Troubleshooting	37
Maintenance	38
● Glossary	39
● Specifications	41
● Limited Warranty	42

Features

Blu-ray Disc™

You can enjoy Blu-ray Disc™ which is capable of storing five times more data than a conventional DVD.

BD-Java

With some Blu-ray Disc™ which support Java applications, you can enjoy the interactive functions such as games or interactive menus.

BD-Live™

BD-Live™ (BD-ROM version 2 Profile 2.0) that allows interactive functions to be used when this unit is connected to the Internet in addition to the BONUSVIEW function. The various functions differ depending on the disc.

Full high-definition video playback

Watch movies in the highest picture quality available for your HDTV. This unit offers full high-definition video playback up to 1080p resolution for an amazing viewing experience. A highly detailed picture and increased sharpness delivers a more true-to-life picture.

DVD Upconversion for enhanced picture quality

Your current DVD will look even better than before thanks to video upconversion. Upconversion will increase the resolution of standard definition DVD to high definition up to 1080p over an HDMI connection. The picture will be less jagged and more realistic for a near high-definition experience.

Enjoy your content on different kinds of media

Full backwards compatibility with Blu-ray Disc™, DVD, CD and SD card ensures that you can continue to enjoy your current audio-video collection. Additionally, you can view JPEG digital pictures or listen to MP3 or Windows Media™ Audio music files.

Experience rich multi-channel surround sound

Multi-channel surround sound, which recognizes real-to-life sound and makes you feel like you are really there.

PIP (BONUSVIEW™)

Some BD-videos have the PIP function which enables you to display the secondary video in the primary video. You can call up the secondary video by pressing **BONUSVIEW** whenever the scene contains the secondary video.

Pop-up menu

Some BD-video have pop-up menu which is a navigation menu that can be called up and be operated on the TV screen without interrupting the playback. You can call up the pop-up menu by pressing **POP/TOP** or **MENU**. Contents in the pop-up menu vary depending on the disc.

Playback of Content from an SD Memory Card

You can play back MP3 / WMA / JPEG files stored in an SD Memory Card. You can store picture-in-picture commentary, subtitles or other extras for BD-ROM ver. 2 (Profile 2.0 / Profile 1.1) files in an SD Memory Card and play back with the BD-video.

Playing back AVCHD files

This unit supports playback of AVCHD format files (new format for high definition video camcorders) recorded on disc. Your high definition personal archive is playable in HD quality.

x.v.Color®

This unit supports playback of video contents on discs recorded with "x.v.Color" technology. To watch this video content with the "x.v.Color", a TV or other display device supporting both video image reproduction using the "x.v.Color" standard and capable of manually switching its color setting is required. Please refer to the owner's manual of your display device for further information.

Wi-Fi CERTIFIED

The Wi-Fi CERTIFIED logo is an assurance that Wi-Fi Alliance has tested a product in numerous configurations and with a diverse sampling of other devices to ensure compatibility with other Wi-Fi CERTIFIED equipment that operates in the same frequency band.

Blu-ray 3D Feature

This product can play 3D contents through an HDMI cable.

To implement the 3D effect, connect a 3D device (3D-compliant AV receiver, 3D-compliant TV) to the product using an HDMI cable, and play the 3D content while wearing 3D vision glasses.

Easy and simple connection to your HDTV via HDMI®

Connect this unit to your HDTV with one single HDMI (High-Definition Multimedia Interface) cable. It is recommended to use a High Speed HDMI Cable for better compatibility. The high definition video output signal will be transferred to your HDTV without conversion to analog signals, so you will get excellent picture and sound quality.

Thanks to other multiple outputs, you can also easily connect to your home theater system or amplifier.

HDMI® CEC (Consumer Electronics Control)

This unit supports HDMI CEC, which allows integrated system control over HDMI and is part of the HDMI standard.

This function may not work properly on some devices.

HDMI 1080p/24F output (Blu-ray Disc™ only)

This unit is equipped with a feature which can provide the smooth movement in the playback of film originated material with the frame rate of 24 frames per second with progressive scan. (Available only when the TV is connected by an HDMI cable and compatible with 1080p/24F frame input.)

Refer to "Display Setting" in "Customizing the Function Settings" on page 27.

Copyright protection system

To play back the digital video images of a Blu-ray Disc™ / DVD via an HDMI connection, it is necessary that both the unit and the TV (or an AV amplifier) support a copyright protection system called HDCP (high-bandwidth digital content protection system). HDCP is copy protection technology that comprises data encryption and authentication of the connected AV device. This unit supports HDCP. Please read the operating instructions of your TV (or AV amplifier) for more information.

Identification of Controls

Front panel

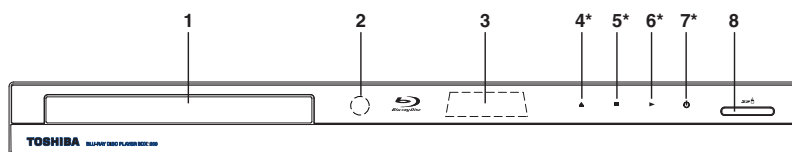

(*) Notes:

1. These indicators are located in the sensor field.
2. When this unit is off, these indicators are dimmed. If a finger is brought close to the sensor field, the indicators will be invoked and light up.

1. Disc tray

2. Remote sensor

3. Display

4. OPEN/CLOSE indicator

- When invoked (white), tap to open/close the disc tray.

5. STOP indicator

- When invoked (white), tap to stop playback.

6. PLAY indicator

- When invoked (white), tap to start playback.

7. ON/STANDBY indicator

- When invoked (white), tap to turn on the unit, or to turn the unit into the standby mode. (To completely turn off the unit, you must unplug the AC power cord.)

8. SD card slot

How to Power On Your Unit ?

1. Connect to a standard AC outlet to supply power to this unit, the **ON/STANDBY** indicator lights in red and then turns white at once.
2. After about 10 seconds, the **ON/STANDBY** indicator will turn red automatically.
3. Touch the **ON/STANDBY** button to turn on the unit. The **ON/STANDBY** indicator will remain white (ON mode).

Rear panel

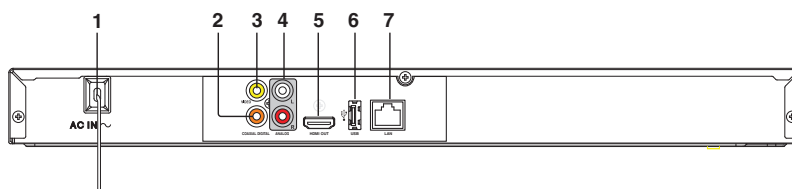

1. AC power cord

- Connect to a standard AC outlet to supply power to this unit.
- Unplug this cord from the AC outlet to completely turn off the unit.

2. COAXIAL DIGITAL AUDIO OUT jack

- Use to connect an AV receiver / amplifier, Dolby Digital / DTS decoder or other device with a coaxial digital audio input jack using a coaxial digital audio cable.

3. VIDEO OUT jack

- Use to connect a TV, an AV receiver or other device with a composite video cable.

4. ANALOG AUDIO OUT(L/R) jacks

- Use to connect a TV, an AV receiver / amplifier or other device with a composite audio cable.

5. HDMI OUT jack

- Use to connect a TV with an HDMI compatible port via an HDMI cable.

6. USB jack

- Use to connect USB flash drives/wireless LAN adapter (not included).

7. LAN terminal

- Use to connect a network equipment with LAN cable.

Using the Remote control

Remote control

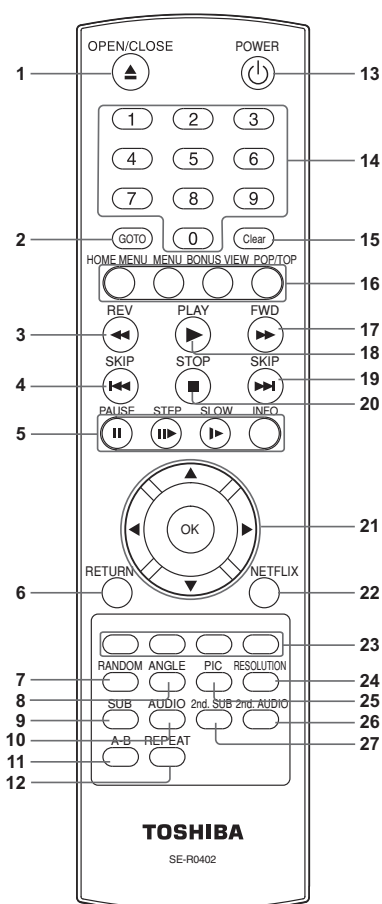

No.	Item	Description
1	OPEN/CLOSE ▲	Press to open or close the disc tray.
2	GOTO	Press to display the search menu.
3	REV ◀◀	During playback, press to fast reverse the playback.
4	SKIP ◀◀◀	<ul style="list-style-type: none"> During playback, press once to return to the beginning of the current title, chapter, track or file. During playback, press twice to return to the previous title, chapter, track or file. During the JPEG playback, press to return to the previous file.
5	PAUSE	Press to pause playback.
5	STEP ▶	Press to advance one frame.
5	SLOW ▶▶	Press to play back the disc in slow motion.
5	INFO	Press to display disc information.
6	RETURN	Press to return to the previous menu.
7	RANDOM	Press to turn random function on or off for Audio CD, MP3 or WMA disc.
8	ANGLE	Press to select a viewing angle if multiple angles are available on the disc.
9	SUB(SUBTITLE)	Press to display the subtitle menu.
10	AUDIO	Press to select the audio mode.
11	A-B	Press to play back a defined section between point A and B repeatedly.
12	REPEAT	Press to toggle between various repeat modes.
13	POWER ⏻	Press to turn on the unit, or to turn the unit into the standby mode. (To completely turn off the unit, you must unplug the power cord.)
14	Number buttons	<ul style="list-style-type: none"> In playback mode, press GOTO, then press the number buttons to enter a title, chapter, track, time or file number. In menu mode, press to enter the parental code password.
15	CLEAR	Press to clear an input error.

	HOME MENU	Press to display the Connected in home menu.
	MENU	Press to display disc menu.
	BONUSVIEW	Press to switch picture-in-picture feature on or off (only applicable to BD-video which supports the PIP function). For more details, see "PIP (BONUSVIEW™) Setting" on page 20.
16	POP/TOP	<ul style="list-style-type: none"> • During Blu-ray Disc playback, press to open a menu that lets you control Blu-ray Disc playback. • During DVD playback, press to open the DVD menu (if available).
17	FWD ►►	During playback, press to fast forward the playback.
18	PLAY ►	Press to start playback or resume playback.
19	SKIP ►►I	<ul style="list-style-type: none"> • During playback, press to skip to the next title, chapter, track or file. • During the JPEG playback, press to go to the next file.
20	STOP ■	Press to stop playback.
	▲ / ▼ / ◀ / ▶	Press to select items or settings.
21	OK(ENTER)	<ul style="list-style-type: none"> • Press to confirm or select menu items. • Press to activate the on-screen keyboard while configuring a wireless network.
22	NETFLIX	Press to use Netflix service directly. (Make sure your Blu-ray Disc™ player is correctly connected to the internet and network settings are properly configured.)
23	RED / GREEN / BLUE / YELLOW	<ul style="list-style-type: none"> • Press to select items on some Blu-ray Disc™ contents. • When file list / thumbnail list is shown, press to switch between pages.
24	RESOLUTION	Press to select the video resolution in full stop mode.
25	PIC	<p>In playback mode, press to adjust picture quality according to your preference (Actual effect to picture may vary depending on TV.):</p> <ul style="list-style-type: none"> • E.P.M (Enhanced Picture Mode): The picture is sharper with enhanced color. • Sharpness
26	2nd. AUDIO	In PIP mode, press to turn the audio for the secondary video on or off. For more details, see "PIP (BONUSVIEW™) Setting" on page 20.
27	2nd. SUB (SUBTITLE)	In PIP mode, press to turn the subtitle for the secondary video on or off.

Installing batteries

Install the batteries (AAAx2) matching the polarity indicated inside battery compartment of the remote control.

1 Open the cover.

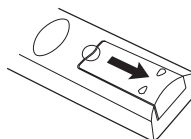

2 Insert batteries.

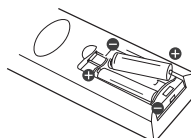

Make sure to match the + and – on the batteries to the marks indicated in the battery compartment.

3 Close the cover.

Caution: Never throw batteries into a fire.

Notes:

- Do not mix different battery types or combine used batteries with new ones.
- If the remote control does not operate correctly, or if the operating range becomes reduced, replace both batteries with new ones.
- If the batteries are dead or if you will not be using the remote control for a long time, remove the batteries to prevent battery acid from leaking into the battery compartment.

Operating with the remote control

Point the remote control at the remote sensor and press the buttons.

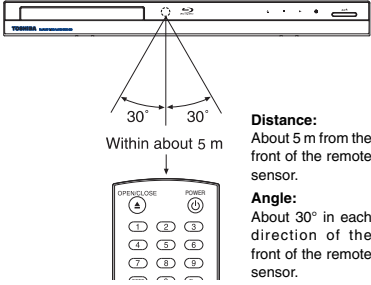

Distance:
About 5 m from the front of the remote sensor.

Angle:
About 30° in each direction of the front of the remote sensor.

* Do not expose the remote sensor of the Blu-ray Disc™ player to a strong light source such as direct sunlight or other illumination. If you do so, you may not be able to operate the Blu-ray Disc™ player via the remote control.

Notes:

- Direct the remote control at the remote sensor of the Blu-ray Disc™ player.
- When using the remote control, press the buttons at intervals of about 1 second to ensure the correct mode of operation.
- Do not drop or give the remote control a shock.
- Do not leave the remote control near an extremely hot or humid place.
- Do not spill water or put anything wet on the remote control.
- Do not open the remote control.
- If the remote control is not going to be used for a long time, remove the battery to avoid damage caused by battery leakage corrosion.

Connecting to a TV

Connect the Blu-ray Disc™ player to your TV.

Connecting to a TV using an HDMI® cable (Supports up to 1080i/1080p, 1080p/24F resolution.)

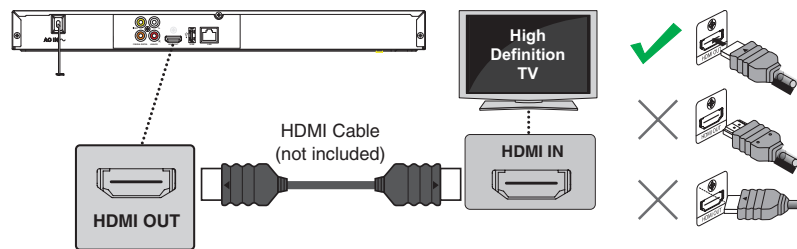

CONNECTIONS

Notes:

- To enjoy the viewing of 3D content, an HDMI connection with High Speed HDMI cable is required.
- Do not tilt the connector when inserting it into the HDMI jack, and make sure the shapes of the jack and the connector are matched.
- When using a non-HDCP compatible TV, the image will not display properly.
- An HDMI cable carries both video and audio signals. If you want to use TV speakers, you do not need to make an additional audio connection if you are using an HDMI cable.

Connecting to a TV using an A/V cable

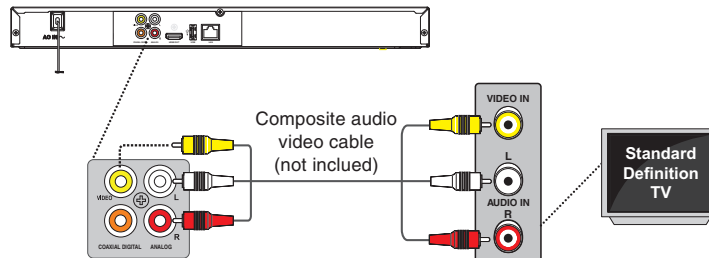

Notes:

- Refer to the owner's manual of the connected TV as well.
- When connecting to a TV using an HDMI cable, no video output.
- When you connect the DVD player to your TV, be sure to turn off the power and unplug both units from the wall outlet before making any connections.
- If your television set has one audio input, connect the left and right audio outputs of the DVD player to a Y cable adapter (not supplied) and then connect to your TV.
- Connect the DVD player directly to your TV. If you connect the DVD player to a VCR, TV/VCR combination or video selector, the playback picture may be distorted as DVDs are copy protected.
- Analog audio out will not have sound if DTS playback is selected.

Connecting to an Audio System

- When you change the connections, all devices should be turned off.
- Refer to the manual accompanying external devices for more information.

Via 2-Channel Analog Audio Output

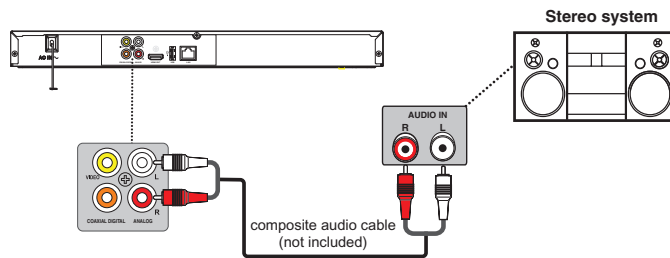

Via Digital Audio Output

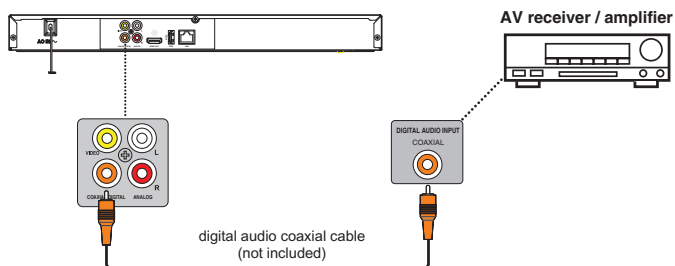

Via HDMI® Audio Output

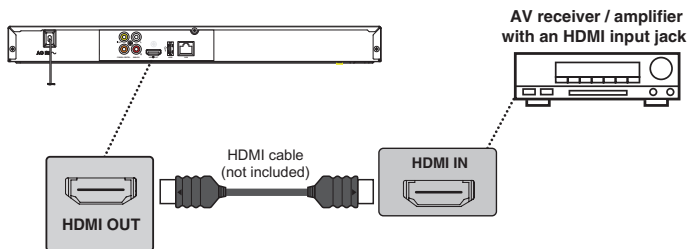

Audio Cable, Digital Audio Coaxial Cable and HDMI Cable NOT INCLUDED.

Network Connection

Your Blu-ray Disc™ player can be connected to your home network:

- By connecting an Ethernet cable to the ETHERNET jack on the rear of your player and to a wired hub or router. Using a wired network provides the best performance, because the attached devices connect directly to the network and are not subject to radio frequency interference.
- By connecting through the built-in wireless device and a wireless access point or router.

Connecting your player to a wired router

- Connect an Ethernet cable (CAT5 or better with RJ45 connector) to the ETHERNET jack on the back of your player and to an Ethernet jack on a hub or broadband router.

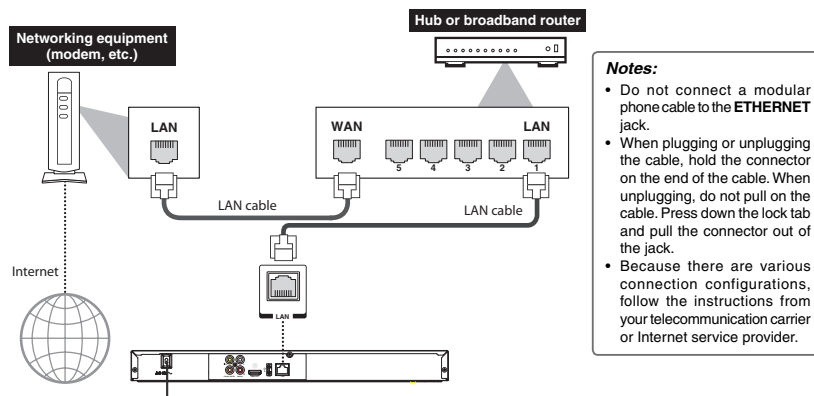

CONNECTIONS

Connecting your player to a wireless access point or router

Your Blu-ray Disc™ player has an integrated Wi-Fi device and antenna. No physical connection to the wireless router is necessary.

- Configure your player to access the wireless access point or router. For more information, see "Configuring a wireless Internet connection" on page 31.
- The network configuration and connection method may vary depending on the equipment in use and the network environment. Your Blu-ray disc player is equipped with an IEEE 802.11n wireless module, which also supports the 802.11 a/b/g/n standards. For the best wireless performance, we recommend using an IEEE 802.11n certified Wi-Fi network (access point or wireless router).

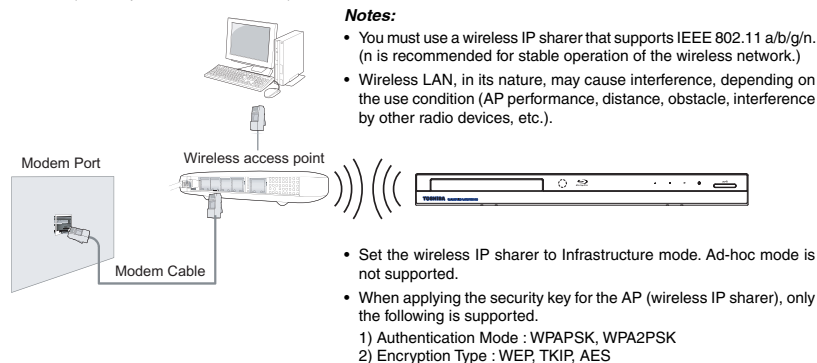

Information on Playback

Before you start playing back a disc, read the following information.

Playable Discs and Files

This unit is compatible to play back the following discs / files.

To play back a disc / file, make sure that it meets the requirements for region codes and color systems as described below. You can play back discs that have the following logos.

Other disc types are not guaranteed to play back.

Playable discs	Logos
Blu-ray Disc™ - BD-ROM (single / dual layer) - BD-RE (single / dual layer) (Recorded in BDMV format) - BD-R (single / dual layer)(Recorded in BDMV format) (Unclosed discs may not be played back.)	
DVD-ROM	
DVD-RW	
DVD-R	
CD-DA (audio CD)	
CD-RW	
CD-R	
DTS-CD	-

Playable files	Media
AVCHD	DVD-RW/-R
MP3	
Windows Media™ Audio	BD-RE/-R, DVD-RW/-R, CD-RW/-R, SD Memory Card
JPEG	(including SDHC), miniSD Card, microSD Card
MKV	

- This unit cannot playback the disc contents protected by Windows Media™ Digital Rights Management (DRM).

Readable cards	Playable files/data
SD Memory Card (8 MB - 2 GB)	MP3, Windows Media™
SDHC Memory Card (4 GB - 8 GB)	Audio, JPEG, picture-
miniSD Card (8 MB - 2 GB)	in-picture commentary,
microSD Card (8 MB - 2 GB)	subtitles or other extras for BD-ROM

- This unit supports SD Memory Card with FAT12/FAT16 file system, and SDHC Memory Card with FAT32 file system.
- This unit does not support NTFS file system.
- This unit may not read the SD Memory Cards formatted on a computer. If that is the case, please reformat the SD Memory Cards in this unit and try again.
- This unit does not support miniSDHC and microSDHC Memory Card.
- For miniSD Card and microSD Card, the adapter is necessary.



- Portions of this product are protected under copyright law and are provided under license by ARIS / SOLANA / 4C.
- Please keep the SD Memory Cards in their cases when you are not using them.
- Do not try to open or modify the card.
- Do not touch the terminal surface with your fingers or any metals.
- Do not attach additional labels or stickers to cards.
- Do not remove the label of the SD Memory Cards.
- This unit recognizes up to 8 characters of file name in the SD Memory Card. Characters after 8th will not be displayed.
- TOSHIBA does not guarantee 100% compatibility with all SD Cards and USB Device.

Unplayable Discs and Files

The following discs will not be played back in this unit.

- CD-ROM
- CD-I (compact disc-interactive)
- DVD-RAM
- VSD (video single disc)
- DVD-audio
- HD DVD
- VIDEO CD
- Unfinalized disc
- SACD
- Blu-ray Disc™ / DVD / SD Memory Card containing DivX® files.
- Blu-ray Disc™ / DVD hybrid disc (played back as a BD-video only)
- Blu-ray Disc™ that contains AVCHD files
- DVD-RW/-R recorded in non compatible recording format.
- Super Audio CD - Only the sound on the CD layer can be heard. The sound on the high-density Super Audio CD layer cannot be heard.
- Playability of dual discs are not guaranteed.
- multi session disc
- multi border disc

Color Systems

BD-video and DVD-video are recorded in different color systems throughout the world. The most common color system is NTSC (which is used primarily in the United States and Canada).

Region Codes

This unit has been designed to play back BD-video with region "A" and DVD-video with region "1" or "ALL". You cannot play back BD-video or DVD-video that are labeled for other regions. Look for the symbols on the right on your BD-video or DVD-video.

If these region symbols do not appear on your BD-video or DVD-video, you cannot play back the disc in this unit. The letter or number inside the globe refers to region of the world. A BD-video or DVD-video labeled for a specific region can only be played back in the unit with the same region code.



BD-video



DVD-video

Structure of Disc/SD Card Contents

The contents of Blu-ray Disc™ / DVD / AVCHD are generally divided into titles. Titles may be further subdivided into chapters.

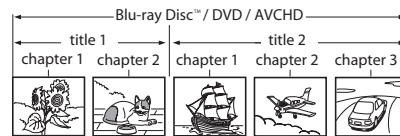

Audio CD is divided into tracks.



Data discs, USB device, SD Memory Cards containing MP3 / WMA / JPEG are divided into folders, and the folders are subdivided into files.

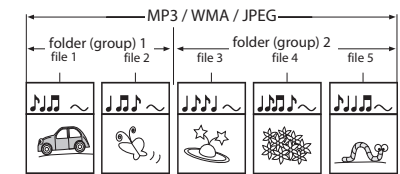

PLAYBACK

Playing a Disc

This section shows you the basics on how to play a disc.

CAUTION:

Keep your fingers well clear of the disc tray as it is closing. Neglecting to do so may cause serious personal injury.

Basic playback

Preparations

- When you want to view a disc, turn on the TV and select the video input connected to the Blu-ray Disc™ player.

1 Press the POWER button.



The Blu-ray Disc™ player turns on.

2 Press OPEN/CLOSE.



The disc tray opens.

3 Place the disc on the disc tray.



With the playback side down

4 Press OPEN/CLOSE to close the disc tray.



Playback starts.

If you insert a Blu-ray disc or a DVD that contains a top menu, a menu may appear. Use **▼** / **▲** / **◀** / **▶** to select the title you want to view, then press **OK** to start playback.

- You may need to press the **POP/TOP** or **MENU** button to display disc menu (depending on the actual Blu-ray disc or DVD.)

■ To start playback in stop mode

Press **▶ PLAY**.

■ To pause playback (still mode)

Press **⏸ PAUSE** during playback.

To resume normal playback, press the **▶ PLAY** button.

- The sound is muted during still mode.

■ To stop playback

Press **■ STOP**. The home menu is displayed.

For Blu-ray discs, press **▼/▲** to select BD-ROM, then press **OK** to start playback at the beginning of the disc.

For DVDs/audio CDs, press **▶ PLAY** to resume normal playback.

- Depending on the disc, playback starts where it stopped or at the beginning of the disc.

- If you press **■ STOP** twice, playback stops completely. To start playback again, press **▶ PLAY**. Playback starts at the beginning of the disc.

■ To remove the disc

Press **OPEN/CLOSE**.

Remove the disc after the disc tray opens completely.

- Be sure to press the **OPEN/CLOSE** button to close the disc tray after you remove the disc.

■ To turn the power off

Press **POWER** button to turn the unit off.

Variable Speed Playback

You can play discs at various speeds, and resume playback from the location where you stopped playback.

Playing in fast reverse / forward directions

Press ◀◀ or ▶▶ during playback.

 : **Fast forward playback**

 : **Fast reverse playback**

Each time you press this button, the fast-forward or fast-reverse speed changes in the following sequence:

**Fast x 2 → Fast x 4 → Fast x 8 → Fast x 16
→ Fast x 32 → Fast x 64 → Fast x 128.**

■ **To resume normal playback**

Press ▶ **PLAY**.

Notes:

- The Blu-ray Disc™ player mutes sound and subtitles during reverse and forward scan.
- The playback speed may differ depending on the disc.

Playing frame by frame

Press  during still playback.

Each time you press this button, the picture advances one frame.

■ **To resume normal playback**

Press ▶ **PLAY**.

Note: The sound is muted during frame by frame playback.

Playing in slow motion

Press  during playback.

Each time you press this button, the slow-motion speed changes in the following sequence:

Slow x 1/2 → Slow x 1/4 → Slow x 1/8

■ **To resume normal playback**

Press ▶ **PLAY**.

Notes:

- The sound is muted during slow-motion playback.
- 3 speeds are available.

Locating a Desired Section

Normally, Blu-ray discs and DVDs are divided into titles, and the titles are sub-divided into chapters. Audio CDs are divided into tracks. You can quickly locate any specific title, chapter, or track.

Locating a title using the pop/top menu

1 Press **POP/TOP**.

 The pop/top menu appears on the TV screen.

2 Press **▼ / ▲ / ◀ / ▶** to select the title you want.

If the titles in the top menu are assigned a number, you can directly locate a specific title by pressing its designated number with the number buttons.

3 Press **OK**.

Playback starts from Chapter 1 of the selected title.

Locating a specific chapter or track

Press \ll or \gg repeatedly to access the chapter or track number you want.

Playback starts from the selected chapter or track.

To locate succeeding chapters or tracks.

Playback starts from the beginning of the current chapter or track. When you press twice in quick succession, playback starts from the beginning of the preceding chapter or track.

Note: Some titles may not display chapter numbers.

Accessing a Specific Location Directly

Locating a specific title/chapter/time

1 Press GOTO.
The Goto menu appears on the TV screen.

e.g.



a. Press the GOTO button once:

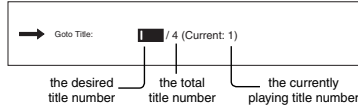

b. Press the GOTO button twice:

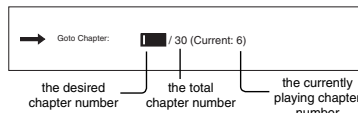

c. Press the GOTO button for 3 times:

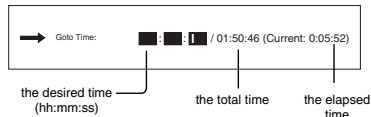

(Press GOTO once)

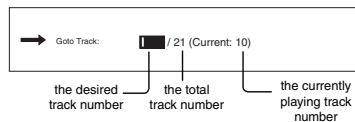

(Press GOTO once)

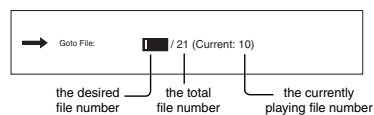

(Press GOTO twice)

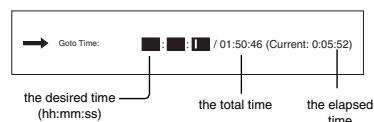

2 Press the number buttons to enter title, chapter (track) number or time.

While accessing the TIME using number buttons, just enter 2 digits in order.

The first two numbers you entered represent hours. The second two numbers you entered represent minutes.

The third two numbers you entered represent seconds. Press the **CLEAR** button to reset the numbers.

3 Press OK.
Playback starts from the selected section.

Repeating a Title, Chapter, Track or Specific Segment

Repeating a title, chapter or track



Press REPEAT repeatedly to select the desired repeat mode during playback.

e.g.

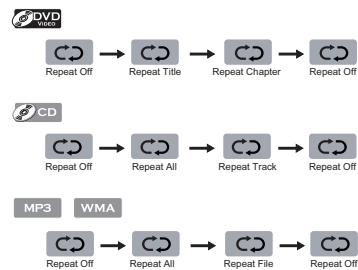

Notes:

- The repeat setting will be cancelled when you stop playback.
- The chapter, title or track repeat will be cleared when moving to another chapter, title, track / file or folder.
- Repeat playback does not function during A-B repeat playback.
- Chapter and title repeat are not available with some scenes.
- When the repeat setting is set for a MP3 or WMA folder (file), the repeat setting will be cancelled if you select other MP3 or WMA folder (file) to playback.

PLAYBACK

Repeating a specific segment



1 Press A-B at the desired starting point A during playback.



2 Press A-B at the desired ending point B during playback.



The Blu-ray Disc™ player automatically returns to point A and starts repeat playback of the selected segment (A-B).

■ To resume normal playback

Press A-B until is displayed.

Notes:

- Some discs may not permit A-B repeat operation.
- You can specify a segment only within the current title or track.
- You cannot set the A-B repeat function for a segment that includes multiple camera angles.
- A-B repeat does not function during chapter, title, track or all repeat playback.

Playing in a Random Order

Playing tracks or files in a random order



Press RANDOM repeatedly to select Random ON during playback.

Once you turn RANDOM function on, the RANDOM indicator will be activated and the system will play all files in a random sequence.

■ To resume normal playback

Press RANDOM repeatedly until is displayed.

PIP (BONUSVIEW™) Setting

Some Blu-ray discs have the PIP function which enables you to display the secondary video in the primary video. You can call up the secondary video by pressing **BONUS VIEW** whenever the scene contains the secondary video. See the documentation that came with the disc for playback instructions.

1 Press **BONUS VIEW** during playback to turn PIP mode on.



2 Press 2nd. **AUDIO** to turn the audio for the video in the PinP window on or off.



3 Press 2nd. **SUB** to turn the subtitle for the video in the PinP window on or off.

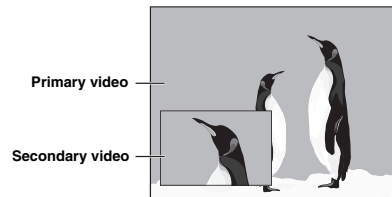

■ To resume normal playback

Press **BONUS VIEW** to turn off the PIP mode.

Note: PIP audio cannot be heard unless **Bitstream Mixed** has been selected on the Audio menu. For more information, see "Audio Setting" on page 28.

Camera Angle

Some BD-video and DVD-video contain scenes which have been shot simultaneously from various angles.

1 During playback, press **ANGLE**.

The selected angle will be displayed on the display bar at the top of the TV screen.



The first digit indicates the current viewing angle, and the second digit indicates the total number of viewing angles.

2 Press **▶**, then use **▼ / ▲** to select the desired angle.

Audio Selection

1 During playback, press **AUDIO**.

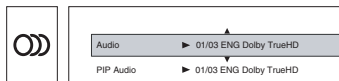

In the example "01/03 ENG Dolby TrueHD", "01" indicates the currently selected audio channel. "03" indicates the total number of audio channels. "ENG" indicates the audio language. "Dolby TrueHD" describes the currently selected audio format.

2 Press **▶**, then use **▼ / ▲** to select the desired audio language and audio format.

Notes:

- The available options of Audio vary from different disc format.
- PIP Audio is not available for all discs. It only applies to Blu-ray discs that supports picture-in-picture features.

Subtitle Selection

1 During playback, press SUB.

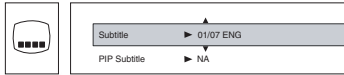

In the example "01/07 ENG",
 "01" indicates the currently selected subtitle.
 "07" indicates the total number of subtitles.
 "ENG" indicates the subtitle language.

2 Press **▶**, then use **▼ / ▲** to select the desired subtitle.





























Notes:

- The available options of Subtitle vary from different disc format.
- PIP Subtitle is not available for all discs. It only applies to Blu-ray discs that support picture-in-picture features.

Displaying On-screen Information

You can check information about the current disc by pressing INFO.

On-Screen display       

Disc format	On-Screen Display
	 Title 1 Chapter 1/25 0:02:00  1:57:35   Off Play
 	 Title 1 Chapter 1/18 0:02:00  1:57:35   Off Play
	 Track 1/12 0:00:20  0:05:35    Off Off Play
 	 File: 1/5 song1.mp3 Title: Cool Track Artist: Ricardo Funiccio Album: Dead Dux 0:02:00  0:30:00    Off Off Play
	 File: 4/13 flower.jpg   Off Pause

PLAYBACK

Playing AVCHD/MP3/WMA/JPEG Files

AVCHD MP3 WMA JPEG

You can play AVCHD, MP3, WMA or JPEG files that have been recorded on a disc on the Blu-ray Disc™ player.

Playing files on a data disc

When you insert a data disc containing picture, music, or video files into your player, icons are added to the menu to indicate that video, music, or picture files are available for playback.

1 Press **OPEN/CLOSE** to open the disc tray, place a disc that contains video/MP3/JPEG files.

2 In Home Menu, press **▼ / ▲** to select **Media**, and then press **▶**,

If a USB device and a SD card containing music are inserted at the same time, the system will enter the source selection screen shown as below:

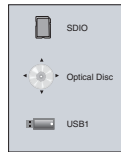

If no USB device or SD card is inserted, the system will only show optical disc.

3 Press **▼ / ▲** to select a desired source and then press **▶** to highlight an option, and then press **OK**.

(For example: selecting the Pictures)

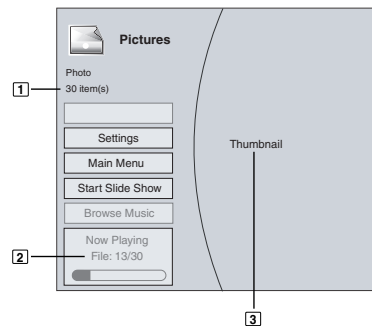

- 1**: defines the total number of files that a device contains.
2: shows the currently playing file number.
3: shows all pictures in thumbnail mode.

Settings: This option enables you to define Slide Show Effects (None, Horizontal Scroll, Fade and Shutter) and Slide Show Delay (5 Seconds, 2 Seconds, 1 Second, No Delay, 10 Seconds, 15 Seconds and 30 Seconds). After setting, press **▼** to highlight **Ok** and then press **OK** to confirm.

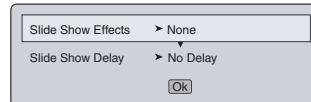

Main Menu: Returns to the main menu.

Previous Folder: This item only appears if your optical disc, USB device or SD card contains several different picture folders.

Start Slide Show: This option enables you to view picture (files) one after another automatically.

Browse Music: Goes back to Music folder.

4 Press **▼ / ▲** to select the desired photo, and then press **OK** to start playing.

↺: Press **REPEAT** repeatedly to select the desired repeat mode.

5 To play music files while viewing photos, follow the following steps:

1. Press **RETURN**.
2. Use **▼ / ▲** to select **Browse Music**, then press **OK**.
3. Select the desired track and press **OK** to start playing.

6 To stop playing and return to the main menu, follow one of the steps described below:

- Press **STOP**.
- Press **RETURN**.
- Press **◀**, then use **▼ / ▲** to highlight **Main Menu** and then press **OK** to confirm.

Using an SD Card

This unit supports the use of a Secure Digital (SD) card (not included).

CAUTION:

Before inserting the SD card, please read carefully the relevant information on "Playable Discs and Files" on page 14.

Inserting an SD card

- 1** Inserting an SD card fully into the slot on the front of Blu-ray Disc™ player until it clicks as illustrated.

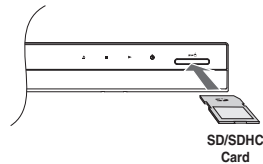

- 2** In Home Menu, press \blacktriangledown / \blacktriangle to select Media, and then press \blacktriangleright .

If no USB device or optical disc is inserted, the system will only show SD device.

- 3** Press \blacktriangledown / \blacktriangle to select a desired source, then press \blacktriangleright to highlight an option, and press OK.

For detailed operations, please follow the instructions in "Playing files on a data disc" on page 22.

■ Removing the SD card

In stop mode, gently push the SD card into the slot and then pull it out slowly.

Notes:

- If you cannot easily insert the memory card, you may have inserted it incorrectly. Try to turnover the card and then insert again. Do not force the memory card into the memory card slot.
- Do not remove the SD card during playback.

PLAYBACK

Using a USB Device

You can play MP3, WMA or JPEG files that have been stored on USB devices on the Blu-ray Disc™ player.

Operating a USB device

- 1** Inserting a USB device into the USB slot on the back of Blu-ray Disc™ player until it clicks.

- 2** In Home Menu, press \blacktriangledown / \blacktriangle to select Media, and then press \blacktriangleright .

If no SD card or optical disc is inserted, the system will only show USB device.

- 3** Press \blacktriangledown / \blacktriangle to select a desired source, then press \blacktriangleright to highlight an option, and press OK.

For detailed operations, please follow the instructions in "Playing files on a data disc" on page 22.

■ Removing the USB device

In stop mode, gently pull the USB device out slowly.

Notes:

- If you cannot easily insert the USB device, you may have inserted it incorrectly. Try to turnover the device and then insert again.
- Do not remove the USB device during playback.

Using Media Player function

Operating Media Player function

1 Set Media Player to "ON".

For detailed operations, please refer to the "Media Player" section in "System Setting" on page 30.

2 In Home Menu, press ▼ / ▲ to select Media, and then press ►.

If Media Player is set to "OFF", Media Player will not function.

3 Press ▼ / ▲ to select a desired source, then press ► to highlight an option, and press OK.

Notes:

- Make sure your player is properly connected to the network before using Media Player. Furthermore, you need other Media Player servers in the network to see and/or hear contents.
- Do not remove the LAN connector during playback.

Customizing the Function Settings

You can change the default settings to customize performance to your preference.

General Operations

1. Press **▼ / ▲** to select **Settings** in home menu while in full stop mode, the Settings menu appears.
2. Press **►** button, then use **▲ / ▼** button to select the setting options.
3. Press **OK** button.
4. Press **◀** or **RETURN** button to return to the previous menu.

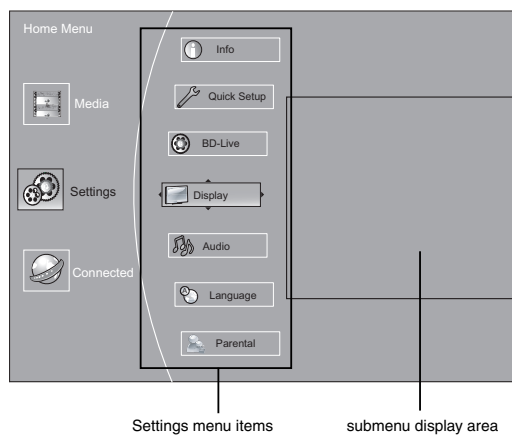

Info Menu

This menu displays the following information:

- **Software Version**
- **Software Date**
- **Netflix ESN**

1. In the main menu of **Settings**, press **►** button, then use **▲ / ▼** button to select **Info** to display the version information on software and hardware.
2. Press **◀** or **RETURN** to go to the previous menu.

3. Follow the on-screen instructions to customize the following settings to your preference:

- **OSD Language Settings**
- **Resolution**
- **TV Aspect**
- **Wireless**
- **Optical Disc Auto Play**
- **Screen Saver Duration**

4. After setting, press **OK** to confirm and exit the setup.

Note: If it is the first time for the player to start up or users restore all settings to factory defaults, the system will prompt you to perform Quick Setup. Repeat the steps described as above to complete the setup.

Performing Quick-Setup

1. In the main menu of **Settings**, press **►** button, then use **▲ / ▼** button to select **Quick Setup**, and then press **OK** to confirm.
2. Press **OK** to perform Quick Setup.
To exit the setup menu:
 - Use **▼** button to highlight "No thanks. I'll go through the full setup menu later", and then press **OK**.
 - Or press **◀** button directly.

Customizing the Function Settings

Using BD-Live™ Features

Some (but not all) Blu-ray™ discs contain additional features that are made available to players that are connected to the internet, and have additional memory added. These additional features may include things like:

- the ability to download new movie trailers
- additional 'commentary' by actors and directors
- multiperson game play and chat

In order to access BD-Live functions, the player must be properly configured for BD-Live internet access, and it must be equipped with additional memory.

1. In the main menu of **Settings**, press ► button, then use ▲ / ▼ button to select **BD-Live**, then press **OK**.
2. Press ▲ / ▼ to select an option, and then press **OK**.
3. Use ▲ / ▼ to select the desired setting, and then press **OK** to confirm.
4. Press ◀ to go to the previous menu.

BD-Live Internet Access:

- **Limit Access** — Allows Internet access with valid "BD-Live" network access approval.
- **Always Allow Access** — Always allows BD-Live Internet access.
- **Prohibit Access** — Never allows BD-Live Internet access.

In order to set the player up for BD-Live Internet Access, perform the following steps:

1. In the main menu of **Settings**, press ► button, then use ▲ / ▼ to select **BD-Live**, then press **OK**.
2. Press ▲ / ▼ to select "**BD-Live Internet Access**", and then press **OK**.
3. Use ▲ / ▼ to select the desired setting, and then press **OK** to confirm.
4. Make sure that "**Limit Access**" or "**Always Allow Access**" is checked.
5. Once the USB device or SD card has been inserted, if there is not at least 100Mbyte of free space on the device, you should choose "**Erase Blu-ray Storage**" from the BD-Live setup menu.
6. Press ◀ to return to the main menu of **Settings**, then use ▲ / ▼ to highlight **Network**, and then press **OK**. (For details, please refer to "Network Connection Setting" on Page 31.)

Notes:

- Depending on your connection environment, it may take time to connect to the Internet or the Internet may not be connected.
- When BD-Live function are used and the unit is connected to the Internet, you may be charged for this communication.
- Do not remove the USB device or SD card when using the BD-Live function.

BD-Live Storage:

This option is used to tell the Blu-ray Disc™ player whether or not to use an inserted SD card or USB device to store BD-Live content (movie trailers, additional scenes, etc.).

In order to add BD-Live memory for BD-Live Internet Access, insert an USB device or SD card (1GB is recommended) into the USB slot or SD card slot on the player.

Erase Blu-ray Storage:

If you choose **OK** to erase Blu-ray storage, all bookmarks and BD-Live content saved in memory are deleted.

Customizing the Function Settings

Display Setting

1. In the main menu of **Settings**, press ► button to select **Display**, and then press **OK** to confirm.
2. Press ▲ / ▼ to select an option, and then press **OK**.
3. Use ▲ / ▼ to select the desired option, and then press **OK** to confirm your selection.
4. Press ◀ to go to the previous menu.

HDMI Status:

This option displays the HDMI status. If an HDMI TV is connected, **Connected** appears. If an HDMI TV is not connected, **Disconnected** appears.

HDMI Preferred Format:

This option shows the best HDMI format for the connected TV. If HDMI is not pulled out, a composite image is not output.

Resolution:

You can define the video output resolution in this option. In case that the menu of "Resolution" setting disappears, make composite video (yellow) connection to restore it, then select the resolution which is compatible with the connected TV.

Notes:

- Selecting a resolution the TV does not support could result in an unstable picture or loss of the picture. See the documentation that came with the TV to find the resolutions the TV supports.
- Only the HDMI output on your player supports 1080p video output at any frame rate. If the TV is connected to the component output, the video output is limited to 1080i or lower.

TV Type	Resolution
If your TV is a high-definition TV(HDTV) connected to the HDMI jack on your player and you want your player to set the output resolution based on information exchanged between the TV and your player over the HDMI cable.	HDMI Auto
If the TV is a high-definition TV (HDTV) capable of 1080p (any frame rate) connected to the HDMI jack on your player	1080p (HDMI)
If your TV is a high-definition TV (HDTV) capable of 1080i only	1080i
If your TV is a high-definition TV (HDTV) capable of 720p only	720p
If your TV is an enhanced-definition TV (EDTV)	480p
If your TV is a standard-definition NTSC TV (American or Asian SD TV)	480i

TV Aspect:

16:9 wide, 16:9 Pillarbox, 4:3 Pan and Scan and 4:3 Letter Box are available for your choice.

Film Mode:

Movies are recorded on film at a rate of 24 pictures (frames) per second. Many of the movies on Blu-ray discs are placed on the discs at this frame rate. If your TV supports 24 frames per second, but you would prefer viewing the video at a higher frame rate, you should turn off Film Mode. **Off** selects a 60 frames/second output format.

Deep Color:

This option decides whether to turn off the Deep Color (color depth) setting for video signals output from the HDMI OUT jack.

Connecting the player and a TV that supports Deep Color allows more accurate color reproduction than when connecting it to a TV that does not support Deep Color. It is recommended to set this option **Off** if the picture is unstable or colors appear unnatural.

Bluray 3D Mode:

Select whether to play a Blu-ray Disc with 3D contents in 3D Mode.

Automatic: The 3D Blu-ray disc is played in 3D mode if your product detects a TV which supports it. It is played in 2D mode if your product detects a TV which can not support it.

Forced 2D: The 3D Blu-ray disc is played in 2D mode at all times. Select this option to view a picture without 3D effect or when a TV cannot support 3D Blu-ray discs.

Notes:

- If you or any viewer experiences the following symptoms or any other discomfort from viewing 3D video images, stop viewing and contact your health care provider:
Convulsions, Eye or muscle twitching, Loss of awareness, Altered vision, Involuntary movements, Disorientation, Eye Strain, Nausea/Vomiting, Dizziness, Headaches or Fatigue
- Carefully read instructions provided with your display and/or 3D glasses before 3D viewing.
- If you want to enjoy a 3D content, connect a 3D device (3D compliant AV receiver or TV) to the product and wear a 3D glass before playing the 3D content.
- While watching the 3D video, all analogue component and composite signals will be blocked automatically.
- All 3D signals are output only using the HDMI cable and through the HDMI OUT port.
- As the video resolution in 3D play mode is fixed according to the resolution of the original 3D video, you can not change the resolution to your preference.
- You must use a high-speed HDMI cable for a proper output of the 3D signal.
- You can not use this product for switching a 2D content to 3D.

Customizing the Function Settings

Audio Setting

The settings in the Audio menu will configure the Blu-ray Disc™ player's digital audio outputs (HDMI or Coaxial).

1. In the main menu of **Settings**, press **▶** button, then use **▲/▼** button to select **Audio**, then press **OK** button.
2. Press **▲/▼** to select an option, and then press **OK**.
3. Use **▲/▼** to select your preferred audio items, and then press **OK** to confirm your selection.
4. Press **◀** to go to the previous menu.

PCM Downsampling:

If you don't have a surround sound receiver connected to the Blu-ray Disc™ player, you should **leave the PCM downsampling to 48 kHz**, and proceed to the next setup menu item. This is true regardless of whether the audio is connected to the TV with HDMI or the analog stereo outputs.

If you have a surround sound receiver connected to the Blu-ray Disc™ player, and you have connected to the surround receiver via the Blu-ray Disc™ player's **analog multichannel audio outputs**, this setting has no effect on the audio going to the analog outputs of the player. Leave the PCM downsampling to 48 kHz, and proceed to the next setup menu item.

If you have a surround sound receiver connected to the Blu-ray Disc™ player, and you have connected to the surround receiver via the Blu-ray Disc™ player's **HDMI output**, this setting has no effect on the audio going to the HDMI output of the player. **Leave the PCM downsampling to 48 kHz**, and proceed to the next setup menu item.

If you have a surround sound receiver connected to the Blu-ray Disc™ player via **optical cable**, set this menu item to the maximum PCM sampling rate that your surround receiver can accept (48 kHz or 96 kHz). **If in doubt, consult your surround receiver's manual or set to 48 kHz.**

NOTE: Incorrectly setting the digital audio output's PCM sampling rate too high may result in unpredictable audio playback.

Digital Output:

- **PCM Stereo** — Sets the output to PCM Stereo if you have not an audio receiver connected to your Blu-ray Disc™ player or the audio receiver connected to Blu-ray Disc™ player is not a 5.1/7.1 channel receiver.
- **Bitstream HD** — Lets your player send Dolby TrueHD or DTS-HD MA bitstreams over HDMI (if your player is connected to a compatible HDMI audio receiver). If your player is not connected to a compatible HDMI receiver (for example, your player is connected directly to the TV or your player is connected to an audio receiver using an optical cable), a compatible audio signal is automatically sent over the HDMI and optical connections. With this setting, Blu-ray audio is limited to the soundtrack for the main movie (no PIP audio).
- **Bitstream Legacy** — Sends a DTS or Dolby Digital bitstream from the disc over the HDMI and optical connections. Blu-ray audio is limited to the soundtrack for the main movie (no PIP audio).
- **Bitstream Mixed** — Sends a mixed (PIP audio and movie audio) DTS audio stream over the HDMI and optical connections. This mode is primarily intended for use when

you want to hear both PIP audio and the movie audio.

- **PCM 5.1** — Sends a PCM audio signal of up to 5.1 channels over the HDMI connection and up to 2 channels over the optical connection.
- **PCM 7.1** — Sends a PCM audio signal of up to 7.1 channels over the HDMI connection and up to 2 channels over the optical connection.

Dynamic Range Control:

Dynamic Range Control means that you can allow the Blu-ray Disc™ player to make the loud parts of a movie's audio track quieter than they would be in the theatre, without making the dialog of the actors any quieter.

This would be useful, for instance, when you want to watch a movie in the evening when others might be sleeping.

NOTES: This setup menu item **has no effect** unless:

- The device playing the disc's audio (TV or surround audio receiver) is connected to the Blu-ray Disc™ player's analog audio outputs; OR
- you have selected "Bitstream Mixed" in the Blu-ray Disc™ player's audio setup menu.

When **Dynamic Range Control** is set to **Off**, movie soundtracks are played with the standard dynamic range.

When movie soundtracks are played at low volume or from smaller speakers, you can set **Dynamic Range Control** to **On**. Your player applies appropriate compression to make low-level content more intelligible and prevent dramatic passages from getting too loud.

Selecting the "**Auto**" option turns on the Dynamic Range Control for all Blu-ray Disc™ movie soundtracks except Dolby TruHD. If you have selected a TruHD track on the Blu-ray™ disc, the "auto" selection tells the Blu-ray Disc™ player to only turn on dynamic range control if information embedded in the TruHD sound track tells it to do so.

Stereo Downmix:

Select whether to downmix the multi-channel audio into fewer channels.

- **Auto** — Downmixes the multi-channel audio into the specific stereo that the connected equipment supports.
- **Stereo (LoRo)** — Downmixes the multi-channel audio into two channel stereo. Choose when the Blu-ray Disc™ player is connected to the equipment that does not support virtual surround function such as Dolby Pro Logic.
- **Surround Encoded (LtRt)** — Downmixes the multi-channel audio into surround compatible stereo. Choose when the Blu-ray Disc™ player is connected to the equipment that supports virtual surround function such as Dolby Pro Logic.

Customizing the Function Settings

Language Setting

1. In the main menu of **Settings**, press ▲ / ▼ to select **Language**, and then press **OK**.
2. Press ▲ / ▼ to select **OSD, Menu, Audio** or **Subtitle**, and then press **OK**.
3. Use ▲ / ▼ to select your preferred language, and then press **OK** to confirm your selection.
4. Press ◀ to go to the previous menu.

OSD:

This option enables you to select the on-screen menu language.

Menu:

This option lets you to select the disc menu language.

Notes:

- Not all languages are available on all discs.
- Most discs only have one menu language.

Audio:

You can choose the audio language from this option to your preference.

Notes:

- Not all languages are available on all discs.
- Some discs do not let you select the audio language using your player's menu. Instead, you have to select the audio language from the disc setup menu (the menu that appears after you insert the disc).

Subtitle:

You can customize your preferred subtitle language in this option.

Notes:

- Not all languages are available on all discs.
- Some discs do not let you select the subtitle language using your player's menu. Instead, you have to select the subtitle language from the disc setup menu (the menu that appears after you insert the disc).
- You can also select the subtitle language from the subtitle menu in the on-screen menu.

Parental Control

1. In the main menu of **Settings**, press ►, then press ▲ / ▼ to select **Parental**, and then press **OK**.
2. Press ▲ / ▼ to select an option, and then press **OK**.
3. Use ▲ / ▼ to select the desired option, and then press **OK** to confirm your selection.
4. Press ◀ to go to the previous menu.

Note: If **Parental Control** was previously turned **On**, you will be prompted to enter the parental control password before being allowed to change these settings. (See "Turning parental control on or off" for details.)

Selecting the parental country

Parental Country is fixed in USA.

Turning parental control on or off

1. In the main menu of **Settings**, press ►, then press ▲ / ▼ to select **Parental**, and then press **OK**.
2. Press ▲ / ▼ to select **Parental Control**, then press **OK**.
3. Press ▲ / ▼ to select **On** or **Off**, then press **OK**.
4. Press ◀ to go to the previous menu.

Setting the parental control level

1. In the main menu of **Settings**, press ►, then press ▲ / ▼ to select **Parental**, and then press **OK**.
2. Press ▲ / ▼ to select **Parental Level**, then press **OK**.
3. Press ▲ / ▼ to select the rating level you want to block, then press **OK**. The rating and all higher ratings will be blocked. You can select:
 - 1 [Kid Safe] — Suitable for all children.
 - 2 [G] — General audiences.
 - 3 [PG] — Parental guidance suggested.
 - 4 [PG-13] — Not suitable for anyone under 13.
 - 5 [PG-R] — Parental guidance recommended.
 - 6 [R] — Not suitable for anyone under 17 unless supervised by a parent or adult guardian.
 - 7 [NC-17] — Not suitable for anyone under 17.
 - 8 [Adult] — All Blu-ray discs and DVDs can be played.
4. Press ◀ to go to the previous menu.

Setting the parental control password

1. In the main menu of **Settings**, press ►, then press ▲ / ▼ to select **Parental**, and then press **OK**.
2. Press ▲ / ▼ to select **Parental Password**, then press **OK**.
3. Enter a 4-digit number for the parental password, then use ▼ to highlight **Ok**, and then press **OK** to confirm.
If you forget your password, reset your player to the factory defaults. For more information, see "Restore factory defaults" on page 30.
4. Press ◀ to go to the previous menu.

Customizing the Function Settings

System Setting

1. In the main menu of **Settings**, press ► button, then use ▲ / ▼ button to select **System**, then press **OK**.
2. Press ▲ / ▼ to select an option, and then press **OK**.
3. Use ▲ / ▼ to select the desired setting, and then press **OK** to confirm.
4. Press ◀ to go to the previous menu.

Optical Disc Auto Play:

If **Enable** is selected, it will load data and play back automatically when you insert a Blu-ray disc. When **Disable** is selected and if you insert a Blu-ray disc, the disc you can select will be displayed on the Settings menu.

Media Player:

Media Player technology enables you to create an interoperability network with other devices for resource sharing based on a network.

Screen Saver Duration:

This Blu-ray Disc™ player has a screen saver feature that turns the screen black when your player is inactive. You can set the interval time you want your player to wait before activating the screen saver.

Note: The unit shuts down automatically in about thirty minutes if it remains idle and no activities are made.

CEC Support:

This option is used to allow the TV remote control to control certain functions of the Blu-ray Disc™ player; and for the Blu-ray Disc™ player to control certain functions of the TV.

On: Allow mutual control of devices through HDMI.

Off: Do not allow CEC control.

Notes:

- Not all TVs are compatible with your Blu-ray Disc™ player.
- The default setting is **Off**. Select **On** if CEC control is necessary.

Update Via Network:

This option displays the required storage space if the Blu-ray Disc™ player is connected to internet for upgrade.

For detailed upgrade operation, please refer to "**Upgrading Your Player's Firmware**" on page 33.

Restore factory defaults:

Choose one of the following options, then press **OK** to pop up a dialog box, choose **Ok** in the box, and then press **OK** to confirm.

To apply the deactivation, please plug off the player after operating deactivation.

Actions	Response
Restore factory settings and deactivate all connected applications	All settings (including Parental Password) will be restored to the factory defaults and all connected applications will be deactivated.
Restore factory settings	Restores all settings (including Parental Password) to the factory defaults.
Deactivate all connected applications	Deactivates all connected applications
Deactivate Netflix	Deactivates the connected Netflix application
Deactivate YouTube	Deactivates the connected YouTube application
Deactivate Pandora	Deactivates the connected Pandora application
Deactivate Vudu	Deactivates the connected VUDU application
Deactivate Blockbuster	Deactivates the connected Blockbuster application
Deactivate CinemaNow	Deactivates the connected CinemaNow application

Customizing the Function Settings

Network Connection Setting

- Press **▼ / ▲** to select **Network** in stop mode, then press **►** button.
- If no Ethernet cable is connected to the ETHERNET jack on the back of your player, a screen similar to the following appears:
 - Manual** — Lets you manually configure network settings, such as IP address, subnet mask, and gateway settings.
 - Dynamic** — Uses DHCP to automatically obtain an IP address.
- Press **▼ / ▲ / ► / ◀** to highlight **Network Test**, and press **OK** to test your network connection.
- Press **◀** or **RETURN** to go to the previous menu.

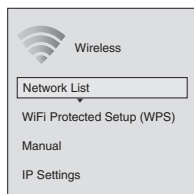

For detailed operations, refer to the "Configuring a wireless Internet connection".

- If a wired connection is made to your player, a screen similar to the following appears:

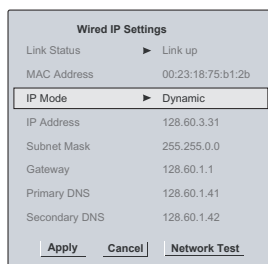

Refer to the "Configuring a wired Internet connection" for details.

Notes:

- "Wireless" and "Wired" are optional and do not appear at the same time. Normally, "Wireless" is shown without wired connection. While using a wired Internet connection, "Wireless" is disabled and "Wired" is activated.

Configuring a wired Internet connection

- Press **▼ / ▲** to select **Network** in stop mode, then press **►** button to enter the following screen:

If the network connection is active, **Link Up** appears next to Link Status. If the network connection is not active, **Link Down** displays next to Link Status.
- Press **▼ / ▲** to select **IP Mode**, then press **OK**.
- Press **▼ / ▲** to select an IP mode. You can select:

Configuring a wireless Internet connection

This section describes how to configure the Blu-ray Disc™ player for accessing the internet via a WiFi connection. The procedure for connecting to a wireless network depends on various network parameters. Read the following configuration methods to determine which instructions to use to connect to your network.

I. Connection to the wireless Network which you select

- Connecting to an Unencrypted Wireless Network
- Connecting to an Encrypted Wireless Network

II. Connection to the wireless Network using Wi-Fi Protected Setup (WPS)

- Connecting to a Wireless Network Using WPS Pushbutton
- Connecting to a Wireless Network Using WPS PIN

III. Connection to the wireless Network using Manual IP Configuration

Description of the Wireless Network List Display

Choosing "Network List" in the wireless network setup menu will cause a list of available WiFi networks to appear, as shown below:



Customizing the Function Settings

The symbols that might appear next to each listed wireless network in the network list are as follows:

Category	Icon	Definition
Connected		When the Blu-ray Disc™ player is turned on, it will connect to the wireless network displaying this symbol. Typically, this is the last wireless network connected before powering down.
	*	Indicates that the Blu-ray Disc™ player is currently connected to this network.
Saved		The wireless network properties have been saved in the Blu-ray Disc™ player's memory.
		The wireless network data is not encrypted.
		The wireless network data is encrypted; a 'security key' must be entered so that the Blu-ray Disc™ player can share data over the network.
Wireless Security		The wireless network data is encrypted; the encryption scheme is not supported by the Blu-ray Disc™ player.
		The wireless network supports 802.11a
		The wireless network supports 802.11b
		The wireless network supports 802.11g
		The wireless network supports 802.11n
Wireless Protocol		The wireless router supports the WPS standard.
		Strong Signal
		Good Signal
		Medium Signal
		Weak Signal
Signal Strength		No Signal

I. Connection to the wireless Network which you select

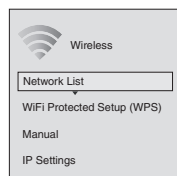

- In the "Wireless" menu, press ▼ / ▲ to select **Network List**, then press **OK**. A list of existing wireless networks near the Blu-ray Disc™ player will appear (It may take several seconds for this list to be created). For example:

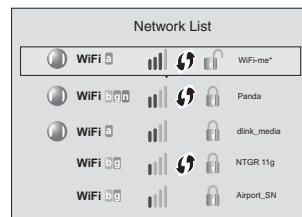

- Press ▼ / ▲ to select the desired wireless network, and press **OK** to confirm.

- If the Blu-ray Disc™ player is connected to an **Unencrypted Wireless Network**, a menu similar to the following will appear:

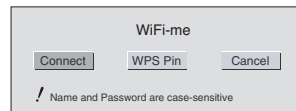

- Press ◀ / ▶ to highlight **Connect**, and press **OK**. If the wireless network is functioning, icon and a message "Connection to XXX...Success" will appear on the TV.
- Press **OK** to close the message. The Blu-ray Disc™ player is now connected to the network. From now on, when you turn on the player, it will automatically connect to the network; there is no need to repeat these steps again.

Note: If you do not see this message, the Blu-ray Disc™ player was not able to connect to the network.

- If the Blu-ray Disc™ player is connected to an **Encrypted Wireless Network**, a menu similar to the following will appear:



- Press **OK(ENTER)** to activate the on-screen keyboard. Carefully enter the network password by using the ▲ / ▼ / ◀ / ▶ to highlight the desired letter on the keyboard, and then pressing **OK**. (If you make a mistake, use the backspace key to erase the mistake.)
- Use ▲ / ▼ / ◀ / ▶ to highlight **Done** on the upper-right corner of the keyboard, and press **OK** to remove the keyboard from the screen.

Customizing the Function Settings

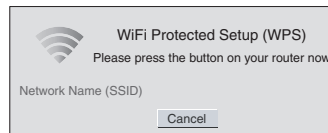
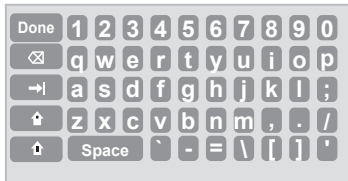

- Use **▼** to highlight **Connect**, and press **OK**. If the wireless network is functioning,  icon and a message "Connection to XXX...Success" will appear on the TV.
- Press **OK** to close the message. The Blu-ray Disc™ player is now connected to the network. From now on, when you turn on the player, it will automatically connect to the network; there is no need to repeat these steps again.

Notes:

- If you do not see this message, the Blu-ray Disc™ player was not able to connect to the network.
- If the wireless network is **encrypted using an unsupported encryption** (it appears in the network list with an icon), you cannot connect to the network. You must change the router's encryption type before proceeding.

II. Connection to the wireless Network using Wi-Fi protected Setup(WPS)

- Press **▼ / ▲** to select **Network** in stop mode, then press **►** button to enter the following screen:

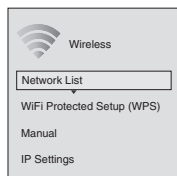

a. If the Blu-ray Disc™ player is connected to a Wireless Network Using WPS Pushbutton:

- Press **▼ / ▲** to select **WiFi Protected Setup (WPS)**, then press **OK**.

- Press the WPS button on the top of your router.
- Once you see "Success" on the button at the bottom of the screen, the Blu-ray Disc™ player is connected to the router.

Note: If you do not see this message, the Blu-ray Disc™ player was not able to connect to the network. Repeat steps 1-4 again.

b. If the Blu-ray Disc™ player is connected to a Wireless Network Using WPS PIN:

- Press **▼ / ▲** to select **Network List**, then press **OK**. A list of existing wireless networks near the Blu-ray Disc™ player will appear (It may take several seconds for this list to be created).
- Press **▼ / ▲** to select the desired wireless network, and press **OK** to confirm.
- Press **◀ / ▶** to highlight **WPS PIN**, and press **OK**. The following screen will appear:

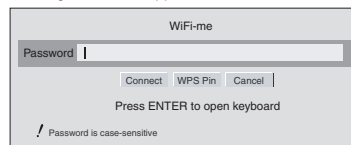

- Press **◀ / ▶** to highlight connection method you desire, and press **OK**.
- Follow the on-screen message to continue operating the connection.

III. Connection to the wireless Network using Manual IP Configuration

- In the "Wireless" menu, press **▼ / ▲** to select **Manual**, then press **OK**.
- Follow the on-screen message to continue operating the connection.

Upgrading Your Player's Firmware

The company that produced this player may occasionally offer upgrades to the player's software.

Automatic upgrades over the Internet

- Make sure that your player is successfully connected to the Internet. If new software is available, you will see a message prompting you whether to update your firmware.
- If you want to update the player's firmware, use **► / ◀** to highlight "OK", and then press **OK**. The software will begin downloading, and a status bar will appear on the TV screen.
- Once the update is complete, a message will appear indicating that the player will turn itself off and on.

Using the Connected Applications

Some players are equipped with the capability to watch movies over the internet.

Watching Movies with BLOCKBUSTER®

This Blu-ray Disc™ Player enables you to use the following services provided by Blockbuster.

1. In Home Menu, press **▲** / **▼** to select **Connected**.
2. Press **►**, then press **▲** / **▼** to highlight **Blockbuster**, and then press **OK** to enter Blockbuster main menu.
 - **Movies** : Display movies.
 - **TV Shows** : Display TV Shows.
 - **Find** : Search for a desired movie or TV show by entering it manually.
 - **My Library** : Display a title that you bought or rented.
 - **My Favorites** : Display a title that has been added to My Favorites.
 - **Configure** : Activate or deactivate the Blu-ray Disc™ Player.
 - **Help** : Get customer service contact information and check the current software version.
3. If you don't have a Blockbuster account yet, visit www.blockbuster.com to create your account.
4. Use **▼** / **▲** / **►** / **◄** to select the **Configure**, then press **OK**.
5. Use the number buttons on the remote control to enter the activation code that is created by the web site, then use **▼** to highlight **Activate**, and press **OK** to confirm.

When the Blu-ray Disc™ Player is activated, you will move to the Home page.
6. Press **►** / **◄** to select the **Movies** or **TV Shows**, then press **OK**.
7. Press **▼** / **▲** / **►** / **◄** to select the desired title, then press **OK**.
8. Press **►** / **◄** to select the **Rent** or **Buy**, then press **OK**.
9. Press **►** / **◄** to select the **Submit Order**, then press **OK**. If you want to play any of the titles that your bought, simply click **Play Now**.
10. Press **◄** to go to the previous menu.

Watching Movies with CinemaNow®

This Blu-ray Disc™ Player enables you to use the following services provided by CinemaNow.

1. In Home Menu, press **▲** / **▼** to select **Connected**.
2. Press **►**, then press **▲** / **▼** to highlight **CinemaNow**, and then press **OK** to enter CinemaNow main menu.
 - **Movies** : Display movies.
 - **TV Shows** : Display TV Shows.
 - **Search All** : Search for a desired movie or TV show by entering it manually.
 - **My Videos** : Display a title that you bought or rented.
 - **Wish List** : Display a title that has been added to Wish List.
 - **Settings** : Activate or deactivate the Blu-ray Disc™ Player.
 - **Help** : Get customer service contact information and check the current software version.
3. If you don't have a CinemaNow account yet, visit www.cinemanow.com/bbactivate to create your account.
4. Use **▼** / **▲** / **►** / **◄** to select the **Settings**, then press **OK**.
5. Press the **Activate**.
6. Use the number buttons on the remote control to enter the activation code that is created by the web site, then use **▼** to highlight **Activate**, and press **OK** to confirm.

When the Blu-ray Disc™ Player is activated, you will move to the Home page.
7. Press **►** / **◄** to select the **Movies** or **TV Shows**, then press **OK**.
8. Press **▼** / **▲** / **►** / **◄** to select the desired title, then press **OK**.
9. Press **►** / **◄** to select the **Rent** or **Buy**, then press **OK**.
10. Press **►** / **◄** to select the **Submit Order**, then press **OK**. If you want to play any of the titles that your bought, simply click **Play Now**.
11. Press **◄** to go to the previous menu.

Using the Connected Applications

Watching Movies with Netflix®

To use Netflix service, connect this player to your network, and make the network settings if they are not finished yet.

1. Launching Netflix movie

In Home Menu, press ▲ / ▼ to select **Connected**, then use ►, and then press ▲ / ▼ to highlight **"Netflix"**, and then press **OK** to enter.

2. Creating Netflix account

If you are not a Netflix Member:

Select "no". Read the instructions displayed on the TV screen, and visit <http://www.netflix.com/toshiba> from your PC. Sign up to create your account, then select "I'm now a member".

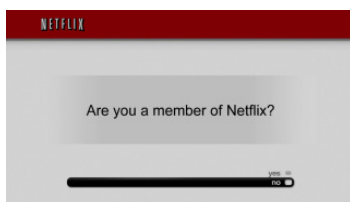

If you are a Netflix Member:
Select "Yes".

3. Activating Netflix player

To play streaming video via Netflix service, Netflix player needs to be activated. Read the instructions displayed on the TV screen, and visit <http://www.netflix.com/activate> on your PC. Sign in to your Netflix account, if necessary. Enter the activation code displayed on the TV screen.

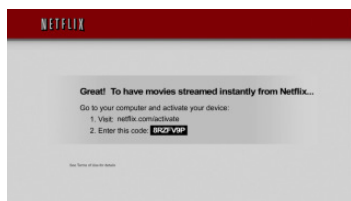

4. Preparing Instant Queue

To play streaming video via Netflix service, Netflix player needs to be activated. Read the instructions displayed on the TV screen, and visit <http://www.netflix.com/activate> on your PC. Sign in to your Netflix account, if necessary. Enter the activation code displayed on the TV screen.

Now you can view Netflix streaming video.

After having activated Netflix player and prepared Instant Queue, movies and TV episodes in your Instant Queue appear on the TV screen. Select your desired one using the remote control of the player. You can control Netflix streaming video with the following keys of the remote control of this player:

▶	To start playing movie. To pause playback while in PLAY mode.
■	To stop playing and return to a list of movie titles.
	To pause playing movie. To start playing while in PAUSE mode.
▶	To pause playing and open a list of scenes. Pressing further proceeds to the next scene.
◀	To pause playing and open a list of scenes. Pressing further proceeds to the previous scene.
▲	To stop playing and return to a list of movie titles.
▶▶	To pause playing and open a list of scenes. Fast forward play starts.
◀◀	To pause playing and open a list of scenes. Fast reverse play starts.
HOME MENU	To stop playing and return to Home Menu.
OK	To pause playing of Trick play screen while in PLAY mode. To start playing the movie in case of during Trick play screen.

Note: Resolution of video streamed from Netflix varies depending on communication speed or bitrate of each content, etc.

Using the Connected Applications

Listening to Music with Pandora®

Using an existing Pandora account

1. In Home Menu, press ▲ / ▼ to select **Connected**.
2. Press ►, then press ▲ / ▼ to highlight **Pandora**, and then press **OK** to confirm.
3. Select **"I have a Pandora account"** from the option list.
4. Sign in with your test account.

Creating a new account on the Blu-ray Disc™ player

1. In Home Menu, press ▲ / ▼ to select **Connected**.
2. Press ►, then press ▲ / ▼ to highlight **Pandora**, and then press **OK** to confirm.
3. Select **"I am new to Pandora"** from the option list.
4. You will be given an activation code. Use this activation code to generate a new account and link it to the Blu-ray Disc™ player using a PC.

Creating a new Pandora account on your PC

Go to <http://www.pandora.com/> to create a new account.

Watching Movies with VUDU™

Creating a VUDU account on your player

1. In Home Menu, press ▲ / ▼ to select **Connected**.
2. Press ►, then press ▲ / ▼ to highlight **Vudu**, and then press **OK** to confirm.
3. Follow the instructions to create an account, it will ask for an email address.
4. Enter YOUR email address using the keyboard that appears on the screen. VUDU will then display a message on the TV **"Sending you an email"**.

Creating a VUDU account on your PC

1. VUDU will send you an email with a hyper-link; click on the link.
2. In the Vudu page that comes up on your PC's browser after clicking the link, enter the e-mail and password of the owner of the account.
3. VUDU will then display a message **"Enabling your device to view movies. The email message on your TV screen will disappear when done"**.
4. On your TV, you can now navigate to a VUDU movie, and 'buy' or 'rent' it.

Watching Movies with YouTube®

1. In Home Menu, press ▲ / ▼ to select **Connected**.
2. Press ►, then press ▲ / ▼ to highlight **YouTube**, and then press **OK** to confirm.
3. Please enjoy any contents.

Troubleshooting & Maintenance

Troubleshooting

If the unit does not perform properly when operated as instructed in this manual, check the unit, consulting the following checklist.

Problem	Solution
No power	<ul style="list-style-type: none"> - Check if the AC cord is properly connected. - Unplug the AC cord once, and wait for 5-10 seconds and then plug it in again.
No sound or picture	<ul style="list-style-type: none"> - Check if the connected TV is turned on. - Check if the connections are made securely and correctly. - Check whether the connected TV or other device supports HDCP. (This unit will not output a video signal unless the other device supports HDCP.) - Check whether the output format of this unit (HDMI FORMAT) matches the supported input format of other connected device.
Distorted picture	<ul style="list-style-type: none"> - Sometimes a small amount of picture distortion may appear. This is not a malfunction. - Connect this unit directly to the TV. If the composite audio / video cables are connected to a VCR, pictures may be distorted due to the copyright protection system.
Completely distorted picture or black / white picture with Blu-ray Disc™ / DVD	<ul style="list-style-type: none"> - Make sure the disc is compatible with this unit.
No sound or distorted sound	<ul style="list-style-type: none"> - Adjust the volume. - Check if speakers are connected correctly. - Check the HDMI connections. - Check the settings in "Audio" menu.
Picture freezes momentarily during playback	<ul style="list-style-type: none"> - Check the disc for fingerprints / scratches and clean with a soft cloth wiping from center to edge. - Clean the disc.
Disc cannot be played back	<ul style="list-style-type: none"> - Clean the disc. - Ensure the disc label is facing up. - Check if the disc is defective by trying another disc. - Cancel the ratings control or change the control level. - Insert a correct disc that can be played back on this unit.
SD Memory Card cannot be read	<ul style="list-style-type: none"> - The format of the card does not match that accepted by this unit or the card is not compatible.
No return to start-up screen when disc is removed	<ul style="list-style-type: none"> - Reset this unit by turning it off, then on again.
The unit does not respond to the remote control	<ul style="list-style-type: none"> - Aim the remote control directly at infrared sensor window on the front panel. - Reduce the distance to infrared sensor window. - Replace the batteries in the remote control. - Re-insert the batteries with their polarities (+ / - signs) as indicated.
Buttons do not work or the unit stops responding	<ul style="list-style-type: none"> - To completely reset the unit, unplug the AC cord from the AC outlet for 5-10 seconds.
The unit does not respond to some operating commands during playback	<ul style="list-style-type: none"> - Operations may not be permitted by the disc. - Refer to the instructions of the disc.
The unit cannot read Blu-ray Disc™ / DVD / CD	<ul style="list-style-type: none"> - Dew condensation may form inside the unit. Do not use this unit for at least a few hours until its inside gets dry. - Wipe the dirt off the disc or replace the disc.
Angle does not switch	<ul style="list-style-type: none"> - The angle cannot be switched for Blu-ray Disc™ / DVD which do not contain multiple angles. - In some cases multiple angles are only recorded for specific scenes.
Playback does not start when the title is selected	<ul style="list-style-type: none"> - Check the settings in "Parental" menu.

OTHERS

Troubleshooting & Maintenance

Problem	Solution
The password for rating level has been forgotten	- If you forget your password, reset your player to the factory defaults and your forgotten password will be cleared. For more information, see " Restore factory defaults " on page 30.
Cannot connect to the network	- Check if the LAN cable connection is properly made. - Turn on the modem or broadband router. - Check if the broadband router and/or modem is correctly connected. - Check the "Network Connection Setting".
Cannot connect to the network while my PC is connected to the network	- Check the content of your Internet service contract to see if your Internet service provider prevents multiple terminals connecting at the same time.
Cannot use the BD-Live function	- Use an SD card with enough space.
The playback of BD-video or download of data does not perform properly	- Check if an SD Card is correctly inserted. Do not remove the card during playback as some BD-videos require an SD Card during playback.

Notes

- Some functions are not available in specific modes, but this is not a malfunction. Read the description in this manual for details on correct operations.
- Some functions are prohibited on some discs.

Maintenance

Servicing

- Please refer to relevant topics on "Troubleshooting & Maintenance" before returning the product.
- If this unit becomes inoperative, do not try to correct the problem by yourself. There are no user-serviceable parts inside. Turn off, unplug the power plug, and please call our helpline to locate an Authorized Service Center.

Cleaning the cabinet

- Never use a solvent, thinner, benzene or alcohol to clean the unit. Do not spray insecticide liquid near the unit. Such chemicals may discolor the surface or damage the unit.

Cleaning discs

- When a disc becomes dirty, clean it with a cleaning cloth. Wipe the disc from the center to out. Do not wipe in a circular motion.
- Do not use solvents such as benzene, thinner, commercially available cleaners, detergent, abrasive cleaning agents or antistatic spray intended for analog records.

Cleaning the disc lens

- If this unit still does not perform properly although you refer to the relevant sections and to "Troubleshooting" in this manual, the laser optical pickup unit may be dirty. Consult your dealer or an Authorized Service Center for inspection and cleaning of the laser optical pickup unit.

Disc handling

- Handle the discs so that fingerprints and dust do not adhere to the surfaces of the discs.
- Always store the disc in its protective case when it is not used.
- Note that discs with special shapes (heart-shaped discs, octagonal discs, etc.) cannot be played back on this unit. Do not attempt to playback such discs, as they may damage the unit.

IR signal check

- If the remote control is not working properly, you can use a digital camera (including a cellular phone with built-in camera) to see if it is sending out an infrared signal.

Glossary

Analog Audio

An electrical signal that directly represents sound. Compare this to digital audio which can be an electrical signal, but is an indirect representation of sound.

Aspect Ratio

The width of a TV screen relative to its height. Conventional TVs are 4:3 (in other words, the TV screen is almost square); widescreen models are 16:9 (the TV screen is almost twice as wide as it is high).

AVCHD

AVCHD is a new format for high definition video camcorders which can record and play high-resolution HD images.

BD-Java

With some Blu-ray Disc™ which support Java applications, you can enjoy the interactive functions such as games or interactive menus.

BD-Live™

BD-Live is a BD-video (BD-ROM version 2 Profile 2.0/Profile 1.1) which contains new functions (e.g. Internet connection), in addition to the BONUSVIEW function.

Blu-ray 3D™

Blu-ray 3D™ is a BD-video (BD-ROM version 3 Profile 5.0) which contains 3D view function, in addition to the BD-Live/BONUSVIEW function.

Blu-ray Disc™ (BD)

Blu-ray Disc™ is a next generation optical video disc which is capable of storing much more data than a conventional DVD is. The large capacity makes it possible to benefit from the features such as high-definition videos, multi-channel surround sounds, interactive menus and so on.

Chapter

Just as a book is split up into several chapters, a title on a BD-video or DVD-video is usually divided into chapters.

Component Video Output

Each signal of luminance (Y) and component (P_r/C_r , P_b/C_b) is independent to output so that you can experience picture Color as it is.

Also, due to compatibility with progressive video (525p/480p), you can experience higher-density picture than that in interlace (525i/480i).

Digital Audio

An indirect representation of sound by numbers. During recording, the sound is measured at discrete intervals (44,100 times a second for CD audio) by an analog-to-digital converter,

generating a stream of numbers. On playback, a digital-to-analog converter generates an analog signal based on these numbers.

DNS Server

A server which translates Internet domain names into IP addresses.

Dolby Digital®

The system to compress digital sound developed by Dolby Laboratories. It offers you sound of stereo (2ch) or multi-channel audio.

Dolby® Digital Plus

Dolby Digital Plus is the next generation digital audio compression technology developed as an extension to Dolby Digital. Blu-ray Disc supports 7.1 multi-channel surround sound output.

Dolby® TrueHD

Dolby TrueHD is a lossless coding technology developed for next generation optical discs. Blu-ray Disc supports 7.1 multi-channel surround sound output.

DTS®

DTS is a multi-channel surround sound system. By connecting to DTS decoder, you can enjoy movie dynamic and realistic sound like movie theater. DTS surround sound technologies were developed by DTS, Inc.

DTS-HD®

DTS-HD is a lossless coding technology developed as an extension of the original DTS Coherent Acoustics format. Blu-ray Disc supports 7.1 multi-channel surround sound output.

Gateway

IP Address of the electronic devices (such as router) which provide Internet access.

HDMI (High-Definition Multimedia Interface)

A digital interface between audio and video source. It can transmit component video, audio, and control signal with one cable connection.

Hub

A device used for connecting multiple device to the network.

IP Address

A set of numbers which are assigned to devices participating in a computer network.

Glossary

JPEG (Joint Photographic Experts Group)

JPEG is a method of compressing still picture files. You can copy JPEG files on BD-RE/-R, DVD-RW/-R, CD-RW/-R or SD Memory Card from a computer and play back the files in this unit.

LAN (Local Area Network)

A group of computer networks covering a small area like a company, school or home.

Local Storage

A storage area of sub contents for playing virtual packages on BD-video.

MP3 (MPEG audio layer 3)

MP3 is a method of compressing files. You can copy MP3 files on BD-RE/-R, DVD-RW/-R, CD-RW/-R or SD Memory Card from the computer and play back the files on this unit.

PCM (Pulse Code Modulation)

The most common system of encoding digital audio, found on CD and DAT. Excellent quality that requires a lot of data compared to formats such as Dolby Digital and MPEG audio. For compatibility with digital audio recorders (CD, MD and DAT) and AV amplifiers with digital inputs, this unit can convert Dolby Digital, DTS, and MPEG audio to PCM.

Proxy Server

Proxy server is a server which acts as an intermediary between a workstation user and the Internet to ensure security.

Region Code

Regions associate discs and players with particular areas of the world. This unit will only play back discs that have compatible region codes. You can find the region code of your unit by looking on the rear panel. Some discs are compatible with more than one region (or all regions).

Router

A networking device which distinguishes the IP address assigned to each device and routing and forwarding information in the computer network.

Sampling Frequency

The rate which sound is measured by a specified interval to turn into digital audio data. The numbers of sampling in one second defines as sampling frequency. The higher the rate, the better the sound quality.

Subnet Mask

A mask which is used to determine what subnet an IP address belongs to.

Title

A collection of chapters on BD-video or DVD-video.

Track

Audio CD use tracks to divide up the content of a disc. The BD-video or DVD-video equivalent is called a chapter. See also "Chapter".

Virtual Package

The function which copies data to other media (local storage) from the Internet and play the secondary video, secondary audio and the subtitle at the same time. The method of the playback varies depending on discs.

Windows Media™ Audio

Windows Media™ Audio is the audio compressing technology developed by Microsoft. You can copy Windows Media™ Audio files on BD-RE/-R, DVD-RW/-R, CD-RW/-R or SD Memory Card from a computer and play them back on this unit.

x.v.Color

"x.v.Color" is a promotion name given to the products that have the capability to realize a wide color space based on the xvYCC specifications and is a trademark of Sony Corporation.

Specifications

General	
Signal system	NTSC color
Power requirements	120 V AC, 60 Hz
Power consumption	15 W
Dimensions (width x height x depth)	430 x 43.5 x 193.5 mm
Weight	1.32 kg
Operating temperature	41°F (5°C) to 95°F (35°C)
Operating humidity	Less than 80 % (no condensation)

Terminals		
Rear	Video output RCA jack	1 Vp-p (75Ω)
	HDMI output HDMI jack x 1	Video: 480i, 480p, 720p, 1080i, 1080p, 1080p/24F / Audio
	Audio output (Analog) RCA jack x 2	L/R: 2 Vrms (output impedance: less than 1kΩ)
	Audio output (Coaxial digital) RCA jack x 1	0.5 Vp-p (75 Ω)
	USB terminal x 1	5V --- 500mA
	LAN terminal	100BASE-T

Note:

- The specifications and design of this product are subject to change without notice.

OTHERS

Limited United States Warranty for Digital Audio Video ("DAV") Product

Toshiba America Information Systems, Inc. ("TAIS") makes the following limited warranties to original consumers in the United States. THESE LIMITED WARRANTIES EXTEND TO THE ORIGINAL CONSUMER PURCHASER OR ANY PERSON RECEIVING THIS DAV PRODUCT AS A GIFT FROM THE ORIGINAL CONSUMER PURCHASER AND TO NO OTHER PURCHASER OR TRANSFEREE. DAV PRODUCTS PURCHASED IN THE U.S.A. OR PUERTO RICO AND USED ANYWHERE OUTSIDE OF THE U.S.A. OR PUERTO RICO, INCLUDING, WITHOUT LIMITATION, CANADA AND MEXICO, ARE NOT COVERED BY THESE WARRANTIES. DAV PRODUCTS PURCHASED ANYWHERE OUTSIDE OF THE U.S.A. OR PUERTO RICO, INCLUDING, WITHOUT LIMITATION, CANADA AND MEXICO, AND USED IN THE U.S.A., ARE NOT COVERED BY THESE WARRANTIES.

Limited 90-Day Warranty on Parts and Labor

TAIS WARRANTS THIS PRODUCT AND ITS PARTS AGAINST DEFECTS IN MATERIALS OR WORKMANSHIP FOR A PERIOD OF 90-DAYS FROM THE DATE OF ORIGINAL RETAIL PURCHASE. DURING THIS PERIOD, TAIS WILL, AT TAIS' SOLE DISCRETION, REPAIR OR REPLACE A DEFECTIVE PART/PRODUCT WITH A NEW OR REFURBISHED PART/PRODUCT WITHOUT CHARGE TO YOU FOR PARTS OR LABOR. ANY PART OR PRODUCT REPLACED UNDER THIS LIMITED WARRANTY BECOMES THE PROPERTY OF TAIS. IN SOME CASES, YOU MAY BE RESPONSIBLE FOR DELIVERING THE PRODUCT TO A SERVICE CENTER.

Rental Units – The limited warranty period begins on the date of the first rental or thirty (30) days after the date of shipment to the rental firm, whichever comes first.

Your Responsibility – Read the owner's manual thoroughly before installing or operating this Product. Complete and mail the enclosed product registration card (if provided) or register your Product online at www.support.toshiba.com. Registration of your Product will enable TAIS to contact you in the unlikely event a safety notification is required under the U.S. Consumer Product Safety Act. Failure to complete and return the product registration card does not diminish your warranty rights.

THE ABOVE WARRANTIES ARE SUBJECT TO THE FOLLOWING CONDITIONS:

(1) This Limited Warranty is extended only to the original purchaser and only covers product purchased as new. (2) A purchase receipt or other proof of the original purchase date is required for warranty service. (3) All warranty servicing of this Product must be performed by an Authorized TAIS Service Provider. (4) The warranties from TAIS are effective only if this Product is purchased and operated in the U.S.A. or Puerto Rico. (5) Removal and reinstallation of product that is mounted in such a manner as to impede normal service is not covered under these warranties. This includes wall mounts, custom cabinets and other installation methods that do not provide for direct and immediate access to the product for service purposes. Labor service charges for set installation, setup, adjustment of customer controls, and installation or repair of antenna, satellite or cable systems are not covered by this limited warranty. (6) Reception or other problems caused by inadequate antenna systems, misaligned satellite dishes, improperly installed cable drops or use with non-standard signals or sources are your responsibility and are not covered by this limited warranty. (7) This limited warranty is void if the product is used outside the range of the temperature (heat/cold) and/or moisture operating conditions as outlined in the product's specification listed in the Owner's manual, or if the product is exposed to excessive smoke, dust, or other airborne contaminants or environmental conditions. (8) Warranties extend only to defects in materials or workmanship as limited above, and do not extend to any Product or parts that have been lost or discarded by you or to damage to the Product or parts caused by fires, misuse, abuse, accident, Acts of God (such as lightning or fluctuations in electric power), improper installation, improper maintenance, or use in violation

of instructions furnished by TAIS; use or malfunction through simultaneous use of this Product and connected equipment; or to units that have been modified or had the serial number removed, altered, defaced, or rendered illegible. (9) Product purchased "AS-IS" or "With known faults, defects or problems" are not covered by this limited warranty. (10) Product previously owned or registered by a consumer and resold is not covered by this limited warranty. (11) Product that is refurbished and resold is not covered under this limited warranty.

How to Obtain Warranty Services

After following all of the operating instructions in the Owner's manual, review the section entitled "Concierge" located on our Customer Support Web site at www.support.toshiba.com. If you find that service is needed, follow the instructions provided on the web site or please contact TAIS' Consumer Solution Center toll free at 1-800-631-3811. You must present upon request your original bill of sale or other proof of purchase including the serial number for in warranty service.

ALL WARRANTIES IMPLIED BY THE LAW OF ANY STATE OF THE U.S.A., INCLUDING THE IMPLIED WARRANTIES OF MERCHANTABILITY AND FITNESS FOR A PARTICULAR PURPOSE, ARE EXPRESSLY LIMITED TO THE DURATION OF THE LIMITED WARRANTIES SET FORTH ABOVE. WITH THE EXCEPTION OF ANY WARRANTIES IMPLIED BY THE LAW OF ANY STATE OF THE U.S.A. AS HEREBY LIMITED, THE FOREGOING LIMITED WARRANTY IS EXCLUSIVE AND IN LIEU OF ALL OTHER WARRANTIES, GUARANTEES, AGREEMENTS, AND SIMILAR OBLIGATIONS OF TAIS WITH RESPECT TO THE REPAIR OR REPLACEMENT OF ANY PARTS. IN NO EVENT SHALL TAIS BE LIABLE FOR CONSEQUENTIAL OR INCIDENTAL DAMAGES (INCLUDING, BUT NOT LIMITED TO, LOST PROFITS, BUSINESS INTERRUPTION, OR MODIFICATION OR ERASURE OF RECORDED DATA CAUSED BY USE, MISUSE OR INABILITY TO USE THIS PRODUCT).

No person, agent, distributor, dealer or company is authorized to change, modify or extend the terms of these warranties in any manner whatsoever. The time within which an action must be commenced to enforce any obligation of TAIS arising under this limited warranty or under any statute, or law of the United States or any state thereof, is hereby limited to ninety (90) days from the date you discover or should have discovered, the defect. This limitation does not apply to implied warranties arising under the law of any state of the U.S.A.

THIS LIMITED WARRANTY GIVES YOU SPECIFIC LEGAL RIGHTS AND YOU MAY ALSO HAVE OTHER RIGHTS WHICH MAY VARY FROM STATE TO STATE IN THE U.S.A. SOME STATES OF THE U.S.A. DO NOT ALLOW LIMITATIONS ON THE DURATION OF AN IMPLIED WARRANTY, WHEN AN ACTION MAY BE BROUGHT, OR THE EXCLUSION OR LIMITATION OF INCIDENTAL OR CONSEQUENTIAL DAMAGES. THEREFORE, THE ABOVE PROVISIONS MAY NOT APPLY TO YOU UNDER SUCH CIRCUMSTANCES.

Disclaimer

I. HEALTH/SAFETY-RELATED

IMPORTANT SAFETY INFORMATION CONCERNING 3D VIEWING

- If you or any viewer experiences the following symptoms or any other discomfort from viewing 3D video images, stop viewing and contact your health care provider:

Convulsions	Eye or muscle twitching	Loss of awareness
Altered vision	Involuntary movements	Disorientation
Eye Strain	Nausea/Vomiting	Dizziness
Headaches	Fatigue	

- Some viewers may experience a seizure or blackout when exposed to certain flashing images or lights contained in certain 3D television pictures or video games. Anyone who has had a seizure, loss of awareness, or other symptom linked to an epileptic condition, or has a family history of epilepsy, should contact a health care provider before using the 3D function.
- If you feel eye fatigue or other discomfort from viewing 3D video images, stop viewing and take a rest until the condition is eliminated.
- Due to the possible impact on vision development, viewers of 3D video images should be age 6 or above. Children and teenagers may be more susceptible to health issues associated with viewing in 3D and should be closely supervised to avoid prolonged viewing without rest.
- Avoid use of the 3D function when under the influence of alcohol.
- Watching the screen while sitting too close for an extended period of time may cause eye strain. Consult your display manual to determine the ideal viewing distance.
- Viewing in 3D may cause dizziness and/or disorientation for some viewers. Therefore, to avoid injury do not place your player or display near open stairwells, balconies, or wires and do not sit near objects that could be broken if accidentally hit.
- Carefully read instructions provided with your display and/or 3D glasses before 3D viewing.

II. PERFORMANCE RELATED

- This product is designed to playback Blu-ray discs that comply with the 3D specifications of Blu-ray Disc Association. It is not compatible with other 3D specifications.
- 3D capable display, 3D eyewear and High Speed HDMI cable (all sold separately) required for playback and viewing 3D content.
- If you route your signal through an AV receiver or other video distribution device they must be 3D capable to support 3D viewing. Viewing HD content and up-converting DVD content may require an HDCP capable input on your display device.
- While up-converting DVD video content may result in a picture that appears to be near HD quality, results may vary depending on content, display and settings.
- 1080p capable display required for viewing content in 1080p.
- 1080p/24 fps encoded content and an HD display capable of accepting a 1080p/24Hz signal required for viewing 1080p/24 fps content.
- Performance of interactive and/or network features may vary due to disc design or content, and may also require an always-on broadband internet connection. Firmware update may be required for some interactive and/or network features. Some features may require additional bandwidth.
- BD-Live™ may require an SD or SDHC card or USB memory with available storage capacity of at least 1GB (sold separately).
- VUDU™, Netflix®, BLOCKBUSTER® on Demand, Pandora® and other internet services are available only in the United States, and are not provided by Toshiba, may change or be discontinued at any time and may be subject to internet service provider restrictions.
- Toshiba makes no warranties, representations, or assurances about the content, availability or functionality of third-party content or services. Use of third party internet services may require the creation of a separate account through a computer with internet access and may require payment of one-time and/or recurring charges. Not all services may be available on or compatible with these products.
- For Dolby® TrueHD and DTS-HD Master Audio | Essential™ playback, content encoded in Dolby® TrueHD and DTS-HD Master Audio | Essential™ format required. Supported file types: JPEG, MP3, WMA, and AVCHD. Some recordable media, cards or files may not be supported. Deep Color feature as specified in HDMI specification requires compatible Deep Color capable HD display and/or device. Use of HDMI-CEC requires an HDMI-CEC compatible display device. Depending on the specifications of your display device, some or all HDMI-CEC functions may not work even if your display device is HDMI-CEC compatible.
- Products do not play HD DVD discs.
- Some features subject to delayed availability.
- Because the Blu-ray format and 3D specifications use new technologies, certain disc, content, connection and other compatibility and/or performance issues are possible. If you experience such issues, please refer to www.support.toshiba.com for information on the availability of firmware updates that may resolve your problem, or contact Toshiba Customer Solutions.
- This product includes technology owned by Microsoft Corporation and can not be used or distributed without a license from Microsoft Licensing, GP.
- This product contains technology subject to certain intellectual property rights of Microsoft. Use or distribution of this technology outside of this product is prohibited without the appropriate license(s) from Microsoft.
- While every effort has been made at the time of publication to ensure the accuracy of the information provided herein, product specifications, configurations, system/component/options availability are all subject to change without notice.

OTHERS

END USER LICENSE AGREEMENT

This End User License Agreement ("EULA") is a legal agreement between you and Toshiba Corporation ("Toshiba") with regard to the copyrighted Software provided with this EULA. Use of any software and related documentation ("Software") provided with a Toshiba Blu-ray Disc™ Player, or made available by downloading or otherwise to you by Toshiba in whatever form or media, will constitute your acceptance of these terms, unless separate terms are provided by the software supplier or Toshiba in the documentation accompanying the Toshiba Blu-ray Disc™ Player or otherwise, in which case certain additional or different terms may apply. If you do not agree with the terms of this EULA, do not use, download, install or copy the Software. If you wish to return a complete Blu-ray Disc™ Player system (hardware and software), contact the retailer where you purchased the Blu-ray Disc™ Player, and comply with the retailer's standard return policies and procedures.

Article 1 Definition

The Software means all programs contained in the Toshiba Blu-ray Disc™ Player. The copyright of the Software belongs to Toshiba and/or its suppliers, including BSQUARE Corporation and/or its suppliers. The Software is protected by copyright laws, Universal Copyright Convention, and other laws and conventions related to intellectual property rights. The content of the Software and manual is subject to change by Toshiba without notice.

Article 2 License Grant and Use Conditions

Toshiba grants to you a personal, non-transferable and non-exclusive right to use the copy of the Software in accordance with this EULA. You may permanently transfer all of your rights under this EULA, provided you transfer complete Blu-ray Disc™ Player together with all of the Software, you retain no copies, and the recipient agrees to the terms of this EULA. If the Software is an upgrade version, any transfer must include all prior versions of the Software. For maintenance purposes, you may update the version of the Software only for the Blu-ray Disc™ Player that is owned by you.

Article 3 Prohibited Uses

Unless otherwise expressly provided in this EULA or the product manual accompanying the Toshiba Blu-ray Disc™ Player:

- 3.1. You may not copy the Software, in whole or in part, without express written permission by Toshiba and/or its suppliers.
- 3.2. You may not assign, resell, distribute or sublicense the Software or a copy of the Software.
- 3.3. You may not create, assign, resell, or sublicense secondary works of the Software without permission.
- 3.4. You may not modify, analyze, reverse engineer, decompile or disassemble any part of the Software.
- 3.5. You may not combine or incorporate the Software with or into any other application.
- 3.6. You may not print the Software.

Article 4 Disclaimer

- 4.1. THE HARDWARE PRODUCT LIMITED WARRANTY IS SET FORTH IN THE DOCUMENTATION ACCOMPANYING THE HARDWARE PRODUCT.
- 4.2. THE SOFTWARE IS PROVIDED "AS-IS" AND "AS-AVAILABLE," WITHOUT WARRANTIES OF ANY KIND. ALL WARRANTIES AND CONDITIONS, EXPRESS OR IMPLIED, CONTRACTUAL OR STATUTORY, INCLUDING BUT NOT LIMITED TO, ANY IMPLIED WARRANTIES OF MERCHANTABILITY OR FITNESS FOR A PARTICULAR PURPOSE, TITLE OR NON-INFRINGEMENT ARE HEREBY WAIVED BY YOU AND DISCLAIMED BY TOSHIBA. THIS EULA REPRESENTS THE SOLE AND EXCLUSIVE OBLIGATION OF TOSHIBA AND ITS SUPPLIERS WITH RESPECT TO THE SOFTWARE.

Article 5 Limitation of Liability

TO THE MAXIMUM EXTENT NOT PROHIBITED BY APPLICABLE LAW, IN NO EVENT SHALL TOSHIBA AND/OR ITS SUPPLIERS BE LIABLE FOR PERSONAL INJURY, OR ANY INCIDENTAL, SPECIAL, INDIRECT, PUNITIVE OR CONSEQUENTIAL DAMAGES WHATSOEVER, INCLUDING, WITHOUT LIMITATION, DAMAGES FOR LOSS OF PROFITS, LOSS OF DATA, BUSINESS INTERRUPTION, OR ANY OTHER COMMERCIAL DAMAGES OR LOSSES, ARISING OUT OF OR RELATED TO YOUR USE OR INABILITY TO USE THE SOFTWARE, HOWEVER CAUSED, REGARDLESS OF THE THEORY OF LIABILITY (CONTRACT, TORT, OR OTHERWISE) AND EVEN IF TOSHIBA AND/OR ITS SUPPLIERS HAS BEEN ADVISED OF THE POSSIBILITY OF SUCH DAMAGES. SOME JURISDICTIONS DO NOT ALLOW THE LIMITATION OF LIABILITY FOR PERSONAL INJURY, OR FOR INCIDENTAL OR CONSEQUENTIAL DAMAGES; THEREFORE, THE ABOVE LIMITATIONS MAY NOT APPLY TO YOU UNDER SUCH CIRCUMSTANCES. THE AGGREGATE LIABILITY OF TOSHIBA AND ITS SUPPLIERS IN CONNECTION WITH THE SOFTWARE, REGARDLESS OF THE FORM OF ANY LEGAL ACTION OR PROCEEDING, SHALL BE LIMITED TO DIRECT DAMAGES NOT TO EXCEED THE AMOUNT PAID FOR THE TOSHIBA BLU-RAY PLAYER.

Article 6 Export Control

Any export, directly or indirectly, of the Software in contravention of the United States Export Administration Regulations, or any other applicable law, regulation, or order, is prohibited.

Article 7 Termination of License

In the event that you fail to comply with any of the terms and conditions contained herein, Toshiba shall have the right to immediately terminate this Agreement without any notification to you. Upon termination of this Agreement, you shall cease all use of the Software and destroy all copies, in whole and/or in part.

Article 8 Governing Law

This EULA is governed by the laws of Japan, without references to the conflict of laws principles. Any and all disputes arising hereunder shall be resolved exclusively by the Tokyo District Court, Japan, and you hereby consent to the exclusive jurisdiction of such court.

Article 9 Severability

If any provision of this EULA shall be held to be invalid, illegal or unenforceable, the validity, legality and enforceability of the remaining provisions hereof shall not in any way be affected or impaired.

(C) 2001-2010 Toshiba Corporation

The Software contains Macromedia® [Flash®] [Flash Lite™] technology of Adobe Systems Incorporated.

Copyright© 1995-2007 Adobe Systems Incorporated. All rights reserved. Macromedia, Flash, Macromedia Flash, [and Macromedia Flash Lite] are trademarks or registered trademarks of Adobe Systems Incorporated in the United States and other countries.

License information on the software used in the TOSHIBA Blu-ray Disc™ player

This document is statement purpose only. Not concerned with operation of this product.

The software pre-installed in the TOSHIBA Blu-ray Disc™ player consists of multiple, independent software components. Each software component is copyrighted by TOSHIBA or a third party.

The TOSHIBA Blu-ray Disc™ player uses software components that are distributed as freeware under a third-party end-user license agreement or copyright notice (hereinafter referred to as a "EULA").

Some EULAs require that the source code of the applicable component be disclosed as the condition for distributing the software component in executable format. You can check the software components subject to such EULA requirements on the following phone number:

Phone number: 1-800-631-3811

TOSHIBA provides a warranty for the TOSHIBA Blu-ray Disc™ player you have purchased under conditions set forth by TOSHIBA.

However, some of the software components distributed under an EULA are made available for use by the user on the assumption that they are not copyrighted or warranted by TOSHIBA or any third party. These software components are licensed to the user free of charge and therefore not covered by any warranty within the scope of the applicable laws. These software components are not subject to any copyrights or other third-party rights and are provided in "as is" condition without any warranty, whether express or implied. "Warranty" here includes, but not limited to, an implied warranty for marketability or fitness for specific uses. All risks associated with the quality or performance of these software components are assumed by the user. TOSHIBA shall not be liable whatsoever for any cost of repair or correction or other incidental expense incurred in connection with a defect found in any of these software components. Unless specified under the applicable laws or in a written agreement, a party who changes or redistributes the software with consent from the copyright holders or based on the aforementioned licenses shall not be held liable whatsoever for any loss arising from the use of or inability to use such software components. The same applies even when the copyright holders or relevant third parties have been informed of the possibility of such loss. "Loss" here includes normal, special, incidental and indirect loss (including, but not limited to, the loss of data or its accuracy; loss incurred by the user or any third party; and interface incompatibility with other software). Please read each EULA for details on the use conditions and items that must be observed regarding these software components.

The table below lists the software components pre-installed in the TOSHIBA Blu-ray Disc™ player, which are subject to EULAs. The user should read the applicable EULAs carefully before using these software components. The EULAs are exhibited in their original text (English) as exactly written by the respective parties other than TOSHIBA.

OTHERS

Open-Source Software Included in the Blu-ray Disc™ Player:

Software License (*= source must be distributed on request)

A copy of the GPL2.0 license is provided in Appendix K
A copy of the LGPL2.1 license is provided in Appendix L

*backtrace	GPL2
*directfb-extra	GPL2
*cairo	LGPL2
*directfb	GPL2
*iconv	LGPL2
openssl	BSD-old dual license. The terms and conditions which apply to this software are provided in Appendix H. This product includes software developed by the OpenSSL Project for use in the OpenSSL Toolkit (http://www.openssl.org)
curl	The terms and conditions which apply to this software are provided in Appendix A.
*freetype	The terms and conditions which apply to this software are provided in Appendix G. Recommended advertisement is: Portions of this software are copyright © <year> The FreeType Project (www.freetype.org). All rights reserved.
jpeg	The terms and conditions which apply to this software are provided in Appendix B.
expat	The terms and conditions which apply to this software are provided in Appendix I.
mng	The terms and conditions which apply to this software are provided in Appendix C.
png	The terms and conditions which apply to this software are provided in Appendix D.
xml	The terms and conditions which apply to this software are provided in Appendix E.
zlib	The terms and conditions which apply to this software are provided in Appendix F.
Elektra	BSD-new
Ltdl	LPGL
fontconfig	
pixman	
qlite	
malloc-extras	
xsit	
hostname	
init	
nandtest	

Open-Source Software Included in the Kernel/Rootfs:

(* = source must be distributed on request)
A copy of the GPL license is provided in Appendix K
A copy of the LGPL license is provided in Appendix L

Utility	Base Version	License	Utility	Base Version	License
*kernel		GPL 2.0	*tinylogin	TinyLogin-0.80	GPL 2.0
*arp	net-tools-1.52	GPL 2.0	*hotplug	hotplug-1.8	GPL 2.0
*bash	GNU Bash-3.2	GPL 2.0	*utelnetsd	utelnetsd-0.1.3	GPL 2.0
*busybox	busybox-1.11.1	GPL 2.0	*procps	procps-3.2.8	GPL 2.0
*cramfsck	cramfs	GPL 2.0	*libfreetype.so.6.3.	freetype-2.1.2	GPL 2.0
*dhcpcd	dhcpcd-1.3	GPL 2.0	*libtermcap.so	GNU Bash-2.05	GPL 2.0
*e2fsprogs	e2fsprogs-1.41.5	GPL 2.0	*libtermcap.so.2.0.8	GNU termcap 1.3	GPL 2.0
*fdisk	fdisk-2.10m	GPL 2.0	zlib	zlib-1.2.3	zlib license
*getty	TinyLogin-0.80	GPL 2.0			
*hostnamesysutils	sysutils	GPL 2.0			The terms and conditions which apply to this software are provided in Appendix F.
*ifconfig	net-tools-1.52	GPL 2.0	libusb.so	libusb-0.1.12	LGPL 2.1
*kill	sysutils	GPL 2.0	uClibc	uClibc-nptl-0.9.29-20070423	LGPL 2.1
*mkcramfs	cramfs	GPL 2.0	tcpdump	tcpdump-4.0.0	BSD-new
*ntfs-3g	ntfs-3g 2009.4.4	GPL 2.0			The terms and conditions which apply to this software are provided in Appendix M.
*passwd	TinyLogin-0.80	GPL 2.0	strace	strace 4.5.18	BSD-new
*ps	sysutils	GPL 2.0			The terms and conditions which apply to this software are provided in Appendix M.
*route	net-tools-1.52	GPL 2.0			
*sfdisk	sfdisk-3.07	GPL 2.0			
*shutdown	sysutils	GPL 2.0			

Utility	Base Version	License	Utility	Base Version	License
hdparm	hdparm-6.9	BSD-new	ntpdate		GPL2.0
The terms and conditions which apply to this software are provided in Appendix M.			top		GPL2.0
libpcap	libcap-1.0.0	BSD-new	tune2fs		GPL2.0
The terms and conditions which apply to this software are provided in Appendix M.			ubiattach		GPL2.0
portmap	portmap	BSD-old	ubircrc32		GPL2.0
The terms and conditions which apply to this software are provided in Appendix J.			ubidetach		GPL2.0
	Advertising sentence is: Copyright (c) 1990 The Regents of the University of California. All rights reserved.		ubiformat		GPL2.0
openssl	openssl 0.9.8k	BSD-old. See advertisement notice above.	ubimkvol		GPL2.0
pata_platform.ko		GPL	ubinfo		GPL2.0
scsi_wait_scan.ko		GPL	ubinize		GPL2.0
Badblocks		GPL2.0	ubirename		GPL2.0
compile_et		GPL2.0	ubirmvol		GPL2.0
e2fsck		GPL2.0	ubiupdatevol		GPL2.0
flash_erase		GPL2.0	vmstat		GPL2.0
flash_eraseall		GPL2.0	libusb-config		GPL2.1
flash_info		GPL2.0	libusbpp		GPL2.1
fsck		GPL2.0	libuuid		GPL2.1
genecceerror		GPL2.0	Tip		Unique license
hdparm		GPL2.0	Unzip		Unique license
hotplug		GPL2.0	brcm_wifi.hotplug		GPL2.0
libcom_err		GPL2.0	libss		GPL2.0
libe2p		GPL2.0	libstdc++		GPL2.0
libext2fs		GPL2.0	mk_cmds		GPL2.0
libgcc_s		GPL2.0	mke2fs		GPL2.0
libnandutils		GPL2.0	mklost+found		GPL2.0
libproc		GPL2.0	mount.hotplug		GPL2.0
nanddump		GPL2.0	mtdfinfo		GPL2.0
nandwrite		GPL2.0	nandsim.ko		GPL2.0
netstat		GPL2.0	tftpd		GPL2.0

OTHERS

Luxi Font Copyright

Luxi fonts copyright (c) 2001 by Bigelow & Holmes Inc. Luxi font instruction code copyright (c) 2001 by URW++ GmbH. All Rights Reserved. Luxi is a registered trademark of Bigelow & Holmes Inc. Permission is hereby granted, free of charge, to any person obtaining a copy of these Fonts and associated documentation files (the "Font Software"), to deal in the Font Software, including without limitation the rights to use, copy, merge, publish, distribute, sublicense, and/or sell copies of the Font Software, and to permit persons to whom the Font Software is furnished to do so, subject to the following conditions:

The above copyright and trademark notices and this permission notice shall be included in all copies of one or more of the Font Software.

The Font Software may not be modified, altered, or added to, and in particular the designs of glyphs or characters in the Fonts may not be modified nor may additional glyphs or characters be added to the Fonts. This License becomes null and void when the Fonts or Font Software have been modified.

THE FONT SOFTWARE IS PROVIDED "AS IS", WITHOUT WARRANTY OF ANY KIND, EXPRESS OR IMPLIED, INCLUDING BUT NOT LIMITED TO ANY WARRANTIES OF MERCHANTABILITY, FITNESS FOR A PARTICULAR PURPOSE AND NONINFRINGEMENT OF COPYRIGHT, PATENT, TRADEMARK, OR OTHER RIGHT. IN NO EVENT SHALL BIGELOW & HOLMES INC. OR URW++ GMBH. BE LIABLE FOR ANY CLAIM, DAMAGES OR OTHER LIABILITY, INCLUDING ANY GENERAL, SPECIAL, INDIRECT, INCIDENTAL, OR CONSEQUENTIAL DAMAGES, WHETHER IN AN ACTION OF CONTRACT, TORT OR OTHERWISE, ARISING FROM, OUT OF THE USE OR INABILITY TO USE THE FONT SOFTWARE OR FROM OTHER DEALINGS IN THE FONT SOFTWARE.

Except as contained in this notice, the names of Bigelow & Holmes Inc. and URW++ GmbH. shall not be used in advertising or otherwise to promote the sale, use or other dealings in this Font Software without prior written authorization from Bigelow & Holmes Inc. and URW++ GmbH.

For further information, contact:

info@urwpp.de or design@bigelowandholmes.com

Appendix A - CURL license

COPYRIGHT AND PERMISSION NOTICE

Copyright (c) 1996 - 2009, Daniel Stenberg, <daniel@haxx.se>.

All rights reserved.

Permission to use, copy, modify, and distribute this software for any purpose with or without fee is hereby granted, provided that the above copyright notice and this permission notice appear in all copies.

THE SOFTWARE IS PROVIDED „AS IS”; WITHOUT WARRANTY OF ANY KIND, EXPRESS OR IMPLIED, INCLUDING BUT NOT LIMITED TO THE WARRANTIES OF MERCHANTABILITY, FITNESS FOR A PARTICULAR PURPOSE AND NONINFRINGEMENT OF THIRD PARTY RIGHTS. IN NO EVENT SHALL THE AUTHORS OR COPYRIGHT HOLDERS BE LIABLE FOR ANY CLAIM, DAMAGES OR OTHER LIABILITY, WHETHER IN AN ACTION OF CONTRACT, TORT OR OTHERWISE, ARISING FROM, OUT OF OR IN CONNECTION WITH THE SOFTWARE OR THE USE OR OTHER DEALINGS IN THE SOFTWARE.

Except as contained in this notice, the name of a copyright holder shall not be used in advertising or otherwise to promote the sale, use or other dealings in this Software without prior written authorization of the copyright holder.

Appendix B - JPEG License

LEGAL ISSUES

=====

In plain English:

1. We don't promise that this software works. (But if you find any bugs, please let us know!)
2. You can use this software for whatever you want. You don't have to pay us.
3. You may not pretend that you wrote this software. If you use it in a program, you must acknowledge somewhere in your documentation that you've used the IJG code.

In legalese:

The authors make NO WARRANTY or representation, either express or implied, with respect to this software, its quality, accuracy, merchantability, or fitness for a particular purpose. This software is provided "AS IS", and you, its user, assume the entire risk as to its quality and accuracy.

This software is copyright (C) 1991-1998, Thomas G. Lane.

All Rights Reserved except as specified below.

Permission is hereby granted to use, copy, modify, and distribute this software (or portions thereof) for any purpose, without fee, subject to these conditions:

- (1) If any part of the source code for this software is distributed, then this README file must be included, with this copyright and no-warranty notice unaltered; and any additions, deletions, or changes to the original files must be clearly indicated in accompanying documentation.
- (2) If only executable code is distributed, then the accompanying documentation must state that "this software is based in part on the work of the Independent JPEG Group".
- (3) Permission for use of this software is granted only if the user accepts full responsibility for any undesirable consequences; the authors accept NO LIABILITY for damages of any kind.

These conditions apply to any software derived from or based on the IJG code, not just to the unmodified library. If you use our work, you ought to acknowledge us.

Permission is NOT granted for the use of any IJG author's name or company name in advertising or publicity relating to this software or products derived from it. This software may be referred to only as "the Independent JPEG Group's software".

We specifically permit and encourage the use of this software as the basis of commercial products, provided that all warranty or liability claims are assumed by the product vendor.

Appendix C - MNG License

/*

COPYRIGHT NOTICE:

Copyright (c) 2000 Gerard Juyn (gerard@libmng.com)

[You may insert additional notices after this sentence if you modify this source]

For the purposes of this copyright and license, "Contributing Authors" is defined as the following set of individuals:

Gerard Juyn

The MNG Library is supplied "AS IS". The Contributing Authors disclaim all warranties, expressed or implied, including, without limitation, the warranties of merchantability and of fitness for any purpose. The Contributing Authors assume no liability for direct, indirect, incidental, special, exemplary, or consequential damages, which may result from the use of the MNG Library, even if advised of the possibility of such damage.

Permission is hereby granted to use, copy, modify, and distribute this source code, or portions hereof, for any purpose, without fee, subject to the following restrictions:

1. The origin of this source code must not be misrepresented; you must not claim that you wrote the original software.
2. Altered versions must be plainly marked as such and must not be misrepresented as being the original source.
3. This Copyright notice may not be removed or altered from any source or altered source distribution.

The Contributing Authors specifically permit, without fee, and encourage the use of this source code as a component to supporting the MNG and JNG file format in commercial products. If you use this source code in a product, acknowledgment would be highly appreciated.

Parts of this software have been adapted from the libpng package. Although this library supports all features from the PNG specification (as MNG descends from it), it does not require the libpng package. It does require the zlib library and optionally the IJG jpeg library, and/or the "tittle-cms" library by Marti Maria (depending on the inclusion of support for JNG and Full-Color-Management respectively).

This library's function is primarily to read and display MNG animations. It is not meant as a full-featured image-editing component! It does however offer creation and editing functionality at the chunk level. (future modifications may include some more support for creation and or editing)

*/

Appendix D - PNG License File Distribution Clause

The Contributing Authors and Group 42, Inc. specifically permit, without fee, and encourage the use of this source code as a component to supporting the PNG file format in commercial products. If you use this source code in a product, acknowledgment is not required but would be appreciated.

Appendix E – XML License

Except where otherwise noted in the source code (e.g. the files hash.c, list.c and the trio files, which are covered by a similar licence but with different Copyright notices) all the files are:

Copyright (C) 1998-2003 Daniel Veillard. All Rights Reserved.

Permission is hereby granted, free of charge, to any person obtaining a copy of this software and associated documentation files (the "Software"), to deal in the Software without restriction, including without limitation the rights to use, copy, modify, merge, publish, distribute, sublicense, and/or sell copies of the Software, and to permit persons to whom the Software is furnished to do so, subject to the following conditions:

The above copyright notice and this permission notice shall be included in all copies or substantial portions of the Software.

THE SOFTWARE IS PROVIDED "AS IS", WITHOUT WARRANTY OF ANY KIND, EXPRESS OR IMPLIED, INCLUDING BUT NOT LIMITED TO THE WARRANTIES OF MERCHANTABILITY, FITNESS FOR A PARTICULAR PURPOSE AND NONINFRINGEMENT. IN NO EVENT SHALL THE DANIEL VEILLARD BE LIABLE FOR ANY CLAIM, DAMAGES OR OTHER LIABILITY, WHETHER IN AN ACTION OF CONTRACT, TORT OR OTHERWISE, ARISING FROM, OUT OF OR IN CONNECTION WITH THE SOFTWARE OR THE USE OR OTHER DEALINGS IN THE SOFTWARE.

Except as contained in this notice, the name of Daniel Veillard shall not be used in advertising or otherwise to promote the sale, use or other dealings in this Software without prior written authorization from him.

Appendix F – zlib Distribution Conditions

This software is provided 'as-is', without any express or implied warranty. In no event will the authors be held liable for any damages arising from the use of this software.

Permission is granted to anyone to use this software for any purpose, including commercial applications, and to alter it and redistribute it freely, subject to the following restrictions:

1. The origin of this software must not be misrepresented; you must not claim that you wrote the original software. If you use this software in a product, an acknowledgment in the product documentation would be appreciated but is not required.
2. Altered source versions must be plainly marked as such, and must not be misrepresented as being the original software.
3. This notice may not be removed or altered from any source distribution.

Jean-loup Gailly Mark Adler
jloup@gzip.org madler@alumni.caltech.edu

If you use the zlib library in a product, we would appreciate "not" receiving lengthy legal documents to sign. The sources are provided for free but without warranty of any kind. The library has been entirely written by Jean-loup Gailly and Mark Adler; it does not include third-party code.

If you redistribute modified sources, we would appreciate that you include in the file ChangeLog history information documenting your changes. Please read the FAQ for more information on the distribution of modified source versions.

Appendix G – Freetype License

The FreeType Project LICENSE

2006-Jan-27

Copyright 1996-2002, 2006 by
David Turner, Robert Wilhelm, and Werner Lemberg

Introduction

The FreeType Project is distributed in several archive packages; some of them may contain, in addition to the FreeType font engine, various tools and contributions which rely on, or relate to, the FreeType Project.

This license applies to all files found in such packages, and which do not fall under their own explicit license. The license affects thus the FreeType font engine, the test programs, documentation and makefiles, at the very least.

This license was inspired by the BSD, Artistic, and IJG (Independent JPEG Group) licenses, which all encourage inclusion and use of free software in commercial and freeware products alike. As a consequence, its main points are that:

- o We don't promise that this software works. However, we will be interested in any kind of bug reports. ('as is' distribution)
- o You can use this software for whatever you want, in parts or full form, without having to pay us. ('royalty-free' usage)
- o You may not pretend that you wrote this software. If you use it, or only parts of it, in a program, you must acknowledge somewhere in your documentation that you have used the FreeType code. ('credits')

We specifically permit and encourage the inclusion of this software, with or without modifications, in commercial products. We disclaim all warranties covering The FreeType Project and assume no liability related to The FreeType Project.

Finally, many people asked us for a preferred form for a credit/disclaimer to use in compliance with this license. We thus encourage you to use the following text:

```
*****  
Portions of this software are copyright © <year> The FreeType Project (www.freetype.org). All rights reserved.  
*****
```

Please replace <year> with the value from the FreeType version you actually use.

Legal Terms

0. Definitions

Throughout this license, the terms 'package', 'FreeType Project', and 'FreeType archive' refer to the set of files originally distributed by the authors (David Turner, Robert Wilhelm, and Werner Lemberg) as the 'FreeType Project', be they named as alpha, beta or final release.

'You' refers to the licensee, or person using the project, where 'using' is a generic term including compiling the project's source code as well as linking it to form a 'program' or 'executable'. This program is referred to as 'a program using the FreeType engine'.

This license applies to all files distributed in the original FreeType Project, including all source code, binaries and documentation, unless otherwise stated in the file in its original, unmodified form as distributed in the original archive. If you are unsure whether or not a particular file is covered by this license, you must contact us to verify this.

The FreeType Project is copyright (C) 1996-2000 by David Turner, Robert Wilhelm, and Werner Lemberg. All rights reserved except as specified below.

1. No Warranty

THE FREETYPE PROJECT IS PROVIDED 'AS IS' WITHOUT WARRANTY OF ANY KIND, EITHER EXPRESS OR IMPLIED, INCLUDING, BUT NOT LIMITED TO, WARRANTIES OF MERCHANTABILITY AND FITNESS FOR A PARTICULAR PURPOSE. IN NO EVENT WILL ANY OF THE AUTHORS OR COPYRIGHT HOLDERS BE LIABLE FOR ANY DAMAGES CAUSED BY THE USE OR THE INABILITY TO USE, OF THE FREETYPE PROJECT.

2. Redistribution

This license grants a worldwide, royalty-free, perpetual and irrevocable right and license to use, execute, perform, compile, display, copy, create derivative works of, distribute and sublicense the FreeType Project (in both source and object code forms) and derivative works thereof for any purpose; and to authorize others to exercise some or all of the rights granted herein, subject to the following conditions:

- o Redistribution of source code must retain this license file ('FTL.TXT') unaltered; any additions, deletions or changes to the original files must be clearly indicated in accompanying documentation. The copyright notices of the unaltered, original files must be preserved in all copies of source files.
- o Redistribution in binary form must provide a disclaimer that states that the software is based in part of the work of the FreeType Team, in the distribution documentation. We also encourage you to put an URL to the FreeType web page in your documentation, though this isn't mandatory.

These conditions apply to any software derived from or based on the FreeType Project, not just the unmodified files. If you use our work, you must acknowledge us. However, no fee need be paid to us.

3. Advertising

Neither the FreeType authors and contributors nor you shall use the name of the other for commercial, advertising, or promotional purposes without specific prior written permission.

We suggest, but do not require, that you use one or more of the following phrases to refer to this software in your documentation or advertising materials: 'FreeType Project', 'FreeType Engine', 'FreeType library', or 'FreeType Distribution'.

As you have not signed this license, you are not required to accept it. However, as the FreeType Project is copyrighted material, only this license, or another one contracted with the authors, grants you the right to use, distribute, and modify it. Therefore, by using, distributing, or modifying the FreeType Project, you indicate that you understand and accept all the terms of this license.

4. Contacts

There are two mailing lists related to FreeType:

o freetype@nongnu.org

Discusses general use and applications of FreeType, as well as future and wanted additions to the library and distribution. If you are looking for support, start in this list if you haven't found anything to help you in the documentation.

o freetype-devel@nongnu.org

Discusses bugs, as well as engine internals, design issues, specific licenses, porting, etc.

Our home page can be found at

<http://www.freetype.org>

--- end of FTL.TXT ---

Appendix H – Openssl License

LICENSE ISSUES

The OpenSSL toolkit stays under a dual license, i.e. both the conditions of the OpenSSL License and the original SSLeay license apply to the toolkit.

See below for the actual license texts. Actually both licenses are BSD-style Open Source licenses. In case of any license issues related to OpenSSL, please contact openssl-core@openssl.org.

OpenSSL License

/* =====

Copyright (c) 1998-2008 The OpenSSL Project. All rights reserved.

Redistribution and use in source and binary forms, with or without modification, are permitted provided that the following conditions are met:

1. Redistributions of source code must retain the above copyright notice, this list of conditions and the following disclaimer.
2. Redistributions in binary form must reproduce the above copyright notice, this list of conditions and the following disclaimer in the documentation and/or other materials provided with the distribution.
3. All advertising materials mentioning features or use of this software must display the following acknowledgment: "This product includes software developed by the OpenSSL Project for use in the OpenSSL Toolkit. (<http://www.openssl.org/>)"
4. The names "OpenSSL Toolkit" and "OpenSSL Project" must not be used to endorse or promote products derived from this software without prior written permission. For written permission, please contact openssl-core@openssl.org.
5. Products derived from this software may not be called "OpenSSL" nor may "OpenSSL" appear in their names without prior written permission of the OpenSSL Project.
6. Redistributions of any form whatsoever must retain the following acknowledgment: "This product includes software developed by the OpenSSL Project for use in the OpenSSL Toolkit (<http://www.openssl.org/>)"

THIS SOFTWARE IS PROVIDED BY THE OpenSSL PROJECT ``AS IS'' AND ANY EXPRESSED OR IMPLIED WARRANTIES, INCLUDING, BUT NOT LIMITED TO, THE IMPLIED WARRANTIES OF MERCHANTABILITY AND FITNESS FOR A PARTICULAR PURPOSE ARE DISCLAIMED. IN NO EVENT SHALL THE OpenSSL PROJECT OR ITS CONTRIBUTORS BE LIABLE FOR ANY DIRECT, INDIRECT, INCIDENTAL, SPECIAL, EXEMPLARY, OR CONSEQUENTIAL DAMAGES (INCLUDING, BUT NOT LIMITED TO, PROCUREMENT OF SUBSTITUTE GOODS OR SERVICES; LOSS OF USE, DATA, OR PROFITS; OR BUSINESS INTERRUPTION) HOWEVER CAUSED AND ON ANY THEORY OF LIABILITY, WHETHER IN CONTRACT, STRICT LIABILITY, OR TORT (INCLUDING NEGLIGENCE OR OTHERWISE) ARISING IN ANY WAY OUT OF THE USE OF THIS SOFTWARE, EVEN IF ADVISED OF THE POSSIBILITY OF SUCH DAMAGE.

This product includes cryptographic software written by Eric Young (ey@cryptsoft.com). This product includes software written by Tim Hudson (th@cryptsoft.com).

*/

OTHERS

Others

Original SSLeay License

```
/* Copyright (C) 1995-1998 Eric Young (eay@cryptsoft.com) All rights reserved.
```

This package is an SSL implementation written by Eric Young (eay@cryptsoft.com). The implementation was written so as to conform with Netscapes SSL.

This library is free for commercial and non-commercial use as long as the following conditions are aheared to. The following conditions apply to all code found in this distribution, be it the RC4, RSA, lhash, DES, etc., code; not just the SSL code. The SSL documentation included with this distribution is covered by the same copyright terms except that the holder is Tim Hudson (tjh@cryptsoft.com).

Copyright remains Eric Young's, and as such any Copyright notices in the code are not to be removed. If this package is used in a product, Eric Young should be given attribution as the author of the parts of the library used. This can be in the form of a textual message at program startup or in documentation (online or textual) provided with the package.

Redistribution and use in source and binary forms, with or without modification, are permitted provided that the following conditions are met:

1. Redistributions of source code must retain the copyright notice, this list of conditions and the following disclaimer.
2. Redistributions in binary form must reproduce the above copyright notice, this list of conditions and the following disclaimer in the documentation and/or other materials provided with the distribution.
3. All advertising materials mentioning features or use of this software must display the following acknowledgement: "This product includes cryptographic software written by Eric Young (eay@cryptsoft.com)"

The word 'cryptographic' can be left out if the rouines from the library being used are not cryptographic related :-).

4. If you include any Windows specific code (or a derivative thereof) from the apps directory (application code) you must include an acknowledgement: "This product includes software written by Tim Hudson (tjh@cryptsoft.com)"

THIS SOFTWARE IS PROVIDED BY ERIC YOUNG ``AS IS'' AND ANY EXPRESS OR IMPLIED WARRANTIES, INCLUDING, BUT NOT LIMITED TO, THE IMPLIED WARRANTIES OF MERCHANTABILITY AND FITNESS FOR A PARTICULAR PURPOSE ARE DISCLAIMED. IN NO EVENT SHALL THE AUTHOR OR CONTRIBUTORS BE LIABLE FOR ANY DIRECT, INDIRECT, INCIDENTAL, SPECIAL, EXEMPLARY, OR CONSEQUENTIAL DAMAGES (INCLUDING, BUT NOT LIMITED TO, PROCUREMENT OF SUBSTITUTE GOODS OR SERVICES; LOSS OF USE, DATA, OR PROFITS; OR BUSINESS INTERRUPTION) HOWEVER CAUSED AND ON ANY THEORY OF LIABILITY, WHETHER IN CONTRACT, STRICT LIABILITY, OR TORT (INCLUDING NEGLIGENCE OR OTHERWISE) ARISING IN ANY WAY OUT OF THE USE OF THIS SOFTWARE, EVEN IF ADVISED OF THE POSSIBILITY OF SUCH DAMAGE.

The licence and distribution terms for any publically available version or derivative of this code cannot be changed. i.e. this code cannot simply be copied and put under another distribution licence [including the GNU Public Licence.]

```
*/
```

Appendix I – Expat License

Copyright (c) 1998, 1999, 2000 Thai Open Source Software Center Ltd and Clark Cooper Copyright (c) 2001, 2002, 2003, 2004, 2005, 2006 Expat maintainers.

Permission is hereby granted, free of charge, to any person obtaining a copy of this software and associated documentation files (the "Software"), to deal in the Software without restriction, including without limitation the rights to use, copy, modify, merge, publish, distribute, sublicense, and/or sell copies of the Software, and to permit persons to whom the Software is furnished to do so, subject to the following conditions:

The above copyright notice and this permission notice shall be included in all copies or substantial portions of the Software.

THIS SOFTWARE IS PROVIDED "AS IS", WITHOUT WARRANTY OF ANY KIND, EXPRESS OR IMPLIED, INCLUDING BUT NOT LIMITED TO THE WARRANTIES OF MERCHANTABILITY, FITNESS FOR A PARTICULAR PURPOSE AND NONINFRINGEMENT. IN NO EVENT SHALL THE AUTHORS OR COPYRIGHT HOLDERS BE LIABLE FOR ANY CLAIM, DAMAGES OR OTHER LIABILITY, WHETHER IN AN ACTION OF CONTRACT, TORT OR OTHERWISE, ARISING FROM, OUT OF OR IN CONNECTION WITH THE SOFTWARE OR THE USE OR OTHER DEALINGS IN THE SOFTWARE.

Appendix J – Portmap License

```
/*-
```

Copyright (c) 1990 The Regents of the University of California. All rights reserved.

Redistribution and use in source and binary forms, with or without modification, are permitted provided that the following conditions are met:

1. Redistributions of source code must retain the above copyright notice, this list of conditions and the following disclaimer.
2. Redistributions in binary form must reproduce the above copyright notice, this list of conditions and the following disclaimer in the documentation and/or other materials provided with the distribution.
3. All advertising materials mentioning features or use of this software must display the following acknowledgement: This product includes software developed by the University of California, Berkeley and its contributors.
4. Neither the name of the University nor the names of its contributors may be used to endorse or promote products derived from this software without specific prior written permission.

THIS SOFTWARE IS PROVIDED BY THE REGENTS AND CONTRIBUTORS ``AS IS'' AND ANY EXPRESS OR IMPLIED WARRANTIES, INCLUDING, BUT NOT LIMITED TO, THE IMPLIED WARRANTIES OF MERCHANTABILITY AND FITNESS FOR A PARTICULAR PURPOSE ARE DISCLAIMED. IN NO EVENT SHALL THE REGENTS OR CONTRIBUTORS BE LIABLE FOR ANY DIRECT, INDIRECT, INCIDENTAL, SPECIAL, EXEMPLARY, OR CONSEQUENTIAL DAMAGES (INCLUDING, BUT NOT LIMITED TO, PROCUREMENT OF SUBSTITUTE GOODS OR SERVICES; LOSS OF USE, DATA, OR PROFITS; OR BUSINESS INTERRUPTION) HOWEVER CAUSED AND ON ANY THEORY OF LIABILITY, WHETHER IN CONTRACT, STRICT LIABILITY, OR TORT (INCLUDING NEGLIGENCE OR OTHERWISE) ARISING IN ANY WAY OUT OF THE USE OF THIS SOFTWARE, EVEN IF ADVISED OF THE POSSIBILITY OF SUCH DAMAGE.

```
*/
```

Appendix K – GNU GPL 2.0

GNU GENERAL PUBLIC LICENSE
Version 2, June 1991

Copyright (C) 1989, 1991 Free Software Foundation, Inc.
51 Franklin Street, Fifth Floor, Boston, MA 02110-1301, USA

Everyone is permitted to copy and distribute verbatim copies of this license document, but changing it is not allowed.

Preamble

The licenses for most software are designed to take away your freedom to share and change it. By contrast, the GNU General Public License is intended to guarantee your freedom to share and change free software—to make sure the software is free for all its users. This General Public License applies to most of the Free Software Foundation's software and to any other program whose authors commit to using it. (Some other Free Software Foundation software is covered by the GNU Lesser General Public License instead.) You can apply it to your programs, too.

When we speak of free software, we are referring to freedom, not price. Our General Public Licenses are designed to make sure that you have the freedom to distribute copies of free software (and charge for this service if you wish), that you receive source code or can get it if you want it, that you can change the software or use pieces of it in new free programs; and that you know you can do these things.

To protect your rights, we need to make restrictions that forbid anyone to deny you these rights or to ask you to surrender the rights. These restrictions translate to certain responsibilities for you if you distribute copies of the software, or if you modify it.

For example, if you distribute copies of such a program, whether gratis or for a fee, you must give the recipients all the rights that you have. You must make sure that they, too, receive or can get the source code. And you must show them these terms so they know their rights.

We protect your rights with two steps: (1) copyright the software, and (2) offer you this license which gives you legal permission to copy, distribute and/or modify the software.

Also, for each author's protection and ours, we want to make certain that everyone understands that there is no warranty for this free software. If the software is modified by someone else and passed on, we want its recipients to know that what they have is not the original, so that any problems introduced by others will not reflect on the original authors' reputations.

Finally, any free program is threatened constantly by software patents. We wish to avoid the danger that redistributors of a free program will individually obtain patent licenses, in effect making the program proprietary. To prevent this, we have made it clear that any patent must be licensed for everyone's free use or not licensed at all.

The precise terms and conditions for copying, distribution and modification follow.

TERMS AND CONDITIONS FOR COPYING, DISTRIBUTION AND MODIFICATION

0. This License applies to any program or other work which contains a notice placed by the copyright holder saying it may be distributed under the terms of this General Public License. The "Program", below, refers to any such program or work, and a "work based on the Program" means either the Program or any derivative work under copyright law: that is to say, a work containing the Program or a portion of it, either verbatim or with modifications and/or translated into another language. (Hereinafter, translation is included without limitation in the term "modification".) Each licensee is addressed as "you".

Activities other than copying, distribution and modification are not covered by this License; they are outside its scope. The act of running the Program is not restricted, and the output from the Program is covered only if its contents constitute a work based on the Program (independent of having been made by running the Program). Whether that is true depends on what the Program does.

1. You may copy and distribute verbatim copies of the Program's source code as you receive it, in any medium, provided that you conspicuously and appropriately publish on each copy an appropriate copyright notice and disclaimer of warranty; keep intact all the notices that refer to this License and to the absence of any warranty; and give any other recipients of the Program a copy of this License along with the Program.

You may charge a fee for the physical act of transferring a copy, and you may at your option offer warranty protection in exchange for a fee.

2. You may modify your copy or copies of the Program or any portion of it, thus forming a work based on the Program, and copy and distribute such modifications or work under the terms of Section 1 above, provided that you also meet all of these conditions:

- You must cause the modified files to carry prominent notices stating that you changed the files and the date of any change.
- You must cause any work that you distribute or publish, that in whole or in part contains or is derived from the Program or any part thereof, to be licensed as a whole at no charge to all third parties under the terms of this License.
- If the modified program normally reads commands interactively when run, you must cause it, when started running for such interactive use in the most ordinary way, to print or display an announcement including an appropriate copyright notice and a notice that there is no warranty (or else, saying that you provide a warranty) and that users may redistribute the program under these conditions, and telling the user how to view a copy of this License. (Exception: if the Program itself is interactive but does not normally print such an announcement, your work based on the Program is not required to print an announcement.)

These requirements apply to the modified work as a whole. If identifiable sections of that work are not derived from the Program, and can be reasonably considered independent and separate works in themselves, then this License, and its terms, do not apply to those sections when you distribute them as separate works. But when you distribute the same sections as part of a whole which is a work based on the Program, the distribution of the whole must be on the terms of this License, whose permissions for other licensees extend to the entire whole, and thus to each and every part regardless of who wrote it.

Thus, it is not the intent of this section to claim rights or contest your rights to work written entirely by you; rather, the intent is to exercise the right to control the distribution of derivative or collective works based on the Program.

In addition, mere aggregation of another work not based on the Program with the Program (or with a work based on the Program) on a volume of a storage or distribution medium does not bring the other work under the scope of this License.

3. You may copy and distribute the Program (or a work based on it, under Section 2) in object code or executable form under the terms of Sections 1 and 2 above provided that you also do one of the following:

- Accompany it with the complete corresponding machine-readable source code, which must be distributed under the terms of Sections 1 and 2 above on a medium customarily used for software interchange; or,
- Accompany it with a written offer, valid for at least three years, to give any third party, for a charge no more than your cost of physically performing source distribution, a complete machine-readable copy of the corresponding source code, to be distributed under the terms of Sections 1 and 2 above on a medium customarily used for software interchange; or,

Others

c) Accompany it with the information you received as to the offer to distribute corresponding source code. (This alternative is allowed only for noncommercial distribution and only if you received the program in object code or executable form with such an offer, in accord with Subsection b above.)

The source code for a work means the preferred form of the work for making modifications to it. For an executable work, complete source code means all the source code for all modules it contains, plus any associated interface definition files, plus the scripts used to control compilation and installation of the executable. However, as a special exception, the source code distributed need not include anything that is normally distributed (in either source or binary form) with the major components (compiler, kernel, and so on) of the operating system on which the executable runs, unless that component itself accompanies the executable.

If distribution of executable or object code is made by offering access to copy from a designated place, then offering equivalent access to copy the source code from the same place counts as distribution of the source code, even though third parties are not compelled to copy the source along with the object code.

4. You may not copy, modify, sublicense, or distribute the Program except as expressly provided under this License. Any attempt otherwise to copy, modify, sublicense or distribute the Program is void, and will automatically terminate your rights under this License. However, parties who have received copies, or rights, from you under this License will not have their licenses terminated so long as such parties remain in full compliance.

5. You are not required to accept this License, since you have not signed it. However, nothing else grants you permission to modify or distribute the Program or its derivative works. These actions are prohibited by law if you do not accept this License. Therefore, by modifying or distributing the Program (or any work based on the Program), you indicate your acceptance of this License to do so, and all its terms and conditions for copying, distributing or modifying the Program or works based on it.

6. Each time you redistribute the Program (or any work based on the Program), the recipient automatically receives a license from the original licensor to copy, distribute or modify the Program subject to these terms and conditions. You may not impose any further restrictions on the recipients' exercise of the rights granted herein. You are not responsible for enforcing compliance by third parties to this License.

7. If, as a consequence of a court judgment or allegation of patent infringement or for any other reason (not limited to patent issues), conditions are imposed on you (whether by court order, agreement or otherwise) that contradict the conditions of this License, they do not excuse you from the conditions of this License. If you cannot distribute so as to satisfy simultaneously your obligations under this License and any other pertinent obligations, then as a consequence you may not distribute the Program at all. For example, if a patent license would not permit royalty-free redistribution of the Program by all those who receive copies directly or indirectly through you, then the only way you could satisfy both it and this License would be to refrain entirely from distribution of the Program.

If any portion of this section is held invalid or unenforceable under any particular circumstance, the balance of the section is intended to apply and the section as a whole is intended to apply in other circumstances.

It is not the purpose of this section to induce you to infringe any patents or other property right claims or to contest validity of any such claims; this section has the sole purpose of protecting the integrity of the free software distribution system, which is implemented by public license practices. Many people have made generous contributions to the wide range of software distributed through that system in reliance on consistent application of that system; it is up to the author/donor to decide if he or she is willing to distribute software through any other system and a licensee cannot impose that choice.

This section is intended to make thoroughly clear what is believed to be a consequence of the rest of this License.

8. If the distribution and/or use of the Program is restricted in certain countries either by patents or by copyrighted interfaces, the original copyright holder who places the Program under this License may add an explicit geographical distribution limitation excluding those countries, so that distribution is permitted only in or among countries not thus excluded. In such case, this License incorporates the limitation as if written in the body of this License.

9. The Free Software Foundation may publish revised and/or new versions of the General Public License from time to time. Such new versions will be similar in spirit to the present version, but may differ in detail to address new problems or concerns.

Each version is given a distinguishing version number. If the Program specifies a version number of this License which applies to it and "any later version", you have the option of following the terms and conditions either of that version or of any later version published by the Free Software Foundation. If the Program does not specify a version number of this License, you may choose any version ever published by the Free Software Foundation.

10. If you wish to incorporate parts of the Program into other free programs whose distribution conditions are different, write to the author to ask for permission. For software which is copyrighted by the Free Software Foundation, write to the Free Software Foundation; we sometimes make exceptions for this. Our decision will be guided by the two goals of preserving the free status of all derivatives of our free software and of promoting the sharing and reuse of software generally.

NO WARRANTY

11. BECAUSE THE PROGRAM IS LICENSED FREE OF CHARGE, THERE IS NO WARRANTY FOR THE PROGRAM, TO THE EXTENT PERMITTED BY APPLICABLE LAW. EXCEPT WHEN OTHERWISE STATED IN WRITING THE COPYRIGHT HOLDERS AND/OR OTHER PARTIES PROVIDE THE PROGRAM "AS IS" WITHOUT WARRANTY OF ANY KIND, EITHER EXPRESSED OR IMPLIED, INCLUDING, BUT NOT LIMITED TO, THE IMPLIED WARRANTIES OF MERCHANTABILITY AND FITNESS FOR A PARTICULAR PURPOSE. THE ENTIRE RISK AS TO THE QUALITY AND PERFORMANCE OF THE PROGRAM IS WITH YOU. SHOULD THE PROGRAM PROVE DEFECTIVE, YOU ASSUME THE COST OF ALL NECESSARY SERVICING, REPAIR OR CORRECTION.

12. IN NO EVENT UNLESS REQUIRED BY APPLICABLE LAW OR AGREED TO IN WRITING WILL ANY COPYRIGHT HOLDER, OR ANY OTHER PARTY WHO MAY MODIFY AND/OR REDISTRIBUTE THE PROGRAM AS PERMITTED ABOVE, BE LIABLE TO YOU FOR DAMAGES, INCLUDING ANY GENERAL, SPECIAL, INCIDENTAL OR CONSEQUENTIAL DAMAGES ARISING OUT OF THE USE OR INABILITY TO USE THE PROGRAM (INCLUDING BUT NOT LIMITED TO LOSS OF DATA OR DATA BEING RENDERED INACCURATE OR LOSSES SUSTAINED BY YOU OR THIRD PARTIES OR A FAILURE OF THE PROGRAM TO OPERATE WITH ANY OTHER PROGRAMS), EVEN IF SUCH HOLDER OR OTHER PARTY HAS BEEN ADVISED OF THE POSSIBILITY OF SUCH DAMAGES.

END OF TERMS AND CONDITIONS

Appendix L – GNU LGPL 2.1

GNU LESSER GENERAL PUBLIC LICENSE

Version 2.1, February 1999

Copyright (C) 1991, 1999 Free Software Foundation, Inc.

59 Temple Place, Suite 330, Boston, MA 02111-1307 USA

Everyone is permitted to copy and distribute verbatim copies of this license document, but changing it is not allowed.

[This is the first released version of the Lesser GPL. It also counts as the successor of the GNU Library Public License, version 2, hence the version number 2.1.]

Preamble

The licenses for most software are designed to take away your freedom to share and change it. By contrast, the GNU General Public Licenses are intended to guarantee your freedom to share and change free software—to make sure the software is free for all its users.

This license, the Lesser General Public License, applies to some specially designated software packages—typically libraries—of the Free Software Foundation and other authors who decide to use it. You can use it too, but we suggest you first think carefully about whether this license or the ordinary General Public License is the better strategy to use in any particular case, based on the explanations below.

When we speak of free software, we are referring to freedom of use, not price. Our General Public Licenses are designed to make sure that you have the freedom to distribute copies of free software (and charge for this service if you wish); that you receive source code or can get it if you want it; that you can change the software and use pieces of it in new free programs; and that you are informed that you can do these things.

To protect your rights, we need to make restrictions that forbid distributors to deny you these rights or to ask you to surrender these rights. These restrictions translate to certain responsibilities for you if you distribute copies of the library or if you modify it.

For example, if you distribute copies of the library, whether gratis or for a fee, you must give the recipients all the rights that we gave you. You must make sure that they, too, receive or can get the source code. If you link other code with the library, you must provide complete object files to the recipients, so that they can relink them with the library after making changes to the library and recompiling it. And you must show them these terms so they know their rights.

We protect your rights with a two-step method: (1) we copyright the library, and (2) we offer you this license, which gives you legal permission to copy, distribute and/or modify the library.

To protect each distributor, we want to make it very clear that there is no warranty for the free library. Also, if the library is modified by someone else and passed on, the recipients should know that what they have is not the original version, so that the original author's reputation will not be affected by problems that might be introduced by others.

Finally, software patents pose a constant threat to the existence of any free program. We wish to make sure that a company cannot effectively restrict the users of a free program by obtaining a restrictive license from a patent holder. Therefore, we insist that any patent license obtained for a version of the library must be consistent with the full freedom of use specified in this license.

Most GNU software, including some libraries, is covered by the ordinary GNU General Public License. This license, the GNU Lesser General Public License, applies to certain designated libraries, and is quite different from the ordinary General Public License. We use this license for certain libraries in order to permit linking those libraries into non-free programs.

When a program is linked with a library, whether statically or using a shared library, the combination of the two is legally speaking a combined work, a derivative of the original library. The ordinary General Public License therefore permits such linking only if the entire combination fits its criteria of freedom. The Lesser General Public License permits more lax criteria for linking other code with the library.

We call this license the "Lesser" General Public License because it does Less to protect the user's freedom than the ordinary General Public License. It also provides other free software developers Less of an advantage over competing non-free programs. These disadvantages are the reason we use the ordinary General Public License for many libraries. However, the Lesser license provides advantages in certain special circumstances.

For example, on rare occasions, there may be a special need to encourage the widest possible use of a certain library, so that it becomes a de-facto standard. To achieve this, non-free programs must be allowed to use the library. A more frequent case is that a free library does the same job as widely used non-free libraries. In this case, there is little to gain by limiting the free library to free software only, so we use the Lesser General Public License.

In other cases, permission to use a particular library in non-free programs enables a greater number of people to use a large body of free software. For example, permission to use the GNU C Library in non-free programs enables many more people to use the whole GNU operating system, as well as its variant, the GNU/Linux operating system.

Although the Lesser General Public License is Less protective of the users' freedom, it does ensure that the user of a program that is linked with the Library has the freedom and the wherewithal to run that program using a modified version of the Library.

The precise terms and conditions for copying, distribution and modification follow. Pay close attention to the difference between a "work based on the library" and a "work that uses the library". The former contains code derived from the library, whereas the latter must be combined with the library in order to run.

GNU LESSER GENERAL PUBLIC LICENSE

TERMS AND CONDITIONS FOR COPYING, DISTRIBUTION AND MODIFICATION

0. This License Agreement applies to any software library or other program which contains a notice placed by the copyright holder or other authorized party saying it may be distributed under the terms of this Lesser General Public License (also called "this License"). Each licensee is addressed as "you".

A "library" means a collection of software functions and/or data prepared so as to be conveniently linked with application programs (which use some of those functions and data) to form executables.

The "Library", below, refers to any such software library or work which has been distributed under these terms. A "work based on the Library" means either the Library or any derivative work under copyright law: that is to say, a work containing the Library or a portion of it, either verbatim or with modifications and/or translated straightforwardly into another language. (Hereinafter, translation is included without limitation in the term "modification".)

"Source code" for a work means the preferred form of the work for making modifications to it. For a library, complete source code means all the source code for all modules it contains, plus any associated interface definition files, plus the scripts used to control compilation and installation of the library.

OTHERS

Others

Activities other than copying, distribution and modification are not covered by this License; they are outside its scope. The act of running a program using the Library is not restricted, and output from such a program is covered only if its contents constitute a work based on the Library (independent of the use of the Library in a tool for writing it). Whether that is true depends on what the Library does and what the program that uses the Library does.

1. You may copy and distribute verbatim copies of the Library's complete source code as you receive it, in any medium, provided that you conspicuously and appropriately publish on each copy an appropriate copyright notice and disclaimer of warranty; keep intact all the notices that refer to this License and to the absence of any warranty; and distribute a copy of this License along with the Library.

You may charge a fee for the physical act of transferring a copy, and you may at your option offer warranty protection in exchange for a fee.

2. You may modify your copy or copies of the Library or any portion of it, thus forming a work based on the Library, and copy and distribute such modifications or work under the terms of Section 1 above, provided that you also meet all of these conditions:

- a) The modified work must itself be a software library.
- b) You must cause the files modified to carry prominent notices stating that you changed the files and the date of any change.
- c) You must cause the whole of the work to be licensed at no charge to all third parties under the terms of this License.
- d) If a facility in the modified Library refers to a function or a table of data to be supplied by an application program that uses the facility, other than as an argument passed when the facility is invoked, then you must make a good faith effort to ensure that, in the event an application does not supply such function or table, the facility still operates, and performs whatever part of its purpose remains meaningful.

(For example, a function in a library to compute square roots has a purpose that is entirely well-defined independent of the application. Therefore, Subsection 2d requires that any application-supplied function or table used by this function must be optional: if the application does not supply it, the square root function must still compute square roots.)

These requirements apply to the modified work as a whole. If identifiable sections of that work are not derived from the Library, and can be reasonably considered independent and separate works in themselves, then this License, and its terms, do not apply to those sections when you distribute them as separate works. But when you distribute the same sections as part of a whole which is a work based on the Library, the distribution of the whole must be on the terms of this License, whose permissions for other licensees extend to the entire whole, and thus to each and every part regardless of who wrote it.

Thus, it is not the intent of this section to claim rights or contest your rights to work written entirely by you; rather, the intent is to exercise the right to control the distribution of derivative or collective works based on the Library.

In addition, mere aggregation of another work not based on the Library with the Library (or with a work based on the Library) on a volume of a storage or distribution medium does not bring the other work under the scope of this License.

3. You may opt to apply the terms of the ordinary GNU General Public License instead of this License to a given copy of the Library. To do this, you must alter all the notices that refer to this License, so that they refer to the ordinary GNU General Public License, version 2, instead of to this License. (If a newer version than version 2 of the ordinary GNU General Public License has appeared, then you can specify that version instead if you wish.) Do not make any other change in these notices.

Once this change is made in a given copy, it is irreversible for that copy, so the ordinary GNU General Public License applies to all subsequent copies and derivative works made from that copy.

This option is useful when you wish to copy part of the code of the Library into a program that is not a library.

4. You may copy and distribute the Library (or a portion or derivative of it, under Section 2) in object code or executable form under the terms of Sections 1 and 2 above provided that you accompany it with the complete corresponding machine-readable source code, which must be distributed under the terms of Sections 1 and 2 above on a medium customarily used for software interchange.

If distribution of object code is made by offering access to copy from a designated place, then offering equivalent access to copy the source code from the same place satisfies the requirement to distribute the source code, even though third parties are not compelled to copy the source along with the object code.

5. A program that contains no derivative of any portion of the Library, but is designed to work with the Library by being compiled or linked with it, is called a "work that uses the Library". Such a work, in isolation, is not a derivative work of the Library, and therefore falls outside the scope of this License.

However, linking a "work that uses the Library" with the Library creates an executable that is a derivative of the Library (because it contains portions of the Library), rather than a "work that uses the library". The executable is therefore covered by this License. Section 6 states terms for distribution of such executables.

When a "work that uses the Library" uses material from a header file that is part of the Library, the object code for the work may be a derivative work of the Library even though the source code is not.

Whether this is true is especially significant if the work can be linked without the Library, or if the work is itself a library. The threshold for this to be true is not precisely defined by law.

If such an object file uses only numerical parameters, data structure layouts and accessors, and small macros and small inline functions (ten lines or less in length), then the use of the object file is unrestricted, regardless of whether it is legally a derivative work. (Executables containing this object code plus portions of the Library will still fall under Section 6.)

Otherwise, if the work is a derivative of the Library, you may distribute the object code for the work under the terms of Section 6. Any executables containing that work also fall under Section 6, whether or not they are linked directly with the Library itself.

6. As an exception to the Sections above, you may also combine or link a "work that uses the Library" with the Library to produce a work containing portions of the Library, and distribute that work under terms of your choice, provided that the terms permit modification of the work for the customer's own use and reverse engineering for debugging such modifications.

You must give prominent notice with each copy of the work that the Library is used in it and that the Library and its use are covered by this License. You must supply a copy of this License. If the work during execution displays copyright notices, you must include the copyright notice for the Library among them, as well as a reference directing the user to the copy of this License. Also, you must do one of these things:

- a) Accompany the work with the complete corresponding machine-readable source code for the Library including whatever changes were used in the work (which must be distributed under Sections 1 and 2 above); and, if the work is an executable linked with the Library, with the complete machine-readable "work that uses the Library", as object code and/or source code, so that the user can modify the Library and then relink to produce a modified executable containing the modified Library. (It is understood that the user who changes the contents of definitions files in the Library will not necessarily be able to recompile the application to use the modified definitions.)
- b) Use a suitable shared library mechanism for linking with the Library. A suitable mechanism is one that (1) uses at run time a copy of the library already present on the user's computer system, rather than copying library functions into the executable, and (2) will operate properly with a modified version of the library, if the user installs one, as long as the modified version is interface-compatible with the version that the work was made with.



- c) Accompany the work with a written offer, valid for at least three years, to give the same user the materials specified in Subsection 6a, above, for a charge no more than the cost of performing this distribution.
- d) If distribution of the work is made by offering access to copy from a designated place, offer equivalent access to copy the above specified materials from the same place.
- e) Verify that the user has already received a copy of these materials or that you have already sent this user a copy.

For an executable, the required form of the "work that uses the Library" must include any data and utility programs needed for reproducing the executable from it. However, as a special exception, the materials to be distributed need not include anything that is normally distributed (in either source or binary form) with the major components (compiler, kernel, and so on) of the operating system on which the executable runs, unless that component itself accompanies the executable.

It may happen that this requirement contradicts the license restrictions of other proprietary libraries that do not normally accompany the operating system. Such a contradiction means you cannot use both them and the Library together in an executable that you distribute.

7. You may place library facilities that are a work based on the Library side-by-side in a single library together with other library facilities not covered by this License, and distribute such a combined library, provided that the separate distribution of the work based on the Library and of the other library facilities is otherwise permitted, and provided that you do these two things:

- a) Accompany the combined library with a copy of the same work based on the Library, uncombined with any other library facilities. This must be distributed under the terms of the Sections above.
- b) Give prominent notice with the combined library of the fact that part of it is a work based on the Library, and explaining where to find the accompanying uncombined form of the same work.

8. You may not copy, modify, sublicense, link with, or distribute the Library except as expressly provided under this License. Any attempt otherwise to copy, modify, sublicense, link with, or distribute the Library is void, and will automatically terminate your rights under this License. However, parties who have received copies, or rights, from you under this License will not have their licenses terminated so long as such parties remain in full compliance.

9. You are not required to accept this License, since you have not signed it. However, nothing else grants you permission to modify or distribute the Library or its derivative works. These actions are prohibited by law if you do not accept this License. Therefore, by modifying or distributing the Library (or any work based on the Library), you indicate your acceptance of this License to do so, and all its terms and conditions for copying, distributing or modifying the Library or works based on it.

10. Each time you redistribute the Library (or any work based on the Library), the recipient automatically receives a license from the original licensor to copy, distribute, link with or modify the Library subject to these terms and conditions. You may not impose any further restrictions on the recipients' exercise of the rights granted herein. You are not responsible for enforcing compliance by third parties with this License.

11. If, as a consequence of a court judgment or allegation of patent infringement or for any other reason (not limited to patent issues), conditions are imposed on you (whether by court order, agreement or otherwise) that contradict the conditions of this License, they do not excuse you from the conditions of this License. If you cannot distribute so as to satisfy simultaneously your obligations under this License and any other pertinent obligations, then as a consequence you may not distribute the Library at all. For example, if a patent license would not permit royalty-free redistribution of the Library by all those who receive copies directly or indirectly through you, then the only way you could satisfy both it and this License would be to refrain entirely from distribution of the Library.

If any portion of this section is held invalid or unenforceable under any particular circumstance, the balance of the section is intended to apply, and the section as a whole is intended to apply in other circumstances.

It is not the purpose of this section to induce you to infringe any patents or other property right claims or to contest validity of any such claims; this section has the sole purpose of protecting the integrity of the free software distribution system which is implemented by public license practices. Many people have made generous contributions to the wide range of software distributed through that system in reliance on consistent application of that system; it is up to the author/donor to decide if he or she is willing to distribute software through any other system and a licensee cannot impose that choice.

This section is intended to make thoroughly clear what is believed to be a consequence of the rest of this License.

12. If the distribution and/or use of the Library is restricted in certain countries either by patents or by copyrighted interfaces, the original copyright holder who places the Library under this License may add an explicit geographical distribution limitation excluding those countries, so that distribution is permitted only in or among countries not thus excluded. In such case, this License incorporates the limitation as if written in the body of this License.

13. The Free Software Foundation may publish revised and/or new versions of the Lesser General Public License from time to time. Such new versions will be similar in spirit to the present version, but may differ in detail to address new problems or concerns.

Each version is given a distinguishing version number. If the Library specifies a version number of this License which applies to it and "any later version", you have the option of following the terms and conditions either of that version or of any later version published by the Free Software Foundation. If the Library does not specify a license version number, you may choose any version ever published by the Free Software Foundation.

14. If you wish to incorporate parts of the Library into other free programs whose distribution conditions are incompatible with these, write to the author to ask for permission. For software which is copyrighted by the Free Software Foundation, write to the Free Software Foundation; we sometimes make exceptions for this. Our decision will be guided by the two goals of preserving the free status of all derivatives of our free software and of promoting the sharing and reuse of software generally.

NO WARRANTY

15. BECAUSE THE LIBRARY IS LICENSED FREE OF CHARGE, THERE IS NO WARRANTY FOR THE LIBRARY, TO THE EXTENT PERMITTED BY APPLICABLE LAW. EXCEPT WHEN OTHERWISE STATED IN WRITING THE COPYRIGHT HOLDERS AND/OR OTHER PARTIES PROVIDE THE LIBRARY "AS IS" WITHOUT WARRANTY OF ANY KIND, EITHER EXPRESSED OR IMPLIED, INCLUDING, BUT NOT LIMITED TO, THE IMPLIED WARRANTIES OF MERCHANTABILITY AND FITNESS FOR A PARTICULAR PURPOSE. THE ENTIRE RISK AS TO THE QUALITY AND PERFORMANCE OF THE LIBRARY IS WITH YOU. SHOULD THE LIBRARY PROVE DEFECTIVE, YOU ASSUME THE COST OF ALL NECESSARY SERVICING, REPAIR OR CORRECTION.

16. IN NO EVENT UNLESS REQUIRED BY APPLICABLE LAW OR AGREED TO IN WRITING WILL ANY COPYRIGHT HOLDER, OR ANY OTHER PARTY WHO MAY MODIFY AND/OR REDISTRIBUTE THE LIBRARY AS PERMITTED ABOVE, BE LIABLE TO YOU FOR DAMAGES, INCLUDING ANY GENERAL, SPECIAL, INCIDENTAL OR CONSEQUENTIAL DAMAGES ARISING OUT OF THE USE OR INABILITY TO USE THE LIBRARY (INCLUDING BUT NOT LIMITED TO LOSS OF DATA OR DATA BEING RENDERED INACCURATE OR LOSSES SUSTAINED BY YOU OR THIRD PARTIES OR A FAILURE OF THE LIBRARY TO OPERATE WITH ANY OTHER SOFTWARE), EVEN IF SUCH HOLDER OR OTHER PARTY HAS BEEN ADVISED OF THE POSSIBILITY OF SUCH DAMAGES.

END OF TERMS AND CONDITIONS

OTHERS



How to Apply These Terms to Your New Libraries

If you develop a new library, and you want it to be of the greatest possible use to the public, we recommend making it free software that everyone can redistribute and change. You can do so by permitting redistribution under these terms (or, alternatively, under the terms of the ordinary General Public License).

To apply these terms, attach the following notices to the library. It is safest to attach them to the start of each source file to most effectively convey the exclusion of warranty; and each file should have at least the "copyright" line and a pointer to where the full notice is found.

<one line to give the library's name and a brief idea of what it does.>

Copyright (C) <year> <name of author>

This library is free software; you can redistribute it and/or modify it under the terms of the GNU Lesser General Public License as published by the Free Software Foundation; either version 2.1 of the License, or (at your option) any later version.

This library is distributed in the hope that it will be useful, but WITHOUT ANY WARRANTY; without even the implied warranty of MERCHANTABILITY or FITNESS FOR A PARTICULAR PURPOSE. See the GNU Lesser General Public License for more details.

You should have received a copy of the GNU Lesser General Public License along with this library; if not, write to the Free Software Foundation, Inc., 59 Temple Place, Suite 330, Boston, MA 02111-1307 USA

Also add information on how to contact you by electronic and paper mail. You should also get your employer (if you work as a programmer) or your school, if any, to sign a "copyright disclaimer" for the library, if necessary. Here is a sample; alter the names:

Yoyodyne, Inc., hereby disclaims all copyright interest in the library 'Frob' (a library for tweaking knobs) written by James Random Hacker.

<signature of Ty Coon>, 1 April 1990

Ty Coon, President of Vice

That's all there is to it!

Appendix M – BSD-New

/*

Copyright (c) 1988, 1989, 1990, 1991, 1992, 1993, 1994, 1995, 1996, 1997

The Regents of the University of California. All rights reserved.

Redistribution and use in source and binary forms, with or without modification, are permitted provided that: (1) source code distributions retain the above copyright notice and this paragraph in its entirety, (2) distributions including binary code include the above copyright notice and this paragraph in its entirety in the documentation or other materials provided with the distribution, and (3) all advertising materials mentioning features or use of this software display the following acknowledgement:

"This product includes software developed by the University of California, Lawrence Berkeley Laboratory and its contributors." Neither the name of the University nor the names of its contributors may be used to endorse or promote products derived from this software without specific prior written permission.

THIS SOFTWARE IS PROVIDED "AS IS" AND WITHOUT ANY EXPRESS OR IMPLIED WARRANTIES, INCLUDING, WITHOUT LIMITATION, THE IMPLIED WARRANTIES OF MERCHANTABILITY AND FITNESS FOR A PARTICULAR PURPOSE.

*/

Appendix N – CinemaNow

Third Party Requirements

a. gSOAP.

The following notice is applicable to the CinemaNow SDK. Company is required to include such notice in the documentation for any Embedded Products it distributes.

Part of the software embedded in this product is gSOAP software.

Portions created by gSOAP are Copyright (C) 2001-2004 Robert A. van Engelen, Genivia Inc. All Rights Reserved.

THE SOFTWARE IN THIS PRODUCT WAS IN PART PROVIDED BY GENIVIA INC AND ANY EXPRESS OR IMPLIED WARRANTIES, INCLUDING, BUT NOT LIMITED TO, THE IMPLIED WARRANTIES OF MERCHANTABILITY AND FITNESS FOR A PARTICULAR PURPOSE ARE DISCLAIMED. IN NO EVENT SHALL THE AUTHOR BE LIABLE FOR ANY DIRECT, INDIRECT, INCIDENTAL, SPECIAL, EXEMPLARY, OR CONSEQUENTIAL DAMAGES (INCLUDING, BUT NOT LIMITED TO, PROCUREMENT OF SUBSTITUTE GOODS OR SERVICES; LOSS OF USE, DATA, OR PROFITS; OR BUSINESS INTERRUPTION) HOWEVER CAUSED AND ON ANY THEORY OF LIABILITY, WHETHER IN CONTRACT, STRICT LIABILITY, OR TORT (INCLUDING NEGLIGENCE OR OTHERWISE) ARISING IN ANY WAY OUT OF THE USE OF THIS SOFTWARE, EVEN IF ADVISED OF THE POSSIBILITY OF SUCH DAMAGE.

b. [THE CODE IS BEING PROVIDED IN OBJECT CODE SO THE ABOVE DOESN'T APPLY]

c. Curl/ 7.12.2

COPYRIGHT AND PERMISSION NOTICE

Copyright (c) 1996 - 2009, Daniel Stenberg, <daniel@haxx.se>.

All rights reserved.

Permission to use, copy, modify, and distribute this software for any purpose with or without fee is hereby granted, provided that the above copyright notice and this permission notice appear in all copies.

THE SOFTWARE IS PROVIDED "AS IS", WITHOUT WARRANTY OF ANY KIND, EXPRESS OR IMPLIED, INCLUDING BUT NOT LIMITED TO THE WARRANTIES OF MERCHANTABILITY, FITNESS FOR A PARTICULAR PURPOSE AND NONINFRINGEMENT OF THIRD PARTY RIGHTS. IN NO EVENT SHALL THE AUTHORS OR COPYRIGHT HOLDERS BE LIABLE FOR ANY CLAIM, DAMAGES OR OTHER LIABILITY, WHETHER IN AN ACTION OF CONTRACT, TORT OR OTHERWISE, ARISING FROM, OUT OF OR IN CONNECTION WITH THE SOFTWARE OR THE USE OR OTHER DEALINGS IN THE SOFTWARE.

Except as contained in this notice, the name of a copyright holder shall not be used in advertising or otherwise to promote the sale, use or other dealings in this Software without prior written authorization of the copyright holder.

d. C-ARES 1.6.0

Copyright 1998 by the Massachusetts Institute of Technology.

Permission to use, copy, modify, and distribute this software and its documentation for any purpose and without fee is hereby granted, provided that the above copyright notice appear in all copies and that both that copyright notice and this permission notice appear in supporting documentation, and that the name of M.I.T. not be used in advertising or publicity pertaining to distribution of the software without specific, written prior permission. M.I.T. makes no representations about the suitability of this software for any purpose. It is provided "as is" without express or implied warranty.

e. OpenSSL 0.9.5a

Original SSLey License

Copyright (C) 1995-1998 Eric Young (eay@cryptsoft.com) All rights reserved.

This package is an SSL implementation written by Eric Young (eay@cryptsoft.com). The implementation was written so as to conform with Netscape's SSL. This library is free for commercial and non-commercial use as long as the following conditions are adhered to. The following conditions apply to all code found in this distribution, be it the RC4, RSA, lhash, DES, etc., code; not just the SSL code. The SSL documentation included with this distribution is covered by the same copyright terms except that the holder is Tim Hudson (tjh@cryptsoft.com).

Copyright remains Eric Young's, and as such any Copyright notices in the code are not to be removed. If this package is used in a product, Eric Young should be given attribution as the author of the parts of the library used. This can be in the form of a textual message at program startup or in documentation (online or textual) provided with the package.

Redistribution and use in source and binary forms, with or without modification, are permitted provided that the following conditions are met:

1. Redistributions of source code must retain the copyright notice, this list of conditions and the following disclaimer.
2. Redistributions in binary form must reproduce the above copyright notice, this list of conditions and the following disclaimer in the documentation and/or other materials provided with the distribution.
3. All advertising materials mentioning features or use of this software must display the following acknowledgement: "This product includes cryptographic software written by Eric Young (eay@cryptsoft.com)" The word 'cryptographic' can be left out if the routines from the library being used are not cryptographic related :-).
4. If you include any Windows specific code (or a derivative thereof) from the apps directory (application code) you must include an acknowledgement: "This product includes software written by Tim Hudson (tjh@cryptsoft.com)"

THIS SOFTWARE IS PROVIDED BY ERIC YOUNG "AS IS" AND ANY EXPRESS OR IMPLIED WARRANTIES, INCLUDING, BUT NOT LIMITED TO, THE IMPLIED WARRANTIES OF MERCHANTABILITY AND FITNESS FOR A PARTICULAR PURPOSE ARE DISCLAIMED. IN NO EVENT SHALL THE AUTHOR OR CONTRIBUTORS BE LIABLE FOR ANY DIRECT, INDIRECT, INCIDENTAL, SPECIAL, EXEMPLARY, OR CONSEQUENTIAL DAMAGES (INCLUDING, BUT NOT LIMITED TO, PROCUREMENT OF SUBSTITUTE GOODS OR SERVICES; LOSS OF USE, DATA, OR PROFITS; OR BUSINESS INTERRUPTION) HOWEVER CAUSED AND ON ANY THEORY OF LIABILITY, WHETHER IN CONTRACT, STRICT LIABILITY, OR TORT (INCLUDING NEGLIGENCE OR OTHERWISE) ARISING IN ANY WAY OUT OF THE USE OF THIS SOFTWARE, EVEN IF ADVISED OF THE POSSIBILITY OF SUCH DAMAGE.

The license and distribution terms for any publicly available version or derivative of this code cannot be changed. i.e. this code cannot simply be copied and put under another distribution license [including the GNU Public License.]

Content owners use Windows Media digital rights management technology (WMDRM) to protect their intellectual property, including copyrights. This device uses WMDRM software to access WMDRM-protected content. If the WMDRM software fails to protect the content, content owners may ask Microsoft to revoke the software's ability to use WMDRM to play or copy protected content. Revocation does not affect unprotected content. When you download licenses for protected content, you agree that Microsoft may include a revocation list with the licenses. Content owners may require you to upgrade WMDRM to access their content. If you decline an upgrade, you will not be able to access content that requires the upgrade.

OTHERS



NEED HELP?

**PLEASE CONTACT US FOR HELP,
IF YOU REQUIRE ASSISTANCE
IN SET-UP OR OPERATION.**

If you are experiencing a technical problem or have questions regarding operation, authorized service centers, warranty or parts, then please contact our Customer Service Department at:

1-(800) 631-3811

For DVD product questions, including Single DVD players, Single Blu-ray™ players, DVD/VCR Combos, Portable DVD players and LCD TV/DVD Combos, please call:

1-(866) 583-7353

For DVD Recorders, please call:

1-(800) 319-6684

We are available to answer all of your questions
Monday – Friday 10:00am to 7:00pm EST

Many questions regarding parts, service and warranties can be answered by visiting the Customer Support section of our website:
support.toshiba.com

THANK YOU

TOSHIBA
Leading Innovation >>>

Printed in China

811-BD5291W011

Free Manuals Download Website

<http://myh66.com>

<http://usermanuals.us>

<http://www.somanuals.com>

<http://www.4manuals.cc>

<http://www.manual-lib.com>

<http://www.404manual.com>

<http://www.luxmanual.com>

<http://aubethermostatmanual.com>

Golf course search by state

<http://golfingnear.com>

Email search by domain

<http://emailbydomain.com>

Auto manuals search

<http://auto.somanuals.com>

TV manuals search

<http://tv.somanuals.com>