

Portégé® 2000 User's Guide

If you need assistance:

❖ VirtualTech™

<http://virtualtech.toshiba.com>

❖ InTouch® Center

Calling within the United States (800) 457-7777

Calling from outside the United States (949) 859-4273

For more information, see [Chapter 8](#) on [page 148](#).

TOSHIBA

C6609-1201M1

Model: Portégé 2000

Compact Disk-ReWritable

The computer system you purchased may include a Compact Disk-ReWritable (CD-RW), one of the most advanced storage technologies available. As with any new technology, you must read and follow all set-up and usage instructions in the applicable user guides and/or manuals enclosed. If you fail to do so, this product may not function properly and you may lose data or suffer other damage. **TOSHIBA AMERICA INFORMATION SYSTEMS (“TOSHIBA”), ITS AFFILIATES AND SUPPLIERS DO NOT WARRANT THAT OPERATION OF THE PRODUCT WILL BE UNINTERRUPTED OR ERROR FREE. YOU AGREE THAT TOSHIBA, ITS AFFILIATES AND SUPPLIERS SHALL HAVE NO RESPONSIBILITY FOR DAMAGE TO OR LOSS OF ANY BUSINESS, PROFITS, PROGRAMS, DATA OR REMOVABLE STORAGE MEDIA ARISING OUT OF OR RESULTING FROM THE USE OF THE PRODUCT, EVEN IF ADVISED OF THE POSSIBILITY THEREOF.**

Protection of Stored Data

For your important data, please make periodic back-up copies of all the data stored on the hard disk or other storage devices as a precaution against possible failures, alteration, or loss of the data. **IF YOUR DATA IS ALTERED OR LOST DUE TO ANY TROUBLE, FAILURE OR MALFUNCTION OF THE HARD DISK DRIVE OR OTHER STORAGE DEVICES AND THE DATA CANNOT BE RECOVERED, TOSHIBA SHALL NOT BE LIABLE FOR ANY DAMAGE OR LOSS OF DATA, OR ANY OTHER DAMAGE RESULTING THEREFROM. WHEN COPYING OR TRANSFERRING YOUR DATA, PLEASE BE SURE TO CONFIRM WHETHER THE DATA HAS BEEN SUCCESSFULLY COPIED OR TRANSFERRED. TOSHIBA DISCLAIMS ANY LIABILITY FOR THE FAILURE TO COPY OR TRANSFER THE DATA CORRECTLY.**

Critical Applications

The computer you have purchased is not designed for any “critical applications.” “Critical applications” means life support systems, medical applications, connections to implanted medical devices, commercial transportation, nuclear facilities or systems or any other applications where product failure could lead to injury to persons or loss of life or catastrophic property damage. **ACCORDINGLY, TOSHIBA, ITS AFFILIATES AND SUPPLIERS DISCLAIM ANY AND ALL LIABILITY**

ARISING OUT OF THE USE OF THE COMPUTER PRODUCTS IN ANY CRITICAL APPLICATIONS. IF YOU USE THE COMPUTER PRODUCTS IN A CRITICAL APPLICATION, YOU, AND NOT TOSHIBA, ASSUME FULL RESPONSIBILITY FOR SUCH USE.

FCR Notice

This equipment has been tested and found to comply with the limits for a Class B digital device, pursuant to Part 15 of the FCC rules. These limits are designed to provide reasonable protection against harmful interference in a residential installation.

This equipment generates, uses and can radiate radio frequency energy and, if not installed and used in accordance with the instructions, it may cause harmful interference to radio communications. However, there is no guarantee that interference will not occur in a particular installation. If this equipment does cause harmful interference to radio or television reception, which can be determined by turning the equipment off and on, the user is encouraged to try to correct the interference by one or more of the following measures:

- ❖ Reorient or relocate the receiving antenna.
- ❖ Increase the separation between the equipment and receiver.
- ❖ Connect the equipment to an outlet on a circuit different from that to which the receiver is connected.
- ❖ Consult the dealer or an experienced radio/TV technician for help.



NOTE: Only peripherals complying with the FCC Class B limits may be attached to this computer. Operation with non-compliant peripherals or peripherals not recommended by Toshiba is likely to result in interference to radio and TV reception. Shielded cables must be used between the external devices and the computer's USB port and microphone jack. Changes or modifications made to this equipment not expressly approved by Toshiba or parties authorized by Toshiba could void the user's authority to operate the equipment.

This device complies with Part 15 of the FCC Rules. Operation is subject to the following two conditions:

- ❖ This device may not cause harmful interference.

4

- ❖ This device must accept any interference received, including interference that may cause undesired operation.

Contact:

Toshiba America Information Systems, Inc.
9740 Irvine Blvd.
Irvine, CA 92618-1697
(949) 583-3000

Industry Canada Requirement

This Class B digital apparatus complies with Canadian ICES-003.

Cet appareil numérique de la classe B est conforme à la norme NMB-003 du Canada.

FCC Requirements

The following information is pursuant to FCC CFR 47, Part 68 and refers to internal modems.

Installation

When you are ready to install or use the modem, call your local telephone company and give them the following information:

- ❖ The telephone number of the line to which you will connect the modem.
- ❖ The FCC registration number of the modem.
- ❖ The ringer equivalence number (REN) of the modem, which is 0.3B.

The modem connects to the telephone line by means of a standard jack called the USOC RJ11C.

Type of Service

Your modem is designed to be used on standard-device telephone lines. Connection to telephone company-provided coin service (central office implemented systems) is prohibited. Connection to party lines service is subject to State tariffs. If you have any questions about your telephone line, such as how many pieces of equipment you can connect to it, the telephone company will provide this information upon request.

Telephone Company Procedures

The goal of the telephone company is to provide you with the best service it can. In order to do this, it may occasionally be necessary for them to make changes in their equipment, operations or procedures. If these changes

might affect your service or the operation of your equipment, the telephone company will give you notice, in writing, to allow you to make any changes necessary to maintain uninterrupted service.

If Problems Arise

If any of your telephone equipment is not operating properly, you should immediately remove it from your telephone line, as it may cause harm to the telephone network. If the telephone company notes a problem, they may temporarily discontinue service. When practical, they will notify you in advance of this disconnection. If advance notice is not feasible, you will be notified as soon as possible. When you are notified, you will be given the opportunity to correct the problem and informed of your right to file a complaint with the FCC. In the event repairs are ever needed on your modem, they should be performed by Toshiba Corporation, Toshiba America Information Systems, Inc. or an authorized representative of Toshiba.

Disconnection

If you should ever decide to permanently disconnect your modem from its present line, please call the telephone company and let them know of this change.

Fax Branding

The Telephone Consumer Protection Act of 1991 makes it unlawful to use a computer or other electronic device to send any message via a telephone fax machine unless such message clearly contains in a margin at the top or bottom of each transmitted page or on the first page of the transmission, the date and time it is sent and an identification of the business, other entity or individual sending the message and the telephone number of the sending machine or such business, other entity or individual.

In order to program this information into your fax modem, you should complete the setup for your fax software before sending a message.

Instructions for IC CS-03 certified equipment

- 1** NOTICE: The Industry Canada label identifies certified equipment. This certification means that the equipment meets certain telecommunications network protective, operational and safety requirements as prescribed in the appropriate Terminal Equipment Technical Requirements document(s). The Department does not guarantee the equipment will operate to the user's satisfaction.

Before installing this equipment, users should ensure that it is permissible to be connected to the facilities of the local telecommunications company. The equipment must also be installed

using an acceptable method of connection. The customer should be aware that compliance with the above conditions may not prevent degradation of service in some situations.

Repairs to certified equipment should be coordinated by a representative designated by the supplier. Any repairs or alterations made by the user to this equipment, or equipment malfunctions, may give the telecommunications company cause to request the user to disconnect the equipment.

Users should ensure for their own protection that the electrical ground connections of the power utility, telephone lines and internal metallic water pipe system, if present, are connected together. This precaution may be particularly important in rural areas.

Caution: Users should not attempt to make such connections themselves, but should contact the appropriate electric inspection authority, or electrician, as appropriate.

- 2 The user manual of analog equipment must contain the equipment's Ringer Equivalence Number (REN) and an explanation notice similar to the following:

The Ringer Equivalence Number (REN) of this device can be found on the label affixed to your computer.

NOTICE: The Ringer Equivalence Number (REN) assigned to each terminal device provides an indication of the maximum number of terminals allowed to be connected to a telephone interface. The termination on an interface may consist of any combination of devices subject only to the requirement that the sum of the Ringer Equivalence Numbers of all the devices does not exceed 5.

- 3 The standard connecting arrangement (telephone jack type) for this equipment is jack type(s): USOC RJ11C.

Wireless Interoperability

The Toshiba Wireless LAN Mini PCI Card products are designed to be interoperable with any wireless LAN product that is based on Direct Sequence Spread Spectrum (DSSS) radio technology, and is compliant to:

- ❖ The IEEE 802.11 Standard on Wireless LANs (Revision B), as defined and approved by the Institute of Electrical and Electronics Engineers.
- ❖ The Wireless Fidelity (Wi-Fi™) certification as defined by the WECA Wireless Ethernet Compatibility Alliance.

Wireless LAN and your Health

Wireless LAN products, like other radio devices, emit radio frequency electromagnetic energy. The level of energy emitted by Wireless LAN devices however is far much less than the electromagnetic energy emitted by wireless devices like for example mobile phones. Because Wireless LAN products operate within the guidelines found in radio frequency safety standards and recommendations, Toshiba believes Wireless LAN is safe for use by consumers. These standards and recommendations reflect the consensus of the scientific community and result from deliberations of panels and committees of scientists who continually review and interpret the extensive research literature.

In some situations or environments, the use of Wireless LAN may be restricted by the proprietor of the building or responsible representatives of the organization. These situations may for example include:

- ❖ Using the Wireless LAN equipment on board of airplanes, or
- ❖ In any other environment where the risk of interference to other devices or services is perceived or identified as harmful.

If you are uncertain of the policy that applies on the use of wireless devices in a specific organization or environment (e.g., airports), you are encouraged to ask for authorization to use the Wireless LAN device prior to turning on the equipment.

Regulatory Information

The Toshiba Wireless LAN Mini PCI Card must be installed and used in strict accordance with the manufacturer's instructions as described in the user documentation that comes with the product. This device complies with the following radio frequency and safety standards.

Canada – Industry Canada (IC)

This device complies with RSS 210 of Industry Canada.

Operation is subject to the following two conditions: (1) this device may not cause interference, and (2) this device must accept any interference, including interference that may cause undesired operation of this device.

USA-Federal Communications Commission (FCC)

This device complies with Part 15 of FCC Rules. Operation of the devices in a Wireless LAN System is subject to the following two conditions:

- ❖ This device may not cause harmful interference.
- ❖ This device must accept any interference that may cause undesired operation.

Caution: Exposure to Radio Frequency Radiation

The radiated output power of the Toshiba Wireless LAN Mini PCI Card is far below the FCC radio frequency exposure limits. Nevertheless, the Toshiba Wireless LAN Mini PCI Card shall be used in such a manner that the potential for human contact during normal operation is minimized. When using this device in combination with Wireless LAN Outdoor Antenna products, a certain separation distance between antenna and nearby persons has to be kept to ensure RF exposure compliance. The distance between the antennas and the user should not be less than 20.0 cm.

Refer to the Regulatory Statements as identified in the documentation that comes with those products for additional information.

The Toshiba Wireless LAN Mini PCI Card is far below the FCC radio frequency exposure limits.

Nevertheless, it is advised to use the Toshiba Wireless LAN Mini PCI Card in such a manner that human contact during normal operation is minimized.

Interference Statement

This equipment has been tested and found to comply with the limits for a Class B digital device, pursuant to Part 15 of the FCC Rules. These limits are designed to provide reasonable protection against harmful interference in a residential installation. This equipment generates, uses, and can radiate radio frequency energy. If not installed and used in accordance with the instructions, it may cause harmful interference to radio communications. However, there is no guarantee that interference will not occur in a particular installation.

If this equipment does cause harmful interference to radio or television reception, which can be determined by turning the equipment off and on, the user is encouraged to try and correct the interference by one or more of the following measures:

- ❖ Reorient or relocate the receiving antenna.
- ❖ Increase the distance between the equipment and the receiver.
- ❖ Connect the equipment to an outlet on a circuit different from that to which the receiver is connected.
- ❖ Consult the dealer or an experienced radio/TV technician for help.

Toshiba is not responsible for any radio or television interference caused by unauthorized modification of the devices included with this Toshiba Wireless LAN Mini PCI Card, or the substitution or attachment of connecting cables and equipment other than specified by Toshiba.

The correction of interference caused by such unauthorized modification, substitution or attachment will be the responsibility of the user.

Approved Countries for use

This equipment is approved to the radio standard by the countries in Fig.1.

Australia	Austria	Belgium
Canada	Denmark	Finland
France	Germany	Greece
Iceland	Ireland	Italy
Japan	Luxembourg	Mexico
Netherlands	New Zealand	Norway
Poland	Portugal	Spain
Sweden	Switzerland	UK
USA		

Caution: Do not use this equipment except in the countries in Fig.1.

CD-ROM, DVD-ROM, DVD-ROM/CD-RW Safety Instructions

The CD-ROM, DVD-ROM, and DVD-ROM/CD-RW drives employ a laser system. To ensure proper use of this product, please read this instruction manual carefully and retain for future reference. Should the unit ever require maintenance, contact an authorized service location.

Use of controls, adjustments or the performance of procedures other than those specified may result in hazardous radiation exposure.

To prevent direct exposure to the laser beam, do not try to open the enclosure.

Location of the required label

(Sample shown below. (Location of the label and manufacturing information may vary.)

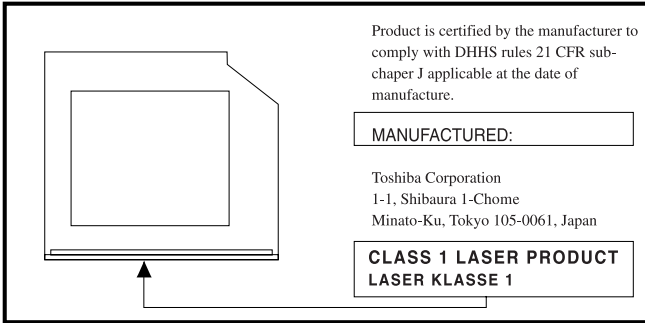

CAUTION: This appliance contains a laser system and is classified as a "CLASS 1 LASER PRODUCT." To use this model properly, read the instruction manual carefully and keep it for your future reference. In case of any trouble with this model, please contact your nearest "AUTHORIZED service station." To prevent direct exposure to the laser beam, do not try to open the enclosure.



Use of controls or adjustments or performance of procedures other than those specified in the owner's manual may result in hazardous radiation exposure.

Copyright

This guide is copyrighted by Toshiba America Information Systems, Inc. with all rights reserved. Under the copyright laws, this guide cannot be reproduced in any form without the prior written permission of Toshiba. No patent liability is assumed, however, with respect to the use of the information contained herein.

©2001 by Toshiba America Information Systems, Inc. All rights reserved.

Export Administration Regulation

This document contains technical data that may be controlled under the U.S. Export Administration Regulations, and may be subject to the approval of the U.S. Department of Commerce prior to export. Any export, directly or indirectly, in contravention of the U.S. Export Administration Regulations is prohibited.

Notice

The information contained in this manual, including but not limited to any product specifications, is subject to change without notice.

TOSHIBA CORPORATION AND TOSHIBA AMERICA INFORMATION SYSTEMS, INC. (TOSHIBA) PROVIDES NO WARRANTY WITH REGARD TO THIS MANUAL OR ANY OTHER INFORMATION CONTAINED HEREIN AND HEREBY EXPRESSLY DISCLAIMS ANY IMPLIED WARRANTIES OF MERCHANTABILITY OR FITNESS FOR ANY PARTICULAR PURPOSE WITH REGARD TO ANY OF THE FOREGOING. TOSHIBA ASSUMES NO LIABILITY FOR ANY DAMAGES INCURRED DIRECTLY OR INDIRECTLY FROM ANY TECHNICAL OR TYPOGRAPHICAL ERRORS OR OMISSIONS CONTAINED HEREIN OR FOR DISCREPANCIES BETWEEN THE PRODUCT AND THE MANUAL. IN NO EVENT SHALL TOSHIBA BE LIABLE FOR ANY INCIDENTAL, CONSEQUENTIAL, SPECIAL, OR EXEMPLARY DAMAGES, WHETHER BASED ON TORT, CONTRACT OR OTHERWISE, ARISING OUT OF OR IN CONNECTION WITH THIS MANUAL OR ANY OTHER INFORMATION CONTAINED HEREIN OR THE USE THEREOF.

Trademarks

Portégé, Noteworthy, Fn-esse and InTouch are registered trademarks, and VirtualTech and SelectServ are trademarks of Toshiba America Information Systems, Inc. and/or Toshiba Corporation.

CompuServe is a registered trademark of America Online, Inc.

Microsoft and Windows are registered trademarks, and Windows Media is a trademark of Microsoft Corporation.

Wi-Fi is a trademark of the Wireless Capability Ethernet Alliance.

TouchPad is a trademark of Synaptics, Inc.

SPANworks is a trademark of SPANworks USA.

All other brand and product names are trademarks or registered trademarks of their respective companies.

Computer Disposal Information

This product contains mercury. Disposal of this material may be regulated due to environmental considerations. For disposal, reuse or recycling information, please contact your local government or the Electronic Industries Alliance at www.eiae.org.

Contents

Introduction	20
This guide	20
Safety icons	21
Other icons used	22
Other documentation	22
Service options	23
Chapter 1: Finding Your Way Around	24
Making sure you have everything	24
Front with the display panel closed	25
Left side	25
Back	26
Right side	27
Underside	28
Front with the display panel open	29
Keyboard indicator panel	31
System indicator panel	31
AC adapter	33
Chapter 2: Getting Started	35
Selecting a place to work	35

Creating a computer-friendly environment.....	35
Keeping yourself comfortable	36
Precautions.....	39
Setting up your computer	40
Installing additional memory (optional)	40
Connecting a mouse	44
Connecting a printer	45
Connecting the modem.....	45
Connecting to a power source	46
Connecting other external devices	48
Using the computer for the first time.....	48
Opening the display panel.....	49
Turning on the power.....	49
Using the TouchPad	50
Setting up your software.....	51
Registering your computer with Toshiba	52
Customizing your computer's settings.....	53
Powering off the computer	54
Closing the display panel	55
Different ways to turn the computer on and off	55
Caring for your computer.....	55
Cleaning the computer	56
Moving the computer.....	56
Using a computer lock	56
Chapter 3: Learning the Basics	58
Computing tips	58
Using the keyboard	60
Ctrl, Fn and Alt keys	60
Character keys	60
Function keys.....	61
Windows® special keys	61
Overlay keys.....	62
Starting a program.....	64

Saving your work	64
Printing your work	65
Using optional external diskettes	65
Inserting and removing diskettes	66
Copying documents to a diskette	66
Taking care of diskettes.....	67
Backing up your work	68
Restoring your work	69
Playing audio	69
Setting up for communications.....	70
Connecting your computer to a network.....	71
An overview of using the Internet	71
The Internet	72
The World Wide Web	72
Internet Service Providers.....	72
Connecting to the Internet	73
Surfing the Internet.....	73
Internet features.....	74
Uploading and downloading files from the Internet.....	74
Toshiba's online resources	75
Chapter 4: Mobile Computing	76
Toshiba's energy-saver design	76
Running the computer on battery power	76
Maximizing battery life	77
Using additional battery packs	77
Battery safety precautions.....	78
Charging batteries.....	78
Charging the main battery.....	78
Charging the RTC battery.....	79
Using a battery charger.....	80
Monitoring main battery power.....	80
Determining remaining battery power.....	81

What to do when the main battery runs low	82
Conserving battery power	83
Setting a power usage mode.....	83
Using battery alarms.....	85
Setting battery alarms.....	85
Turning off the display automatically	86
Enabling the screen saver	86
Changing the main battery	88
Removing the battery from the computer	88
Inserting a charged battery	89
Disposing of used batteries safely	90
Traveling tips.....	91
Chapter 5: Expansion Options.....	92
Using your computer at the office.....	92
Optional Slim Port Replicator	93
Back of the optional Slim Port Replicator	93
Front of the optional Slim Port Replicator.....	93
Using the optional Slim Port Replicator	94
Attaching the optional Slim Port Replicator to the computer	94
Connecting the optional external USB diskette drive.....	95
Using an external keyboard.....	97
Connecting a keyboard	97
Making your external keyboard emulate the Fn key	97
Using an external monitor.....	97
Connecting the monitor	98
Connecting a mouse or a printer.....	99
Using PC Cards.....	99
Inserting a PC Card	100
Removing a PC Card	101

Hot swapping PC Cards	102
Using a Secure Digital card	102
Inserting a Secure Digital card	103
Removing a Secure Digital card	103
Chapter 6: Enhancing Productivity	104
Windows® XP special features	104
Personalizing your desktop	105
Customizing the taskbar	105
Bringing the world to your desktop	106
Changing desktop and browsing style	107
Personalizing individual windows	108
Customizing window toolbars	109
Displaying information about each folder	110
Emulating a full-size keyboard	111
Setting up for communications	112
Determining the COM port	112
Using the Ethernet LAN Port	113
Accessing a LAN	114
Exchanging data with another computer	114
Transferring application files	114
Setting up a direct cable connection	115
Using audio features	116
Using external speakers or headphones	117
Recording sounds	117
Using a microphone	118
Adjusting recording settings	119
Powering down the computer	119
Turn Off or Shut down command	120
Restart command	120
Hibernation command	120
Standby command	121
Using Turn Off or Shut down	122
Turning off more quickly	122

Starting again after Turn Off or Shut down	125
Using Hibernation	125
Enabling the Hibernation command	125
Going into Hibernation mode	127
Going into Hibernation mode more quickly....	128
Starting again from Hibernation	129
Using Standby	129
Going into Standby mode more quickly	130
Starting again from Standby	133
Chapter 7: Toshiba Utilities	134
Fn-esse	134
Starting Fn-esse	135
Assigning a key to a program or document ...	136
Viewing existing key assignments	138
Changing or removing existing key assignments	138
Hotkey utility	138
Expansion device properties	139
Accessing Mobile Extension Service Configuration.....	139
TOSHIBA Console	140
Customize Your Computer	141
Network	141
Security.....	142
TOSHIBA Button Controls	142
Power Management	143
Toshiba Hardware Setup	146
Chapter 8: If Something Goes Wrong	148
Problems that are easy to fix	148
Problems when you turn on the computer.....	150
The Windows® operating system is not working .	152
Using Startup options to fix problems	152

Internet problems	153
The Windows® XP operating system can help you	154
Resolving a hardware conflict	154
A plan of action	155
Resolving hardware conflicts on your own	155
Fixing a problem with Device Manager	157
Memory card problems.....	158
Power and the batteries	159
Keyboard problems.....	161
Display problems	161
Disk drive problems	163
Sound system problems	165
PC Card problems.....	166
Printer problems	169
Modem problems.....	170
Develop good computing habits	170
If you need further assistance.....	172
Before you call	172
Contacting Toshiba	172
Other Toshiba Internet Web sites	174
Toshiba's worldwide offices	174
Appendix A: Hot Keys	178
Volume Control	178
Volume Mute.....	179
Password security	179
Without a password	179
With a password	179
Power usage mode	180
Standby mode.....	181
Hibernation mode	182
Display modes	183
Display brightness	184
Keyboard hot keys	184

Appendix B: Power Cable Connectors	185
USA and Canada	185
United Kingdom	185
Australia.....	185
Europe	185
Glossary	186
Index	202

Introduction

Welcome to the world of powerful and portable multimedia computers! With your new Toshiba notebook computer, your access to information can accompany you wherever you go.

You will find that your Microsoft® Windows® XP Professional operating system is already installed on your computer. It offers exciting features and easy Internet access.

This guide

This guide introduces the computer's features. You can:

- ❖ Read the entire guide from beginning to end.
- ❖ Skim through and stop when a topic interests you.
- ❖ Use the table of contents and the index to find specific information.

If you are new to computers, or have not used a notebook computer before, read through the first couple of chapters to familiarize yourself with the components of the computer and how to turn it on. After that, seek out whatever interests you most.

Safety icons

This manual contains safety instructions that must be observed in order to avoid potential hazards that could result in personal injuries, damage to your equipment, or loss of data. These safety cautions have been classified according to the seriousness of the risk, and the icons highlight these instructions as follows:



***DANGER:** This icon indicates the existence of a hazard that could result in death or serious bodily injury if the safety instruction is not observed.*



***WARNING:** This icon indicates the existence of a hazard that could result in bodily injury if the safety instruction is not observed.*



***CAUTION:** This icon indicates the existence of a hazard that could result in damage to equipment or property if the safety instruction is not observed.*



***NOTE:** This icon indicates information that relates to the safe operation of the equipment or related items.*

Other icons used

Additional icons highlight other helpful or educational information:



TECHNICAL NOTE: This icon highlights technical information about the computer.



HINT: This icon denotes helpful hints and tips.



DEFINITION: This icon indicates the definition of a term used in the text.

Other documentation

Your computer comes with the following documentation:

- ❖ This electronic version of the user's guide.
- ❖ Guides for other programs that may come preinstalled on your computer and for additional programs on your Recovery CDs.
- ❖ Accessories information, which lists accessories available from Toshiba and explains how to order them.
- ❖ The Microsoft® Windows® operating system documentation, which explains the features of the operating system.

Service options

Toshiba offers a full line of service options built around its SelectServ™ warranty programs. For more information, visit Toshiba's Web site at Toshiba.com.

If you have a problem or need to contact Toshiba, see [“If Something Goes Wrong”](#) on page 148.

Chapter 1

Finding Your Way Around

This chapter presents a grand tour of your Portégé 2000 computer. It serves as a reference for you to locate specific parts of the computer.

Making sure you have everything

Before you do anything else, consult the Quick Start card shipped with your unit to make sure you received everything.

If any items are missing or damaged, notify your network administrator or authorized Toshiba representative immediately. For additional help, see [“If you need further assistance” on page 172.](#)

Front with the display panel closed

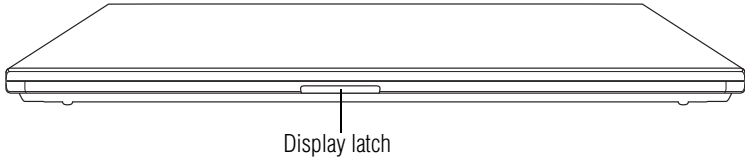

The **display latch** locks the display panel. Press the latch to release it.

Left side

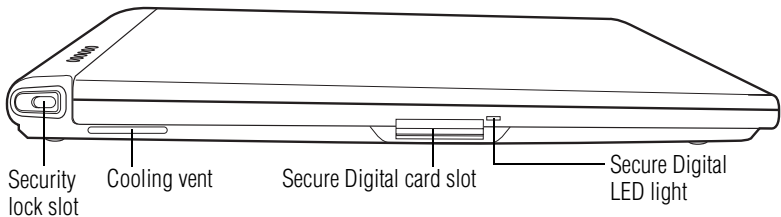

■  Attaching a special cable to the antitheft **security lock slot** lets you anchor your computer to a large, heavy object, such as your desk.

The **cooling vent** prevents the computer's central processing unit (CPU) from overheating so that it can continue to perform at its maximum speed.

The **Secure Digital card slot** holds a highly secure, stamp-size flash memory card with a capacity of 16 MB, 32 MB, 64 MB or 128 MB.

The **Secure Digital LED light** indicates the card slot is in use.

Back

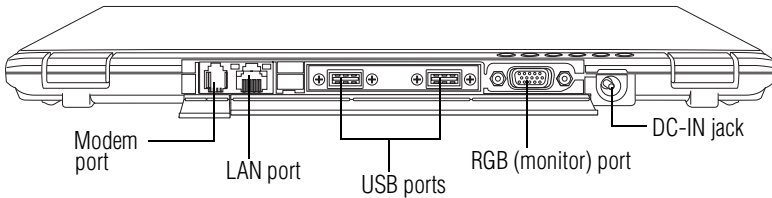

The **modem port** lets you use a RJ11 telephone cable to connect the modem directly to a standard telephone line. For more information, see [“Connecting the modem” on page 45.](#)



The **LAN port** lets you connect the computer to a local area network using a 10/100 Ethernet link.



Use the **Universal Serial Bus (USB) ports** to connect the optional external USB diskette drive or other USB peripherals.



DEFINITION: USB is a peripheral expansion standard that supports a data transfer rate of up to 12 Mbps for peripherals such as keyboards and pointing devices. USB peripherals have a single standard for cables and connectors. The USB standard also allows hot swapping of peripherals.



The **RGB (monitor) port** lets you connect an external monitor to your computer.



The **DC-IN jack** is where you plug in the AC adapter. For more information, see [“Connecting to a power source” on page 46.](#)

Right side

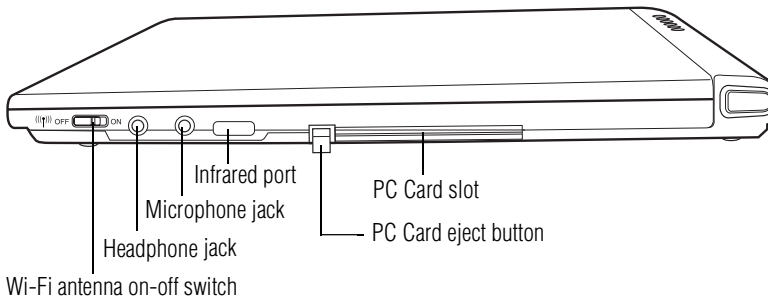

The **Wi-Fi antenna on-off switch** turns the computer's Wi-Fi antenna on or off.



The 3.5 mm diameter mini **headphone jack** lets you connect stereo headphones. Connecting headphones to this jack automatically disables the internal speaker. For more information about the Portégé 2000's audio capabilities, see ["Using audio features"](#) on page 116.



The 3.5 mm diameter mini monaural **microphone jack** lets you connect an external microphone for recording sound.



The **infrared port** allows cordless communication with a computer or other device, such as a printer, that has a compatible infrared port.



The **PC Card eject button** releases the PC Card from the PC Card slot. For more information, see ["Using PC Cards"](#) on page 99.



The **PC Card slot** can hold one Type I PC Card or one Type II PC Card. For more information, see ["Using PC Cards"](#) on page 99.

Underside

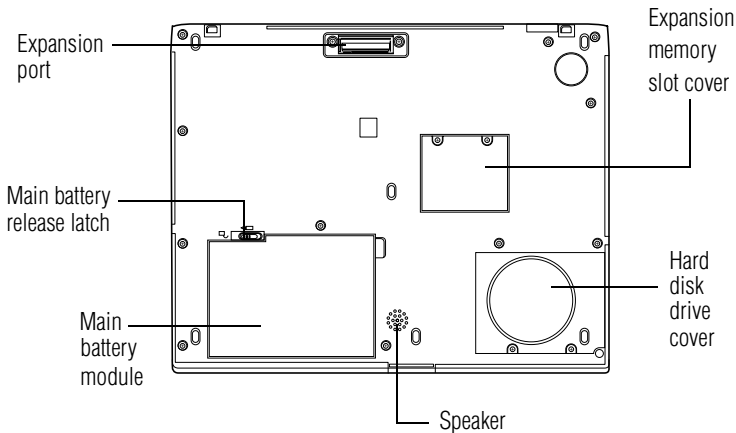

The **expansion port** allows you to connect the computer to an expansion device such as the optional Slim Port Replicator. A shutter door protects this port.



The spring-loaded **main battery release latch** locks and unlocks the battery module, which holds the main battery in place.



The removable **main battery module** powers the computer when you're away from an AC power source. Using the main battery, you can work for several hours in full power mode without an external power source.

For more information about inserting or removing the main battery, see [“Changing the main battery” on page 88](#).

The **speaker** allows you to hear sounds, such as system alarms or audio files played on optional media devices.



The **expansion memory slot cover** protects the slot that holds any extra memory added to your computer. For more information on expanding your computer's memory, see [“Installing additional memory \(optional\)” on page 40](#).

The **hard disk drive cover** protects the slot that holds the hard disk drive.

Front with the display panel open

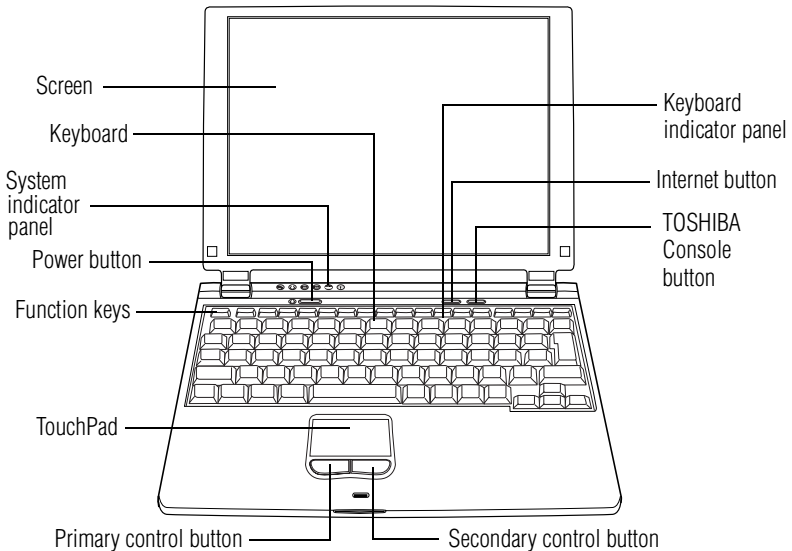

The computer's **screen** is a Poly-Silicon Technology, Thin Film Transistor (TFT), liquid crystal display (LCD) that provides clear, sharp, color images.

The Portégé 2000 has an 12.1-inch screen (measured diagonally) capable of showing 1024 x 768 pixels in up to 16 million colors. You can adjust the tilt of the screen for the most comfortable viewing angle.

You can also connect an external monitor to the computer. For more information, see [“Using an external monitor” on page 97](#).

The **keyboard** provides all the functionality of a full-size keyboard. For detailed information, see [“Using the keyboard” on page 60](#).

The **system indicator panel** is located above the keyboard on the left side, just below the open display panel. It consists of six lights that provide information about the current status of your computer.



The **power button** turns the computer on and off.

The **function keys**, when used with the Fn key, activate several different system functions. For more information, see [“Hot Keys” on page 178](#).

The **TouchPad™** enables you to move the cursor with the stroke of a finger.

The **Primary control button** next to the TouchPad acts like the primary button on a mouse.

The **Secondary control button** next to the TouchPad acts like the secondary button on a mouse.

The **keyboard indicator panel** is a set of lights on keys F10, F11 and F12 located at the top of the keyboard. For more information, see [“Keyboard indicator panel” on page 31](#).



The **Internet button** turns on the computer and launches your default Internet browser.



The **TOSHIBA Console button** allows quick access to various functions.

Keyboard indicator panel



Cursor control mode



Numeric mode



The **cursor control mode** light glows when the cursor control overlay is on. When this light is on, pressing an overlay key moves the cursor in the direction of the arrow printed on the key instead of typing the letter printed on the key.



The **numeric mode** light glows when the numeric overlay is on. When this light is on, pressing an overlay key types the number printed on the key instead of typing the letter printed on the key.



Caps lock light—The light on the Caps lock key glows when the Caps lock is on. When this light is on, pressing a letter key on the keyboard produces an uppercase (capital) letter.

System indicator panel

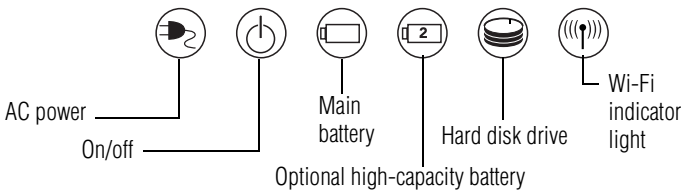

The **AC power** light shows the power status of the AC adapter.

- ❖ No illumination means that the AC adapter is not connected.

- ❖ Green means the system is receiving power from the AC adapter.
- ❖ Flashing amber means there may be a problem with the AC adapter, the main battery, or the computer. Unplug the AC adapter, remove the main battery, and reinstall it. (See “Changing the main battery” on page 88.)

For more information, see [“Connecting to a power source” on page 46.](#)



The **on/off** light indicates whether the computer’s power switch is turned on and whether the computer is in Standby mode.

- ❖ No illumination means the power is off with the computer in boot mode.
- ❖ Green means the power switch is turned on, and power is being supplied.
- ❖ Flashing amber, in two-second intervals, means the power is off and the computer is in Standby mode.



The **main battery** light indicates the status of the computer’s main battery.

- ❖ No illumination means the main battery is not in use and the AC adapter is not connected.
- ❖ Green means the main battery is fully charged.
- ❖ Amber means the main battery is charging (AC adapter connected).
- ❖ Flashing amber means the main battery charge is low and it is time to recharge the main battery or plug in the AC adapter.

For more information, see [“Monitoring main battery power” on page 80.](#)

The **optional high-capacity battery** light indicates whether the computer’s optional high-capacity battery (if present) is currently in use.



The **hard disk drive** light indicates whether the internal hard disk drive is currently in use.

- ❖ No illumination means the hard disk drive is idle.
- ❖ Green or flashing green means that the hard disk is being accessed.



Wi-Fi indicator light—The 802.11 b (referred to as Wi-Fi™ — wireless fidelity) indicator light glows amber when the Wi-Fi antenna is turned on.



NOTE: For environments that do not permit wireless use or instruct you to turn off all radio devices (for example, aboard commercial aircraft), you should turn the Wi-Fi antenna switch off.



CAUTION: Never turn off the computer while any drive is in use. Doing so may damage the media in use and result in loss of data.

AC adapter

Your computer is powered by the main battery (and optional high-capacity battery, if present) or by the AC adapter. The AC adapter can recharge the main battery while the computer is running or while it is off.

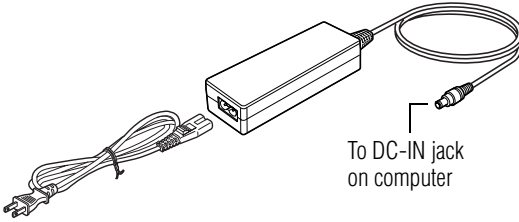

TECHNICAL NOTE: The main battery doesn't charge while the computer is consuming full power. For more information on your computer's power management, see ["Power Management"](#) on page 143.

*AC adapter*

For more information, see [“Connecting to a power source”](#) on page 46.

Chapter 2

Getting Started

This chapter provides tips for working comfortably, summarizes how to connect components, and explains what to do the first time you use your notebook computer.

Selecting a place to work

Your computer is portable and designed to be used in a variety of circumstances and locations.

Creating a computer-friendly environment

Place the computer on a flat surface that is large enough for the computer and any other items you are using, such as a printer. Leave enough space around the computer and other equipment to provide adequate ventilation. Otherwise, they may overheat.

To keep your computer in prime operating condition, protect your work area from:

- ❖ Dust, moisture, and direct sunlight.

-
- ❖ Liquids and corrosive chemicals.



CAUTION: If you spill liquid into the computer, turn it off, unplug it from the AC power source, and let it dry out completely before turning it on again.

If the computer does not operate correctly after you turn it back on, contact your Toshiba service representative or your network administrator.

- ❖ Equipment that generates a strong electromagnetic field, such as stereo speakers (other than speakers that are connected to the computer) or speakerphones.
- ❖ Rapid changes in temperature or humidity and sources of temperature change such as air conditioner vents or heaters.
- ❖ Extreme heat, cold, or humidity.

Keeping yourself comfortable

Strain and stress injuries are becoming more common as people spend more time using their computers. With a little care and proper use of the equipment you can work comfortably throughout the day.



WARNING: Using the computer keyboard incorrectly may result in discomfort and possible injury. If your hands, wrists, and/or arms bother you while typing, stop using the computer and rest. If the discomfort persists, consult a physician.

This section provides hints on avoiding strain and stress injuries. For more information, consult books on ergonomics, repetitive-strain injury, and repetitive-stress syndrome.

Placement of the computer

Proper placement of the computer and external devices is important to avoid stress-related injuries:

- ❖ Place the computer on a flat surface at a comfortable height and distance. You should be able to type without twisting your torso or neck, and look at the screen without slouching.
- ❖ If you are using an external monitor, the top of the screen should be no higher than eye level.
- ❖ If you use a paper holder, set it at about the same height and distance as the screen.

Seating and posture

When using your computer, maintain good posture with your body relaxed and your weight distributed evenly. Proper seating is a primary factor in reducing work strain. Some people find a backless chair more comfortable than a conventional chair. Whichever type you choose, use the following guidelines to adjust your chair for maximum computing comfort.

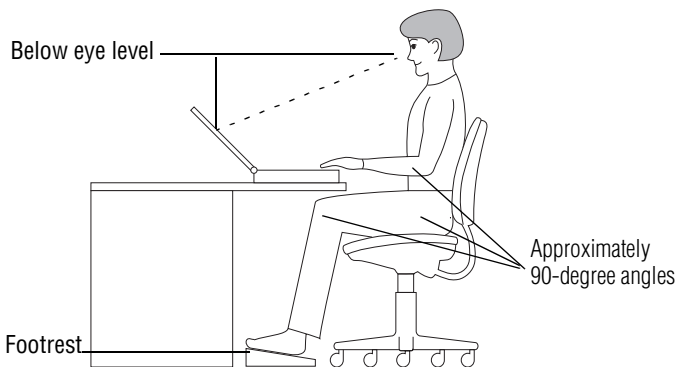

Correct posture and positioning of the computer

- ❖ Position your chair so that the keyboard is at or slightly below the level of your elbow. You should be able to type

comfortably with your shoulders relaxed and your forearms parallel to the floor.

If you are using a conventional chair:

- ❖ Your knees should be slightly higher than your hips. If necessary, use a footrest to raise the level of your knees and ease the pressure on the back of your thighs.
- ❖ Adjust the back of your chair so that it supports the lower curve of your spine. If necessary, use a cushion to provide extra back support. Lower-back-support cushions are available at many office supply stores.
- ❖ Sit with your back straight so that your knees, hips, and elbows form approximately 90-degree angles when you work. Avoid slumping forward or leaning back too far.

Lighting

Proper lighting can improve the visibility of the display and reduce eyestrain.

- ❖ Position the display panel or external monitor so that sunlight or bright indoor lighting does not reflect off the screen. Use tinted windows or shades to reduce glare.
- ❖ Avoid placing your computer in front of a bright light that could shine directly in your eyes.
- ❖ If possible, use soft, indirect lighting in your computer work area.

Arms and wrists

- ❖ Avoid bending, arching or twisting your wrists. Keep them in a relaxed, neutral position while typing.
- ❖ Exercise your hands, wrists and arms to improve circulation.

Work habits

The key to avoiding discomfort or injury from strain is to vary your activities. If possible, schedule a variety of tasks into your working day. Finding ways to break up the routine can reduce stress and improve your efficiency.

- ❖ Take frequent breaks to change position, stretch your muscles and relieve your eyes. A break of two or three minutes every half hour is more effective than a long break after several hours.
- ❖ Avoid performing repetitive activities for long periods. Intersperse such activities with other tasks.
- ❖ Focusing your eyes on your computer screen for long periods can cause eyestrain. Look away from the computer frequently and focus your eyes on a distant object for at least thirty seconds.

Precautions

- ❖ Avoid spilling liquids on the computer's keyboard.
If you do spill a liquid that gets into the keyboard, turn off the computer immediately. Leave the computer turned off overnight to give it time to dry out before you use it again.
- ❖ If a drive-in-use light indicates the drive is being accessed, don't turn off the computer.
Powering off the computer while it is reading from or writing to a disk may damage the disk, the drive or both.
- ❖ Keep the computer and diskettes away from objects that generate strong magnetic fields, such as large stereo speakers.
Information on diskettes is stored magnetically. Getting a magnet too close to a diskette can erase important files.

- ❖ Scan all new files for viruses.

This precaution is especially important for files you receive via diskette or email, or download from the Internet.

Setting up your computer

Your computer contains a rechargeable main battery that needs to be charged before you can use it.

To use external power or to charge the battery, you must attach the AC adapter. See [“Connecting to an AC outlet” on page 46](#).

To register your computer online, or to sign up for an Internet account, you must connect the built-in modem to a telephone line. See [“Connecting the modem” on page 45](#).

Before starting to use your computer, you may also want to:

- ❖ Add more memory
- ❖ Connect a mouse (see [“Connecting a mouse” on page 44](#))
- ❖ Connect a full-size keyboard (see [“Connecting a keyboard” on page 97](#))
- ❖ Connect an external monitor (see [“Using an external monitor” on page 97](#))
- ❖ Connect a local printer (see [“Connecting a printer” on page 45](#))
- ❖ Install PC Cards (see [“Using PC Cards” on page 99](#))

Installing additional memory (optional)

Your computer comes with enough memory to run most of today’s popular applications. You may want to increase the computer’s memory if you use complex software or process large amounts of data.

Additional memory comes in 256 MB modules. One memory slot is available.

To install a memory module:

- 1 Turn the computer off.



CAUTION: Do not try to install a memory module with the computer in Standby or Hibernation mode. You can damage the computer and the module.

- 2 Remove all cables connected to the computer.

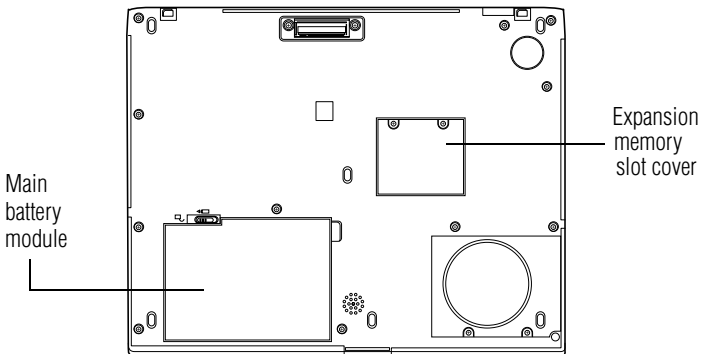

Base of the computer

- 3 Turn the computer upside down and remove the main battery module.

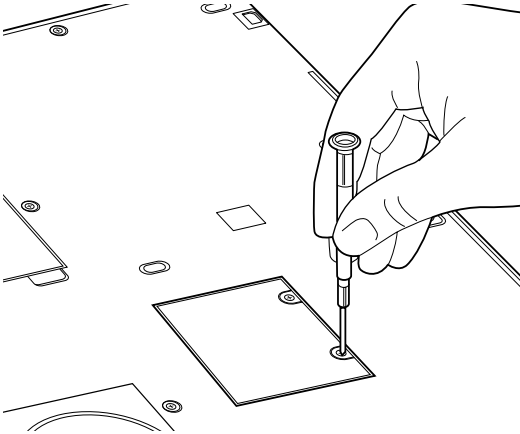

Removing the memory slot cover screws

- 4 Remove the two screws securing the expansion memory slot cover and store them in a safe place.



NOTE: Use a point size 0 Phillips screwdriver.

- 5 Lift off the cover.

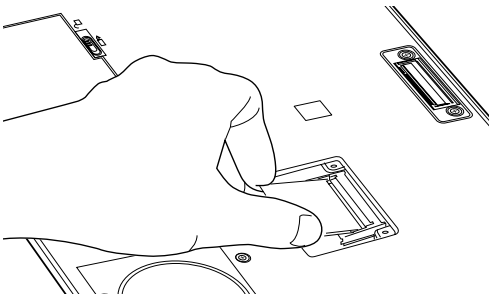

Inserting the memory module

- 6 Align the connector on the memory module with the computer's connector and carefully press the module above the connector to ensure a solid connection.



CAUTION: Do not touch the connectors on the memory module or on the computer. Debris on the connectors may cause memory access problems.

Press only the area above the connector. Do not press on the electronic components.

- 7 Secure the memory model with the one screw that came with the memory module.



CAUTION: Use only the screw that came with the memory module.

- 8 Seat the memory slot cover and secure it with the two screws.



NOTE: Use a point size 0 Phillips screwdriver.

- 9 When you turn the computer on, it should automatically recognize the total memory capacity. Use the Toshiba Hardware Setup program to verify that the added memory is recognized. If it is not recognized, check the module's connection.



NOTE: When you view the memory display, the total amount will be reduced by 16 MB, which is used for VRAM.

Removing a memory module

To remove the memory module:

- 1 Turn the computer off and remove all cables connected to the computer.



CAUTION: Do not try to remove a memory module with the computer in Standby or Hibernation mode. You can damage the computer and the memory module.

- 2 Turn the computer upside down and remove the main battery module.
- 3 Remove the two screws securing the memory module cover and store them in a safe place.
- 4 Lift off the cover.
- 5 Remove the screw that secures the memory module.
- 6 Fit two slender objects such as tweezers under the memory module on each side of the connector and pry up to disconnect the module.
- 7 Grasp the memory module by the sides and lift it out.



CAUTION: Do not touch the connectors on the memory module or on the computer. Debris on the connectors may cause memory access problems.

- 8 Seat the cover and secure it with the two screws.

Connecting a mouse

You may want to use a USB-compatible mouse instead of the TouchPad, the computer's built-in pointing device.

To connect the mouse to your computer or the optional Slim Port Replicator, plug its cable into one of the USB ports. You can connect it while the computer is on.

The operating system automatically detects the mouse. The mouse and TouchPad can be used at the same time.

Connecting a printer

You can connect a USB-compatible printer to your computer. To determine if the printer is USB-compatible, check its documentation. If it is USB-compatible, you can connect the printer while the computer is on.

To make the connection, you need a suitable USB cable, which may come with your printer. Otherwise, you can purchase one from a computer or electronics store.

To connect a printer to your computer or the optional Slim Port Replicator:



- 1 Connect the USB cable to the printer and to one of the USB ports.
- 2 Connect the printer's power cable to a wall outlet and turn on the printer.

See your printer documentation for additional configuration steps, or see [“Setting up a printer”](#) on page 52.

Connecting the modem

Your computer comes with an integrated V.90 56K modem, which you can connect as follows:

- 1 Locate the modem port on the back of your computer.
- 2 Plug one end of the telephone cable (provided) into the port.

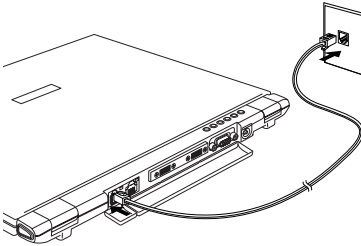

Connecting the internal modem

- 3 Connect the other end of the telephone cable to the jack of a standard voice-grade telephone line.



HINT: If you are using a telephone line at home, disable Call Waiting before you connect through the modem. Call Waiting interrupts transmission.

Connecting to a power source

Your computer requires power to operate. Use the power cable and AC adapter to connect the computer to a live power outlet, or use the main battery and the optional high-capacity battery.

Connecting to an AC outlet

The AC adapter enables you to power the computer from a wall outlet and to charge the computer's main battery.



DANGER: Hold the power cable by its plug when you connect/disconnect it. Do NOT pull the cable itself. Doing so may damage the power cable and result in a short circuit or electric shock.

To connect the computer to an external power source:

- 1 Connect the socket end of the power cable to the AC adapter.

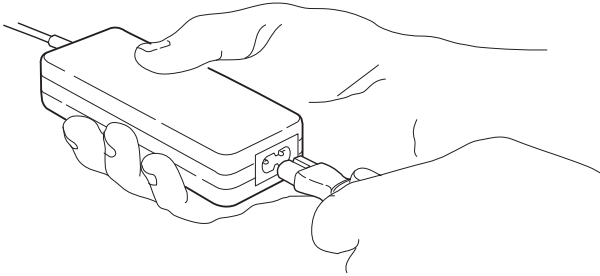

Connecting the power cable to the AC adapter



CAUTION: Use only the AC adapter supplied with the computer. Using any other AC adapter could damage the computer and void your warranty.



- 2 Connect the DC-OUT end of the AC adapter cable to the DC-IN jack on the back of the computer.

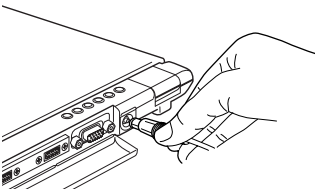

Connecting the AC adapter cable to the computer

- 3 Insert the plug end of the power cable into a live wall outlet.

The AC power light on the indicator panel glows green.

If the main battery is present, the main battery light glows:

- ❖ Green if the main battery is fully charged
 - ❖ Amber if the main battery is charging
- 4** If the AC power light flashes amber during charging, either the main battery is malfunctioning, or it is not receiving input from the AC power supply.

Disconnect the AC cable and remove the main battery pack. See [“If Something Goes Wrong” on page 148](#) for troubleshooting information.

Using the main battery

Your computer came with its main battery already installed. Before using the main battery to power the computer, you must first charge it.

To charge the main battery, leave the computer plugged in for at least six hours with the computer turned off. After that, the main battery will be completely charged and ready to power the computer.

For more information about installing or removing the main battery, see [“Changing the main battery” on page 88](#).

Connecting other external devices

For more information on attaching the Slim Port Replicator, an external monitor and other external USB-compatible devices, such as a keyboard and diskette drive, see the [“Expansion Options” chapter on page 92](#).

Using the computer for the first time

For information on connecting devices, see [“Setting up your computer” on page 40](#).

Opening the display panel

Press the display panel latch and lift the display panel.

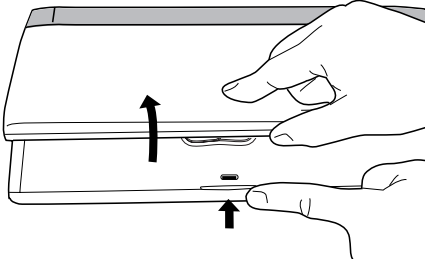

Opening the display panel



CAUTION: To avoid damaging the display panel, don't force it beyond the point where it moves easily.

Never lift or move the computer using the display panel.

Turning on the power

- 1** If the optional external diskette drive is connected, check that it is empty.
- 2** If you have a local printer connected to the computer, turn it on and wait until the printer is ready (on line).

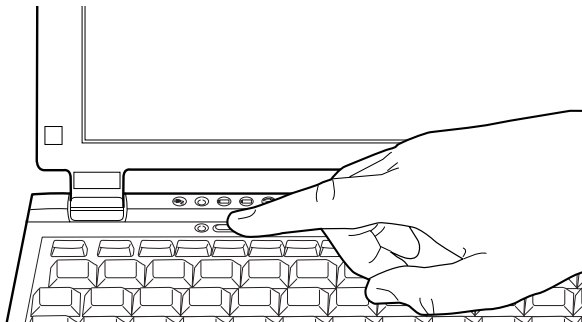

Turning on the power



- 3** Locate the oval-shaped power button above the F3 and F4 keys at the top of the keyboard. Turn on the computer by pressing the button for at least one second.

The on/off light on the system indicator panel glows green, indicating that the computer is on.



HINT: After turning on the computer for the first time, don't turn off the power again until the operating system has completely loaded.



The AC power light glows green when the computer is connected to an external power source.



The main battery light:

- ❖ Glows amber while the main battery is being charged.
- ❖ Glows green when the main battery is fully charged.
- ❖ Is unlit when the computer is not connected to an external power source.



The hard disk drive light flashes to indicate that the hard disk drive is currently in use.



CAUTION: Never turn off the computer while any of the drives is in use.

Using the TouchPad

The TouchPad, the small, smooth square cutout located in front of the keyboard, is sensitive to touch and enables you to move the cursor with the stroke of a finger. Simply move your finger on the TouchPad in the direction you'd like to move the cursor:

- ❖ To move the cursor to the top of the page, push your finger forward on the TouchPad.

- ❖ To move the cursor to the bottom of the page, drag your finger toward yourself.
 - ❖ To move the cursor to the right side of the page, slide your finger across the TouchPad from left to right.
 - ❖ To move it to the left side, slide your finger from right to left.
-



NOTE: Because the TouchPad is much smaller than the display screen, moving your cursor across the screen often means having to move your finger several times across the TouchPad in the preferred direction.

Once you've positioned your cursor, you can either click it into place by double-tapping the TouchPad or clicking the control buttons.

Primary and secondary control buttons

When you want to click or choose an item, use the TouchPad to move the pointer/cursor to the item. Once the pointer/cursor is positioned, you can click it into place by either double-tapping the TouchPad or clicking the control buttons.

The control buttons are adjacent to the TouchPad and are used like the buttons on a mouse. The primary control button is the left one and corresponds to the left mouse button. To double-click, press the primary button twice in rapid succession.

The function of the secondary button depends on the program you are using. It usually corresponds to the right mouse button. Check your program's documentation to find whether it uses the secondary mouse button.

Setting up your software

The first time you turn on your computer, the Setup Wizard guides you through steps to set up your software.

-
- 1 From the welcome screen, click **Next** to enter the Setup Wizard.
 - 2 Confirm acceptance of Microsoft's End User License Agreement and click **Next**.
 - 3 Enter your name and the name of your company or organization and click **Next**.
 - 4 Enter the information about your computer.
-



NOTE: If your computer has the Microsoft® Windows® XP Professional operating system and will be connected to a network, consult your system administrator before you choose your computer name and network settings.

- 5 Set the correct date, time and time zone for your computer and click **Next**.

Your computer restarts automatically.

Registering your computer with Toshiba

Registering your computer lets Toshiba keep you up-to-date with information about new products and upgrades, and also extends your Toshiba warranty worldwide at no charge to you. You can register your computer with Toshiba by double-clicking the icon on your desktop or by mailing the registration card that may ship with your computer.



NOTE: To register online, your computer's modem must be connected to a voice-grade telephone line.

Setting up a printer

If you have a printer, follow these steps to set it up for the first time. You only need to set up the printer once.

1 Click **Start, Printers and Faxes**.

The Printers and Faxes window appears.

2 Click **Add a Printer**.

The Add Printer Wizard appears

*Sample Add Printer Wizard***3** Follow the on-screen instructions to set up your printer.

TECHNICAL NOTE: Some printers require a specific installation process. In this case, the Windows® XP Professional Add Printer Wizard will display an error message. If this happens, refer to your printer installation guide for further instructions.

Customizing your computer's settings

There are several ways in which you can customize your computer to suit your particular requirements. Refer to your operating system documentation or Help and Support for details.

You may also wish to customize your power usage settings. For more information, see [“Turning off the display automatically” on page 86](#). There are additional custom settings you can choose. See [“Toshiba Utilities” on page 134](#).

Powering off the computer

It’s a good idea to power off your computer when you are not using it for a while.

If you are using the computer for the first time, leave the computer plugged into a power source (even though the computer is off) to fully charge the main battery. With the computer off, it may take up to six hours to charge the main battery.

Guidelines for powering off the computer:

- ❖ If you have work in progress and aren’t connected to a network, use the Hibernate command to save your system settings to the hard disk so that, when you turn on the computer again, you automatically return to where you left off.
- ❖ To leave the computer off for a longer period, power down the computer. The Windows® XP Professional operating system uses the Shut down command to power down the computer if you are connected to a Windows® network server (domain server) or the Turn Off command if you are not.
- ❖ When the hard disk drive light on the system indicator panel is on, don’t turn off the power. Doing so may damage your hard disk.

For more information, see [“Powering down the computer” on page 119](#).

Closing the display panel

When you are finished using the computer, power off and close the display panel to keep dust and dirt out of the computer.

If you close the display panel while the computer is still on, one of these actions will occur:

- ❖ If you have the audible warning set, the computer will beep to notify you that it is still on. (See [“Toshiba Hardware Setup”](#) on page 146.)
- ❖ If you have an action feature set, the computer will perform that action (Nothing, Standby, Hibernate). For more information, see [“Power Management”](#) on page 143.

Different ways to turn the computer on and off

Instead of turning on your computer by pressing the power button, you can set the computer to turn on automatically at a time you designate. Using this option enables you to transfer files by modem at night, when the rates are cheaper. You can set the computer to turn on and send or receive the files while you are asleep. This option is called Auto Power On.

Caring for your computer

This section gives tips on cleaning and moving your computer. For information about taking care of your computer’s main battery, see [“Battery safety precautions”](#) on page 78.

Cleaning the computer



CAUTION: Keep liquid, including cleaning fluid, out of the computer's keyboard, speaker grille and other openings. Never spray cleaner directly onto the computer. Never use harsh or caustic chemical products to clean the computer.

To keep your computer clean, gently wipe the display panel and exterior case with a lightly dampened cloth. Ask your network administrator for suggestions for appropriate cleaning products.

Moving the computer

Before moving your computer, even across the room, make sure all disk activity has ended (the drive-in-use light stops glowing) and all external peripheral cables are disconnected.

Using a computer lock

You may want to secure your computer to a heavy object such as your desk. The easiest way to do this is to purchase an optional PORT-Noteworthy[®] computer lock cable.



PORT-Noteworthy computer lock cable

To secure the computer:

- 1** Loop the cable through or around some part of a heavy object.

Make sure there is no way for a potential thief to slip the cable off the object.

- 2 Pass the locking end through the loop.
-  3 Insert the cable's locking end into the security lock slot on your computer, then engage the locking device.

The computer is now securely locked.

Chapter 3

Learning the Basics

This chapter lists computing tips and provides important information about the system's basic features.

Computing tips

- ❖ Save your work frequently.

Your work temporarily stays in the computer's memory until you save it to the disk. You will lose all unsaved work, if, for example, a system error occurs and you must restart your computer, or your battery runs out of charge while you are working. Your computer can be configured to warn you when the battery is running low. See [“Setting battery alarms”](#) on page 85.



HINT: Some programs have an automatic save feature which you can turn on. This feature saves your file to the hard disk at preset intervals. See your software documentation for details.

-
- ❖ Back up your files to diskettes (or other removable storage media) on a regular basis. Label the backup copies clearly and store them in a safe place.
If your hard disk suddenly fails, you may lose all the data on it unless you have a separate backup copy.
 - ❖ Use Error-Checking and Disk Defragmenter regularly to conserve disk space and help your computer perform at its optimal level. Consult your Windows® XP operating system documentation for more information on these and other utilities.
 - ❖ Always use the proper procedure to power off the computer. See [“Powering down the computer” on page 119](#).



TECHNICAL NOTE: The operating system records information, such as your desktop setup, during its shutdown procedure. If you don't let the operating system shut down, details such as new icon positions may be lost.

Using the keyboard

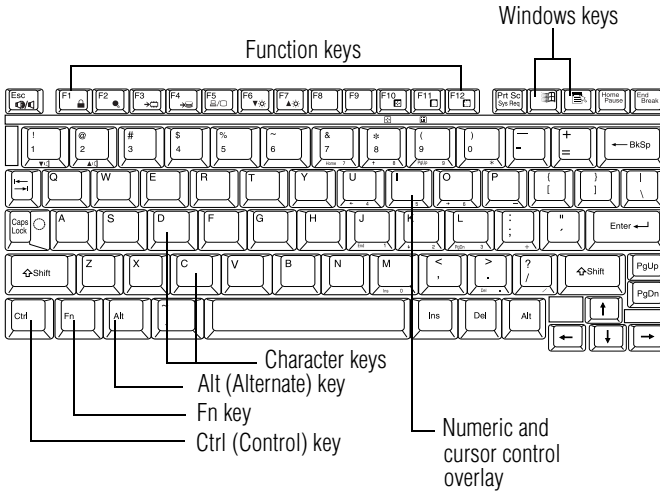

Sample parts of the keyboard

Ctrl, Fn and Alt keys



Ctrl, Fn and Alt keys

The Ctrl, Fn and Alt keys do different things depending on the program you are using. For more information, see your program documentation.

Character keys

Typing with the character keys is very much like typing on a typewriter, except that:

- ❖ The spacebar creates a space character instead of just passing over an area of the page.
- ❖ The lowercase l (el) and the number 1 are not interchangeable.

- ❖ The uppercase O (oh) and the number 0 are not interchangeable.
- ❖ The Caps Lock key changes only the alphabet keys to uppercase—the number and symbol keys are not affected.

Function keys



Function keys

The function keys (not to be confused with the Fn key) are the 12 keys at the top of the keyboard. They are called function keys because they run programmed functions determined by the application you are using. For more information, see your program documentation.

Hot keys

When used in combination with the Fn key, function keys marked with icons run programmed functions specific to your computer. For more information, see “Hot Keys” on page 178.

Windows® special keys

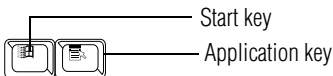

Windows® special keys

The keyboard provides two keys that have special functions:

- ❖ The Windows® logo key opens the Start menu.
- ❖ The Application key has the same function as the secondary (or right mouse) control button.

Overlay keys

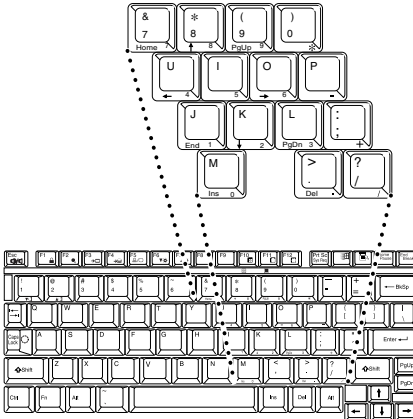

Keyboard overlay keys

The keys with numbers and symbols on them form the numeric and cursor overlay. This overlay lets you enter numeric data or control the cursor as you would using the ten-key keypad on a full-size keyboard.

Using the numeric keyboard overlay



To turn the numeric overlay on and off, press Fn and F11 simultaneously. The numeric mode light on the keyboard indicator panel glows when the numeric overlay is on.

You can still use the overlay keys to type alphabetic characters while the numeric overlay is on.

Once the numeric overlay is turned on:

To

Procedure

Type lowercase letters

Press and hold down Fn while you type the letters

Type uppercase letters

Press Fn and Shift simultaneously while you type the letters

<i>To</i>	<i>Procedure</i>
Use the cursor control keys	Press and hold down Shift while you use the overlay keys, then release Shift to return to the numeric overlay

To turn off the numeric overlay, hold down the Fn key and press F11 again. The numeric mode light on the keyboard indicator panel goes out.

Using the cursor control overlay



To turn on the cursor control overlay, press Fn and F10 simultaneously. The cursor control mode light on the keyboard indicator panel glows when the cursor control overlay is on.

Once the cursor control overlay is on:

<i>To</i>	<i>Procedure</i>
Type lowercase letters	Press and hold down Fn while you type the letters
Type uppercase letters	Press Fn and Shift simultaneously while you type the letters
Use the numeric keys	Press and hold down Shift while you use the overlay keys, then release Shift to return to the cursor control overlay

To turn off the cursor control overlay, hold down the Fn key and press F10 again. The cursor control mode light on the keyboard indicator panel goes out.

Starting a program

The easiest way to start a program is to double-click the name of the file that contains the information you want to work on. To find the file, use My Computer or Windows[®] Explorer.

If you prefer to open the program first, you have the following options:

- ❖ Double-click the icon for the program on your desktop
- ❖ Use the Start menu
- ❖ Use Windows[®] Explorer to locate the program file
- ❖ Use the Run dialog box

For more information, see Help and Support in the Start menu.

Saving your work

Before you turn off the computer, save your work to the hard disk drive or a diskette.



NOTE: Always save your data even when you are using the Stand by command. If your battery fully discharges, your information will be lost. Your computer can be configured to warn you when the battery is running low, see ["Using battery alarms" on page 85](#).

Many programs offer a feature that saves documents at regular intervals, such as every 15 minutes. Check your programs' documentation to see whether they have an automatic save feature.

To save:

- ❖ A file you are updating, open the program's **File** menu and click **Save**.

-
- ❖ A new file, choose **Save As** from the **File** menu, type a name for the file, and click **OK**.
-



*HINT: To make another copy of the file you are currently working with, choose **Save As** from the **File** menu and give the new file a different name.*

Printing your work

Verify that the Windows[®] XP operating system is set up for your printer as described in “[Setting up a printer](#)” on page 52.



TECHNICAL NOTE: You only need to set up the printer the first time you connect it. If you use more than one printer or are changing printers, you will need to set up the operating system to run with the additional printer(s).

To print a file:

- 1 If your printer is not on, turn it on now.
- 2 In the **File** menu of your program, click **Print**.
The program displays a Print dialog box.
- 3 Click **OK** to print.

Using optional external diskettes

To use diskettes, you must connect the optional external USB diskette drive to the USB port on the back of the computer, or to the optional Slim Port Replicator. See “[Connecting the optional external USB diskette drive](#)” on page 95 for more information.

Inserting and removing diskettes

- 1 Insert a diskette into the insertion slot until it clicks in place.

A protective flap inside the drive's insertion slot automatically retracts when you insert a diskette.

The diskette-in-use light glows when the computer is accessing a diskette.

- 2 Push the diskette eject button to remove a diskette from the drive.

Copying documents to a diskette

Diskettes provide an easy means of transferring files from one computer to another. Copying a file to a diskette also gives you a backup copy in case something happens to the original on your hard disk. This section describes how to use the My Computer window to copy a file from the hard disk to a diskette.

To copy files to a diskette:

- 1 Connect the optional external USB diskette drive to the computer.
- 2 Insert a diskette into the drive.
- 3 Double-click the **My Computer** icon.

The operating system opens the My Computer window.

- 4 Double-click the drive that contains the file you want to copy.

The operating system displays the contents of the drive.

- 5 Double-click the folder that contains the file, then click the file you want to copy.



HINT: Use the Ctrl or Shift key to select more than one file.

6 On the menu bar, click **File**, then click **Send To**.

7 Click the icon for 3½ Floppy (A:).

The operating system copies the file(s).



HINT: You can also copy a file to diskette by clicking the file (or files) you want to copy with the secondary button, then pointing to Send To and clicking 3½ Floppy (A:).

Taking care of diskettes

To protect the data stored on your diskettes:

- ❖ Store your diskettes in their boxes or other containers to protect them and keep them clean.
- ❖ Keep diskettes at room temperature and avoid exposing them to direct sunlight. Otherwise data may be lost.
- ❖ Keep your diskettes away from sources of magnetism, such as speakers and radios, since these can destroy data.
- ❖ Clean dirty diskettes with a soft cloth moistened in water. Do *not* use cleaning fluids.

Avoid:

- ❖ Sliding back the protective metal cover.
- ❖ Touching the magnetic surface of a diskette. Fingerprints can prevent the drive from reading the data held on a diskette.
- ❖ Twisting or bending a diskette.
- ❖ Placing heavy objects on your diskettes.
- ❖ Eating, smoking or using erasers near your diskettes. Foreign particles can damage the surface.

Backing up your work

To back up several files at one time, use the Backup or Restore Wizard. You can choose the files and the type of backup you want to perform.

- 1 Connect the backup device to your computer as shown in the manufacturer's instructions.
- 2 Click **Start, All Programs, Accessories, System Tools, Backup**.

The Backup or Restore Wizard window appears.

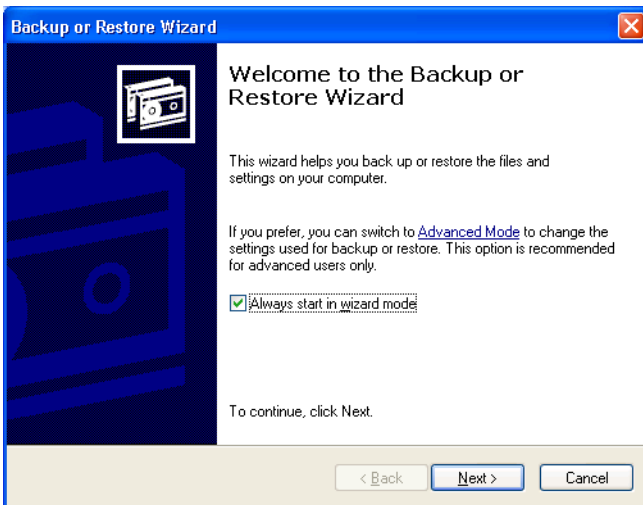

Sample Backup or Restore Wizard window

- 3 Follow the on-screen instructions.

Restoring your work

You can also use the Backup or Restore Wizard to restore information from your backup media to your hard disk.



TECHNICAL NOTE: When restoring files, the backup program prompts you if you try to overwrite a file that already exists on the hard disk. Make sure the backup version is the one you want before overwriting the existing file.

Playing audio

Your computer is equipped to play audio files, including those that run on optional media devices such as CD and DVD drives. By adjusting the controls on your operating system's Windows Media™ Player, you can control the playing of those files.

To access the Windows Media™ Player, click **Start**, then click **Windows Media Player**.

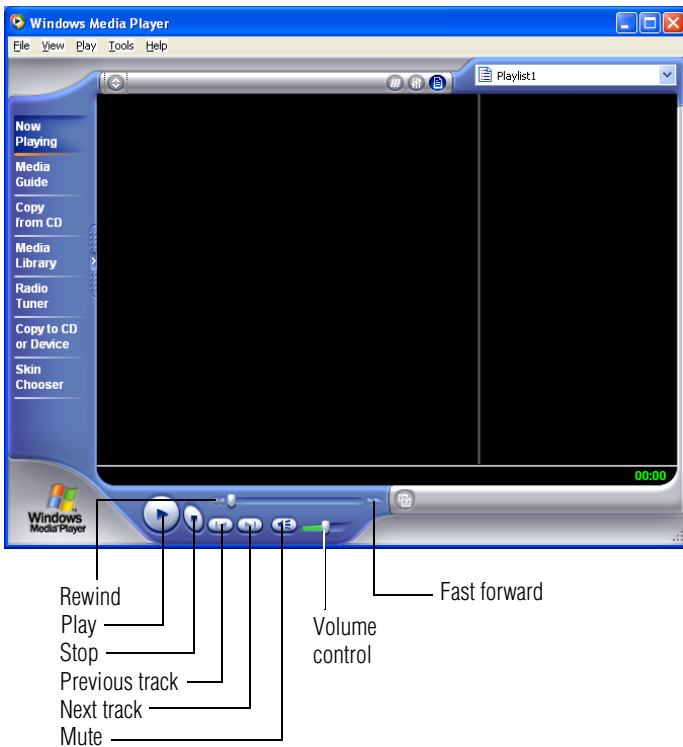

Sample Windows Media™ Player screen

With your pointing device, use the Windows Media™ Player screen as you would an audio control panel.

Setting up for communications

To connect to the Internet, use an online service, or communicate across the telephone lines with another computer, you need:

- ❖ A modem (supplied with your computer)
- ❖ A telephone line
- ❖ A browser or communications program

- ❖ An Internet Service Provider (ISP) or an online service if you plan to use the Internet

Before you can use the modem, you must connect it to a standard voice-grade telephone line. See “[Connecting the modem](#)” on [page 45](#) for details.

Connecting your computer to a network

To access a network:

- ❖ At the office, connect the computer to a Local Area Network (LAN). For specific information about connecting to the LAN, consult your network administrator.
- ❖ Use your computer’s Wi-Fi capability to connect to a wireless LAN.
- ❖ While you are at home or traveling, you need a dial-up connection. Ask your network administrator for the telephone number of the network.

To set up the connection, use the Dial-Up Networking Wizard:

- 1 Click **Start** and point to **All Programs**.
- 2 Point to **Accessories**, then to **Communications**, and click **Network Setup Wizard** or **Network Connections**.
- 3 Enter the phone number of your network connection and let the program dial the number.

The computer connects with the network.

An overview of using the Internet

The following sections give a quick introduction to the Internet and some of its exciting features, under these headings:

- ❖ [The Internet](#)
- ❖ [The World Wide Web](#)

- ❖ Internet Service Providers
- ❖ Connecting to the Internet
- ❖ Surfing the Internet
- ❖ Internet features
- ❖ Uploading and downloading files from the Internet

The Internet

The Internet is an association of thousands of networks and millions of computers around the world connected by communications lines. They all work together to share information.

The World Wide Web

The World Wide Web (or 'Web') is a subset of the Internet — a collection of interlinked documents (located on computers connected to the Internet) that work together using a specific Internet protocol called Hypertext Transfer Protocol (HTTP).

The World Wide Web offers information as text, images, audio, or video to be referenced from anywhere in the world. Special programs called Web browsers are specifically designed to work with HTTP. They make it easier to connect to a particular network address and send and receive information.

Internet Service Providers

To connect a computer directly to the Internet, many people and businesses use an Internet Service Provider (ISP). An ISP is a company that has the equipment and the telecommunication lines necessary to maintain an Internet connection.

You can connect to the Internet by using a telephone and modem or through other higher-speed communication methods such as Digital Subscriber Lines (DSL), cable, and satellite links.

Connecting to the Internet

To connect to the Internet, you need:

- ❖ A modem
- ❖ A Web browser
- ❖ A telephone line
- ❖ An Internet Service Provider (ISP) account

Microsoft's Web browser, Internet Explorer, is automatically configured on your system so that when you first start it, it guides you through signing up for a new ISP account.

Once you have established an ISP account, you can access the Internet.

- 1** Connect your computer's modem to a telephone line.
- 2** Have your modem dial the ISP's telephone number, and establish a connection with the ISP's computer.

If you are using your computer at the office, then you probably connect to the Internet through your company's network. See your network administrator about connecting to the Internet.

Surfing the Internet

Once connected to the Internet, the Web browser displays a home page, for example, your ISP's home page on the Internet or your company's Web site home page.

To visit a desired Web site, type in the Web address. The Web address, or Uniform Resource Locator (URL), is a unique identifier for that computer system linked to the Internet. Web addresses can also appear within a Web page's text, and are known as links. Clicking a link automatically displays the site on your Web browser.

You can also use a Search Engine, a Web site specifically designed to help you look for information.

Internet features

The Internet offers many types of communication tools to help you perform many tasks.

❖ **Internet email**

To send and receive email of your own, you need a mailbox on the Web, or an email address.

If you have an account with an ISP, you can probably set up an email address at the same time as you sign up for the service.

❖ **Internet chat rooms**

A chat room is a Web site that offers a place where people with similar interests and ideas can communicate in real-time, one-on-one or in groups, by typing messages which are instantly viewed by others on their computer screens.

❖ **Internet news groups**

A news group is similar to a chat room, but instead of using a dedicated site to converse about a specialized subject with others in real-time, it uses a Web site as a clearinghouse where all the messages are placed, like a gigantic bulletin board.

❖ **Online shopping**

Many Web sites offer products and services for sale.

Uploading and downloading files from the Internet

Transferring files from one computer to another is termed uploading (transferring data from your computer to a site on the Web), or downloading (transferring data from a site on the Web to your computer).

There are several ways to upload or download data. It can be as simple as attaching a file or document to an email, or you can use the File Transfer Protocol (FTP) features of your Web browser to transfer large amounts of data.

Toshiba's online resources

Toshiba maintains a number of online sites to which you can connect. These sites provide information about Toshiba products, give help with technical questions and keep you up to date with future upgrades. For more information, see [“Contacting Toshiba” on page 172](#).

Chapter 4

Mobile Computing

This chapter covers all aspects of using your computer while traveling.

Toshiba's energy-saver design

Your computer enters a low-power standby mode when it is not being used, thereby conserving energy and saving money in the process. It has a number of other features that enhance its energy efficiency.

Many of these energy-saving features have been set by Toshiba. We recommend you leave these features active, allowing your computer to operate at its maximum energy efficiency, so that you can use it for longer periods while traveling.

Running the computer on battery power

Your computer contains a removable, rechargeable lithium polymer (Li-polymer) main battery that provides power when you are away from an AC outlet. You can recharge the main battery many times.

In addition to the removable lithium polymer main battery, the computer has an internal real-time clock (RTC) battery. This is a nickel metal hydride (NiMH) battery. The RTC battery powers the RTC memory, which stores your system configuration settings and the current time and date for up to a month while the computer is turned off.

To increase the length of time you can run the computer on battery power, you can connect a second battery to the optional high-capacity battery connector on the base of the computer.

Maximizing battery life

A battery can be recharged many times. Gradually over time it will lose its ability to hold a charge. To maximize the life of your main battery:

- ❖ Avoid leaving the computer plugged in and unused for more than a few hours. Overcharging the main battery may shorten its life.
- ❖ If you are not going to use the computer for a long time, remove the main battery and the optional high-capacity battery.
- ❖ Alternate between main battery packs if you have a spare.
- ❖ Make sure your computer is turned off, or in Hibernation mode, when you are replacing the main battery.
- ❖ Store spare battery packs in a cool dry place out of direct sunlight.

Using additional battery packs

If you spend a lot of time traveling and need to work for many hours without an AC power source, you may want to carry additional charged battery packs with you. You can then replace a discharged battery and continue working.

Battery safety precautions

- ❖ Never try to disassemble a battery pack.
- ❖ Never overcharge or reverse charge a battery. Overcharging will shorten its life and reverse charging could destroy it, causing the release of toxic fumes.
- ❖ Avoid touching the metal terminals of the battery with another metal object. Short circuiting the battery will cause it to overheat and may cause permanent damage to the battery or the computer.
- ❖ Never incinerate a spent battery as this will cause it to explode, releasing toxic materials.
- ❖ If a battery is leaking or damaged, replace it immediately. Use protective gloves when handling a damaged battery.
- ❖ When replacing the main battery, use an identical battery that you can purchase from Toshiba. See the accessories information provided with your computer or visit toshibaaccessories.com.

Charging batteries

The main battery and optional high-capacity battery need to be charged before you can use them to power the computer. You can charge the main battery using either your computer or an optional battery charger. To charge the optional high-capacity battery you must use a battery charger.

Charging the main battery

To charge the main battery while it is in your computer, use the AC adapter to connect the computer to a live wall outlet. With the computer off, recharging the main battery takes up to six hours. The main battery takes much longer to charge when the computer is on. The main battery does not charge while the computer is consuming full power.

The main battery light:



- ❖ Glows amber while the main battery is being charged.
- ❖ Glows green when the main battery is fully charged.

The main battery may not start charging immediately if:

- ❖ The main battery is extremely hot or cold. To ensure that the main battery charges to its full capacity, wait until it reaches room temperature.
- ❖ The main battery is almost completely discharged. Leave the power connected and the main battery should begin charging after a few minutes.



HINT: Once the main battery is fully charged, we recommend you operate your computer on battery power until the main battery discharges completely. Doing this extends the life of the main battery and helps ensure accurate monitoring of battery capacity.

Charging the RTC battery

The RTC battery provides power for the internal real-time clock and calendar. During normal use, the main battery keeps the RTC battery adequately charged. Occasionally, the RTC battery may lose its charge completely, especially if you have had the computer turned off for a long time.

To recharge the RTC battery, plug in the computer and leave it turned off for at least 24 hours.



TECHNICAL NOTE: It is seldom necessary to charge the RTC battery because it charges while the computer is on. If the RTC battery is low, the real-time clock and calendar become slow or stop working.

When Hibernation mode is enabled and the RTC battery is completely discharged, a warning prompts you to reset the real-time clock.

Using a battery charger

You can purchase an optional battery charger that recharges lithium polymer battery packs without requiring the use of your computer.

Use the battery charger to charge the optional high-capacity battery and to charge spare main battery packs.



CAUTION: Avoid leaving batteries in the battery charger for more than a week at a time. Doing so may reduce the potential charge of the battery.

Use only battery chargers designed to work with your computer and its batteries. You can order a Toshiba battery charger through the accessories information sheet or Toshiba's Web site at toshibaaccessories.com.

Monitoring main battery power



The computer's main battery light gives you an indication of the main battery's current charge:

- ❖ No illumination means the main battery is not in use and the AC Adapter is not connected.

- ❖ Green means the main battery is fully charged.
- ❖ Amber means the main battery is charging (AC Adapter connected).
- ❖ Flashing amber means the main battery charge is low and it is time to recharge the main battery or plug in the AC Adapter.



HINT: Be careful not to confuse the main battery light (☐) with the on/off light (⏻). When the on/off light flashes amber, it indicates that the system is suspended (using the operating system Standby command).

Determining remaining battery power



NOTE: Wait at least 16 seconds after turning on the computer before trying to monitor the remaining battery power. The computer needs this time to check the battery's remaining capacity and perform its calculations.

- 1 Click **Start**, then click **Control Panel**.
- 2 Click **Performance and Maintenance**.
- 3 Click the **Toshiba Power Saver** icon.
- 4 The Power Saver Properties window appears



The current power source and battery power remaining section displays the current charge state of the battery. The value is shown as a percentage of remaining battery charge.



TECHNICAL NOTE: The computer drains the battery faster at low temperatures. Check your remaining charge frequently if you are working in temperatures below 50 degrees Fahrenheit.

The computer calculates the remaining battery charge based on your current rate of power use and other factors such as the age of the battery.

What to do when the main battery runs low

When the main battery runs low you can:

- ❖ Plug the computer into an external power source and recharge the main battery.
- ❖ Put the computer in Hibernation mode and replace the main battery with a charged spare.
- ❖ Connect the computer to the optional high-capacity battery.
- ❖ Save your work and turn off the computer.

If you don't manage to do any of these things before the main battery completely runs out of power, the computer automatically enters Standby mode and turns itself off. Standby mode keeps track of where you were so, when you turn on the power again, you can continue where you left off.

The computer stores information on what you were doing until the main battery runs out of power. If you have Hibernation mode enabled (the default), the computer copies the details of your open programs and files to the hard disk before shutting down.

Conserving battery power

How long a fully charged battery pack lasts when you are using the computer depends on a number of factors, such as:

- ❖ How the computer is configured.
- ❖ How much you use the display panel instead of an external monitor.
- ❖ How much you use the hard disk and other drives.
- ❖ Whether you use any optional devices to which the battery supplies power.
- ❖ Where you are working—since operating time decreases at low temperatures.

Toshiba's power-saving options greatly increase the length of time you can use the computer before having to recharge the main battery.

Toshiba has combined these options into several preset power usage modes.

Setting a power usage mode

- 1** Click **Start, Control Panel**.
The Control Panel window appears.
- 2** Click **Performance and Maintenance**.

3 Click the **TOSHIBA Power Saver** icon.

The TOSHIBA Power Saver Properties window appears.

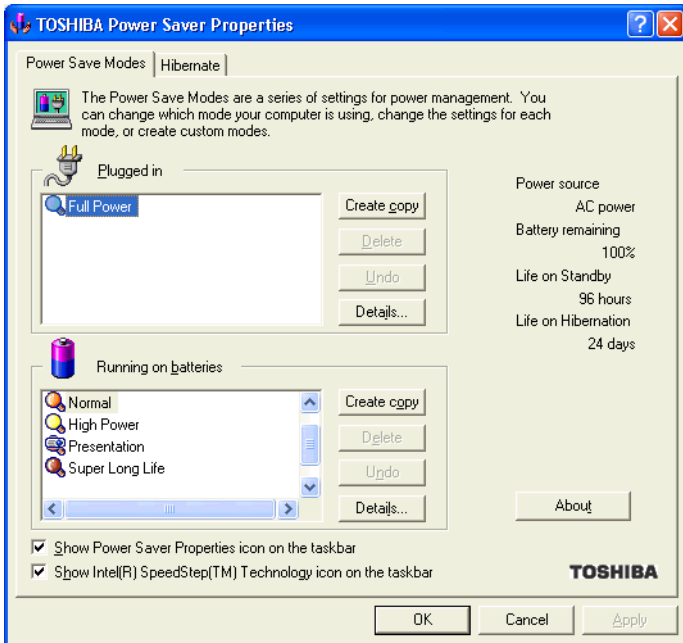

Sample TOSHIBA Power Saver Properties window

By changing the options that appear in the Power Saver Properties dialog box and clicking **OK**, you can reconfigure that function. You may choose a power-saving management strategy to best suit your computing needs. If you are running on batteries and the programs that you are using do not require a lot of system resources, you may experience longer work sessions by enabling the Normal setting. Any options that you change become the active settings when you exit the program. (You do not have to restart your system before they become active settings.)

Using a hot key to select the power usage mode

- 1 Press Fn and F2 simultaneously to display the power usage pop-up window.
- 2 While continuing to press Fn, press F2 until you select the desired power usage mode.
- 3 Release the Fn key.

The computer is now in the selected mode.

Using battery alarms

You can configure the computer to warn you when the main battery is running low.

Setting battery alarms

You can set two alarms. Each alarm can be set to alert you when a specified percentage of remaining battery power has been reached. You can set how the warning occurs: sound an alarm, display a message, both, or none. You can also set the computer to enter Standby mode or Hibernation mode or to completely power down when the alarm goes off.

To set an alarm or alarms:

- 1 Click **Start, Control Panel**.
- 2 Click **Performance and Maintenance**.
- 3 Click **Toshiba Power Saver**.

The Toshiba Power Saver Properties window appears.

- 4 In the “Running on batteries” section, click **Details**.
The mode Properties window appears.
- 5 Click the Alarm tab and set the alarm(s), as desired.

Turning off the display automatically

To save power, it's a good idea to set the display to turn off automatically when you're not using the computer. You can do this in several ways:

- ❖ Use the Display Properties to enable the blank screen saver.
- ❖ Use the Power Saver Properties to turn off the LCD panel after a certain amount of time has passed.

Enabling the screen saver

- 1** Click **Start, Control Panel**.
- 2** Click **Appearance and Themes**.
- 3** Click **Display**.
The Display Properties window appears.
- 4** Click the **Screen Saver** tab.

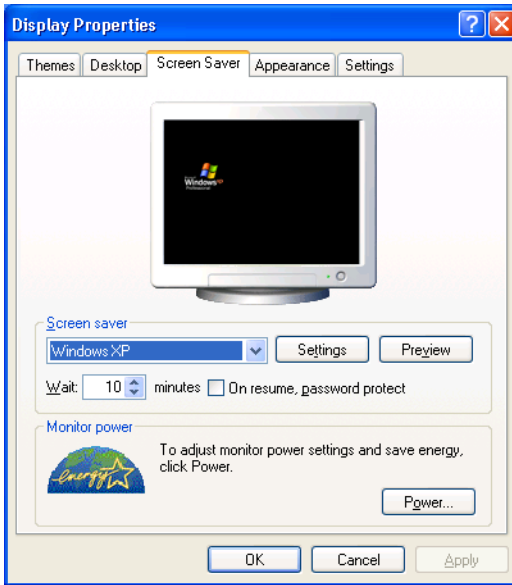

Sample Display Properties window with Screen Saver tab displayed

- 5 In the section labeled **Screen Saver**, select **Blank Screen**.
- 6 In the Wait window, click the up and down buttons to set the number of minutes of inactivity before the display turns off automatically.
- 7 Click **Apply**, then **OK**.

Changing the main battery

When your main battery has run out of power, you have two options: plug in the AC Adapter or install a fresh main battery.



TECHNICAL NOTE: To avoid losing any data, save your files and then either completely shut down your computer, or put it into Hibernation mode before changing the main battery.

Removing the battery from the computer

- 1 Save your work.
- 2 Power off the computer or place it in Hibernation mode according to the instructions in [“Going into Hibernation mode more quickly”](#) on page 128.
- 3 Remove all cables connected to the computer.
- 4 Close the display panel and turn the computer upside down with the front of the computer facing you.

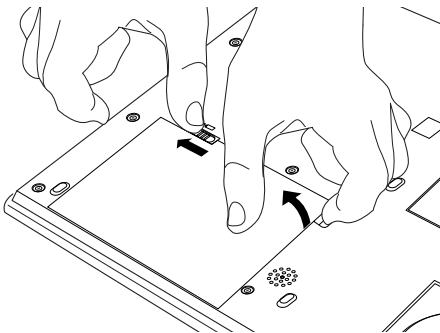

Sliding the battery release latch and freeing the battery

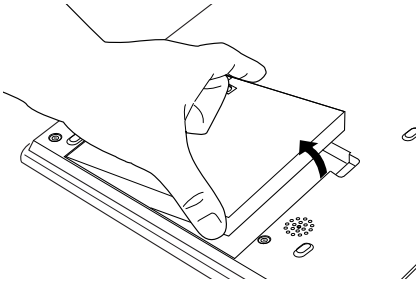

Pulling the battery out

- 5 Carefully slide the battery release latch to the left and use the finger slot near the corner of the battery module to gently pull the battery module free.



WARNING: If the battery is leaking or its case is cracked, put on protective gloves to handle it, and discard it immediately following the advice in “Disposing of used batteries safely” on page 90.

Inserting a charged battery

- 1 Wipe the battery terminals of the charged battery with a clean cloth to ensure a good connection.
- 2 Holding the battery at an angle, insert the end facing you into the front of the battery slot.
Make sure that end fits evenly with the surrounding casing.
- 3 If you have inserted that end correctly, you will be able to gently press the rear end into place until the battery latch snaps shut. If that end resists, don't force it. Simply start over.

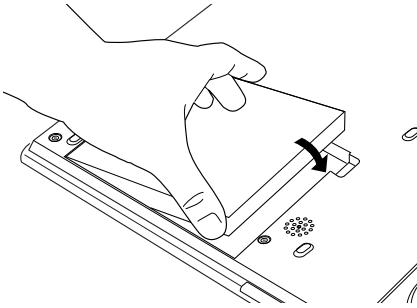
*Inserting the battery*

CAUTION: Failure to lock the battery cover can result in the battery falling out of the computer case.

- 4 Turn the computer right side up.
- 5 Reconnect any cables you removed.
- 6 Turn on the computer.

Disposing of used batteries safely

You can recharge a battery pack many times, so it should last for years. When the battery pack needs replacing, the battery light flashes amber shortly after you have fully recharged the battery.

You must discard a battery pack if it becomes damaged.



CAUTION: The battery pack is a lithium polymer (Li-polymer) battery, which can explode if not properly replaced, used, handled, or disposed of. Putting spent batteries in the trash is not only irresponsible, it may be illegal. Dispose of the battery as required by local ordinances or regulations.

Use only batteries recommended by Toshiba.

The materials that came with your computer may include an insert regarding the disposal of batteries. If not, check with your local government for information on where to recycle or dispose of old batteries.

Traveling tips

The environmental precautions listed in [“Selecting a place to work”](#) on page 35 also apply while traveling.

- ❖ Never leave your computer on a sunny ledge or in a place where it could get splashed with moisture or covered in dust.
- ❖ Always travel with the computer in a carrying case. Toshiba offers a choice of carrying cases for the computer. They all provide plenty of extra space for manuals, power cables, diskettes, etc. See your dealer for more information.



NOTE: When traveling by air, you may be required to put your notebook through airport security. The X-ray equipment used will not harm your computer.

Chapter 5

Expansion Options

Your computer is designed to work in your office as well as on the road. This chapter explains how to set up several optional external devices so that your notebook can provide all the convenience of a traditional desktop computer.

To order additional devices and accessories, see the accessories information provided with your computer, or visit toshibaaccessories.com.

Using your computer at the office

By connecting an external full-size keyboard, an external monitor, a mouse and a printer, you can work with your computer as if it were a standard office model. You can connect a monitor and USB-compatible devices, such as the keyboard, mouse and printer, directly to the computer, or to the optional Slim Port Replicator.

For information on connecting a mouse and a printer, see the “Getting Started” chapter on page 35.

If you want to connect your computer to the office network, you can use the LAN port or your wireless LAN (Wi-Fi) capability.

Optional Slim Port Replicator

The optional Slim Port Replicator enhances your mobility because it provides a range of ports that enable you to connect to many expansion devices. The replicator provides more USB ports than the computer, enabling you to use more USB-compatible devices at the same time.

If you use the optional Slim Port Replicator, you cannot use the computer ports at the same time, since attaching the replicator makes the computer ports inaccessible.

Back of the optional Slim Port Replicator

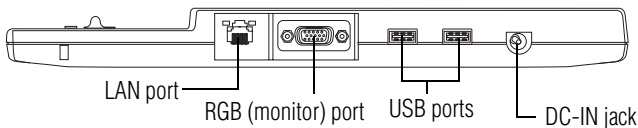

The **LAN port** lets you connect the computer to a local area network using a 10/100 Ethernet link.



The **RGB (monitor) port** lets you connect an external monitor. For more information, see [“Using an external monitor”](#) on page 97.



Use the **Universal Serial Bus (USB) ports** to connect the optional external USB diskette drive or other USB peripherals.



You can connect the AC adapter to the **DC-IN** jack on the optional Slim Port Replicator.

Front of the optional Slim Port Replicator

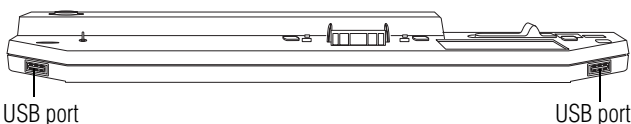



Use the **Universal Serial Bus (USB) ports** to connect the optional external USB diskette drive or other USB peripherals.

Using the optional Slim Port Replicator

The optional Slim Port Replicator connects to the expansion port on the bottom of the computer. When the port replicator is attached and the power is on, a small light illuminates.

Attaching the optional Slim Port Replicator to the computer

- 1 Make sure the computer is turned off.
- 2 Remove all connections from the back of the computer.

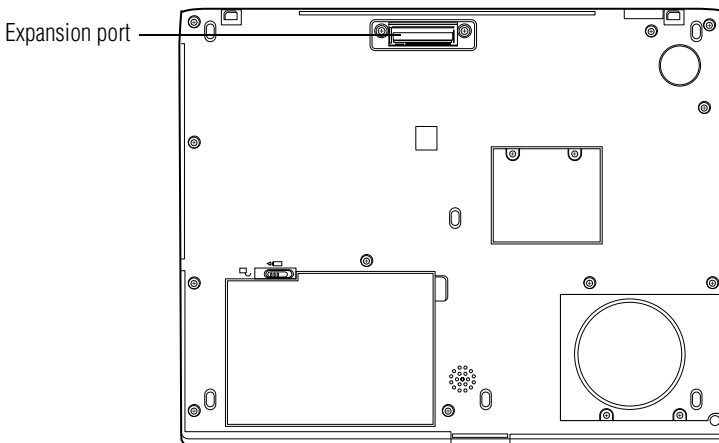

Computer's expansion port for connecting to optional Slim Port Replicator

- 3 Locate the expansion port on the bottom of the computer.

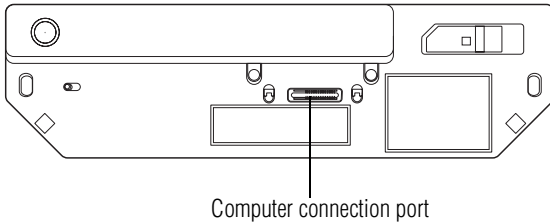

Optional Slim Port Replicator and where it attaches to your computer

- 4 Holding the computer firmly, connect the expansion port on the bottom of the computer to the connection port on top of the optional Slim Port Replicator.
- 5 Connect the replicator to a power source.

Connecting the optional external USB diskette drive

The optional external USB diskette drive allows you to use diskettes and is useful for installing software on the hard disk, exchanging information with other systems, and making backup copies of the files stored on your hard disk.

You can attach the optional external USB diskette drive to a USB port on the back of the computer or to any of the USB ports on the optional Slim Port Replicator. You can also attach it while the computer is on.

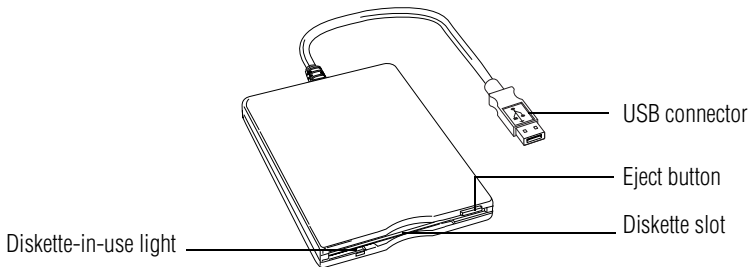
*Optional external USB diskette drive and connector cable*

TECHNICAL NOTE: You may attach the optional external USB diskette drive while the computer is on or off.

If you attempt to access the drive when it is not attached to the computer, you will receive an error message.

To attach the optional external USB diskette drive cable to a USB port on either the computer or the optional Slim Port Replicator, gently push the connector into the USB port.

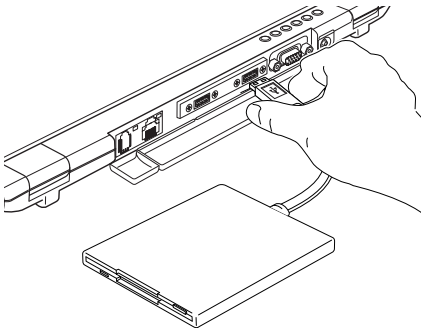

Attaching the optional diskette drive cable to one of the computer's USB ports.

The computer automatically recognizes the optional external USB diskette drive and calls it A:.

Using an external keyboard

If you prefer to use a standard keyboard, you can attach one to a USB port on the computer or on the optional Slim Port Replicator, provided the keyboard is USB-compatible.

Connecting a keyboard

You can connect a USB keyboard while the computer is on.

To connect the keyboard to the computer or the optional Slim Port Replicator, gently push the keyboard cable into the USB port.

Making your external keyboard emulate the Fn key

An external keyboard does not have the Fn key provided by the computer's built-in keyboard. You can use the Fn Key Emulation option in Toshiba Hardware Setup to assign an external keyboard key combination that will emulate the internal keyboard's Fn key.

In Toshiba Hardware Setup, you can emulate the Fn keys by setting key combinations in the keyboard option of the utility. See [“Toshiba Hardware Setup” on page 146](#) for more information.

Using an external monitor

If you prefer to use an external monitor, you can attach one to your computer's RGB (monitor) port or to the RGB (monitor) port on the optional Slim Port Replicator.

Connecting the monitor

- 1 If you are connecting the monitor to your computer or to the optional Slim Port Replicator, and the replicator is connected to your computer, turn off the computer.



NOTE: Make sure the computer is off before you attach the monitor. Connecting a monitor with the computer's power on may damage the monitor, the computer, or both.



- 2 Connect the monitor's video cable to the RGB (monitor) port on the computer or the optional Slim Port Replicator.
- 3 Connect the monitor's power cable to a power source.
- 4 Turn on the computer.
- 5 Turn on the external monitor.

The computer will use the external monitor and disable the built-in display panel.

If your external monitor can display high-resolution video modes (greater than 800 x 600), you can take advantage of this feature by changing the video mode in Display Properties in the Control Panel.

Using both screens simultaneously

You can view information on the computer's built-in display and an external monitor simultaneously. The size of the display image on each screen depends upon the video mode.

To send information to both the built-in display panel and the external monitor, change the Power On Display option.

To do this using the hot key:

- 1 Press Fn and F5 simultaneously.
- 2 While holding down Fn, press F5 repeatedly until you get the desired setting.

This hot key cycles through the settings in the following order: built-in display only, external monitor only, and simultaneous display.

- 3 Release the Fn key.
-



HINT: Simultaneous mode works only with external monitors that support 800 x 600 resolution and higher.

Connecting a mouse or a printer

For information on attaching a mouse or a printer, see “Connecting a mouse” on page 44 or “Connecting a printer” on page 45.

Using PC Cards

You may insert one Type I card or one Type II card into the computer’s PC Card slot. This slot contains a spacekeeper insert to keep dust and dirt out of the computer. If you are not using a PC Card, leave the insert in place. If you are using a PC Card, remove the insert and keep it in a safe place for future use.

PC Cards are credit-card sized expansion cards that greatly increase the capabilities of your computer.

Some PC Cards combine several functions. Multifunction cards allow you to get the most out of your PC Card slot.

Most PC Cards conform to the PCMCIA (Personal Computer Memory Card International Association) standard.



TECHNICAL NOTE: For PCMCIA-compatible PC Cards, check the package to make sure they conform to the PCMCIA 2.1 standard (or later). Other cards may work with your computer, but they are likely to be much more difficult to set up and use.

Inserting a PC Card

Before inserting a PC Card, read the documentation that came with the card to see if it has any special requirements.



HINT: The operating system provides the Card and Socket Services software for your PC Card. Even if your PC Card comes with its own version of Card and Socket Services, you should use the files included in the operating system.

To install a PC Card:

- 1 Locate the PC Card slot on your computer.

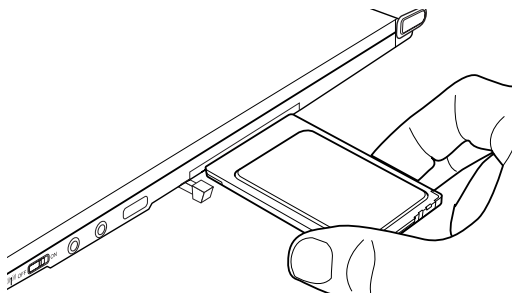

Inserting a PC Card into the slot

- 2 Insert the PC Card in the slot.
- 3 When the card is almost all the way into the slot, push firmly, but gently, to ensure a good connection with the computer. Don't force the card into position.

Removing a PC Card

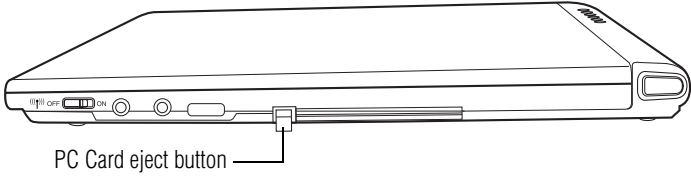

PC Card eject button

- 1** Press the PC Card eject button once to extend it, then press it again to remove the card.

The PC Card pops out about an inch.

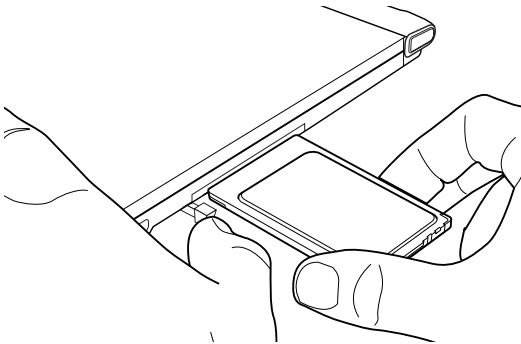

Removing the PC Card from the slot

- 2** Grasp the edges of the PC Card and carefully slide it out of the slot.

Hot swapping PC Cards

One of the great things about PC Cards is that you can replace one PC Card with another while the computer is on. This is called “hot swapping.”



DEFINITION: Hot swapping is the ability to change PC Cards while the computer is on.

Hot swapping precautions

Although you can insert a PC Card at any time, remember not to remove a card while it is in use. Otherwise, you could lose valuable information.

For example:

- ❖ Never remove a hard disk card or CD-ROM drive card while the system is accessing the card.
- ❖ Never remove a network card while you are connected to the network.
- ❖ Never remove a SCSI card while any of the SCSI devices connected to it are operating.



DEFINITION: SCSI is an acronym for Small Computer Systems Interface. A single SCSI PC Card enables you to connect several SCSI devices to your computer at the same time.

Before removing a PC Card, stop it by clicking the **PC Card** (PCMCIA) icon on the taskbar.

Using a Secure Digital card

Your computer supports the use of a Secure Digital media card.

Inserting a Secure Digital card

- 1 Turn the card so that the contacts (metal areas) are face down.

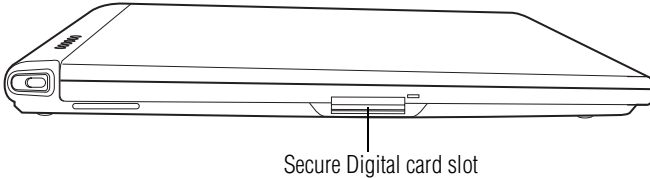

- 2 Push the card into the slot until it locks in place.

Removing a Secure Digital card

- 1 Right-click the Secure Digital drive's icon and select **Eject** from the pop-up menu.
- 2 Press the card inward to release it.
The card pops out slightly.
- 3 Lift the left side of the computer, grasp the card, and pull it straight out.

Chapter 6

Enhancing Productivity

In this chapter, you will explore other features of your notebook computer.

Windows® XP special features

The Windows® XP Professional operating system offers you several new features and enhancements, including:

- ❖ New system file protection
- ❖ A system restore function, allowing you to rollback the system to its previous mode
- ❖ An improved help center, support automation, and automatic Windows® operating system update
- ❖ Wizards to simplify setting up your home network
- ❖ Ability to share one Internet connection among multiple PCs
- ❖ An automatic discovery feature that allows your computer to detect new and intelligent devices

Personalizing your desktop

Your desktop is your virtual workspace. This section explains how to customize its features for the way you like to work. You can customize the following aspects of the desktop:

- ❖ Taskbar—which resources to display for quick access
- ❖ Web content interface—what information from the Internet to always display
- ❖ Desktop style—how windows are displayed and how to browse folders and files
- ❖ Toolbars—what information appears at the top of each window

Customizing the taskbar

As you work, the taskbar changes to reflect what you are doing. Its icons provide shortcuts to programs, documents, files, folders, system features, and components. Open applications also have Forward and Backward buttons to allow navigation through folders, documents, and Web sites.

For example, you can personalize the taskbar to include Quick Launch icons, and also your favorite URL addresses or local folders and programs.



DEFINITION: URL stands for Uniform Resource Locator, which is the address that defines the route to a file on the Web or any other Internet facility. Generically, it is known as the World Wide Web site address.

Having a list of favorite URLs handy saves time. Using it bypasses the need for you to launch your browser first.

To customize your taskbar settings, point to an empty space in the taskbar and click the secondary button. Then click **Properties**.

Bringing the world to your desktop

With the Windows[®] XP operating system you can set up your desktop with complete World Wide Web integration at a single click.

Turning on the Web content interface

The first step to bring active content to your desktop is to turn on the Web content interface:

- 1 Point to an empty space on the desktop and click the secondary button.
- 2 Click **Properties**.
The Display Properties window appears.
- 3 Click the **Desktop** tab.
- 4 Click the **Customize Desktop** button.
- 5 Click the **Web** tab.
- 6 Follow the instructions to set up your desktop.

Adding components to the Web content interface

- 1 Point to an empty space on the desktop and click the secondary button.
- 2 Click on **Properties**.
The Display Properties window appear.
- 3 Click the **Desktop** tab.
- 4 Click the **Customize Desktop** button.
- 5 Click the **Web** tab.
The operating system displays a list of items to add to the desktop.
- 6 To view additional components, click **New**.
The New Desktop Item dialog box appears.

- 7 To browse the Gallery for more components to add, click **Visit Gallery**.

In order to browse, an active Internet connection must be established.

- 8 To select some other Web site, type the address of the Web site you want or click **Browse** to locate it.

You can configure the Web content interface in several other ways. For further information, see your operating system documentation or access Windows® Help by clicking **Start, Help and Support**.

Changing desktop and browsing style

The operating system enables you to customize the way you view your desktop and browse the files and folders on your local computer or network file server.

You can specify that:

- ❖ Items that normally require a double-click will open with a single click.
- ❖ Folders will open in their own window instead of in the same window.
- ❖ Folders are accompanied by a list of common tasks instead of being displayed alone.

The options you choose determine how you browse in the operating system, regardless of whether you start from the desktop, My Computer, Windows Explorer, or Internet Explorer.

For more information about changing your desktop style, enter desktop in the Help and Support Index.

Choosing a style

To select desktop and browsing style options:

- 1 Click **Start**, then click **My Computer**.

The My Computer window appears.

- 2 Select the **Tools** menu, then click **Folder Options**.

The Folder Options dialog box appears.

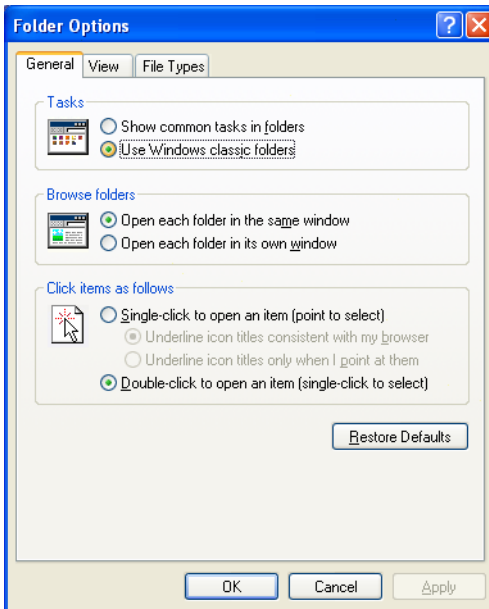

Sample Folder Options dialog box

- 3 Click the preferred options.
- 4 Click **Apply**, then **OK**.

Personalizing individual windows

Just as you can display a Web page on your desktop, you can also display a Web page in an individual window. If you subscribe to the Web page, it can be automatically updated on a regular basis. For example, using this Web integration feature you can monitor weather, game scores, stock prices, or headlines—all in the window of your choice.

Customizing window toolbars

You can display one or more customizable toolbars at the top of a window. As you browse, the operating system detects the kind of information presented in the window and automatically displays the appropriate toolbar buttons and menus.

You can also add these toolbars to the taskbar.

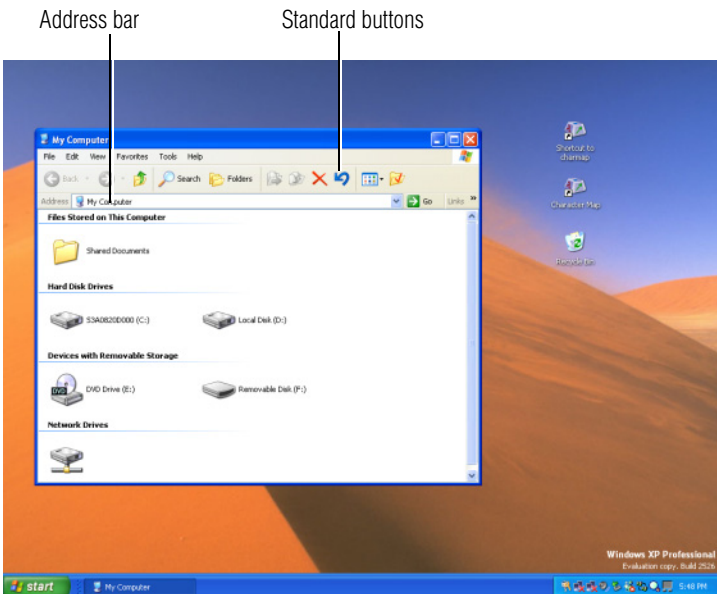

Sample toolbar locations

The elements you can add to the top of the window are:

Toolbar element *Description*

Address Bar Opens Web pages, programs, folders, or documents. By default, the address bar shows your current location, and whether it is a folder or a Web page. You can browse to another location by typing an address — a URL, a path, or even a program name.

If you start typing a previously typed address, the AutoComplete feature finishes the address for you.

Standard buttons Displays buttons for commonly used commands, such as copying, pasting, deleting items, changing views, and browsing backward and forward.

Displaying a toolbar in a window

- 1 Click **Start**, then click **My Computer**.

The My Computer window appears.

- 2 On the **View** menu, point to **Toolbars**, then click the name of the toolbar you want to display.

The toolbar appears below the menu bar of the current window.

Displaying information about each folder

In addition to displaying the contents of each window, you might find it helpful to have the operating system display the name of the folder and brief information about how to use the folder. This means displaying an individual window as a Web page.

- 1 Click **Start**, then click **My Computer**.

The My Computer window appears.

- 2 Open the folder you want to view as a Web page.
- 3 In the **Tools** menu, select **Folder Options**.
- 4 In the Tasks section, click the button for **Show common tasks in folders**.
- 5 Click **Apply**, then **OK**.

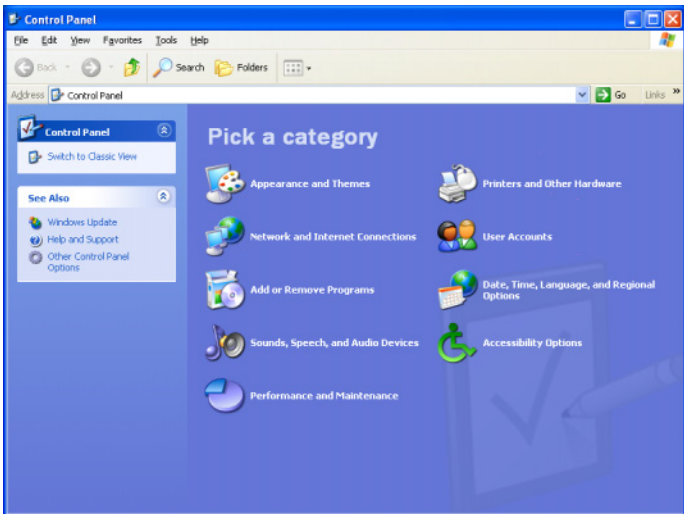

Sample Control Panel window as a Web page

The addition of the name of the folder and instructions for how to use the folder on the left give the window the appearance of a Web page.

Emulating a full-size keyboard

Although your computer's keyboard is compatible with a full-size 101/102-key enhanced keyboard, it has fewer keys.

Pressing the Fn key simultaneously in combination with one of several keys allows you to emulate a full-size keyboard. The keys are: Alt, Ctrl, cursor control mode, and numeric control mode. See [“Using the keyboard” on page 60](#) for the location of these keys.

Setting up for communications

In order to connect to the Internet, use an online service, or communicate across the telephone lines with another computer, you need:

- ❖ A modem (one comes with your computer)
- ❖ A telephone line
- ❖ A browser or communications program
- ❖ An Internet Service Provider (ISP) or online service if you plan to use the Internet

Determining the COM port

Your modem is connected to one of the computer's COM (communications) ports. The default setting for the modem is COM3.

The following procedure is intended to support you if you need to either upgrade your modem or reset the port to the default settings.

If you're having trouble connecting through the modem, you may need to determine the current COM port name and possibly change it.

To find out which port your modem is connected to in the operating system:

- 1** Click **Start**, click **Control Panel**, then **Printers and Other Hardware**.

The Control Panel opens.

- 2** Click **Phone and Modem options**.

The Phone and Modem options window appears.

- 3** Click the **Modems** tab.

A location box appears.

- 4 Make a note of the COM port number shown in the **Attached to** field.
- 5 To verify that the modem is set up properly, double-click the COM port to which your modem is connected.

The Modem AMR Properties box appears. In the device status area, the computer should indicate whether the modem is working properly.
- 6 If the modem isn't working properly, click **Troubleshooting** and follow the instructions.
- 7 Click **OK** to close the Properties box, then the Phone and Modem options box.
- 8 Close the Control Panel.

Using the Ethernet LAN Port

If your operating system is Windows® XP Professional, you can connect your computer to a Local Area Network (LAN) at work or from a remote location.

When your computer starts, the Windows® operating system attempts to contact a Dynamic Host Configuration Protocol (DHCP) server. If the computer is not connected to a network, it may pause a few minutes as it waits for a reply. To avoid this delay, you can configure the Windows® operating system to disable the LAN port.

To disable the LAN port:

- 1 Click **Start** and then click **Control Panel**.
- 2 Click **Performance and Maintenance**.
- 3 Click the **System** icon and select the **Hardware** tab, then select the **Device Manager** button
- 4 Select **Network Adapters**, then select the specific Network Adapter.
- 5 Secondary click the **Adapter** and click **Disable**.
- 6 Click **Yes** to confirm disabling the network card.

Your LAN port is now disabled.

Accessing a LAN

To access a LAN:

- ❖ At the office, you can connect the network Ethernet cable to the RJ45 jack on your computer.
- ❖ Your computer may be equipped for wireless communications. If so, see the next section on “Exchanging data with another computer.”
- ❖ From home or while on the road you’ll need a dial-up connection. Ask your network administrator for the telephone number to access the network.

Exchanging data with another computer

To transfer a large amount of information between your notebook and another computer with a compatible infrared port, you can use a special synchronization program.

- 1 Place the computers so that their infrared ports are aligned.
- 2 Load the synchronization program on both computers.
- 3 Set any specific options.
- 4 Start the transfer.
- 5 When you have finished transferring files, close the synchronization programs on both computers.

Transferring application files

There may be instances when you will need to transfer application files from the Recovery CD that comes with your computer. A CD-ROM drive is not a standard feature of the Portégé 2000, but you can transfer these files to your computer in the following ways:

- ❖ Use an external CD-ROM drive.

You can order a PORT-Noteworthy PC Card CD-ROM drive from Toshiba and install it in the PC Card slot on the right side of the computer. Alternatively, if you have a PC Card SCSI adapter, you can use a SCSI CD-ROM drive.

- ❖ Connect to a network.

You can access your Recovery CD by connecting your notebook to the office network. You then can upload the files on the CD from another computer with a CD-ROM drive onto a network server and download the files onto your notebook.

- ❖ Use the infrared port to connect your notebook to another computer that has a CD-ROM drive.

Setting up a direct cable connection

To establish a direct cable connection with another computer:

- 1 Click **Start, All Programs**.
- 2 Point to **Accessories, Communications**, and click **New Connection Wizard**.
- 3 Click **Next**.
- 4 Select **Set up an advanced connection**.
- 5 Click **Next**.
- 6 Select **Connect directly to another computer**.
- 7 Choose the appropriate role for your computer:
 - ❖ Guest
 - ❖ Host
- 8 Follow the on-screen instructions.

Using SPANworks™ 2000

The SPANworks 2000 application offers enhanced communication between networked computers. You can do

such things as transfer files between two computers, broadcast a slide presentation simultaneously to several machines, set up electronic business cards, and send text messages to a few people or to everyone in your proximity.



NOTE: Before using SPANworks, you must establish a network link between computers.

SPANworks 2000 supports communication over a wired LAN or a wireless LAN.

To access SPANworks 2000:



- 1 Double-click the **SPANworks** icon on the desktop.
- 2 Follow the instructions on your screen to set up a connection to the network.

To transfer a large amount of information between computers, you can use the Windows[®] XP Briefcase or a specialized synchronization program and the computer's infrared port.



TECHNICAL NOTE: Toshiba recommends that you start the SPANworks 2000 application after closing all other applications. This will ensure system resources are available since, in the presentation function, SPANworks 2000 may stop opening a presentation if the amount of remaining system resources is less than required.

Using audio features

Your computer is equipped with a built-in monaural speaker.

The computer plays sounds through the internal speaker. It uses the sound settings in your operating system, except for the system speaker, which is configured by the Toshiba

System utility. To adjust the volume, click the speaker icon in the taskbar.

Using external speakers or headphones

Instead of using the internal speaker, you can connect headphones or a pair of external stereo speakers.



TECHNICAL NOTE: Use amplified speakers that require an external power source. Other types of speakers will be inadequate to produce sound from the computer.

To play back sound files through external speakers or headphones:



- 1 Locate the headphone jack on the computer.
- 2 Using any necessary adapters, plug the cable from the headphones or external speakers into the headphone jack.



To adjust the volume:

- ❖ For external speakers, use the volume controls on each speaker.
- ❖ For headphones, use the Fn +1 (volume decrease) and Fn+2 (volume increase) key combinations.

Recording sounds

The external microphone may be used with other software to record monaural audio sounds and save them as digital audio.WAV files on disk.



DEFINITION: A .WAV (pronounced "wave") file is the format for storing sound in files.

118 **Enhancing Productivity**

Using audio features

You may also record sounds as .WAV files by connecting an external microphone or other sound source to the microphone jack.

Using a microphone

- 1 Connect an external microphone to the computer.
- 2 Click **Start**, point to **All Programs, Accessories, Entertainment**, then click **Sound Recorder**.

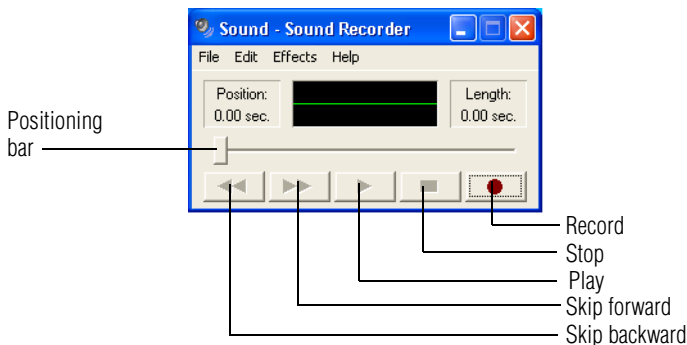

Sample Sound Recorder screen



- 3 Click the **Record** button and speak normally into the microphone.



NOTE: You can only record 60 seconds at a time.



- 4 When you have finished recording, click the **Stop** button.



- 5 To hear what you just recorded, click the **Play** button.

- 6 To save the file, select **Save** from the **File** menu.

Adjusting recording settings

The better the quality of the recording, the more disk space the sound file requires. Experiment to find a balance that fits your needs.

- 1 Open Sound Recorder, if necessary (click **Start**, point to **All Programs, Accessories, Entertainment**, then click **Sound Recorder**).
- 2 In the Sound Recorder window, click **Edit**, then click **Audio Properties**.
- 3 In the Audio Properties dialog box, adjust the Recording Volume and Preferred device.
- 4 Click **OK**.

Your new settings take effect the next time you record.

Powering down the computer

When you power down the computer, you have a number of options to choose from:

- ❖ Turn Off or Shut down, which power off the computer.
- ❖ Hibernation, which saves the current operating state to the hard disk and powers off the computer
- ❖ Standby, which saves the current operating state to memory and enters a low power mode
- ❖ Restart, which restarts the computer

Each option has its advantages.



TECHNICAL NOTE: Before using any of these options to power down your computer, save your files and make sure the disk activity lights are off.

If you change your mind and decide to continue working after all, wait a few seconds before turning the computer on again.

Turn Off or Shut down command

The Turn Off or Shut down commands power off the computer. The Windows[®] XP Professional operating system uses Turn Off if you are not connected to a Windows[®] network server (domain server). It uses Shut down if you are connected to a Windows[®] network server (domain server).

Factors to consider when choosing Turn Off or Shut down:

- ❖ No power is used while the computer is turned off. This is the most efficient mode if you will be away from your computer for an extended time.
- ❖ Restarting from Turn Off or Shut down uses the most time and battery power.
- ❖ When starting up again, the system does not automatically open the programs and files you were previously using.

Restart command

Restart is the same as Turn Off or Shut down but automatically powers up the computer. Use it when you need to reload the operating system, for example to activate changes to system settings.

Hibernation command

The Hibernation command powers off the computer, but it first saves the current state of the computer to the hard disk. Since Hibernation does not require power to maintain the saved information, the system settings are retained indefinitely. Restoring information from the hard disk takes longer than restoring it from memory. When you start up again, the computer runs a self-test, loads the operating system, and then returns to the state in which you left it.

Factors to consider when choosing Hibernation:

- ❖ While in Hibernation mode, the computer uses no battery power.

- ❖ Because the state of the system is held on the hard disk, no data is lost if the battery discharges while the computer is in Hibernation mode.
- ❖ When starting up again, this choice uses less time and battery power than the Turn Off or Shut down option. But it uses a little more time and battery power to start up than the Standby option, because information is being retrieved from the hard disk instead of from memory.
- ❖ On restarting, the computer returns to the state in which you left it, and opens all the programs and files you were using.

Standby command

The Standby command puts the computer into a power-saving mode. Standby stores the current state of the computer in memory so that, when you restart the computer, you can continue working from where you left off.

Factors to consider when choosing Standby:

- ❖ While in Standby mode, the computer uses some battery power. If your computer is left in Standby mode for an extended period, your computer could lose data.
- ❖ When starting up again, this choice uses less time and battery power than either Turn Off, Shut down or Hibernation.
- ❖ On restarting, the computer returns to the state in which you left it, and opens all the programs and files you were using.



NOTE: If you power down using the Standby command and the battery discharges fully, your information will be lost. Be sure to save your work often.

Using Turn Off or Shut down

If you are not connected to a Windows® network server (domain server), power off the computer as follows:

To turn off the computer.

- 1 Click **Start, Turn off computer.**

The Turn off computer window appears.

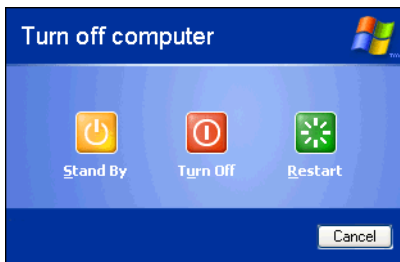

Sample Turn off computer window

- 2 Click **Turn Off.**

The computer turns itself off.

If you are connected to a Windows® network server (domain server), power off the computer as follows:

- 1 Click the **Start** button, then **Shut down.**

The Shut Down window appears.

- 2 Select **Shut down** from the drop-down list.
- 3 Click **OK.**

The computer shuts down completely.

Turning off more quickly

In addition to the method described above, you can turn off the computer by pressing the power button.

To use this method, you first need to turn on the feature in TOSHIBA Power Saver.

1 Click **Start, Control Panel**.

The Control Panel window appears.

2 Click **Performance and Maintenance**.

3 Double-click the **TOSHIBA Power Saver** icon.

The TOSHIBA Power Saver Properties window appears.

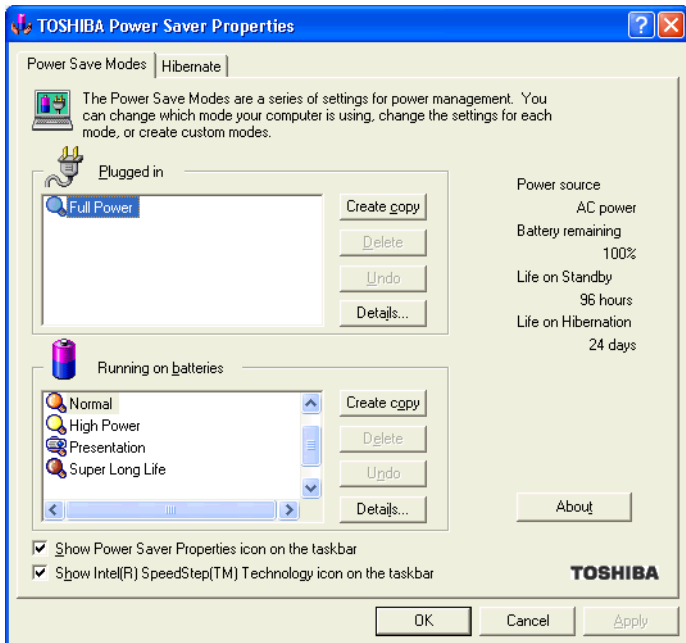

Sample TOSHIBA Power Saver Properties window

- 4 Click **Details** in the Running on batteries section.
The Full Power Properties window appears.
- 5 Click the **System Power Mode** tab.

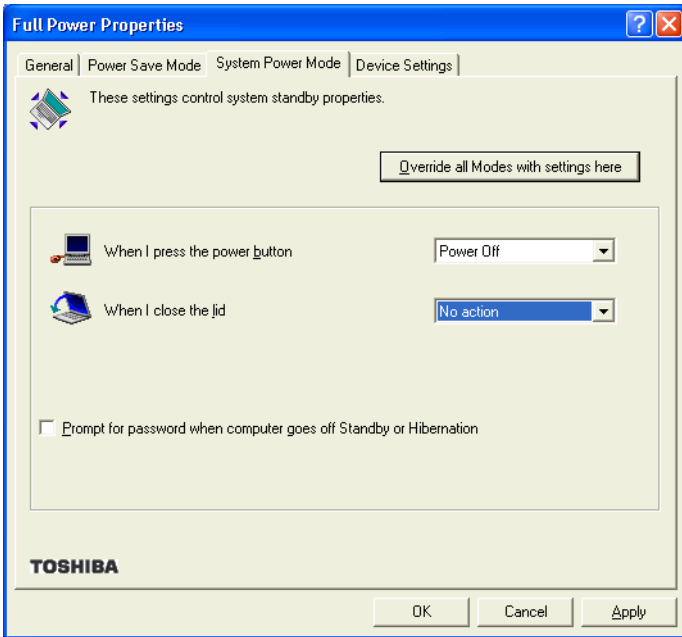

Sample Full Power Properties window

- 6 Select **Power Off** for the option you want.
 - ❖ **When I press the power button**
Set this option to Power Off if you want the computer to turn off when you press the power button.

7 Click **Override all Modes with settings here.**

The Set the range window appears.

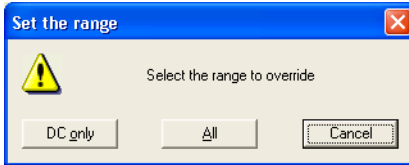

Sample Set the range window with DC only option

8 Do one of the following:

- ❖ Click **DC only** if you want the settings to apply only when you are using battery power.
- ❖ Click **All** for the settings to apply whether you are using battery power or outlet power.

9 Click **OK** to close the Full Power Properties window.

10 Click **OK** to close the TOSHIBA Power Saver Properties window, then close the Control Panel.

Starting again after Turn Off or Shut down

To start the computer up again, press and release the power button; the on/off light changes to green.

Using Hibernation

Enabling the Hibernation command

Hibernation is a default setting. If it should become disabled, you can enable it as follows:

1 Click **Start, Control Panel.**

The Control Panel window appears.

2 Click **Performance and Maintenance.**

3 Double-click the **TOSHIBA Power Saver** icon.

The TOSHIBA Power Saver Properties window appears.

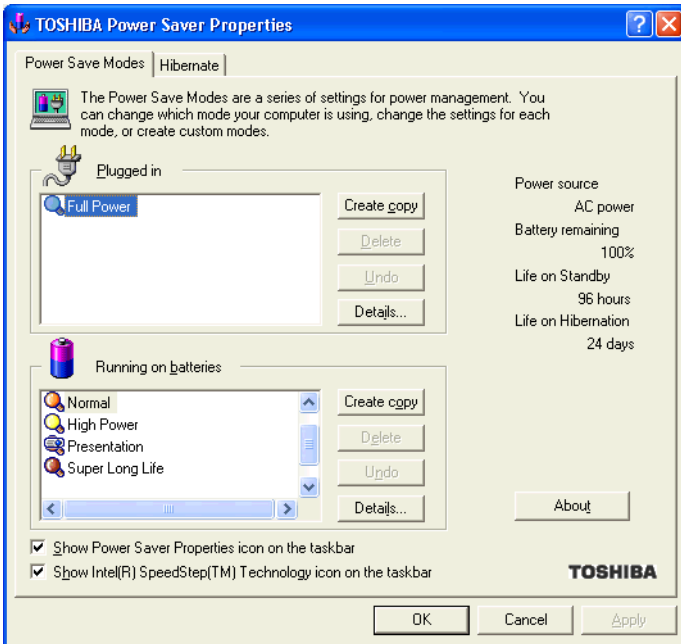

Sample TOSHIBA Power Saver Properties window

- 4 In the Running on batteries area, click the **Details** button.
- 5 Click the **System Power Mode** tab.
- 6 Select **Hibernation** for the options you want.
 - ❖ **When I press the power button**
Set this option to Hibernation so that the computer will go into Hibernation mode when you press the power button.
 - ❖ **When I close the lid**
Set this option to Hibernation so that the computer will go into Hibernation mode when you close the display panel.
- 7 Click **Override all Modes with settings here**.

The Set the range window appears.

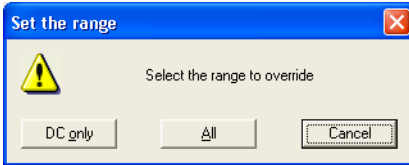

Sample Set the range window with DC only option

- 8 Do one of the following:
 - ❖ Click **DC only** if you want the settings to apply only when you are using battery power.
 - ❖ Click **All** for the settings to apply whether you are using battery power or outlet power.
- 9 Click **OK** to close the Full Power Properties window.
- 10 Click the **Hibernate** tab, then click the **Enable hibernate support** check box.
- 11 Click **OK** to close the TOSHIBA Power Saver Properties window, then close the Control Panel.

Going into Hibernation mode

If you are not connected to a Windows® network server (domain server), power off the computer using the Hibernation command as follows:

- 1 Click **Start, Turn off computer.**

The Turn off computer window appears.

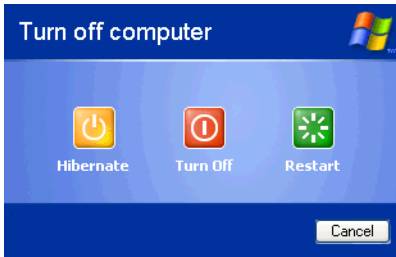

Sample Turn off computer window with shift key held down to show Hibernate option

- 2 Hold down the shift key and click **Hibernate** (“Hibernate” only appears when the shift key is pressed).

The computer saves the state of the system, including all open programs and files, to the hard disk, and then powers down completely.

If you are connected to a Windows® network server (domain server), follow these steps to power down the computer using Hibernation:

- 1 Click **Start**, then **Shut Down**.

The Shut Down window appears.

- 2 Select **Hibernate** from the drop-down list of options.
- 3 Click **OK**.

The computer saves the state of the system, including all open programs and files, to the hard disk, and then powers down completely.

Going into Hibernation mode more quickly

You can also put the computer into Hibernation mode in three ways:

- ❖ By pressing the hotkey combination Fn+F4.
- ❖ By pressing the power button

- ❖ By closing the display panel.

Starting again from Hibernation

To start up the computer from Hibernation mode, press and release the power button until the on/off icon glows green. The computer returns to the screen you were using.

If you went into Hibernation mode by closing the display panel, you can start the computer again by opening the display panel.

Using Standby

If you are not connected to a Windows® network server (domain server), power down the computer using the Standby command as follows:

- 1 Click **Start, Turn off computer**.

The Turn off computer window appears.

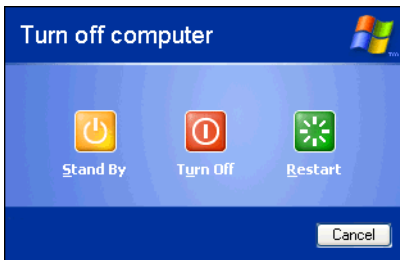

Sample Turn off computer window with Stand By option

2 Click Stand By.

The computer saves the state of all open programs and files to memory, turns off the display, and goes into a low-power mode. The on/off light (⏻) blinks amber indicating the machine is in Standby mode.

If you are connected to a Windows® network server (domain server), power down the computer using the Standby command as follows:

1 Click the Start button, then select Shut down.

The Shut Down window appears.

2 Select Stand by from the drop-down list of options.**3 Click OK.**

The computer saves the state of all open programs and files to memory, turns off the display, and goes into a low-power mode. The on/off light blinks green to indicate the machine is in Stand by mode.



NOTE: If you power down using the Standby command and the battery discharges fully, your information will be lost. Be sure to save your work often.

Going into Standby mode more quickly

You can also put the computer into Standby mode in three ways:

- ❖ By pressing the hot key combination Fn+F3.
- ❖ By pressing the power button
- ❖ By closing the display panel.

To put the computer into Standby mode when you press the power button or close the display panel, you must preset the mode:

1 Click **Start, Control Panel**.

The Control Panel window appears

2 Click **Performance and Maintenance**.

3 Double-click the **TOSHIBA Power Saver** icon.

The TOSHIBA Power Saver Properties window appears.

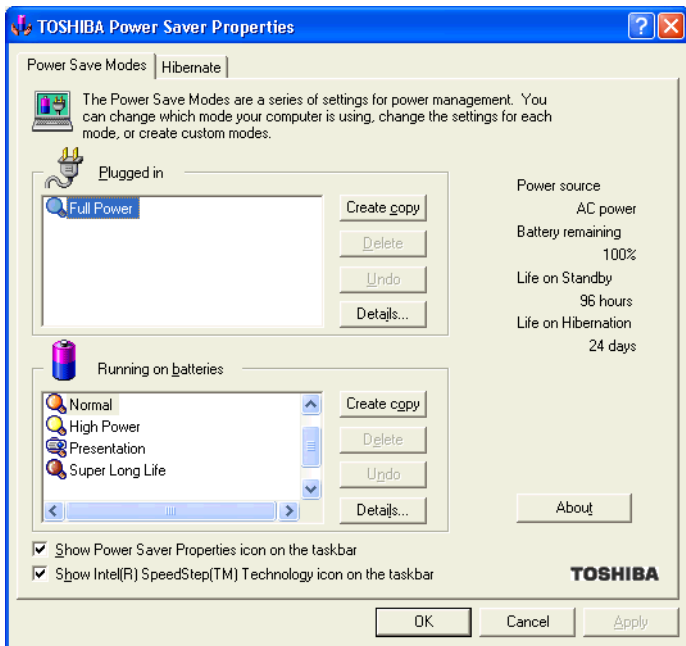

Sample TOSHIBA Power Saver Properties window

4 Click **Details** in the Running on batteries section.

The Full Power Properties window appears

5 Click the **System Power Mode** tab.

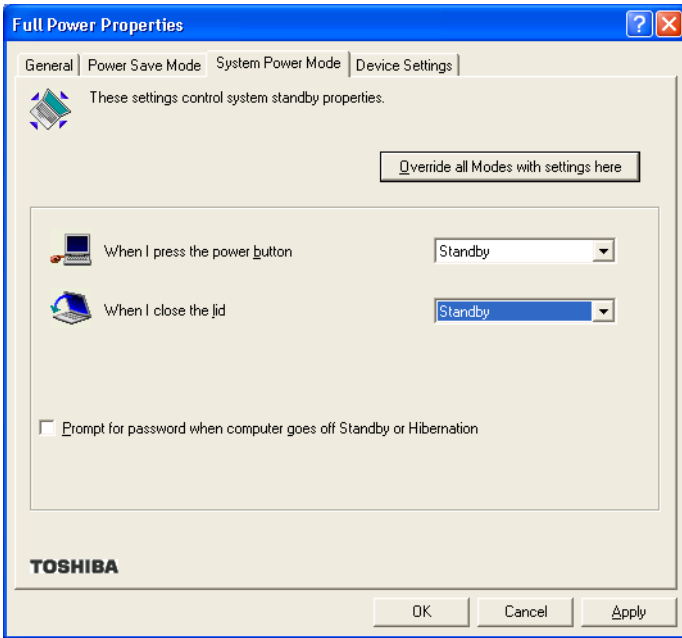

Sample Full Power Properties window

6 Select **Standby** for the options you want.

❖ **When I press the power button**

Set this option to Standby so that the computer will go into Standby mode when you press the power button.

❖ **When I close the lid**

Set this option to Standby so that the computer will go into Standby mode when you close the display panel.

❖ **When the system standby time has passed**

Set this option to Standby if you want the computer to automatically go into Standby mode when you haven't used it for a specified amount of time. You

can set the System standby time on the Power Save Mode tab.

7 Click **Override all Modes with settings here.**

The Set the range window appears.

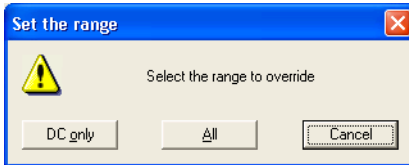

Sample Set the range window with DC only option

8 Do one of the following:

- ❖ Click **DC only** for the settings to apply only when you are using battery power.
- ❖ Click **All** for the settings to apply whether you are using battery power or outlet power.

9 Click **OK** to close the Full Power Properties window.

10 Click **OK** to close the TOSHIBA Power Saver Properties window, then close the Control Panel.

Starting again from Standby

To start up the computer from Standby mode, press and release the power button until the on/off light changes to green. The computer returns to the screen you were using.

If you put the computer in Standby mode by closing the display panel, you can start the computer again by opening the display panel.

Chapter 7

Toshiba Utilities

Your computer includes several utilities designed to help you to reconfigure your system to best meet your individual needs. Together, these allow you to ascertain certain system details, set additional options, or change default options. These utilities are described in this chapter:

- ❖ Fn-esse®
- ❖ Hotkey utility
- ❖ TOSHIBA Mobile Extension Service Configuration
- ❖ TOSHIBA Console

Fn-esse

The operating system shortcuts and Toshiba's Fn-esse program provide quick ways to open programs, documents, and folders from within any program without using the Start menu.

This section describes how to use the Fn-esse program to quickly access your programs and files.

With Fn-esse, you can assign an Fn key combination to:

- ❖ Open a Windows® program
- ❖ Open a file in its associated Windows® program
- ❖ Display a customized folder of Windows® programs and/or files from which to choose

Fn-esse also has several keys, known as hot keys, that perform preassigned operations. For more information, see [“Hot Keys” on page 178](#).

You can assign any key that is not associated with a hot key or a keyboard overlay.

Starting Fn-esse

You can access Fn-esse in one of two ways:

- ❖ Click **Start, All Programs, Toshiba Utilities and Fn-esse**.
- ❖ Click on the Fn-esse icon.

The Fn-esse keyboard appears.

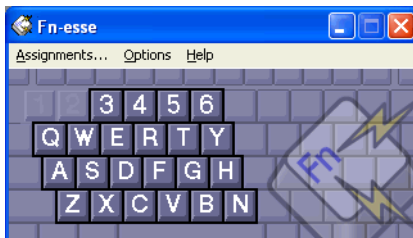

Sample Fn-esse keyboard

The keys are color-coded as follows:

- ❖ Available keys are black.
- ❖ Assigned keys and keys associated with a popup list are shown on the Fn-esse keyboard in the selected color.
- ❖ Unavailable keys are dark gray.

Assigning a key to a program or document

There are two ways to assign a key to open a program or document:

- ❖ Drag-and-drop
- ❖ Use the keyboard or pointing device

The method most often used is drag-and-drop.

Using drag-and-drop

To assign a key to a program or document:

- 1 Start both Fn-esse and Windows® Explorer (or the program supporting drag-and-drop).
- 2 Resize the Explorer window so that you can see both the Fn-esse keyboard and Explorer at the same time.
- 3 In the Explorer window, highlight the program or document file you wish to assign to a key.
- 4 Click and hold the primary button as you drag the highlighted item from Explorer to the key on the Fn-esse keyboard you want to assign to it.
- 5 Release the primary button.

Fn-esse displays the Add/Edit Command dialog box with the Description, Command Line, and Working Directory fields automatically completed.

- 6 Click **OK** to close the Add/Edit Command dialog box with your key assignment in place.

The program or document is now associated with the key you just selected. To open the program or document, press Fn plus the appropriate key from within any Windows® program.

Using the keyboard or pointing device

To assign a key to open a program or document:

- 1 Start Fn-esse.
- 2 Perform one of the following:
 - ❖ Using the keyboard, press and hold the Fn key, then press the desired assignment key.
 - ❖ Using the pointing device, move the cursor over the desired key and press the secondary button.

The Assignment Type dialog box appears.



HINT: If you are making a direct key assignment, complete step 3. If you are making a popup assignment, complete step 4.

- 3 To make a direct key assignment, select **Direct** to display the Add/Edit Command dialog box, then complete these steps:
 - ❖ Enter the Description, Command Line, and Working Directory for the new Fn-esse key assignment, or click the **Browse** button to specify this information.
 - ❖ Click **OK**.
- 4 To make a popup assignment, select **Popup** to display the Application Explorer dialog box, then complete these steps:
 - ❖ Select the desired folder. The left side of the Application Explorer window displays the folders in the Programs menu. The right side lists the programs and documents in the folder. These are the items that appear in the popup list.
 - ❖ To create a popup list with items from various folders, or to pick only a few items from a folder, create a new folder containing only the desired programs and documents. If you are unsure how to

do this, refer to your operating system documentation.

- ❖ Click **OK** to associate the folder with the key you just selected.
- ❖ To open a popup list showing the items in that folder, press Fn plus the appropriate key from within any Windows[®] program.

Viewing existing key assignments

To view the existing key assignments, choose **Assignments** from the Fn-esse keyboard. Fn-esse displays the Function Key Assignments dialog box. This box lists all the key assignments and the program or document to which each key is assigned.

To view items in a popup list, click the **Expand popup lists** check box.

Changing or removing existing key assignments

- 1 In the Fn-esse keyboard, click the key you wish to change with the secondary button.
Fn-esse displays the Assignment Type dialog box.
- 2 To change the key assignment, click **Direct** or **Popup** and continue as if you were creating a new assignment.
- 3 To remove the key assignment, click **Clear**.

Hotkey utility

The hotkey utility allows you to receive a confirmation message when you use the hot key combination for Standby [Fn+F3] and Hibernation [Fn+F4].

To activate the utility:

- 1 Click **Start**, then click **Hotkey utility**
The Hotkey window appears.

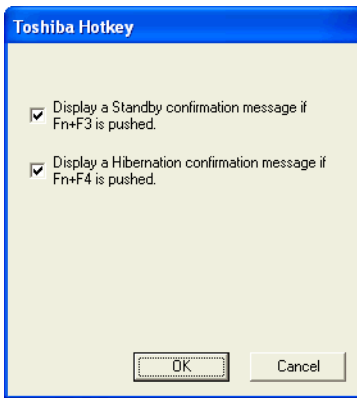

Sample Toshiba Hotkey utility window

- 2 Put a check mark next to the desired option.
- 3 Click **OK**.

Expansion device properties

To adjust the settings for the optional Slim Port Replicator, use the TOSHIBA Mobile Extension Service Configuration utility.

Accessing Mobile Extension Service Configuration

You can access the Mobile Extension Service Configuration utility in either of the following ways:

- ❖ Click the **TOSHIBA Console** button and **Slim Select Bay & Docking** icon.
- ❖ Click **Start, Control Panel, Performance and Maintenance, TOSHIBA Mobile Extension**.

The TOSHIBA Mobile Extension Service Configuration window appears.

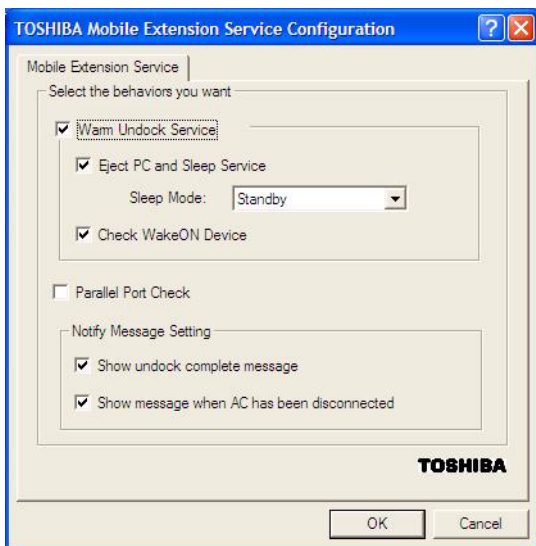

Sample TOSHIBA Mobile Extension Service Configuration window

TOSHIBA Console

The TOSHIBA Console provides quick access to computer functions and allows you to customize a range of computer settings.

You can normally access this utility in two ways:

- ❖ Press the TOSHIBA Console button located above the F12 key on your keyboard.
- ❖ Use the Start menu, as follows.
 - 1 Click **Start**, then click **All Programs**.
 - 2 Point to **TOSHIBA Console**, then click the resulting **TOSHIBA Console** selection.

The TOSHIBA Console window appears.



Sample TOSHIBA Console window

The TOSHIBA Console offers three categories of features:

- ❖ Customize Your Computer
- ❖ Network
- ❖ Security

Customize Your Computer

The features available in this category are:

- ❖ Power Management
- ❖ TOSHIBA Button Controls
- ❖ Mouse
- ❖ Hotkey assignment (for detailed information, see [“Fn-esse” on page 134](#))
- ❖ Toshiba Hardware

Network

The feature in this category is the IR Utility.

Security

The features available in this category are:

- ❖ Supervisor password
- ❖ User password

TOSHIBA Button Controls

The TOSHIBA Button Controls allow you to enable or disable the TOSHIBA Console and Internet buttons and the programs associated with them. Those buttons are located just above the function keys at the top of the keyboard.

To access these controls:

- 1 In the TOSHIBA Console window, click **TOSHIBA Button Controls**.

The TOSHIBA Controls Properties window appears.

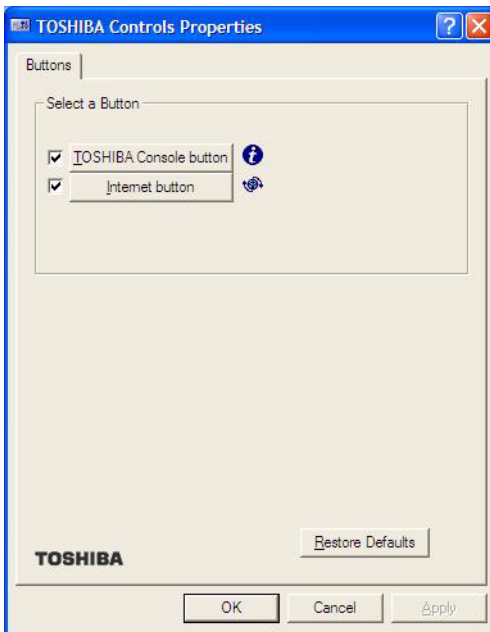

Sample TOSHIBA Controls Properties window

- 2 Click the **Buttons** tab
- 3 Check the boxes for the TOSHIBA Console button and/or the Internet button.
- 4 Under Select a Program, make the desired selections.
- 5 Click **Apply**, then click **OK**.

Power Management

The Power Management feature enables you to control your computer's power usage, regardless of the source, and use the many preset power modes, or create one yourself.



To access Power Management through the TOSHIBA Console, double-click the **Power Management** icon.

The TOSHIBA Power Saver Properties window appears.

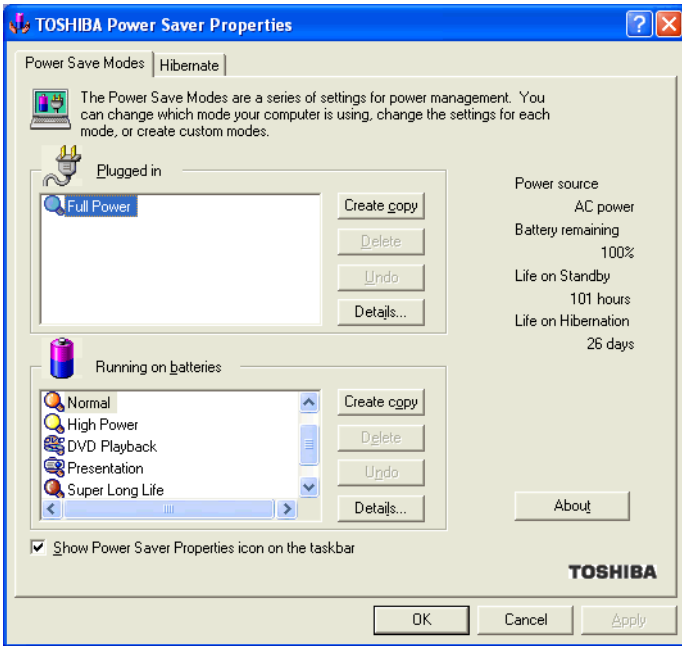

Sample TOSHIBA Power Saver Properties window

The Power Save Modes tab shows the power usage modes for both AC power (“Plugged in”) and battery power (Running on batteries”).

You can either use one of the preset modes or create and use your own customized mode. The preset modes cannot be deleted.

By changing the options that appear in the Toshiba Power Saver Properties window and clicking **OK**, you can reconfigure that function. Any options that you change become effective when you click either **OK** or **Apply**.

Plugged in section

This section has a single preset power usage mode — Full Power. You can create other AC power modes, but Toshiba recommends use of the preset Full Power mode.

The windows and settings for creating and customizing AC power modes are described below.

Running on batteries section

This section lists the preset modes along with the estimated battery life for each mode. The preset modes are:

- ❖ Long Life
- ❖ Normal
- ❖ High Power
- ❖ Presentation
- ❖ Super Long Life

Although you can change the properties for any of these modes, this is not recommended. If you need a customized mode, create a new mode with the properties you require.

Creating a new power mode

- 1 Highlight one of the preset modes.
- 2 Click **Create copy**.
- 3 A new mode appears with the title “Copy *Name*” where *Name* is the title of the mode you copied. Delete this title, type in the name for your new power mode, then press Enter.

Customizing a power mode

- 1 Highlight the mode on the Power Save Modes window.
- 2 Click **Details...**

The Properties window for the selected mode opens with the General tab displayed.

This tab enables you to choose an icon for your power usage mode, describe the mode’s characteristics and, optionally, associate it with a program.

The Name field displays the name assigned to the mode in the Power Saver Properties window. You can change the name here if you wish.

Toshiba Hardware Setup

Toshiba Hardware Setup is the Toshiba configuration management tool. To access it:

In the **TOSHIBA Console**, double-click the **Toshiba Hardware** icon.

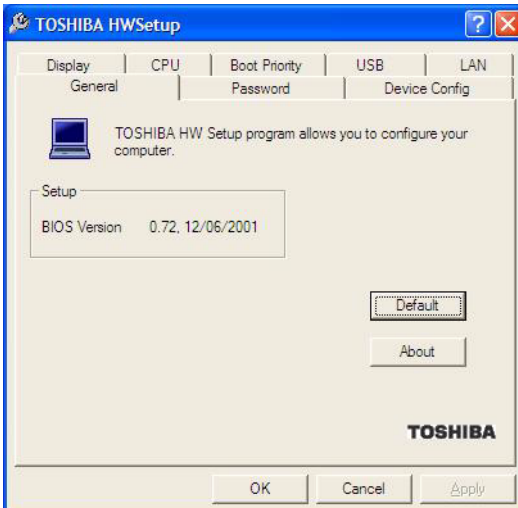

Sample TOSHIBA HWSetup window

The TOSHIBA HWSetup window appears with tabs for the following:

- ❖ **Display**—Allows you to change various default settings for the built-in LCD display.
- ❖ **CPU**—Allows you to enable or disable the processor serial number, and to set the “CPU Frequency Mode” to one of “Dynamically Switchable,” “Always High,” or “Always Low.”

-
- ❖ **Boot Priority** — Allows you to change the sequence in which your computer searches the drives for the operating system.

You can also manually choose the Boot Priority by pressing the power button, then quickly pressing the right or left arrow keys.

Select the boot device by pressing the right or left arrow keys, then pressing the Enter key.



NOTE: Since the system is a quick-booting system, you must press the arrow keys immediately after pressing the power button.

- ❖ **USB**—Allows you to enable or disable USB Legacy Emulation.

Choose the desired tab and accompanying options.

- ❖ **LAN** — Lets you enable or disable the Wake-up on LAN feature.
- ❖ **General** — Allows you to view current BIOS, hard disk drive and memory settings.
- ❖ **Password** — Allows you to set user passwords.
- ❖ **Device Config**—Shows the Device configuration options.

Chapter 8

If Something Goes Wrong

Some problems you may encounter when using your computer are relatively easy to identify and solve. Others may require help from your network administrator or the manufacturer of a software program.

This chapter aims to help you solve many problems by yourself. It covers the problems you are most likely to encounter.

If all else fails, contact Toshiba. You will find information on Toshiba's support services at the end of this chapter.

Problems that are easy to fix

Your program stops responding.

If you are working with a program that suddenly freezes all operations, chances are the program has stopped responding. You can exit the failed program without shutting down the operating system or closing other programs.

To close a program that has stopped responding:

- 1 Press **Ctrl, Alt, and Del** simultaneously (once).
- 2 Click **Windows Task Manager**.

The Windows Task Manager window appears.

- 3 Click the **Applications** tab.

If a program has stopped responding, the words “not responding” appear beside its name in the list.

- 4 Select the program you want to close, then click **End Task**.

Closing the failed program should allow you to continue working. If it does not, continue with step 5.

- 5 Close the remaining programs one by one by selecting the program name, then **End Task**.

To power off your computer, do one of the following:

If you are not connected to a domain server:

- 1 Click **Start, Turn off computer**.
- 2 The Turn off computer window appears.
- 3 Click **Turn Off**.

The computer turns off.

If you are connected to a domain server:

- 1 Click the **Start** button, then **Shut down**.
- 2 Select **Shut down** from the drop-down list.
- 3 Click **OK**.

The computer shuts down completely.

Your program performs an illegal operation.

If you receive the message, “Your program has performed an illegal operation,” you should record the details of the message and consult the software manufacturer.

To record the details:

- 1** Click the **Details** button and select the text the operating system displays.
The Details button displays information that the software manufacturer needs to help you solve your problem.
- 2** Press Ctrl and c simultaneously to copy the text to the clipboard.
- 3** Open Notepad (click **Start**, point to **All Programs**, then point to **Accessories** and click **Notepad**).
- 4** Press Ctrl and v simultaneously to paste the details into Notepad.
- 5** Add a paragraph break and type some notes describing what you were doing when you received the message.
- 6** Save the file and refer to it when you contact the software manufacturer.

Problems when you turn on the computer

These problems may occur when you turn on the power.

The computer will not start.

Make sure you attached the AC adapter and power cable properly or installed a charged battery.

Press and hold down the power button for a few seconds.

If you are using the AC adapter, check that the wall outlet is working by plugging in another device, such as a lamp.

The computer starts but, when you press a key, nothing happens.

You are probably in Stand By mode and have a software or resource conflict. When this happens, turning the power on returns you to the problem instead of restarting the system. To clear the condition, press Ctrl, Alt, and Del simultaneously.

Clearing the condition may get the computer running, but it won't solve a resource conflict. Read the documentation that came with the conflicting device and [“Resolving a hardware conflict” on page 154](#).

The computer is not accessing the hard disk or the optional external diskette drive.

Your computer normally loads the operating system from the hard disk. If you have a hard disk problem, you will not be able to start the computer. Insert a system diskette into the optional external diskette drive and press the left or right arrow key to choose it as your boot-up device.

The computer displays the WARNING RESUME FAILURE **message.**

The computer was placed in Stand By mode and the battery has discharged. Data stored in the computer's memory has been lost.

To charge the battery, leave the computer plugged into a live wall outlet for several hours. For more information, see [“Power and the batteries” on page 159](#).

The computer displays the Non-System disk **or** disk error **message.**

Make sure there is no diskette in the optional external diskette drive. If there is one, remove it and press any key to continue. If pressing any key does not work, press Ctrl, Alt, and Del to restart the computer.

The Windows® operating system is not working

Once you are familiar with the desktop and used to the way the operating system responds to your work routine, you can easily detect if the operating system is not working correctly. For example:

- ❖ The operating system fails to start after the Starting Windows XP message appears.
- ❖ The operating system takes a long time to start.
- ❖ The operating system responds differently from the normal routine.
- ❖ The screen does not look right.

Unless a hardware device has failed, problems usually occur when you change the system in some way such as installing a new program or adding a device.

If you experience any of these problems, use the options in the Startup menu to fix the problem.

Using Startup options to fix problems

If the operating system fails to start properly, you may have to change your system's configuration or verify the startup procedure to fix the problem. To do this, use the options in the Startup menu. This section describes each option and when to use the procedure.

To open the Startup menu:

- 1** Restart your computer.
- 2** Press F8 when your computer starts.

The Windows® Advanced Options menu displays these options:

- ❖ Safe Mode

-
- ❖ Safe Mode (with Networking)
 - ❖ Safe Mode (with Command Prompt)
 - ❖ Enable Boot Logging
 - ❖ Enable VGA Mode
 - ❖ Last known good configuration (your most recent settings that worked)
 - ❖ Directory Services Restore Mode (Windows® domain controllers only)
 - ❖ Debugging Mode
 - ❖ Start Windows® normally
 - ❖ Reboot
 - ❖ Return to OS Choices (menu)

See your Windows® documentation for further explanation.



TECHNICAL NOTE: If your computer is connected to a network, the Startup menu may display different versions of Safe mode.

Internet problems

My Internet connection is very slow.

Many factors contribute to the speed with which you can surf the Internet. They include: modem speed, time of day (when everyone else is surfing, your access can be slow) and popularity of the site. If accessing a particular site is very slow, try later.

My browser can't find the URL address I typed in.

Make sure you separated the domain names of the address with the forward slash (/). Check the spelling of each name and the syntax of the address carefully. A single incorrect letter or missed character, comma instead of period (“dot”) or

other mistake makes it impossible for your browser to locate the site.

My browser can't find a site I bookmarked.

The World Wide Web is constantly changing. A site you bookmarked yesterday may not be available today or its server may be down for temporary repair. Try again later.

The Windows® XP operating system can help you

If the operating system has started properly, but you still have a problem using your computer, the online Help can assist you in troubleshooting the problem.

To access Windows® XP Help and Support:

1 Click **Start**, then click **Help and Support**.

The Help and Support window appears.

2 Then do one or both of the following:

- ❖ In the search field, type in the topic on which you need help and follow the on-screen instructions.
- ❖ Click a problem you would like help with from the listings and follow the on-screen instructions.

You can connect to Support Online by clicking **Support** from the menu.

Resolving a hardware conflict

If you receive an error message telling you there is a device driver conflict or a general hardware problem, try using Windows® Help and Support to troubleshoot the problem first.

For help on hardware conflicts:

1 Click **Start**, then click **Help and Support**.

2 Click the **Hardware** link in the window's left pane.

A list of category links appear.

- 3 Click the **Fixing a hardware problem**.
- 4 Choose from specific topics and follow the steps.

If there is still a problem, the operating system should display a message that explains what the conflict is.

A plan of action

The smooth operation of the system depends on the interaction of all devices, programs, and features. If the system or one of its attached devices isn't working, resolving the problem can be time-consuming and frustrating.

The recommended procedure for getting multiple devices to work together is to add and set up one device at a time. After you add each device, test it to make sure it and all previously connected devices work.

The device most recently connected to the system is the one most likely to be causing a hardware conflict.

Resolving hardware conflicts on your own

Computer components need resources to accomplish a task. A device, such as a disk drive or a modem, needs a channel to the computer's Central Processing Unit (CPU). It also needs a direct channel to the computer's memory to store information as it works. These channels of communication are commonly referred to as system resources.

Interrupt Request Channel

The channel to the CPU is called an Interrupt Request (IRQ) because it interrupts what the processor is doing and requests some of the processor's time. If two or more devices use the same IRQ, the processor does not know which device is asking for attention. This causes a hardware conflict.

Direct Memory Access

Similarly, the data required by the device is stored in a specific place or address in memory called the Direct Memory Access (DMA). The DMA provides a dedicated channel for adapter cards to bypass the microprocessor and access memory directly. If two or more devices use the same DMA, the data required by one device overwrites the data required by the other, causing a hardware conflict.

Plug and Play

With Plug and Play and the operating system, avoiding hardware conflicts is easy. Plug and Play is a computer standard that helps the system BIOS (basic input/output system) and the operating system to automatically assign system resources to Plug and Play-compliant devices. In theory, if every device connected to the computer is Plug and Play-compliant, no two devices will compete for the same system resources. Plug in the device and turn on your computer. The operating system is automatically set up to accommodate the new device.

If you install an older (legacy) device that the operating system cannot recognize, the operating system may have difficulty assigning resources to it. As a result, a hardware conflict can occur.

Resolving conflicts

There are three things you can do to resolve hardware conflicts:

- ❖ Disable the device.
For an older device, remove it from the computer.
- ❖ Disable another system component and use its resources for the new device, see [“Fixing a problem with Device Manager” on page 157](#).

-
- ❖ Reconfigure the device so that its requirements do not conflict. Refer to the device's documentation for instructions about changing settings on the device.

Fixing a problem with Device Manager

Device Manager provides a way to check and change the configuration of a device.



CAUTION: Changing the default settings using Device Manager can cause other conflicts that make one or more devices unusable. Device Manager is a configuration tool for advanced users who understand configuration parameters and the ramifications of changing them.

Disabling a device

- 1 Click **Start, Control Panel, Administrative Tools**.
- 2 Click the **Computer Management** icon.
- 3 Select the specific device from the device category.
- 4 In the toolbar, look to the far right for an icon of a monitor with a strike mark through a circle on the front. This is the disable feature.
- 5 Click the icon.
You are given the option of disabling the device.
- 6 Click **yes** or **no**, whichever is appropriate.

Checking device properties

Device Manager provides a way to view the properties of a device. Properties include the name of the manufacturer, the type of device, the drivers installed, and the system resources assigned to the device.

To check a device's properties:

- 1 Click **Start, Control Panel, Administrative Tools**.
- 2 Click the **Computer Management** icon.
- 3 Click the **Device Manager** button.
- 4 To view the device(s) installed, double-click the device type.
- 5 To view the properties, double-click the device.

The operating system displays the Device Properties dialog box, which provides an array of tabs. They include:

- ❖ The **General** tab, which provides basic information about the device.
- ❖ The **Resource** tab, which lists resources assigned to the monitor, optional external diskette disk drive, and other power-using functions.
- ❖ The **Drivers** tab, which displays the drivers being used by the device.

A Troubleshooting button is also present.

- 6 Click **troubleshooting**.

A Help and Support window for that device appears.

For more information about Device Manager, refer to Windows® XP online help.

Memory card problems

Incorrectly connected or faulty memory modules may cause errors that seem to be device-related. It is worthwhile checking for these first:

- 1 Click **Start, Turn off computer**.
- 2 Click **Turn Off**.

The operating system shuts down and turns off the computer automatically.

- 3 Remove the memory module, following the instructions in [“Removing a memory module”](#) on page 44.
- 4 Reinstall the memory module, following the instructions in [“Installing additional memory \(optional\)”](#) on page 40, and making sure the module is seated properly.
- 5 Check for the error again.
- 6 If the error recurs, remove the memory module entirely and check for the error again.

If removing the memory module eliminates the error, the memory module may be faulty. If the error recurs without the memory module installed, the error is not caused by the memory module.

Power and the batteries

Your computer receives its power through the AC adapter and power cable or from the system batteries (main battery, optional high-capacity battery and real-time clock (RTC) battery). Power problems are interrelated. For example, a faulty AC adapter or power cable will neither power the computer nor recharge the batteries.

Here are some typical problems and how to solve them:

The AC power light does not come on when you plug in the AC adapter and power cable.

Make sure the AC adapter and power cable are firmly plugged into both the wall outlet and the computer.

If the AC power light still does not come on, check that the wall outlet is working properly by plugging in a lamp or other appliance.

The AC adapter and power cable work correctly, but the battery will not charge.

The battery doesn't charge while the computer is consuming full power. Try turning off the computer.

The main battery may not be inserted correctly in the computer. Turn off the computer, remove the battery, clean the contacts with a soft dry cloth (if necessary) and replace the battery. See [“Removing the battery from the computer” on page 88](#) and [“Inserting a charged battery” on page 89](#) for detailed instructions.

The battery may be too hot or too cold to charge properly. If you think this is the probable cause, let the battery reach room temperature and try again.

If the battery has completely discharged, it will not begin charging immediately. Leave the AC adapter and power cable connected, wait 20 minutes and see if the battery is charging.

If the battery light is glowing after 20 minutes, let the computer continue charging the battery for at least another 20 minutes before you turn on the computer.

If the battery light does not glow after 20 minutes, the battery may have reached the end of its useful life. Try replacing it.

The battery appears not to power the computer for as long as it usually does.

If you frequently recharge a partially charged battery, it may not charge fully. Let the battery discharge completely, then try charging it again.

Check the power options using the Power Management utility. Have you added a device, such as a PC Card or memory module, that takes its power from the battery? Is your software using the hard disk more? Is the display power set to turn off automatically? Was the battery fully charged to begin with? All these conditions affect how long the charge lasts.

For more information on maximizing battery power, see [“Charging batteries” on page 78](#).

Keyboard problems

If, when you type, strange things happen or nothing happens, the problem may be related to the keyboard itself.

The keyboard produces unexpected characters.

A keypad overlay may be on. If the numeric keypad or cursor control light is on, press Fn and F10 simultaneously to turn off the cursor control light or press Fn and F11 simultaneously to turn off the numeric keypad light.

If the problem occurs when both the keypad overlays are off, make sure the software you are using is not remapping the keyboard. Refer to the software's documentation and check that the program does not assign different meanings to any of the keys.

You have connected an external keyboard and the operating system displays one or more keyboard error messages.

If you have a second keyboard, try it. If it works, the first keyboard may be defective or incompatible with your computer.

Display problems

Here are some typical display problems and their solutions:

The screen is blank.

Display Auto Off may have gone into effect. Press any key to activate the screen.

You may have activated the instant password feature by pressing Fn and F1 simultaneously. If you have registered a password, press any key, type the password and press Enter. If no password is registered, press any key. The screen reactivates and allows you to continue working.

If you are using the built-in screen, make sure the display priority is not set for an external monitor. To do this, press Fn and F5 simultaneously (once). If this does not correct the

problem, press Fn and F5 simultaneously again to return the display priority to its previous setting.

If you are using an external monitor:

- ❖ Check that the monitor is turned on.
- ❖ Check that the monitor's power cable is firmly plugged into a working power outlet.
- ❖ Check that the cable connecting the external monitor to the computer is firmly attached.
- ❖ Try adjusting the contrast and brightness controls on the external monitor.
- ❖ Press Fn and F5 simultaneously to make sure the display priority is not set for the built-in screen.

The screen does not look right.

You can change the display settings by clicking a blank area of the desktop with the secondary control button, then clicking Properties. This opens the Display Properties dialog box. The Appearance tab of this dialog box allows you to choose the colors for the screen. The Settings tab allows you to choose the screen resolution.

The built-in screen flickers.

Some flickering is a normal result of the way the screen produces colors. To reduce the amount of flickering, try using fewer colors.

To change the number of colors displayed:

- 1** Point at the desktop and click with the secondary button.
- 2** Click **Properties**, and then the **Settings** tab.
- 3** Change the Colors option and click **OK**.

For more information, see Windows[®] Help.

A message tells you that there is a problem with your display settings and that the adapter type is incorrect or the current settings do not work with your hardware.

Reduce the size of the color palette to one that is supported by the computer's internal display.

To change the display properties:

- 1 Point at the desktop and click with the secondary button.
The Display Properties window appears.
- 2 Click **Properties**, then click the **Settings** tab.
- 3 Adjust the screen resolution and/or color quality.
- 4 Click **OK**.

The display mode is set to Simultaneous and the external display device does not work.

Make sure the external monitor is capable of displaying at resolutions of 800 x 600 or higher. Devices that do not support this resolution will only work in External monitor only mode.

Disk drive problems

Problems with the hard disk or with a diskette drive usually show up as an inability to access the disk or as sector errors. Sometimes a disk problem may cause one or more files to appear to have garbage in them. Typical disk problems are:

You are having trouble accessing a disk, or one or more files appear to be missing.

Make sure you are identifying the drive by its correct name (A: or C:).

Error-checking

Run Error-checking, which analyzes the directories, files and File Allocation Table (FAT) on the disk and repairs any damage it finds:

To run Error-checking:

- 1** Click **Start**, then click **My Computer**.
- 2** Right-click the drive you want to check.
The drive's Properties box appears.
- 3** Click the **Tools** tab.
- 4** Click the **Check now** button.
The Check Disk All Apps box appears.
- 5** You can choose one or both options:
 - ❖ Automatically fix file system errors
 - ❖ Scan for and attempt recovery of bad sectors
- 6** Click **Start**.

Error-checking tests and repairs the disk.

Your hard disk seems very slow.

If you have been using your computer for some time, your files may have become fragmented. Run Disk Defragmenter. To do this, click **Start**, then click **All Programs**, point to **Accessories** and **System Tools**, and click **Disk Defragmenter**.

Your data files are damaged or corrupted.

Refer to your software documentation for file recovery procedures. Many software packages automatically create backup files.

You may also be able to recover lost data using utility software. Consult your network administrator.

Some programs run correctly but others do not.

This is probably a configuration problem. If a program does not run properly, refer to its documentation and check that the hardware configuration meets its needs.

A diskette will not go into the optional external diskette drive.

You may already have a diskette in the drive. Make sure the drive is empty.

You may be inserting the diskette incorrectly. Hold the diskette with the hub side facing down, and insert it so that the metal head window cover goes into the drive first.

The metal cover or a loose label may be obstructing the path into the drive. Carefully inspect the diskette. If the metal cover is loose, replace the diskette. If the label is loose, replace the label and try inserting the diskette again.

The computer displays the Non-system disk or disk error **message.**

If you are starting the computer from a diskette, the diskette in the drive does not have the files necessary to start the computer. Replace it with a bootable diskette.

The drive cannot read a diskette.

Try another diskette. If you can access the second diskette, the first diskette (not the drive) is probably causing the problem. Run Error-checking on the faulty diskette (for instructions, see [“Disk drive problems” on page 163](#)).

Sound system problems

You do not hear any sound from the computer.

Adjust the volume control.

If you are using external headphones or speakers, check that they are securely connected to your computer.

The computer emits a loud, high-pitched noise.

This is feedback between the microphone and the speakers. It occurs in any sound system when input from a microphone is fed to the speakers and the speaker volume is too loud. Adjust the volume control.

Changing the settings for the Record Monitor feature in the Recording Control Utility (default Off), or the Mute feature in the Mixer Utility (default Enabled), may cause feedback. Revert to the default settings.

PC Card problems

PC Cards (PCMCIA-compatible) include many types of devices, such as a removable hard disk, additional memory, or a pager.

Most PC Card problems occur during installation and setup of new cards. If you're having trouble getting one or more of these devices to work together, several sections in this chapter may apply.

Resource conflicts can cause problems when using PC Cards. See [“Resolving a hardware conflict” on page 154](#).

Card Information Structure

When you insert a PC Card into a slot, the computer attempts to determine the type of card and the resources it requires by reading its Card Information Structure (CIS). Sometimes the CIS contains enough information for you to use the card immediately.

Other cards must be set up before you can use them. Use the Windows® XP PC Card (PCMCIA) Wizard to set up the card. Refer to your Microsoft® documentation for more information, or refer to the documentation that came with the PC Card.

Some card manufacturers use special software called *enablers* to support their cards. Enablers result in nonstandard configurations that can cause problems when installing the PC Card.

If your system does not have built-in drivers for your PC Card and the card did not come with an operating system driver, it may not work under the operating system. Contact

the manufacturer of the PC Card for information about using the card under the operating system.

PC Card checklist

- ❖ Make sure the card is inserted properly into the slot.
See “[Connecting a mouse or a printer](#)” on page 99 for how to insert PC Cards.
- ❖ Make sure all cables are securely connected.
- ❖ Occasionally a defective PC Card slips through quality control. If another PCMCIA-equipped computer is available, try the card in that machine. If the card malfunctions again, it may be defective.

Resolving PC Card problems

Here are some common problems and their solutions:

The slot appears to be dead. PC Cards that used to work no longer work.

Check the PC Card status:

- 1** Click **Start**.
- 2** Click **My Computer** icon with the secondary button, then click **Properties**.

The System Properties dialog box appears.

- 3** Click the **Hardware** tab.
- 4** Click the **Device Manager** button.
- 5** Double-click the **PCMCIA adapter**.
- 6** Double-click the appropriate PC Card.

The operating system displays your PC Card’s Properties dialog box, which contains information about your PC Card configuration and status.

The computer stops working (hangs) when you insert a PC Card.

The problem may be caused by an I/O (input/output) conflict between the PCMCIA socket and another device in the system. Use Device Manager to make sure each device has its own I/O base address. See [“Fixing a problem with Device Manager” on page 157](#) for more information.

Since all PC Cards share the same socket, each card is not required to have its own address.

Hot swapping (removing one PC Card and inserting another without turning the computer off) fails.

Follow this procedure before you remove a PC Card:

- 1 Double-click the **PC Card** icon on the taskbar.
- 2 Click **Safely remove xxxx**, where *xxxx* is the identifier for your PC Card.

The operating system displays a message that you may safely remove the card.

- 3 Remove the card from the slot.

The system does not recognize your PC Card.

Refer to the PC Card documentation.

Removing a malfunctioning card and reinstalling it can correct many problems. For more information, see [“Connecting a mouse or a printer” on page 99](#).

A PC Card error occurs.

Reinsert the card to make sure it is properly connected.

If the card is attached to an external device, check that the connection is secure.

Refer to the card’s documentation, which should contain a troubleshooting section.

Printer problems

This section lists some of the most common printer problems:

The printer will not print.

Check that the printer is connected to a working power outlet, turned on and ready (on line).

Check that the printer has plenty of paper. Some printers will not start printing when there are just two or three sheets of paper left in the tray.

Make sure the printer cable is firmly attached to the computer and the printer.

Run the printer's self-test to check for any problem with the printer itself.

Make sure you installed the proper printer drivers, as shown in ["Setting up a printer" on page 52](#).

You may have connected the printer while the computer is on. Disable Stand By mode, turn off the computer, and turn off the printer. Turn the printer back on, make sure it is on line, then turn the computer back on.

Try printing another file. For example, you could create and attempt to print a short test file using Notepad. If a Notepad file prints correctly, the problem may be in your original file.

If you cannot resolve the problem, contact the printer's manufacturer.

The printer will not print what you see on the screen.

Many programs display information on the screen differently from the way they print it. See if your program has a print preview mode. This mode lets you see your work exactly as it will print. Contact the software manufacturer for more information.

Modem problems

This section lists common modem problems:

The modem will not receive or transmit properly.

Make sure the cable from the modem to the telephone line is firmly connected to the computer's modem port and the telephone line jack.

Check the port settings to make sure the hardware and software are referring to the same COM port. See [“Determining the COM port” on page 112.](#)

Check the communications parameters (baud rate, parity, data length and stop bits) specified in the communications program. It should be set up to transmit at 300, 1200, 2400, 4800, 9600, 14400, 28800, 33600 bps (bits per second) or higher. Refer to the program's documentation and the modem manual for information on how to change these settings.



TECHNICAL NOTE: Disable Call Waiting before you connect through the modem. Call Waiting interrupts data transmission.

The modem is on, set up properly and still will not transmit or receive data.

Make sure the line has a dial tone. Connect a telephone handset to the line to check this.

The other system may be busy or off line. Try making a test transmission to someone else.

Develop good computing habits

Make sure you are prepared.

Save your work frequently.

You can never predict when your computer will lock, forcing you to close a program and lose unsaved changes. Many

software programs build in an automatic backup, but you should not rely solely on this feature. Save your work! See “Computing tips” on page 58 for instructions.

On a regular basis, back up the information stored on your hard disk.

Here are some ways you can do this:

- ❖ Copy files to diskette.
- ❖ Connect a tape drive to the system and use specialized software to copy everything on the hard disk to a tape.
- ❖ Connect your computer to the office network and copy files to your network partition.

Some people use a combination of these methods, backing up all files to tape weekly and copying critical files to diskette on a daily basis.

If you have installed your own programs, you should back up these programs as well as your data files. If something goes wrong that requires you to reformat your hard disk and start again, reloading all your programs and data files from a backup source will save time.

Read the user’s guides.

It’s very difficult to provide a fail-safe set of steps you can follow every time you experience a problem with the computer. Your ability to solve problems will improve as you learn about how the computer and its software work together.

Get familiar with all the user’s guides provided with your computer, as well as the manuals that come with the programs and devices you purchase.

Your local computer store or book store sells a variety of self-help books you can use to supplement the information in the manuals.

If you need further assistance

If you have followed the recommendations in this chapter and are still having problems, you may need additional technical assistance. This section contains the steps to take to ask for help.

Before you call

Since some problems may be related to the operating system or the program you are using, it is important to investigate other sources of assistance first.

Before contacting Toshiba:

- ❖ Review the troubleshooting information in your operating system documentation.
- ❖ If the problem occurs while you are running a program, consult the program's documentation for troubleshooting suggestions. Contact the software company's technical support group for their assistance.
- ❖ Consult your network administrator.
- ❖ Consult your authorized Toshiba representative, who is your best source for current information.

Contacting Toshiba

If you still need help and suspect that the problem is hardware-related, Toshiba offers a variety of resources to help you.

- 1 Start with accessing Toshiba on the Internet using any Internet browser by typing:
`pcsupport.toshiba.com`
- 2 Next, try one of Toshiba's online services. The Toshiba Forum can be accessed through CompuServe[®] by typing:
`go toshiba.`

Toshiba voice contact

Before calling Toshiba, make sure you have:

- ❖ Your computer's serial number.
- ❖ The computer and any optional devices related to the problem.
- ❖ Backup copies of your Windows® operating system and all other preloaded software on diskettes or CD-ROM.
- ❖ Name and version of the program involved in the problem along with its installation diskettes or CD-ROM.
- ❖ Information about what you were doing when the problem occurred.
- ❖ Exact error messages and when they occurred.

For technical support, call the Toshiba InTouch Center:

Within the United States at (800) 457-7777

Outside the United States at (949) 859-4273

Other Toshiba Internet Web sites

toshiba.com	Worldwide Toshiba corporate site
computers.toshiba.com	Marketing and product information in the USA
toshiba.ca	Canada
toshiba-Europe.com	Europe
toshiba.co.jp/index.htm	Japan
csd.toshiba.com/cgi-bin/tais/support/supp_home_latam.jsp	Mexico and all of Latin America

Toshiba's worldwide offices

Australia

Toshiba (Australia) Pty. Limited
84-92 Talavera Road
North Ryde NSW 2113
Sydney
Australia

Belgium

Toshiba Information Systems
Benelux (Belgium) B.V.
Excelsiorlaan 40
B-1930 Zaventem
Belgium

Austria

Toshiba Europe GmbH
Handelskai 388
1020 Wien, Austria

Canada

Toshiba Canada Ltd.
191 McNabb Street
Markham, Ontario
L3R - 8H2
Canada

Czech Republic

CHG Toshiba, s.r.o.
Hnevkovskeho 65
61700 Brno

Finland

Scribona TPC OY
Sinimäentie 14
P.O. Box 83
02630 ESPOO
Finland

Germany

Toshiba Europe GmbH
Leibnizstraße 2
D-93055 Regensburg
Germany

Hungary

Technotrade Kft.
Szerencs utca 202
1147 Budapest
Hungary

Italy

Progetto Elettronica 92 s.r.l.
Viale Certosa 138,
20156 Milano
Italy

Denmark

Scribona Danmark A/S
Naverland 27
DK2600 Glostrup
Denmark

France

Toshiba Systèmes (France)
S.A.
7, Rue Ampère
92804 Puteaux Cédex
France

Greece

Ideal Electronics S.A.
109 Syngrou Avenue
176 71 Kalithea
Athens
Greece

Ireland

Toshiba Information Systems
(U.K) Ltd.
Toshiba Court
Weybridge Business Park
Addlestone Road
Weybridge KT15 2UL
United Kingdom

Japan

Toshiba Corporation, PCO-
IO
1-1, Shibaura 1-Chome
Minato-Ku, Tokyo, 105-8001
Japan

Luxembourg

Toshiba Information Systems
Benelux B.V.
Rivium Boulevard 41
2909 LK, Capelle a/d IJssel
The Netherlands

Morocco

C.B.I.
22 Rue de Béthune
Casablanca
Morocco

Norway

Scribona Norge A/S
Toshiba PC Service
Stalfjaera 20
P.O. Box 51
Kalbakken
0901 OSLO 9
Norway

Poland

TECHMEX S.A.
ul. Partyzantów 71,
43-316 Bielsko-Biala
01-059 Warszawa
Poland

Mexico and all of Latin America

Toshiba de México S.A.
Sierra Candela No.111, 6to.
Piso
Col. Lomas de Chapultepec.
CP 11000 Mexico, DF.

800-457-7777 (outside of the US)

949-859-4276 (within the US
- this call may incur long distance charges)

The Netherlands

Toshiba Information Systems
Benelux B.V.
Rivium Boulevard 41
2909 LK, Capelle a/d IJssel
The Netherlands

Papua New Guinea

Fujitsu (PNG) Pty. Ltd.
P.O. Box 4952 Boroko
NCD, Papua
New Guinea

Portugal

Quinta Grande Assistência
Técnica Informática, Lda.
Av. Moinhos no. 15A
Ur. Quinta Grande
2720 Alfragide
Portugal

Singapore

Toshiba Singapore Pte. Ltd.
438B Alexandra Rd. # 06-01
Alexandra Technopark
Singapore 119968

Slovenia

Inea d.o.o.
Ljubljanska 80
61230 Domzale
Slovenia

Sweden

Scribona PC AB
Sundbybergsväegen 1
Box 1374
171 27 Solna
Sweden

United Kingdom

Toshiba Information Systems
(U.K) Ltd.
Toshiba Court
Weybridge Business Park
Addlestone Road
Weybridge KT15 2UL
United Kingdom

The Rest of Europe

Toshiba Europe (I.E.) GmbH
Hammfelddamm 8
D-4-1460 Neuss
Germany

Slovakia

HTC a.s.
Dobrovicova 8
81109 Bratislava
Slovakia

Spain

Toshiba Information Systems
(España) S.A.
Parque Empresarial San
Fernando
Edificio Europa, 1a Planta
Escalera A
28831 (Madrid) San
Fernando de Henares
Spain

Switzerland

Ozalid AG
Herostrasse 7
8048 Zürich
Switzerland

United States

Toshiba America Information
Systems, Inc.
9740 Irvine Boulevard
Irvine, California 92618
United States

Appendix A

Hot Keys

Hot keys are keys that, when pressed in combination with the Fn key, turn system functions on and off. Hot keys have a legend on the key indicating the option or feature the key controls.

Volume Control

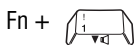

This hot key decreases the volume coming from your computer.



This hot key increases the volume coming from your computer.

Volume Mute

Fn +



This hot key enables/disables volume mute on your computer.

When volume mute is enabled, no sound will come from the speakers or headphones.

Password security

Fn +



This hot key blanks the display.

Without a password

The Fn + F1 key combination turns off the display. Using the mouse or any key will make the display reappear.

With a password

The Fn + F1 key combination turns off the display and activates the security feature. Using the mouse or any key will make the screen saver password dialog box appear, and you can then type in either a user or an administrator password.

For the Windows[®] XP operating system, you type the user or administrator password into the Windows[®] security screen dialog box.

To activate the password feature:

- 1 Click **Start**, then click **Control Panel**.
- 2 Double-click **Display**.
- 3 Select the **Screen Saver** tab.
- 4 Click the **On resume, password protected** check box.

5 Click **OK**.

Power usage mode

Fn + 

This hot key displays the power usage pop-up window and cycles through the battery save modes.



Sample power usage modes

The properties of each mode are set in the Toshiba Power Management utility. For more information, see [“Power Management” on page 143](#).

Standby mode

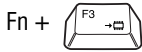

This hot key puts the computer into Standby mode.

- ❖ A message box is displayed by default to confirm that the computer is going into Standby mode. You can choose not to display this message box.

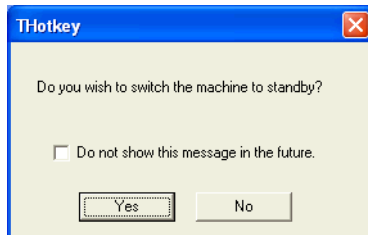

Sample Standby confirmation box

- ❖ For more information about Standby mode, please see [“Using Standby” on page 129.](#)

Hibernation mode

Fn +



This hot key puts the computer into Hibernation mode.

- ❖ If Hibernation mode is enabled (the default) a message box is displayed by default to confirm the computer is going into Hibernation mode. You can choose not to display this message box.

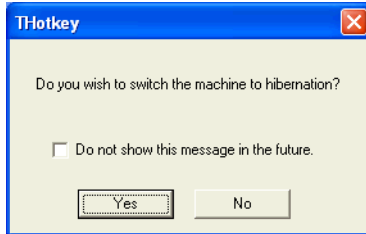

Sample Hibernation confirmation box

- ❖ If Hibernation mode is disabled, this hot key will not respond. For more information on Hibernation mode, see [“Using Hibernation” on page 125](#).

Display modes



This hot key cycles through the power-on display options.

The display modes are:

- ❖ Built-in display panel only
- ❖ Built-in display panel and external monitor simultaneously
- ❖ External monitor only

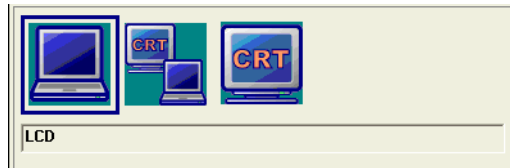

Sample display options window

In order to use a simultaneous mode, you must set the resolution of the internal display panel to match the resolution of the external display device.

Display brightness

Fn +  This hot key decreases the screen brightness.

Fn +  This hot key increases the screen brightness.

Keyboard hot keys

Fn +  This hot key turns the cursor control overlay on and off.

Fn +  This hot key turns the numeric overlay on and off.

Fn +  This hot key turns the scroll lock feature on and off.

Appendix B

Power Cable Connectors

Your computer features a universal power supply you can use worldwide. This appendix shows the shapes of the typical AC power cable connectors for various parts of the world.

USA and Canada



UL approved
CSA approved

Australia



AS approved

United Kingdom



BS approved

Europe



VDA approved
NEMKO approved

Glossary



TECHNICAL NOTE: Some features defined in this glossary may not be available on your computer.

Acronyms

The following acronyms may appear in this user's guide.

AC	alternating current
BIOS	basic input/output system
bps	bits per second
CD	compact disc
CD-ROM	compact disc read-only memory
CD-RW	compact disc rewritable memory
CMOS	complementary metal-oxide semiconductor
COM1	communications port 1 (serial port)
COM2	communications port 2 (serial port)
CPU	central processing unit
DC	direct current

DMA	direct memory access
DIMM	dual inline memory module
DOS	disk operating system
DPI	dots per inch
DSTN	dual supertwist nematic
DVD	digital versatile (or video) disc
DVD-ROM	digital versatile (or video) disc read-only memory
ECP	enhanced capabilities port
EPROM	erasable programmable read-only memory
FAT	file allocation table
FCC	Federal Communications Commission
FIR	fast infrared
GB	gigabyte
HDD	hard disk drive
HTML	Hypertext Markup Language
IEEE	Institute of Electrical and Electronics Engineers
I/O	input/output
IRQ	interrupt request
ISP	Internet service provider
KB	kilobyte
LAN	local area network
LCD	liquid crystal display
LPT1	line printer port 1 (parallel port)
LSI	large-scale integration
MB	megabyte
MIDI	Musical Instrument Digital Interface
PC	personal computer
PCI	Peripheral Component Interconnect
PCMCIA	Personal Computer Memory Card International Association

RAM	random access memory
RFI	radio frequency interference
ROM	read-only memory
RTC	real-time clock
SCSI	small computer system interface
SDRAM	synchronous dynamic random access memory
SRAM	static random access memory
SVGA	super video graphics adapter
TFT	thin film transistor
USB	universal serial bus
URL	uniform resource locator
WAN	wide area network
www	World Wide Web

Terms

The following terms may appear in this user's guide.

A

active-matrix display — A liquid crystal display (LCD) made from an array of liquid crystal cells using active-matrix technology. Also known as a “TFT display,” in its simplest form there is one thin film transistor (TFT) for each cell. This type of display works well with notebook computers because of its shallow depth and high-quality color. Active-matrix displays are viewable from wider angles than most passive-matrix displays.

adapter — A device that provides a compatible connection between two units. For example, the computer's internal display adapter receives information from the software and translates it into images on the screen. An adapter can take a number of forms, from a microprocessor to a simple connector. An intelligent adapter (one that is capable of doing some processing) may also be called a controller.

alternating current (AC) — The type of power usually supplied to residential and commercial wall outlets. AC reverses its direction at regular intervals. Compare *direct current (DC)*.

application — A computer program that you use to perform tasks of a specific type. Applications include word processors, spreadsheets, and database management systems. See also *program*.

B

backup — A copy of a file, usually on a removable disk, kept in case the original file is lost or damaged.

basic input/output system (BIOS) — See *BIOS*.

baud rate — The speed at which a communication device, such as a printer or modem, transmits information. Baud rate is the number of signal changes per second (not necessarily the same as bits per second). See also *bits per second*.

BIOS (basic input/output system) — Basic instructions, stored in read-only memory (ROM), containing the information the computer needs in order to check hardware and load the operating system when you start up the computer.

bit — Short for “binary digit.” A bit is the smallest unit of information used by a computer. A group of eight bits is a byte. See also *byte*.

bits per second (bps) — A way of measuring the speed at which information is passed between two devices. The basic measure used in modem communications, bps is similar, but not identical, to the baud rate. See also *baud rate*.

boot — To start the computer. The term “boot” originates from bootstrap program (as in “pulling itself up by its bootstraps”), a program that loads and initializes the operating system. See also *reboot*.

boot disk — See *system disk*.

boot priority (startup sequence) — The order in which the computer accesses its disk drives to locate the startup files. Under the default startup sequence, the computer looks for the startup files in the diskette drive before checking the hard disk.

bus — An electrical circuit that connects the central processing unit (CPU) with other parts of the computer, such as the video adapter, disk drives, and ports. It is the pathway through which data flows from one device to another. See also *bus speed*, *frontside bus*.

bus speed — The speed at which the central processing unit (CPU) communicates with the other parts of the computer.

byte — A sequence of eight bits. A byte is the smallest addressable unit of data. See also *bit*, *gigabyte*, *kilobyte*, *megabyte*.

C

cache — A section of very fast memory in which frequently used information is duplicated for quick access. Accessing data from cache is faster than accessing it from the computer's main memory. See also *CPU cache*, *L1 cache*, *L2 cache*.

CD — An individual compact disc. See also *CD-ROM*.

CD-ROM (compact disc read-only memory) — A form of high-capacity storage that uses laser optics instead of magnetic means for reading data. See also *CD*. Compare *DVD-ROM*.

central processing unit (CPU) — The chip that functions as the “brain” of the computer. It takes information from outside sources, such as memory or keyboard input, processes the information, and sends the results to another device that uses the information.

character — Any letter, number, or symbol you can use on the computer. Some characters are non-printing characters, such as a paragraph break in a word-processing program. A character occupies one byte of computer storage.

chip — A small piece of silicon containing computer logic and circuits for processing, memory, input/output, and/or control functions. Chips are mounted on printed circuit boards.

click — To press and release a TouchPad control button or mouse button. In the Windows® operating system, this refers to the left mouse button or TouchPad control button, unless otherwise stated. See also *double-click*.

color palette — A set of specified colors that establishes the colors that can be displayed on the screen at a particular time.

compatibility — The extent to which computers, programs, or devices can work together harmoniously, using the same commands, formats, or language as each other.

configuration — (1) The collection of components that make up a single computer system. (2) How parts of the system are set up (that is, configured).

controller — A device that controls the transfer of data from a computer to a peripheral device and vice versa. For example, disk drives, monitors, keyboards, and printers all require controllers.

CPU — See *central processing unit (CPU)*.

CPU cache — A section of very fast memory residing between the CPU and the computer's main memory that temporarily stores data and instructions the CPU will need to execute commands and programs. See also *cache, L1 cache, L2 cache*.

cursor — A symbol that indicates the current position on the screen. The shape of the cursor varies, depending on the program you're using and what you're doing.

D

default — The setting selected by a program when you don't specify an alternative setting.

device — A component attached to the computer. Devices may be external (outside the computer's case) or internal (inside the computer's case). Printers, disk drives, and modems are examples of devices.

device driver — A program (called a "driver") that permits a computer to communicate with a device.

dialog box — An on-screen window displayed by the operating system or a program giving a direction to, or requesting input from, the user.

direct current (DC) — The type of power usually supplied by batteries. DC flows in one direction. Compare *alternating current (AC)*.

direct memory access (DMA) — A dedicated channel, bypassing the CPU, that enables direct data transfer between memory and a device.

directory — See *folder*.

disable — To turn a computer option off. See also *enable*.

disc — A round, flat piece of metal, designed to be read from and written to by optical (laser) technology, and used in the production of optical discs, such as CDs and DVDs. Compare *disk*.

disk — A round, flat piece of material that can be magnetically influenced to hold information in digital form, and used in the production of magnetic disks, such as diskettes and hard disks. Compare *disc*. See also *diskette*, *hard disk*.

disk drive — The device that reads and writes information and programs on a diskette or hard disk. It rotates the disk at high speed past one or more read/write heads.

diskette — A thin, flexible disk in a protective jacket that stores magnetically encoded data. Diskettes can be removed from the computer and come in two sizes: 5.25-inch and 3.5-inch. Your computer uses 3.5-inch diskettes. See also *double-density diskette*, *high-density diskette*.

document — Any file created with an application and, if saved to disk, given a name by which it can be retrieved. See also *file*.

double-click — To press a TouchPad control button or mouse button rapidly twice. In the Windows® operating system, this refers to the left TouchPad control button or mouse button, unless otherwise stated.

double-density diskette — A 3.5-inch diskette that can hold up to 720 KB of information (half the capacity of a high-density diskette). See also *diskette*, *high-density diskette*.

download — (1) In communications, to receive a file from another computer through a modem or network. (2) To send font data from the computer to a printer. See also *upload*.

drag — To hold down a TouchPad control button or mouse button while moving the cursor to drag a selected object. In the Windows® operating system, this refers to the left TouchPad control button or mouse button, unless otherwise stated.

driver — See *device driver*.

DVD — An individual digital versatile (or video) disc. See also *DVD-ROM*.

DVD-ROM (digital versatile [or video] disc read-only memory) — A very high-capacity storage medium that uses laser optics for reading data. Each DVD-ROM can hold as much data as several CD-ROMs. Compare *CD-ROM*.

E **emulation** — A technique in which a device or program imitates another device or program.

enable — To turn on a computer option. See also *disable*.

executable file — A computer program that is ready to run. Application programs and batch files are examples of executable files. Names of executable files usually end with a .bat or .exe extension.

expansion device — A device that connects to a computer to expand its capabilities. Other names for an expansion device are port expander, port replicator, docking station, or network adapter.

extension — See *file extension*.

external device — See *device*.

F **file** — A collection of related information, saved on disk with a unique name. A file may be a program, information used by a program, or a document. See also *document*.

file allocation table (FAT) — The section of a disk that keeps track of the location of files stored on the disk.

file name — A set of characters that uniquely identifies a file within a particular folder. It consists of two parts: the actual name and the file name extension. See also *file extension*.

file extension — The three characters following the period (pronounced “dot”) at the end of a file name. The extension indicates the type of file. Examples are .exe for program files and .hlp for help files. See also *file name*.

folder — Also called directory. A container for organizing files saved to a disk. A folder is symbolized on screen by a graphical image (icon) of a file folder. A folder can contain files and other folders.

format — (verb) To prepare a blank disk for use with the computer’s operating system. Formatting creates a structure on the disk so that the operating system can write information to the disk or read information from it.

frontside bus — The primary pathway (bus) between the CPU and the computer’s main memory. Also called “system bus.” See also *bus*.

function keys — The keys labeled F1 through F12, typically located on the keyboard. Their function is determined by the operating system and/or individual programs.

G

gigabyte (GB) — A unit of data equal to 1,073,741,824 bytes (1024 x 1024 x 1024 bytes). See also *byte*.

ground — A conductor to which all components of an electric circuit are connected. It has a potential of zero (0) volts, is connected to the earth, and is the point of reference for voltages in the circuit.

H

hard disk — A storage device composed of a rigid platter or platters that can be magnetically coded with data. Hard disks hold much more information than diskettes and are used for long-term storage of programs and data. The primary (or only) hard disk in a computer is usually fixed, but some computers have secondary hard disks that are removable. By default, the primary hard disk is referred to as drive C.

hardware — The physical components of a computer system. Compare *software*.

Hibernation — A feature of many Toshiba notebook computers that saves to the hard disk the current state of your work, including all open files and programs, when you turn the computer off. When you turn on the computer again, your work is returned to the same state it was when the computer was turned off. See also *Standby*, *Suspend*.

high-density diskette — A 3.5-inch diskette that holds 1.44 MB of data. See also *diskette*.

hot key — (1) A feature in which certain keys in combination with the Fn key can set system options or control system parameters, such as the battery save mode. (2) A key or combination of keys that activates a memory resident program.

hot swapping — The ability to add or remove devices from a computer while the computer is running and have the operating system automatically recognize the change.

I icon — A small image displayed on the screen that represents a function, file, or program.

interlaced — A method of refreshing a computer screen, in which only every other line of pixels is refreshed. Interlaced monitors take two passes to create a complete screen image. Compare *non-interlaced*.

internal device — See *device*.

Internet — The decentralized, world-wide network of computers that provides electronic mail, the World Wide Web, and other services. See also *World Wide Web*.

K keyboard shortcut — A key or combination of keys that you use to perform a task instead of using a pointing device such as the TouchPad.

kilobyte (KB) — A unit of data equal to 1024 bytes. See also *byte*.

L L1 (level one) cache — Memory cache built into the processor to help improve processing speed. See also *cache*, *CPU cache*, *L2 cache*.

L2 (level two) cache — Memory cache installed on the motherboard to help improve processing speed. It is slower than L1 cache and faster than main memory. See also *cache*, *CPU cache*, *L1 cache*.

LAN (local area network) — A group of computers or other devices dispersed over a relatively limited area and connected by a communications link that enables any device to interact with any other on the network.

liquid crystal display (LCD) — A type of display that uses a liquid substance between two transparent electrode panels. When an electric current passes through the electrodes, the molecules in the liquid form a crystalline pattern that polarizes the light passing through it. A filter over the electrodes permits only non-polarized light to pass to the surface of the display, creating light and dark pixels.

load — To move information from a storage device (such as a hard disk) into memory for processing.

local area network — See *LAN*.

logical drive — A section of a disk that is recognized by the operating system as a separate disk drive. A system's logical drives may differ from its physical drives. For example, a single hard disk drive may be partitioned into two or more logical drives.

M

megabyte (MB) — A unit of data equal to 1,048,576 bytes (1024 x 1024 bytes). See also *bytes*.

memory — Typically refers to the computer's main memory, where programs are run and data is temporarily stored and processed. Memory can be volatile and hold data temporarily, such as RAM, or it can be nonvolatile and hold data permanently, such as ROM. A computer's main memory is RAM. See *RAM*, *ROM*.

microprocessor — See *central processing unit (CPU)*.

MIDI (Musical Instrument Digital Interface) — A standard for connecting musical instruments, synthesizers, and computers. The MIDI standard provides a way of translating music into a form computers can use, and vice versa.

modem — Short for “modulator/demodulator.” A device that converts information from digital to analog and back to digital, enabling information to pass back and forth between digital computers and analog telephone lines.

motherboard — The main circuit board in the computer. It contains the processor, memory, and other primary components.

MS-DOS prompt — See *system prompt*.

multimedia — A combination of two or more media, such as sound, animation, and video in a computer program or presentation.

Musical Instrument Digital Interface — See MIDI.

N

network — A collection of computers and associated devices that are connected by communications facilities. A network allows you to share data and peripheral devices, such as printers, with other users and to exchange electronic mail.

non-interlaced — A method of refreshing a computer screen, in which each pixel of every line is refreshed as the electron beam scans across and down the screen. Compare *interlaced*.

non-system disk — A disk for storing programs and data that cannot be used to start the computer. Compare *system disk*.

O

online — Available through the computer. Online may refer to information being read from your own computer’s hard disk, such as online documentation or online help, or to information coming from another company on a company network or the Internet.

operating system — A set of programs that controls how the computer works. Examples of operating systems are the Windows® XP Professional and Windows® 2000 operating systems.

P

palette — See *color palette*.

parallel — Processes that occur simultaneously. In communications, it means the transmission of more than one bit of information at a time. On some computers, a parallel port provides a parallel communications interface between the computer and an appropriate device. Compare *serial*.

password — A unique string of characters which you enter to verify your identity to the computer or the network.

PC Card — A credit-card-sized expansion card designed to increase the capabilities of notebook computers. PC Cards provide functions such as modem, fax/modem, hard disk drive, network adapter, sound card, or SCSI adapter.

peripheral — Any device, such as a printer or joystick, that is attached to the computer and controlled by the computer's CPU.

pixel — Short for "picture element." The smallest dot that can be produced on a screen or printer.

Plug and Play — Generally, refers to the computer's ability to automatically configure itself to work with peripheral devices. When capitalized, refers to a standard that, when followed by a device manufacturer, allows a PC to configure itself automatically to work with the device.

pointing device — Any device, such as the TouchPad or a mouse, that enables you to move the cursor on the screen.

port — A socket on the computer where you plug in a cable for connection to a network or a peripheral device.

processor — See *central processing unit (CPU)*.

program — A set of instructions that can be executed by a computer. The general classes of programs (also called software) are operating system, application, and utility. See also *operating system, application, utility*.

properties — The attributes of an object or device. For example, the properties of a file include the file's type, size, and creation date.

-
- R**
- RAM (random access memory)** — Volatile memory that can be written to as well as read. By volatile, we mean that information in RAM is lost when you turn off your computer. This type of memory is used for your computer's main memory. See also *memory*. Compare *ROM*.
- random access memory** — See *RAM*.
- read-only memory** — See *ROM*.
- reboot** — See *boot*, *restart*.
- removable disk** — A disk that can be removed from a disk drive. A diskette is one example of a removable disk.
- resolution** — A measure of the sharpness of the images that can be produced by a printer or displayed on a screen. For a printer, resolution is expressed in dots per inch (dpi). For a screen, it is expressed as the number of pixels available horizontally and vertically.
- restart** — Synonymous with reboot. To reset the computer by reloading the operating system without turning the computer off. See also *boot*.
- RJ11** — A modular connector used on most U.S. telephone systems and direct-connect modems. The RJ11 connector is a 6-wire connector.
- ROM (read-only memory)** — Non-volatile memory that can be read but not written to. By non-volatile, we mean that information in ROM remains whether or not the computer is receiving power. This type of memory is used to store your computer's BIOS, which is essential instructions the computer reads when you start it up. See also *BIOS*, *memory*. Compare *RAM*.
- S**
- select** — To highlight or otherwise specify text, data, or graphics with the intent to perform some operation on it.

serial — Processes that occur one at a time. In communications, it means the transmission of one bit at a time sequentially over a single channel. Most computers have a serial port, which provides a serial interface between the computer and a single device, and/or a USB port which provides a high-speed connection to multiple devices. See *Universal Serial Bus (USB)*. Compare *parallel*.

shortcut — See *keyboard shortcut*.

software — See *program*. Compare *hardware*.

Standby — A feature of some Windows® operating systems that allows you to turn off the computer without exiting your open applications and to continue from where you left off when you turn the computer on again.

Suspend — A feature of some Windows® operating systems that allows you to turn off the computer without exiting your open applications and to continue from where you left off when you turn the computer on again.

system disk — A diskette that contains the operating system files needed to start the computer. Any diskette can be formatted as a system disk. A system disk is also called a “bootable disk” or a “startup disk.” Compare *non-system disk*.

system prompt — The symbol (in the MS-DOS® operating system, generally a drive letter followed by a “greater than” sign) indicating where you enter commands.

TFT display — See *active-matrix display*.

universal serial bus (USB) — A serial bus that supports a data transfer rate of up to 12 Mbps (12 million bits per second). USB can connect up to 127 peripheral devices through a single all-purpose USB port. USB allows hot swapping of peripherals. See also *bus*, *hot swapping*, *serial*.

upload — To send a file to another computer through a modem or network. See also *download*.

USB — See *universal serial bus (USB)*.

T
U

utility — A computer program designed to perform a narrowly focused operation or solve a specific problem. Utilities are often related to computer system management.

W

Web — See *World Wide Web*.

Wi-Fi — A term trademarked by the Wireless Capability Ethernet Alliance which stands for Wireless Fidelity. Wi-Fi is another term for the IEEE 802.11b communication protocol that permits an Ethernet connection using wireless communication components.

World Wide Web (www) — The worldwide network of Web sites linked together over the Internet. A user of the Web can jump from site to site regardless of the location of the computer hosting the site. See also *Internet*.

Index

A

AC adapter 33

AC power

connecting adapter 47

power light 50

status 31

accessories

carrying case 91

Direct Cable Connection software
115

PORT-Noteworthy computer lock
cable 56

adding

memory 40

audio

.WAV digital wave files 117

features 116

playing 69

B

Backup or Restore Wizard 68

battery

additional packs 77

alarms 85

changing 88

charge indicator light 80

charge not lasting 160

charging main 78

charging RTC 79

conserving power 83

descriptions 76

indicator light 32, 50

inserting 89

low charge 82

main battery power status 78

maximizing life 77

monitoring power 80

not charging 159

optional charger 80

power usage mode 83, 180

remaining power 81

removing 88

safe disposal 90

safety precautions 78

status 32

buttons

control 51

Internet 30

PC Card eject 27

power 30

- primary control 30, 51
- secondary control 30, 51
- TOSHIBA Console 30

C

- caps lock light 31
- channels
 - DMA 156
 - IRQ 155
- checking device properties 157
- cleaning the computer 56
- click 51
- COM port 112
- command
 - Turn Off 120
- communications
 - network connection 71, 114
 - setting up 70
 - system resources 155
- computer
 - lock 56
 - non-system disk or disk error message 151
 - not accessing disk drives 151
 - setting up 40, 41
 - transferring information 116
 - warning resume failure message 151
- computing tips 58
- connecting
 - modem 45
 - printer 45, 99
 - to a network 71
 - USB-compatible
 - keyboard 97
 - monitor 97
 - mouse 45, 99
- control buttons 51
- cooling vents
 - CPU 25
- copying files 114

- cursor control mode light 31
- customizing
 - taskbar 105

D

- DC-IN
 - jack 26
- desktop
 - browsing style 107
 - changing styles 107
 - personalizing 105
- Device Manager 157
 - checking properties 157
 - disabling a device 157, 158
- digital audio .WAV files 117
- Digital Subscriber Lines (DSL) 72
- Direct Cable Connection software 115
- Disk Defragmenter 59, 164
- disk drive
 - corrupted/damaged data files 164
 - missing files/trouble accessing a disk 163
 - running slow 164
- diskette
 - care 67
 - copying documents to 66
 - copying files 66
 - inserting and removing 66
 - protecting stored data 67
- diskette drive
 - attaching external USB 96
 - can't insert a diskette 165
 - can't read a diskette 165
- display
 - doesn't look normal/flickers 162
 - external monitor not working 163
 - screen is blank 161
- display options
 - built-in display only 99
 - external monitor only 99

- simultaneous viewing 98
- display panel
 - closing 55
 - opening 49
 - panel latch 25
 - TFT LCD 29
 - turn off automatically 86
- displaying folder information 110
- disposing of battery 90
- DMA (Direct Memory Access) 156
- double-click 51
- downloading 74

E

- email 74
- environment
 - computer-friendly 35
- ergonomics 36, 37, 38
- error messages
 - device driver conflict 154
 - general hardware problem 154
 - non-system disk or disk error 151, 165
 - problem with display settings/
 - current settings not working
 - with hardware 163
 - program has performed an illegal operation 150
 - warning resume failure 151
- Error-checking 59, 164
- Ethernet LAN Port
 - disabling 113
 - using 113
- exchanging data 114
- expansion memory slot 43
- expansion port 28
- external
 - diskette drive 95
 - keyboard 97
 - monitor

- connecting 97
- not working 163

F

- FAT (File Allocation Table) 163
- features 58
- files
 - .WAV 117
 - backing up 59
 - printing 65
 - restoring 69
 - saving 58, 64
 - transferring application files 114
- Fn key 30
 - assigning functions 136
- Fn key emulation 97
- Fn-esse 134
 - assigning keys 136
 - change/remove key assignments 138
 - drag-and-drop 136
 - keyboard 135
 - starting 135
 - using keyboard or pointing device 137
 - viewing key assignments 138
- folders
 - displaying information 110
- function keys 30

H

- hard disk drive
 - light 33, 50
- hardware conflicts 154
 - resolving 156
- headphones 117
 - jack 27
- Help
 - Windows XP 154
- Hibernation command 120
 - enabling 125

- Hibernation mode 120
 - methods 129, 130
- hot key
 - display brightness 184
 - display modes 183
 - Hibernation mode 182
 - keyboard overlays 184
 - password security 179
 - power usage mode 180
 - Standby mode 181
 - volume control 178
 - volume mute 179
- hot keys 179
 - power usage modes 85
- hot swapping 102
 - precautions 102
- Hotkey utility 138
- Hypertext Transfer Protocol (HTTP) 72

I

- icons
 - safety 21
- infrared port 27
 - transferring files 114
- inserting
 - main battery 89
- installing
 - memory module 40
- Internet 72
 - bookmarked site not found 154
 - button 30
 - chat rooms 74
 - connecting to 73
 - news groups 74
 - overview 71
 - slow connection 153
 - URL address not found 154
- Internet Service Provider (ISP) 72, 74
- IRQ (Interrupt Request) 155

J

- jacks
 - DC-IN 26, 47
 - headphone 27, 117
 - microphone 27
 - speaker 117
 - telephone line 45

K

- keyboard
 - character keys 60
 - connecting external USB 97
 - Ctrl, Fn and Alt keys 60
 - cursor control overlay 63
 - emulating Fn keys 97
 - external 97
 - Fn-esse 135
 - full-size emulation 111
 - function keys 61
 - hot keys 184
 - layout 60
 - not working 151, 161
 - numeric overlay 62
 - unexpected characters 161
- keyboard indicator panel 30, 31

L

- LCD panel
 - closing 55
 - screen saver 86
 - turn off automatically 86
- lighting 38
- lights
 - caps lock 31
 - cursor control mode 31
 - numeric mode 31
 - on/off 32
 - optional high-capacity battery 32
 - Wi-Fi 33

M

- main battery
 - light 32, 48
 - maximizing life 77
 - module 28
 - release latch 28
 - removing 88
 - memory
 - installing additional 40
 - problem solving 158
 - removing expansion slot cover 43
 - memory cards
 - Secure Digital 25, 103
 - microphone
 - using 118
 - microphone jack 27
 - Microsoft Support Online Web site 154
 - modem
 - connecting 45
 - determining COM port 112
 - port 26
 - problem solving 170
 - resetting port to default settings 112
 - upgrading 112
 - modes
 - Hibernation 120
 - Standby 121
 - monitor
 - not working 162
 - moving the computer 56
- N**
- network
 - accessing 71, 114
 - Dial-Up Networking Wizard 71, 114
 - numeric mode light 31

O

- on/off light 32
- optional additional equipment
 - battery charger 78, 80
 - carrying case 91
 - memory modules 40
 - Noteworthy computer lock cable 56
- optional high-capacity battery light 32

P

- PC Card
 - checklist 167
 - CIS (Card Information Structure) 166
 - computer stops working 168
 - eject button 27
 - errors 168
 - hot swapping 102
 - hot swapping fails 168
 - installing 100
 - modem default 112
 - not recognized 168
 - problem solving 166, 167
 - removing 101
 - slot 27, 99
- PC Card slot 99
- playing audio 69
- Plug and Play 156
- ports
 - expansion 28, 94
 - infrared 27
 - LAN 26, 93
 - modem 26
 - RGB (monitor) 26, 93
 - Universal Serial Bus 26, 93
- power
 - AC adapter 26
 - AC adapter status 31
 - computer will not start 150

- connecting cable to AC Adapter
 - 47
 - energy-saving features 76
 - light 48
 - on/off button 30
 - preset usage modes 83
 - problem solving 159
 - turning on the power 49
- power cable connectors 185
- Power Management 143
 - running on batteries 145
- power off
 - alternate methods 55
 - guidelines 54
- power source
 - connecting 47
- power usage modes
 - changing 83
 - customizing 145
 - preset 83
- powering down the computer 119, 130
 - options 119
- primary control button 30, 51
- printer
 - connecting 45
 - problem solving 169
 - setting up 52
- printing a file 65
- problem solving
 - AC power 159
 - accessing disk drives 151
 - battery charge doesn't last 160
 - battery not charging 159
 - can't insert diskette in drive 165
 - can't read a diskette 165
 - changing display properties 163
 - checking device properties 157
 - computer hangs when PC Card inserted 168
 - computer will not power up 150
 - corrupted/damaged data files 164
 - Device Manager 157
 - disabling a device 157, 158
 - disk drive is slow 164
 - display is blank 161
 - external display not working 163
 - external keyboard not working 161
 - external monitor 162
 - faulty memory 158
 - hardware conflict 154, 155, 156
 - high-pitched noise 165
 - illegal operation 150
 - Internet bookmarked site not found 154
 - Internet connection is slow 153
 - keyboard
 - not responding 151
 - keyboard produces unexpected characters 161
 - missing files/trouble accessing a disk 163
 - modem not receiving or transmitting 170
 - no sound 165
 - non-system disk or disk error 151, 165
 - PC Card 166
 - checklist 167
 - error occurs 168
 - hot swapping fails 168
 - not recognized 168
 - slots appear dead 167
 - power and batteries 159
 - printer 169
 - program not responding 148
 - program not working properly 164
 - screen does not look right/flickers 162

- Startup options 152
- system resources 155
- trouble prevention 170
- URL address not found 154
- warning resume failure 151
- Windows won't start 151
- Windows XP not working 152

- programs
 - not running correctly 164
 - starting 64
 - synchronization 116
 - Web browsers 72

R

- real-time clock battery
 - recharging 79
- recording
 - adjusting quality 119
- recording sounds 117
- Recovery CDs 22
 - transferring application files 115
- registering computer 52
- remaining battery power 81
- removing
 - main battery 88
- Restart command 120
- restoring work 69
- RGB (monitor) port 26, 93
- RTC battery *See real-time clock battery*

S

- safety
 - icons 21
- saving your work 64
- screen
 - blank 161
 - display 29
 - doesn't look normal/flickers 162
- screen saver

- enabling 86
- Search Engine 73
- secondary control button 30, 51
- Secure Digital card 25, 103
 - inserting 103
 - removing 103
 - using 102
- Secure Digital card slot 25
- security
 - anti-theft locking device 25
- SelectServ 23
- setting up
 - computer 40, 41
 - printer 52
- Shut down
 - using 122
- Shut down command 120
- simultaneous screens 98
- Slim Port Replicator 93
 - network access 71
- sound
 - problem solving 165
- sound system
 - connecting external speakers 117
- SPANworks 2000 115
- speakers
 - connecting external speakers 117
- Standby command 121, 130
- Standby mode 121
 - hot key 181
- starting a program 64
- Startup menu
 - problem solving 152
- system indicator panel 30, 31
- System Setup 151

T

- taskbar
 - customizing 105
- toolbars

- displaying in a window 110
- Toshiba
 - Accessories Information 22
 - Internet Web sites 174
 - registering computer 52
 - worldwide offices 174

- TOSHIBA Button Controls 142
- TOSHIBA Console 140
- TOSHIBA Console button 30
- Toshiba Hardware Setup 146
- TOSHIBA Mobile Extension 139

- Toshiba online services
 - Toshiba Forum 172

- TouchPad 30
 - using 50, 51

- traveling tips 91

- Turn Off
 - using 122

- Turn Off command 120, 122

- Turn Off methods 122

- turning computer on/off 30, 49

- turning off the computer 54

U

- Uniform Resource Locator (URL) 73, 105

- Universal Serial Bus (USB) port 26, 93, 94

- uploading 74

- URL (Uniform Resource Locator) 73, 105

- USB-compatible
 - diskette drive
 - connecting 95
 - keyboard 97
 - connecting 97
 - mouse
 - connecting 45
 - printer
 - connecting 45

- utilities

- Fn-esse 134
- Hotkey utility 138
- Power Management 143
- TOSHIBA Mobile Extension 139

V

- volume control 117

W

- warranty
 - SelectServ 23

- Web address 73

- Web browsers 72

- Web content interface 106

- Web sites
 - Support Online 154
 - Toshiba 174

- Wi-Fi
 - light 33
 - wireless networking 113

- Wi-Fi antenna
 - on-off switch 27

- Windows Media Player 69

- Windows XP
 - Briefcase 116
 - Help 154
 - Help and Support 154
 - problem solving 152
 - special features 104

- wireless networking 113

- wizards
 - Add Printer 53
 - Backup or Restore 68
 - Dial-Up Networking 71
 - Internet Connection 74

- World Wide Web 72

Free Manuals Download Website

<http://myh66.com>

<http://usermanuals.us>

<http://www.somanuals.com>

<http://www.4manuals.cc>

<http://www.manual-lib.com>

<http://www.404manual.com>

<http://www.luxmanual.com>

<http://aubethermostatmanual.com>

Golf course search by state

<http://golfingnear.com>

Email search by domain

<http://emailbydomain.com>

Auto manuals search

<http://auto.somanuals.com>

TV manuals search

<http://tv.somanuals.com>