



TOSHIBA

OWNER'S MANUAL

Color Television

FST PURE™
COLORSTREAM™

Welcome to
Toshiba

Important
Safeguards

Connecting
your TV

Using the
Remote Control

Setting up
your TV

Using the TV's
Features

Appendix

Owner's Record

The model number and serial number are on the back of your TV. Record these numbers in the spaces below. Refer to these numbers whenever you communicate with your Toshiba dealer about this TV.

Model number:

Serial number:

14AF41

© 2000 TOSHIBA CORPORATION
All Rights Reserved

Welcome to Toshiba

Welcome to Toshiba

Congratulations! You have purchased one of the finest color TVs on the market. The goal of this manual is to guide you through setting up and operating your Toshiba TV as quickly as possible. Please make sure you've received the following items: TV, remote control, batteries, manual, registration card, and extended service plan literature. If you did not receive all of the items, or any of the items are damaged or broken, please contact your Toshiba dealer. In addition, you may need to purchase other audio or video cables to connect your equipment. See "Connecting your TV" on page 4 for more information.

Please read all the safety and operating instructions carefully before you begin.

Exploring your new TV

You can operate your TV by using the buttons on the front panel or the remote control. All the terminals on the front and the back panel provide all the connections you will need to connect other equipment to your TV.

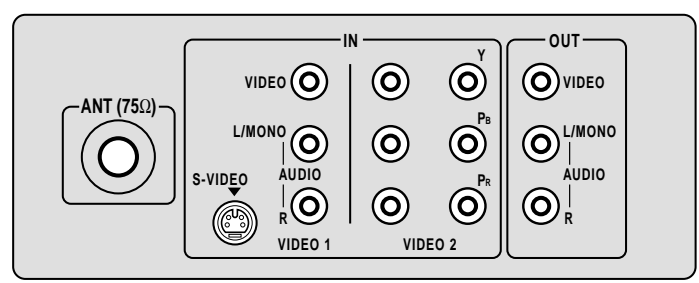
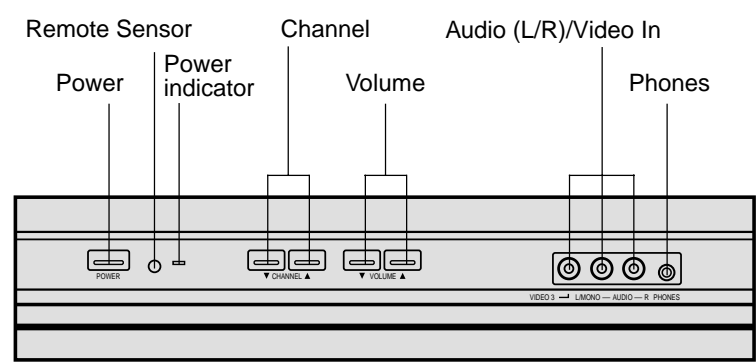

Selecting a location for the TV

- Place the TV on the floor or on a sturdy platform in a location where light does not directly hit the screen.
- Place the TV far enough from the walls to allow proper ventilation. Inadequate ventilation may cause overheating, which may damage the TV.

The model number and serial number are on the back of your TV. Record these numbers in the spaces below. Refer to these numbers whenever you communicate with your Toshiba dealer about this TV.

Model number: _____

Serial number: _____

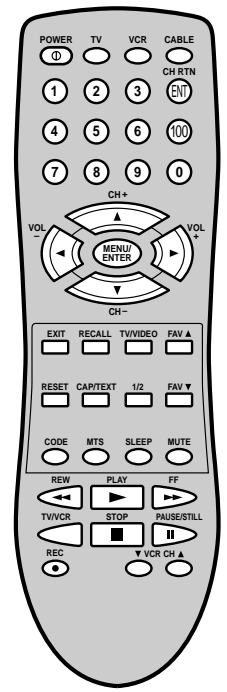

Caution:
 The plug has one prong wider than the other and will fit only one way into a standard electrical outlet (120 volt AC, 60 Hz). If the plug does not fit into the outlet, try turning it around. If the plug still does not fit, the outlet is probably non-standard and must be replaced by a qualified electrician.
Do not tamper with the plug or try to force it into a non-standard outlet.

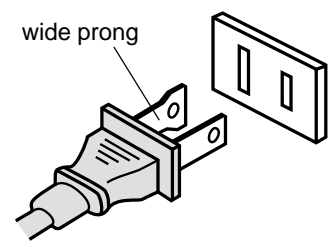



Important Safeguards	2
Connecting your TV	4
Connecting a VCR	4
Connecting a cable converter box	5
Connecting a DVD/satellite receiver and a VCR	6
Connecting a DVD with ColorStream™ and a VCR	6
Connecting two VCRs	7
Connecting a camcorder	7
Connecting an audio amplifier	7
Using the remote control	8
Preparing the remote control for use	8
Installing the remote control batteries	8
Using the remote control with a VCR or a cable TV converter	8
Programming the remote control for use with a VCR or a cable TV converter	9
Learning about the remote control	10
Setting up your TV	11
Changing the on-screen display language	11
Adding channels to the TV's memory	12
Programming channels automatically	12
Adding and erasing channels manually	12
Changing channels	12
Using the TV's features	13
Adjusting the channel settings	13
Switching between two channels	13
Programming your favorite channels	13
Using the V-Chip	14
Selecting a PIN code	14
Blocking programs by ratings	15
Blocking unrated movies or programs	18
Blocking channels	18
Labeling channels	19
Adjusting the picture	20
Adjusting the picture quality	20
Watching video input	21
Selecting the ColorStream mode	21
Displaying on-screen information	21
Setting the sleep timer	21
Using the closed caption feature	21
Adjusting the sound	22
Muting the sound	22
Selecting stereo/SAP broadcasts	22
Adjusting the sound quality	23
Using the STABLE SOUND feature	23
Auto power off	24
Understanding the Power Return feature	24
Appendix	24
Cleaning and care	24
Troubleshooting	25
Specifications	26
Limited United States warranty	27

Welcome to
Toshiba

Important
Safeguards

Connecting
your TV

Using the
Remote Control

Setting up
your TV

Using the TV's
Features

Appendix





Important Safeguards

	CAUTION RISK OF ELECTRIC SHOCK DO NOT OPEN	
CAUTION: TO REDUCE THE RISK OF ELECTRIC SHOCK, DO NOT REMOVE COVER (OR BACK). NO USER-SERVICEABLE PARTS INSIDE. REFER SERVICING TO QUALIFIED SERVICE PERSONNEL.		



The lightning flash with arrowhead symbol, within an equilateral triangle is intended to alert the user to the presence of uninsulated dangerous voltage within the product's enclosure that may be of sufficient magnitude to constitute a risk of electric shock.



The exclamation point within an equilateral triangle is intended to alert the user to the presence of important operating and maintenance (servicing) instructions in the literature accompanying the appliance.

CAUTION: Changes or modifications not expressly approved by the party responsible for compliance with the FCC Rules could void the user's authority to operate this equipment.

WARNING: TO PREVENT FIRE OR SHOCK HAZARD, DO NOT EXPOSE THIS APPLIANCE TO RAIN OR MOISTURE.

IMPORTANT SAFEGUARDS

1. READ INSTRUCTIONS

All the safety and operating instructions should be read before the unit is operated.

2. RETAIN INSTRUCTIONS

The safety and operating instructions should be retained for future reference.

3. HEED WARNINGS

All warnings on the unit and in the operating instructions should be adhered to.

4. FOLLOW INSTRUCTIONS

All operating and use instructions should be followed.

5. CLEANING

Unplug this unit from the wall outlet before cleaning. Do not use liquid cleaners or aerosol cleaners. Use a damp cloth for cleaning.

6. ATTACHMENTS

The manufacturer of this unit does not make any recommendations for attachments, as they may cause hazards.

7. WATER AND MOISTURE

Do not use this unit near water. For example, near a bathtub, washbowl, kitchen sink, or laundry tub, in a wet basement, or near a swimming pool.

8. ACCESSORIES

Do not place this unit on an unstable cart, stand, tripod, bracket, or table.

The unit may fall, causing serious injury, and serious damage to the unit.

8A. An appliance and cart combination should be moved with care.

Quick stops, excessive force, and uneven surfaces may cause the appliance and cart combination to overturn.

9. VENTILATION

Slots and openings in the cabinet back or bottom are provided for ventilation, to ensure reliable operation of the unit and to protect it from overheating. These openings must not be blocked or covered. The openings should never be blocked by placing the unit on a bed, sofa, rug, or other similar surface. This unit should never be placed near or over a radiator or heat source. This unit should not be placed in a built-in installation, such as a bookcase, or rack unless proper ventilation is provided or the manufacturer's instructions have been adhered to.

10. POWER SOURCE

This unit should be operated only from the type of power source indicated on the rating plate. If you are not sure of the type of power supply to your home, consult your appliance dealer or local power company. For units intended to operate from battery power, or other sources, refer to the operating instructions.

11. GROUNDING OR POLARIZATION

This unit is equipped with a polarized alternating current line plug (a plug having one blade wider than the other).

This plug will fit into the power outlet only one way. This is a safety feature. If you are unable to insert the plug fully into the outlet, try reversing the plug. If the plug should still fail to fit, contact your electrician to replace your obsolete outlet. Do not defeat the safety purpose of the polarized plug. If your unit is equipped with a 3-wire grounding-type plug, a plug having a third (grounding) pin, this plug will only fit into a grounding-type power outlet. This too, is a safety feature. If you are unable to insert the plug into the outlet, contact your electrician to replace your obsolete outlet. Do not defeat the safety purpose of the grounding-type plug.

12. POWERCORD PROTECTION

Power-supply cords should be routed so that they are not likely to be walked on or pinched by items placed upon or against them, paying particular attention to cords at plugs, convenience receptacles, and the point where they exit from the appliance.

PORTABLE CART WARNING
(symbol provided by RETAC)



S3126A





Welcome to
Toshiba

Important
Safeguards

Connecting
your TV

Using the
Remote Control

Setting up
your TV

Using the TV's
Features

Appendix

13. LIGHTNING

To protect your unit during a lightning storm, or when it is left unattended and unused for long periods of time, unplug it from the wall outlet and disconnect the antenna or cable system. This will prevent damage to the unit due to lightning and power line surges.

14. POWER LINES

An outside antenna system should not be located in the vicinity of overhead power lines, or other electric light or power circuits, or where it can fall into such power lines or circuits. When installing an outside antenna system, extreme care should be taken to keep from touching such power lines or circuits as contact with them might be fatal.

15. OVERLOADING

Do not overload wall outlets and extension cords as this can result in a risk of fire or electric shock.

16. OBJECT AND LIQUID ENTRY

Do not push objects through any openings in this unit as they may touch dangerous voltage points or short out parts that could result in fire or electric shock. Never spill or spray any type of liquid into the unit.

17. OUTDOOR ANTENNA GROUNDING

If an outside antenna or cable system is connected to the unit, be sure the antenna or cable system is grounded to provide some protection against voltage surges and built-up static charges. Section 810 of the National Electrical Code, ANSI/NFPA 70, provides information with respect to proper grounding of the mast and supporting structure, grounding of the lead-in wire to an antenna discharge unit, size of grounding conductors, location of antenna discharge unit, connection to grounding electrodes, and requirements for the grounding electrode.

18. SERVICING

Do not attempt to service this unit yourself as opening or removing covers may expose you to dangerous voltage or other hazards. Refer all servicing to qualified service personnel.

19. DAMAGE REQUIRING SERVICE

Unplug this unit from the wall outlet and refer servicing to qualified service personnel under the following conditions:

- a. When the power-supply cord or plug is damaged.
- b. If liquid has been spilled, or objects have fallen into the unit.
- c. If the unit has been exposed to rain or water.
- d. If the unit does not operate normally by following the operating instructions. Adjust only those controls that are covered by the operating instructions, as an improper adjustment of other controls may result in damage and will often require extensive work by a qualified technician to restore the unit to its normal operation.
- e. If the unit has been dropped or the cabinet has been damaged.
- f. When the unit exhibits a distinct change in performance, this indicates a need for service.

20. REPLACEMENT PARTS

When replacement parts are required, be sure the service technician uses replacement parts specified by the manufacturer or those that have the same characteristics as the original part.

Unauthorized substitutions may result in fire, electric shock or other hazards.

21. SAFETY CHECK

Upon completion of any service or repairs to this unit, ask the service technician to perform safety checks to determine that the unit is in proper operating condition.

22. HEAT

The product should be situated away from heat sources such as radiators, heat registers, stoves, or other products (including amplifiers) that produce heat.

23. NOTE TO CATV SYSTEM INSTALLER

This reminder is provided to call the CATV system installer's attention to Article 820-40 of the NEC that provides guidelines for proper grounding and, in particular, specifies that the cable ground shall be connected to the grounding system of the building, as close to the point of cable entry as practical.

EXAMPLE OF ANTENNA GROUNDING AS PER NATIONAL ELECTRICAL CODE

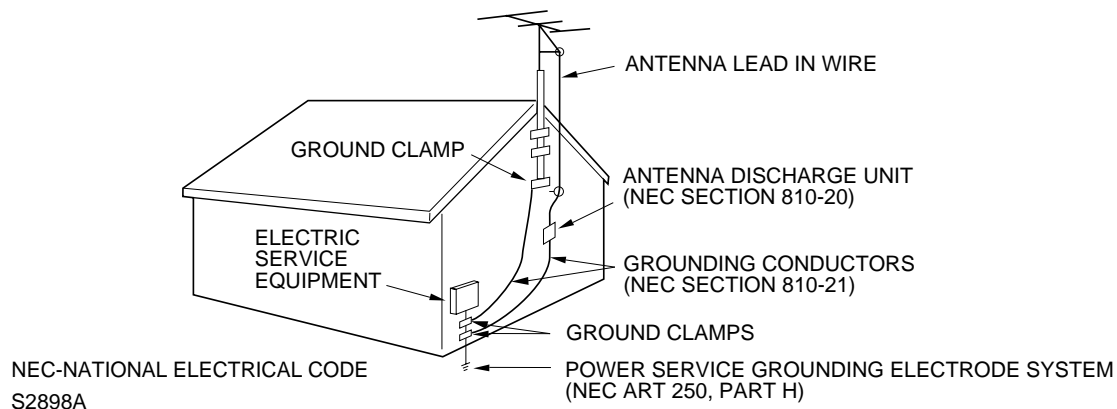

3





Connecting your TV

Connecting your TV

If you haven't connected electronic equipment before, or you have been frustrated in the past, you may wish to read this section. (Cables are not supplied.)

- A coaxial cable is the standard cable that comes in from your antenna or cable converter box. Coaxial cables use "F" connectors.
- Audio and video cables are usually color coded according to use: yellow for video and red and white for audio. The red audio cable is for the stereo right channel, and the white audio cable is for the stereo (or mono) left channel. If you look at the rear panel of the TV, you will see that the terminals are color coded in the same manner as the cables.
- S-video cables provide better picture performance. S-video cables can only be used with S-video compatible components.
- ColorStream™ cables come in sets of three and provide the best picture performance. ColorStream cables can only be used with ColorStream compatible components.

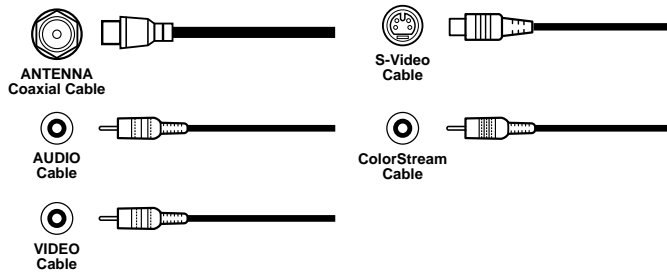

Caution:

Do not plug the TV in until you have finished connecting all of your equipment.

Connecting a VCR

This connection allows you to watch local channels and video programs, play or record on the VCR while watching TV, and to record from one channel while watching another channel.

You will need:

- one coaxial cable
- one pair of audio cables (only one cable for a mono VCR)
- one video cable

Caution:

If using a mono VCR, connect L/Mono to VCR Audio OUT using only one audio cable. If you have a S-VHS VCR, use the S-video connections and remove the video cable.

Note:

When the video cable and the S-video cable to Video1 simultaneously, the S-video will automatically take precedence.

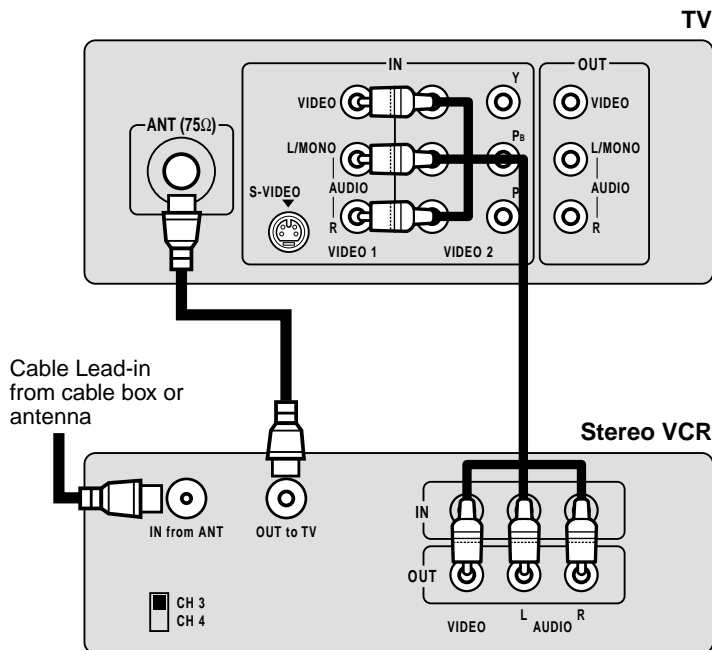



Connecting a cable converter box

This television has an extended tuning range and can tune most cable channels without using a cable company supplied converter box. Some cable companies offer "premium pay channels" in which the signal is scrambled. Descrambling these signals for normal viewing requires the use of a descrambler device which is generally provided by the cable company.

For Subscribers to Basic Cable TV Service

For basic cable service not requiring a Converter/Descrambler box, connect the CATV 75 ohm Coaxial Cable directly to the Antenna Jack on the back of the television.

For Subscribers to Scrambled Cable TV Service

If you subscribe to a cable service which requires the use of a Converter/Descrambler box, connect the incoming cable to the Converter/Descrambler box and connect the output of the box to the Antenna Jack on the back of the television. Follow the connections shown left. Set the television to the output of the Converter/Descrambler box (usually channel 3 or 4) and use the Converter/Descrambler box to select channels.

For Subscribers to Unscrambled Basic Cable with Scrambled Premium Channels

If you subscribe to a cable service in which basic cable channels are unscrambled and premium channels require the use of a Converter/Descrambler box, you may wish to use a two-set signal splitter (sometimes called a "two-set coupler") and an A/B Switch box from the cable installer or an electronics supply store. Follow the connections shown left. With the switch in the "B" position, you can directly tune any nonscrambled channels on your TV. With the switch in the "A" position, tune your TV to the output of the Converter/Descrambler box (usually channel 3 or 4) and use the box to tune scrambled channels.

Note:

When you use a converter box with your TV, there may be features that you cannot program using the remote control, such as labeling channels, blocking channels, and programming your favorite channels.

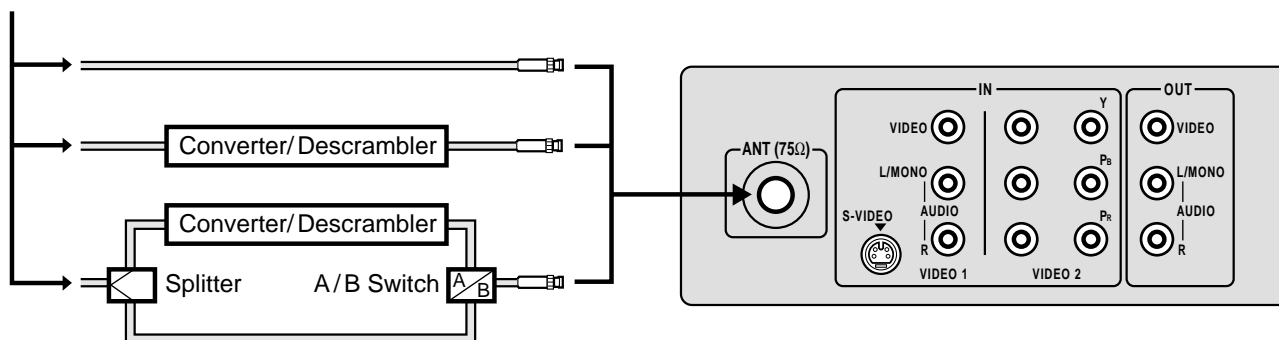



Connecting a DVD/satellite receiver and a VCR

This connection allows you to watch DVD/satellite, video and TV programs. You can record from the DVD/satellite receiver and TV, as well as record one TV channel while watching another channel.

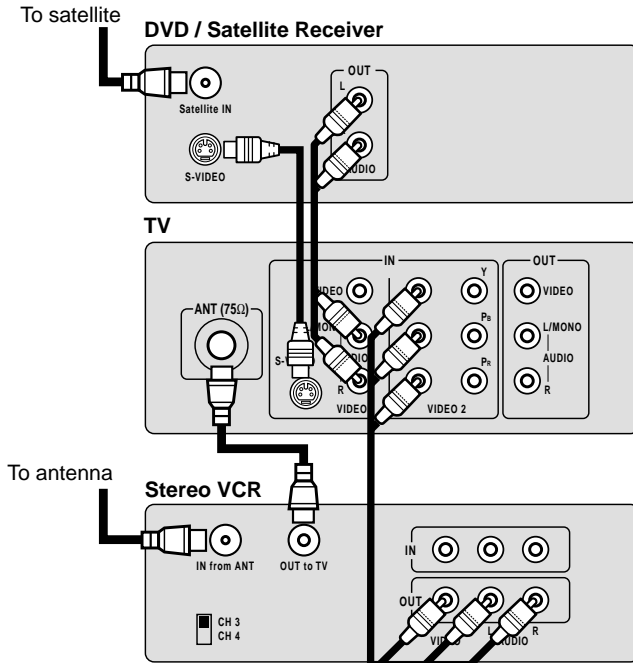

Connecting
your TV

You will need:

- one coaxial cable
- two pairs of audio cables (only one cable for a mono VCR)
- one video cables
- one S-video cable

Caution:

You can use a video cable instead of the S-video cable, but the picture quality will decrease. If you use a S-video cable between the TV and DVD/satellite receiver, make the audio connections only and remove the video connection.

Connecting a DVD with ColorStream™ and a VCR

This connection allows you to watch DVD, video or TV programs and to record DVD or TV programs. You can record from one source and watch a program from another source. Your TV is capable of using ColorStream (component video). Connecting your TV to a ColorStream compatible DVD, such as a Toshiba DVD, can greatly enhance picture quality and performance.

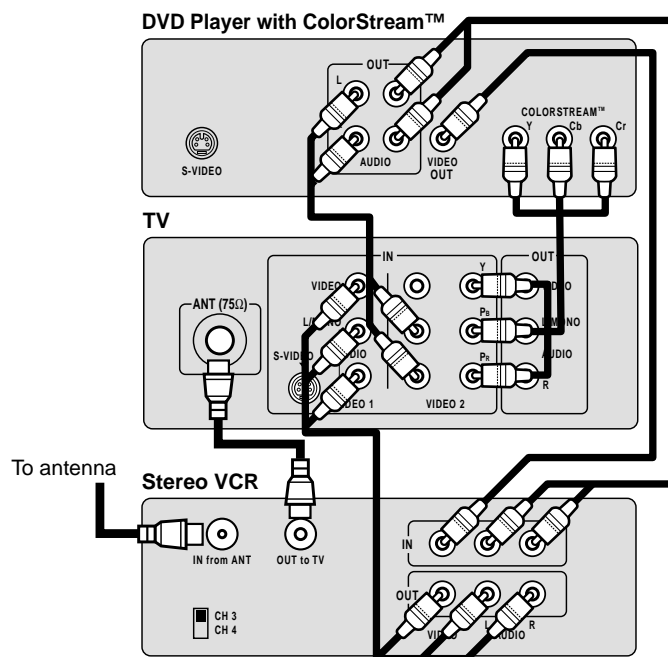

You will need:

- one coaxial cable
- three pairs of audio cables (only one cable for a mono VCR)
- two video cables
- one set of ColorStream video cables

Caution:

To play from the DVD, the DVD and TV must use ColorStream connections. To record from the DVD, the DVD and TV must select Video. The ColorStream selection in the OPTION menu should be DVD mode. See "Selecting the ColorStream mode" on page 21.





Connecting two VCRs

This connection allows you to record from one VCR to another VCR while watching a video program. You will also be able to record from one TV channel while watching another channel.

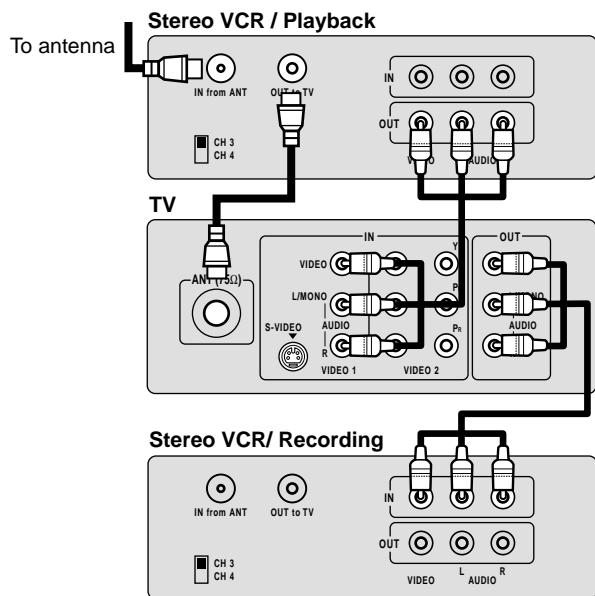

You will need:

- one coaxial cable
- two pairs of audio cables (only two cables for mono VCRs)
- two video cables

Caution:

Do not connect one VCR to the output and input jacks on the TV at the same time. If you are using a S-VHS VCR, use the S-video connections and remove the video cable.

Welcome to
Toshiba

Important
Safeguards

Connecting
your TV

Connecting a camcorder

This connection allows you to watch video materials recorded on a camcorder.

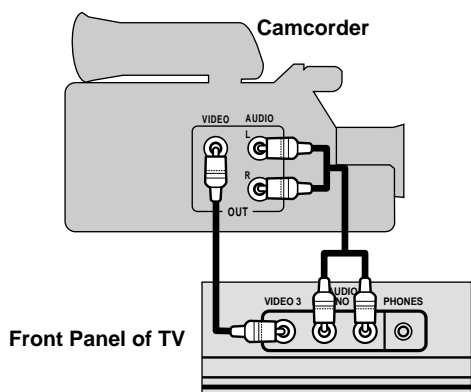

You will need:

- one pair of audio cables
- one video cable

Caution:

If you are using a S-VHS camcorder with a S-video output, use the Video1 jacks on the back of the TV.

Using the
Remote Control

Setting up
your TV

Connecting an audio amplifier

This connection allows you to use an audio amplifier to enjoy a high-quality sound. This also allows you to use external speakers. To control the audio, turn on the TV and the stereo amplifier. You will need one pair of audio cables.

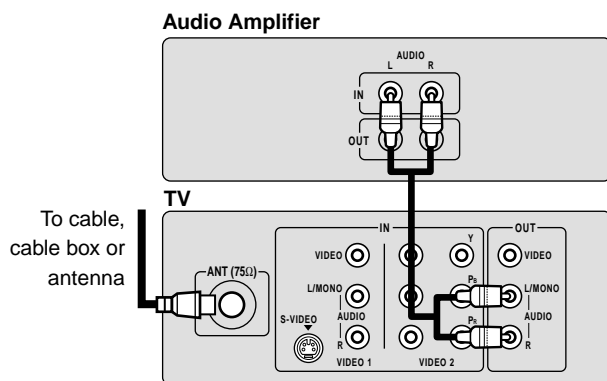

Using the TV's
Features

Appendix





Using the remote control

Preparing the remote control for use

With the remote control, you can operate your TV, most VCR models, and cable TV converters together, even if they are different brands. If you will be using your TV with a Toshiba VCR, your remote control is already programmed and ready to use. If you own different brands of VCRs and/or converters, you first have to program your remote control. (See "Programming the remote control for use with a VCR or a cable TV converter" on page 9.)

Installing the remote control batteries

To install the batteries:

1. Open the battery cover of the back of the remote control.

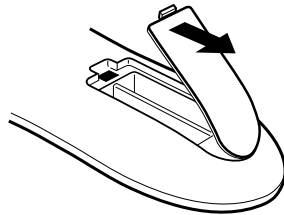

2. Install two "AAA" size batteries. Match the + and - signs on the batteries to the signs on the battery compartment.

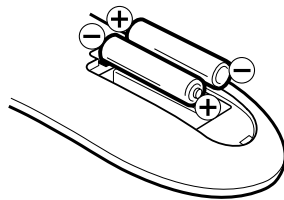

3. Close the battery cover on to the remote control until the lock snaps.

Note:

This remote control's functions may or may not operate your VCR or cable TV converter. Refer to the owner's manuals supplied with the equipment to see which features are available. In addition, the original controllers may have features not available on this remote control. If you would like to continue to use these features, you may want to use the original remote control.

Caution:

- Dispose of your batteries in a designated disposal area. Do not throw your batteries into a fire.
- Do not mix battery types or combine used batteries with new ones.
- Remove dead batteries immediately to prevent battery acid from leaking into the battery compartment.
- If you do not intend to use the remote control for a long time, remove the batteries.

Using the Remote Control

Using the remote control with a VCR or a cable TV converter

To control a Toshiba VCR:

Press the VCR button first. The buttons shown to the right will then control the VCR. The rest of the buttons will operate the TV as usual.

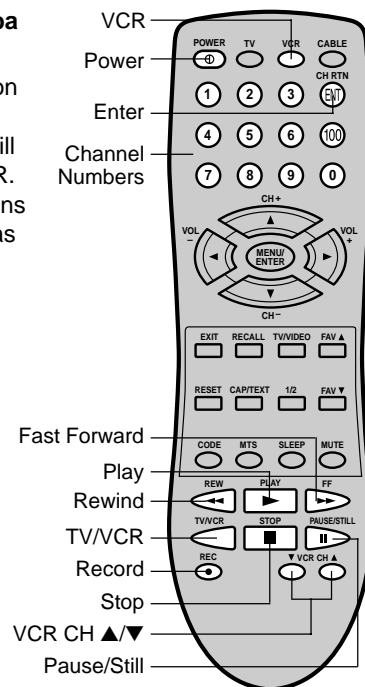

To control a cable TV converter:

Program the remote control to recognize the brand of your converter (see "Programming the remote control for use with a VCR or cable TV converter", on page 9). The buttons shown on the right will control the cable TV converter. Press the CABLE button first.

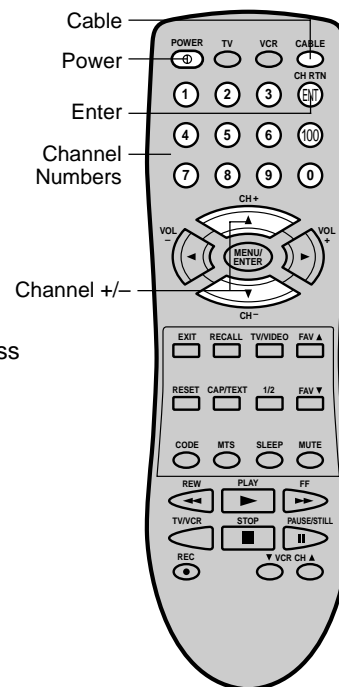



Programming the remote control for use with a VCR or a cable TV converter

This remote control is pre-programmed to operate Toshiba VCRs. To use VCRs or cable converters other than Toshiba models, you must follow the steps below before you operate your remote control.

1. Press the CODE button and the VCR or the CABLE button you want to register at the same time.
2. Enter the 2-digit code listed below using the Direct Channel Selection buttons (0-9) within 10 seconds.
3. Point the remote control at the VCR or converter and press POWER to test the code number.
If the VCR or converter turns on, you have entered the right number.
If the VCR or converter does not respond to the remote control, you may have entered the wrong number. Repeat steps 1-2 with another code number.

For future reference, write down the code numbers you used:

VCR code _____

Cable code _____

Note:

- When shipped from the factory, the remote control is set to operate your TV.
- If you do not enter the code within 10 seconds from step 1 or enter the non-listed code below, this operation is canceled.
- Each time you replace the batteries, you must reprogram the remote control.
- Some newer VCRs are capable of working on either of two remote codes. These VCRs have a switch labeled "VCR1/VCR2". If your VCR has this kind of switch, it may not respond to any of the code numbers for your VCR brand name. In this case, set the switch to the other position (VCR1 or VCR2) and reprogram the remote control.

Registration codes by product and brand name

VCR			
Admiral	08, 61	Multi Tech	39
Adventura	31	NEC	02, 18
Aiwa	31	Orion	33, 50
Akai	23, 38, 41	Panasonic	14, 51, 59
Audio Dynamics	02, 18	Pentax	15
Bell & Howell	06, 47	Philco	07, 14
Broksonic	21, 26, 33, 50, 55	Philips	07, 14, 27
Canon	14	Pioneer	10, 15
Citizen	09	Portland	46
Craig	12	Pro Scan	16, 60
Curtis Mathes	14, 59	Quasar	14, 59
Daewoo	44, 46, 48, 54	RCA	15, 16, 20, 27, 40, 42, 60
Daytron	36, 46	Realistic	06, 08, 12, 14, 31
DBX	02, 18	Samsung	20, 30
Emerson	03, 21, 23, 26, 33, 35, 43, 50	Sansui	39
Fisher	11, 12, 13, 47	Sanyo	06, 12, 47
Funai	31	Scott	04, 05, 33, 43
General Electric	14, 16, 20	Sears	06, 09, 11, 12, 15
Goldstar	09	Sharp	08, 61
Go Video	56, 62, 63	Shintom	39
Hitachi	15, 57	Signature 2000	08, 14, 16, 19, 31, 49
Instant Replay	14, 27	Sony	17, 32, 37
J.C. Penney	14, 15, 18, 27	Sylvania	07, 14, 27
JVC	02, 25, 58	Symphonic	31
Kenwood	02	Tashiko	09
Logik	39	Tatung	02
LXI	09, 31	Teac	02, 31
Magnavox	07, 14, 31	Teknika	34
Marantz	07, 18	Toshiba	05, 15
Marta	09	XR1000	39
Memorex	06, 12, 14, 31, 33	Vector Research	04, 18
Mitsubishi	04, 22, 52, 64	Yamaha	02, 18
Montgomery Ward	08, 14, 16, 19, 31, 49	Zenith	01, 24, 25, 29, 37

CABLE			
Allegro	58, 62	RCA DSS	73
Allegro A/B Switch	61	Regency	29
Gemini	05, 31, 38	Samsung	35
General Electric	67	Scientific Atlanta	16, 23, 36, 64
General Instrument	05, 06	Sprucer	13
Hamlin	02, 03, 45, 65, 66	Standard Comp	35
Jerrold	04, 07, 08, 09, 10, 18, 60, 63	Texscan	39, 56, 71
Kale Vision	35	Tocom	17, 18, 46
Macom	14, 21	Unika	48, 62
Magnavox	34	United Satellite	44
NSC	35, 39, 68, 69, 70	Universal	58, 62
Oak	11, 32, 42	Vid Tech	40
Panasonic	13, 20	Video Way	49
Paragon	33	Viewstar	54, 55, 72
Philips	47, 50, 52, 54, 55	Zenith	01, 53, 74
Pioneer	15, 43	Zenith Satellite	12, 28, 30, 51





Learning about the remote control

POWER turns the TV on and off (page 8)

Sleep timer sets the TV to go off at a set time (page 21)

TV/Video selects video input source (page 21)

Channel + / - cycles through programmed channels (page 12)

TV/VCR/Cable switches between TV, VCR and Cable (page 9)

Channel Numbers allow direct access to channels (page 12)

Volume + / - adjusts the volume level

Channel Return returns to the last viewed channel (page 13)

Menu allows access to programming menus (pages 11-24)

Enter sets programmed menu information (pages 11-24)

Favorite Channels ▲▼ cycles through favorite channels (page 13)

Reset resets settings to preset factory formats (pages 20 and 23)

Closed Captioning turns closed captioning on or off and selects channel 1 or 2 (page 21)

Mute mutes the sound (page 22)

MTS switches MTS sound (page 22)

Recall displays screen information (page 21)

CODE is used to programming the remote control (page 9)

Exit exits programming menus (pages 11-24)

Stop stops a videotape

Rec starts recording a videotape

Play plays a videotape

FF fast forwards a videotape

Rew rewinds a videotape

Pause/Still pauses or still a videotape

TV/VCR toggles between TV and VCR when viewing while recording

VCR Channel ▲▼ cycles through programmed channels of VCR

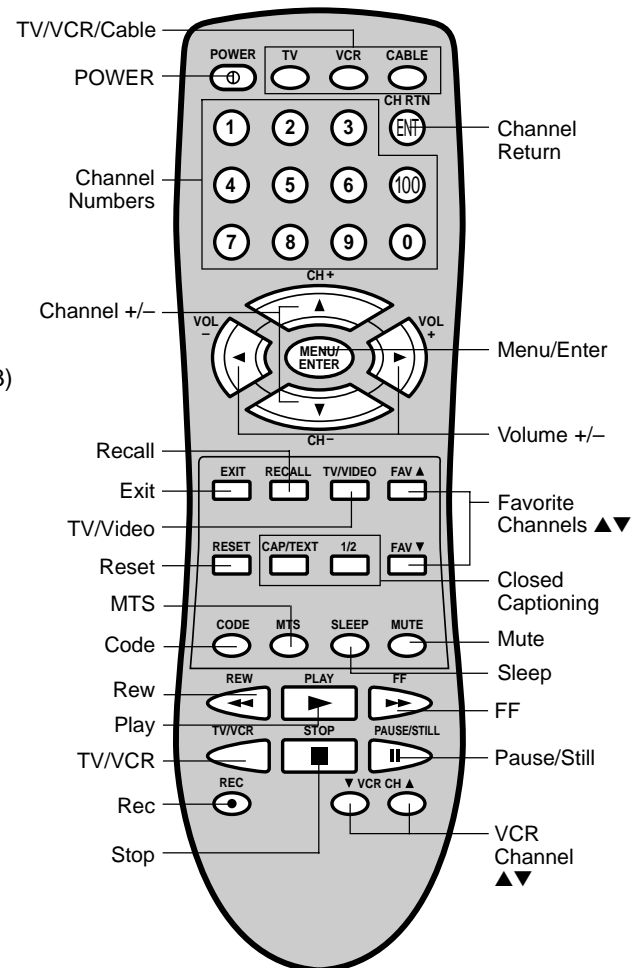

Using the Remote Control



Setting up your TV

After you've installed the batteries and programmed the remote control, you need to set some preferences on the TV using the menu. You can access the menu with the buttons on the remote control.

- When you make a menu selection, your changes occur immediately. You do not have to press MENU or EXIT to see your changes.
- After fifteen seconds, the menu screen will automatically disappear if you do not make a selection. Your changes will still be saved.
- When you are finished programming the menus, press EXIT.

Changing the on-screen display language

You can choose from three different languages (English, French and Spanish) for the on-screen displays. Adjustment menus and messages will appear in the language of your choice.

To select a language:

1. Press MENU, then press ◀ or ▶ until the OPTION menu appears.
2. Press ▲ or ▼ to highlight LANGUAGE.

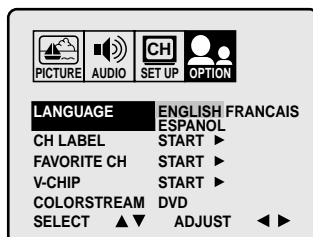
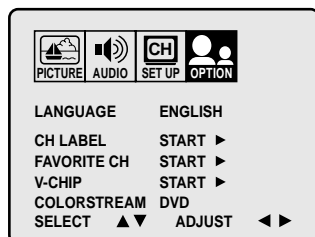

3. Press ◀ or ▶ to highlight your desired language.

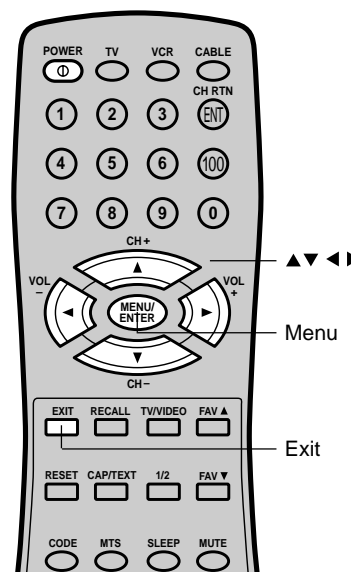

Welcome to
Toshiba

Important
Safeguards

Connecting
your TV

Using the
Remote Control

Setting up
your TV

Using the TV's
Features

Appendix





Adding channels to the TV's memory

Your TV will stop on specific channels that are stored in the TV's channel memory when you press Channel + or -. Use the steps below to set all active channels in your area automatically.

Programming channels automatically

Your TV can automatically detect all active channels and store them in its memory. After the TV has stored the channels in its memory, you can erase channels or add your favorite channels.

To add channels:

1. Press MENU, then press ◀ or ▶ to display the SET UP menu.
2. Press ▲ or ▼ until the TV/CABLE selection is highlighted.
3. Press ◀ or ▶ to highlight either TV or CABLE, depending on which you use.

If you use an antenna, choose TV.
If you use cable, choose CABLE.

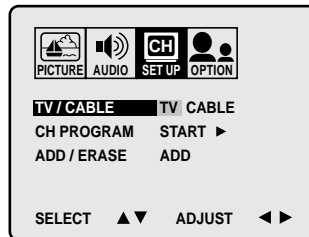

4. Press ▼ to select CH PROGRAM.
5. Press ◀ or ▶ to start channel programming. The TV will automatically cycle through all the TV or Cable channels (depending on which you selected), and store all active channels in the channel memory. While the TV is cycling through the channels, the message "PROGRAMMING NOW PLEASE WAIT" appears and count up the received channel.
6. When channel programming is complete, the message "COMPLETED (channel or cable number)" appears.
7. Press Channel ▲ or ▼ to view the programmed channels.

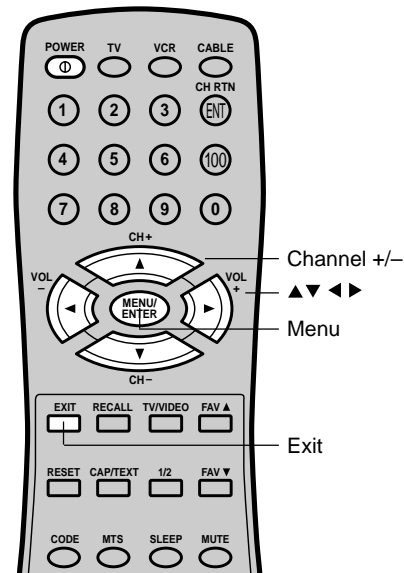

Adding and erasing channels manually

After you've programmed the channels, you can add or erase specific channels.

To add or erase channels:

1. Select the channel you want to add or erase using Channel + or -. If adding channels, you must select the channel to add by using the Channel Number buttons.
2. Press MENU, then press ◀ or ▶ to display the SET UP menu.
3. Press ▲ or ▼ to highlight ADD/ERASE.
4. Press ◀ or ▶ to select ADD or ERASE, whichever function you want to perform.
5. Repeat steps 1-4 for other channels you want to add or erase.

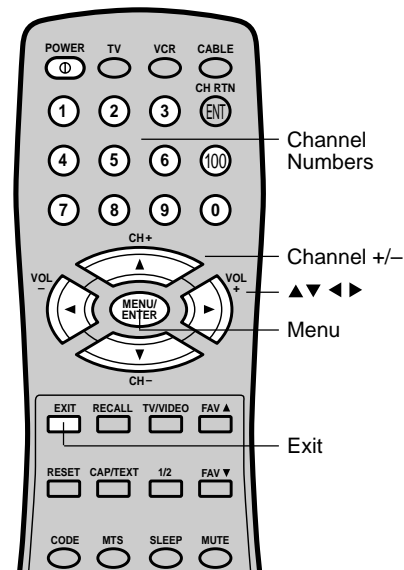
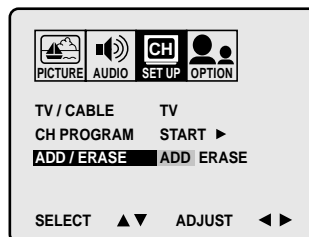

Setting up
your TV

Changing channels

To change the channel, you can:

- change the programmed channels using the remote control
- select a channel directly using the remote control
- scan the channels using the TV buttons

To change to the next programmed channel:

Press Channel + or - on the TV or remote control.

To change to a specific channel (programmed or unprogrammed):

Press the Channel Number buttons (0-9 and 100).

For example, to select channel 125, press the 100 button, the 2 button, and the 5 button.





Using the TV's features

Adjusting the channel settings

Switching between two channels

You can switch between two channels without entering an actual channel number each time.

To switch between two channels:

1. Select the first channel you want to view.
2. Select a second channel with the Channel Number buttons (0-9, 100).
3. Press CH RTN. The previous channel will be displayed.

Each time you press CH RTN, the TV will switch back and forth between the two channels.

Programming your favorite channels

You can preset up to 12 of your favorite channels using the Favorite Channel Programming feature. Because this feature scans through only your favorite channels, it allows you to skip other channels you do not normally watch.

You can still use Channel ▲▼ to scan through all the channels you programmed in the TV's memory.

To program your favorite channels:

1. Select a channel you want to program.
2. Press MENU, then press ◀ or ▶ to display the OPTION menu.
3. Press ▲ or ▼ to highlight FAVORITE CH.

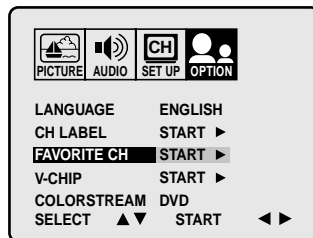

4. Press ◀ or ▶ to display the FAVORITE CH menu. SET/CLEAR will be highlighted.

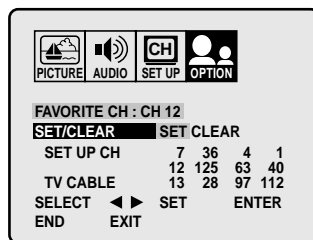

5. Press ◀ or ▶ to highlight SET and press ENTER.
6. Press EXIT to clear the screen.
7. Repeat steps 1 through 6 for up to 11 other channels.

To select your favorite channels:

Press the FAV ▲▼ buttons on the remote control to select your favorite channels.

The FAV ▲▼ buttons will not work until you have programmed your favorite channels.

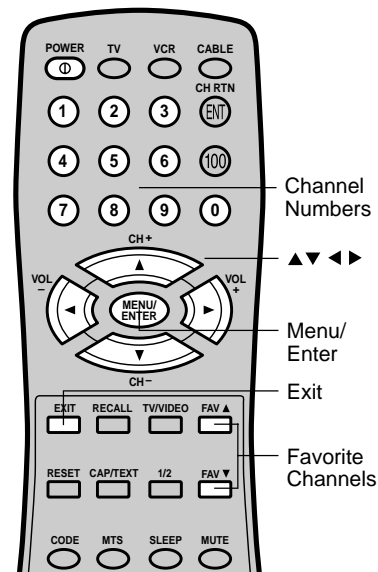
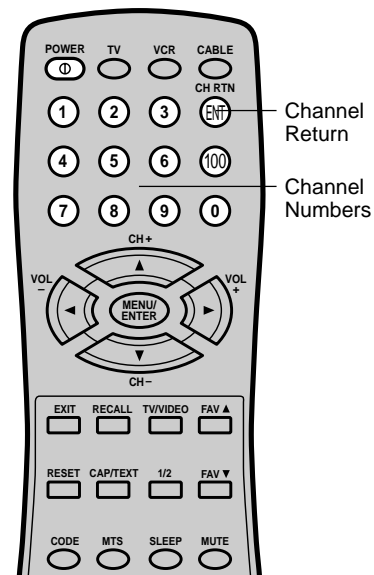

Welcome to
Toshiba

Important
Safeguards

Connecting
your TV

Using the
Remote Control

Setting up
your TV

Using the TV's
Features

Appendix



To clear your favorite channels:

1. Select a channel you want to clear.
2. Press MENU, then press ◀ or ▶ to display the OPTION menu.
3. Press ▲ or ▼ to highlight FAVORITE CH.
4. Press ◀ or ▶ to display the FAVORITE CH menu. SET/CLEAR will be highlighted.

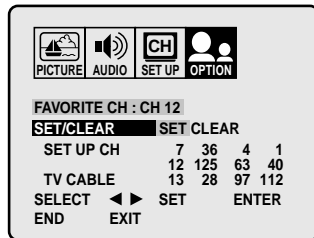

5. Press the ◀ or ▶ to highlight CLEAR.

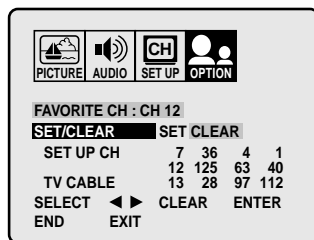

6. Press ENTER until "0" replaces the channel number you want to erase.
7. Press EXIT to clear the screen.
8. Repeat steps 1 through 6 for the other channels.

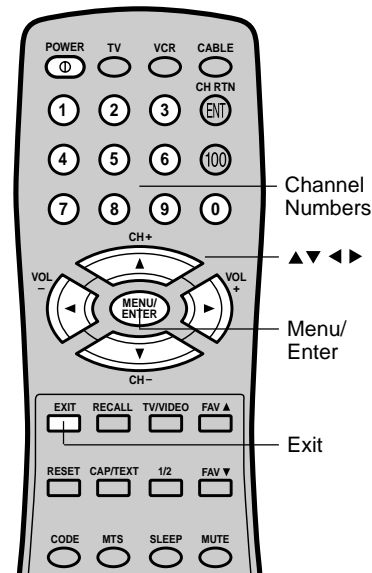

Using the V-Chip

You can prevent others from viewing certain programs or channels by using the V-Chip feature.

Selecting a PIN code

Before you can block programs and channels, though, you must select a personal identification number (PIN) code. The PIN code you select prevents others from changing the rating limits you set.

To select your PIN code and access the V-Chip menus:

1. Press MENU, then press ◀ or ▶ to highlight the OPTION menu.
2. Press ▲ or ▼ to highlight V-CHIP.

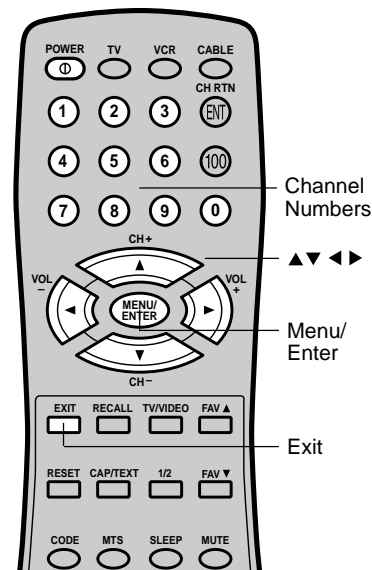
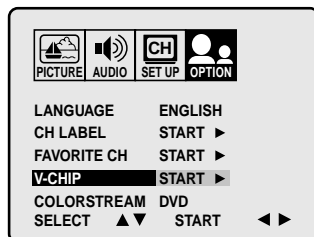



- Press **◀** or **▶** to display the V-CHIP menu.

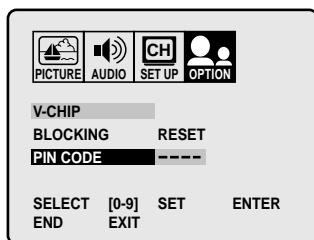

- Use the Channel Number buttons (0-9) to enter your PIN code. If you are accessing the V-Chip menus for the first time, select a four-digit number to be your PIN code. Press **ENTER**. The **BLOCKING** menu appears.

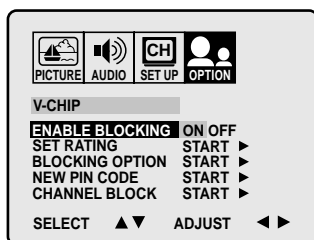

- You may now enable blocking—“Blocking programs by ratings” (see below), “Blocking channels” (see page 18), “To change your PIN code” (below) or “Blocking unrated movies or programs” (see page 18).

To change your PIN code:

- Press **MENU**, then press **◀** or **▶** to display the **OPTION** menu.
- Press **▲** or **▼** to highlight **V-CHIP**.
- Press **◀** or **▶** to display the **V-CHIP** menu.
- Use the Channel Number buttons (0-9) to enter your PIN code. If you are accessing the V-Chip menus for the first time, select a four-digit number to be your PIN code. Press **ENTER**. The **BLOCKING** menu appears.
- Press **▲** or **▼** to highlight **NEW PIN CODE** and press **◀** or **▶** to display the **NEW PIN CODE** menu.
- Use the Channel Number buttons (0-9) to enter a new code. Press **ENTER**.
- Press **EXIT** to return to normal viewing.

Blocking programs by ratings

The Motion Picture Association of America (MPAA) uses a rating system to qualify motion picture content. Television broadcasters employ a rating system to qualify the content of television programs, as well. The MPAA, Youth TV and TV ratings work with the V-Chip feature and allow you to block out programming above the rating limits you determine.

Note:

If you forget your PIN code, press **RECALL** four times within five seconds from the **V-CHIP** menu. This allows you to proceed to the **BLOCKING** menu and reset your PIN code.

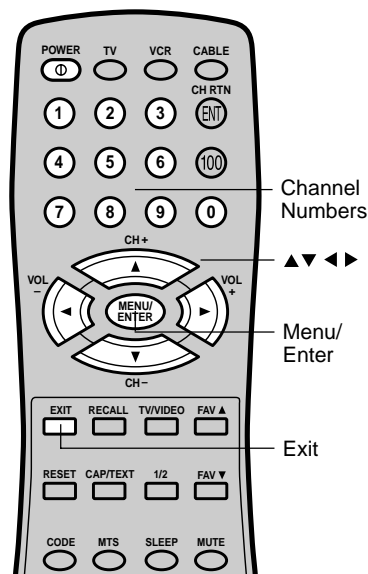

Welcome to
Toshiba

Important
Safeguards

Connecting
your TV

Using the
Remote Control

Setting up
your TV

Using the TV's
Features

Appendix



MPAA Ratings

X	For adults only.
NC17	Not intended for anyone 17 or under.
R	Restricted. Under 17 requires an accompanying parent or adult guardian.
PG13	Parents strongly cautioned. Some material may be inappropriate for children under 13.
PG	Parental guidance suggested. Some material may not be appropriate for children.
G	General audience. Appropriate for all ages.

Youth TV Ratings

Y7, Y7 FV	Directed to older children. This program is designed for children age 7 and above. For those programs where fantasy violence may be more intense or more combative than other programs in this category, such programs are designated TV-Y7-FV.
Y	All children. This program is designed to be appropriate for all children.

TV Ratings

MA	Mature audience only. This program is specifically designed to be viewed by adults and therefore may be unsuitable for children under 17.
	Language Crude or indecent language.
	Sex Explicit sexual activity.
	Violence Graphic violence.
14	Parents strongly cautioned. This program contains some material that many parents would find unsuitable for children under 14 years of age.
	Dialog Intensely suggestive dialog.
	Language Strong, coarse language.
	Sex Intense sexual situations.
	Violence Intense violence.
PG	Parental guidance suggested. This program contains material that parents may find unsuitable for younger children.
	Dialog Some suggestive dialog.
	Language Infrequent coarse language.
	Sex Some sexual situations.
	Violence Moderate violence
G	General audience. Most parents would find this program suitable for all ages.
No DLSV	Programs without any Dialog, Language, Sex or Violence ratings.

Note:

To see the rating of the program you are viewing, press **RECALL** at any time.



To use the V-Chip to block programs by rating:

1. Press MENU, then press ◀ or ▶ to display the OPTION menu.
2. Press ▲ or ▼ to highlight V-CHIP.
3. Press ◀ or ▶ to display the V-CHIP menu.
4. Use the Channel Number buttons (0-9) to enter your PIN code. If you are accessing the V-Chip menus for the first time, select a four-digit number to be your PIN code. Press ENTER. The BLOCKING menu appears.

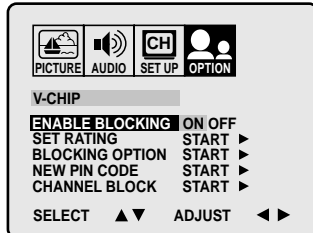

5. Press ▲ or ▼ to highlight ENABLE BLOCKING.
 - Press ◀ or ▶ to highlight ON to enable the V-Chip and program blocking by rating.
 - Press ◀ or ▶ to highlight OFF to disable the V-Chip and program blocking by rating.
6. Press ▲ or ▼ to highlight SET RATING. Then, press ◀ or ▶ to display the SET RATING menu.

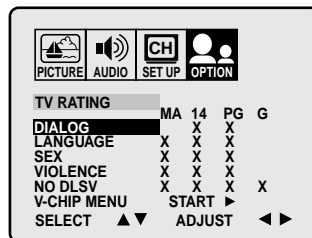
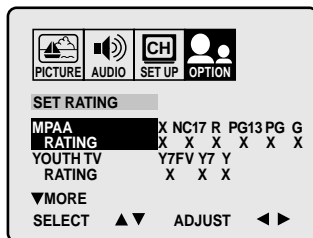

7. Press ▲ or ▼ to highlight MPAA Rating, Youth TV Rating or individual TV Ratings.
8. Press ◀ or ▶ to select the ratings which will be blocked. Blocked ratings are signified by a red "X". Unblocked ratings are signified by a green "✓". As you block ratings, all ratings higher than the ones you select are blocked, as well. For example, if you choose to block the MPAA rating R, the higher ratings, NC17 and X, are automatically blocked, too.
9. When you are done selecting the ratings to be blocked, press EXIT to return to normal viewing.

When you try to view a program with a ratings block, a message will appear listing the program's ratings. The program can still be viewed if you press MUTE and then enter your PIN code to temporarily bypass the block.

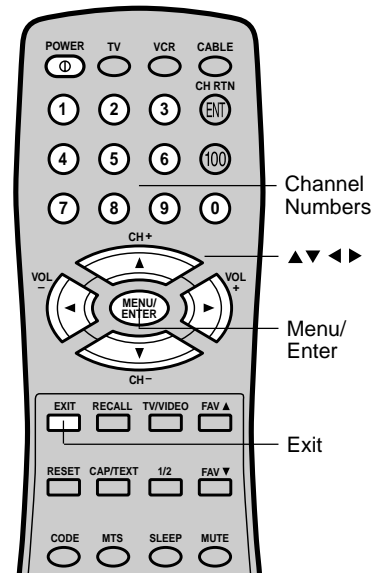

Welcome to Toshiba

Important Safeguards

Connecting your TV

Using the Remote Control

Setting up your TV

Using the TV's Features

Appendix



Blocking unrated movies or programs

Some movies and programs are not rated. You can block these movies and programs using the V-Chip.

To block unrated movies or programs:

1. Press MENU, then press ◀ or ▶ to display the OPTION menu.
2. Press ▲ or ▼ to highlight V-CHIP.
3. Press ◀ or ▶ to display the V-CHIP menu.
4. Use the Channel Number buttons (0-9) to enter your PIN code.
If you are accessing the V-Chip menus for the first time, select a four-digit number to be your PIN code. Press ENTER. The BLOCKING menu appears.
5. Press ▲ or ▼ to highlight BLOCKING OPTION.
6. Press ◀ or ▶ to display the BLOCKING OPTION menu.
7. Press ▲ or ▼ to highlight MPAA UNRATED.
 - Press ◀ or ▶ to highlight ON to block unrated movies.
 - Press ◀ or ▶ to highlight OFF to unblock unrated movies.
8. Press ▲ or ▼ to highlight TV NONE RATING.
 - Press ◀ or ▶ to highlight ON to block programs with a rating of "TV NONE". While you select ON position the message "NOTICE: ENABLING THIS OPTION MAY BLOCK EMERGENCY MESSAGES" appears.
 - Press ◀ or ▶ to highlight OFF to unblock programs with a rating of "TV NONE".
9. Press EXIT to return to normal viewing.

Note:

Blocking television programs with a rating of "TV NONE" may block emergency messages.

Blocking channels

You can also choose to block individual channels. These channels will not be seen regardless of the ratings of their programming. You can choose to block up to four TV channels and four cable channels.

To block channels:

1. Use the Channel Number Buttons (0-9) display the television channel you wish to block.
2. Press MENU, then press ◀ or ▶ to highlight the OPTION menu.
3. Press ▲ or ▼ to highlight V-CHIP and then press ◀ or ▶ to display the V-CHIP menu.
4. Use the Channel Number buttons (0-9) to enter your PIN code.
If you are accessing the V-Chip menus for the first time, choose a four-digit number to be your PIN code. Press ENTER.
5. Press ▲ or ▼ to highlight CHANNEL BLOCK and then press ◀ or ▶ to display the CHANNEL BLOCK menu.

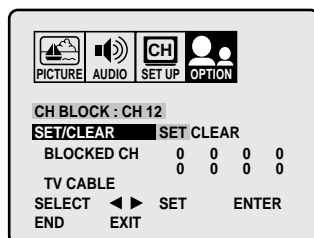

6. Press ◀ or ▶ to:
 - SET the channel as one to be blocked.
 - CLEAR all channels from the list of blocked channels.
7. Press ENTER.

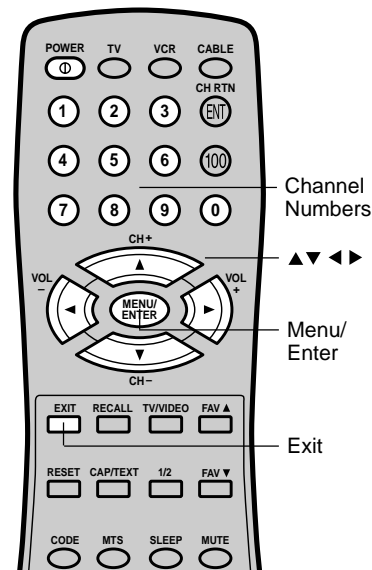



- Repeat steps 1 through 7 to block other channels. When you are finished blocking channels, press EXIT to return to normal viewing.

If you try to display a blocked channel, the TV will not display it, but will display the nearest unblocked channel.

To unblock channels:

- Press MENU, then press ◀ or ▶ to display the OPTION menu.
- Press ▲ or ▼ to highlight V-CHIP and then press ◀ or ▶ to display the V-CHIP menu.
- Use the Channel Number buttons (0-9) to enter your PIN code. If you are accessing the V-Chip menus for the first time, choose a four-digit number to be your PIN code. Press ENTER.
- Press ▲ or ▼ to highlight CHANNEL BLOCK and then press ◀ or ▶ to display the CHANNEL BLOCK menu.
- Press ◀ or ▶ to highlight CLEAR and clear all channels from the list of blocked channels. Press ENTER.
- Press EXIT to return to normal viewing.

Note:

After programming CHANNEL BLOCK, change channels before turning off the television.

Labeling channels

Channel labels will appear over the channel number display each time you turn on the TV, select a channel, or press the Recall button. You can choose any four characters to identify the channels.

To create channel labels:

- Select a channel you want to label.
- Press MENU then press ◀ or ▶ until the OPTION menu appears.
- Press ▲ or ▼ to highlight CH LABEL.

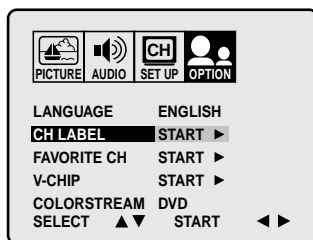

- Press ▶ to display the CH LABEL menu. SET/CLEAR will be highlighted.
- Press ◀ or ▶ to highlight SET.

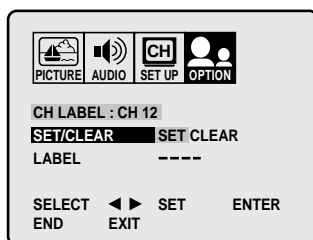

- Press ▲ or ▼ to highlight LABEL.

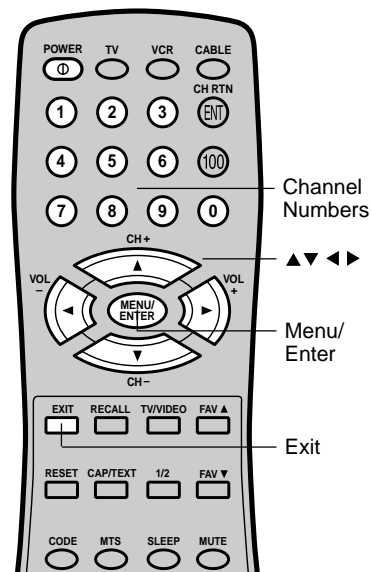
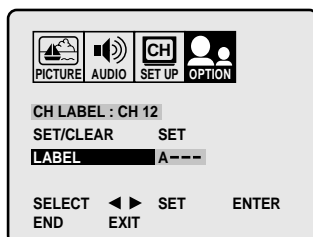

- Welcome to Toshiba
- Important Safeguards
- Connecting your TV
- Using the Remote Control
- Setting up your TV
- Using the TV's Features
- Appendix



- Assign the label to the channel. Press ◀ or ▶ to enter a character in the first space. Press the button repeatedly until the character you want appears on the screen. Press ENTER.

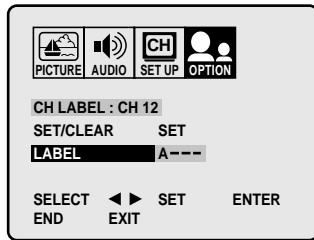

- Repeat step 7 to enter the rest of the characters. If you would like a blank space in the label name, you must choose an empty space from the list of characters. Otherwise, a dash will appear in that space.
- Press EXIT to clear the screen.
- Repeat steps 1 through 8 for other channels. You can assign the label to all the channels.

To erase channel labels:

- Select a channel with a label.
- Press MENU then press ◀ or ▶ until the OPTION menu appears.
- Press ▲ or ▼ to highlight CH LABEL.
- Press ◀ or ▶ to display the CH LABEL menu. SET/CLEAR will be highlighted.
- Press ◀ or ▶ to highlight CLEAR.
- Press ENTER.
- Repeat steps 1 through 6 to erase other channel labels.

Adjusting the picture

Adjusting the picture quality

You can adjust the picture quality to your personal preferences, including the contrast, brightness, color, tint, and sharpness. The qualities you choose will be stored automatically in your TV's memory so you can recall them at any time.

To adjust the picture quality:

- Press MENU, then press ◀ or ▶ to display the PICTURE menu.

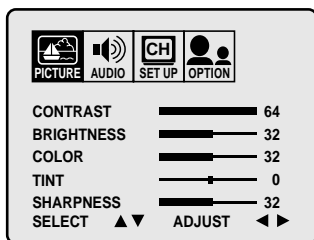

- Press ▲ or ▼ until the item you want to adjust is highlighted.
- Press ◀ or ▶ to adjust the level.

The PICTURE items you have adjusted will be stored in the TV's memory automatically.

Selection	◀ Pressing	▶
contrast	lower	higher
brightness	darker	lighter
color	paler	deeper
tint	reddish	greenish
sharpness	softer	sharper

Note:

The character will change as below.

◀ → 0 ← → ... ← → 9 ← → A ← → ...
 ◀ → Z ← → SPACE ← → + ← → -

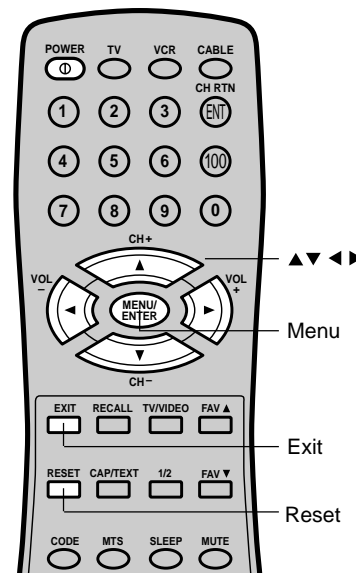

Note:

To reset the picture adjustments to the factory settings, press RESET.





Watching video input

You can use the TV/VIDEO button on the remote to view a signal coming from other devices, such as VCRs or video disc players that may be connected to your TV. (See "Connecting your TV" on page 4.)

Selecting the ColorStream mode

You can use either the ColorStream input for connecting the DVD or DTV receiver.

1. Press MENU, then press ◀ or ▶ until the OPTION menu appears.
2. Press ▲ or ▼ to highlight COLORSTREAM.
3. Press ◀ or ▶ to highlight DVD or DTV depending on which device is connected.

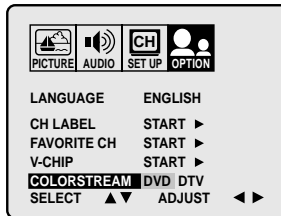

Displaying on-screen information

Press RECALL to display the following on-screen information:

- Channel number or VIDEO mode selected
- Channel label (if preset)
- Stereo or SAP (second audio program) audio status

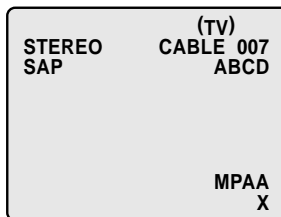

Setting the sleep timer

You can set the TV so it turns off automatically.

To set the sleep timer:

Press the SLEEP button on the remote control. The clock will count down 10 minutes for each press of the SLEEP button (120, 110, ... 10, 0). After the sleep time is programmed, the display will appear briefly every ten minutes to remind you that the sleep timer is operating.

To confirm the sleep timer setting:

Press the SLEEP button and the remaining time will be momentarily displayed.

To cancel the sleep timer:

Press the SLEEP button repeatedly until the display turns to 0.

Using the closed caption feature

You have two options with the closed caption feature: captions or text. A caption is a printed version of the dialogue, narration and/or sound effects of a TV program. Text is information not related to the program that appears on half of the TV screen.

To view captions or text:

1. Select the desired program. The captioned programs are usually marked in your local TV listing by "CC".
2. Press CAP/TEXT repeatedly to select caption or text mode.

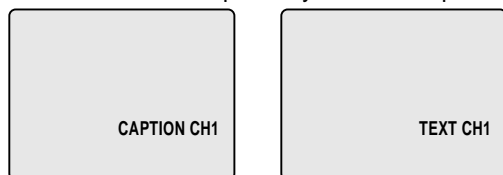

3. Press 1/2 to select caption or text channel.

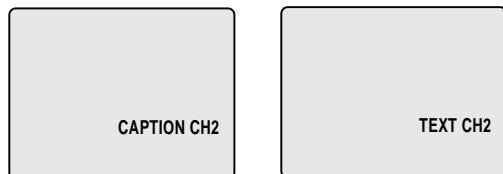

4. To turn off the closed-captioned feature, press CAP/TEXT repeatedly until the normal TV viewing appears on the screen.

To select the input mode:

Press the TV/VIDEO button repeatedly to select desired mode. The signal source you are connected to is displayed in light blue.

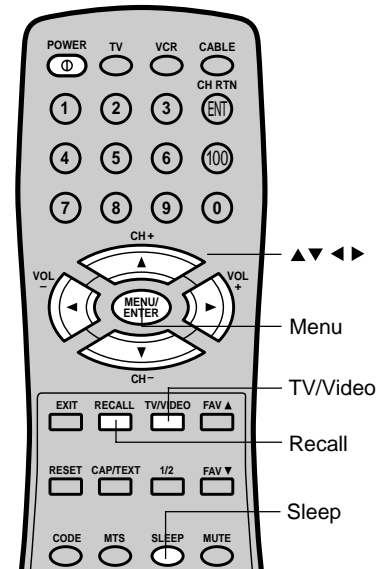

Note:

The factory settings are DVD.

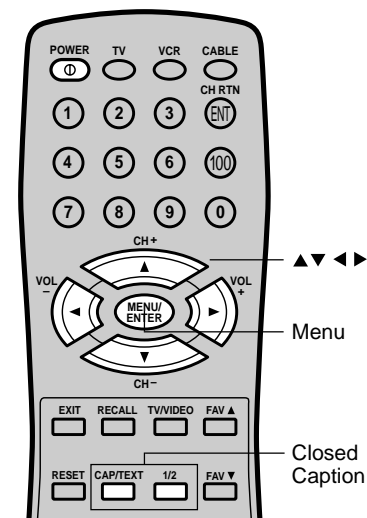

Note:

A closed caption signal may not be decoded in the following situations:

- when a video tape has been dubbed
- when the signal reception is weak
- when the signal reception is non-standard

When you choose a closed captioned channel and the text mode, the text screen always appears. When there is no signal, however, the text screen will not display text characters.

Welcome to
Toshiba

Important
Safeguards

Connecting
your TV

Using the
Remote Control

Setting up
your TV

Using the TV's
Features

Appendix



Adjusting the sound

Muting the sound

Press MUTE to temporarily turn off the sound. While the sound is off, the screen will display the word MUTE in the lower right-hand corner. To restore the sound, press MUTE again.

Selecting stereo/SAP broadcasts

You can enjoy watching TV while you listen to high-fidelity stereo sound with the Multi-channel TV Sound (MTS) feature. MTS can also transmit a second audio program (SAP) containing a second language or other audio information.

When the TV receives a stereo or SAP broadcast, the word STEREO or SAP appears on the screen when the TV is on, you change the channel, or press the RECALL button.

The MTS feature is not available while in the VIDEO mode.

When you are watching a stereo broadcast, the word STEREO is displayed in light blue. You should leave your TV set to STEREO so you can automatically receive stereo or monaural sound, depending on the broadcast type. If the stereo sound is noisy, select MONO to reduce the noise. The word STEREO or SAP is displayed in light blue when the TV receives the signal.

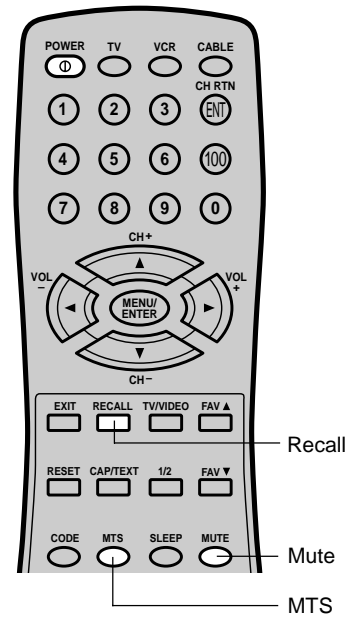

To select desired sound

Press the MTS button to select the desired sound.

MONO+SAP broadcasting

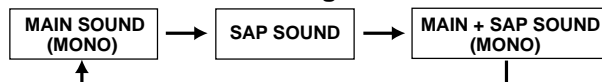

STEREO+SAP broadcasting

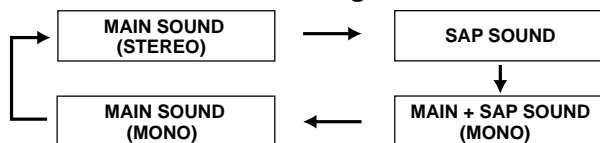



Adjusting the sound quality

You can change the sound quality of your TV by adjusting the bass, treble, and balance.

To adjust the sound quality:

1. Press MENU, then press ◀ or ▶ until the AUDIO menu appears.

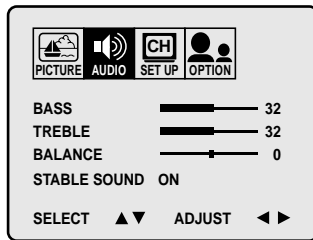

2. Press ▲ or ▼ to highlight the item you want to adjust.
3. Press ◀ or ▶ to adjust the level.

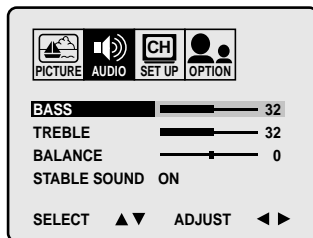

- ◀ makes the sound quality weaker or decreases the balance in the right channel, depending on the item selected.
- ▶ makes the sound quality stronger or decreases the balance in the left channel, depending on the item selected.

Using the STABLE SOUND feature

When the loud sound is made, the stable sound feature automatically lower the sound.

To turn on the STABLE SOUND feature:

1. Press MENU, then press ◀ or ▶ until the AUDIO menu appears.
2. Press ▲ or ▼ to highlight STABLE SOUND.
3. Press ◀ or ▶ to highlight ON.

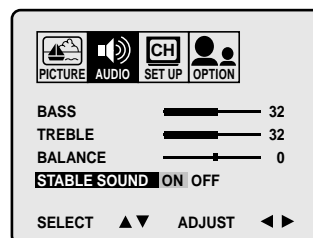

To turn off the STABLE SOUND feature:

Choose OFF in step 3 above.

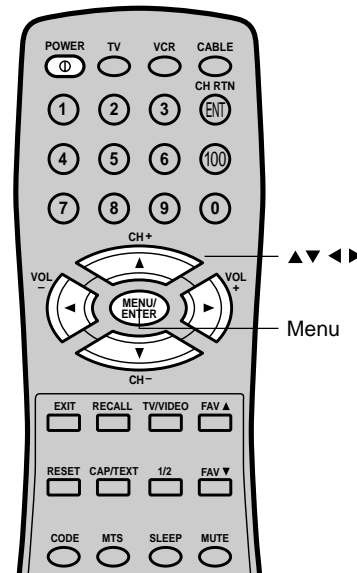

Note:

To reset the audio adjustments to the factory settings, press RESET.

Welcome to
Toshiba

Important
Safeguards

Connecting
your TV

Using the
Remote Control

Setting up
your TV

Using the TV's
Features

Appendix





Auto power off

The TV will automatically turn itself off after approximately 15 minutes if it is tuned to a vacant channel or if a station completes its broadcast for the day and stops broadcasting on that channel. This feature, however, does not work in the VIDEO mode.

Understanding the Power Return feature

If the power is cut off while you are viewing the TV and the power is resupplied, the Power Return feature will turn the TV on automatically.

If the power is going to be off for a long time or you are going to be away from home for a long time, remove the power plug from the wall outlet to prevent the TV from turning on in your absence.

Appendix

Cleaning and care

WARNING:

TV sets use high voltage. Do not try to remove the cabinet back. Refer servicing to qualified service technicians.

To clean the TV screen:

1. Unplug the TV to avoid possible shock hazard.
2. Use a clean cellulose sponge or chamois cloth dampened with a solution of mild detergent and warm water to clean the TV screen and trim. Do not use too much water because water spills into the cabinet can cause damage to the TV.
3. Wipe off any excess moisture with a clean dry cloth.
4. Polish the cabinet with a quality furniture polish to maintain the finish and appearance of the cabinet.

Caution:

Never use strong solvents such as thinner, benzene, or other chemicals on or near the cabinet. These chemicals can damage the finish of the cabinet.





Troubleshooting

Before calling a service technician, please check the following table for a possible cause of the problem and some solutions.

Problem

Solution

TV will not turn on	<ul style="list-style-type: none"> • Make sure the power cord is plugged in, then press POWER. • The remote control batteries may be dead. Replace the batteries.
No picture, no sound	<ul style="list-style-type: none"> • Check the antenna/cable connections.
No sound, picture OK	<ul style="list-style-type: none"> • The sound may be muted. Press VOLUME. • The station may have broadcast difficulties. Try another channel.
Poor sound, picture OK	<ul style="list-style-type: none"> • The station may have broadcast difficulties. Try another channel.
Poor picture, sound OK	<ul style="list-style-type: none"> • Check the antenna connections. • The station may have broadcast difficulties. Try another channel. • Adjust the PICTURE menu.
Poor reception of broadcast channels	<ul style="list-style-type: none"> • The station may have broadcast difficulties. Try another channel. • Check the antenna connections. • If you are using a VCR, make sure the TV/VCR button is set correctly.
Cannot receive above channel 13	<ul style="list-style-type: none"> • Make sure TV/CABLE is set to CABLE mode.
Unable to select a certain channel	<ul style="list-style-type: none"> • The channel may be blocked out with the V-Chip feature, or erased with the add/erase feature.
Multiple images	<ul style="list-style-type: none"> • The station may have broadcast difficulties. Try another channel. • Use a highly directional outdoor antenna.
Poor color or no color	<ul style="list-style-type: none"> • The station may have broadcast difficulties. Try another channel. • Adjust the TINT and/or COLOR in the PICTURE menu. • If you change the direction of the TV while it is turned on, the picture could suffer from color shading. If so, turn off the TV and allow it to cool down for several hours before turning it on again.
No stereo or SAP sound from a known MTS broadcast	<ul style="list-style-type: none"> • Make sure the MTS feature is set properly.
The remote control does not operate	<ul style="list-style-type: none"> • Check if the TV/VCR/CABLE mode is properly set. • There may be an obstruction between the remote control and the remote control sensor. • The remote control batteries may be dead. Replace the batteries.
The V-Chip PIN code does not work	<ul style="list-style-type: none"> • Change or reset your PIN code (see page 14, Selecting a PIN code).

Welcome to
Toshiba

Important
Safeguards

Connecting
your TV

Using the
Remote Control

Setting up
your TV

Using the TV's
Features

Appendix





Specifications

Picture Tube	Type 14 (357 mm diagonal)
Television system	NTSC standard
Channel coverage	VHF: 2 ~ 13 UHF: 14 ~ 69 Cable TV: 4A, A-5 ~ A-1, A-I, J ~ W, W+1 ~ W+48
Power source	120V AC, 60 Hz
Power consumption	75 W
Audio power	2.5W + 2.5W
Speaker type	1-5/8 x 2-13/16 inches (41 x 71 mm) x 2 pcs.
Video/Audio terminals	S-VIDEO INPUT Y-INPUT: 1V (p-p), 75 ohm, negative sync. C-INPUT: 0.286V (p-p) (burst signal), 75 ohm VIDEO/AUDIO INPUT VIDEO: 1V (p-p), 75 ohm, negative sync. AUDIO: 150 mV (rms) (30% modulation equivalent, 47k ohm) ColorStream™ (component video) INPUT Y : 1V (p-p), 75 ohm PR : 0.7V (p-p), 75 ohm PB : 0.7V (p-p), 75 ohm VIDEO/AUDIO OUTPUT VIDEO: 1V (p-p), 75 ohm, negative sync. AUDIO: 150 mV (rms) (30% modulation equivalent, 47k ohm)
Dimensions	Width: 17 inches (432 mm) Height: 13-9/16 inches (344.5 mm) Depth: 15-3/16 inches (386 mm)
Weight	24.3 lbs. (11 kg)
Supplied accessories	Remote control with two size "AAA" batteries

Design and specifications are subject to change without notice.





Limited United States Warranty

Toshiba America Consumer Products, Inc. ("TACP") and Toshiba Hawaii Inc. ("THI") make the following limited warranties. These limited warranties extend to the original consumer purchaser or any person receiving this set as a gift from the original consumer purchaser and to no other purchaser or transferee.

Limited Ninety (90) Day Warranty

TACP and THI warrant this product and its parts against defects in materials or workmanship for a period of ninety (90) days after the date of original retail purchase. During this period, TACP and THI will repair a defective product or part, without charge to you. You must deliver the entire set to an Authorized TACP/THI Service Station. You pay for all transportation and insurance charges for the set to and from the Service Station.

Limited One (1) Year Warranty

TACP/THI further warrant the parts in this product against defects in materials or workmanship for a period of one year after the date of original retail purchase. During this period TACP/THI will replace a defective part without charge to you, except that if a defective part is replaced after ninety (90) days from the date of original retail purchase you pay labor charges involved in the replacement. You must also deliver the entire product to a TACP/THI Authorized Service Station. You are responsible for all transportation for the set to and from the Service Station.

Limited Two (2) Year Warranty of Picture Tube

TACP and THI further warrant the picture tube in this product against defects in materials or workmanship for a period of two (2) years after the date of original retail purchase. During this period, TACP/THI will replace a defective picture tube without charge to you, except that if a defective picture tube is replaced after ninety (90) days from the date of original retail purchase, you pay labor charges involved in the replacement. You are responsible for all transportation and insurance charges for the set to and from the Service Station.

Rental units

The warranty for rental units begins with the first rental of thirty (30) days from the date of shipment to the rental firm, whichever comes first.

Commercial units

Products sold and used for commercial use have a limited ninety (90) day warranty for all parts, labor and picture tube.

Owner's manual and registration card

You should read this owner's manual thoroughly before operating this product. You should complete and mail the enclosed registration card within ten days after you, or the person who has given you this product as a gift, purchased this product. This is one way to enable TACP/THI to provide you with better customer service and improved products. Failure to return the registration card will not affect your rights under this warranty.

Your responsibility

The above warranties are subject to the following conditions:

- You must retain your bill of sale or provide other proof of purchase.
- All warranty servicing of this product must be made by an Authorized TACP/THI Service Station.
- **These warranties are effective only if the product is purchased and operated in the U.S.A. or Puerto Rico.**
- Labor service charges for set installation, set up, adjustment of customer controls and installation or repair of antenna systems are not covered by this warranty. Reception problems caused by inadequate antenna systems are your responsibility.
- Warranties extend only to defects in materials or workmanship as limited above and do not extend to any product or parts which have been lost or discarded by you or to damage to products or parts caused by misuse, accident, damage caused by Acts of God, such as lightning or fluctuations in electric power, improper installation, improper maintenance or use in violation of instructions furnished by us; or to units which have been modified or had the serial number removed, altered, defaced or rendered illegible.

How to obtain warranty service

If after following all of the operating instructions in this manual and checking the section "Troubleshooting," you find that service is needed;

- Call the TACP toll free number 1-800-631-3811 after you find a defective product or part to find the nearest Toshiba Authorized Service Station.
- Please present your bill of sale or other proof to the Authorized Service Station.





Authorized TACP/THI service station personnel will come to your home when warranty service is required. Depending on the type of repair required, the service will either be performed in your home or the set will be taken to the TACP/THI Authorized service station for repair and returned to your home at no cost to you.

In the Continental U.S.

If your TV requires service, call toll free:
1-800-631-3811



In Hawaii

If your TV requires service, call:
(808) 521-5377
327 Kamakee Street, Honolulu, HI 96814

Limitations

All warranties implied by state law, including the implied warranties of merchantability and fitness for a particular purpose, are expressly limited to the duration of the limited warranties set forth above. With the exception of any warranties implied by state law as hereby limited, the foregoing warranty is exclusive and in lieu of all other warranties, guarantees, agreements and similar obligations of manufacturer or seller with respect to the repair or replacement of any parts. In no event shall TACP or THI be liable for consequential or incidental damages.

No person, agent, distributor, dealer or company is authorized to change, modify or extend the terms of these warranties in any manner whatsoever. The time within which action must be commenced to enforce any obligation of TACP or THI arising under this warranty or under any statute, or law of the United States or any state thereof, is hereby limited to 90 days from the date you discover or should have discovered, the defect. This limitation does not apply to implied warranties arising under state law.

This warranty gives you specific legal rights and you may also have other rights which may vary from state to state. Some states do not allow limitation on how long an implied warranty lasts, when an action may be brought, or the exclusion or limitation of incidental or consequential damages, so the above provisions may not apply to you.

REV. 9-01-98







TOSHIBA AMERICA CONSUMER PRODUCTS, INC.

Head Office

82 Totowa Road, Wayne, NJ 07470

Factory Service Center

1420B Toshiba Drive, Lebanon, TN 37087

TOSHIBA HAWAII, INC

Head Office

327 Kamakee Street, Honolulu, HI 96814

PRINTED IN THAILAND

TOSHIBA

3J70201B 
01/06

23563690



Free Manuals Download Website

<http://myh66.com>

<http://usermanuals.us>

<http://www.somanuals.com>

<http://www.4manuals.cc>

<http://www.manual-lib.com>

<http://www.404manual.com>

<http://www.luxmanual.com>

<http://aubethermostatmanual.com>

Golf course search by state

<http://golfingnear.com>

Email search by domain

<http://emailbydomain.com>

Auto manuals search

<http://auto.somanuals.com>

TV manuals search

<http://tv.somanuals.com>