

# TOSHIBA

# OWNER'S MANUAL

## Color Television

**FST PURE**<sup>®</sup>  
COLORSTREAM<sup>®</sup>

**20AF44**  
**24AF44**

### Owner's Record

The model number and serial number are on the back of your TV. Record these numbers in the spaces below. Refer to these numbers whenever you communicate with your Toshiba dealer about this TV.

Model number:

Serial number:

Important  
Safeguards

Welcome to  
Toshiba

Connecting  
your TV

Using the  
Remote Control

Setting up  
your TV

Using the TV's  
Features

Appendix

## Dear Customer,

Thank you for purchasing this Toshiba TV. This manual will help you use the many exciting features of your new TV. **Before operating the TV, please read this manual completely, and keep it nearby for future reference.**

### Safety Precautions

#### WARNING

**TO REDUCE THE RISK OF FIRE OR ELECTRIC SHOCK, DO NOT EXPOSE THIS APPLIANCE TO RAIN OR MOISTURE.**

	<b>WARNING</b> RISK OF ELECTRIC SHOCK DO NOT OPEN	
<b>WARNING: TO REDUCE THE RISK OF ELECTRIC SHOCK, DO NOT REMOVE COVER (OR BACK). NO USER-SERVICEABLE PARTS INSIDE. REFER SERVICING TO QUALIFIED SERVICE PERSONNEL.</b>		

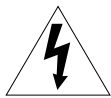

The lightning symbol in the triangle tells you that the voltage inside this product may be strong enough to cause an electric shock. **DO NOT TRY TO SERVICE THIS PRODUCT YOURSELF.**



The exclamation mark in the triangle tells you that important operating and maintenance instructions follow this symbol.

**CAUTION: To reduce the risk of electric shock, do not use the polarized plug with an extension cord, receptacle, or other outlet unless the blades can be inserted completely to prevent blade exposure.**

### NOTE TO CATV INSTALLERS IN THE USA

This is a reminder to call the CATV system installer's attention to Article 820-40 of the NEC, which provides guidelines for proper grounding and, in particular, specifies that the cable ground shall be connected to the grounding system of the building, as close to the point of cable entry as practical. For additional antenna grounding information, see items 25 and 26 on page 4.

### NOTICE OF POSSIBLE ADVERSE EFFECTS ON TV PICTURE TUBE

If a fixed (non-moving) pattern remains on the TV screen for long periods of time, the image can become permanently engrained in the picture tube. **This type of damage is NOT COVERED BY YOUR WARRANTY.** See item 33 on page 4.

## Child Safety



### It Makes A Difference Where Your TV Stands

**Congratulations on your purchase! As you enjoy your new TV, keep these safety tips in mind:**

#### The Issue

- If you are like most consumers, you have a TV in your home. Many homes, in fact, have more than one TV.
- The home theater entertainment experience is a growing trend, and larger TVs are popular purchases; however, they are not always supported on the proper TV stands.
- Sometimes TVs are improperly secured or inappropriately situated on dressers, bookcases, shelves, desks, audio speakers, chests, or carts. As a result, TVs may fall over, causing unnecessary injury.

#### Toshiba Cares!

- The consumer electronics industry is committed to making home entertainment enjoyable and safe.
- The Consumer Electronics Association formed the Home Entertainment Support Safety Committee, comprised of TV and consumer electronics furniture manufacturers, to advocate children's safety and educate consumers and their families about television safety.

#### Tune Into Safety

- One size does NOT fit all! Use appropriate furniture large enough to support the weight of your TV (and other electronic components).
- Use appropriate angle braces, straps, and anchors to secure your furniture to the wall (but never screw anything directly into the TV).
- Carefully read and understand the other enclosed instructions for proper use of this product.
- Do not allow children to climb on or play with furniture and TVs.
- Avoid placing any item on top of your TV (such as a VCR, remote control, or toy) that a curious child may reach for.
- Remember that children can become excited while watching a program and can potentially push or pull a TV over.
- Share our safety message about this hidden hazard of the home with your family and friends. Thank you!



2500 Wilson Blvd.  
Arlington, VA 22201 U.S.A.  
Tel. 703-907-7600 Fax 703-907-7690  
www.CE.org

*CEA is the Sponsor, Producer and Manager of the International CES®*

# Important Safety Instructions

- 1) **Read these instructions.**
- 2) **Keep these instructions.**
- 3) **Heed all warnings.**
- 4) **Follow all instructions.**



- 5) **Do not use this apparatus near water.**



- 6) **Clean only with a dry cloth.**

- 7) **Do not block any ventilation openings.** Install in accordance with the manufacturer's instructions.



- 8) **Do not install near any heat sources** such as radiators, heat registers, stoves, or other apparatus (including amplifiers) that produce heat.

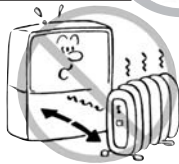

- 9) **Do not defeat the safety purpose of the polarized or grounding type plug.** A polarized plug has two blades with one wider than the other. A grounding type plug has two blades and a third grounding prong. The wide blade or the third prong are provided for your safety. If the provided plug does not fit into your outlet, consult an electrician for replacement of the obsolete outlet.

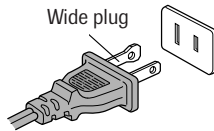

- 10) **Protect the power cord** from being walked on or pinched, particularly at plugs, convenience receptacles, and the point where it exits the apparatus.

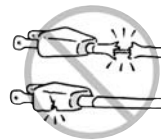

- 11) **Only use attachments/accessories specified by the manufacturer.**

- 12) **Use only with the cart, stand, tripod, bracket, or table specified by the manufacturer, or sold with the apparatus.** When a cart is used, use caution when moving the cart/apparatus combination to avoid injury from tip-over.



- 13) **Unplug this apparatus during lightning storms or when unused for long periods of time.**

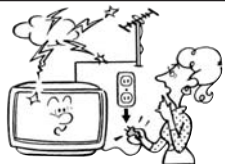

- 14) **Refer all servicing to qualified service personnel.**

Service is required when the apparatus has been damaged in any way, such as power supply cord or plug is damaged, liquid has been spilled or objects have fallen into the apparatus, the apparatus has been exposed to rain or moisture, does not operate normally, or has been dropped.



- 15) **CAUTION:** To reduce the risk of electric shock, do not use the polarized plug with an extension cord, receptacle, or other outlet unless the blades can be inserted completely to prevent blade exposure.

# Installation, Care, and Service

## Installation

Follow these recommendations and precautions and heed all warnings when installing your TV:

- 16) Never modify this equipment. Changes or modifications may void: a) the warranty, and b) the user's authority to operate this equipment under the rules of the Federal Communications Commission.

- 17) **! DANGER: RISK OF SERIOUS PERSONAL INJURY, DEATH, OR EQUIPMENT DAMAGE!** Never place the TV on an unstable cart, stand, or table. The TV may fall, causing serious personal injury, death, or serious damage to the TV.



- 18) Never place or store the TV in direct sunlight; hot, humid areas; areas subject to excessive dust or vibration; or locations with temperatures at or below 41°F (5°C).



- 19) Always place the TV on the floor or a sturdy, level, stable surface that can support the weight of the unit.



- 20) Never place items such as vases, aquariums, or candles on top of the TV.



- 21) Never block or cover the slots or openings in the TV cabinet back, bottom, and sides. Never place the TV:

- on a bed, sofa, rug, or similar surface;
- too close to drapes, curtains, or walls; or
- in a confined space such as a bookcase, built-in cabinet, or any other place with poor ventilation.



The slots and openings are provided to protect the TV from overheating and to help maintain reliable operation of the TV.



- 22) Never allow anything to rest on or roll over the power cord, and never place the TV where the power cord is subject to wear or abuse.

- 23) Never overload wall outlets and extension cords.



- 24) Always operate this equipment from a 120V AC, 60 Hz power source only.

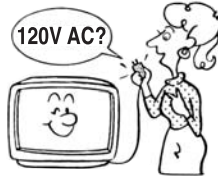

- 25) Always make sure the antenna system is properly grounded to provide adequate protection against voltage surges and built-up static charges (see Section 810 of the National Electric Code).

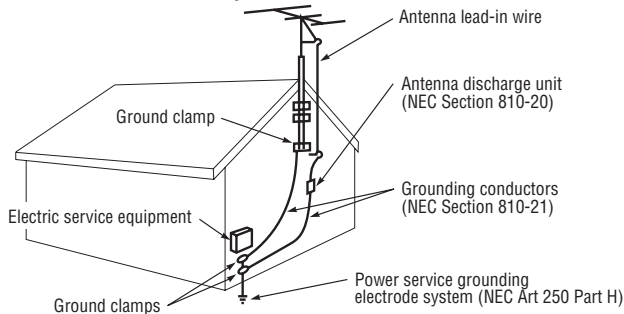

- 26) **⚠ DANGER: RISK OF SERIOUS PERSONAL INJURY OR DEATH!**
- Use extreme care to make sure you are never in a position where your body (or any item you are in contact with, such as a ladder or screwdriver) can accidentally touch overhead power lines. Never locate the antenna near overhead power lines or other electrical circuits.
  - Never attempt to install any of the following during lightning activity:
    - a) an antenna system; or
    - b) cables, wires, or any home theater component connected to an antenna or phone system.

## Care

For better performance and safer operation of your TOSHIBA TV, follow these recommendations and precautions:

- 27) Always sit approximately 10–25 feet away from the TV and as directly in front of it as possible. The picture can appear dull if you sit too far to the left or right of the TV, or if sunlight or room lights reflect on the screen. Turn the TV off to check for reflections on the screen, and then remove the source of reflections while viewing the TV.

- 28) Always unplug the TV before cleaning. Never use liquid or aerosol cleaners.

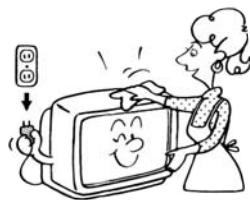

- 29) **⚠ WARNING: RISK OF ELECTRIC SHOCK!** Never spill liquids or push objects of any kind into the TV cabinet slots.

- 30) [*This item applies to projection TVs only.*] If the air temperature rises suddenly (for example, when the TV is first delivered), condensation may form on the lenses. This can make the picture appear distorted or the color appear faded. If this happens, turn off the TV for 6 to 7 hours to allow the condensation to evaporate.

- 31) For added protection of your TV from lightning and power surges, always unplug the power cord and disconnect the antenna from the TV if you leave the TV unattended or unused for long periods of time.

- 32) During normal use, the TV may make occasional snapping or popping sounds. This is normal, especially when the unit is being turned on or off. If these sounds become frequent or continuous, unplug the power cord and contact a Toshiba Authorized Service Center.



- 33) **Possible Adverse Effects on TV Picture Tube:** If a fixed (non-moving) pattern remains on the TV screen for long periods of time, the image can become permanently engrained in the picture tube and cause subtle but permanent ghost images. **This type of damage is NOT COVERED BY YOUR WARRANTY.** Never leave your TV on for long periods of time while it is displaying the following formats or images:

- **Fixed Images**, such as PIP/POP windows, stock tickers, video game patterns, TV station logos, and websites.
- **Special Formats** that do not use the entire screen. For example, viewing letterbox style (16:9) media on a normal (4:3) display (gray bars at top and bottom of screen); or viewing normal style (4:3) media on a widescreen (16:9) display (gray bars on left and right sides of screen).

## Service

- 34) **⚠ WARNING: RISK OF ELECTRIC SHOCK!** Never attempt to service the TV yourself. Opening and removing the covers may expose you to dangerous voltage or other hazards. Refer all servicing to a Toshiba Authorized Service Center.

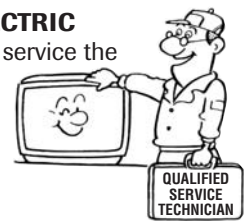

- 35) If you have the TV serviced:

- Ask the service technician to use only replacement parts specified by the manufacturer.
- Upon completion of service, ask the service technician to perform routine safety checks to determine that the TV is in safe operating condition.



- 36) When the TV reaches the end of its useful life, ask a qualified service technician to properly dispose of the TV. Improper disposal may result in a picture tube implosion and possible personal injury.

<b>Important Safety Information .....</b>	<b>2-4</b>
<b>Welcome to Toshiba.....</b>	<b>6</b>
Exploring your new TV .....	6
Selecting a location for the TV .....	6
<b>Connecting your TV .....</b>	<b>7</b>
Connecting a VCR .....	7
Connecting a cable converter box .....	8
Connecting a DVD player/satellite receiver and a VCR .....	9
Connecting a DVD player with ColorStream® (component video) and a VCR .....	9
Connecting two VCRs .....	10
Connecting a camcorder .....	10
Connecting an audio amplifier .....	10
<b>Using the remote control.....</b>	<b>11</b>
Preparing the remote control for use .....	11
Installing the remote control batteries .....	11
Using the remote control with a VCR, DVD player or cable TV converter .....	11
Programming the remote control for use with a VCR, DVD player, or cable TV converter .....	12
VCR, DVD player, and cable TV converter codes .....	13
Learning about the remote control .....	14
<b>Setting up your TV .....</b>	<b>15</b>
Changing the on-screen display language .....	15
Adding channels to the TV's memory .....	16
Programming channels automatically .....	16
Adding and erasing channels manually .....	16
Changing channels .....	16
<b>Using the TV's features .....</b>	<b>17</b>
Adjusting the channel settings .....	17
Switching between two channels .....	17
Programming your favorite channels .....	17
Using the V-Chip (parental control) feature (U.S. V-Chip system only) .....	18
Selecting a PIN code .....	18
Blocking programs by ratings .....	19
Blocking unrated movies or programs .....	22
Using the LOCK menu .....	22
Locking channels .....	22
Locking video input .....	23
Setting the game timer .....	23
Labeling channels .....	24
Setting the clock .....	25
Setting the ON/OFF timer .....	25
Setting the on timer .....	25
Setting the off timer .....	26
Adjusting the picture quality .....	27
Watching video input .....	27
Selecting the ColorStream® mode .....	27
Displaying on-screen information .....	27
Setting the sleep timer .....	28
Using the closed caption feature .....	28
Changing the picture size .....	28
Adjusting the sound .....	29
Muting the sound .....	29
Selecting stereo/SAP broadcasts .....	29
Adjusting the sound quality .....	30
Using the BBE sound feature .....	30
Using the surround sound feature .....	31
Using the StableSound® feature .....	31
Auto power off .....	31
Understanding the Power Return feature .....	31
<b>Appendix .....</b>	<b>32</b>
Troubleshooting .....	32
Specifications .....	33
Limited United States Warranty .....	34
Limited Canada Warranty .....	35

## Welcome to Toshiba

Congratulations! You have purchased one of the finest color TVs on the market. The goal of this manual is to guide you through setting up and operating your Toshiba TV as quickly as possible.

You may need to purchase other audio or video cables to connect your equipment. See "Connecting your TV" on page 7 for more information.

Please read all the safety and operating instructions carefully before you begin.

## Exploring your new TV

You can operate your TV by using the buttons on the front panel or the remote control. The front and back panels provide all the inputs you will need to connect other equipment to your TV.

### 20AF44

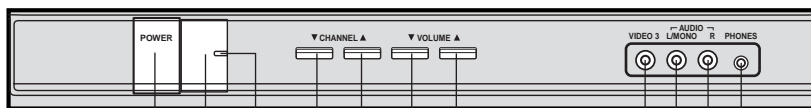

Remote sensor  
Channel  
Volume  
Audio(L/R)/Video In  
Phones

### 24AF44

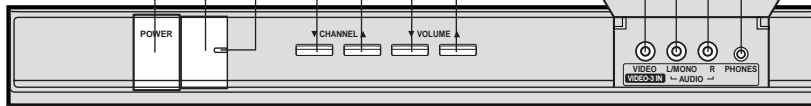

TV front panel

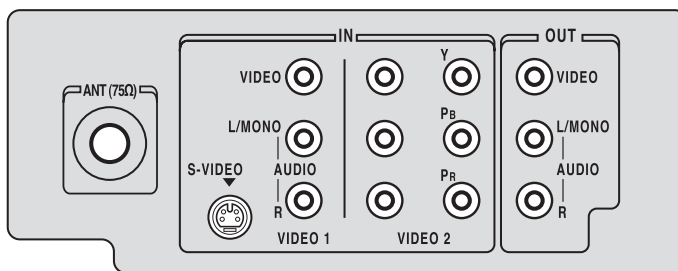
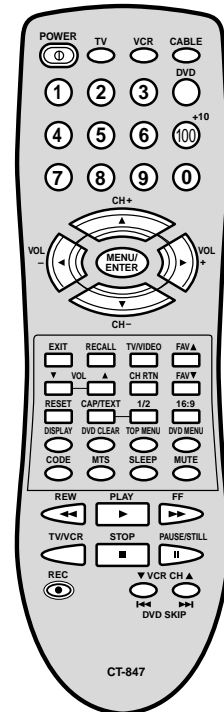

TV back panel

## Selecting a location for the TV

- Place the TV on the floor or on a sturdy platform in a location where light does not directly hit the screen.
- Place the TV far enough from the walls to allow proper ventilation. Inadequate ventilation may cause overheating, which may damage the TV.

## Connecting your TV

If you haven't connected electronic equipment before, or you have been frustrated in the past, you may wish to read this section. (Cables are not supplied.)

- A coaxial cable is the standard cable that comes in from your antenna or cable converter box. Coaxial cables use "F" connectors.
- Standard A/V (audio/video) cables are usually color coded according to use: yellow for video and red and white for audio. The red audio cable is for the stereo right channel, and the white audio cable is for the stereo left (or mono) channel. If you look at the rear panel of the TV, you will see that the terminals are color coded in the same manner as the cables.
- S-video cables provide better picture performance. S-video cables can only be used with S-video compatible components.
- Component video cables come in sets of three and provide the best picture performance. Component video cables can only be used with component video compatible components.

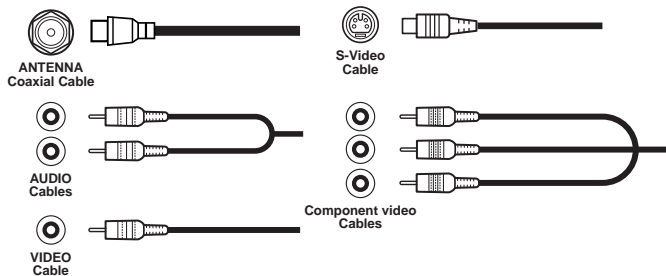

### Caution:

Do not plug the TV in until you have finished connecting all of your equipment.

## Connecting a VCR

This connection allows you to watch local channels and video programs, play or record on the VCR while watching TV, and record from one channel while watching another channel.

You will need:

- two coaxial cables
- one set of standard A/V cables

### Note:

If using a mono VCR, connect L/Mono to VCR Audio OUT using only one audio cable. For better picture quality, if your VCR has S-video, you can use an S-video cable instead of the standard video cable. Do not connect a standard video cable and an S-video cable to VIDEO1 simultaneously.

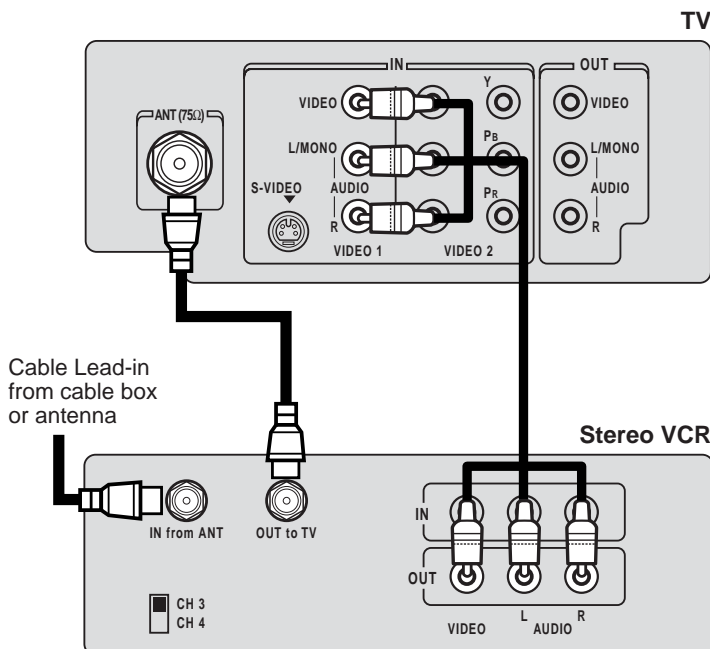

## Connecting a cable converter box

This television has an extended tuning range and can tune most cable channels without using a cable company supplied converter box. Some cable companies offer "premium pay channels" in which the signal is scrambled. Descrambling these signals for normal viewing requires the use of a descrambler device, which is generally provided by the cable company.

### For Subscribers to Basic Cable TV Service

For basic cable service not requiring a Converter/Descrambler box, connect the CATV 75 ohm Coaxial Cable directly to the Antenna Jack on the back of the television.

### For Subscribers to Scrambled Cable TV Service

If you subscribe to a cable service that requires the use of a Converter/Descrambler box, connect the incoming cable to the Converter/Descrambler box and connect the output of the box to the Antenna Jack on the back of the television. Follow the connections shown below. Set the television to the output of the Converter/Descrambler box (usually channel 3 or 4) and use the Converter/Descrambler box to select channels.

### For Subscribers to Unscrambled Basic Cable with Scrambled Premium Channels

If you subscribe to a cable service in which basic cable channels are unscrambled and premium channels require the use of a Converter/Descrambler box, you may wish to use a two-set signal splitter (sometimes called a "two-set coupler") and an A/B Switch box from the cable installer or an electronics supply store. Follow the connections shown below. With the switch in the "B" position, you can directly tune any unscrambled channels on your TV. With the switch in the "A" position, tune your TV to the output of the Converter/Descrambler box (usually channel 3 or 4) and use the box to tune scrambled channels.

#### Note:

*When you use a converter box with your TV, there may be features that you cannot program using the remote control, such as labeling channels, blocking channels, and programming your favorite channels.*

#### Incoming CATV

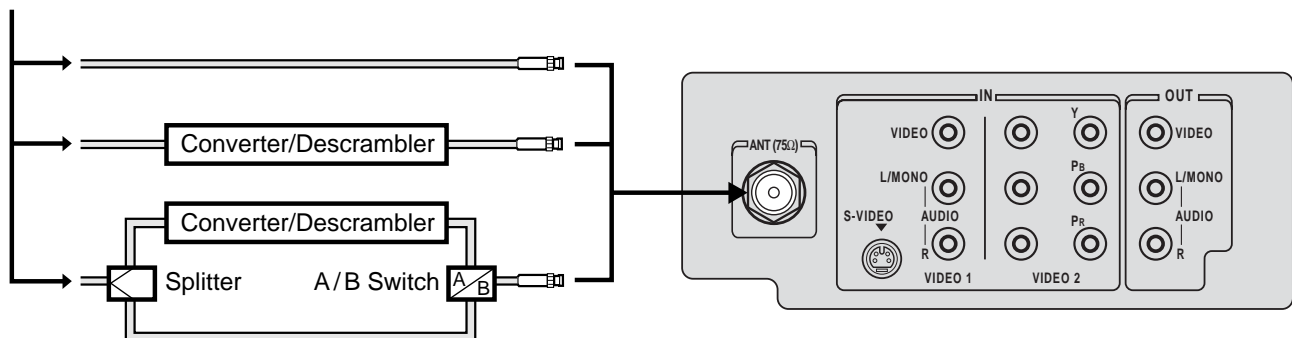



## Connecting a DVD player/satellite receiver and a VCR

This connection allows you to watch DVD/satellite, VCR, or TV programs. You can record from the satellite receiver and TV, as well as record one TV channel while watching another channel.

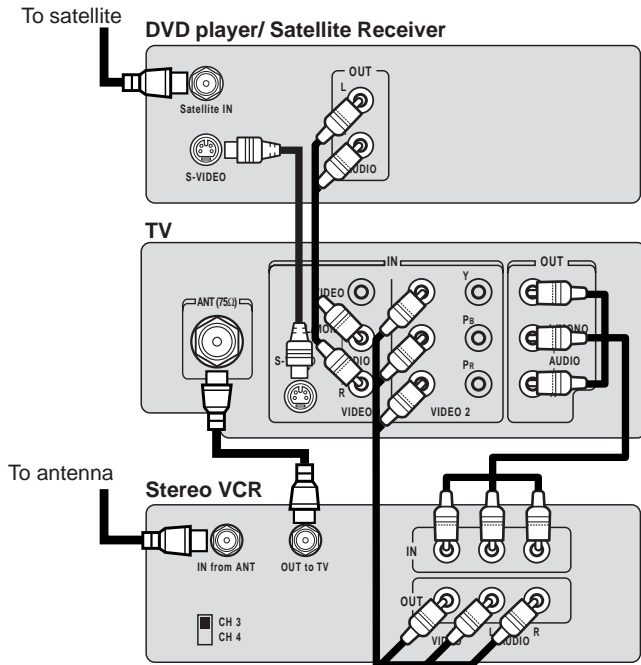

You will need:

- three coaxial cables
- two sets of standard A/V cables
- one S-video cable
- one pair of standard audio cables

### Note:

You can use a standard video cable instead of the S-video cable, but the picture quality will decrease. If you use an S-video cable between the TV and DVD player/satellite receiver, make the audio connections only and remove the standard video cable.

## Connecting a DVD player with ColorStream® (component video) and a VCR

This connection allows you to watch DVD, VCR, or TV programs and record TV programs. You can record from one source while watching a program from another source. Your TV is capable of using ColorStream (component video). Connecting your TV to a component video compatible DVD player, such as a Toshiba DVD player with ColorStream®, can greatly enhance picture quality and performance.

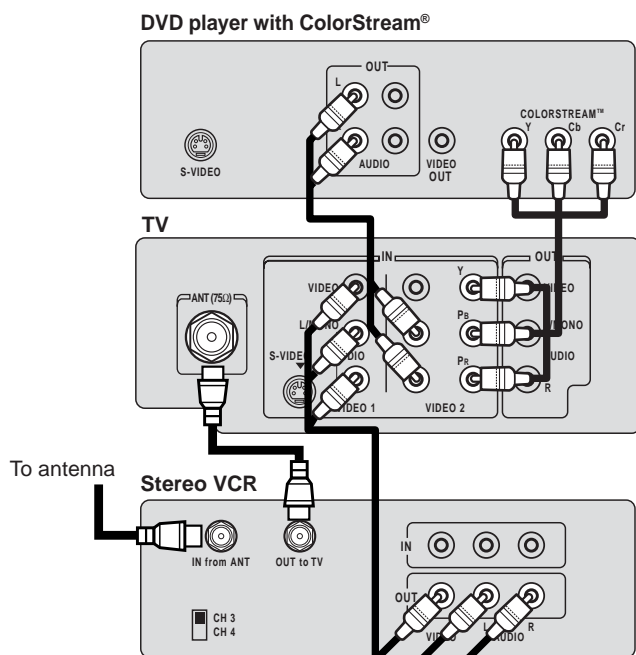

You will need:

- two coaxial cables
- one set of standard A/V cables
- one set of component video cables
- one pair of standard audio cables

### Note:

The ColorStream inputs on this TV are for use with devices that output 480i interlaced signals ONLY. This TV will not accept or display 480p or 720p progressive scan signals or 1080i interlaced high-definition signals. If you connect a high-definition set-top receiver, 480p progressive scan DVD player, or other similar device to the TV's ColorStream inputs, YOU MUST SWITCH THE DEVICE'S OUTPUT TO 480i INTERLACED MODE FIRST. Failure to do this will cause a poor picture or no picture to display.

The unauthorized recording, use, distribution or revision of television programs, videotapes, DVDs, and other materials is prohibited under the Copyright Laws of the United States and other countries, and may subject you to civil and criminal liability.

## Connecting two VCRs

This connection allows you to record (dub/edit) from one VCR to another VCR.

You will also be able to record from one TV channel while watching another channel.

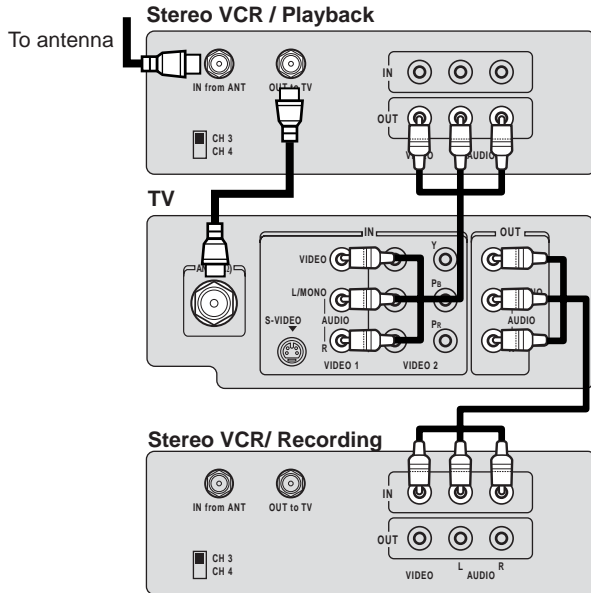

You will need:

- two coaxial cables
- two sets of standard A/V cables

### Note:

Do not connect the same VCR to the output and input jacks on the TV at the same time. For better picture quality, if your VCR has S-video, you can use an S-video cable instead of the standard video cable. Do not connect a standard video cable and an S-video cable to VIDEO1 simultaneously.

## Connecting a camcorder

This connection allows you to watch video materials recorded on a camcorder.

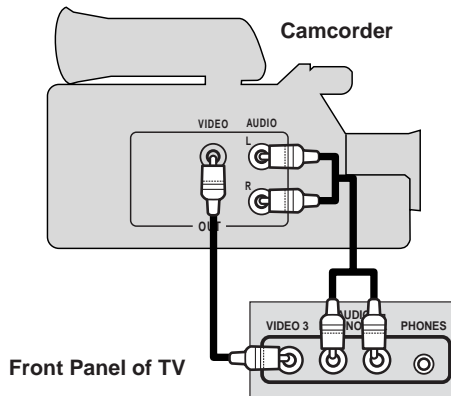

You will need:

- one set of standard A/V cables

### Note:

For better picture quality, if your camcorder has S-video, you can connect an S-video (and standard audio cables) to VIDEO1 on the back of the TV. Do not connect a standard video cable and an S-video cable to VIDEO1 simultaneously.

## Connecting an audio amplifier

This connection allows you to use an audio amplifier to enjoy a high-quality sound. This also allows you to use external speakers. To control the audio, turn on the TV and the stereo amplifier.

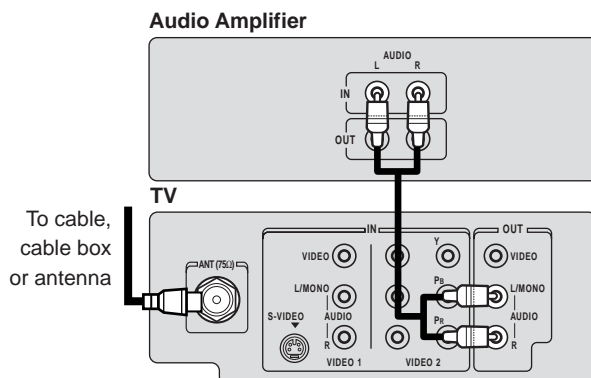

You will need:

- one coaxial cable
- one pair of audio cables

The unauthorized recording, use, distribution or revision of television programs, videotapes, DVDs, and other materials is prohibited under the Copyright Laws of the United States and other countries, and may subject you to civil and criminal liability.

# Using the remote control

## Preparing the remote control for use

With the remote control, you can operate your TV, most VCR and DVD player models, and cable TV converters together, even if they are different brands. If you will be using your TV with a Toshiba VCR or DVD player, your remote control is already programmed and ready to use. If you own different brands of VCRs, DVD players and/or converters, you first have to program your remote control. (See "Programming the remote control for use with a VCR, DVD player, or cable TV converter" on page 12.)

## Installing the remote control batteries

### To install the batteries:

1. Open the battery cover on the back of the remote control.

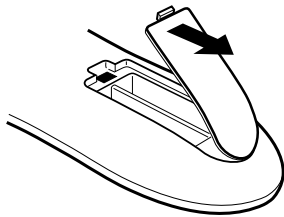

2. Install two "AAA" size batteries. Match the + and - signs on the batteries to the signs on the battery compartment.

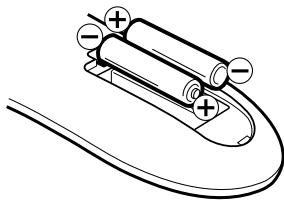

3. Close the battery cover on the remote control until the lock snaps.

### Note:

The TV remote control may or may not operate your VCR, DVD player, or cable TV converter. Refer to the owner's manuals supplied with the equipment to see which features are available. In addition, the original controllers may have features not available on this remote control. If you would like to continue to use these features, you may want to use the original remote control.

### Cautions:

- Dispose of batteries in a designated disposal area. Do not throw batteries into a fire.
- Do not mix battery types or combine used batteries with new ones.
- Remove dead batteries immediately to prevent battery acid from leaking into the battery compartment.
- If you do not intend to use the remote control for a long time, remove the batteries.

## Using the remote control with a VCR, DVD player, or cable TV converter

### To control a VCR:

Program the remote control to recognize the brand of your VCR (see "Programming the remote control for use with a VCR, DVD player, or cable TV converter" on page 12). The buttons shown at right will then control the VCR. Press the VCR button first.

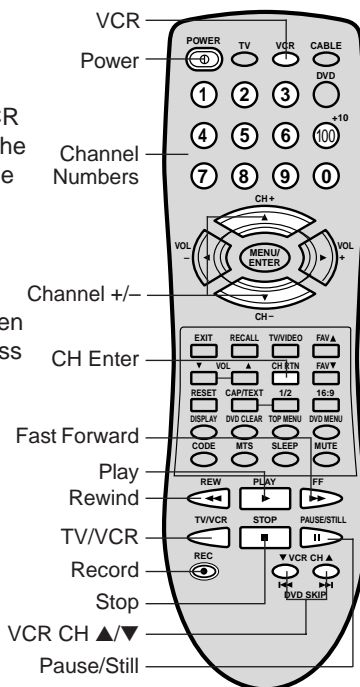

### To control a DVD player:

Program the remote control to recognize the brand of your DVD player (see "Programming the remote control for use with a VCR, DVD player, or cable TV converter" on page 12). The buttons shown at right will then control the DVD player. Press the DVD button first.

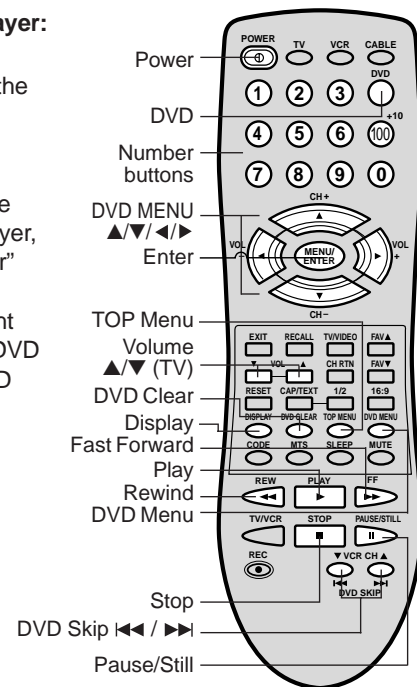

**To control a cable TV converter:**

Program the remote control to recognize the brand of your converter (see "Programming the remote control for use with a VCR, DVD player, or cable TV converter" below). The buttons shown at right will control the cable TV converter. Press the CABLE button first.

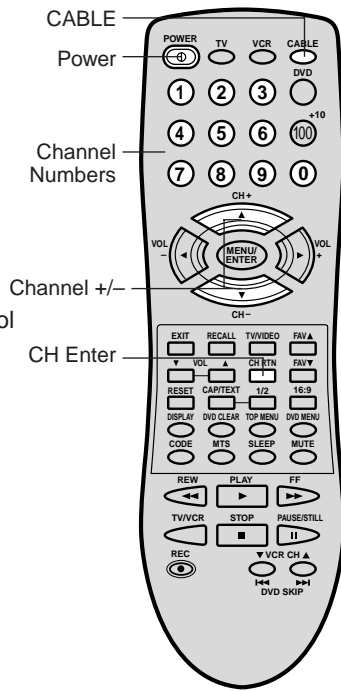

**Programming the remote control for use with a VCR, DVD player, or cable TV converter**

This remote control is pre-programmed to operate Toshiba VCRs and DVD players. To control VCRs, DVD players, or cable converters other than Toshiba models, you must follow the steps below to program your remote control.

1. While holding down the CODE button, press the button for the device you want to control (VCR, DVD, or CABLE).
2. Enter the 2-digit code listed on page 13 using the Number buttons (0–9) within 10 seconds.
3. Point the remote control at the VCR, DVD player, or converter and press POWER to test the code.

If the VCR, DVD player, or converter turns on, you have entered the right code.

If the VCR, DVD player, or converter does not respond to the remote control, you may have entered the wrong code. Repeat steps 1–2 with another code.

For future reference, write down the codes you used:

VCR code \_\_\_\_\_

DVD player code \_\_\_\_\_

Cable TV converter code \_\_\_\_\_

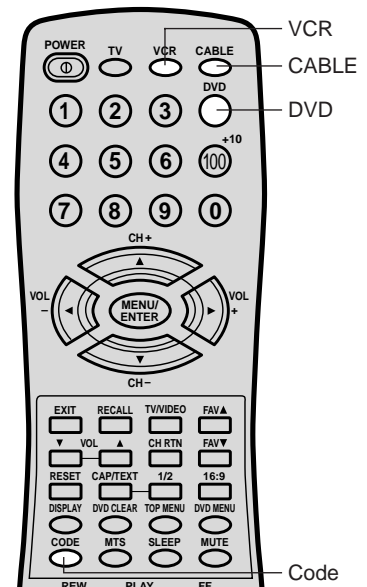

**Notes:**

- When shipped from the factory, the remote control is set to operate your TV.
- If you do not enter the code within 10 seconds from step 1 or if you enter a code not listed below, this operation is canceled.
- Each time you replace the batteries, you must reprogram the remote control.
- Some newer VCRs are capable of working on either of two remote codes. These VCRs have a switch labeled "VCR1/VCR2." If your VCR has this kind of switch and does not respond to any of the codes for your VCR, set the switch to the other position (VCR1 or VCR2) and reprogram the remote control.

Using the Remote Control

## VCR, DVD player, and cable TV converter codes

VCR			
Admiral	08, 61	Multi Tech	39
Adventura	31	NEC	02, 18
Aiwa	31	Orion	33, 50
Akai	23, 38, 41	Panasonic	14, 51, 59
Audio Dynamics	02, 18	Pentax	15
Bell & Howell	06, 47	Philco	07, 14
Broksonic	21, 26, 33, 50, 55	Philips	07, 14, 27
Canon	14	Pioneer	10, 15
Citizen	09	Portland	46
Craig	12	Pro Scan	16, 60
Curtis Mathes	14, 59	Quasar	14, 59
Daewoo	44, 46, 48, 54	RCA	15, 16, 20, 27, 40, 42, 60
Daytron	36, 46	Realistic	06, 08, 12, 14, 31
DBX	02, 18	Samsung	20, 30
Emerson	03, 21, 23, 26, 33, 35, 43, 50	Sansui	39
Fisher	11, 12, 13, 47	Sanyo	06, 12, 47
Funai	31	Scott	04, 05, 33, 43
General Electric	14, 16, 20	Sears	06, 09, 11, 12, 15
Goldstar	09	Sharp	08, 61
Go Video	56, 62, 63	Shintom	39
Hitachi	15, 57	Signature 2000	08, 14, 16, 19, 31, 49
Instant Replay	14, 27	Sony	17, 32, 37
J.C. Penney	14, 15, 18, 27	Sylvania	07, 14, 27
JVC	02, 25, 58	Symphonic	31
Kenwood	02	Tashiko	09
Logik	39	Tatung	02
LXI	09, 31	Teac	02, 31
Magnavox	07, 14, 31	Teknika	34
Marantz	07, 18	Toshiba	05, 15
Marta	09	XR1000	39
Memorex	06, 12, 14, 31, 33	Vector Research	04, 18
Mitsubishi	04, 22, 52, 64	Yamaha	02, 18
Montgomery Ward	08, 14, 16, 19, 31, 49	Zenith	01, 24, 25, 29, 37

DVD PLAYER			
Aiwa	23	RCA	01,06
Apex	20	Saba	01
Denon	00, 17	Sampo	14
Ferguson	01	Samsung	10
Hitachi	11	Sharp	08
JVC	09	Silvania	32, 18
Kenwood	15, 29	SMC	25
Konka	19	Sony	04, 26, 27, 28
Mitsubishi	05	Technics	00
Nordmende	01	Thomson	01
Onkyo	21	Toshiba	03
Oritron	24	Wave	22
Panasonic	00	Yamaha	00, 30
Philips	03, 16	Zenith	07, 12
Pioneer	02	Vialta	31
Raite	13	Funai	32, 18

CABLE TV CONVERTER			
Allegro	58, 62	RCA DSS	73
Allegro A/B Switch	61	Regency	29
Gemini	05, 31, 38	Samsung	35
General Electric	67	Scientific Atlanta	16, 23, 36, 64
General Instrument	05, 06	Sprucer	13
Hamlin	02, 03, 45, 65, 66	Standard Comp	35
Jerrold	04, 07, 08, 09, 10, 18, 60, 63	Texscan	39, 56, 71
Kale Vision	35	Tocom	17, 18, 46
Macom	14, 21	Unika	48, 62
Magnavox	34	United Satellite	44
NSC	35, 39, 68, 69, 70	Universal	58, 62
Oak	11, 32, 42	Vid Tech	40
Panasonic	13, 20	Video Way	49
Paragon	33	Viewstar	54, 55, 72
Philips	47, 50, 52, 54, 55	Zenith	01, 53, 74
Pioneer	15, 43	Zenith Satellite	12, 28, 30, 51

## Learning about the remote control

**POWER** turns the TV on and off

**Sleep** programs the TV to turn off at a set time (page 28)

**TV/Video** selects the video input source (page 27)

**Channel + / -** cycles through programmed channels (page 16) TV/VCR/DVD/CABLE

**TV/VCR/DVD/Cable** select TV, VCR, DVD, or CABLE mode (page 11)

**Channel Numbers** allow direct access to channels (page 16)

**Volume + / -** adjusts the volume level

**Channel Return** returns to the last viewed channel (page 17)

**Menu/Enter** allows access to programming menus, and sets programmed menu information (page 15)

**Favorite Channels ▲▼** cycle through favorite channels (page 17)

**Reset** returns settings to preset factory formats (pages 27 and 30)

**CAP/TEXT** turns closed captions or text on and off (page 28)

**1/2** selects closed caption/text channel 1 or 2 (page 28)

**Mute** turns off the sound (page 29)

**MTS** switches among STEREO, SAP, and MONO sound (page 29)

**Recall** displays status information on-screen (page 27)

**CODE** is used to program the remote control (page 12)

**Exit** exits programming menus (page 15)

**16:9** toggles the aspect ratio between 4:3 (letterbox) and 16:9 (wide screen) modes (page 28)

**Stop** stops a videotape/DVD

**Rec** starts recording a videotape

**Play** plays a videotape/DVD

**FF** fast forwards a videotape/DVD

**Rew** rewinds a videotape/DVD

**Pause/Still** pauses a videotape/DVD

**TV/VCR** toggles between TV and VCR modes when viewing while recording

**VCR Channel ▲▼** cycles through programmed channels of VCR

**DVD Skip** ◀◀ ▶▶ skips chapter of DVD

**Display** displays status information on-screen in the DVD

**Volume ▲▼** adjusts the volume level of DVD playback

**DVD Clear** clears input data in the setting mode of DVD

**TOP Menu** allows access to TOP menu of DVD

**DVD Menu** allows access to DVD menu of DVD

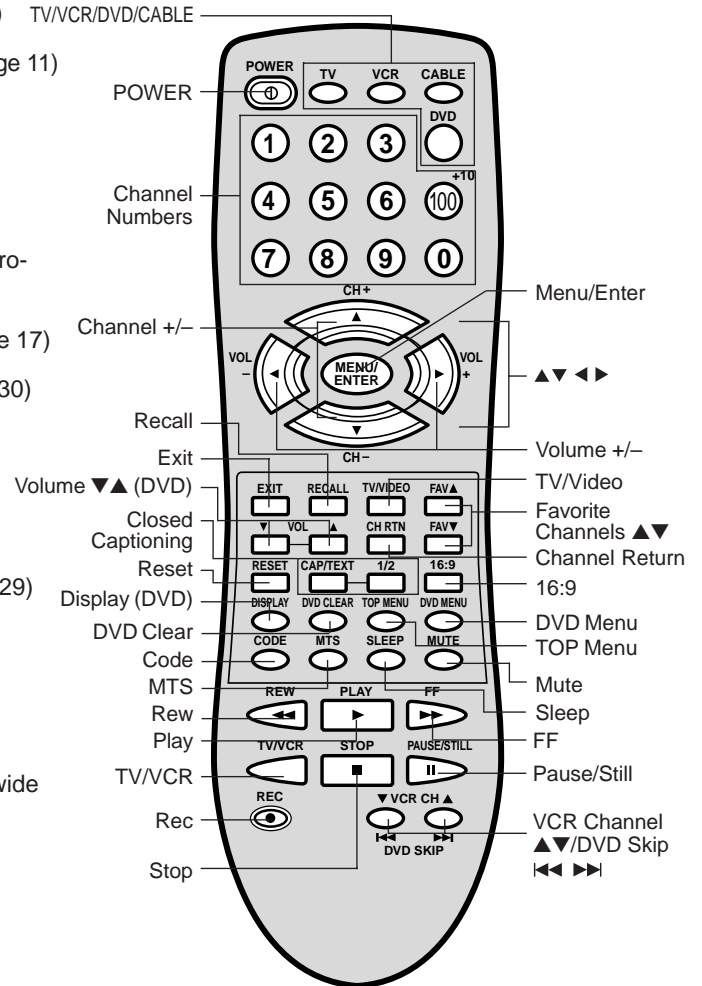

## Setting up your TV

After you have installed the batteries and programmed the remote control, you need to set some preferences on the TV using the menu system. You can access the menu system with the buttons on the remote control.

- When you make a menu selection, your changes occur immediately. You do not have to press MENU or EXIT to see your changes.
- After five seconds, the menu screen will automatically close if you do not make a selection. Your changes will still be saved.
- When you are finished programming the menus, press EXIT.

### Changing the on-screen display language

You can choose from three different languages (English, French and Spanish) for the on-screen displays. Adjustment menus and messages will appear in the language of your choice.

#### To select a language:

1. Press MENU, then press ◀ or ▶ until the OPTION menu appears.

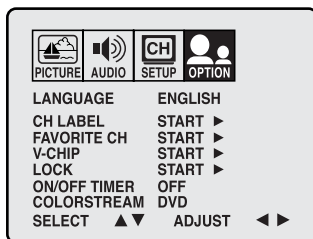

2. Press ▲ or ▼ to highlight LANGUAGE.

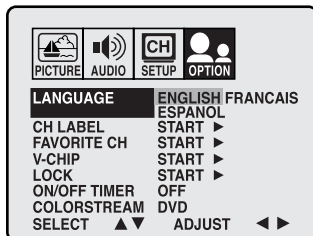

3. Press ◀ or ▶ to highlight your desired language.

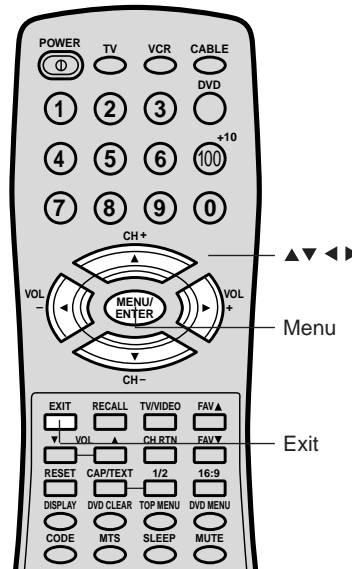

## Adding channels to the TV's memory

Your TV will stop on specific channels that are stored in the TV's channel memory when you press Channel + or -. Use the steps below to set all active channels in your area automatically.

### Programming channels automatically

Your TV can automatically detect all active channels and store them in its memory. After the TV has stored the channels in its memory automatically, you can add or erase channels manually.

#### To add channels automatically:

1. Press MENU, then press ◀ or ▶ to display the SETUP menu.
2. Press ▲ or ▼ until the TV/CABLE selection is highlighted.
3. Press ◀ or ▶ to highlight either TV or CABLE, depending on which you use.

If you use an antenna, choose TV.  
If you use cable, choose CABLE.

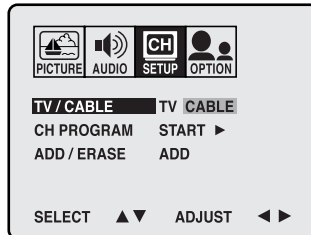

4. Press ▼ to select CH PROGRAM.
5. Press ◀ or ▶ to start channel programming. The TV will automatically cycle through all the TV or Cable channels (depending on which you selected), and store all active channels in the channel memory.  
While the TV is cycling through the channels, the message "PROGRAMMING NOW-PLEASE WAIT" appears.
6. When channel programming is complete, the message "COMPLETED" appears.
7. Press CH + or - to view the programmed channels.

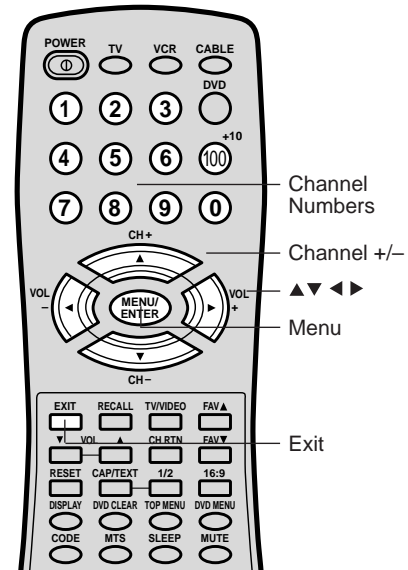

### Adding and erasing channels manually

After you have programmed the channels automatically, you can add or erase specific channels manually.

#### To add or erase channels manually:

1. Select the channel you want to add or erase.  
If adding channels, you must select the channel to add using the Channel Number buttons.
2. Press MENU, then press ◀ or ▶ to display the SETUP menu.
3. Press ▲ or ▼ to highlight ADD/ERASE.
4. Press ◀ or ▶ to select ADD or ERASE, whichever function you want to perform.
5. Repeat steps 1~4 for other channels you want to add or erase.

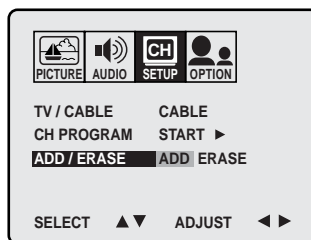

### Changing channels

To change to the next programmed channel:

Press Channel ▼ or ▲ on the TV or CH + or - on the remote control.

To change to a specific channel (programmed or unprogrammed):

Press the Channel Number buttons (0-9 and 100) on the remote control.

For example, to select channel 125, press 100, 2, 5.



## Using the TV's features

### Adjusting the channel settings

#### Switching between two channels

You can switch between two channels without entering an actual channel number each time.

##### To switch between two channels:

1. Select the first channel you want to view.
2. Select a second channel using the Channel Number buttons (0–9, 100).
3. Press CH RTN. The previous channel will be displayed.

Each time you press CH RTN, the TV will switch back and forth between the two channels.

#### Programming your favorite channels

You can preset up to 12 of your favorite channels using the Favorite Channel Programming feature. Because this feature scans through only your favorite channels, it allows you to skip other channels you do not normally watch.

You can still use Channel + / – to scan through all the channels you programmed in the TV's memory.

##### To program your favorite channels:

1. Select a channel you want to program.
2. Press MENU, then press ◀ or ▶ to display the OPTION menu.
3. Press ▲ or ▼ to highlight FAVORITE CH.

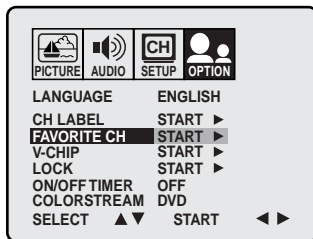

4. Press ◀ or ▶ to display the FAVORITE CH menu. SET/CLEAR will be highlighted.

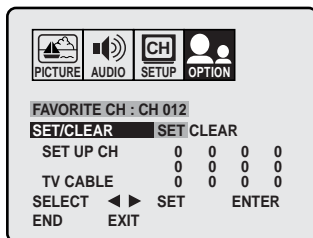

5. Press ◀ or ▶ to highlight SET and press ENTER.
6. Press EXIT to close the screen.
7. Repeat steps 1–6 for up to 11 other channels.

##### To select your favorite channels:

Press the FAV ▲ ▼ buttons on the remote control to select your favorite channels.

The FAV ▲ ▼ buttons will not work until you have programmed your favorite channels.

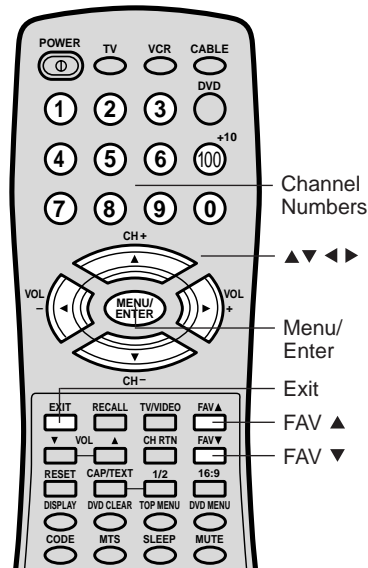
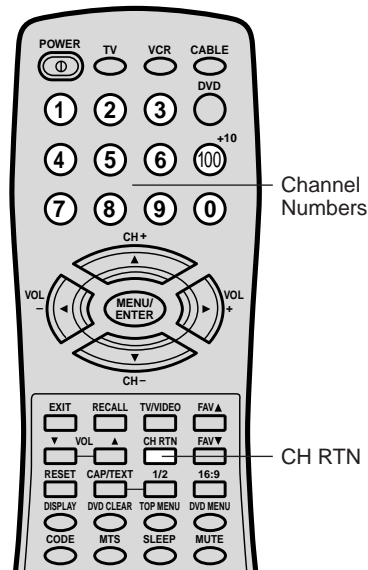

### To clear your favorite channels:

1. Select a channel you want to clear.
2. Press MENU, then press ◀ or ▶ to display the OPTION menu.
3. Press ▲ or ▼ to highlight FAVORITE CH.
4. Press ◀ or ▶ to display the FAVORITE CH menu. SET/CLEAR will be highlighted.

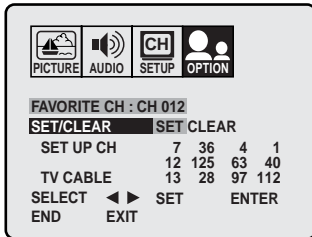

5. Press ◀ or ▶ to highlight CLEAR.

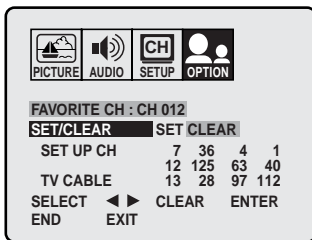

6. Press ENTER until "0" replaces the channel number you want to erase.
7. Press EXIT to clear the screen.
8. Repeat steps 1~6 for the other channels.

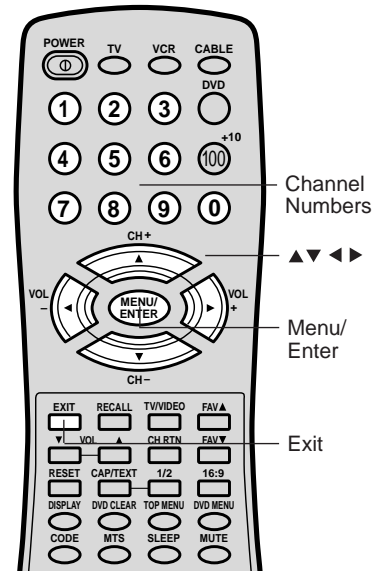

### Using the V-Chip (parental control) feature

The V-Chip feature is available only for the U.S. V-Chip system. The Canadian V-Chip system is not supported.

You can prevent others from viewing certain programs or channels by blocking them using the V-Chip feature.

#### Selecting a PIN code

Before you can block programs and channels, you must select a personal identification number (PIN) code. The PIN code you select prevents others from changing the rating limits you set.

#### To select your PIN code and access the V-Chip menus:

1. Press MENU, then press ◀ or ▶ to highlight the OPTION menu.
2. Press ▲ or ▼ to highlight V-CHIP.

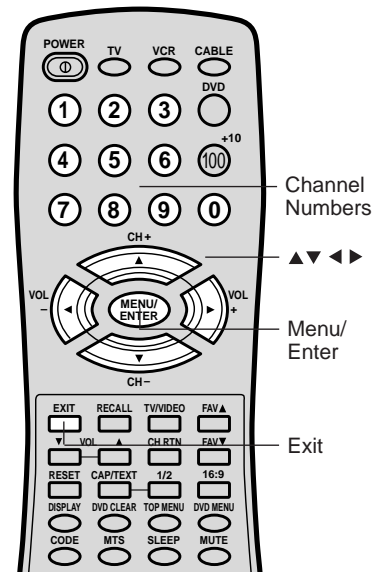
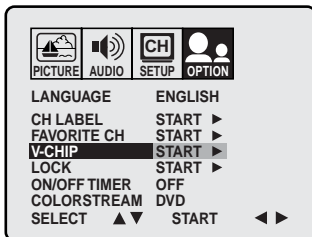

#### Note:

The PIN code you programmed is also used in the LOCK menu; see pages 22 and 23.

Using the TV's Features

- Press ◀ or ▶ to display the V-CHIP menu.

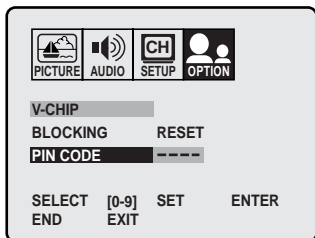

- Use the Channel Number buttons (0–9) to enter your PIN code. If you are accessing the V-Chip menus for the first time, select a four-digit number to be your PIN code. Press ENTER. The BLOCKING menu appears.

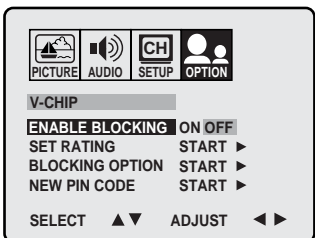

- You may now enable blocking. See “Blocking programs by ratings” (below), “Locking channels” (page 22), “To change your PIN code” (below), or “Blocking unrated movies or programs” (page 22).

#### To change your PIN code:

- Press MENU, then press ◀ or ▶ to display the OPTION menu.
- Press ▲ or ▼ to highlight V-CHIP.
- Press ◀ or ▶ to display the V-CHIP menu.
- Use the Channel Number buttons (0–9) to enter your PIN code. Press ENTER. The BLOCKING menu appears.
- Press ▲ or ▼ to highlight NEW PIN CODE and press ◀ or ▶ to display the NEW PIN CODE menu.
- Use the Channel Number buttons (0–9) to enter a new code. Press ENTER.
- Press EXIT to return to normal viewing.

#### Blocking programs by ratings

The Motion Picture Association of America (MPAA) uses a rating system to qualify motion picture content. Television broadcasters employ a rating system to qualify the content of television programs, as well. The MPAA, Youth TV, and TV ratings work with the V-Chip feature and allow you to block programs according to the rating limits you set.

#### Note:

If you forget your PIN code, press **RECALL** four times within five seconds from the V-CHIP menu. This allows you to proceed to the **BLOCKING** menu and resets your PIN code.

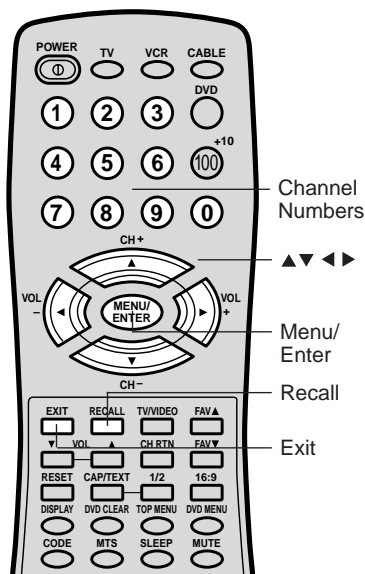

## MPAA Ratings

<b>X</b>	For adults only.
<b>NC17</b>	Not intended for anyone 17 or under.
<b>R</b>	Restricted. Under 17 requires an accompanying parent or adult guardian.
<b>PG13</b>	Parents strongly cautioned. Some material may be inappropriate for children under 13.
<b>PG</b>	Parental guidance suggested. Some material may not be appropriate for children.
<b>G</b>	General audience. Appropriate for all ages.

## Youth TV Ratings

<b>Y7FV, Y7</b>	Directed to older children. This program is designed for children age 7 and above. Programs in which fantasy violence may be more intense or combative than other programs in this category are designated TV-Y7-FV.
<b>Y</b>	All children. This program is designed to be appropriate for all children.

## TV Ratings

<b>MA</b>	Mature audience only. This program is specifically designed to be viewed by adults and therefore may be unsuitable for children under 17.  Language      Crude or indecent language. Sex              Explicit sexual activity. Violence        Graphic violence.
<b>14</b>	Parents strongly cautioned. This program contains some material that many parents would find unsuitable for children under 14 years of age.  Dialog           Intensely suggestive dialog. Language        Strong, coarse language. Sex                Intense sexual situations. Violence         Intense violence.
<b>PG</b>	Parental guidance suggested. This program contains material that parents may find unsuitable for younger children.  Dialog            Some suggestive dialog. Language        Infrequent coarse language. Sex                Some sexual situations. Violence         Moderate violence.
<b>G</b>	General audience. Most parents would find this program suitable for all ages.
<b>No DLSV</b>	Programs not rated according to Dialog, Language, Sex or Violence.

### **Note:**

*To see the rating of the program you are viewing, press **RECALL** at any time.*

### To use the V-Chip to block programs by rating:

1. Press MENU, then press ◀ or ▶ to display the OPTION menu.
2. Press ▲ or ▼ to highlight V-CHIP.
3. Press ◀ or ▶ to display the V-CHIP menu.
4. Use the Channel Number buttons (0–9) to enter your PIN code.  
If you are accessing the V-Chip menus for the first time, select a four-digit number to be your PIN code. Press ENTER.  
The BLOCKING menu appears.

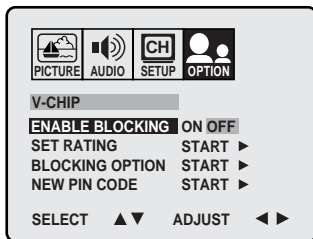

5. Press ▲ or ▼ to highlight ENABLE BLOCKING.
  - Press ◀ or ▶ to highlight ON to enable V-Chip program blocking by rating.
  - Press ◀ or ▶ to highlight OFF to disable V-Chip program blocking by rating.
6. Press ▲ or ▼ to highlight SET RATING. Then, press ◀ or ▶ to display the SET RATING menu.

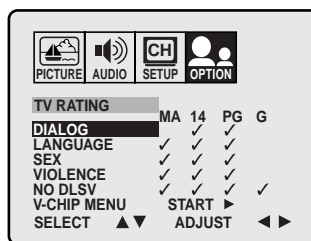
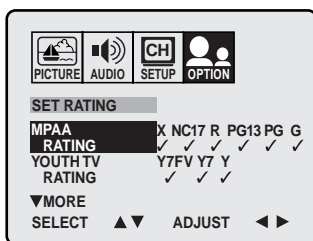

7. Press ▲ or ▼ to highlight MPAA Rating, Youth TV Rating or individual TV Ratings.
8. Press ◀ or ▶ to select the ratings that will be blocked. Blocked ratings are signified by a red "X." Unblocked ratings are signified by a green "✓." As you block ratings, all ratings higher than the ones you select are blocked, as well. For example, if you choose to block the MPAA rating R, the higher ratings NC17 and X are automatically blocked too.
9. When you are done selecting the ratings to be blocked, press EXIT to return to normal viewing.

When you try to view a program with a ratings block, a message will appear listing the program's ratings. The program can still be viewed if you press MUTE and then enter your PIN code to temporarily bypass the block.

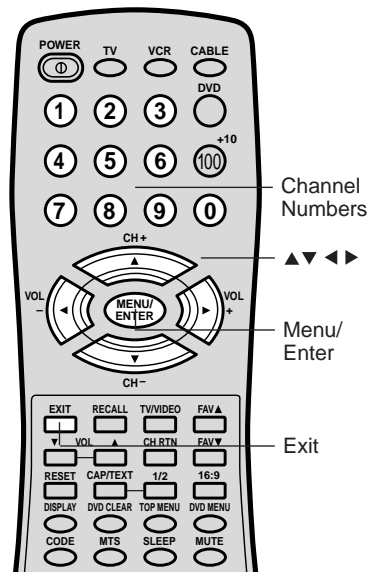

### Note:

*Not all programs are rated. To block programs or movies that are unrated, see "Blocking unrated movies or programs," page 22.*

## Blocking unrated movies or programs

Some movies and programs are not rated. You can block these movies and programs using the V-Chip.

### To block unrated movies or programs:

1. Press MENU, then press ◀ or ▶ to display the OPTION menu.
2. Press ▲ or ▼ to highlight V-CHIP.
3. Press ◀ or ▶ to display the V-CHIP menu.
4. Use the Channel Number buttons (0–9) to enter your PIN code.  
If you are accessing the V-Chip menus for the first time, select a four-digit number to be your PIN code. Press ENTER.  
The BLOCKING menu appears.
5. Press ▲ or ▼ to highlight BLOCKING OPTION.
6. Press ◀ or ▶ to display the BLOCKING OPTION menu.
7. Press ▲ or ▼ to highlight MPAA UNRATED.
  - Press ◀ or ▶ to highlight ON to block unrated movies.
  - Press ◀ or ▶ to highlight OFF to unblock unrated movies.
8. Press ▲ or ▼ to highlight TV NONE RATING.
  - Press ◀ or ▶ to highlight ON to block programs with a rating of "TV NONE." When you select ON, the message "NOTICE: ENABLING THIS OPTION MAY BLOCK EMERGENCY MESSAGES" appears.
  - Press ◀ or ▶ to highlight OFF to unblock programs with a rating of "TV NONE."
9. Press EXIT to return to normal viewing.

### Note:

Blocking television programs with a rating of "TV NONE" may block emergency messages.

## Using the LOCK menu

The LOCK menu includes the CH LOCK, VIDEO LOCK, GAME TIMER, and NEW PIN CODE functions.

You can use these functions after entering the correct PIN code. (This PIN code is the same one selected under "Selecting a PIN code" on page 18.)

### Locking channels

With the CH LOCK feature, you can lock specific channels. You will not be able to tune locked channels unless you clear the setting. You can choose to lock up to nine TV channels and nine cable channels.

#### To lock channels:

1. Use the Channel Number buttons (0–9) to display the television channel you wish to lock.
2. Press MENU, then press ◀ or ▶ to display the OPTION menu.
3. Press ▲ or ▼ to highlight LOCK.
4. Press ◀ or ▶ to display the LOCK menu.
5. Use the Channel Number buttons (0–9) to enter your PIN code, then press ENTER. The LOCK menu appears.
6. Press ▲ or ▼ to highlight CH LOCK and press ◀ or ▶ to display the CH LOCK menu.
7. Press ◀ or ▶ to select the following:
  - SET– to set the channel as one to be locked. Then press ENTER.
  - CLEAR– to clear all channels from the list of locked channels. Then press ENTER.
8. Repeat steps 1 through 7 to lock other channels. When you are finished locking channels, press EXIT to return to normal viewing.

If you try to tune a locked channel, the TV will not display it, but will display the nearest unlocked channel.

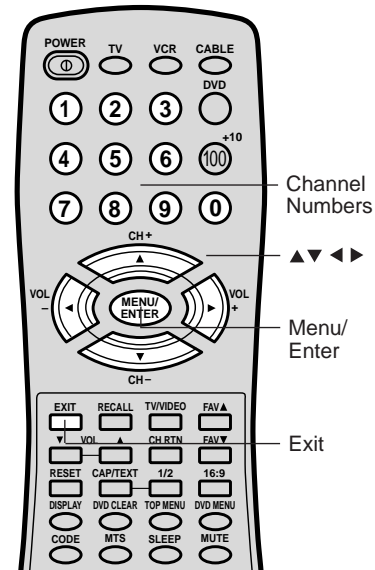
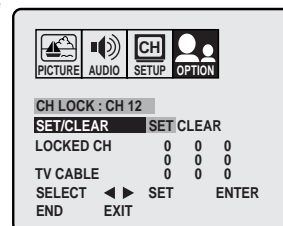
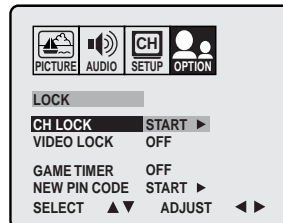

### Note:

After programming CH LOCK, change channels before turning off the television.

**To unlock channels:**

1. Press MENU, then press ◀ or ▶ to display the OPTION menu.
2. Press ▲ or ▼ to highlight LOCK and then press ◀ or ▶ to display the LOCK menu.
3. Use the Channel Number buttons (0–9) to enter your PIN code, then press ENTER. The LOCK menu appears.
4. Press ▲ or ▼ to highlight CH LOCK and press ◀ or ▶ to display the CH LOCK menu.
5. Press ◀ or ▶ to highlight CLEAR and clear all channels from the list of locked channels. Press ENTER.
6. Press EXIT to return to normal viewing.

**Locking video input**

With the VIDEO LOCK feature, you can lock out the input sources (VIDEO1, VIDEO2, VIDEO3, COLORSTREAM) and channels 3 and 4. You will not be able to select the input sources with the TV/VIDEO button or Channel buttons unless you clear the setting.

**To set up the video lock:**

1. Press MENU, then press ◀ or ▶ to display the OPTION menu.
2. Press ▲ or ▼ to highlight LOCK.
3. Press ◀ or ▶ to display the LOCK menu.
4. Use the Channel Number buttons (0–9) to enter your PIN code, then press ENTER. The LOCK menu appears.
5. Press ▲ or ▼ to highlight VIDEO LOCK.
6. Press ◀ or ▶ to select:
  - OFF: Unlocks all video input sources.
  - VIDEO: Locks VIDEO1, VIDEO2, VIDEO3 and COLORSTREAM.
  - VIDEO +: Locks VIDEO1, VIDEO2, VIDEO3, COLORSTREAM, channel 3 and channel 4. This option should be used if you use the antenna terminal to play a video tape.
7. Press EXIT to return to normal viewing.

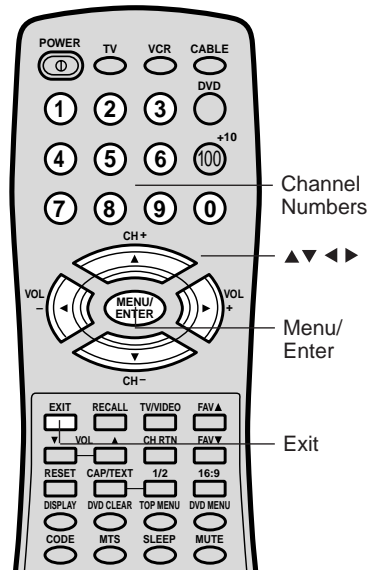
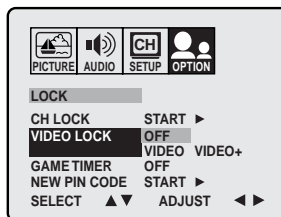
**Note:**

After programming VIDEO LOCK, change channels or activate the TV/VIDEO key before turning off the television.

**Setting the game timer**

With the GAME TIMER feature, you can automatically activate the VIDEO LOCK feature (VIDEO setting) to set a time limit for playing a TV game (30, 60, 90 or 120 minutes).

**To set up the game timer:**

1. Press MENU, then press ◀ or ▶ to display the OPTION menu.
2. Press ▲ or ▼ to highlight LOCK.
3. Press ◀ or ▶ to display the LOCK menu.
4. Use the Channel Number buttons (0–9) to enter your PIN code, then press ENTER. The LOCK menu appears.
5. Press ▲ or ▼ to highlight GAME TIMER.
6. Press ◀ or ▶ to select a time limit (30 minutes, 60 minutes, 90 minutes, 120 minutes or OFF).
7. Press EXIT to return to normal viewing. After the GAME TIMER is programmed, the display will appear briefly every ten minutes to remind you that the GAME TIMER is operating. When the programmed time is reached, the display will change the channel automatically.

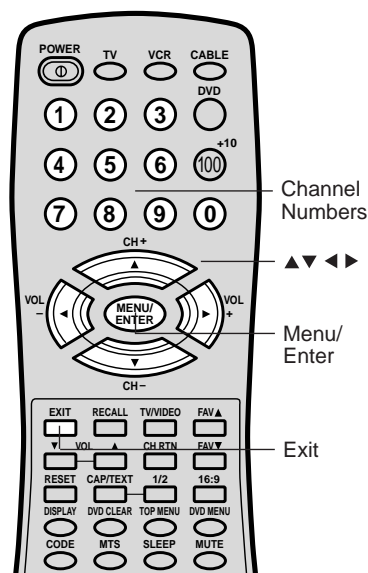
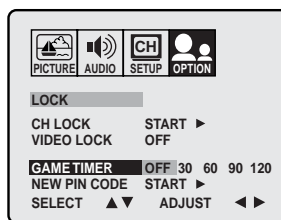

## Labeling channels

Channel labels appear over the channel number display each time you turn on the TV, select a channel, or press the Recall button. You can choose any four characters to identify a channel.

### To create channel labels:

1. Select a channel you want to label.
2. Press MENU, then press ◀ or ▶ until the OPTION menu appears.
3. Press ▲ or ▼ to highlight CH LABEL.

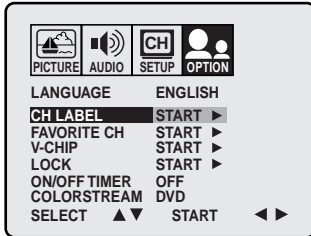

4. Press ◀ or ▶ to display the CH LABEL menu. SET/CLEAR will be highlighted.

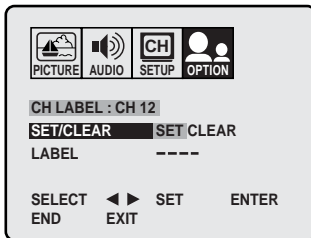

5. Press ◀ or ▶ to highlight SET.
6. Press ▲ or ▼ to highlight LABEL.

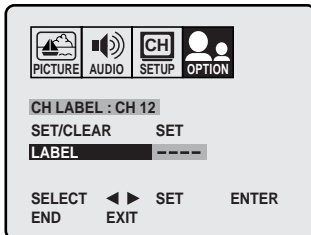

7. Press ◀ or ▶ to enter a character in the first space. Press the button repeatedly until the character you want appears on the screen. Press ENTER.
8. Repeat step 7 to enter the rest of the characters.  
If you would like a blank space in the label name, you must choose an empty space from the list of characters; otherwise, a dash will appear in that space.
9. Repeat steps 1~8 for other channels. You can assign a label to each channel.
10. Press EXIT to clear the screen.

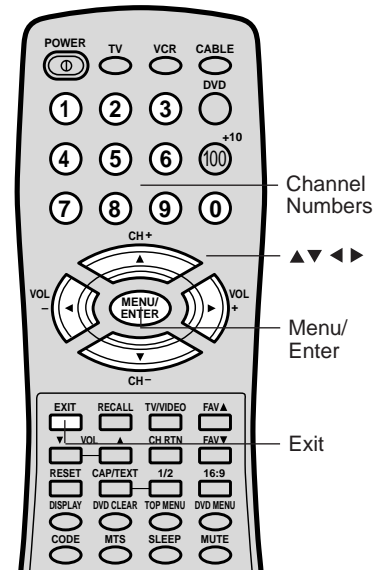
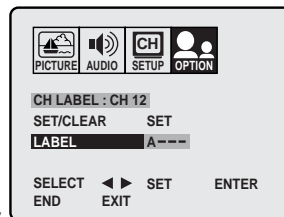

### Note:

The character will change as below.

— ↔ 0 ↔ ... ↔ 9 ↔ A ↔ ...  
↔ Z ↔ SPACE ↔ + ↔ -

### To erase channel labels:

1. Select a channel with a label.
2. Press MENU, then press ◀ or ▶ until the OPTION menu appears.
3. Press ▲ or ▼ to highlight CH LABEL.
4. Press ◀ or ▶ to display the CH LABEL menu. SET/CLEAR will be highlighted.
5. Press ◀ or ▶ to highlight CLEAR.
6. Press ENTER.
7. Repeat steps 1~6 to erase other channel labels.



## Setting the clock

You must set the clock before you can program the ON/OFF timer.

### To set the clock: (Example: 8:30 AM)

1. Press MENU, then press ◀ or ▶ to display the OPTION menu.
2. Press ▲ or ▼ to highlight ON/OFF TIMER.

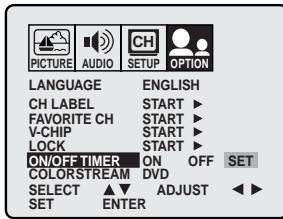

3. Press ◀ or ▶ to highlight SET, then press ENTER. The ON/OFF TIMER menu appears.
4. Press ▲ or ▼ to highlight CLOCK, then press ◀ or ▶ to highlight the hour position.

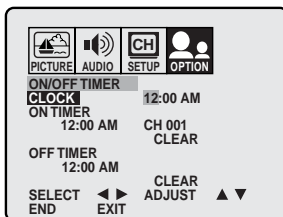

5. Press ▲ or ▼ to set the hour, then press ▶ to highlight the minute position.

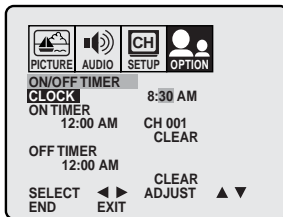

6. Press ▲ or ▼ to set the minutes, then press EXIT to return to normal viewing.

## Setting the ON/OFF timer

### Setting the on timer

This feature allows you to program the TV to turn on automatically at a set time. If you program the ON TIMER to "DAILY," the TV will turn on every day at the same time to the same channel until you clear the ON TIMER.

### To set the on timer: (Example: Turning on the TV to channel 12 at 7:00 AM, DAILY)

1. Press MENU, then press ◀ or ▶ to display the OPTION menu.
2. Press ▲ or ▼ to highlight ON/OFF TIMER.
3. Press ◀ or ▶ to highlight SET, then press ENTER. The ON/OFF TIMER menu appears.
4. Press ▲ or ▼ to highlight ON TIMER and press ◀ or ▶ to highlight the hour position.

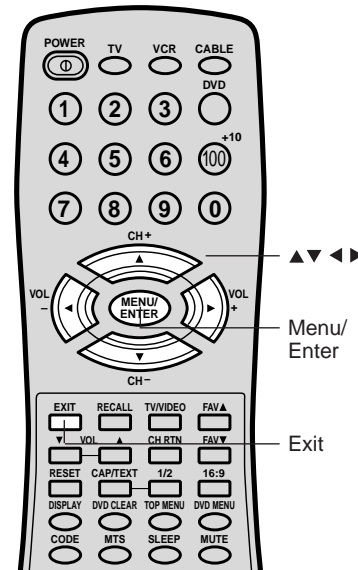
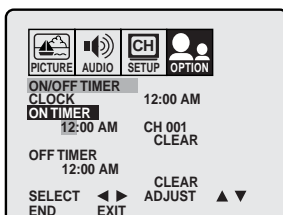

### Note:

If the power source for the TV is interrupted (for example, the power cord is unplugged or a power failure occurs), you will need to reset the clock.

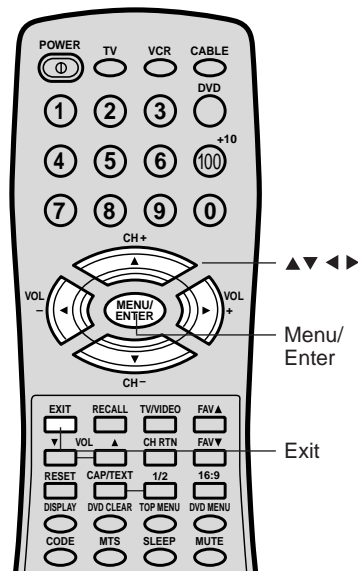

### Note:

After a power failure or disconnection of the power, the timer settings will be lost.

5. Press ▲ or ▼ to set the desired hour, then press ►.

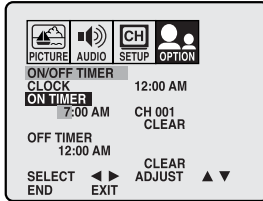

6. Set the desired minutes and channel, as in step 5.  
7. Press ◀ or ▶ to select ONCE or DAILY timer date.

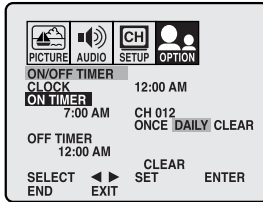

8. Press EXIT to return to normal viewing.

**To cancel the on timer:**

- Select CLEAR in step 7 above.  
Press EXIT to return to normal viewing.

**Setting the off timer**

This feature allows you to program the TV to turn off automatically at a set time. If you program the OFF TIMER to "DAILY," the TV will automatically turn off every day at the same time.

**To set the off timer: (Example: Turning off the TV at 11:30 PM)**

1. Press MENU, then press ◀ or ▶ to display the OPTION menu.
2. Press ▲ or ▼ to highlight ON/OFF TIMER.
3. Press ◀ or ▶ to highlight SET, then press ENTER.  
The ON/OFF TIMER menu appears.
4. Press ▲ or ▼ to highlight OFF TIMER, then press ◀ or ▶ to highlight the hour position.

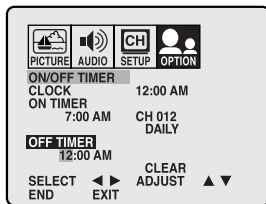

5. Press ▲ or ▼ to set the desired hour, then press ►.

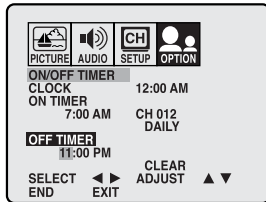

6. Set the desired minutes, as in step 5.  
7. Press ◀ or ▶ to select ONCE or DAILY.

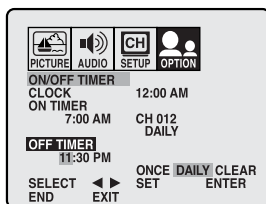

8. Press EXIT to return to normal viewing.

**To cancel the off timer:**

- Select CLEAR in step 7 above.  
Press EXIT to return to normal viewing.

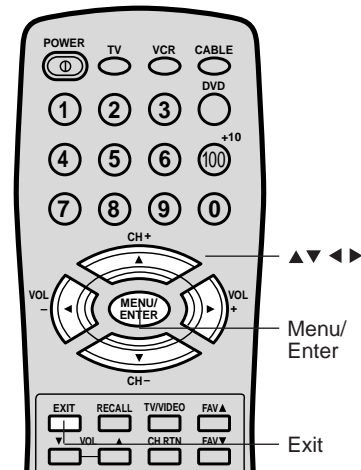

**Note:**

The ON TIMER has a one-hour automatic shut off. One hour after the ON TIMER has turned on the TV, the TV will turn off automatically unless you press any button or have set the OFF TIMER.

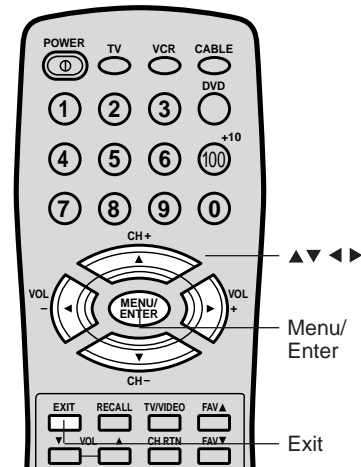

## Adjusting the picture quality

You can adjust the picture quality to your personal preferences, including the contrast, brightness, color, tint, and sharpness. The qualities you choose will be stored automatically in your TV's memory so you can recall them at any time.

### To adjust the picture quality:

1. Press MENU, then press ◀ or ▶ to display the PICTURE menu.

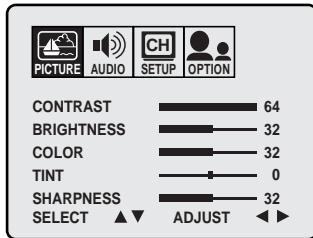

2. Press ▲ or ▼ until the item you want to adjust is highlighted.
3. Press ◀ or ▶ to adjust the level.

Selection	◀ Pressing ▶
contrast	lower higher
brightness	darker lighter
color	paler deeper
tint	reddish greenish
sharpness	softer sharper

4. Press EXIT to return to normal viewing.

## Watching video input

You can use the TV/VIDEO button on the remote control to view a signal coming from other devices, such as VCRs or video disc players that may be connected to your TV. (See "Connecting your TV" on page 7.)

## Selecting the ColorStream® mode

You can use the ColorStream (component video) input for connecting either a DVD player or a DTV receiver.

1. Press MENU, then press ◀ or ▶ until the OPTION menu appears.
2. Press ▲ or ▼ to highlight COLORSTREAM.
3. Press ◀ or ▶ to highlight DVD or DTV, depending on which device is connected.
4. Press EXIT to return to normal viewing.

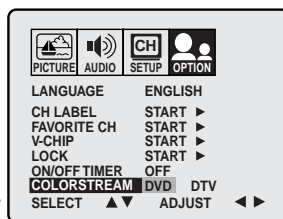

### Note:

The factory setting is DVD.

## Displaying on-screen information

Press RECALL to display the following on-screen information:

- Clock
- Channel number or VIDEO mode selected
- Channel label (if preset)
- Stereo or SAP (second audio program) audio status
- Content rating

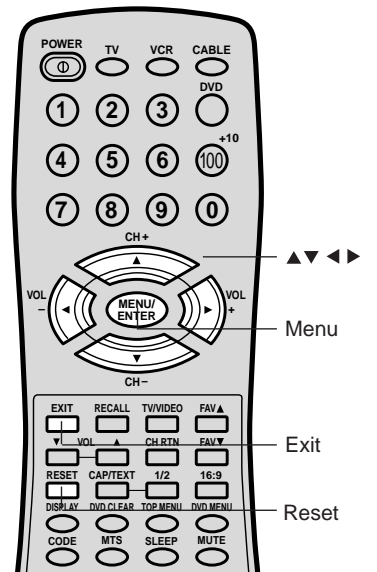
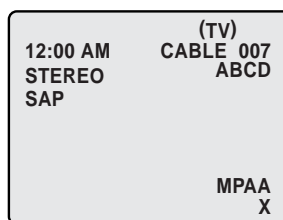

### Note:

To reset the picture adjustments to the factory settings, press RESET.

### To select the input mode:

Press the TV/VIDEO button repeatedly to select the desired mode. The signal source you are connected to is displayed in light blue.

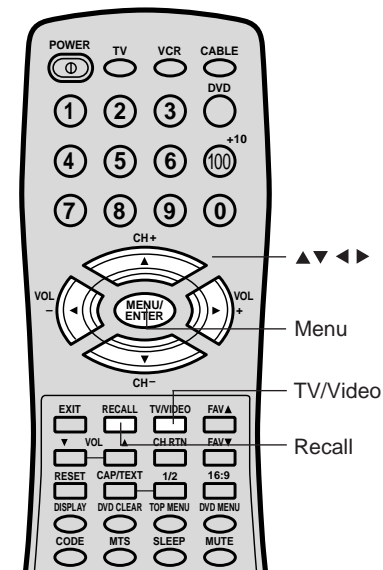

## Setting the sleep timer

You can set the TV so it turns off automatically.

### To set the sleep timer:

Repeatedly press SLEEP on the remote control to set the length of time until the TV turns off. The clock will count down 10 minutes for each press of the SLEEP button (120, 110, ...10, 0). After the sleep time is programmed, the display will appear briefly every ten minutes to remind you that the sleep timer is operating.

### To confirm the sleep timer setting:

Press SLEEP one time. The remaining time will be momentarily displayed.

### To cancel the sleep timer:

Repeatedly press SLEEP until the display turns to 0.

## Using the closed caption feature

You have two options with the closed caption feature: captions or text. A caption is a printed version of the dialogue, narration and/or sound effects of a program. Text is information not related to the program that appears on half of the TV screen when available.

### To view captions or text:

1. Select the desired program. Closed captioned programs are usually marked in your local TV listing as "CC."
2. Press CAP/TEXT repeatedly to select caption or text mode.



3. Press 1/2 to select the caption or text channel.

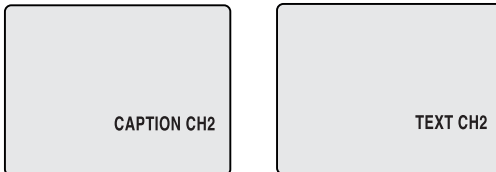

4. To turn off the closed caption feature, press CAP/TEXT repeatedly until captions or text no longer display on-screen.

## Changing the picture size

You can change the picture size to 16:9 (widescreen) style.

### To view 16:9 style:

Select the desired program, then press 16:9. The picture size will be displayed 16:9 style. "16:9" will appear on the screen for approx. 4 seconds.

### To cancel 16:9 style:

Press 16:9 again. The picture size will return to 4:3 style.

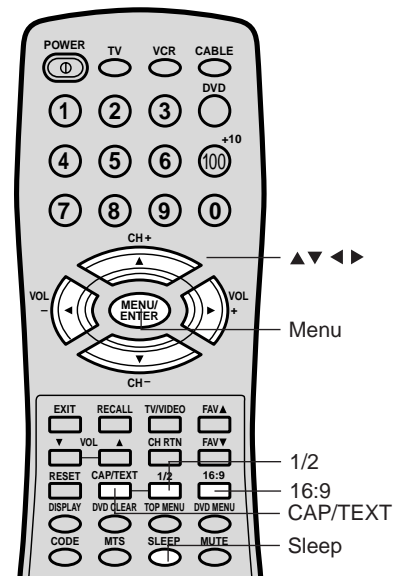
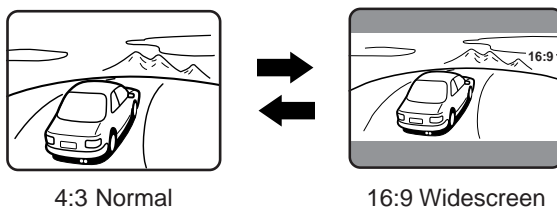

### Note:

A closed caption signal may not be decoded in the following situations:

- when a video tape has been dubbed
- when the signal reception is weak
- when the signal reception is non-standard

When you choose a closed captioned channel and the text mode, the text screen always appears as a black box. When there is no signal, however, the text screen will not display text characters. Repeatedly press CAP/TEXT until the box disappears.

## Adjusting the sound

### Muting the sound

Press MUTE to temporarily turn off the sound. While the sound is off, the screen will display the word MUTE in the lower right-hand corner. To restore the sound, press MUTE again.

### Selecting stereo/SAP broadcasts

You can listen to high-fidelity stereo sound with the Multi-channel TV Sound (MTS) feature. MTS can also transmit a second audio program (SAP) containing a second language or other audio information.

When the TV receives a stereo or SAP broadcast, the word STEREO or SAP appears on-screen every time the TV is turned on, the channel is changed, or the RECALL button is pressed.

The MTS feature is not available in the VIDEO mode.

You can leave your TV in STEREO mode because it will automatically output stereo or monaural sound, depending on the broadcast type. If the stereo sound is noisy, select MONO to reduce the noise. The word STEREO or SAP is displayed in light blue when the TV receives the signal.

#### To select the desired MTS setting:

Repeatedly press the MTS button to select either STEREO, SAP, MONO+SAP, or MONO. If the current program is not available in stereo or SAP, the setting will not be available when you press the MTS button.

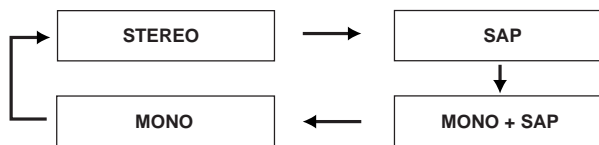

If the current program is not broadcasting either stereo or SAP, those settings will not be available when you press the MTS button.

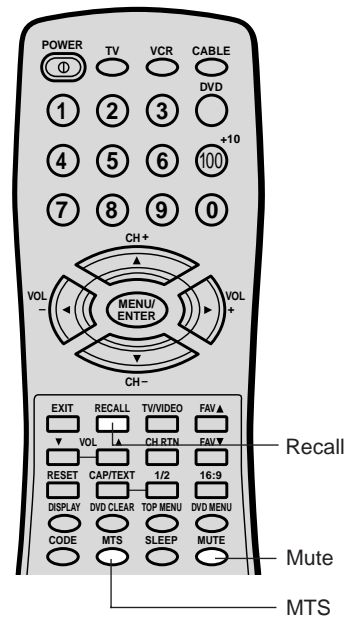

## Adjusting the sound quality

You can change the sound quality of your TV by adjusting the bass, treble, and balance.

### To adjust the sound quality:

1. Press MENU, then press ◀ or ▶ until the AUDIO menu appears.

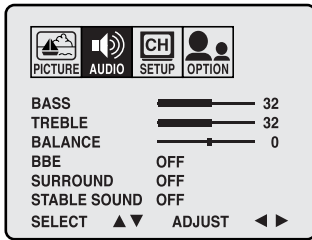

2. Press ▲ or ▼ to highlight the item you want to adjust.
3. Press ◀ or ▶ to adjust the level.

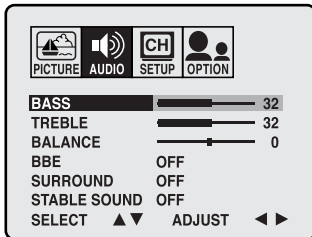

- ◀ makes the sound quality weaker or decreases the balance in the right channel, depending on the item selected.
- ▶ makes the sound quality stronger or increases the balance in the left channel, depending on the item selected.

## Using the BBE sound feature

By correcting the phase delay and distortion naturally generated by speaker systems, the BBE sound feature ensures that the sound that reaches your ears is as natural as the original sound. Human voices are clearer and music is natural and well-defined.

### To turn on the BBE sound feature:

1. Press MENU, then press ◀ or ▶ until the AUDIO menu appears.
2. Press ▲ or ▼ to highlight BBE.
3. Press ◀ or ▶ to highlight ON.

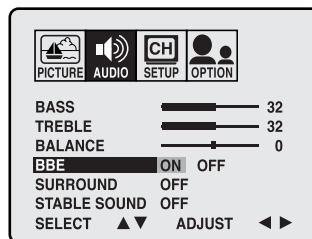

### To turn off the BBE sound feature:

Highlight OFF in step 3 above.

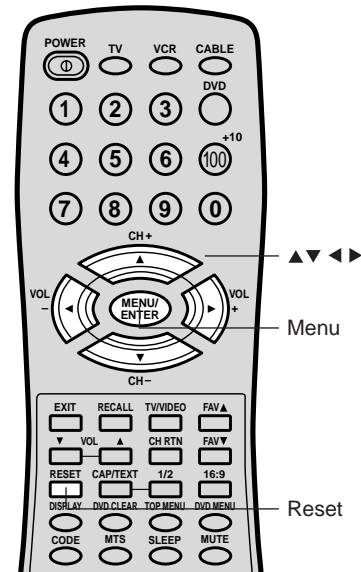

### Note:

To reset the audio adjustments to the factory settings, press RESET.

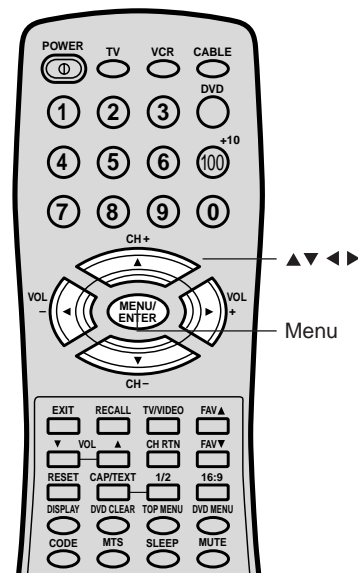

BBE and the BBE symbol are trademarks of BBE Sound, Inc.  
Licensed by BBE Sound, Inc. under USP4638258 and 4482866.  
Manufactured under license from BBE Sound, Inc.

## Using the surround sound feature

The surround sound feature expands the audio listening field wider and deeper to create exceptional sound quality from the TV's speakers. The feature uses stereo signals from a TV broadcast or video input.

### To turn on the surround sound feature:

1. Select the STEREO mode, if available (see "Selecting stereo/SAP broadcasts" on page 29.)
2. Press MENU, and then press ◀ or ▶ until the AUDIO menu appears.
3. Press ▲ or ▼ to highlight SURROUND.
4. Press ◀ or ▶ to highlight ON.

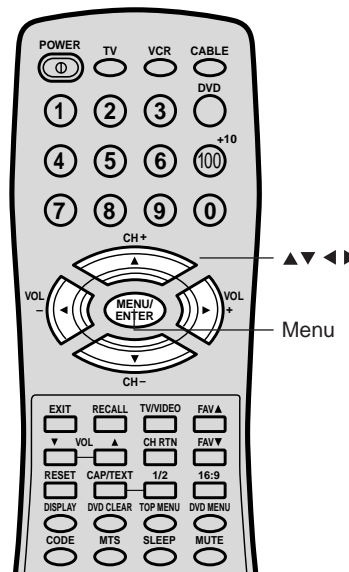
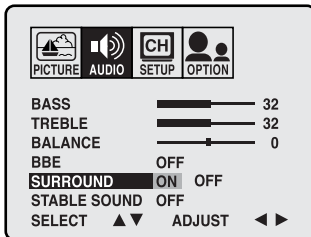

### To turn off the surround sound feature:

Highlight OFF in step 4 above.

In general, you can leave your TV in surround mode because it will automatically output the type of sound being broadcast (surround stereo or monaural).

## Using the StableSound® feature

The StableSound feature limits the highest volume level to prevent extreme changes in volume when the signal source is changed.

### To turn on the StableSound® feature:

1. Press MENU, then press ◀ or ▶ until the AUDIO menu appears.
2. Press ▲ or ▼ to highlight STABLE SOUND.
3. Press ◀ or ▶ to highlight ON.

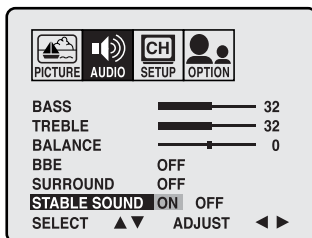

### To turn off the StableSound® feature:

Highlight OFF in step 3 above.

## Auto power off

The TV will automatically turn off after approximately 15 minutes if it is tuned to a vacant channel or a station that completes its broadcast for the day and stops broadcasting on that channel. This feature does not work in VIDEO mode.

## Understanding the Power Return feature

If the power is cut off while you are viewing the TV and the power is resupplied, the Power Return feature will turn the TV on automatically.

If the power is going to be off for a long time or you are going to be away from home for a long time, unplug the power cord from the wall outlet to prevent the TV from turning on in your absence.

# Appendix

## Troubleshooting

Before calling a service technician, please check the following table for a possible cause of the problem and some solutions.

### Problem

TV will not turn on

No picture, no sound

No sound, picture OK

Poor sound, picture OK

Poor picture, sound OK

Poor reception of broadcast channels

Cannot receive above channel 13

Unable to select a certain channel

Cannot access signal input sources (Video1, Video2, Video3 and ColorStream) and/or Channels 3 and 4

Multiple images

Poor color or no color

Black box on screen

No stereo or SAP sound from a known MTS broadcast

The V-Chip PIN code does not work (U.S. V-Chip system only)

The remote control does not operate

### Solution

- Make sure the power cord is plugged in, then press POWER.
- The remote control batteries may be dead. Replace the batteries.
- Check the antenna/cable connections.
- This TV will not accept or display 480p or 720p progressive scan signals or 1080i interlaced high-definition signals through its ColorStream inputs. Switch the other device's output to 480i interlaced mode first (see page 9).
- The sound may be muted. Press VOLUME.
- The station may have broadcast difficulties. Try another channel.
- The MTS feature may be in SAP mode. Press the MTS button on the remote control until STEREO (or MONO) mode is active.
- The station may have broadcast difficulties. Try another channel.
- The MTS feature may be in SAP mode. Press the MTS button on the remote control until STEREO (or MONO) mode is active.
- Check the antenna connections.
- The station may have broadcast difficulties. Try another channel.
- Adjust the PICTURE menu.
- This TV will not accept or display 480p or 720p progressive scan signals or 1080i interlaced high-definition signals through its ColorStream inputs. Switch the other device's output to 480i interlaced mode first (see page 9).
- The station may have broadcast difficulties. Try another channel.
- Check the antenna connections.
- If you are using a VCR, make sure the TV/VCR button is set correctly.
- Make sure TV/CABLE is set to CABLE mode.
- The channel may be blocked by the V-Chip feature or CH LOCK feature, or erased with the add/erase feature.
- Check the VIDEO LOCK feature.
- The station may have broadcast difficulties. Try another channel.
- Use a highly directional outdoor antenna.
- The station may have broadcast difficulties. Try another channel.
- Adjust the TINT and/or COLOR in the PICTURE menu.
- If you change the direction of the TV while it is turned on, the picture could suffer from color shading. If so, turn off the TV and allow it to cool for several hours before turning it on again.
- Repeatedly press CAP/TEXT to turn off the Closed Caption Text mode.
- Make sure the MTS feature is set properly.
- Change or reset your PIN code (pages 18 and 19).
- Make sure the TV/VCR/DVD/CABLE mode is set properly.
- Remove all obstructions between the remote control and the TV.
- The remote control batteries may be dead. Replace the batteries.



## Specifications

	20AF44	24AF44
Picture Tube	Type 20 (508.0 mm diagonal)	Type 24 (600 mm diagonal)
Television system	NTSC standard	
Channel coverage	VHF: 2 ~ 13 UHF: 14 ~ 69 Cable TV: 4A, A-5 ~ A-1, A-I, J ~ W, W+1 ~ W+48	
Power source	120V AC, 60 Hz	
Power consumption	105 W	125 W
Audio power	2.5W + 2.5W	5 W + 5 W
Speaker type	4-11/16 inches (50 x 119 mm) x 2 pcs.	
Video/Audio terminals	S-VIDEO INPUT Y-INPUT: 1V (p-p), 75 ohm, negative sync. C-INPUT: 0.286V (p-p) (burst signal), 75 ohm VIDEO/AUDIO INPUT VIDEO: 1V (p-p), 75 ohm, negative sync. AUDIO: 150 mV (rms) (30% modulation equivalent, 47k ohm) ColorStream® (component video) INPUT Y : 1V (p-p), 75 ohm PR : 0.7V (p-p), 75 ohm PB : 0.7V (p-p), 75 ohm VIDEO/AUDIO OUTPUT VIDEO: 1V (p-p), 75 ohm, negative sync. AUDIO: 150 mV (rms) (30% modulation equivalent, 47k ohm)	
Dimensions	Width: 23-1/4 inches (590 mm) Height: 17-9/16 inches (446.5 mm) Depth: 19-1/16 inches (484 mm)	26-3/8 inches (670 mm) 20-1/16 inches (509 mm) 18-9/16 inches (471.5 mm)
Weight	50.6 lbs. (23 kg)	72.8 lbs. (33 kg)
Supplied accessories	Remote control with two size "AAA" batteries	

Design and specifications are subject to change without notice.

# Limited United States Warranty

## For 24" FST PURE® and All Smaller Television Models

Toshiba America Consumer Products, L.L.C. ("TACP") and Toshiba Hawaii, Inc. ("THI") make the following limited warranties to original consumers in the United States. THESE LIMITED WARRANTIES EXTEND TO THE ORIGINAL CONSUMER PURCHASER OR ANY PERSON RECEIVING THIS TELEVISION AS A GIFT FROM THE ORIGINAL CONSUMER PURCHASER AND TO NO OTHER PURCHASER OR TRANSFEREE. PRODUCTS PURCHASED IN THE U.S.A. AND USED IN CANADA ARE NOT COVERED BY THESE WARRANTIES. PRODUCTS PURCHASED IN CANADA AND USED IN THE U.S.A. ARE NOT COVERED BY THESE WARRANTIES.

### Limited Ninety (90) Day Warranty on Labor\*

TACP/THI warrant this television and its parts against defects in materials or workmanship for a period of ninety (90) days after the date of original retail purchase. DURING THIS PERIOD, TACP/THI WILL, AT TACP/THI'S OPTION, REPAIR OR REPLACE A DEFECTIVE PART WITH A NEW OR REFURBISHED PART WITHOUT CHARGE TO YOU FOR PARTS OR LABOR. YOU MUST DELIVER THE ENTIRE TELEVISION TO AN AUTHORIZED TACP/THI SERVICE STATION. YOU MUST PAY FOR ALL TRANSPORTATION AND INSURANCE CHARGES FOR THE TELEVISION TO AND FROM THE SERVICE STATION.

### Limited One (1) Year Warranty on Parts\*

TACP/THI further warrant the parts in this television against defects in materials or workmanship for a period of one (1) year after the date of original retail purchase. DURING THIS PERIOD, TACP/THI WILL, AT TACP/THI'S OPTION, REPAIR OR REPLACE A DEFECTIVE PART WITH A NEW OR REFURBISHED PART WITHOUT CHARGE TO YOU FOR THE PART, PROVIDED THAT IF A DEFECTIVE PART IS REPAIRED OR REPLACED AFTER NINETY (90) DAYS FROM THE DATE OF ORIGINAL RETAIL PURCHASE, YOU MUST PAY ALL LABOR CHARGES INVOLVED IN THE REPAIR OR REPLACEMENT. YOU MUST DELIVER THE ENTIRE TELEVISION TO AN AUTHORIZED TACP/THI SERVICE STATION. YOU MUST PAY FOR ALL TRANSPORTATION AND INSURANCE CHARGES FOR THE TELEVISION TO AND FROM THE SERVICE STATION.

### Limited Two (2) Year Warranty on Picture Tube\*

TACP/THI further warrant the picture tube in this television against defects in materials or workmanship for a period of two (2) years after the date of original retail purchase. DURING THIS PERIOD, TACP/THI WILL, AT TACP/THI'S OPTION, REPAIR OR REPLACE A DEFECTIVE PICTURE TUBE WITH A NEW OR REFURBISHED PICTURE TUBE WITHOUT CHARGE TO YOU, EXCEPT THAT IF A DEFECTIVE PICTURE TUBE IS REPAIRED OR REPLACED AFTER NINETY (90) DAYS FROM THE DATE OF THE ORIGINAL RETAIL PURCHASE, YOU MUST PAY ALL LABOR CHARGES INVOLVED IN THE REPAIR OR REPLACEMENT. YOU MUST DELIVER THE ENTIRE TELEVISION TO AN AUTHORIZED TACP/THI SERVICE STATION. YOU MUST PAY FOR ALL TRANSPORTATION AND INSURANCE CHARGES FOR THE TELEVISION TO AND FROM THE SERVICE STATION.

### Rental Units

The warranty for rental units begins with the first rental or thirty (30) days from the date of shipment to the rental firm, whichever comes first.

### \*Commercial Units

Televisions sold and used for commercial purposes have a limited ninety (90) day warranty for all parts, labor and picture tube.

### Owner's Manual and Demographic Card

You should read this owner's manual thoroughly before operating this television. You should complete and mail the enclosed Demographic card within ten days after you, or the person who has given you this product as a gift, purchased this television. This is one way to enable TACP/THI to provide you with better customer service and improved product. Failure to return the Demographic card will not affect your rights under this warranty.

### Your Responsibility

THE ABOVE WARRANTIES ARE SUBJECT TO THE FOLLOWING CONDITIONS:

- (1) You must provide your bill of sale or other proof of purchase.
- (2) All warranty servicing of this television must be made by an Authorized TACP/THI Service Station.

- (3) The warranties from TACP and THI are effective only if the television is purchased and operated in the U.S.A. or Puerto Rico.
- (4) Labor service charges for set installation, set up, adjustment of customer controls and installation or repair of antenna systems are not covered by these warranties. Reception problems caused by inadequate antenna systems are your responsibility.
- (5) Warranties extend only to defects in materials or workmanship as limited above and do not extend to any television or parts which have been lost or discarded by you or to damage to television or parts caused by misuse, accident, Acts of God, such as lightning or fluctuations in electric power, improper installation, improper maintenance or use in violation of instructions furnished by TACP/THI; or to units which have been modified or had the serial number removed, altered, defaced or rendered illegible.

### How to Obtain Warranty Services

If, after following all of the operating instructions in this manual and checking the section "Troubleshooting", you find that service is needed:

- (1) To find the nearest TACP/THI Authorized Service Station:  
For televisions purchased in the United States, except Hawaii, visit TACP's web site at [www.toshiba.com/tacp](http://www.toshiba.com/tacp), or call toll free 1-800-631-3811.  
For televisions purchased in Hawaii, contact Toshiba Hawaii, Inc., 327 Kamakee Street, Honolulu, HI 96814, (808) 591-9281.
- (2) Present your bill of sale or other proof of purchase to the Authorized Service Station. You must deliver the entire television to an Authorized TACP/THI Service Station. You must pay for all transportation and insurance charges for the television to and from the Service Station.

**For additional information, visit TACP's web site:  
[www.toshiba.com/tacp](http://www.toshiba.com/tacp).**

ALL WARRANTIES IMPLIED BY THE LAW OF ANY STATE OF THE U.S.A., INCLUDING THE IMPLIED WARRANTIES OF MERCHANTABILITY AND FITNESS FOR A PARTICULAR PURPOSE, ARE EXPRESSLY LIMITED TO THE DURATION OF THE LIMITED WARRANTIES SET FORTH ABOVE. WITH THE EXCEPTION OF ANY WARRANTIES IMPLIED BY THE LAW OF ANY STATE OF THE U.S.A. AS HEREBY LIMITED, THE FOREGOING WARRANTY IS EXCLUSIVE AND IN LIEU OF ALL OTHER WARRANTIES, GUARANTEES, AGREEMENTS AND SIMILAR OBLIGATIONS OF TACP OR THI WITH RESPECT TO THE REPAIR OR REPLACEMENT OF ANY PARTS. IN NO EVENT SHALL TACP OR THI BE LIABLE FOR CONSEQUENTIAL OR INCIDENTAL DAMAGES.

No person, agent, distributor, dealer or company is authorized to change, modify or extend the terms of these warranties in any manner whatsoever. The time within which action must be commenced to enforce any obligation of TACP or THI arising under this warranty or under any law of the United States or of any state thereof is hereby limited to 90 days from the date you discover or should have discovered, the defect. This limitation does not apply to implied warranties arising under the law of any state of the U.S.A. THIS WARRANTY GIVES YOU SPECIFIC LEGAL RIGHTS, AND YOU MAY ALSO HAVE OTHER RIGHTS WHICH MAY VARY FROM STATE TO STATE IN THE U.S.A. SOME STATES OF THE U.S.A. DO NOT ALLOW LIMITATIONS ON HOW LONG AN IMPLIED WARRANTY LASTS, WHEN AN ACTION MAY BE BROUGHT, OR THE EXCLUSION OR LIMITATION OF INCIDENTAL OR CONSEQUENTIAL DAMAGES, SO THE ABOVE LIMITATIONS OR EXCLUSIONS MAY NOT APPLY TO YOU UNDER SUCH CIRCUMSTANCES.

FST PURE® is a registered trademark of Toshiba America Consumer Products, L.L.C.

# Limited Canada Warranty

## For 24" FST PURE® and All Smaller Television Models

Toshiba of Canada Limited ("TCL") makes the following limited warranties to original consumers in Canada. THESE LIMITED WARRANTIES EXTEND TO THE ORIGINAL CONSUMER PURCHASER OR ANY PERSON RECEIVING THIS TELEVISION AS A GIFT FROM THE ORIGINAL CONSUMER PURCHASER AND TO NO OTHER PURCHASER OR TRANSFEREE.

PRODUCTS PURCHASED IN THE U.S.A. AND USED IN CANADA ARE NOT COVERED BY THESE WARRANTIES.

PRODUCTS PURCHASED IN CANADA AND USED IN THE U.S.A. ARE NOT COVERED BY THESE WARRANTIES.

### Limited Ninety (90) Day Warranty on Labor\*

TCL warrants this television and its parts against defects in materials or workmanship for a period of ninety (90) days after the date of original retail purchase. DURING THIS PERIOD, TCL WILL, AT TCL'S OPTION, REPAIR OR REPLACE A DEFECTIVE PART WITH A NEW OR REFURBISHED PART WITHOUT CHARGE TO YOU FOR PARTS OR LABOR. YOU MUST DELIVER THE ENTIRE TELEVISION TO AN AUTHORIZED TCL SERVICE STATION. YOU MUST PAY FOR ALL TRANSPORTATION AND INSURANCE CHARGES FOR THE TELEVISION TO AND FROM THE SERVICE STATION.

### Limited One (1) Year Warranty on Parts\*

TCL further warrants the parts in this television against defects in materials or workmanship for a period of one (1) year after the date of original retail purchase. DURING THIS PERIOD, TCL WILL, AT TCL'S OPTION, REPAIR OR REPLACE A DEFECTIVE PART WITH A NEW OR REFURBISHED PART WITHOUT CHARGE TO YOU FOR THE PART, PROVIDED THAT IF A DEFECTIVE PART IS REPAIRED OR REPLACED AFTER NINETY (90) DAYS FROM THE DATE OF ORIGINAL RETAIL PURCHASE, YOU MUST PAY ALL LABOR CHARGES INVOLVED IN THE REPAIR OR REPLACEMENT. YOU MUST DELIVER THE ENTIRE TELEVISION TO AN AUTHORIZED TCL SERVICE STATION. YOU MUST PAY FOR ALL TRANSPORTATION AND INSURANCE CHARGES FOR THE TELEVISION TO AND FROM THE SERVICE STATION.

### Limited Two (2) Year Warranty on Picture Tube\*

TCL further warrants the picture tube in this television against defects in materials or workmanship for a period of two (2) years after the date of original retail purchase. DURING THIS PERIOD, TCL WILL, AT TCL'S OPTION, REPAIR OR REPLACE A DEFECTIVE PICTURE TUBE WITH A NEW OR REFURBISHED PICTURE TUBE WITHOUT CHARGE TO YOU, EXCEPT THAT IF A DEFECTIVE PICTURE TUBE IS REPAIRED OR REPLACED AFTER NINETY (90) DAYS FROM THE DATE OF THE ORIGINAL RETAIL PURCHASE, YOU PAY ALL LABOR CHARGES INVOLVED IN THE REPAIR OR REPLACEMENT. YOU MUST DELIVER THE ENTIRE TELEVISION TO AN AUTHORIZED TCL SERVICE STATION. YOU MUST PAY FOR ALL TRANSPORTATION AND INSURANCE CHARGES FOR THE TELEVISION TO AND FROM THE SERVICE STATION.

### Rental Units

The warranty for rental units begins with the first rental or thirty (30) days from the date of shipment to the rental firm, whichever comes first.

### \*Commercial Units

Televisions sold and used for commercial purposes have a limited ninety (90) day warranty for all parts, labor and picture tube.

### Owner's Manual

You should read this owner's manual thoroughly before operating this television.

### Your Responsibility

THE ABOVE WARRANTIES ARE SUBJECT TO THE FOLLOWING CONDITIONS:

- (1) You must provide your bill of sale or other proof of purchase.
- (2) All warranty servicing of this television must be made by an Authorized TCL Service Station.
- (3) The warranties from TCL are effective only if the television is purchased in Canada from an authorized TCL dealer and operated in Canada.
- (4) Labor service charges for set installation, set up, adjustment of customer controls and installation or repair of antenna systems are not covered by these warranties. Reception problems caused by inadequate antenna systems are your responsibility.
- (5) Warranties extend only to defects in materials or workmanship as limited above and do not extend to any television or parts which have been lost or discarded by you or to damage to television or parts caused by misuse, accident, Acts of God, such as lightning or fluctuations in electric power, improper installation, improper maintenance or use in violation of instructions furnished by TCL; or to units which have been modified or had the serial number removed, altered, defaced or rendered illegible.

### How to Obtain Warranty Services

If, after following all of the operating instructions in this manual and checking the section "Troubleshooting", you find that service is needed:

- (1) To find the nearest TCL Authorized Service Station visit TCL's web site at [www.toshiba.ca](http://www.toshiba.ca)
- (2) Present your bill of sale or other proof of purchase to the Authorized Service Station. You must deliver the entire television to an Authorized TCL Service Station. You must pay for all transportation and insurance charges for the television to and from the Service Station.

**For additional information, visit TCL's web site:  
[www.toshiba.ca](http://www.toshiba.ca)**

ALL WARRANTIES IMPLIED BY THE LAW OF ANY PROVINCE OF CANADA, INCLUDING THE IMPLIED WARRANTIES OF MERCHANTABILITY AND FITNESS FOR A PARTICULAR PURPOSE, ARE EXPRESSLY LIMITED TO THE DURATION OF THE LIMITED WARRANTIES SET FORTH ABOVE. WITH THE EXCEPTION OF ANY WARRANTIES IMPLIED BY THE LAW OF ANY PROVINCE OF CANADA AS HEREBY LIMITED, THE FOREGOING WARRANTY IS EXCLUSIVE AND IN LIEU OF ALL OTHER WARRANTIES, GUARANTEES, AGREEMENTS AND SIMILAR OBLIGATIONS OF TCL WITH RESPECT TO THE REPAIR OR REPLACEMENT OF ANY PARTS. IN NO EVENT SHALL TCL BE LIABLE FOR CONSEQUENTIAL OR INCIDENTAL DAMAGES.

No person, agent, distributor, dealer or company is authorized to change, modify or extend the terms of these warranties in any manner whatsoever. The time within which action must be commenced to enforce any obligation of TCL arising under this warranty or under any law of Canada or of any province thereof, is hereby limited to 90 days from the date you discover or should have discovered, the defect. This limitation does not apply to implied warranties arising under the law of any province of Canada.

THIS WARRANTY GIVES YOU SPECIFIC LEGAL RIGHTS, AND YOU MAY ALSO HAVE OTHER RIGHTS WHICH MAY VARY FROM PROVINCE TO PROVINCE IN CANADA. SOME PROVINCES OF CANADA DO NOT ALLOW LIMITATIONS ON HOW LONG AN IMPLIED WARRANTY LASTS, WHEN AN ACTION MAY BE BROUGHT, OR THE EXCLUSION OR LIMITATION OF INCIDENTAL OR CONSEQUENTIAL DAMAGES, SO THE ABOVE LIMITATIONS OR EXCLUSIONS MAY NOT APPLY TO YOU UNDER SUCH CIRCUMSTANCES.

FST PURE® is a registered trademark of Toshiba America Consumer Products, L.L.C.

**TOSHIBA AMERICA CONSUMER PRODUCTS, L.L.C.**

**Head Office**

82 Totowa Road, Wayne, NJ 07470

**National Service Division**

1420B Toshiba Drive, Lebanon, TN 37087

**TOSHIBA HAWAII, INC.**

**Head Office**

327 Kamakee Street, Honolulu, HI 96814

**TOSHIBA OF CANADA LIMITED**

191 McNabb Street

Markham, Ontario L3R 8H2

TEL.: (905) 470-5400

**Service Centers:**

TORONTO: 191 McNABB STREET,

MARKHAM, ONTARIO, L3R 8H2, CANADA

TEL.: (905) 470-5400

MONTREAL: 18050 TRANS CANADA, KIRKLAND,

QUEBEC, H9J-4A1, CANADA

TEL.: (514) 390-7766

VANCOUVER: 22171 FRASERWOOD WAY,

RICHMOND, B.C., V62 1J5, CANADA

TEL.: (604) 303-2500

ColorStream®, FST Pure® and StableSound® are registered trademarks of Toshiba America Consumer Products, L.L.C.

PRINTED IN THAILAND



\*J3M71101A\*

04/02 

**TOSHIBA**

## Free Manuals Download Website

<http://myh66.com>

<http://usermanuals.us>

<http://www.somanuals.com>

<http://www.4manuals.cc>

<http://www.manual-lib.com>

<http://www.404manual.com>

<http://www.luxmanual.com>

<http://aubethermostatmanual.com>

Golf course search by state

<http://golfingnear.com>

Email search by domain

<http://emailbydomain.com>

Auto manuals search

<http://auto.somanuals.com>

TV manuals search

<http://tv.somanuals.com>