



TOSHIBA

OWNER'S MANUAL

Color Television

16:9
WIDE

COLORSTREAM®

SRS
WOW

30HF83

Introduction

Connecting
your TV

Using the
Remote Control

Setting up
your TV

Using the TV's
Features

Appendix

Index



Owner's Record

The model number and serial number are on the back of your TV. Record these numbers in the spaces below. Refer to these numbers whenever you communicate with your Toshiba dealer about this TV.

Model number:

Serial number:

Dear Customer,

Thank you for purchasing this Toshiba TV. This manual will help you use the many exciting features of your new TV.

Before operating the TV, please read this manual completely, and keep it nearby for future reference.

Safety Precautions

WARNING

TO REDUCE THE RISK OF FIRE OR ELECTRIC SHOCK, DO NOT EXPOSE THIS APPLIANCE TO RAIN OR MOISTURE.



WARNING: TO REDUCE THE RISK OF ELECTRIC SHOCK, DO NOT REMOVE COVER (OR BACK). NO USER-SERVICEABLE PARTS INSIDE. REFER SERVICING TO QUALIFIED SERVICE PERSONNEL.



The lightning symbol in the triangle tells you that the voltage inside this product may be strong enough to cause an electric shock. **DO NOT TRY TO SERVICE THIS PRODUCT YOURSELF.**



The exclamation mark in the triangle tells you that important operating and maintenance instructions follow this symbol.

NOTE TO CATV INSTALLERS IN THE USA

This is a reminder to call the CATV system installer's attention to Article 820-40 of the NEC, which provides guidelines for proper grounding and, in particular, specifies that the cable ground shall be connected to the grounding system of the building, as close to the point of cable entry as practical. For additional antenna grounding information, see items 25 and 26 on page 4.

NOTICE OF POSSIBLE TV STAND INSTABILITY



DANGER: RISK OF SERIOUS PERSONAL INJURY OR DEATH! Use this TV with

the TOSHIBA TV stand recommended in the "Specifications" section only. Use with other stands may result in instability, causing possible injury or death.

NOTICE OF POSSIBLE ADVERSE EFFECTS ON TV PICTURE TUBE

If a fixed (non-moving) pattern remains on the TV screen for long periods of time, the image can become permanently engrained in the picture tube. **This type of damage is NOT COVERED BY YOUR WARRANTY.**

See item 33 on page 4.

Child Safety

It Makes A Difference Where Your TV Stands



Congratulations on your purchase! As you enjoy your new TV, keep these safety tips in mind:

The Issue

- If you are like most consumers, you have a TV in your home. Many homes, in fact, have more than one TV.
- The home theater entertainment experience is a growing trend, and larger TVs are popular purchases; however, they are not always supported on the proper TV stands.
- Sometimes TVs are improperly secured or inappropriately situated on dressers, bookcases, shelves, desks, audio speakers, chests, or carts. As a result, TVs may fall over, causing unnecessary injury.

Toshiba Cares!

- The consumer electronics industry is committed to making home entertainment enjoyable and safe.
- The Consumer Electronics Association formed the Home Entertainment Support Safety Committee, comprised of TV and consumer electronics furniture manufacturers, to advocate children's safety and educate consumers and their families about television safety.

Tune Into Safety

- One size does NOT fit all! Use appropriate furniture large enough to support the weight of your TV (and other electronic components).
- Use appropriate angle braces, straps, and anchors to secure your furniture to the wall (but never screw anything directly into the TV).
- Carefully read and understand the other enclosed instructions for proper use of this product.
- Do not allow children to climb on or play with furniture and TVs.
- Avoid placing any item on top of your TV (such as a VCR, remote control, or toy) that a curious child may reach for.
- Remember that children can become excited while watching a program and can potentially push or pull a TV over.
- Share our safety message about this hidden hazard of the home with your family and friends. Thank you!



2500 Wilson Blvd.
Arlington, VA 22201 U.S.A.
Tel. 703-907-7600 Fax 703-907-7690
www.CE.org

CEA is the Sponsor, Producer and Manager of the International CES®

Important Safety Instructions

- 1) **Read these instructions.**
- 2) **Keep these instructions.**
- 3) **Heed all warnings.**
- 4) **Follow all instructions.**



- 5) **Do not use this apparatus near water.**



- 6) **Clean only with a dry cloth.**

- 7) **Do not block any ventilation openings.** Install in accordance with the manufacturer's instructions.

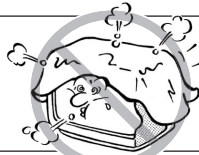

- 8) **Do not install near any heat sources** such as radiators, heat registers, stoves, or other apparatus (including amplifiers) that produce heat.

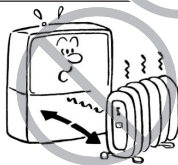

- 9) **Do not defeat the safety purpose of the polarized or grounding type plug.** A polarized plug has two blades with one wider than the other. A grounding type plug has two blades and a third grounding prong. The wide blade or the third prong are provided for your safety. If the provided plug does not fit into your outlet, consult an electrician for replacement of the obsolete outlet.

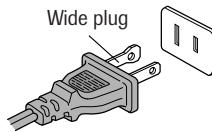

- 10) **Protect the power cord** from being walked on or pinched, particularly at plugs, convenience receptacles, and the point where it exits the apparatus.

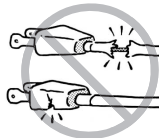

- 11) **Only use attachments/accessories specified by the manufacturer.**

- 12) **Use only with the cart, stand, tripod, bracket, or table specified by the manufacturer, or sold with the apparatus.** When a cart is used, use caution when moving the cart/apparatus combination to avoid injury from tip-over.



- 13) **Unplug this apparatus during lightning storms or when unused for long periods of time.**

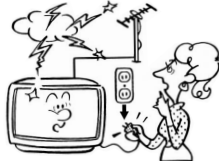

- 14) **Refer all servicing to qualified service personnel.**

Service is required when the apparatus has been damaged in any way, such as power supply cord or plug is damaged, liquid has been spilled or objects have fallen into the apparatus, the apparatus has been exposed to rain or moisture, does not operate normally, or has been dropped.



- 15) **CAUTION:** To reduce the risk of electric shock, do not use the polarized plug with an extension cord, receptacle, or other outlet unless the blades can be inserted completely to prevent blade exposure.

Installation, Care, and Service

Installation

Follow these recommendations and precautions and heed all warnings when installing your TV:

- 16) Never modify this equipment. Changes or modifications may void: a) the warranty, and b) the user's authority to operate this equipment under the rules of the Federal Communications Commission.

- 17) **DANGER: RISK OF SERIOUS PERSONAL INJURY, DEATH, OR EQUIPMENT DAMAGE!** Never place the TV on an unstable cart, stand, or table. The TV may fall, causing serious personal injury, death, or serious damage to the TV.



- 18) Never place or store the TV in direct sunlight; hot, humid areas; areas subject to excessive dust or vibration; or locations with temperatures at or below 41°F (5°C).

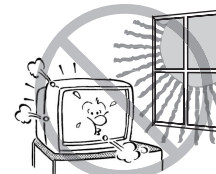

- 19) Always place the TV on the floor or a sturdy, level, stable surface that can support the weight of the unit.



- 20) Never place items such as vases, aquariums, or candles on top of the TV.



- 21) Never block or cover the slots or openings in the TV cabinet back, bottom, and sides. Never place the TV:

- on a bed, sofa, rug, or similar surface;
- too close to drapes, curtains, or walls; or
- in a confined space such as a bookcase, built-in cabinet, or any other place with poor ventilation.

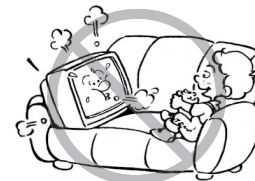

The slots and openings are provided to protect the TV from overheating and to help maintain reliable operation of the TV.

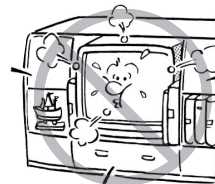

- 22) Never allow anything to rest on or roll over the power cord, and never place the TV where the power cord is subject to wear or abuse.

- 23) Never overload wall outlets and extension cords.





24) Always operate this equipment from a 120 VAC, 60 Hz power source only.

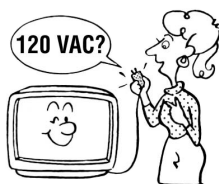

25) Always make sure the antenna system is properly grounded to provide adequate protection against voltage surges and built-up static charges (see Section 810 of the National Electric Code).

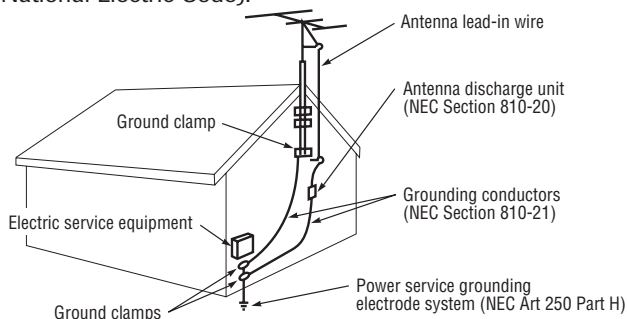

26) **DANGER: RISK OF SERIOUS PERSONAL INJURY OR DEATH!**



- Use extreme care to make sure you are never in a position where your body (or any item you are in contact with, such as a ladder or screwdriver) can accidentally touch overhead power lines. Never locate the antenna near overhead power lines or other electrical circuits.
- Never attempt to install any of the following during lightning activity:
 - a) an antenna system; or b) cables, wires, or any home theater component connected to an antenna or phone system.

Care

For better performance and safer operation of your TOSHIBA TV, follow these recommendations and precautions:

27) Always sit approximately 10–25 feet away from the TV and as directly in front of it as possible. The picture can appear dull if you sit too far to the left or right of the TV, or if sunlight or room lights reflect on the screen. Turn the TV off to check for reflections on the screen, and then remove the source of reflections while viewing the TV.

28) Always unplug the TV before cleaning. Never use liquid or aerosol cleaners.

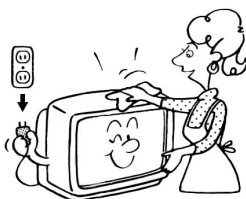

29) **WARNING: RISK OF ELECTRIC SHOCK!** Never spill liquids or push objects of any kind into the TV cabinet slots.



30) [This item applies to projection TVs only.] If the air temperature rises suddenly (for example, when the TV is first delivered), condensation may form on the lenses. This can make the picture appear distorted or the color appear faded. If this happens, turn off the TV for 6 to 7 hours to allow the condensation to evaporate.

31) For added protection of your TV from lightning and power surges, always unplug the power cord and disconnect the antenna from the TV if you leave the TV unattended or unused for long periods of time.

32) During normal use, the TV may make occasional snapping or popping sounds. This is normal, especially when the unit is being turned on or off. If these sounds become frequent or continuous, unplug the power cord and contact a Toshiba Authorized Service Center.

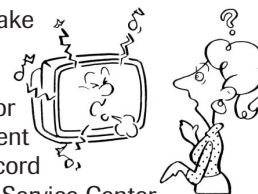

33) **Possible Adverse Effects on TV Picture Tube:** If a fixed (non-moving) pattern remains on the TV screen for long periods of time, the image can become permanently engrained in the picture tube and cause subtle but permanent ghost images. **This type of damage is NOT COVERED BY YOUR WARRANTY.** Never leave your TV on for long periods of time while it is displaying the following formats or images:

- **Fixed Images**, such as PIP/POP windows, stock tickers, video game patterns, TV station logos, and websites.
- **Special Formats** that do not use the entire screen. For example, viewing letterbox style (16:9) media on a normal (4:3) display (gray bars at top and bottom of screen); or viewing normal style (4:3) media on a widescreen (16:9) display (gray bars on left and right sides of screen).

Service

34) **WARNING: RISK OF ELECTRIC SHOCK!** Never attempt to service the TV yourself. Opening and removing the covers may expose you to dangerous voltage or other hazards. Refer all servicing to a Toshiba Authorized Service Center.

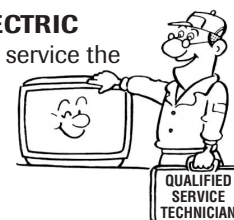

35) If you have the TV serviced:

- Ask the service technician to use only replacement parts specified by the manufacturer.
- Upon completion of service, ask the service technician to perform routine safety checks to determine that the TV is in safe operating condition.

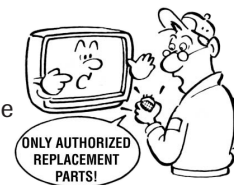

36) When the TV reaches the end of its useful life, ask a qualified service technician to properly dispose of the TV. Improper disposal may result in a picture tube implosion and possible personal injury.



Important Safety Information	2-4	Using the programmed channel search function	34
Introduction	6	Using the favorite channel search function	35
Welcome to Toshiba	6	About the auto favorite feature	35
Exploring your new TV	6	Using the LOCKS menu	36
Note regarding Quick Connect Guide	6	Entering the PIN code	36
Connecting your TV	7	If you cannot remember your PIN code	36
Connecting a VCR	7	Using the V-CHIP menu	37
Connecting a cable box	8	ENABLE BLOCKING	37
Connecting a cable box and VCR	8	TV RATING (Independent rating system for	
Connecting a DVD player or satellite receiver and		broadcasters)	37
a VCR	9	MPAA RATING (Independent rating system for	
Connecting a DVD player with component video		movies)	38
and a VCR	10	BLOCKING OPTION	38
Connecting a DTV receiver/set-top box with component		Unlocking programs temporarily	39
video and a VCR	11	Locking channels	39
Connecting two VCRs	12	Locking video inputs	40
Connecting a camcorder	12	Using the game timer	41
Connecting a device to the DVI/HDCP input	13	Using the front panel lock feature	41
Connecting an audio system	14	Changing the PIN code	41
Connecting an A/V receiver	14	Adjusting the picture	42
Using the remote control	15	Selecting the picture mode	42
Preparing the remote control for use	15	Adjusting the picture quality	42
Installing the remote control batteries	15	Saving your new preferences	43
Programming the remote control	16	Using the flesh tone feature	43
Remote control codes (cont.)	16-17	Using the CableClear™ DNR feature	43
Using the remote control to operate your other devices ..	18	Selecting the color temperature	44
Learning about the remote control	19	Selecting the display format (for 480p signals only) ..	44
Setting up your TV	20	Resetting your picture adjustments	44
Learning about the menu system	20	Selecting the video input source	45
Changing the on-screen display language	21	Labeling the video input sources	45
Selecting the antenna input	21	Using the closed caption feature	46
Programming channels into the channel memory	22	Setting the ON timer	47
Programming channels automatically	22	Setting the sleep timer	47
Adding and erasing channels manually	22	Setting the clock	48
Using the Quick Connect Guide	23	Selecting the background of the menu display	48
Changing channels	24	Adjusting the sound	49
Changing channels using SpeedSurf	24	Muting the sound	49
Adjusting the tilt correction feature	24	Selecting stereo/SAP broadcasts	49
Using the TV's features	25	Using the WOW™ surround sound feature	50
Adjusting the channel settings	25	Adjusting the sound quality	50
Switching between two channels using Channel		Resetting your audio adjustments	51
Return	25	Using the CYCLONE® sub-woofer system	51
Switching between two channels using		Turning off the built-in speakers	52
SurfLock™	25	Selecting the Audio OUT sound	52
Programming your favorite channels	25	Using the StableSound® feature	53
Labeling channels	27	Displaying on-screen information	53
Viewing the wide-screen picture formats	28	Viewing the demo mode	54
Selecting the picture size	28	Understanding the auto power off feature	54
Scrolling the Theater Wide picture		Understanding the last mode memory feature	54
(Theater Wide 2 and 3 only)	30	Appendix	55
Using the auto aspect feature	31	Specifications	55
Selecting the cinema mode	31	Troubleshooting	56
Using the POP double-window feature	32	Limited United States Warranty	57
Switching the main and POP pictures	33	Limited Canada Warranty	58
Freezing the POP picture	33	Index	59
Adjusting the size of the double-window	33		
POP double-window aspect ratio	34		

Introduction

Welcome to Toshiba

Congratulations! You have purchased one of the finest color TVs on the market. The goal of this manual is to guide you through setting up and operating your Toshiba TV as quickly as possible.

Instructions in this manual are based on using the remote control. You can also use the controls on the TV if they have the same name as those on the remote control.

Please read all the safety and operating instructions carefully, and keep the manual for future reference.

Exploring your new TV

You can operate your TV using the buttons on the front panel or the remote control. The back panel and front panel (behind the door) provide all the terminal connections you will need to connect other equipment to your TV. See "Connecting your TV" on page 7.

Note regarding Quick Connect Guide

The **Quick Connect Guide** automatically appears on-screen the first time the TV is turned on. This feature provides on-screen instructions to guide you through initial setup of your TV.

To stop the **Quick Connect Guide**, either press **EXIT** or turn off the TV.

See page 23 for details.

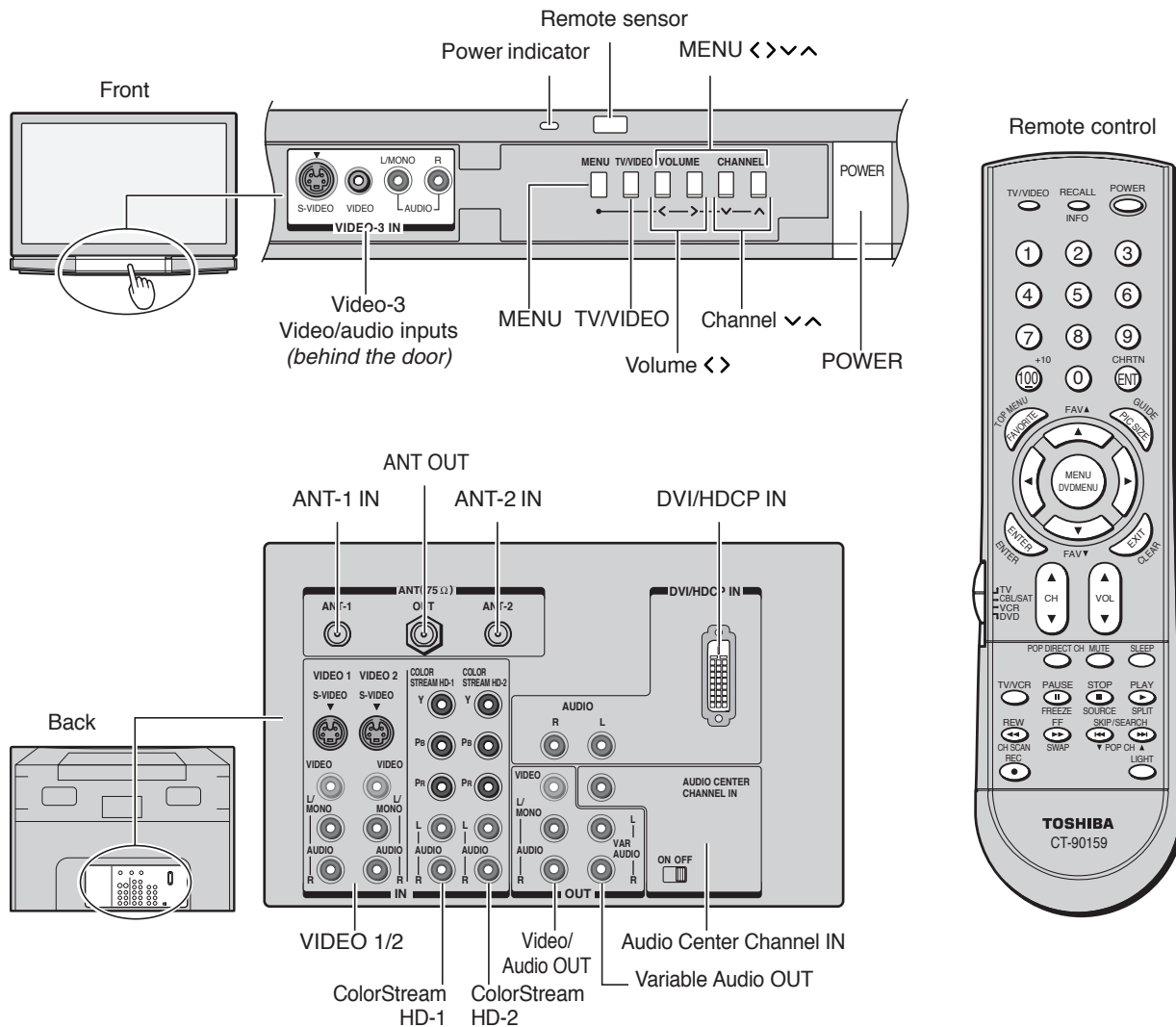

Connecting your TV

Note: Cables are not supplied with your TV.

- **Coaxial cable** is the cable that comes in from your antenna, cable TV service, or cable converter box. Coaxial cable uses "F" connectors.
- **Standard A/V (audio/video) cables** usually come in sets of three, and are typically color-coded according to use: yellow for video, red for stereo right audio, and white for stereo left (or mono) audio. On your TV's back panel, the standard A/V inputs are color-coded in the same manner as the cables.
- **S-Video cable** is for use with video equipment with S-Video output.
- **Component video cables** come in sets of three (color-coded red, green and blue), and are for use with video equipment with component video outputs. (ColorStream® is Toshiba's brand of component video.)
- **DVI-D digital single-link cable** is for use with video equipment with DVI-D output (see page 13).

NOTE REGARDING PICTURE QUALITY

When connecting video equipment to your Toshiba TV:

- **For GOOD picture quality:** Use a standard yellow video cable.
- **For BETTER picture quality:** If your equipment has an S-video input, use an S-video cable *instead of* a standard yellow video cable. (You still must connect the standard red and white audio cables for full system connection, but *do not connect the standard yellow video cable at the same time*, or the picture performance will be unacceptable.)
- **For BEST picture quality:** If your equipment has component video (or DVI) inputs, use either component video cables (or a DVI cable) *instead of* a standard video or S-video cable. (You still must connect the standard red and white audio cables for full system connection, but *do not connect the standard yellow video cable or an S-Video cable at the same time*.)

Connecting a VCR

This connection allows you to watch local channels and video programs, play or record on the VCR while watching TV, and record from one channel while watching another channel.

You will need:

- two coaxial cables
- one set of standard A/V cables

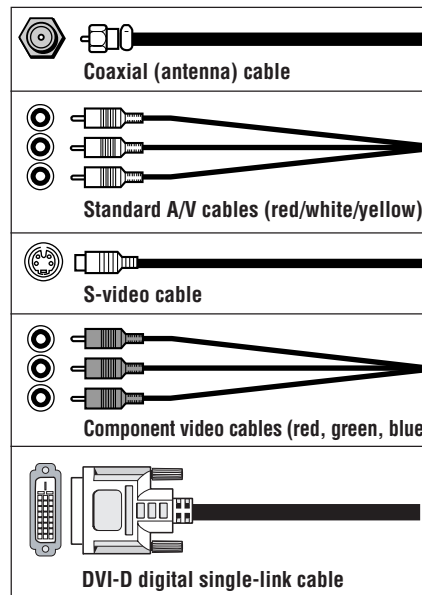
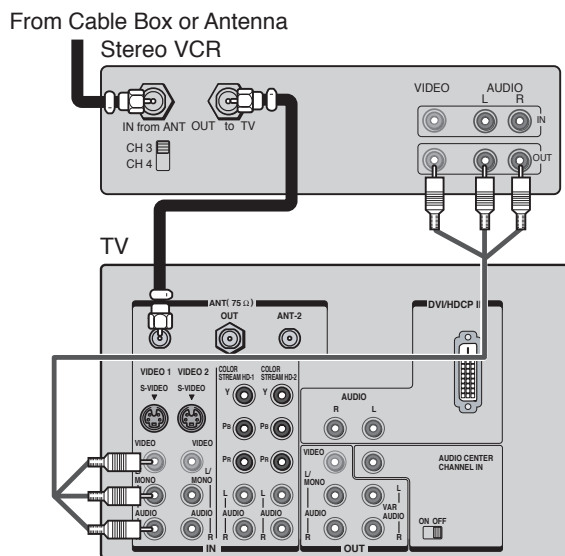

CAUTION:

Do not plug in any power cords until you have finished connecting all equipment.

Note:

If you have a mono VCR, connect L/Mono to VCR Audio OUT using only one audio cable.

If you have a VCR with S-video, use an S-video cable (plus audio cables) instead of the standard video cable for better picture performance.

Do not connect a standard video cable and an S-video cable to VIDEO 1 (or VIDEO 2) at the same time, or the picture performance will be unacceptable.

The unauthorized recording, use, distribution, or revision of television programs, videotapes, DVDs, and other materials is prohibited under the Copyright Laws of the United States and other countries, and may subject you to civil and criminal liability.

Connecting a cable box

This connection allows you to watch basic and premium cable channels. To watch basic cable and use the TV's features, select ANT-1. To view premium channels, select ANT-2, tune the TV to channel 3 or 4 (whichever channel is vacant in your area), and use the cable box to change channels.

You will need:

- three coaxial cables

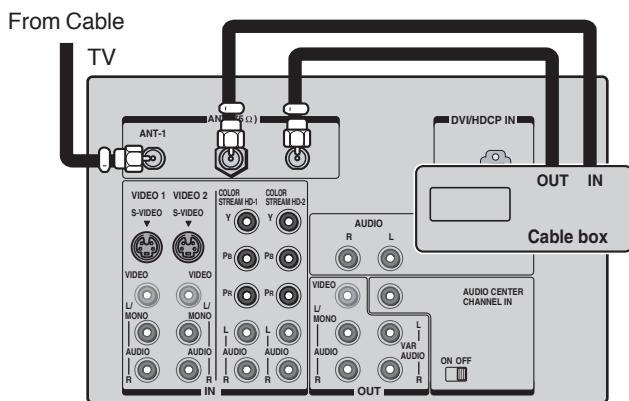

Note:

When you use a cable box with your TV, the remote control will not operate some features, such as programming your favorite channels, labeling channels, and locking channels.

Connecting a cable box and VCR

This connection allows you to watch and record basic and premium cable channels, watch videotapes, and record one channel while watching another channel. To watch basic cable and use the TV's features, select ANT-1.

To view premium channels or record with the VCR, select ANT-2, tune the TV to channel 3 or 4 (whichever channel is vacant in your area), and use the cable box to change channels.

You will need:

- four coaxial cables
- one set of standard A/V cables

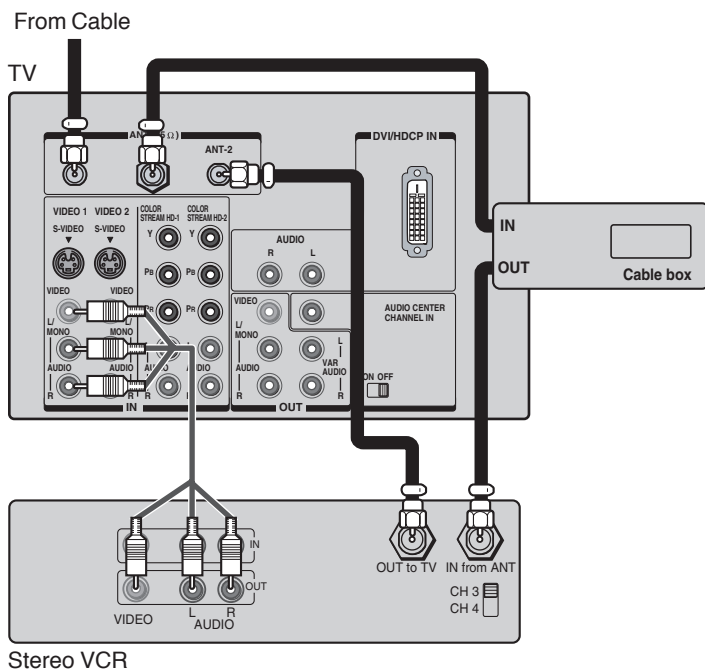

Note:

If you have a mono VCR, connect L/Mono to VCR Audio OUT using only one audio cable.

If you have a VCR with S-video, use an S-video cable (plus audio cables) instead of a regular video cable. Do not connect a standard video cable and an S-video cable to VIDEO 1 (or VIDEO 2) at the same time or the picture performance will not be acceptable.

When you use a converter box with your TV, the remote control will not operate some features, such as programming your favorite channels, labeling channels, and locking channels.

The unauthorized recording, use, distribution, or revision of television programs, videotapes, DVDs, and other materials is prohibited under the Copyright Laws of the United States and other countries, and may subject you to civil and criminal liability.

Connecting a DVD player or satellite receiver (without component video) and a VCR

This connection allows you to watch DVD/satellite, VCR, and TV programs, and record one TV channel while watching another channel.

You will need:

- two coaxial cables (three if satellite receiver is used)
- one set of standard A/V cables
- one pair of audio cables
- one S-video cable (between the TV and DVD player/satellite receiver)

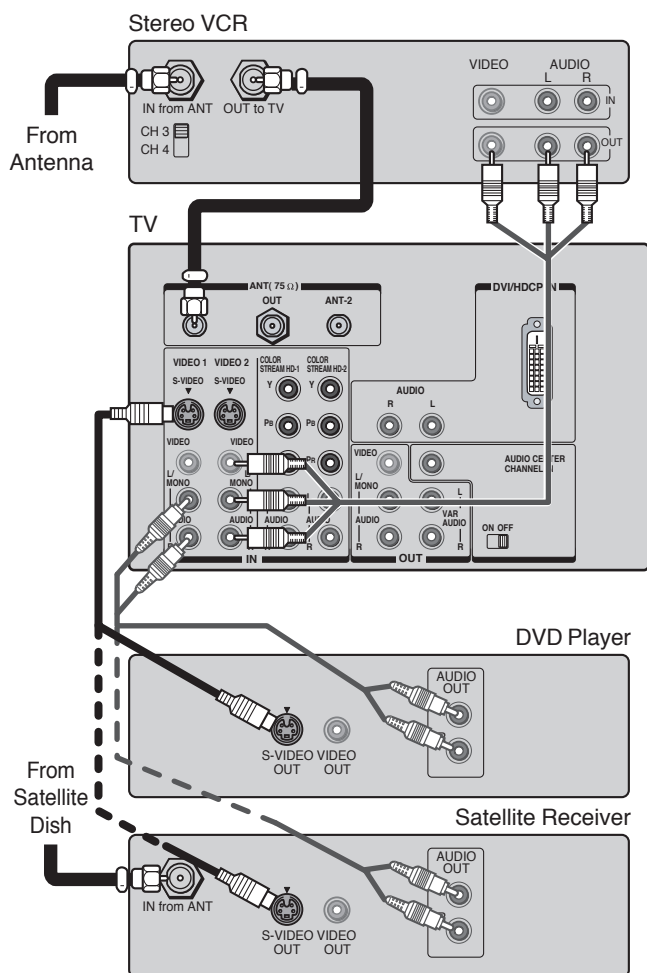

Note:

For the highest possible picture quality from a DVD player/satellite receiver, without component video (or DVI/HDCP), use an S-video cable. If your DVD player or satellite receiver has component video, see page 10.

If your DVD player or satellite receiver has DVI/HDCP, see page 13.

Do not connect an S-video cable and a standard video cable to VIDEO 1 (or VIDEO 2) or the picture performance will be unacceptable.

Do not connect the DVD player/satellite receiver and VCR to the same set of A/V inputs on the TV. (See the illustration, which shows the DVD player/satellite receiver connected to VIDEO 1 on the TV, and the VCR connected to VIDEO 2 on the TV.)

The unauthorized recording, use, distribution, or revision of television programs, videotapes, DVDs, and other materials is prohibited under the Copyright Laws of the United States and other countries, and may subject you to civil and criminal liability.

Connecting a DVD player with component video and a VCR

This connection allows you to watch DVD, VCR, and TV programs, and record TV programs.

Your TV has ColorStream® (component video) inputs. Connecting your TV to a DVD player with component video inputs (such as a Toshiba DVD player with ColorStream®) can greatly enhance picture quality and realism.

- To record one TV program while watching another TV program, tune the VCR to the channel to record, and tune the TV to the channel to watch.
- To record a TV program while watching a DVD, tune the VCR to the channel to record, and select ColorStream HD-1 on the TV (see “Selecting the antenna input” on page 21).

You will need:

- two coaxial cables
- one set of standard A/V cables
- one pair of audio cables
- one set of component video cables

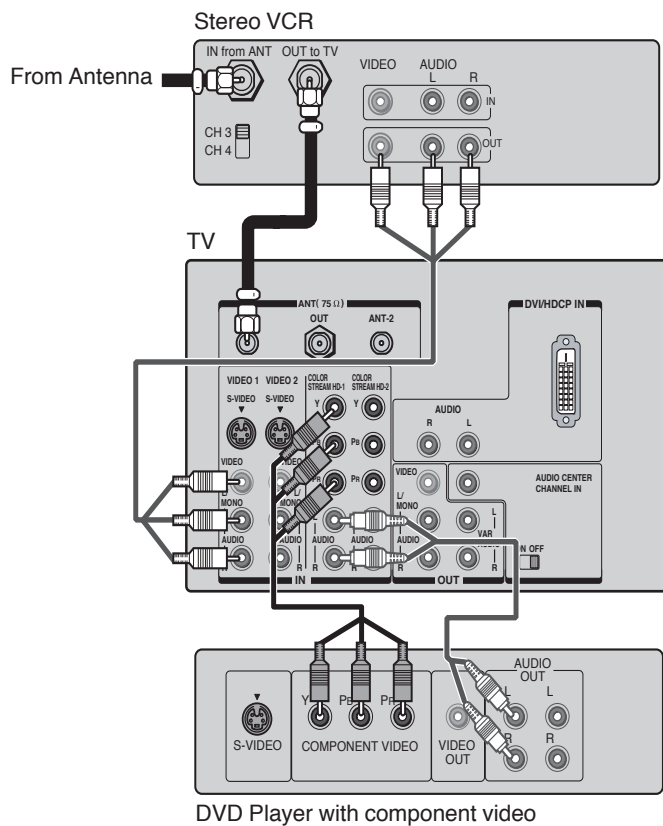

Note:

For the highest possible picture quality, use component video cables (or a DVI-D single-link cable) between the TV and DVD player. You can connect component video cables to either set of ColorStream jacks on the TV (HD-1 or HD-2).

The ColorStream HD-1 and HD-2 jacks can be used with Progressive (480p, 720p) and Interlaced (480i, 1080i) scan systems. A 1080i signal will provide the best picture performance.

If your DVD player does not have component video (or DVI/HDCP,) use the S-video connections plus the standard audio connections instead. Do not connect both S-Video and standard video cables to VIDEO 1 (or VIDEO2) at the same time or the picture performance will be unacceptable. See page 9.

For DVI/HDCP connection, see page 13.

The unauthorized recording, use, distribution, or revision of television programs, videotapes, DVDs, and other materials is prohibited under the Copyright Laws of the United States and other countries, and may subject you to civil and criminal liability.

Connecting a DTV receiver/set-top box with component video and a VCR

This connection allows you to watch DTV (digital TV), VCR, and TV programs, and record DTV and TV programs.

Your TV has ColorStream (component video) inputs. Connecting your TV to a DTV receiver with component video inputs can greatly enhance picture quality and realism.

- To record and watch a DTV program, select LINE IN on the VCR, and select ColorStream HD-2 (or VIDEO 1 for a non-ColorStream connection) on the TV (see "Selecting the antenna input" on page 21).
- To record a TV program while watching a DTV program, tune the VCR to the channel to record, and select ColorStream HD-2 on the TV.
- To record and watch the same TV program, tune the VCR to the channel to record, and select VIDEO 1 on the TV.
- To record one TV program while watching another TV program, tune the VCR to the channel to record, and tune the TV to the channel to watch.

You will need:

- three coaxial cables
- two sets of standard A/V cables
- one pair of audio cables
- one set of component video cables

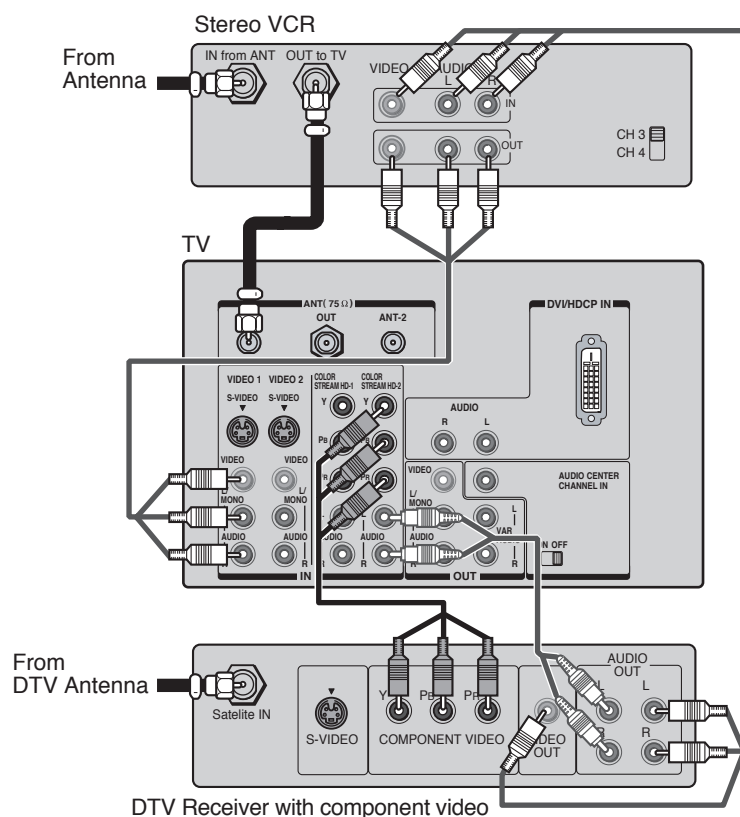

Note:

For the highest possible picture quality, use component video cables (or a DVI-D single-link cable) between TV and DTV receiver. You can connect the component video cables to either set of ColorStream jacks on the TV (HD-1 or HD-2).

The ColorStream HD-1 and HD-2 jacks can be used with Progressive (480p, 720p) and Interlaced (480i, 1080i) scan systems. A 1080i signal will provide the best picture performance.

If your DTV receiver does not have component video (or DVI-HDCP video), use the S-video and standard audio connections instead. Do not connect both an S-video and a standard video cable to VIDEO1 (or VIDEO2) at the same time or the picture performance will be unacceptable.

For DVI/HDCP connection, see page 13.

To monitor recording, set the TV to VIDEO 1.

The unauthorized recording, use, distribution, or revision of television programs, videotapes, DVDs, and other materials is prohibited under the Copyright Laws of the United States and other countries, and may subject you to civil and criminal liability.

Connecting two VCRs

This connection allows you to record (dub/edit) from one VCR to another VCR while watching a videotape. You can also record from one TV channel while watching another TV channel.

You will need:

- two coaxial cables
- two sets of standard A/V cables

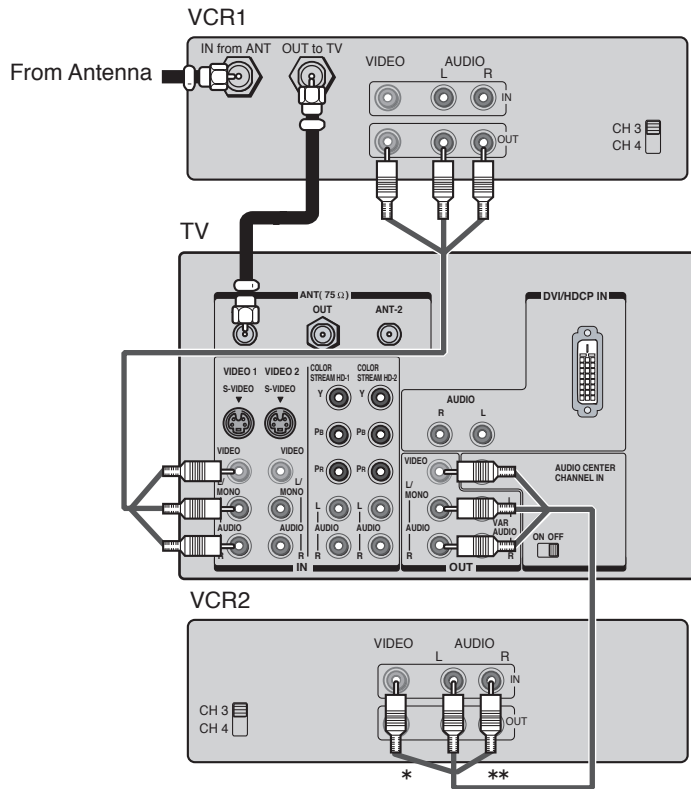

Note:

If VCR1 has S-video, you can use an S-video cable instead of the standard video cable for better picture performance. Do not connect both a standard video cable and an S-video cable to VIDEO 1 (or VIDEO 2) at the same time, or the picture performance will be unacceptable.

Do not connect the same VCR to the output and input jacks on the TV at the same time.

To dub or edit, VCR 2 must select Line IN, and the TV must select VIDEO 1 (see "Selecting the antenna input" on page 21).

The unauthorized recording, use, distribution, or revision of television programs, videotapes, DVDs, and other materials is prohibited under the Copyright Laws of the United States and other countries, and may subject you to civil and criminal liability.

* The Video OUT jack does not output the POP picture.

** The Audio OUT jacks can output the sound of either the Main or POP picture (see "Selecting the Audio OUT sound" on page 52).

Connecting a camcorder

This connection allows you to watch video materials recorded on a camcorder.

You will need:

- one set of standard A/V cables

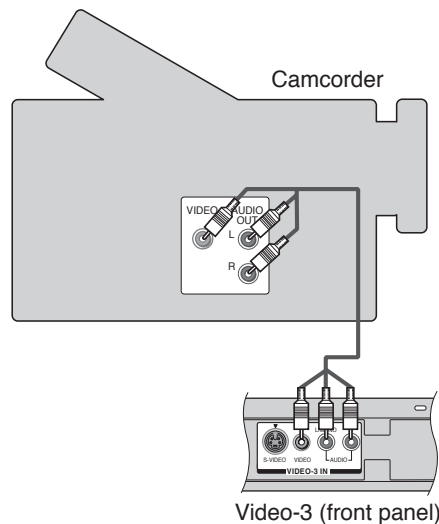

Note:

If your camcorder has S-video, you can use an S-video cable instead of the standard video cable for better picture performance. Do not connect both a standard video cable and an S-video cable at the same time, or the picture performance will be unacceptable.

Connecting a device to the DVI/HDCP input

The DVI/HDCP¹ input on your TV is designed to accept HDCP program material in digital form from EIA/CEA-861-compliant² consumer electronic devices, such as a set-top box or DVD player equipped with a DVI-D digital single-link output connection.³

The DVI/HDCP input is designed for best performance with 1080i high-definition video signals. The DVI/HDCP input also will accept and display 480p, 480i and 720p picture signals.

Note: *This TV is not intended for connection to and should not be used with a PC (personal computer).*

You will need:

- one coaxial cable
- one pair of standard audio cables
- one DVI-D digital single-link cable

Note: *For proper operation, the DVI-D cable length should not exceed 3m (9.8 ft). The recommended length is 2m (6.6 ft).*

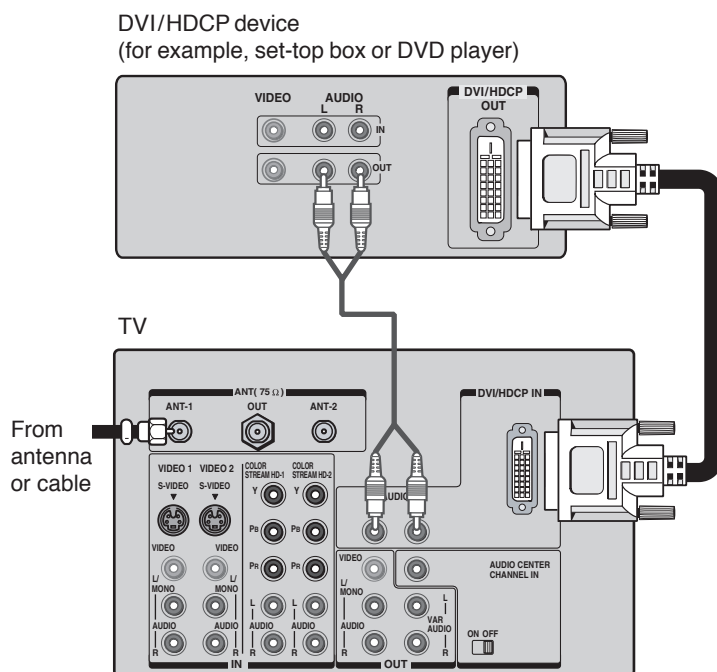

Note:

¹ DVI/HDCP = Digital Visual Interface/ High-bandwidth Digital Content Protection.

² EIA/CEA-861 compliance covers the transmission of uncompressed digital video with high-bandwidth digital content protection, which is being standardized for reception of high-definition video signals.

³ Consult your consumer electronics dealer for availability.

Caution:

To ensure that the DVI/HDCP device is reset properly, it is recommended that you follow these procedures:

- When turning on your electronic components, **turn on the TV first**, and then the DVI/HDCP device.
- When turning off your electronic components, **turn off the DVI/HDCP device first**, and then the TV.

Connecting an audio system

This connection allows you to use external speakers with an external audio amplifier to adjust the sound level.

To control the audio, turn on the TV and the stereo amplifier, and turn off the built-in speakers (see “Turning off the built-in speakers” on page 52).

You will need:

- one pair of audio cables

Note:

To hear sound when using an external audio amplifier, the volume of both the TV and the amplifier must be set to a moderate listening level.

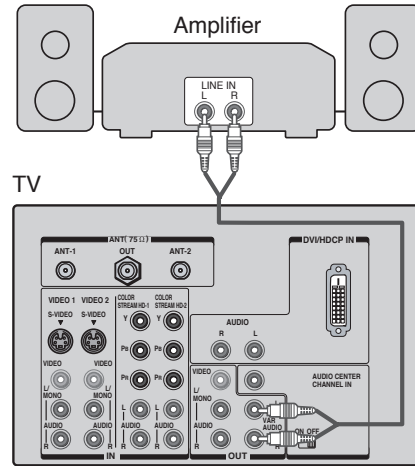

Connecting an A/V receiver

This connection allows you to use an audio/video (A/V) receiver to enhance your TV's sound.

If you have a sound system with Dolby Pro Logic surround sound, you can add to the realism of the sound by using the TV's internal speakers as center channel speakers.

You will need:

- one set of standard A/V cables
- one single standard audio cable for the audio center channel

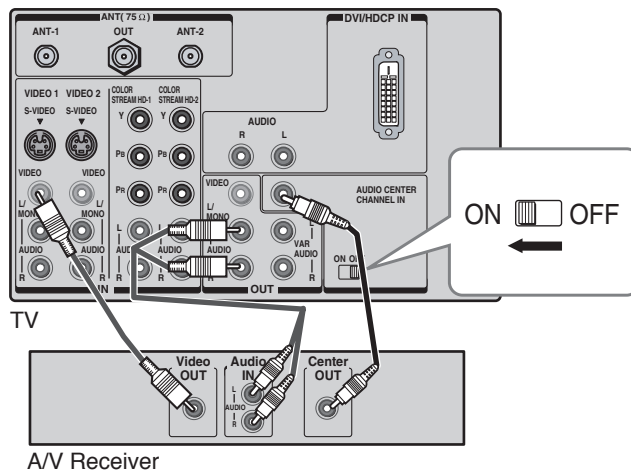

Note:

Refer to the instructions provided with your A/V receiver for details about your surround sound system.

When the Audio Center Channel ON/OFF switch is in the ON position, the TV speakers will function only as center channel speakers.

Adjust the volume for the center channel speakers using the center level control on the A/V receiver.

To use the TV speakers as normal speakers, set the Audio Center Channel ON/OFF switch to the OFF position.

Caution:

To avoid damaging the speakers:

- Turn off the TV before connecting or disconnecting the Audio Center Channel cable.
- Do not connect from the A/V receiver's amplified center speaker OUT to the TV's Audio Center Channel IN.

Dolby Pro Logic* surround sound system connection example

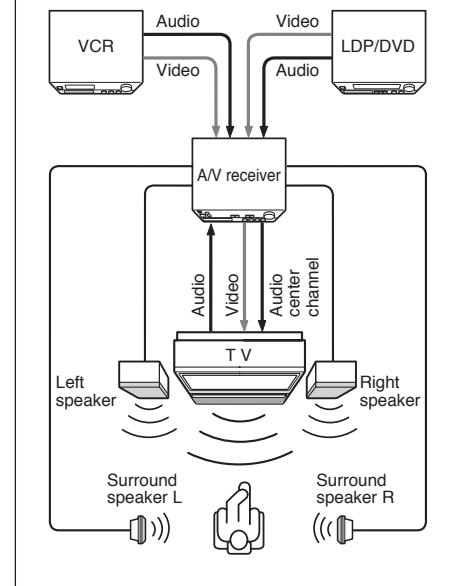

* “Dolby” and “Pro Logic” are trademarks of Dolby Laboratories.



Using the remote control

Preparing the remote control for use

Your TV remote control can operate your TV and many brands of cable boxes, satellite receivers, VCRs, DVD players, and HTIBs (home theater in a box), even if they are different brands.

If you have a Toshiba device:

Your TV remote control is preprogrammed to operate most Toshiba devices. See page 18.

If you have a non-Toshiba device or a Toshiba device that the remote control is not preprogrammed to operate:

You can program the TV remote control so it will operate the other device. See pages 16–18.

Installing the remote control batteries

1. Remove the battery cover from the back of the remote control.

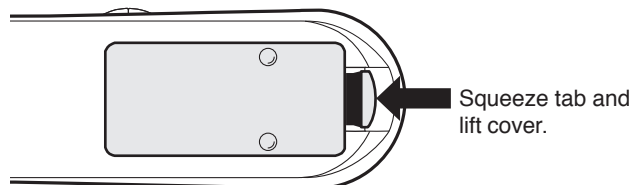

2. Install two "AA" size batteries, making sure to match the + and – signs on the batteries to the signs on the battery compartment.

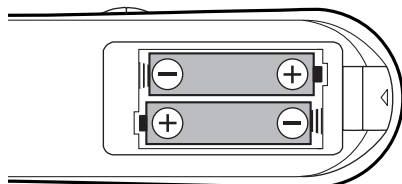

3. Reinsert the battery cover in the remote control until the tab snaps.

Caution:

- Dispose of batteries in a designated disposal area. Do not throw batteries into a fire.
- Do not mix battery types or combine used batteries with new ones.
- If the remote control does not operate correctly, or if the operating range becomes reduced, replace both batteries with new ones.
- If the batteries are dead or if you will not use the remote control for a long time, remove the batteries to prevent battery acid from leaking into the battery compartment.

Note:

If your Toshiba TV remote control does not operate all the features of your other device, use the original remote control for that device.

Remote control codes (cont.)

Satellite receiver (cont.)

RCA: 008, 009, 013, 016
 Realistic: 030
 Samsung: 059
 Sony: 014, 055
 Star Choice: 057
 Star Trak: 025, 026, 037, 054
 STS: 024
 Toshiba: 000, 001, 002, 003, 004, 005, 006, 007, 020, 031, 056
 Uniden: 021, 028, 030, 032, 035, 039, 043, 045, 047, 058
 Zenith: 027

TV/VCR Combo

Action: 078
 GE: 059, 062
 Goldstar: 065
 Panasonic: 065
 Precision: 078
 Quasar: 065
 Realistic: 079
 Sony: 074
 Toshiba: 057
 Zenith: 065

DVD/VCR Combo

Go Video:
 DVD=087, VCR=081
 JVC:
 DVD=088, VCR=082
 RCA:
 DVD=089, VCR=083
 Samsung:
 DVD=090, VCR=084
 Sanyo:
 DVD=091, VCR=085
 Zenith:
 DVD=092, VCR=086

DVD player

Aiwa: 006, 015
 Apex: 016, 017
 BOSE: 097
 Broksonic: 018
 Clarion: 019
 Classic: 020
 Daewoo: 021
 Denon: 022, 023, 024, 025
 Emerson: 026, 027
 Fisher: 028
 Funai: 027
 GE: 001, 029, 030
 Go Video: 087
 GPX: 031

Hitachi: 005, 032, 033, 034, 035
 JVC: 003, 007, 036, 042, 088
 Kenwood: 037
 Konka: 008, 009
 Magnavox: 004, 038
 Memorex: 039
 Mintek: 040
 NAD: 026
 Nakamichi: 041
 Norcent: 043
 Onkyo: 044
 Oritron: 058
 Panasonic: 010, 045, 046, 047, 048, 049, 050
 Philips: 004, 051
 Pioneer: 052, 053, 054, 055
 Proscan: 001, 056
 Qwestar: 057, 058
 RCA: 001, 002, 059, 089
 Sampo: 060
 Samsung: 061, 062, 086, 090
 Sansui: 073
 Sanyo: 063, 091
 Sharp: 064, 067
 Sherwood: 074
 Sony: 011, 012, 065, 066, 068, 069, 070
 Sylvania: 027
 Teac: 071
 Technics: 072
 Techwood: 075
 Toshiba: 000, 013, 076, 077, 078
 Yamaha: 079, 080, 081
 Zenith: 014, 082, 092

Portable DVD player

Aiwa: 093
 Audiovox: 094, 095
 Panasonic: 024, 096, 099
 RCA: 098

VCR

Admiral: 049
 Aiko: 019
 Aiwa: 018
 Akai: 003, 004, 037, 038, 039, 058, 069
 Audiovox: 010
 Bell & Howell: 007, 068
 Broksonic: 008, 017
 Calix: 010
 Carver: 026
 CCE: 019
 Citizen: 009, 010, 011, 012, 013, 014, 015, 019, 057, 073
 Colortype: 005
 Craig: 009, 010, 016, 061, 065, 079
 Curtis Mathes: 001, 005, 009, 012, 014, 040, 048, 053, 056, 057
 Daewoo: 011, 013, 015, 017, 018, 019, 057, 078
 Daytron: 078
 Denon: 063
 Dimensia: 001, 048
 Electrohome: 010, 020, 065
 Emerson: 003, 008, 010, 011, 017, 018, 020, 028, 039, 054, 057, 062, 065, 068, 072
 Fisher: 007, 016, 021, 022, 023, 057, 064, 068, 070, 071, 079
 Fuji: 004, 041
 Funai: 018, 073
 Garrard: 018
 GE: 001, 002, 009, 040, 042, 048, 056
 Go Video: 056, 059, 061, 081
 Goldstar: 005, 010, 014, 054, 056, 065, 067
 Gradiente: 018, 065
 Harman Kardon: 005
 Hitachi: 024, 025, 035, 037, 042, 063, 070, 080
 JBL: 076
 JC Penney: 005, 006, 007, 008, 009, 010, 023, 024, 025, 026, 035, 056, 061, 063, 065
 Jensen: 024, 025, 037, 050
 JVC: 005, 006, 007, 014, 037, 043, 050, 062, 063, 068, 082
 Kenwood: 005, 006, 007, 012, 014, 037, 043, 050, 053, 068, 071
 Kodak: 010
 LG: 010
 Lloyds: 053, 073, 079
 Logik: 061
 LXI: 010
 Magnasonic: 061, 065, 078
 Magnavox: 026, 027, 034, 044, 057, 061, 072
 Marantz: 005, 006, 007, 012, 014, 026, 053, 067

Memorex: 007, 009, 010, 016, 018, 034, 049, 063, 065, 066, 068, 075, 079
 MGA: 020, 028, 039
 MGN: 056
 Minolta: 024, 025, 035, 063
 Mitsubishi: 020, 024, 025, 028, 039, 043, 065
 Montgomery Ward: 049
 Motorola: 049
 MTC: 009, 046, 061
 Multitech: 009, 012, 018
 NEC: 005, 006, 007, 012, 014, 037, 043, 053, 054, 067, 070
 Nikko: 010
 Noblex: 009
 Optimus: 010, 049, 065
 Optonica: 031
 Orion: 054, 057, 062, 065, 068, 072
 Panasonic: 036, 045, 046, 057, 061, 072, 079
 Pentax: 012, 024, 025, 035, 042, 053, 063
 Pentex Research: 014
 Philco: 026, 027, 063
 Philips: 026, 031, 044, 057
 Pioneer: 006, 024, 043, 055
 Portland: 012, 013, 015
 Proscan: 001, 002, 048
 Proton: 061
 Quasar: 045
 Radio Shack: 010, 031, 065
 Radio Shack/Realistic: 007, 009, 010, 016, 018, 020, 021, 022, 031, 049
 Radix: 010
 RCA: 001, 002, 003, 009, 024, 025, 029, 035, 040, 042, 045, 048, 055, 056, 063, 071, 083
 Realistic: 007, 009, 010, 011, 016, 018, 020, 021, 022, 031, 049, 051, 056, 060, 065, 075, 079
 Ricoh: 047
 Runco: 034
 Samsung: 009, 011, 038, 056, 073, 084
 Sansui: 006, 037, 043, 061

Sanyo: 007, 009, 016, 054, 064, 068, 071, 075, 079, 085
 Scott: 008, 011, 017, 028, 030, 057, 065, 072
 Sears: 007, 010, 016, 021, 022, 023, 024, 025, 035, 053, 057, 063, 064, 065, 068, 071, 075, 079
 Sharp: 013, 020, 031, 049, 051, 060, 066
 Shintom: 004, 025, 032, 061
 Signature: 049
 Signature 2000: 075
 Singer: 047, 061
 Sony: 004, 032, 033, 041, 052, 058, 070, 074, 076, 077, 080
 STS: 035
 Sylvania: 018, 026, 027, 028, 044, 072
 Symphonic: 018, 050, 051, 053, 073, 079
 Tandy: 007
 Tashiko: 010
 Tatung: 037
 Teac: 018, 029, 037
 Technics: 036
 Teknika: 010, 018, 065
 Toshiba: 000, 011, 021, 023, 024, 028, 030, 039, 057, 074, 078, 079
 Totevision: 009, 010, 065
 Unitec: 073
 Unitech: 009
 Vector Research: 005, 006, 011, 012, 053
 Video Concepts: 005, 006, 011, 012, 039, 053
 Wards: 009, 010, 011, 016, 018, 020, 024, 025, 031, 035, 049, 051, 056, 057, 060, 065, 066, 079
 White Westinghouse: 073
 XR-1000: 018
 Yamaha: 005, 006, 007, 014, 037, 053
 Zenith: 004, 032, 034, 041, 047, 069, 086

HTIB

Lasonic: 083
 Panasonic: 084
 Venturer: 085

Introduction

Connecting your TV

Using the Remote Control

Setting up your TV

Using the TV's Features

Appendix

Index

Using the remote control to operate your other devices

If you have a non-Toshiba device or a Toshiba device that the remote control is not preprogrammed to operate, you must first program the remote control to recognize the device (if you have not already done so). See pages 16 and 17.

To use your TV remote control to operate a:

- cable box or satellite receiver, set the **Device Switch** to CBL/SAT.
- VCR, set the **Device Switch** to VCR.
- DVD player or HTIB, set the **Device Switch** to DVD.

Note:

Even after the TV remote control is programmed, it may not operate certain features on your other device. If this happens and you wish to use those features, you will need to use the device's original remote control.

Point the remote control directly at the device.

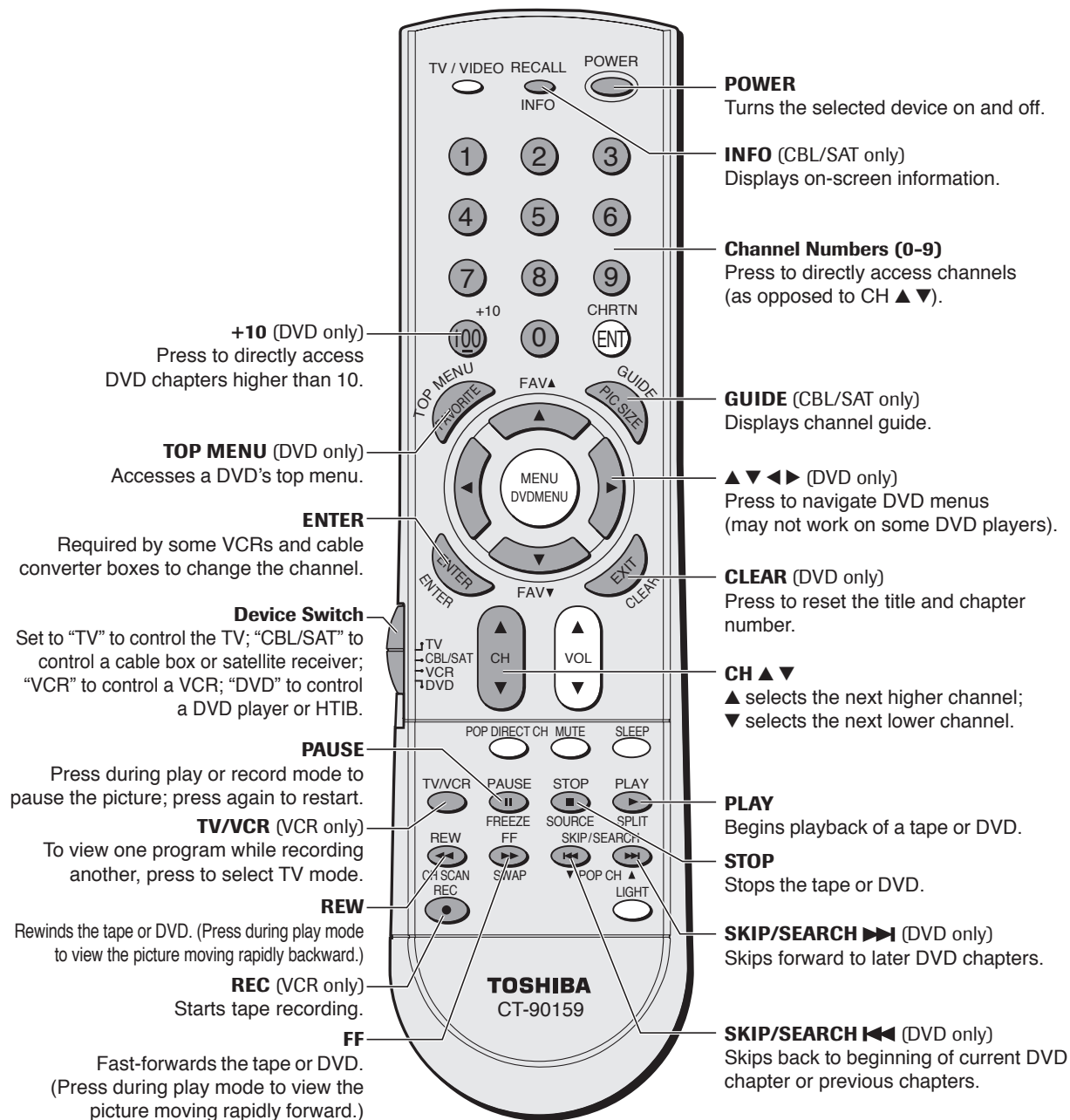

Learning about the remote control

The buttons used for operating the TV only are described here.

POWER turns the TV on and off

RECALL displays screen information (page 53)

SLEEP sets the TV to turn off at a specific time (page 47)

TV/VIDEO selects video input source (page 45)

MUTE mutes the sound (page 49)

Device Switch switches between TV, CLB/SAT/VCR, and DVD (Pages 16-18)
Set to "TV" to control the TV.

CH (channel) ▲ ▼ cycles through programmed channels (page 24)

Channel Numbers (0-9, 100) allow direct access to channels (page 24)

VOL (volume) ▲ ▼ adjusts the volume level

CH RTN returns to the memorized channel (page 25)

MENU allows access to on-screen programming menus (page 20)

ENTER sets programmed menu information (page 20)

▲ ▼ ◀ ▶ select or adjust programming menus (page 20)

POP CH ▲ ▼ selects the POP (picture-out-picture) channel (page 32)

FAV ▲ ▼ cycles through favorite channels (page 26)

FAVORITE allows access to the favorite channel search function (page 35)

PIC SIZE cycles through the five picture sizes: Natural, Theater Wide 1, 2, 3, and Full (page 28)

EXIT exits programming menus (page 20)

SPLIT turns the POP feature on and off (page 32)

SOURCE selects the POP picture source (page 32)

FREEZE freezes the POP picture (page 33)

SWAP switches the main and POP pictures (page 33)

POP DIRECT CH allows direct access to POP channels (page 32)

CH SCAN allows access to the programmed channel search function (page 34)

LIGHT illuminates the keypad for five seconds

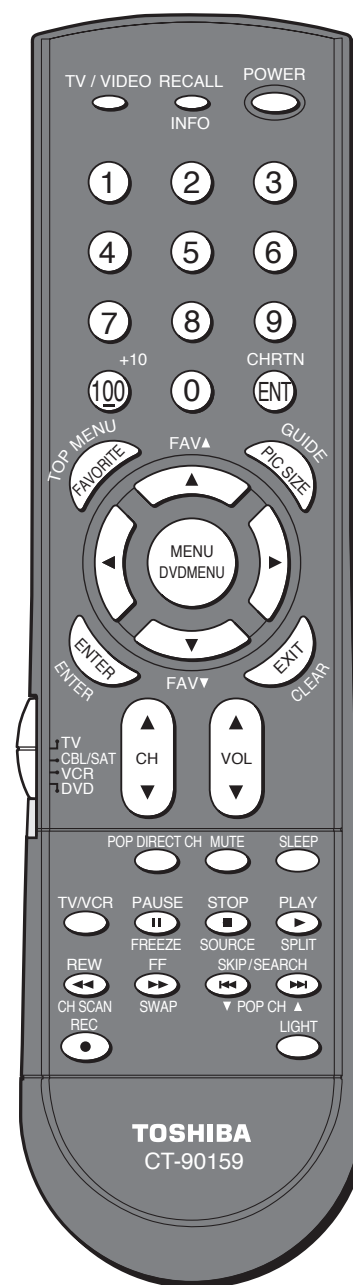

Note:

The error message "Not Available" will appear if you press a key for a function that is not available.

Introduction

Connecting your TV

Using the Remote Control

Setting up your TV

Using the TV's Features

Appendix

Index

Setting up your TV

Learning about the menu system

After you have installed the batteries and programmed the remote control, you will need to set some preferences on the TV using the menu system. You can access the menu system using the buttons on your TV or remote control.

1. Press MENU to display the menu system.
2. Press ◀ (◀) or ▶ (▶) to select a menu.
3. Press ▲ (▲) or ▼ (▼) select an item.
4. Press ◀ (◀) or ▶ (▶) to select or adjust a setting.

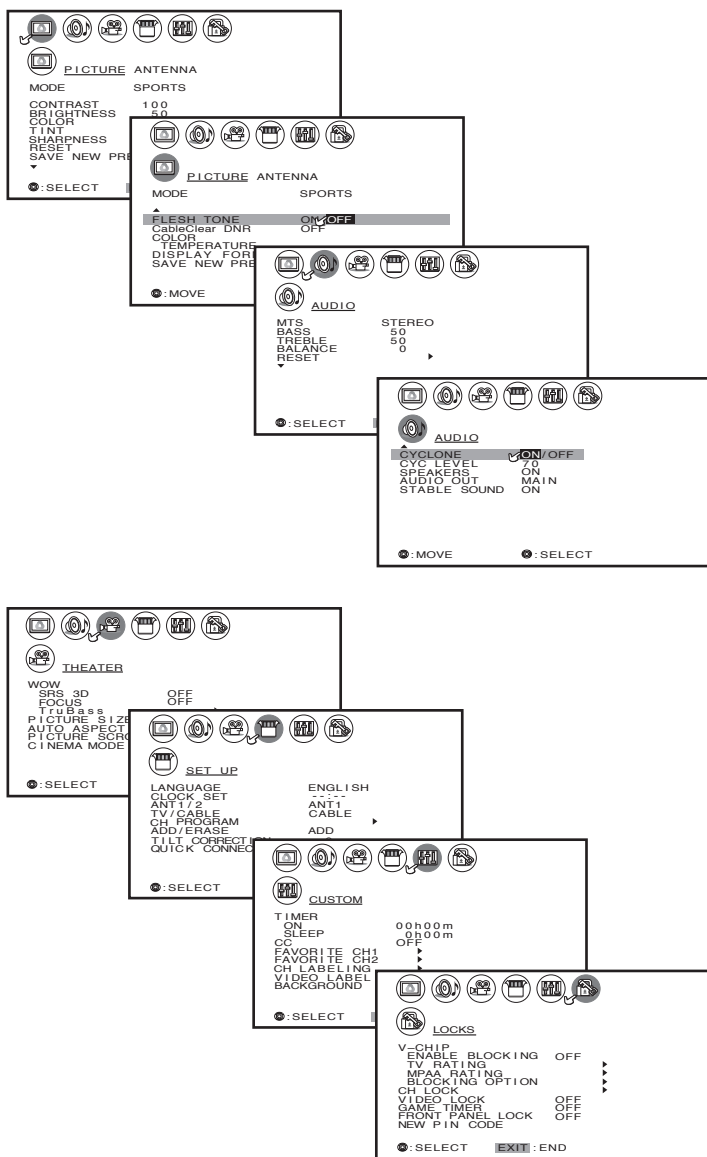

- Press ENTER to activate the function settings in the menus.
- The main menu display will disappear automatically if you do not make a selection within 15 seconds. If you want to close all the on-screen displays instantly, press EXIT.

Note regarding Quick Connect Guide

The **Quick Connect Guide** automatically appears on-screen the first time the TV is turned on. This feature provides on-screen instructions to guide you through initial setup of your TV.

See page 23 for details.

To stop the **Quick Connect Guide**, either press EXIT or turn off the TV.

TV front panel

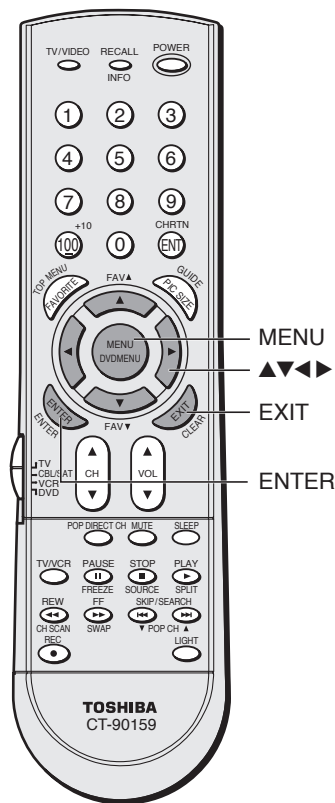
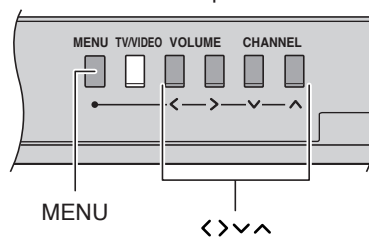

Note:

You can change the background of the menu. See page 48 for details.

Changing the on-screen display language

You can choose from three different languages (English, French and Spanish) for the on-screen display of adjustment menus and messages.

To select a language:

1. Press MENU, and then press ◀ (◀) or ▶ (▶) until the SET UP menu appears.
2. Press ▲ (▲) or ▼ (▼) to highlight LANGUAGE.

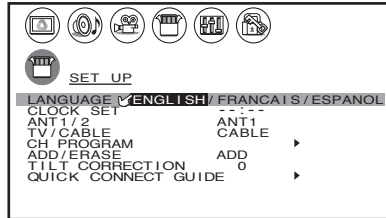

3. Press ◀ (◀) or ▶ (▶) to highlight your desired language.

Selecting the antenna input

You can connect to two different antenna input sources (ANT 1 or ANT 2).

To select the antenna input using the menu system:

1. Press MENU, and then press ◀ (◀) or ▶ (▶) to highlight the SET UP menu.
2. Press ▲ (▲) or ▼ (▼) to highlight ANT 1/2.

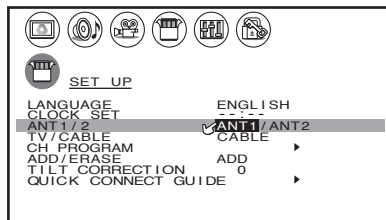

3. Press ◀ (◀) or ▶ (▶) to highlight either ANT 1 or ANT 2, depending on the antenna terminal you wish to use.

To select the antenna input using the TV/VIDEO button:

1. Press the TV/VIDEO button on the remote control or TV (see illustrations below). The current signal source displays in purple.
2. Continue pressing the TV/VIDEO button to select ANT 1 or ANT 2.

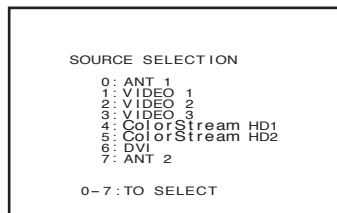

Pressing TV/VIDEO on the remote control displays the current signal source (press TV/VIDEO again or 0-7 to change)

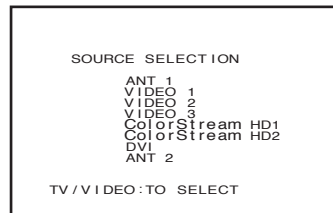

Pressing TV/VIDEO on the TV changes the current signal source

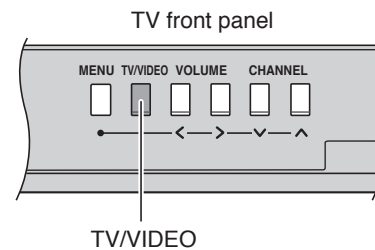
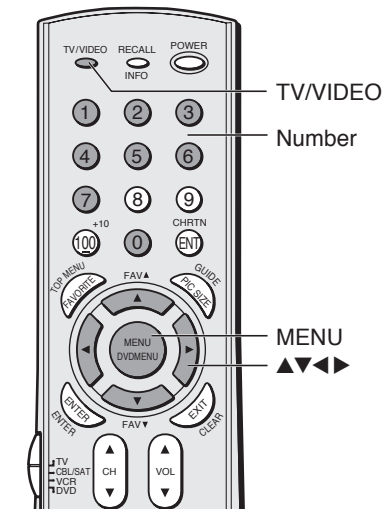
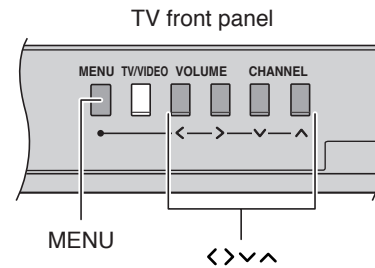

Please note the following regarding the DVI source selection:

This TV is not intended for connection to and should not be used with a PC (personal computer). See "Connecting a device to the DVI/HDCP input" on page 13 for details.

Programming channels into the channel memory

When you press Channel ▲ (▲) or ▼ (▼) on the TV or remote control, your TV will stop only on the channels stored in the channel memory.

Follow the steps below and on the next page to program all active channels into the memory.

Programming channels automatically

Your TV can automatically detect all active channels in your area and store them in the channel memory. After the channels are stored automatically, you can manually add or erase individual channels (see “Adding and erasing channels manually,” below).

To program channels automatically:

1. Press MENU, and then press ◀ (◀) or ▶ (▶) until the SET UP menu appears.
2. Press ▲ (▲) or ▼ (▼) until TV/CABLE is highlighted.
3. Press ◀ (◀) or ▶ (▶) to highlight either TV or CABLE, depending on which you use. If you use an antenna, highlight TV; if you use cable, highlight CABLE.

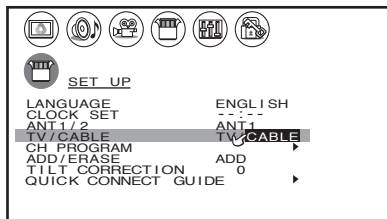

4. Press ▼ (▼) to select CH PROGRAM.

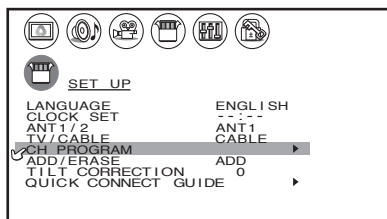

5. Press ◀ (◀) or ▶ (▶) to start channel programming. The TV will automatically cycle through all the TV or Cable channels (depending on which you selected), and store all active channels in the channel memory.

While the TV is cycling through the channels, the message “Programming Now—Please Wait” appears.

6. When channel programming is complete, the message “Completed” appears.
7. Press Channel ▲ (▲) or ▼ (▼) to view the programmed channels.

Adding and erasing channels manually

After you have programmed the channels automatically, you can manually add or erase specific channels.

To add or erase channels:

1. Select the channel you want to add or erase. If you are adding a channel, you must select the channel using the Channel Number buttons.
2. Press MENU, and then press ◀ (◀) or ▶ (▶) until the SET UP menu appears.

Note:

To tune the TV to a channel not programmed in the channel memory, you must use the Channel Number buttons on the remote control.

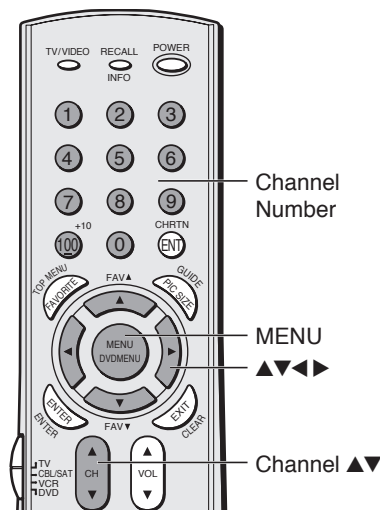

TV front panel

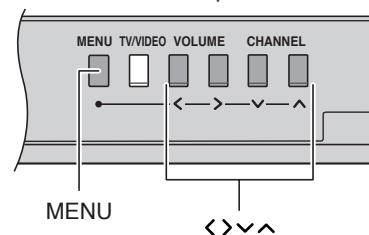



3. Press ▲ (▲) or ▼ (▼) to highlight ADD/ERASE.

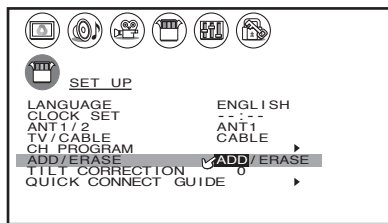

4. Press ◀ (◀) or ▶ (▶) to select ADD or ERASE, depending on the function you want to perform.

5. Repeat steps 1-4 for other channels you want to add or erase.

Using the Quick Connect Guide

The Quick Connect Guide automatically starts the first time the TV is turned on. This feature provides on-screen instructions to guide you through setting up your TV.

To manually start the Quick Connect guide:

1. Press MENU, and then press ◀ or ▶ until the SET UP menu appears.
2. Press ▲ or ▼ to highlight "QUICK CONNECT GUIDE."

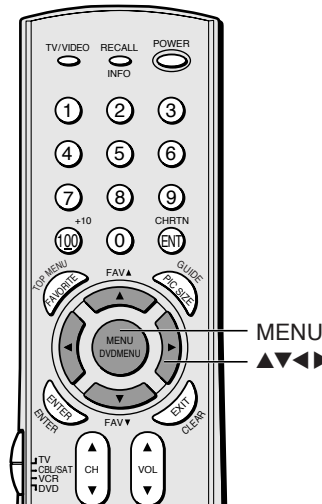
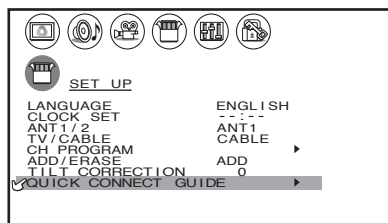

3. Press ◀ or ▶ to enter the Quick Connect Guide mode. Advance the setup according to the guide displayed on the screen. You can set up the following items.

Note:

To stop the Quick Connect Guide, press EXIT or turn off the TV.

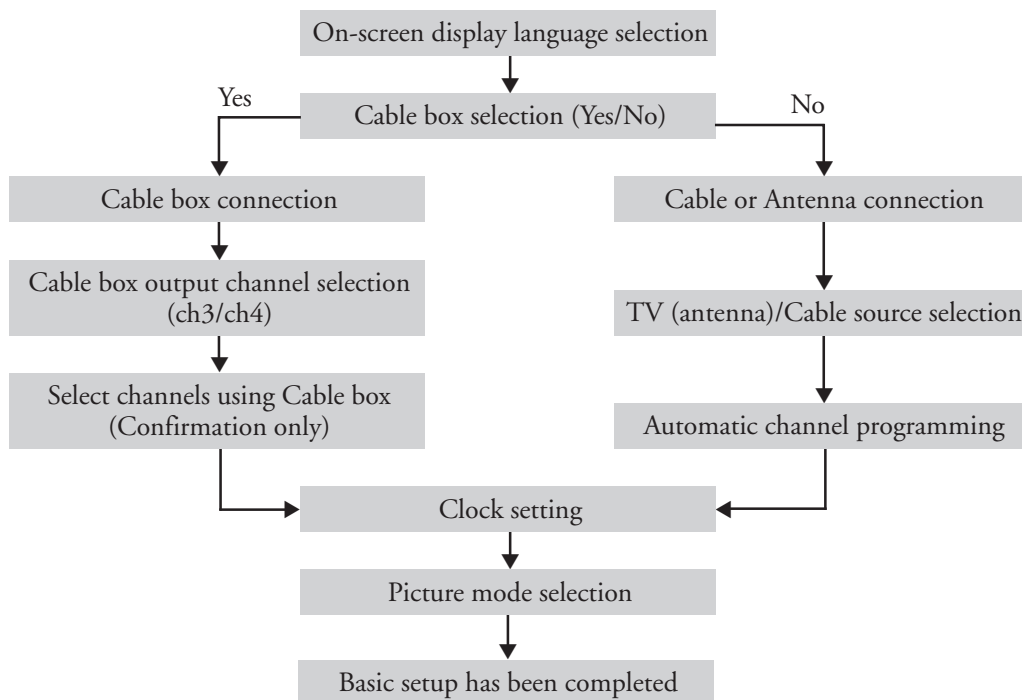

Changing channels

To change to a specific channel (programmed or unprogrammed):

Press the Channel Number buttons (0–9 and 100).

For channels 100 and higher, press the 100 button, and then the next two numbers. For example, to select channel 125, press 100, 2, 5.

To change to the next programmed channel:

Press Channel ▲ or ▼ on the TV or remote control.

Changing channels using SpeedSurf

To use SpeedSurf to change to a specific programmed channel:

1. Press and hold Channel ▲ or ▼ for about one second. The TV will enter the SpeedSurf mode.

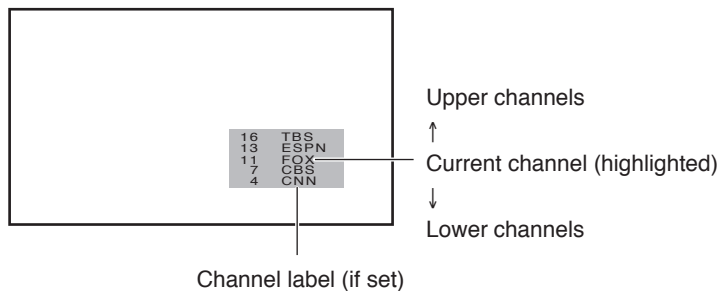

2. Repeatedly press or hold Channel ▲ or ▼ while the SpeedSurf mode is on-screen to scroll the channel list. Release the button to display the highlighted channel.

Adjusting the tilt correction feature

When you install the TV or change the direction of the TV, the picture may become tilted because of the terrestrial magnetism. If so, the following adjustment should be made for the best possible picture.

To adjust the tilt correction:

1. Press MENU, then press ◀ or ▶ until the SET UP menu appears.
2. Press ▲ or ▼ to highlight TILT CORRECTION.
3. Press ◀ or ▶ to correct any tilt of the picture (from +10 to –10).

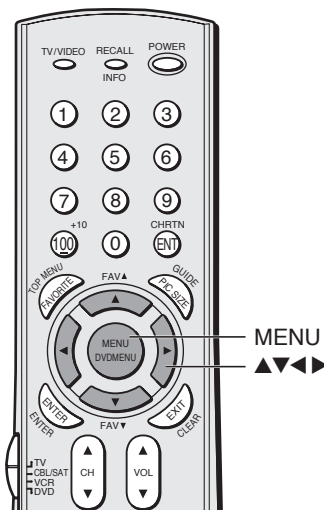
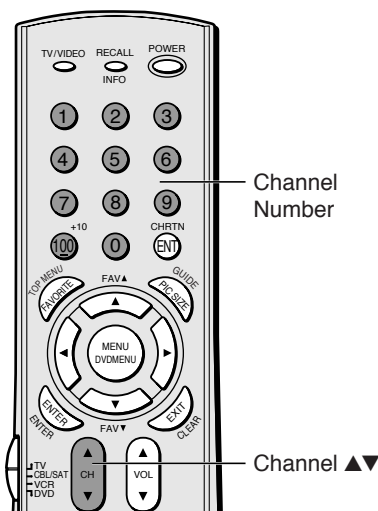
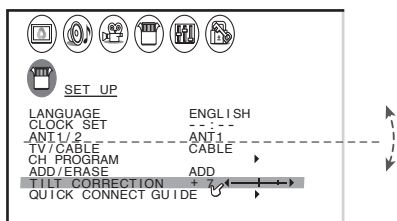

Using the TV's features

Adjusting the channel settings

Switching between two channels using Channel Return

The Channel Return feature allows you to switch between two channels without entering an actual channel number each time.

1. Select the first channel (or video mode) you want to view.
2. Select a second channel using the Channel Number buttons (0–9, 100).
3. Press CH RTN. The previous channel will display.

Each time you press CH RTN, the TV will switch back and forth between the last two channels that were selected.

Switching between two channels using SurfLock™

The SurfLock™ feature temporarily “memorizes” one channel in the CH RTN button, so you can return to that channel quickly from any other channel by pressing CH RTN.

To memorize a channel in the CH RTN button:

1. Select the channel you want to program into the CH RTN button.
2. Press and hold CH RTN for about 2 seconds until the message “Channel Memorized” appears (flashing) on the screen. The channel has been programmed into the CH RTN button (SurfLock memory).
3. Continue to change channels.
4. Press CH RTN. The memorized channel will be selected.

The TV will return to the memorized channel one time only. Once you press CH RTN and then change channels again, the SurfLock memory will be cleared and the button will function as Channel Return, by switching back and forth between the last two channels that were selected.

Programming your favorite channels

You can preset up to 7 of your favorite channels each for FAVORITE CH1 and FAVORITE CH2 modes using the Favorite Channel Programming feature. Because this feature scans through only your favorite channels, it allows you to skip other channels you do not normally watch.

To program your favorite channels:

1. Press MENU, and then press ◀ or ▶ until the CUSTOM menu appears.
2. Press ▲ or ▼ to highlight FAVORITE CH1 or FAVORITE CH2.

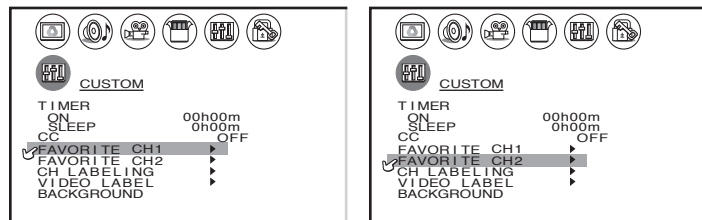

(continued on next page)

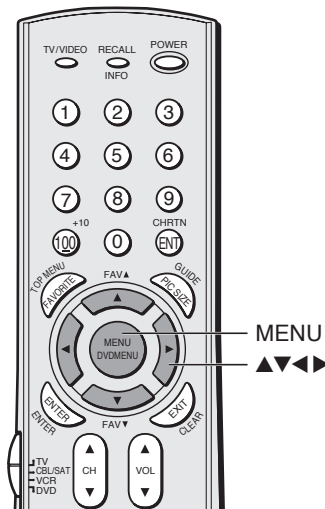
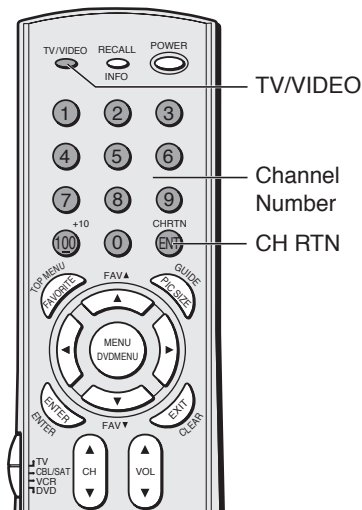

Introduction

Connecting your TV

Using the Remote Control

Setting up your TV

Using the TV's Features

Appendix

Index

- Press ◀ or ▶ to display the FAVORITE CH1 menu, for example. CH INPUT will be highlighted.

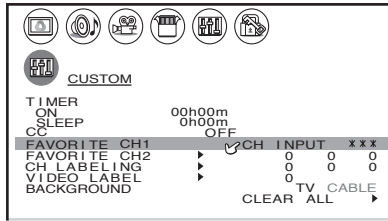

- Press the Channel Number buttons to enter one of your favorite channels.
- Press ENTER.
- Repeat steps 4 and 5 for other channels.

To select your favorite channels:

Press FAV ▼ or ▲.

To quickly scan through your favorite channels in a seven-picture multi-window:

Press FAVORITE (see page 35).

To clear a favorite channel:

- Press MENU, and then press ◀ or ▶ until the CUSTOM menu appears.
- Press ▲ or ▼ to highlight FAVORITE CH2, for example.
- Press ◀ or ▶ to display the FAVORITE CH2 menu.

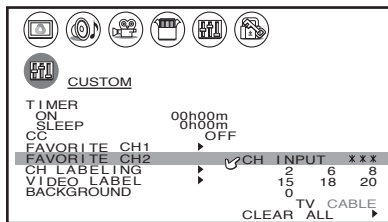

- Press ▲▼◀▶ to highlight the channel you want to clear, then press ENTER.

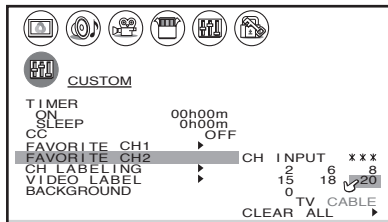

- Repeat step 4 for other channels.

To clear all favorite channels at once:

Press ▲ or ▼ to highlight CLEAR ALL in step 4 above, and then press ◀ or ▶ to clear all favorite channels at once.

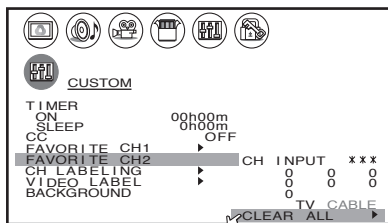

Note:

- The FAV ▲▼ buttons operate as MENU ▲▼ buttons when a menu is on-screen.
- The favorite channel feature is not available in ANT2 mode.

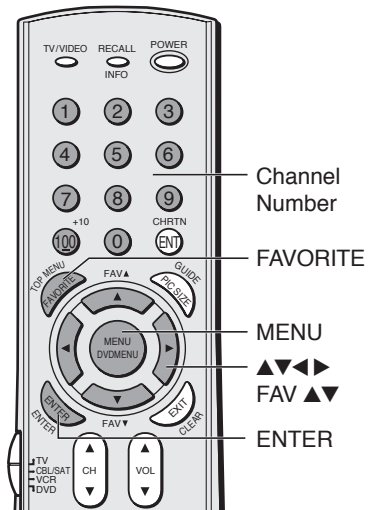



Labeling channels

Channel labels appear above the on-screen channel number display each time you turn on the TV, change a channel, or press **RECALL**. You can choose any four characters to identify a channel. You can assign labels to a maximum of 32 channels.

To create channel labels:

1. Press **MENU**, and then press **◀** or **▶** until the **CUSTOM** menu appears.
2. Press **▲** or **▼** to highlight **CH LABELING**.
3. Press **◀** or **▶** to display the **CH LABELING** menu. **CH INPUT** will be highlighted.

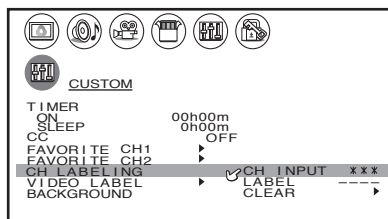

4. Press the Channel Number buttons to select a channel you want to label.

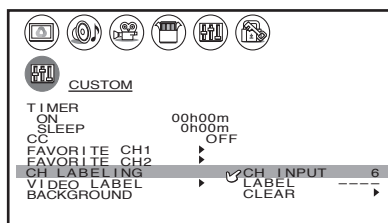

5. Press **▼** to highlight **LABEL**.
6. Press **◀** or **▶** repeatedly to select a character for the first space, and then press **ENTER**.

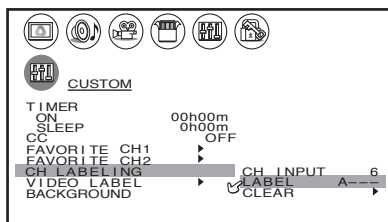

7. Repeat step 6 to enter the rest of the characters.
If you would like a blank space in the label name, you must choose an empty space from the list of characters. Otherwise, a dash “-” will appear in that space.
8. Repeat steps 4–7 for other channels.

To erase channel labels:

1. Press **MENU**, and then press **◀** or **▶** until the **CUSTOM** menu appears.
2. Press **▲** or **▼** to highlight **CH LABELING**.
3. Press **◀** or **▶** to display the **CH LABELING** menu.
4. Select the channel you want to clear with the Channel Number buttons.

(continued on next page)

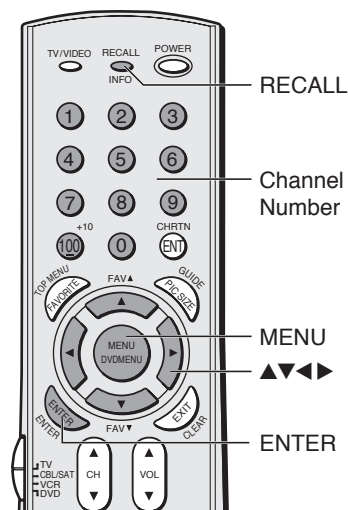

Introduction

Connecting your TV

Using the Remote Control

Setting up your TV

Using the TV's Features

Appendix

Index

5. Press ▼ to highlight CLEAR.
6. Press ◀ or ▶ to erase the channel label.
7. Repeat steps 4–6 to erase other channel labels.

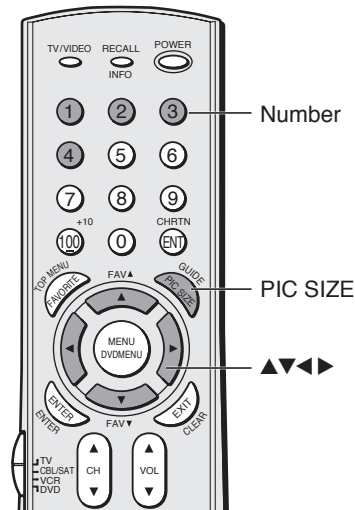
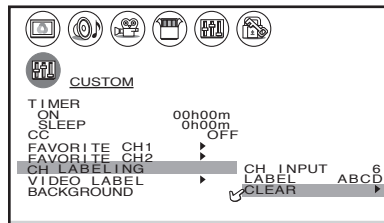

Viewing the wide-screen picture formats

You can view programs that have the conventional TV picture format (4:3 aspect ratio) and the wide-screen format (16:9 aspect ratio) in a variety of picture sizes.

Selecting the picture size

Repeatedly press PIC SIZE to select either Natural, Theater Wide 1, Theater Wide 2, Theater Wide 3, or Full picture size, as described below.

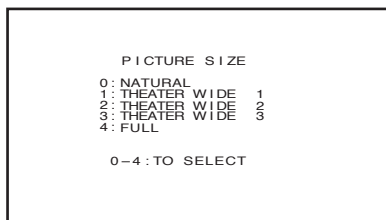

While the above menu is on the screen, you can select the desired picture size by pressing the corresponding number button.

- 480i/480p signal source : 0-4
- 1080i/720p signal source : fixed to 0 (Natural)

Receiving 480i/480p signal source

Natural

The Natural picture size displays the picture in the conventional 4:3 aspect ratio, with bars at the left and right.

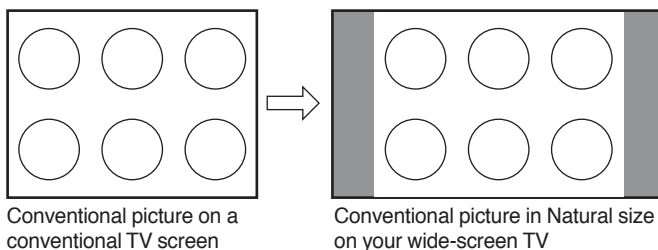

Conventional picture on a conventional TV screen

Conventional picture in Natural size on your wide-screen TV

Full

This mode is to enjoy the wide-screen format (16:9 aspect ratio).

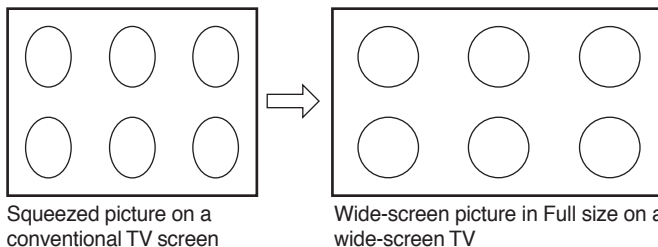

Squeezed picture on a conventional TV screen

Wide-screen picture in Full size on a wide-screen TV

NOTICE OF POSSIBLE ADVERSE EFFECTS ON TV PICTURE TUBE

Avoid displaying stationary images on your TV screen for extended periods of time. Fixed (non-moving) images (such as still PIP/POP windows or black/gray bars in wide-screen picture or PIP/POP formats) can become permanently engrained in the picture tube. **This type of damage is NOT COVERED BY YOUR WARRANTY** because it is the result of misuse. See item 33 on page 4.

Note:

If you select the Theater Wide picture mode for conventional size programs, parts of the picture at the top and bottom of the screen may be hidden.

Note:

If you see the Full picture size for conventional TV picture format (4:3 aspect ratio), the picture will be horizontally stretched.



Theater Wide 1

- The picture is non-uniformly enlarged—the center of the picture remains close to its true proportion, but the left and right edges are stretched wider to fill the screen.

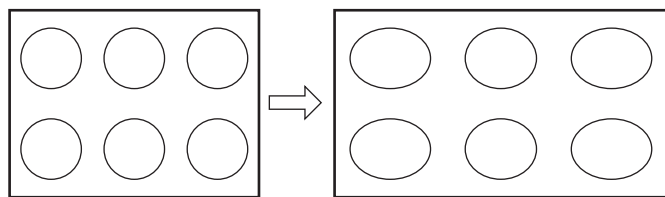

Conventional picture on a conventional TV screen

Theater Wide 1

Theater Wide 2

- The entire picture is uniformly enlarged—it is stretched the same amount both wider and taller (retains its true proportion).
- Part of the picture at the top and bottom is hidden. To view the hidden areas, see “Scrolling the Theater Wide picture” on page 30.

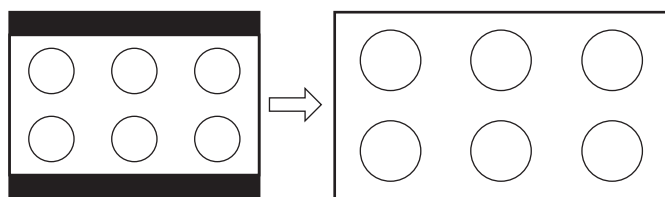

Wide-screen picture on a conventional TV screen (also known as the “letter box” format, with bar at top and bottom)

Theater Wide 2

Theater Wide 3

- The picture is non-uniformly enlarged—it is stretched wider to fill the width of the screen, but only slightly stretched taller.
- A small part of the picture at the top and bottom is hidden. To view the hidden areas (Subtitle, Caption, etc), see “Scrolling the Theater Wide picture” on page 30.

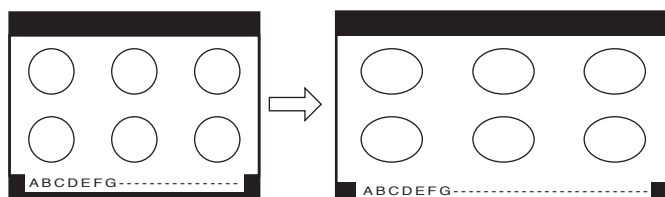

Wide-screen picture on a conventional TV screen with subtitles

Theater Wide 3

Note:

You can also change the Theater Wide 1, 2, 3 using the menu system.
Select PICTURE SIZE in the THEATER menu.

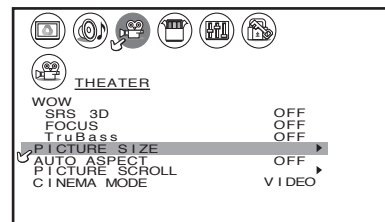

NOTICE OF POSSIBLE ADVERSE EFFECTS ON TV PICTURE TUBE

Avoid displaying stationary images on your TV screen for extended periods of time. Fixed (non-moving) images (such as still PIP/POP windows or black/gray bars in wide-screen picture or PIP/POP formats) can become permanently engrained in the picture tube. **This type of damage is NOT COVERED BY YOUR WARRANTY** because it is the result of misuse. See item 33 on page 4.

Using the special functions to change the size of the displayed image (i.e. changing the height/width ratio) for the purpose of public display or commercial gain may infringe on copyright laws.

Scrolling the Theater Wide picture (Theater Wide 2 and 3 only)

1. Press PIC SIZE to select the Theater Wide 2 or 3 mode.
2. Press MENU, and then press ◀ or ▶ until THEATER menu appears.
3. Press ▲ or ▼ to highlight PICTURE SCROLL.

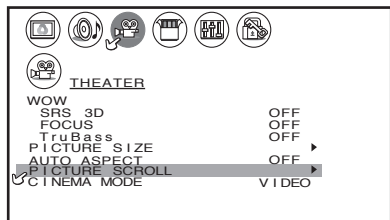

4. Press ◀ or ▶ to display the Scroll Adjustment mode.

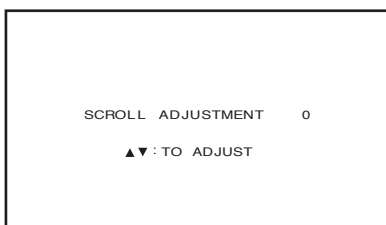

5. Press ▲ or ▼ to adjust the vertical position of the picture.
 - Normal (center) position

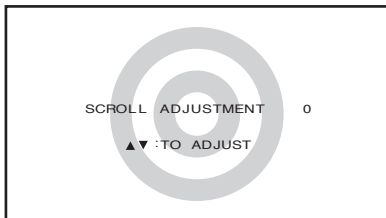

- To raise the picture, press ▲.

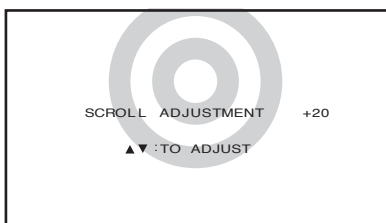

- To lower the picture, press ▼.

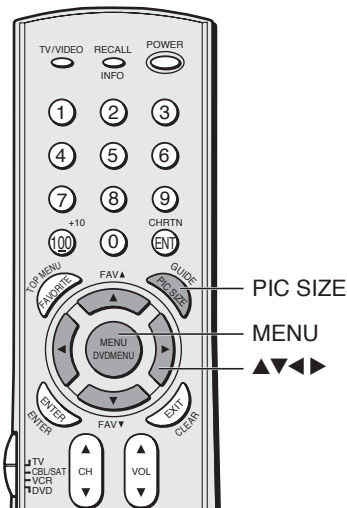
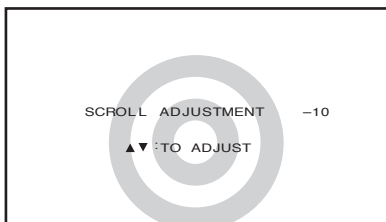

Note:

You can scroll the picture in Theater Wide 2 and Theater Wide 3 only. The scroll amounts are as follows:

- 480i signal source:
 - Wide 1 : Not adjustable
 - Wide 2 : +20 to -10
 - Wide 3 : +20 to -10
- 480p signal source:
 - Wide 1 : Not adjustable
 - Wide 2 : +20 to -10
 - Wide 3 : +20 to -10

NOTICE OF POSSIBLE ADVERSE EFFECTS ON TV PICTURE TUBE

Avoid displaying stationary images on your TV screen for extended periods of time. Fixed (non-moving) images (such as still PIP/POP windows or black/gray bars in wide-screen picture or PIP/POP formats) can become permanently engrained in the picture tube. **This type of damage is NOT COVERED BY YOUR WARRANTY** because it is the result of misuse. See item 33 on page 4.



Using the auto aspect feature

When receiving 480i signal, the TV will automatically change the picture size by reading aspect information (ID-1 data) from the input signal. If the signal does not include aspect information (ID-1 data), the picture size mode you set (pages 28–29) is selected.

To turn on the auto aspect:

1. Press MENU, and then press ◀ or ▶ until the THEATER menu appears.

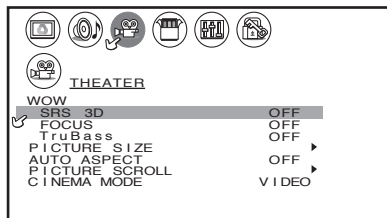

2. Press ▲ or ▼ to highlight AUTO ASPECT, and then press ◀ or ▶ to select ON.

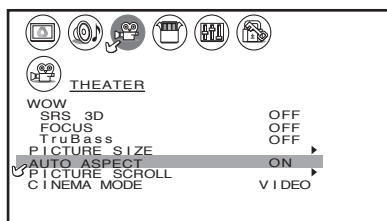

Aspect information (ID-1 data)	Picture size to be selected
4:3 Normal	Natural
16:9 Full	Full
4:3 Letter box	Theater Wide 2
Not Defined	User-set mode

Selecting the cinema mode

When you view a DVD movie (3:2 pulldown processed) from a DVD player connected to the ColorStream (component video) or DVI/HDCP inputs on the TV, smoother and more natural motion can be obtained by setting the CINEMA MODE to FILM (auto).

To set the CINEMA MODE to FILM (auto):

1. Press MENU, and then press ◀ or ▶ until the THEATER menu appears.
2. Press ▲ or ▼ to highlight CINEMA MODE.
3. Press ◀ or ▶ to select FILM (auto).

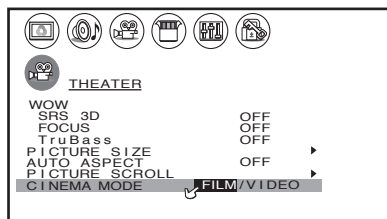

To set the CINEMA MODE to VIDEO (off):

Press ◀ or ▶ to select VIDEO in step 3 above.

Note:

- The auto aspect feature does not operate for the antenna (cable) and DVI input sources.
- The picture size selection is possible even when the auto aspect is active (ON). In this case, the picture size you selected is valid until the input source is changed or auto aspect is turned ON again.
- If the signal includes incorrect aspect information (ID-1 data), the picture will deteriorate and auto aspect may not operate correctly. In such a case, turn OFF the auto aspect.

NOTICE OF POSSIBLE ADVERSE EFFECTS ON TV PICTURE TUBE

Avoid displaying stationary images on your TV screen for extended periods of time. Fixed (non-moving) images (such as still PIP/POP windows or black/gray bars in wide-screen picture or PIP/POP formats) can become permanently engrained in the picture tube. **This type of damage is NOT COVERED BY YOUR WARRANTY** because it is the result of misuse. See item 33 on page 4.

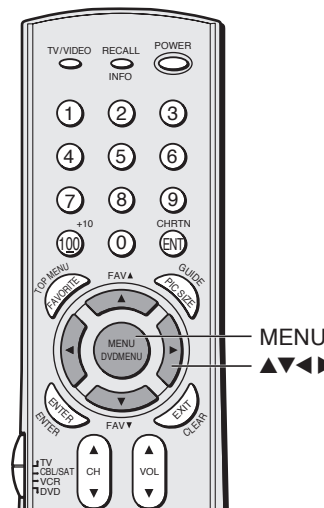

Using the POP double-window feature

The POP (picture-out-picture) feature splits the screen into a double window that allows you to watch two programs at the same time. The POP program can come from a TV broadcast or an external source, such as a VCR.

To display a TV broadcast in the POP window:

1. Press SPLIT to display the POP window.

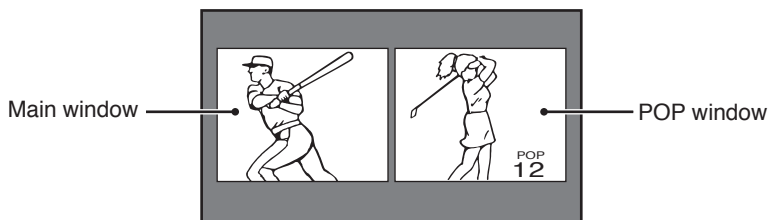

2. Select POP channels in the following two ways:

- To change to a specific channel, press POP DIRECT CH. While "POP" is on the screen, press the Channel Number buttons (0-9 and 100).
- To change to the next programmed channel, press POP CH ▼▲.

If the V-CHIP feature is active and you try to watch a TV program that exceeds your set rating limits, the program will be blocked (see "Using the V-CHIP menu" on page 37).

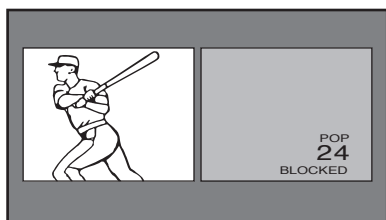

To display a picture from an external source in the POP window:

1. Connect the external source equipment (see "Connecting your TV" on page 7).
2. Select the TV program you want to watch in the main window.
3. Press SPLIT to display the POP window.
4. Repeatedly press SOURCE to select the input source for the POP window (VIDEO 1, VIDEO 2, VIDEO 3, ColorStream HD1, or ColorStream HD2 only; you cannot select DVI in POP mode). The current source will display in purple.
5. You can play a tape as the POP picture, or select a channel for the POP window using the VCR's channel keys.

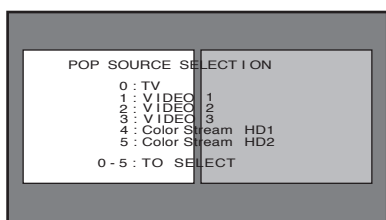

While the above menu is on the screen, you can select the desired signal input source by pressing the corresponding number button (0-5).

To close the POP window:

Press SPLIT again or EXIT.

Note:

- The SPLIT buttons on the remote control operate the TV's POP features.
- You cannot access POP features when viewing DVI input.
- You cannot display the ANT-2 signal source in the POP window.
- You can choose to output the sound of either the main or POP program from the AUDIO OUT (see "Selecting the Audio OUT sound" on page 52).

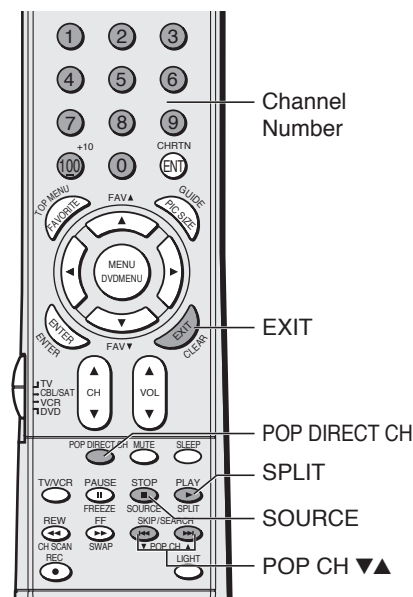

NOTICE OF POSSIBLE ADVERSE EFFECTS ON TV PICTURE TUBE

Avoid displaying stationary images on your TV screen for extended periods of time. Fixed (non-moving) images (such as still PIP/POP windows or black/gray bars in wide-screen picture or PIP/POP formats) can become permanently engrained in the picture tube. **This type of damage is NOT COVERED BY YOUR WARRANTY** because it is the result of misuse. See item 33 on page 4.



Switching the main and POP pictures

Press SWAP while you are using the POP feature to switch the main and POP pictures.

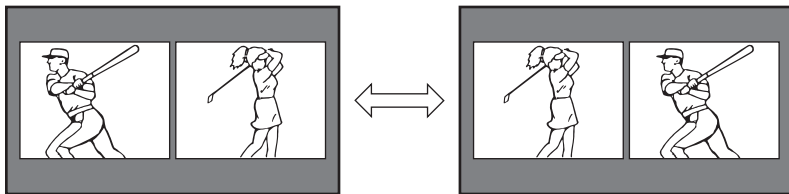

Freezing the POP picture

1. Press FREEZE while the POP is not on the screen. The POP window will appear with a still picture.
2. Press FREEZE again to renew the still picture.

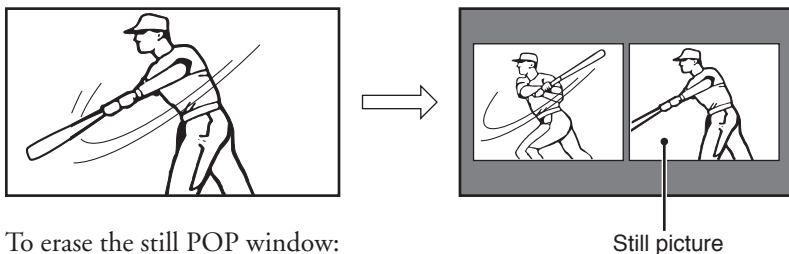

To erase the still POP window:
Press EXIT.

Adjusting the size of the double-window

When the input signals of the main and POP pictures are 480i, you can adjust the size of each window. Repeatedly press ◀ or ▶ to change the size (in 9 steps).

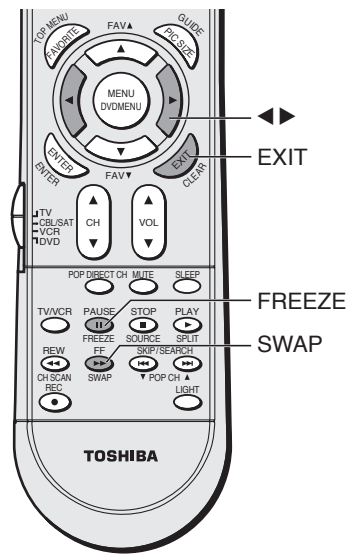
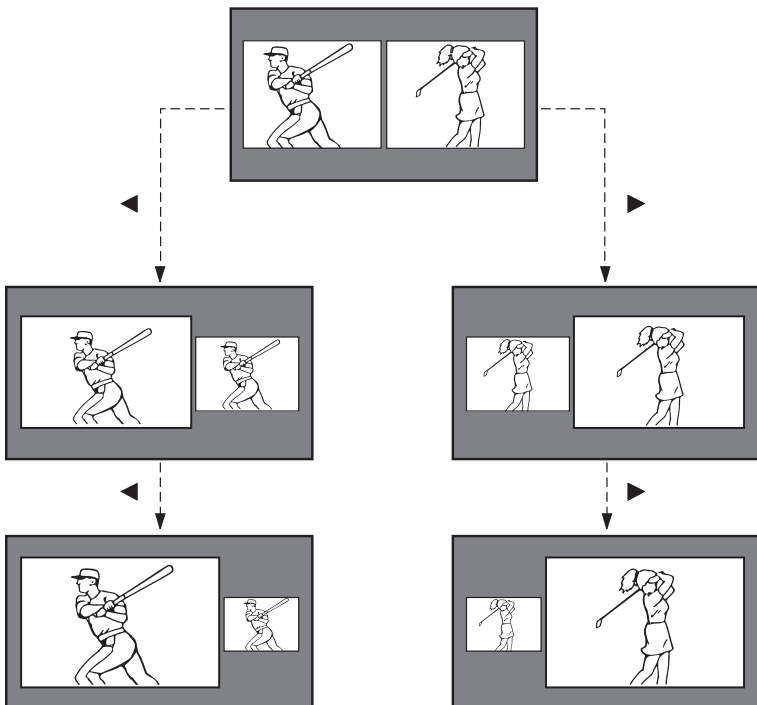

Note:

You can adjust the size of the double-window for 480i signals only. If you try to adjust the double-window size when viewing another signal, the message "Not available" will appear on the screen.

NOTICE OF POSSIBLE ADVERSE EFFECTS ON TV PICTURE TUBE

Avoid displaying stationary images on your TV screen for extended periods of time. Fixed (non-moving) images (such as still PIP/POP windows or black/gray bars in wide-screen picture or PIP/POP formats) can become permanently engrained in the picture tube. **This type of damage is NOT COVERED BY YOUR WARRANTY** because it is the result of misuse. See item 33 on page 4.

POP double-window aspect ratio

The double-window feature displays each picture according to its input signal with various aspect ratios as illustrated below:



Using the programmed channel search function

You can use the programmed channel search function to quickly scan your programmed channels (see "Programming channels into the channel memory" on page 22).

1. Press CH SCAN.
The TV automatically enters POP mode, and begins a seven-picture scan of your programmed channels in the POP window.

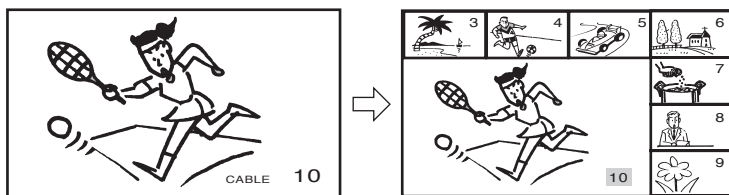

2. Press ▲▼◀▶ to select one of the seven pictures (becomes a moving picture). The main picture is always moving.
3. Press ENTER to display the channel you selected in step 2 as a normal picture.

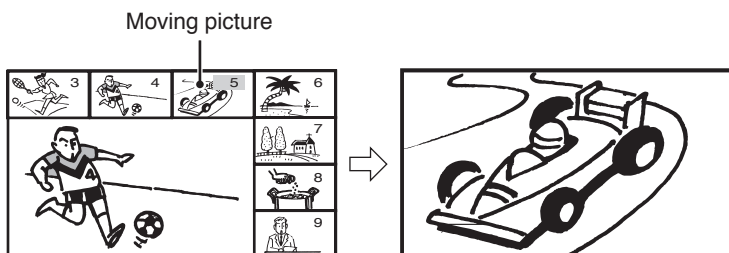

Note:

- The auto aspect feature (page 30) does not operate in the double-window mode.
- Aspect ratio is the ratio of width to height of the picture.

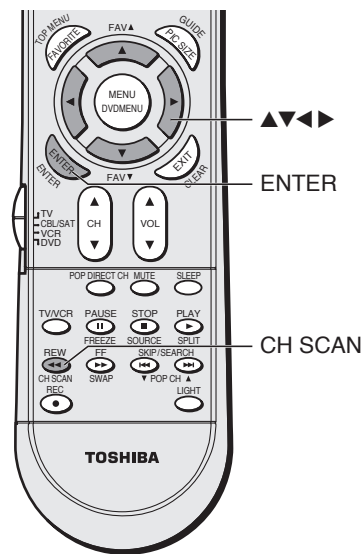

Note:

- This feature does not operate in DVI mode.
- The aspect ratio of all main and POP windows are 16:9.

NOTICE OF POSSIBLE ADVERSE EFFECTS ON TV PICTURE TUBE

Avoid displaying stationary images on your TV screen for extended periods of time. Fixed (non-moving) images (such as still PIP/POP windows or black/gray bars in wide-screen picture or PIP/POP formats) can become permanently engrained in the picture tube. **This type of damage is NOT COVERED BY YOUR WARRANTY** because it is the result of misuse. See item 33 on page 4.



Using the favorite channel search function

You can use the favorite channel search function to quickly scan your favorite channels (see “Programming your favorite channels” on page 25).

1. Press FAVORITE.
The TV automatically enters POP mode, and begins a seven-picture scan of your favorite channels.

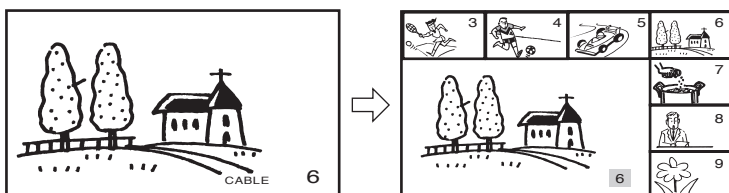

2. Press ▲▼◀▶ to select one of the seven pictures (becomes a moving picture). The main picture is always moving.
3. Press ENTER to display the channel you selected in step 2 as a normal picture.

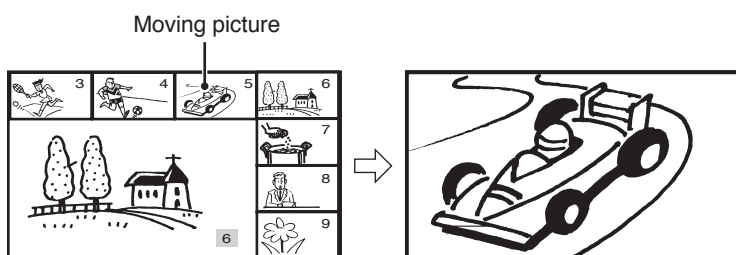

Every time you press FAVORITE, the POP window scans your favorite channels in the following order:

FAVORITE CH1 — FAVORITE CH2 — Off

About the auto favorite feature

If your TV is in the program lock mode, after 4 seconds the TV starts the auto favorite channel search function. See page 39 for details.

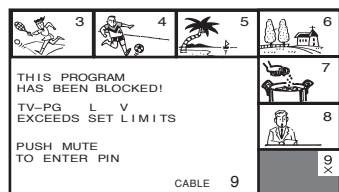

- Blocking Reset status:

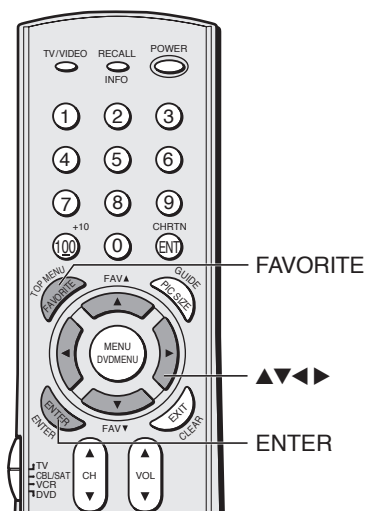

Note:

- This feature does not operate in DVI mode.
- The aspect ratio of all main and POP windows are 16:9.

NOTICE OF POSSIBLE ADVERSE EFFECTS ON TV PICTURE TUBE

Avoid displaying stationary images on your TV screen for extended periods of time. Fixed (non-moving) images (such as still PIP/POP windows or black/gray bars in wide-screen picture or PIP/POP formats) can become permanently engrained in the picture tube. **This type of damage is NOT COVERED BY YOUR WARRANTY** because it is the result of misuse. See item 33 on page 4.

Using the LOCKS menu

The LOCKS menu includes the V-CHIP, CH LOCK, VIDEO LOCK, and NEW PIN CODE functions. You can use these functions after entering the correct PIN code.

Entering the PIN code

1. Press MENU, and then press ◀ or ▶ until the LOCKS menu appears.

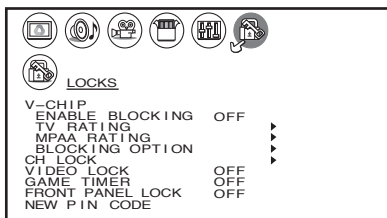

2. Press ▲ or ▼ to display the PIN code entering mode.

Set your 4-digit code by pressing the Number buttons (0-9), and then press ENTER.

- Blocking Active status: (when the PIN code is already stored)
Press the Number buttons (0-9) to enter your 4-digit PIN code, and then press ENTER.



If the wrong PIN code is entered, the message "Incorrect" appears. Enter the code again, and then press ENTER.

If you cannot remember your PIN code

While the PIN code entering screen is displayed, press RECALL four times within five seconds. The PIN code will be released (Blocking Reset status restored).

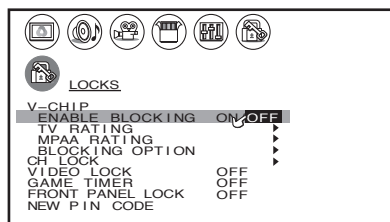

Continue to set each item following the steps on the next page.

Note:

The V-Chip function is available only for the U.S. V-Chip system. The Canadian V-Chip system is not supported.

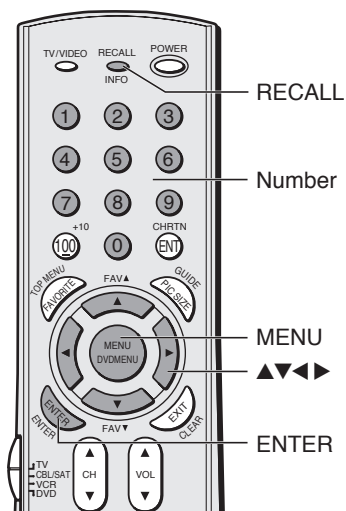

Using the V-CHIP menu

Some TV programs and movies include signals that classify the content of the program (violence, sex, dialog, language). The V-CHIP control feature in this TV detects the signals and blocks the programs according to your selections. To use this feature, perform the following setup.

ENABLE BLOCKING

1. From the LOCKS menu, select ENABLE BLOCKING.
2. Press ◀ or ▶ to select ON or OFF.
ON : To enable your setting (Lock)
OFF: To release your setting (Unlock)

Note: The CH LOCK function is not affected by the Enable Blocking setting.

TV RATING (Independent rating system for broadcasters)

1. From the LOCKS menu, select TV RATING.
2. Press ◀ or ▶ to display the TV RATING menu.
3. Press ▼ or ▲ to select an item.
4. Press ▶ to lock (display "X").
Press ◀ to unlock (display "✓").
5. Repeat steps 3 and 4 to set the next item.

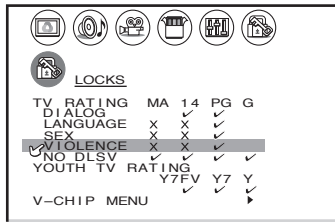

The TV age-based ratings and content themes you can lock are listed in the table below.

Ratings	Description and Content themes
MA	Mature Audience Only (This program is specifically designed to be viewed by adults and therefore may be unsuitable for children under 17.) L) Crude or indecent language S) Explicit sexual activity V) Graphic violence
14	Parents Strongly Cautioned (This program contains some material that many parents would find unsuitable for children under 14 years of age.) D) Intensely suggestive dialog L) Strong, coarse language S) Intense sexual situations V) Intense violence
PG	Parental Guidance Suggested (This program contains material that parents may find unsuitable for younger children.) D) Some suggestive dialog L) Infrequent coarse language S) Some sexual situations V) Moderate violence
G	General Audience (Most parents would find this program suitable for all ages.)
Y7, Y7FV	Directed to Older Children (This program is designed for children age 7 and above. Note: Programs in which fantasy violence may be more intense or more combative than other programs in this category are designated Y7FV.)
Y	All Children (This program is designed to be appropriate for all children.)

Note:

The V-Chip function is available only for the U.S. V-Chip system. The Canadian V-Chip system is not supported.

LOCKS menu

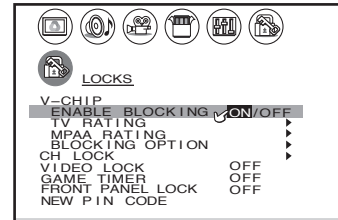

To select each item:

Press ▼ or ▲.

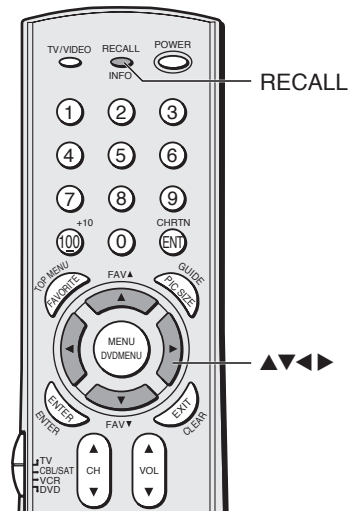

Press RECALL to display the rating of the TV program you are currently watching.

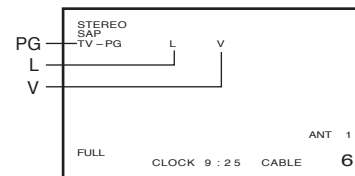

MPAA RATING (Independent rating system for movies)

1. From the LOCKS menu, select MPAA RATING.
2. Press ◀ or ▶ to display the MPAA RATING menu, then press ▼ or ▲ to highlight MPAA RATING.

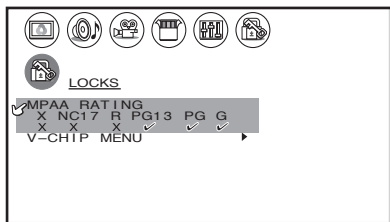

3. Press ▶ to lock ("X") or press ◀ to unlock ("✓").
- The movie ratings you can lock are described as follows:

- X : X-rated (For adults only)
- NC17: Not intended for anyone 17 and under
- R : Restricted (Under 17 requires accompanying parent or adult guardian.)
- PG13 : Parents Strongly Cautioned (Some material may be inappropriate for children under 13)
- PG : Parental Guidance Suggested (Some material may not be suitable for children)
- G : General Audience (Appropriate for all ages)

BLOCKING OPTION

1. From the LOCKS menu, select BLOCKING OPTION.
2. Press ◀ or ▶ to display the BLOCKING OPTION menu, then press ▲ or ▼ to select an item.

MPAA UNRATED:

Press ◀ or ▶ to select ON (Lock) or OFF (Unlock) for unrated programs in the MPAA rating system.

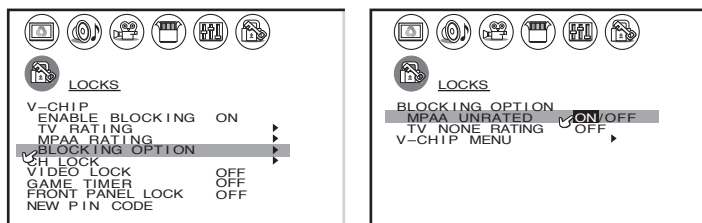

TV NONE RATING

Press ◀ or ▶ to select ON (Lock) or OFF (Unlock) for programs rated NONE in the TV PARENTAL GUIDELINES.

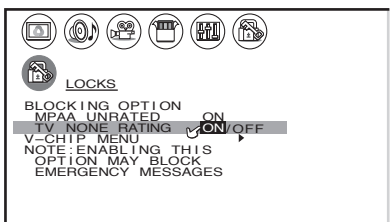

V-CHIP MENU:

Press ◀ or ▶ to return to the LOCKS menu.

LOCKS menu

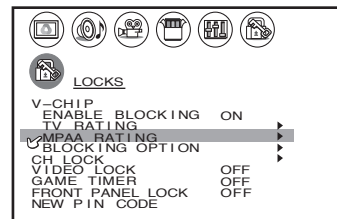

To select each item:
Press ▼ or ▲.

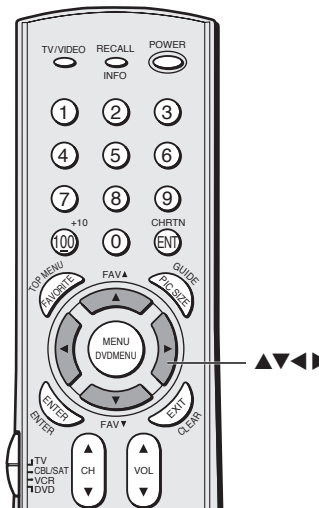

Caution:

Setting the TV None Rating to ON may block the broadcast of emergency information. The menu will display the note, "Enabling this option may block emergency messages" to warn you of this possibility.



Unlocking programs temporarily

If you try to watch a TV program that exceeds the rating limits you set, the TV enters program lock mode. After 4 seconds, the TV starts the auto favorite channel search function (see page 35). You can either unlock the program temporarily or select a non-locked program to watch.

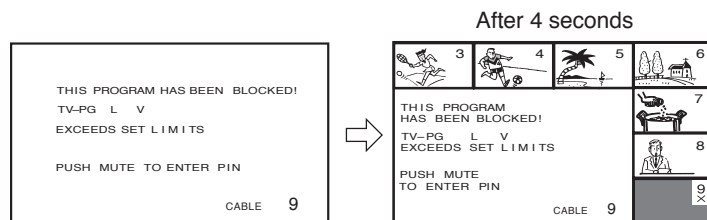

To temporarily unlock the program:

1. Press MUTE.
2. Press the Number buttons (0-9) to enter your 4-digit PIN code.

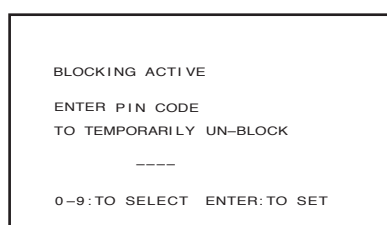

3. Press ENTER.

If the correct code is entered, the program lock mode is released and the normal picture appears.

All locking is disabled until the TV is turned off, and will be enabled when the TV is turned on again.

Locking channels

With the CH LOCK feature, you can lock specific channels. You will not be able to tune locked channels with the Channel \blacktriangle \blacktriangledown buttons or Channel Number buttons unless you clear the setting.

You can lock a maximum of nine channels.

To lock channels:

1. From the LOCKS menu, select CH LOCK.
2. Press \blacktriangleleft or \blacktriangleright to display the CH LOCK menu. CH INPUT will be highlighted.
3. Press the Channel Number buttons to enter the channel you want to lock.
4. Press ENTER.

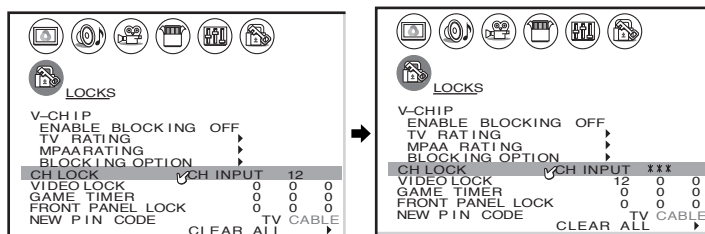

5. Repeat steps 3 and 4 for other channels.

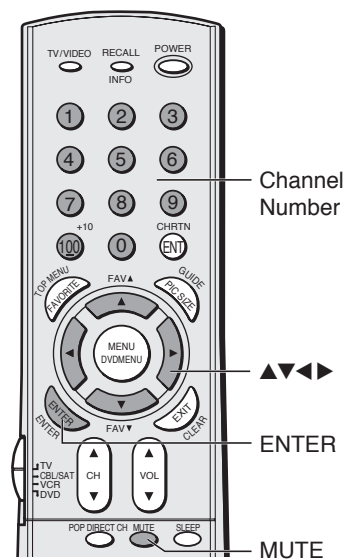

LOCKS menu

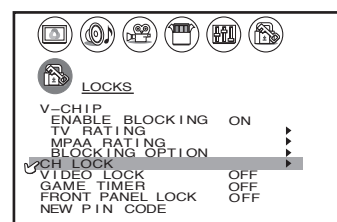

To select each item:

Press \blacktriangledown or \blacktriangle .

To unlock individual channels:

1. From the LOCKS menu, select CH LOCK.
2. Press ◀ or ▶ to display the CH LOCK menu.
3. Press ▲▼◀▶ to highlight the channel you want to unlock, then press ENTER.

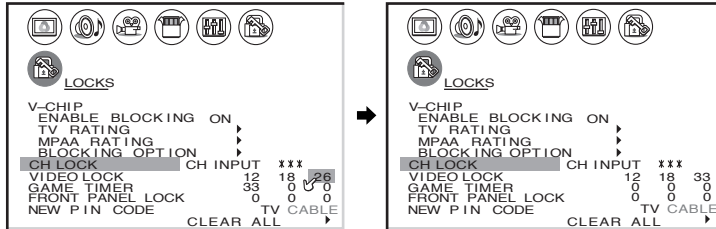

4. Repeat step 3 for other channels.

To unlock all locked channels at once:

Press ▲ or ▼ to highlight CLEAR ALL, and then press ◀ or ▶.

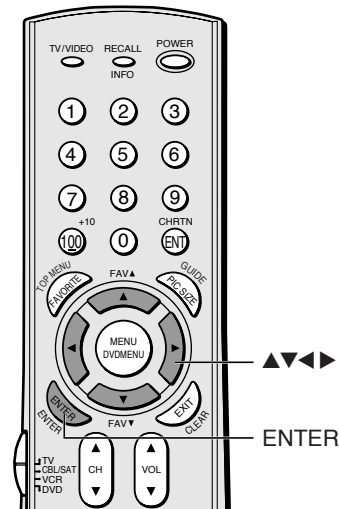
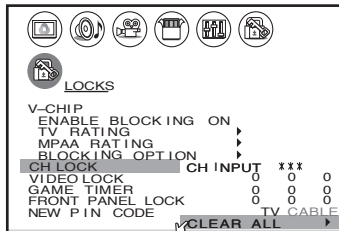

Locking video inputs

With the VIDEO LOCK feature, you can lock out the input sources (VIDEO 1, VIDEO 2, VIDEO 3, ColorStream HD1, ColorStream HD2, DVI/HDCP) and channels 3 and 4.

You will not be able to select the input sources with the TV/VIDEO button or Channel buttons unless you clear the setting.

To set up the video lock:

1. From the LOCKS menu, select VIDEO LOCK.
2. Press ◀ or ▶ to highlight the level of video locking you want (Video, Video+, or Off), as follows:
 - VIDEO : Locks VIDEO 1, VIDEO 2, VIDEO 3, ColorStream HD1, HD2, and DVI/HDCP.
 - VIDEO+ : Locks VIDEO 1, VIDEO 2, VIDEO 3, ColorStream, HD1/HD2, DVI/HDCP, and channels 3 and 4. This option should be used if you use the antenna terminal to play a video tape.

Note: Make sure the POP is not on channel 3 or 4.

OFF : Unlocks all video input sources.

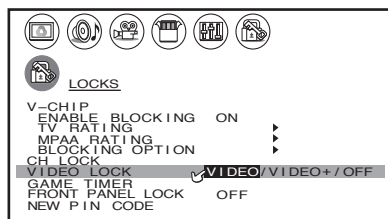



Using the game timer

You can use the game timer to set a time limit for playing a video game (30-120 minutes). When the game timer is activated, the TV enters VIDEO LOCK mode and locks out the input source for the video game device.

To set the game timer:

1. From the LOCKS menu, select GAME TIMER.
2. Press ◀ or ▶ to select the length of time until the video mode is blocked from among 30, 60, 90 and 120 minutes. When the number is highlighted, the timer will start countdown.

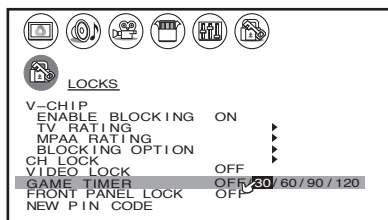

To cancel the timer:

Select OFF in step 2 above.

Using the front panel lock feature

You can lock the front panel buttons to prevent your settings from being changed accidentally (by children, for example). When the front panel lock is in ON, all control buttons on the TV front panel (except POWER) do not operate.

To lock the front panel:

1. From the LOCKS menu, select FRONT PANEL LOCK.
2. Press ◀ or ▶ to highlight ON.

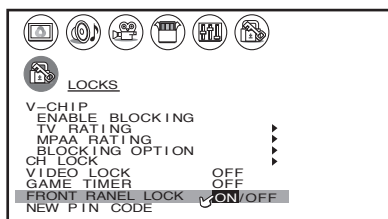

If a button on the front panel is pressed, the message “Not Available” appears.

To unlock the front panel:

Highlight OFF in step 2 above, or press and hold the VOL < button on the TV for about 10 seconds until the message “Front Panel Lock: Off” appears on the screen.

Changing the PIN code

1. From the LOCKS menu, select NEW PIN CODE.
2. Press the Number buttons (0-9) to enter a 4-digit code. The numbers you enter will replace the dashes in the display.

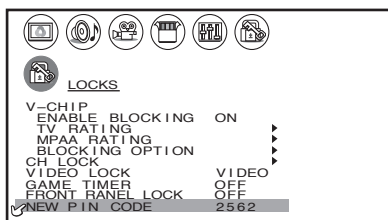

3. Press ENTER. The new PIN code is now active.

Note:

To deactivate the game timer, set the VIDEO LOCK to OFF (see “Locking video inputs” on page 39).

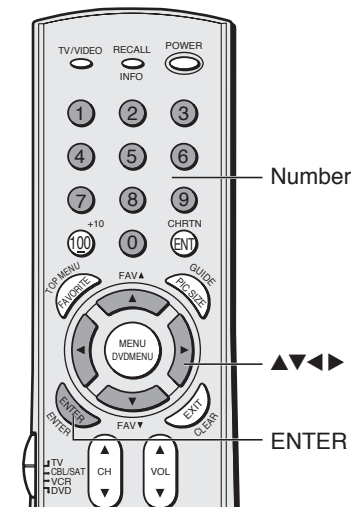
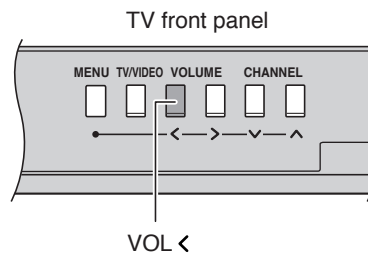
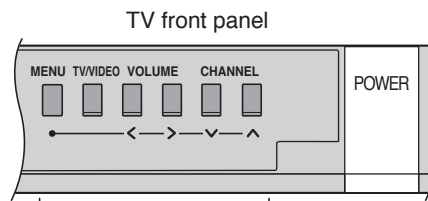

Adjusting the picture

Selecting the picture mode

You can select your desired picture type from four picture modes: Sports, Standard, Movie, and Preference.

Mode	Picture Quality
Sports	Bright and dynamic picture (factory setting)
Standard	Standard picture setting (factory setting)
Movie	Movie-like picture setting (factory setting)
Preference	Your personal preference*

*(see "Saving your new preferences" on page 43.)

To select the picture mode:

1. Press MENU, and then press ◀(◀) or ▶(▶) until the PICTURE menu appears.
2. Press ▼(▼) or ▲(▲) to select MODE.
3. Press ◀(◀) or ▶(▶) to highlight the mode you prefer.

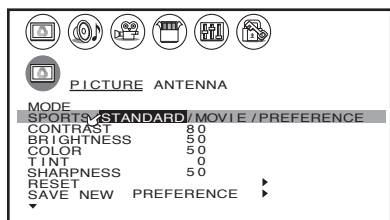

Note:

If you select one of the factory-set picture modes (SPORTS, STANDARDS, or MOVIE) and then change a picture quality setting (for example, increase the contrast), the picture mode automatically changes to PREFERENCE in the Picture menu.

To save your new picture quality settings, you must select SAVE NEW PREFERENCE (see page 43) before closing the Picture menu or the TV will return to the previous picture mode.

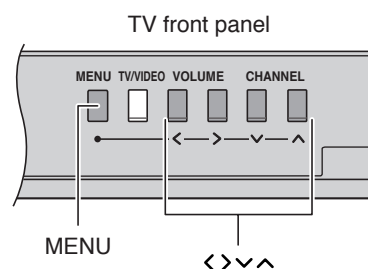

Adjusting the picture quality

You can adjust the picture quality to your personal preferences, including the contrast, brightness, color, tint and sharpness.

Selection	◀ Pressing ▶	
contrast	lower	higher
brightness	darker	lighter
color	paler	deeper
tint	reddish	greenish
sharpness	softer	sharper

To adjust the picture quality:

1. Press MENU, and then press ◀(◀) or ▶(▶) until the PICTURE menu appears.
2. Press ▼(▼) or ▲(▲) until the item you want to adjust is highlighted.
3. Press ◀(◀) or ▶(▶) to adjust the level.

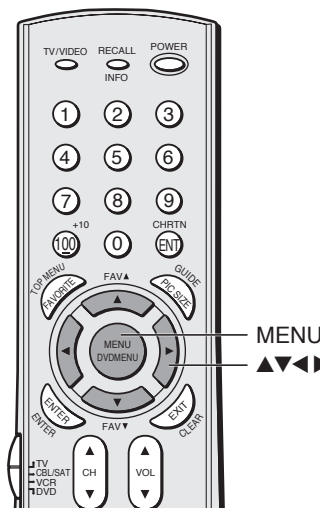
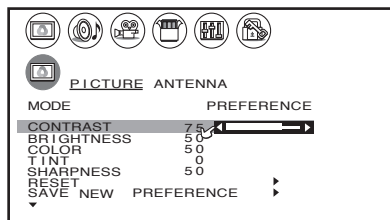

The PICTURE qualities you adjusted can be saved in the TV's memory with the SAVE NEW PREFERENCE feature (see page 43). You can keep these settings or choose factory set options, as described under "Selecting the picture mode" above.



Saving your new preferences

You can save the PICTURE qualities (contrast, brightness, color, tint, and sharpness) you adjusted in the picture preference mode.

To save your new preferences:

1. Press MENU, and then press ◀ or ▶ until the PICTURE menu appears.
2. Press ▲ or ▼ to highlight SAVE NEW PREFERENCE.
3. Press ◀ or ▶. When complete, the menu displays "DONE".

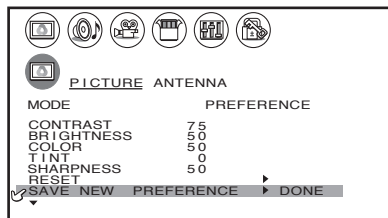

The mode automatically change to PREFERENCE (see "Selecting the picture mode" on page 42).

Using the flesh tone feature

This feature displays natural flesh tones by correcting the tint.

To turn on the flesh tone feature:

1. Press MENU, and then press ◀ or ▶ until the PICTURE menu appears.
2. Press ▲ or ▼ to highlight FLESH TONE.
3. Press ◀ or ▶ to highlight ON.

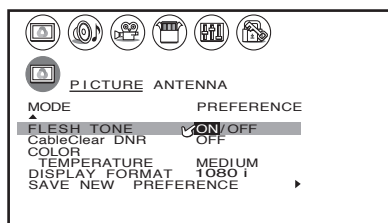

Using the CableClear™ DNR feature

This feature allows you to reduce visible interference in your TV picture. This is useful when receiving a broadcast with a weak signal (especially Cable channel) or playing back a video cassette or disc damaged by repeated use.

To turn on CableClear™ DNR:

1. Press MENU, and then press ◀ or ▶ until the PICTURE menu appears.
2. Press ▲ or ▼ to highlight CableClear DNR.
3. Press ◀ or ▶ to highlight AUTO.

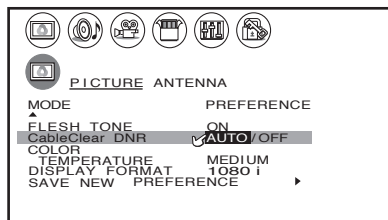

To turn off CableClear DNR:

Highlight OFF in step 3 above.

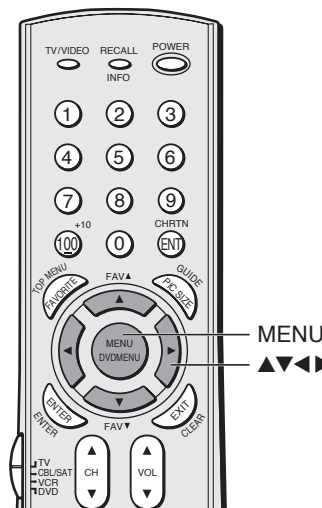

Introduction

Connecting your TV

Using the Remote Control

Setting up your TV

Using the TV's Features

Appendix

Index

Note:

- CableClear DNR is not available in DVI mode (fixed to OFF).
- The "CableClear DNR" menu listing will change to "DNR" in ColorStream mode.

Selecting the color temperature

You can change the quality of the picture by selecting from three preset color temperatures: cool, medium, and warm.

To select the color temperature:

1. Press MENU, and then press ◀ or ▶ until the PICTURE menu appears.
2. Press ▲ or ▼ to highlight COLOR TEMPERATURE.
3. Press ◀ or ▶ to highlight the mode you prefer.

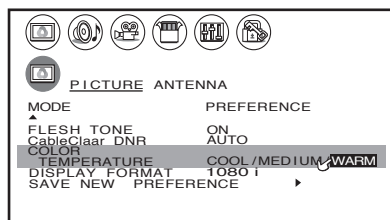

Mode	Picture Quality
cool	blueish
medium	neutral
warm	reddish

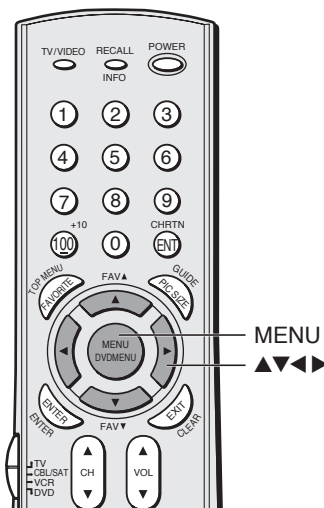

Selecting the display format (for 480p signals only)

This feature converts an input signal 480p to 540p or 1080i.

To select the display format:

1. Press MENU, and then press ◀ or ▶ until the PICTURE menu appears.
2. Press ▲ or ▼ to highlight DISPLAY FORMAT.
3. Press ◀ or ▶ to select 540p or 1080i.

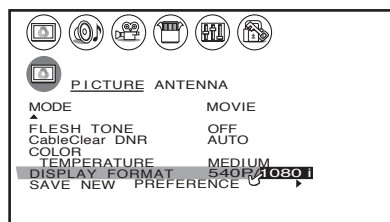

Note:

- The DISPLAY FORMAT feature is available only for 480p input. 1080i is always output when a signal other than 480p is input.
- If you notice flickering in a 480p image, try setting the DISPLAY FORMAT to 540p.

Resetting your picture adjustments

The RESET function adjusts the picture qualities you adjusted to the following factory settings:

Contrast	max (100)	Color temperature	cool
Brightness	center (50)	CableClear DNR	auto
Color	center (50)	Mode	sports
Tint	center (0)		
Sharpness	center (50)		

To reset your picture adjustments:

1. Press MENU, and then press ◀ or ▶ until the PICTURE menu appears.
2. Press ▲ or ▼ to highlight RESET.
3. Press ◀ or ▶. The menu displays "DONE."

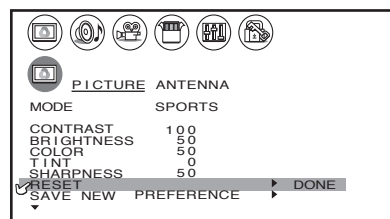



Selecting the video input source

Press TV/VIDEO on the remote control or TV front panel to view a signal from another device connected to your TV, such as a VCR or video disc player (see illustrations below). You can select ANT 1, VIDEO 1, VIDEO 2, VIDEO 3, ColorStream HD1, ColorStream HD2, DVI, or ANT 2 depending on which input jacks you used for connecting your devices (see “Connecting your TV” on page 7).

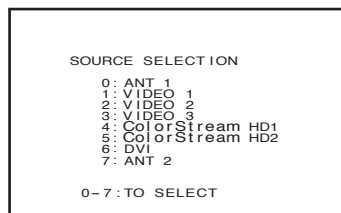

Pressing TV/VIDEO on the remote control displays the current signal source (press TV/VIDEO again or 0-7 to change)

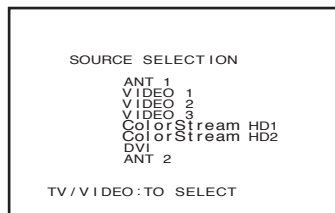

Pressing TV/VIDEO on the TV changes the current signal source

Note:

- When ColorStream HD 1 or HD 2 is selected, the VIDEO OUT jack does not output a signal. To receive a video OUT signal, use a video or S-video IN connection instead of the ColorStream connection.

Please note the following regarding the DVI source selection:

This TV is not intended for connection to and should not be used with a PC (personal computer). See “Connecting a device to the DVI/HDCP input” on page 13 for details.

Labeling the video input sources

The VIDEO LABEL feature allows you to label each input source for your TV from the following preset list of labels:

- : Uses the default label name
- VCR : Video cassette recorder
- DVD : DVD video
- DTV : Digital TV set-top box
- SAT : Satellite box
- CBL : Cable box
- HD : DVI/HDCP device (see page 13.)

To label the video input sources:

- Press MENU, and then press ◀ or ▶ until the CUSTOM menu appears.
- Press ▲ or ▼ to highlight VIDEO LABEL.

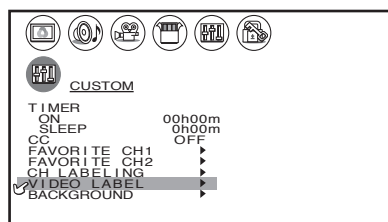

- Press ◀ or ▶ to display the VIDEO LABEL menu.
- Press ▲ or ▼ to highlight the video source you want to label.
- Press ◀ or ▶ to select the desired label for that input source.

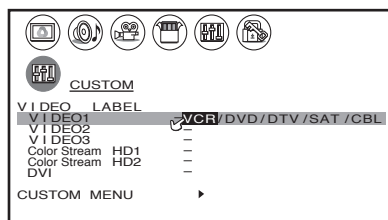

- Finish labeling the other video sources as desired. To return to the previous menu, press ▲ or ▼ to highlight CUSTOM MENU, and then press ◀ or ▶.
- To exit the menu, press EXIT.

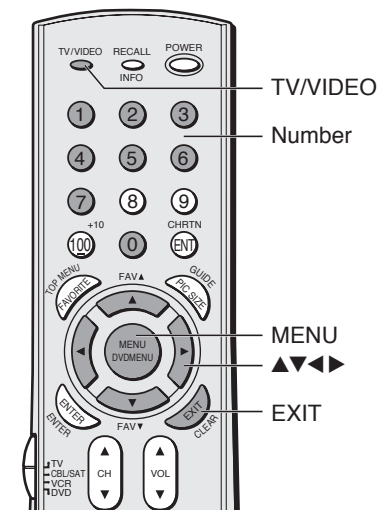
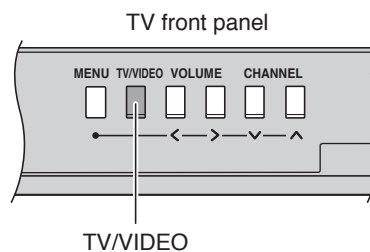

Note:

The HD (high-definition) label is available for DVI mode only (see “Selecting the video input source” above, and “Connecting a device to the DVI/HDCP input” on page 13).

Using the closed caption feature

The closed caption feature has two options:

- Captions—An on-screen display of the dialogue, narration, and sound effects of TV programs and videos that are closed captioned (usually labeled as “CC”).
- Text—An on-screen display of information not related to the current program, such as weather or stock data (when provided by individual stations).

To view captions or text:

1. Tune the TV to the desired program.
2. Press MENU, and then press ◀ or ▶ to display CUSTOM menu.
3. Press ▲ or ▼ to highlight CC.

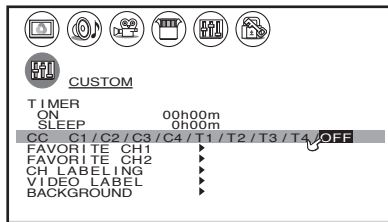

4. Press ◀ or ▶ to highlight the desired closed caption mode, as follows:

- To view captions, highlight C1, C2, C3, or C4 (C1 displays translation in the primary language in your area).

Note: If the program or video you selected is not closed captioned, no captions will display on the screen.



- To view text, highlight T1, T2, T3, or T4.

Note: If text is not available in your area, a black rectangle may appear on your screen. If this happens, turn the Closed Caption feature OFF.

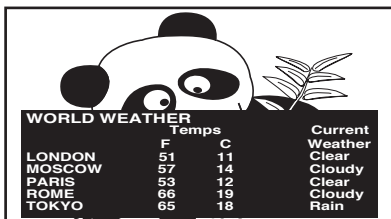

To turn off the Closed Caption feature:

Highlight OFF in step 4.

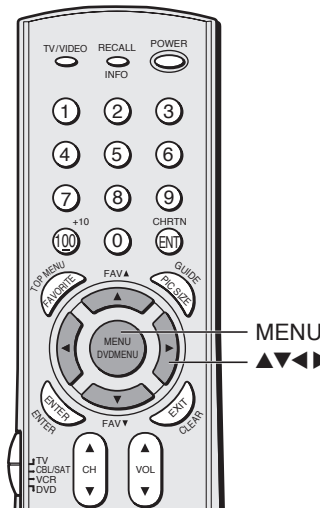

Note:

A closed caption signal may not display in the following situations:

- when a videotape has been dubbed
- when the signal reception is weak
- when the signal reception is nonstandard

Setting the ON timer

To set the ON timer to turn on the TV automatically:

1. Press MENU, and then press ◀ or ▶ until the CUSTOM menu appears.
2. Press ▲ or ▼ to highlight ON.
3. After the number position starts to blink, press the Number buttons (0–9) to enter the length of time until the TV turns on automatically.
You can set the ON timer in 10 minute increments, to a maximum of 12 hours.
4. Press ENTER to start the timer.

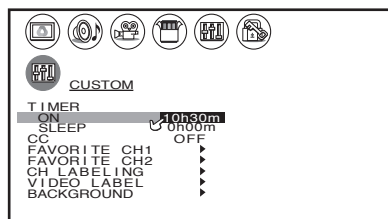

5. Press POWER to turn off the TV.
The TV will turn on automatically after the length of time you set in the ON timer.

Setting the sleep timer

To set the sleep timer to turn off the TV automatically:

1. Press SLEEP to set the length of time until the TV turns off.

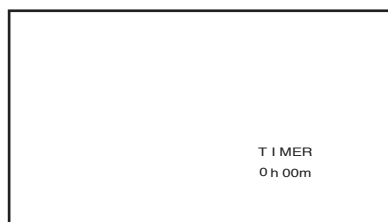

Every time you press the button, the time will increase in 10-minute increments, to a maximum of 3 hours.

0h00m → 0h10m → 0h20m → ... → 2h50m → 3h00m → 0h00m

To cancel the sleep timer:

Press SLEEP until it is set to 0h00m.

The timer also can be set using the on-screen menu:

1. Press MENU, and then press ◀ or ▶ until the CUSTOM menu appears.
2. Press ▲ or ▼ to highlight SLEEP.
3. After the number position starts to blink, press the Number buttons (0–9) to enter the length of time until the TV turns off automatically.
4. Press ENTER to start the timer.

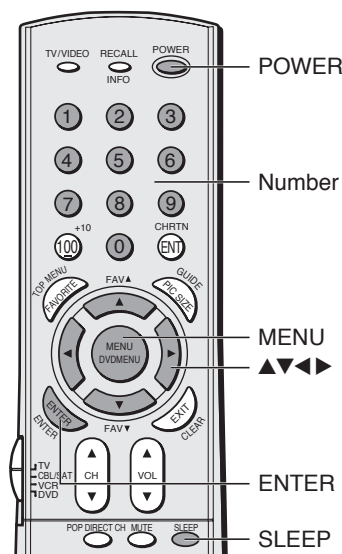
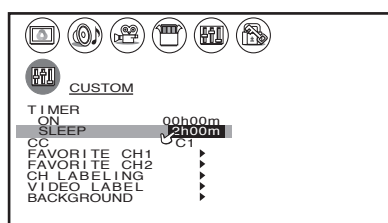

Note :

When an instant power failure occurs, the timer setting may be cleared.

To display the amount of time left until the TV turns on or off automatically, press RECALL.

Setting the clock

To set the clock:

1. Press MENU, and then press ◀ or ▶ until the SET UP menu appears.
2. Press ▲ or ▼ to highlight CLOCK SET.
3. After the number position starts to blink, press the Number buttons (0–9) to enter the correct time. The clock operates on a 24-hour cycle only.
4. Press ENTER to start the clock.

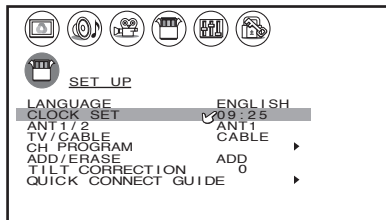

To display the time on-screen:

Press RECALL.

Selecting the background of the menu display

You can change the background of the menu display by selecting from two preset types: shaded and solid (gray).

To select the menu background:

1. Press MENU, and then press ◀ or ▶ until the CUSTOM menu appears.
2. Press ▲ or ▼ to highlight BACKGROUND.
3. Press ◀ or ▶ to select either SHADED or SOLID.

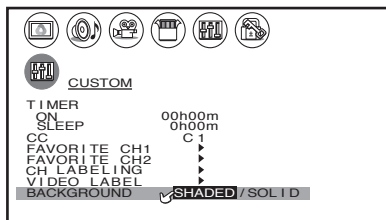

Note :

If the TV's power source is interrupted (the power cord is unplugged or a power failure occurs), the clock must be reset.

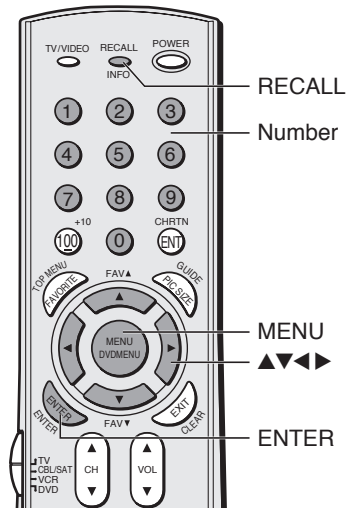

Adjusting the sound

Muting the sound

Press MUTE to temporarily reduce (1/2 MUTE) or turn off (MUTE) the sound. While the sound is muted, the screen will display “1/2 MUTE” or “MUTE” in the lower right corner. Every time you press MUTE, the mute mode will change in the following order.

→ Normal → 1/2 MUTE → MUTE

When you select “MUTE” mode, the closed caption feature is automatically activated (if the closed caption mode is set to OFF). To deactivate this feature, deactivate MUTE. See “Using the closed caption feature” on page 46 for more information.

Selecting stereo/SAP broadcasts

The multi-channel TV sound (MTS) feature allows you to output high-fidelity stereo sound from your TV’s internal speakers. MTS also can transmit a second audio program (SAP) containing a second language, music, or other audio information (when provided by individual stations).

When the TV receives a stereo or SAP broadcast, the word STEREO or SAP appears on-screen every time the TV is turned on, the channel is changed, or the RECALL button is pressed. The word “STEREO” or “SAP” displays in yellow in the menu when the TV receives the signal.

The MTS feature is not available when the TV is in VIDEO mode.

To listen to stereo sound:

1. Press MENU, and then press ◀ (◀) or ▶ (▶) until the AUDIO menu appears.
2. Press ▲ (▲) or ▼ (▼) to highlight MTS.
3. Press ◀ (◀) or ▶ (▶) to highlight STEREO.

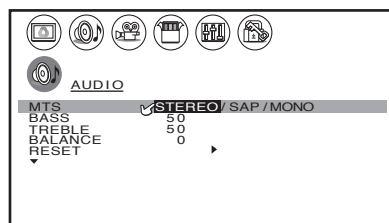

You can leave your TV in STEREO mode because it will automatically output the type of sound being broadcast (stereo or monaural).

If the stereo sound is noisy, select MONO to reduce the noise.

To listen to SAP (if available):

1. Press MENU, and then press ◀ (◀) or ▶ (▶) until the AUDIO menu appears.
2. Press ▲ (▲) or ▼ (▼) to highlight MTS.
3. Press ◀ (◀) or ▶ (▶) to highlight SAP. You will hear the station’s second audio program (if available) from the speakers, while viewing the original program’s picture (see note at right).

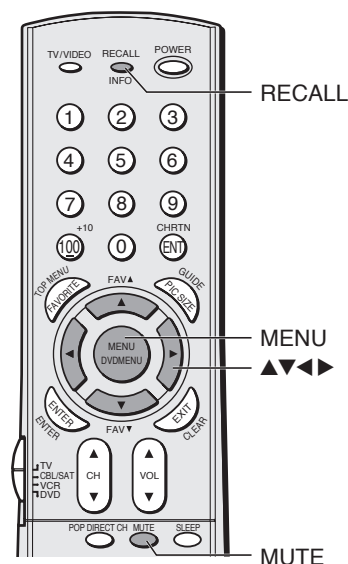

TV front panel

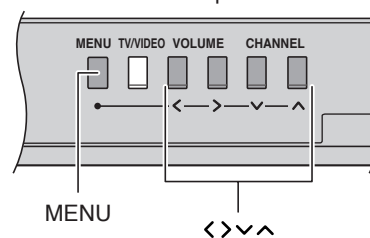

Note :

A second audio program (SAP) can be heard only on those TV stations that offer it.

For example, a station might broadcast music (or another language) as a second audio program. If you have SAP on, you will see the current program on the screen but hear music (or the other language) instead of the program’s normal audio.

If you have SAP on and the station you are watching is not broadcasting a second audio program, the station’s normal audio will be output.

Occasionally no sound is output in SAP mode. If this happens, set the MTS feature to STEREO mode.

Using the WOW™ surround sound feature

WOW is a special combination of SRS Labs audio technologies that creates a thrilling surround sound experience with deep rich bass from stereo sound sources. Your TV's audio will sound fuller, richer, and wider.

To adjust the WOW feature:

1. Select STEREO mode (See "Selecting stereo/SAP broadcasts" on page 49).
2. Press MENU, and then press ◀ or ▶ until the THEATER menu appears.
3. Press ▲ or ▼ to highlight the desired WOW feature you want to adjust, then press ◀ or ▶ to adjust the item.
 - SRS 3D — To turn on or off the surround sound effect.
 - FOCUS — To turn on or off the vocal emphasis effect.
 - TruBass — To select your desired bass expansion level (HIGH, LOW or OFF).

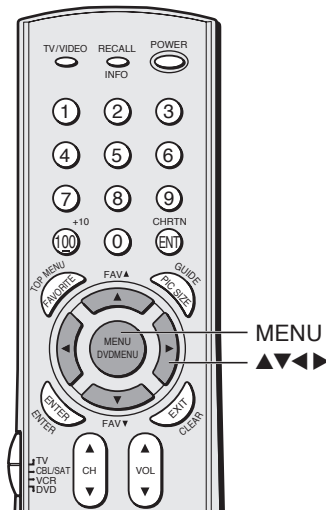
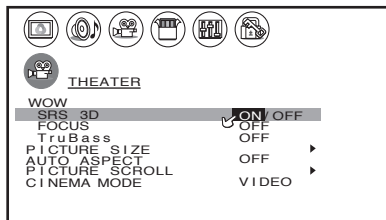

Note:

If the broadcast is monaural, the SRS 3D effect does not work.

Adjusting the sound quality

You can change the quality of your TV's sound by adjusting the bass, treble, and balance.

To adjust the sound quality:

1. Press MENU, and then press ◀ or ▶ until the AUDIO menu appears.
2. Press ▲ or ▼ to highlight the item you want to adjust.

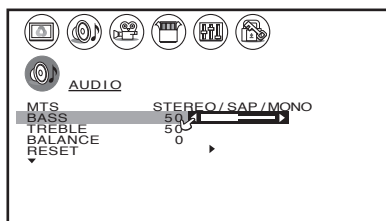

3. Press ◀ or ▶ to adjust the level.
 - ◀ makes the sound quality weaker or increases the balance in the left channel, depending on the item selected.
 - ▶ makes the sound quality stronger or increases the balance in the right channel, depending on the item selected.

SRS WOW, SRS and ● symbol are trademarks of SRS Labs, Inc.

SRS WOW technology is incorporated under license from SRS Labs, Inc.



Resetting your audio adjustments

The RESET function returns your audio adjustments to the following factory settings:

- Bass center (50)
- Treble center (50)
- Balance center (0)

To reset your audio adjustments:

1. Press MENU, and then press ◀ or ▶ until the AUDIO menu appears.
2. Press ▲ or ▼ to highlight RESET.
3. Press ◀ or ▶. The menu displays “DONE.”

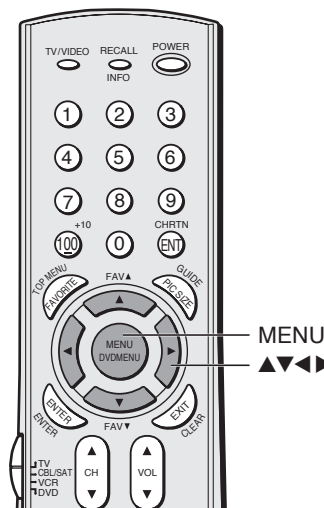
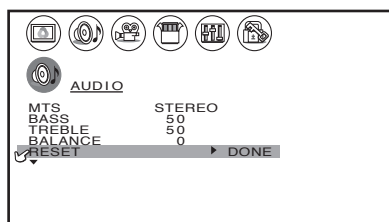

Using the CYCLONE® sub-woofer system

Toshiba's CYCLONE® ABX (Acoustic Bass eXpansion) system provides dynamic acoustic reproduction in a self-enclosed bass-reflex sub-woofer system.

To turn on the CYCLONE® sub-woofer system and adjust the CYCLONE level:

1. Press MENU, and then press ◀ or ▶ until the AUDIO menu appears.
2. Press ▲ or ▼ to highlight CYCLONE.
3. Press ◀ or ▶ to highlight ON.

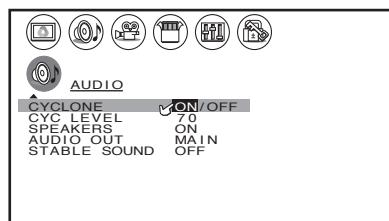

4. Press ▲ or ▼ to highlight CYC LEVEL.
5. Press ◀ or ▶ to adjust the CYCLONE level (sub-woofer volume).
Press ▶ to increase the sub-woofer volume.
Press ◀ to decrease the sub-woofer volume.

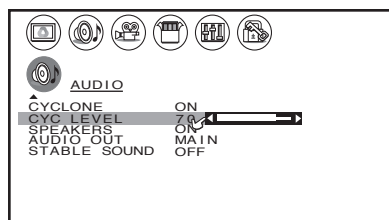

To turn off the CYCLONE® sub-woofer system:

Highlight OFF in step 3 above.

Note:

While the CYCLONE is set to OFF, if the CYCLONE level is adjusted, the CYCLONE is automatically set to ON.

Turning off the built-in speakers

Use this feature to turn off the TV speakers when you connect an audio system (see “Connecting an audio system” on page 14).

To turn off the built-in speakers:

1. Press MENU, then press ◀ or ▶ until AUDIO menu appears.
2. Press ▲ or ▼ to highlight SPEAKERS.
3. Press ◀ or ▶ to highlight OFF.

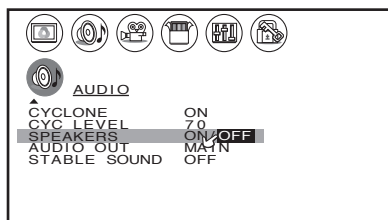

To turn on the built-in speakers:

Highlight ON in step 3 above.

Selecting the AUDIO OUT sound

This feature allows you to select the sound source (MAIN or POP) that is output from the AUDIO OUT jacks (see “Connecting two VCRs” on page 12).

This is useful when amplifying or recording the POP sound with external equipment while hearing the sound of the main picture through the built-in speakers.

To select the AUDIO OUT sound:

1. Press MENU, and then press ◀ or ▶ until the AUDIO menu appears.
2. Press ▲ or ▼ to highlight AUDIO OUT.
3. Press ◀ or ▶ to select MAIN or POP.

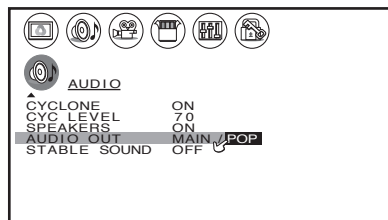

- MAIN: Outputs the sound of the main program through the AUDIO OUT jacks.
- POP : Outputs the sound of the POP program through the AUDIO OUT jacks.

Note:

Make sure the volume control of your audio amplifier is set to a moderate listening level.

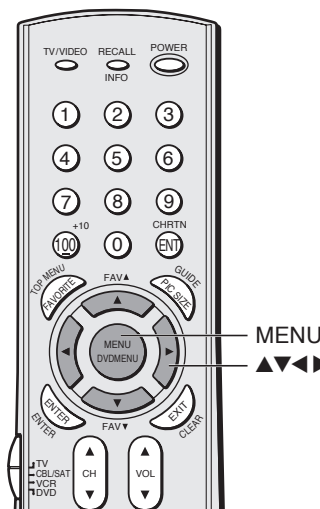

Note:

When the POP window is not on the screen, the sound of the main program is output through the AUDIO OUT jacks, even if POP is selected in the AUDIO OUT menu.

Using the StableSound® feature

When the signal source is changed, the StableSound® feature limits the highest volume level to prevent extreme changes in volume (for example, to prevent the sudden increase in volume that often happens when a TV program switches to a commercial).

To turn on the StableSound® feature:

1. Press MENU, and then press ◀ or ▶ until the AUDIO menu appears.
2. Press ▲ or ▼ to highlight STABLE SOUND.
3. Press ◀ or ▶ to select ON.

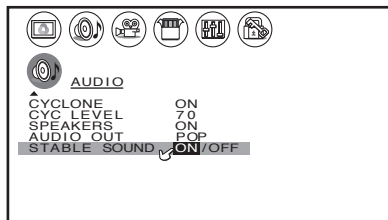

To turn off the StableSound feature:
Highlight OFF in step 3 above.

Displaying on-screen information

Press RECALL to display the following information on-screen:

- Antenna mode (when in TV mode)
- Channel number or VIDEO mode selected
- Time (if set)
- Remaining time of ON/SLEEP timer (if set)
- Channel label (if set)
- Stereo or SAP audio status
- V-CHIP rating status
- Picture size

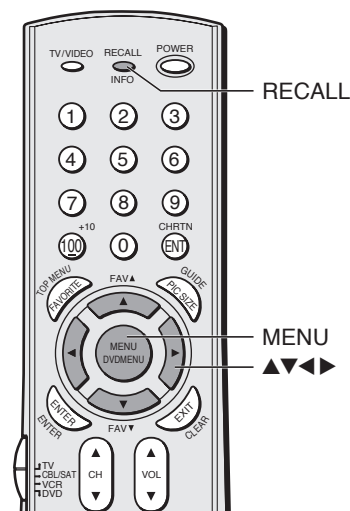
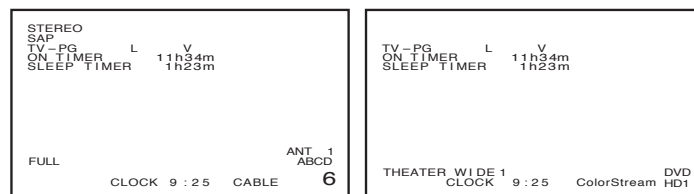

Introduction

Connecting your TV

Using the Remote Control

Setting up your TV

Using the TV's Features

Appendix

Index

Viewing the demo mode

The demo mode automatically demonstrates several of your TV's features.

To start the demo:

Press and hold MENU on the TV front panel for 4 seconds.

To stop the demo:

Press RECALL, EXIT, or POWER.

Understanding the auto power off feature

The TV will automatically turn itself off after approximately 15 minutes if it is tuned to a vacant channel or a station that completes its broadcast for the day. This feature does not work in VIDEO mode.

Understanding the last mode memory feature

If the power is cut off while you are viewing the TV, the Last Mode Memory feature turns the TV on automatically when the power is resupplied.

If the power is going to be off for a long time and you are going to be away from your TV, unplug the power cord to prevent the TV from turning on in your absence.

Appendix

Specifications

Television System

NTSC standard

Channel Coverage

VHF: 2 through 13

UHF: 14 through 69

Cable TV: Mid band (A-8 through A-1, A through I)

Super band (J through W)

Hyper band (AA through ZZ, AAA, BBB)

Ultra band (65 through 94, 100 through 125)

Power Source

120 V AC, 60 Hz

Power Consumption

147 W (average)

Audio Power

10 W + 10 W + 13 W sub-woofer

Speaker Type

Two 6 × 12 cm + one 10 cm round sub-woofer

Video/Audio Terminals

S-VIDEO INPUT

Y : 1 V(p-p), 75 ohm, negative sync.

C : 0.286 V(p-p) (burst signal), 75 ohm

VIDEO/AUDIO INPUT

VIDEO: 1 V(p-p), 75 ohm, negative sync.

AUDIO: 150 mV(rms) (30% modulation equivalent, 47 k ohm)

ColorStream® (component video) INPUT

Y : 1V(p-p), 75 ohm

PR: 0.7 V(p-p), 75 ohm

PB: 0.7 V(p-p), 75 ohm

AUDIO: 150 mV(rms), 47 k ohm

Suggested scan rates: 1080i, 480p, 480i, 720p

VIDEO/AUDIO OUTPUT

VIDEO: 1 V(p-p), 75 ohm, negative sync.

AUDIO: 150 mV(rms) (30% modulation equivalent, 4.7 k ohm)

VARIABLE AUDIO OUTPUT

0–300 mV(rms) (30% modulation equivalent, 4.7 k ohm)

AUDIO CENTER CHANNEL INPUT

300 mV(rms) (30% modulation equivalent, 10 k ohm)

DVI/HDCP INPUT

HDCP compliant

E-EDID* 1.3 compliant

DVI-D uncompressed, high-speed, digital single-link connection

Suggested scan rates: 1080i, 480p, 480i, 720p

Dimensions

Width 29-3/4 inches (756 mm)

Height 21-5/8 inches (549 mm)

Depth 21-5/8 inches (549 mm)

Mass

119 lbs (54kg)

Supplied Accessories

Remote Control with 2 size “AA” alkaline batteries

Optional Stand

ST30W63

Design and specifications are subject to change without notice.

Introduction

Connecting your TV

Using the Remote Control

Setting up your TV

Using the TV's Features

Appendix

Index

* E-EDID = Enhanced-Extended Display Identification

Troubleshooting

Before calling a service technician, please check the following table for a possible cause of the problem and some solutions.

Problem	Solution
TV will not turn on	<ul style="list-style-type: none"> • Make sure the power cord is plugged in, then press POWER. • The remote control batteries may be dead. Replace the batteries.
No picture, no sound	<ul style="list-style-type: none"> • Check the antenna/cable connections.
No sound, picture OK	<ul style="list-style-type: none"> • The sound may be muted. Press VOLUME. • The station may have broadcast difficulties. Try another channel. • Make sure the SPEAKERS function in the AUDIO menu is set properly. • Make sure the AUDIO CENTER CHANNEL switch is set properly. • If the MTS feature is in SAP mode, change it to STEREO mode.
Poor picture, sound OK	<ul style="list-style-type: none"> • Check the antenna connections. • The station may have broadcast difficulties. Try another channel. • Adjust the PICTURE menu. • Make sure your other devices are connected to the TV correctly.
Poor reception of broadcast channels	<ul style="list-style-type: none"> • The station may have broadcast difficulties. Try another channel. • Check the antenna connections. • If you are using a VCR, make sure the TV/VCR button on the remote control is set correctly.
Cannot receive above channel 13	<ul style="list-style-type: none"> • Make sure the device switch on the remote control is set to the mode that corresponds with the signal source type (cable company or outside antenna).
Black box appears on the screen	<ul style="list-style-type: none"> • The closed caption feature may be set to one of the Text modes (T1, T2, T3, or T4). Turn closed captioning OFF.
Unable to select a certain channel	<ul style="list-style-type: none"> • The channel may be locked with the CH LOCK feature, or erased with the ADD/ERASE feature.
Multiple images	<ul style="list-style-type: none"> • The station may have broadcast difficulties. Try another channel. • Antenna reception may be poor. Use a highly directional outdoor antenna.
Poor color or no color	<ul style="list-style-type: none"> • The station may have broadcast difficulties. Try another channel. • Adjust the TINT and/or COLOR in the PICTURE menu.
No stereo or SAP sound from a known MTS broadcast	<ul style="list-style-type: none"> • Make sure the MTS feature is set properly.
The front panel buttons do not operate	<ul style="list-style-type: none"> • Check the FRONT PANEL LOCK feature.
The remote control does not operate	<ul style="list-style-type: none"> • Make sure the appropriate device mode on the remote control is selected. • Remove all obstructions between the remote control and the remote control sensor in the TV. • The remote control batteries may be dead. Replace the batteries.
Cannot access signal input sources (VIDEO1, VIDEO2, VIDEO3, ColorStream HD1/HD2, DVI/HDCP) and/or Channels 3 and 4.	<ul style="list-style-type: none"> • Check the VIDEO LOCK feature.



Limited United States Warranty

for 27" FST PURE® and All Larger Television Models

Toshiba America Consumer Products, Inc. ("TACP") and Toshiba Hawaii, Inc. ("THI") make the following limited warranties to original consumers in the United States. **THESE LIMITED WARRANTIES EXTEND TO THE ORIGINAL CONSUMER PURCHASER OR ANY PERSON RECEIVING THIS TELEVISION AS A GIFT FROM THE ORIGINAL CONSUMER PURCHASER AND TO NO OTHER PURCHASER OR TRANSFEREE.**

PRODUCTS PURCHASED IN THE U.S.A. AND USED IN CANADA ARE NOT COVERED BY THESE WARRANTIES.

PRODUCTS PURCHASED IN CANADA AND USED IN THE U.S.A. ARE NOT COVERED BY THESE WARRANTIES.

Limited One (1) Year Warranty on Parts and Labor*

TACP/THI warrant this television and its parts against defects in materials or workmanship for a period of one (1) year after the date of original retail purchase. **DURING THIS PERIOD, TACP/THI WILL, AT TACP/THI'S OPTION, REPAIR OR REPLACE A DEFECTIVE PART WITH A NEW OR REFURBISHED PART WITHOUT CHARGE TO YOU FOR PARTS OR LABOR.** TACP/THI Authorized Service Station personnel will come to your home when warranty service is required. Depending on the type of repair required, either the service will be performed in your home or the set will be taken to the TACP/THI Authorized Service Station for repair and returned to your home at no cost to you.

Limited Two (2) Year Warranty on Picture Tube*

TACP/THI further warrant the picture tube in this television against defects in materials or workmanship for a period of two (2) years after the date of original retail purchase. **DURING THIS PERIOD, TACP/THI WILL, AT TACP/THI'S OPTION, REPAIR OR REPLACE A DEFECTIVE PICTURE TUBE WITH A NEW OR REFURBISHED PICTURE TUBE WITHOUT CHARGE TO YOU, EXCEPT THAT, IF A DEFECTIVE PICTURE TUBE IS REPAIRED OR REPLACED AFTER ONE (1) YEAR FROM THE DATE OF THE ORIGINAL RETAIL PURCHASE, YOU PAY LABOR CHARGES INVOLVED IN THE REPAIR OR REPLACEMENT.**

Rental Units

The warranty for rental units begins with the date of first rental or thirty (30) days from the date of shipment to the rental firm, whichever comes first.

*Commercial Units

Televisions sold and used for commercial purposes have a limited ninety (90) day warranty for all parts, labor, and picture tubes.

Owner's Manual and Product Registration Card

Read this owner's manual thoroughly before operating this television. Complete and mail the enclosed product registration card within ten days after you, or the person who has given you this product as a gift, purchased this television. Returning the product registration card will enable TACP/THI to provide you with better customer service and improved product support. Failure to return the product registration card will not affect your rights under this warranty.

Your Responsibility

THE ABOVE WARRANTIES ARE SUBJECT TO THE FOLLOWING CONDITIONS:

- (1) You must provide your bill of sale or other proof of purchase.
- (2) All warranty servicing of this television must be made by an Authorized TACP/THI Service Station.
- (3) The warranties from TACP and THI are effective only if the television is purchased and operated in the U.S.A. or Puerto Rico.
- (4) Labor service charges for set installation, setup, adjustment of customer controls, and installation or repair of antenna

systems are not covered by these warranties. Reception problems caused by inadequate antenna systems are your responsibility.

- (5) Warranties extend only to defects in materials or workmanship as limited above and do not extend to any television or parts that have been lost or discarded by you or to damage to television or parts caused by misuse, accident, Acts of God (such as lightning or fluctuations in electric power), improper installation, improper maintenance, or use in violation of instructions furnished by TACP/THI; or to units that have been modified or had the serial number removed, altered, defaced, or rendered illegible.

How to Obtain Warranty Services

If, after following all of the operating instructions in this manual and checking the "Troubleshooting" section, you find that service is needed:

- (1) To find the nearest TACP/THI Authorized Service Station:
 - For televisions purchased in the United States, except Hawaii, visit TACP's web site at www.toshiba.com/tacp, or call toll free 1-800-631-3811.
 - For televisions purchased in Hawaii, contact Toshiba Hawaii, Inc., 327 Kamakee Street, Honolulu, HI 96814, (808) 591-9281.
- (2) Present your bill of sale or other proof of purchase to the Authorized Service Station. Authorized TACP/THI Service Station personnel will come to your home when warranty service is required. Depending on the type of repair required, either the service will be performed in your home or the set will be taken to the Authorized Service Station for repair and returned to your home at no cost to you.

**For additional information, visit TACP's web site:
www.toshiba.com/tacp.**

ALL WARRANTIES IMPLIED BY THE LAW OF ANY STATE OF THE U.S.A., INCLUDING THE IMPLIED WARRANTIES OF MERCHANTABILITY AND FITNESS FOR A PARTICULAR PURPOSE, ARE EXPRESSLY LIMITED TO THE DURATION OF THE LIMITED WARRANTIES SET FORTH ABOVE. WITH THE EXCEPTION OF ANY WARRANTIES IMPLIED BY THE LAW OF ANY STATE OF THE U.S.A. AS HEREBY LIMITED, THE FOREGOING WARRANTY IS EXCLUSIVE AND IN LIEU OF ALL OTHER WARRANTIES, GUARANTEES, AGREEMENTS, AND SIMILAR OBLIGATIONS OF TACP OR THI WITH RESPECT TO THE REPAIR OR REPLACEMENT OF ANY PARTS. IN NO EVENT SHALL TACP OR THI BE LIABLE FOR CONSEQUENTIAL OR INCIDENTAL DAMAGES.

No person, agent, distributor, dealer, or company is authorized to change, modify, or extend the terms of these warranties in any manner whatsoever. The time within which action must be commenced to enforce any obligation of TACP or THI arising under this warranty or under any law of the United States or of any state thereof is hereby limited to 90 days from the date you discover, or should have discovered, the defect. This limitation does not apply to implied warranties arising under the law of any state of the U.S.A.

THIS WARRANTY GIVES YOU SPECIFIC LEGAL RIGHTS, AND YOU MAY ALSO HAVE OTHER RIGHTS, WHICH MAY VARY FROM STATE TO STATE IN THE U.S.A. SOME STATES OF THE U.S.A. DO NOT ALLOW LIMITATIONS ON THE DURATION OF AN IMPLIED WARRANTY, LIMITATIONS ON THE TIME WITHIN WHICH AN ACTION MAY BE BROUGHT, OR THE EXCLUSION OR LIMITATION OF INCIDENTAL OR CONSEQUENTIAL DAMAGES; THEREFORE, THE ABOVE LIMITATIONS OR EXCLUSIONS MAY NOT APPLY TO YOU UNDER SUCH CIRCUMSTANCES.

FST PURE® is a registered trademark of Toshiba America Consumer Products, Inc.
REV. MAR02

Introduction

Connecting your TV

Using the Remote Control

Setting up your TV

Using the TV's Features

Appendix

Index

Limited Canada Warranty for 27" FST PURE® and All Larger Television Models

Toshiba of Canada Limited ("TCL") makes the following limited warranties to original consumers in Canada.

THESE LIMITED WARRANTIES EXTEND TO THE ORIGINAL CONSUMER PURCHASER OR ANY PERSON RECEIVING THIS TELEVISION AS A GIFT FROM THE ORIGINAL CONSUMER PURCHASER AND TO NO OTHER PURCHASER OR TRANSFEREE.

PRODUCTS PURCHASED IN THE U.S.A. AND USED IN CANADA ARE NOT COVERED BY THESE WARRANTIES.

PRODUCTS PURCHASED IN CANADA AND USED IN THE U.S.A. ARE NOT COVERED BY THESE WARRANTIES.

Limited One (1) Year Warranty on Parts and Labor*

TCL warrants this television and its parts against defects in materials or workmanship for a period of one (1) year after the date of original retail purchase. DURING THIS PERIOD, TCL WILL, AT TCL'S OPTION, REPAIR OR REPLACE A DEFECTIVE PART WITH A NEW OR REFURBISHED PART WITHOUT CHARGE TO YOU FOR PARTS OR LABOR. TCL Authorized Service Depot personnel will come to your home when warranty service is required. Depending on the type of repair required, either the service will be performed in your home or the set will be taken to the TCL Authorized Service Depot for repair and returned to your home at no cost to you. IN-HOME SERVICE ONLY APPLIES WITHIN 100 KILOMETERS OF AN AUTHORIZED TCL SERVICE DEPOT.

Limited Two (2) Year Warranty on Picture Tube*

TCL further warrants the picture tube in this television against defects in materials or workmanship for a period of two (2) years after the date of original retail purchase. DURING THIS PERIOD, TCL WILL, AT TCL'S OPTION, REPAIR OR REPLACE A DEFECTIVE PICTURE TUBE WITH A NEW OR REFURBISHED PICTURE TUBE WITHOUT CHARGE TO YOU, EXCEPT THAT, IF A DEFECTIVE PICTURE TUBE IS REPAIRED OR REPLACED AFTER ONE (1) YEAR FROM THE DATE OF THE ORIGINAL RETAIL PURCHASE, YOU PAY LABOR CHARGES INVOLVED IN THE REPAIR OR REPLACEMENT.

Rental Units

The warranty for rental units begins with the date of first rental or thirty (30) days from the date of shipment to the rental firm, whichever comes first.

*Commercial Units

Televisions sold and used for commercial purposes have a limited ninety (90) day warranty for all parts, labor, and picture tubes.

Owner's Manual

Read this owner's manual thoroughly before operating this television.

Your Responsibility

THE ABOVE WARRANTIES ARE SUBJECT TO THE FOLLOWING CONDITIONS:

- (1) You must provide your bill of sale or other proof of purchase.
- (2) All warranty servicing of this television must be made by an Authorized TCL Service Depot.
- (3) The warranties from TCL are effective only if the television is purchased in Canada from an authorized TCL dealer and operated in Canada.
- (4) Labor service charges for set installation, setup, adjustment of customer controls, and installation or repair of antenna systems are not covered by these warranties. Reception problems caused by inadequate antenna systems are your responsibility.

- (5) Warranties extend only to defects in materials or workmanship as limited above and do not extend to any television or parts that have been lost or discarded by you or to damage to television or parts caused by misuse, accident, Acts of God (such as lightning or fluctuations in electric power), improper installation, improper maintenance, or use in violation of instructions furnished by TCL; or to units that have been modified or had the serial number removed, altered, defaced, or rendered illegible.

How to Obtain Warranty Services

If, after following all of the operating instructions in this manual and checking the "Troubleshooting" section, you find that service is needed:

- (1) To find the nearest TCL Authorized Service Depot, visit TCL's web site: www.toshiba.ca.
- (2) Present your bill of sale or other proof of purchase to the Authorized Service Depot. Authorized TCL Service Depot personnel will come to your home when warranty service is required. Depending on the type of repair required, either the service will be performed in your home or the set will be taken to the Authorized Service Depot for repair and returned to your home at no cost to you. IN-HOME SERVICE ONLY APPLIES WITHIN 100 KILOMETERS OF AN AUTHORIZED TCL SERVICE DEPOT.

**For additional information, visit TCL's web site:
www.toshiba.ca**

ALL WARRANTIES IMPLIED BY THE LAW OF ANY PROVINCE OF CANADA, INCLUDING THE IMPLIED WARRANTIES OF MERCHANTABILITY AND FITNESS FOR A PARTICULAR PURPOSE, ARE EXPRESSLY LIMITED TO THE DURATION OF THE LIMITED WARRANTIES SET FORTH ABOVE. WITH THE EXCEPTION OF ANY WARRANTIES IMPLIED BY THE LAW OF ANY PROVINCE OF CANADA AS HEREBY LIMITED, THE FOREGOING WARRANTY IS EXCLUSIVE AND IN LIEU OF ALL OTHER WARRANTIES, GUARANTEES, AGREEMENTS, AND SIMILAR OBLIGATIONS OF TCL WITH RESPECT TO THE REPAIR OR REPLACEMENT OF ANY PARTS. IN NO EVENT SHALL TCL BE LIABLE FOR CONSEQUENTIAL OR INCIDENTAL DAMAGES.

No person, agent, distributor, dealer, or company is authorized to change, modify, or extend the terms of these warranties in any manner whatsoever. The time within which action must be commenced to enforce any obligation of TCL arising under this warranty or under any law of Canada or of any province thereof, is hereby limited to 90 days from the date you discover, or should have discovered, the defect. This limitation does not apply to implied warranties arising under the law of any province of Canada.

THIS WARRANTY GIVES YOU SPECIFIC LEGAL RIGHTS, AND YOU MAY ALSO HAVE OTHER RIGHTS, WHICH MAY VARY FROM PROVINCE TO PROVINCE IN CANADA. SOME PROVINCES OF CANADA DO NOT ALLOW LIMITATIONS ON THE DURATION OF AN IMPLIED WARRANTY, LIMITATIONS ON THE TIME WITHIN WHICH AN ACTION MAY BE BROUGHT, OR THE EXCLUSION OR LIMITATION OF INCIDENTAL OR CONSEQUENTIAL DAMAGES; THEREFORE, THE ABOVE LIMITATIONS OR EXCLUSIONS MAY NOT APPLY TO YOU UNDER SUCH CIRCUMSTANCES.

FST PURE® is a registered trademark of Toshiba America Consumer Products, Inc.
REV. MAR02



Index

A

A/V cables (standard)	7
A/V receiver connection	14
ANT 1/2	21
Antenna cables (coaxial)	7
AUDIO OUT sound, selecting	52
Audio system connection	14
Auto aspect	31
Auto favorite	35
Auto power off	54

B

BACKGROUND selection	48
Back of the TV	6

C

CableClear™ DNR	43
Cable converter box connection	8
Camcorder connection	12
CH ▲▼ buttons	24
CH LABELING	27
CH LOCK	39
CH RTN button	25
Channel Number buttons	24
Channel programming	
ADD/ERASE	22
Automatic programming	22
TV/CABLE selection	22
Cinema mode	31
Clock, setting	48
Closed caption	46
Color temperature	44
ColorStream (component) cables	7
CYCLONE® sub-woofer system	51

D

Demo mode	54
Display format	44
Double-window ("POP") feature	32
DTV receiver connection	11
DVD connection	9, 10
DVI cable	7
DVI/HDCP connection	13

F G

FAV ▲▼ buttons	26
FAVORITE button	35
Favorite channels, programming	25
FOCUS feature	50
Front of the TV	6
Front panel lock	41
Game timer	41

L M

Labeling channels	27
Labeling video inputs	45
Language selection	21
Last mode memory	54
Locking channels	39
Locking video inputs	40
Locks menu	36
Menu system	20
MTS feature	49
MUTE button	49

O P

ON-timer	47
Picture adjustments	
COLOR TEMPERATURE	44
FLESH TONE	43
Picture mode	42
Picture quality	42
Picture-out-picture (POP)	
CH SCAN button	34
FREEZE button	33
POP CH ▼▲ buttons	32
POP DIRECT CH button	32
SOURCE button	32
SPLIT button	32
SWAP button	33
Picture scroll	30
Picture size selection	28
POP (also see "Picture-out-picture")	32

Q R

Quick connect guide	23
RECALL button	53
Remote control	
Battery installation	15
Learning about the buttons	19
Programming	16
RESET	44, 51

S

SAP sound	49
Satellite receiver connection	9
Scrolling the Theater Wide picture	30
Set-top box	11
Size of Double-Window, adjusting	33
Sleep timer	47
Sound quality adjustments	50
S on/off	52
Specifications	55
SpeedSurf mode	24
SRS 3D surround	50
StableSound®	53
Stereo sound	49
SurfLock™	25
S-video cables	7

T

Theater wide picture	29
Tilt correction	24
Troubleshooting	56
TruBass feature	50
TV/VIDEO button	25, 45

V

V-CHI P	
BLOCKING OPTION	38
ENABLE BLOCKING	37
MPAA RATING	38
NEW PIN CODE	41
TV RATING	37
Unlocking programs temporarily	39
VCR connection	7
VIDEO LABEL	45
VIDEO LOCK	40

W

Warranty	57, 58
WOW surround sound feature	50

Introduction

Connecting your TV

Using the Remote Control

Setting up your TV

Using the TV's Features

Appendix

Index



TOSHIBA AMERICA CONSUMER PRODUCTS, INC.

HEAD OFFICE: 82 TOTOWA ROAD, WAYNE, NJ 07470, U.S.A.
NATIONAL SERVICE DIVISION: 1420-B TOSHIBA DRIVE, LEBANON, TN 37087, U.S.A.

TOSHIBA HAWAII, INC.

HEAD OFFICE: 327 KAMAKEE STREET, HONOLULU, HI 96814, U.S.A. – TEL: (808) 591-9281

TOSHIBA OF CANADA LTD.

HEAD OFFICE: 191 McNABB STREET, MARKHAM, ONTARIO, L3R 8H2, CANADA – TEL: (905) 470-5400

SERVICE CENTERS:

TORONTO: 191 McNABB STREET, MARKHAM, ONTARIO L3R 8H2, CANADA – TEL: (905) 470-5400

MONTREAL: 1643 NORTH SERVICE RD., TRANS-CANADA HIGHWAY, DORVAL QUEBEC, H9P 1J1, CANADA – TEL: (514) 856-4100

VANCOUVER: 22171 FRASERWOOD WAY, RICHMOND, B.C., V6W 1J5, CANADA – TEL: (604) 303-2500

MANUFACTURED BY

TOSHIBA AMERICA CONSUMER PRODUCTS, INC.

CYCLONE is a registered trademark of Toshiba Corporation.

ColorStream and StableSound are registered trademarks of Toshiba America Consumer Products, Inc.

CableClear and SurfLock are trademarks of Toshiba America Consumer Products, Inc.

PRINTED IN USA
(03-08) RP

TOSHIBA

Free Manuals Download Website

<http://myh66.com>

<http://usermanuals.us>

<http://www.somanuals.com>

<http://www.4manuals.cc>

<http://www.manual-lib.com>

<http://www.404manual.com>

<http://www.luxmanual.com>

<http://aubethermostatmanual.com>

Golf course search by state

<http://golfingnear.com>

Email search by domain

<http://emailbydomain.com>

Auto manuals search

<http://auto.somanuals.com>

TV manuals search

<http://tv.somanuals.com>