

Contents

SETTING UP

Safety precautions – Some do's and don'ts for you to be aware of	4
Installation and important information	5
The remote control – an at-a-glance guide	6
Connecting external equipment – a guide to connecting external equipment to the back of the television	7
Connecting a computer – connecting a computer to the back of the television	8
Controls and input connections – switching on the television, standby, using the controls on the television, headphone socket, connecting equipment to the side input sockets	9

TUNING THE TELEVISION

DIGITAL – tuning the television for the first time	10
DIGITAL – auto tuning	11
DIGITAL – programme sorting, manual tuning	12
ANALOGUE – tuning analogue mode for the first time, language, country	13
ANALOGUE – manual tune, broadcast system	14
ANALOGUE – auto tune	15
ANALOGUE – programme skip, sorting programme positions	16

CONTROLS AND FEATURES

General controls – changing programme position	17
Stereo and bilingual transmissions – stereo/mono or dual language broadcasts	17
Time display (<i>analogue</i> only)	17
Sound controls – volume, sound mute, bass/treble/balance	17
Sound controls – bass boost, super woofer, dual (<i>analogue</i> only), stable sound®	18
SRS WOW™ sound effects – SRS 3D, FOCUS and TruBass	18
Widescreen viewing	19
Picture controls – picture position (<i>analogue</i> only), back light	21
Picture controls – picture preferences (contrast, brightness, colour, tint, sharpness), black stretch, MPEG noise reduction (MPEG NR), digital noise reduction (DNR)	22
Picture controls – colour temperature, 3D colour management, base colour adjustment	23
Picture controls – active backlight control, cinema mode, antenna amplifier, automatic format (widescreen)	24
Picture controls – 4:3 stretch, blue screen, side panel adjustment, picture still	25
Panel lock – disabling the buttons on the television	25
DIGITAL – programme timer	26
Sleep timer	26
DIGITAL – on-screen information and programme guide	27
DIGITAL settings – parental controls (setting the PIN, mode)	28
DIGITAL settings – favourite programmes, locked programmes, encrypted programmes	29
DIGITAL settings – audio languages, audio output, subtitles, reset TV, common interface	30
DIGITAL settings – software upgrade (version, automatic upgrade, searching for new software)	31
PC settings – picture position, clock phase, sampling clock, reset	32
Input selection and AV connections – input and output sockets for connected equipment, <i>analogue</i> switch off	33

TEXT SERVICES

ANALOGUE text – setting up, general information, Auto. and LIST modes	35
ANALOGUE text – control buttons	36
DIGITAL interactive services – general information	36

PROBLEM SOLVING

Questions and Answers – answers to some of the more common queries including manual fine tuning and colour system	37
--	----

INFORMATION

Notes – for your own records	40
Information – signal information	41
Specifications and Accessories – technical information about the television, supplied accessories	42

Safety Precautions

This equipment has been designed and manufactured to meet international safety standards but, like any electrical equipment, care must be taken to obtain the best results and for safety to be assured. Please read the points below for your own safety. They are of a general nature, intended to help with all electronic consumer products and some points may not apply to the goods you have just purchased.

Air Circulation

Leave more than 10cm clearance around the television to allow adequate ventilation. This will prevent overheating and possible damage to the television. Dusty places should also be avoided.

Heat Damage

Damage may occur if the television is left in direct sunlight or near a heater. Avoid places subject to extremely high temperatures or humidity. Place in a location where the temperature remains between 5°C (41°F) min. and 35°C (94°F) max.

Mains Supply

The mains supply required for this equipment is 220-240v AC 50/60Hz. Never connect to a DC supply or any other power source. DO ensure that the television is not standing on the mains lead. DO NOT cut off the mains plug from this equipment, this incorporates a special Radio Interference Filter, the removal of which will impair its performance. In the UK, the fuse fitted in this plug is approved by ASTA or BSI to BS1362. It should only be replaced by a correctly rated and approved type and the fuse cover must be refitted. IF IN DOUBT PLEASE CONSULT A COMPETENT ELECTRICIAN.

Do

DO read the operating instructions before you attempt to use the equipment.

DO ensure that all electrical connections (including the mains plug, extension leads and inter-connections between pieces of equipment) are properly made and in accordance with the manufacturers' instructions. Switch off and withdraw the mains plug before making or changing connections.

DO consult your dealer if you are ever in doubt about the installation, operation or safety of your equipment.

DO be careful with glass panels or doors on equipment.

DO NOT REMOVE ANY FIXED COVERS AS THIS WILL EXPOSE DANGEROUS AND 'LIVE' PARTS.

THE MAINS PLUG IS USED AS A DISCONNECTING DEVICE AND THEREFORE SHOULD BE READILY OPERABLE.

Do not

DO NOT obstruct the ventilation openings of the equipment with items such as newspapers, tablecloths, curtains, etc. Overheating will cause damage and shorten the life of the equipment.

DO NOT allow electrical equipment to be exposed to dripping or splashing or objects filled with liquids, such as vases, to be placed on the equipment.

DO NOT place hot objects or naked flame sources, such as lighted candles or nightlights on, or close to equipment. High temperatures can melt plastic and lead to fires.

DO NOT use makeshift stands and NEVER fix legs with wood screws. To ensure complete safety, always fit the manufacturers' approved stand, bracket or legs with the fixings provided according to the instructions.

DO NOT leave equipment switched on when it is unattended, unless it is specifically stated that it is designed for unattended operation or has a standby mode. Switch off by withdrawing the plug, make sure your family know how to do this. Special arrangements may need to be made for people with disabilities.

DO NOT continue to operate the equipment if you are in any doubt about it working normally, or it is damaged in any way – switch off, withdraw the mains plug and consult your dealer.

WARNING – excessive sound pressure from earphones or headphones can cause hearing loss.

ABOVE ALL – NEVER let anyone, especially children, push or hit the screen, push anything into holes, slots or any other openings in the case.

NEVER guess or take chances with electrical equipment of any kind – it is better to be safe than sorry.

Installation and important information

Where to install

Locate the television away from direct sunlight and strong lights, soft, indirect lighting is recommended for comfortable viewing. Use curtains or blinds to prevent direct sunlight falling on the screen.

Place on a sturdy platform, the mounting surface should be flat and steady. **It must be secured to the wall with a sturdy tie using the clip on the back of the stand, or secured to the platform using the fixing strap located underneath the table top stand, this will prevent it from falling over.**

The LCD display panels are manufactured using an extremely high level of precision technology, however sometimes some parts of the screen may be missing picture elements or have luminous spots. This is not a sign of a malfunction.

Make sure the television is located in a position where it cannot be pushed or hit by objects, as pressure will break or damage the screen, and that small items cannot be inserted into slots or openings in the case.

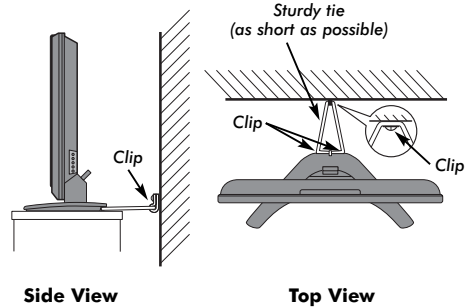

Please take note

EXCLUSION CLAUSE

Toshiba shall under no circumstances be liable for loss and/or damage to the product caused by:

- i) fire;
- ii) earthquake;
- iii) accidental damage;
- iv) intentional misuse of the product;
- v) use of the product in improper conditions;
- vi) loss and/or damage caused to the product whilst in the possession of a third party;
- vii) any damage or loss caused as a result of the owner's failure and/or neglect to follow the instructions set out in the owner's manual;
- viii) any loss or damage caused directly as a result of misuse or malfunction of the product when used simultaneously with associated equipment;

Furthermore, under no circumstances shall Toshiba be liable for any consequential loss and/or damage including but not limited to the following, loss of profit, interruption of business, the loss of recorded data whether caused during normal operation or misuse of the product.

NOTE: A Toshiba wall bracket or stand, where available, must be used. If a non Toshiba wall bracket or stand is used the product's BEAB approval will become void and the equipment is then used at the consumers own risk.

If stationary images generated by text services, channel identification logos, computer displays, video games, on screen menus, etc. are left on the television screen for any length of time they could become conspicuous, it is always advisable to reduce both the brightness and contrast settings.

The remote control

Simple at-a-glance reference of your remote control.

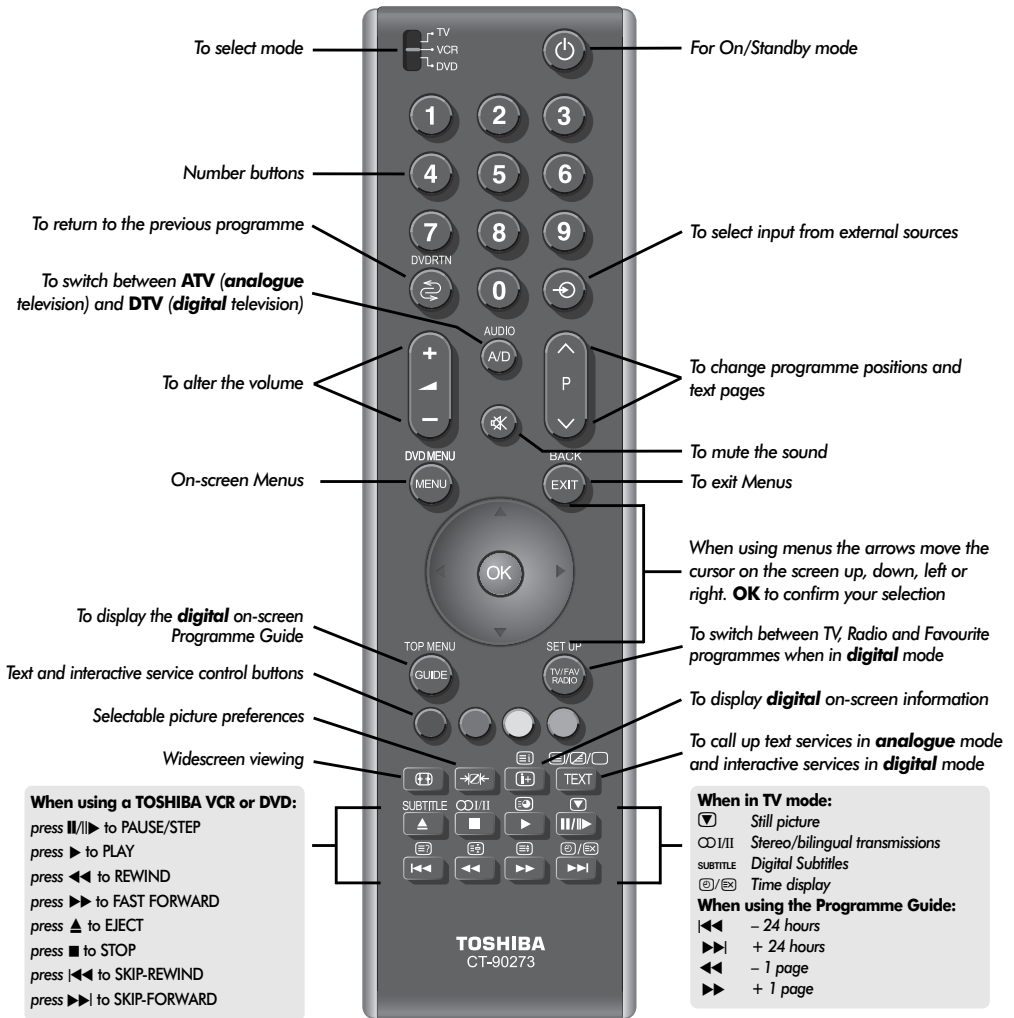

Inserting batteries and effective range of the remote

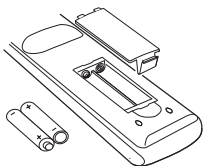

Remove the back cover to reveal the battery compartment and make sure the batteries are inserted the right way round. Suitable battery types for this remote are AAA, IEC R03 1.5V.

Do not combine a used, old battery with a new one or mix battery types. Remove dead batteries immediately to prevent acid from leaking into the battery compartment. Dispose of them in a designated disposal area. **Warning:** batteries must not be exposed to excessive heat such as sunshine, fire or the like.

The performance of the remote control will deteriorate beyond a distance of five metres or outside an angle of 30 degrees from the centre of the television. If the operating range becomes reduced the batteries may need replacing.

Connecting external equipment

Before connecting any external equipment, turn off all main power switches. If there is no switch remove the mains plug from the wall socket.

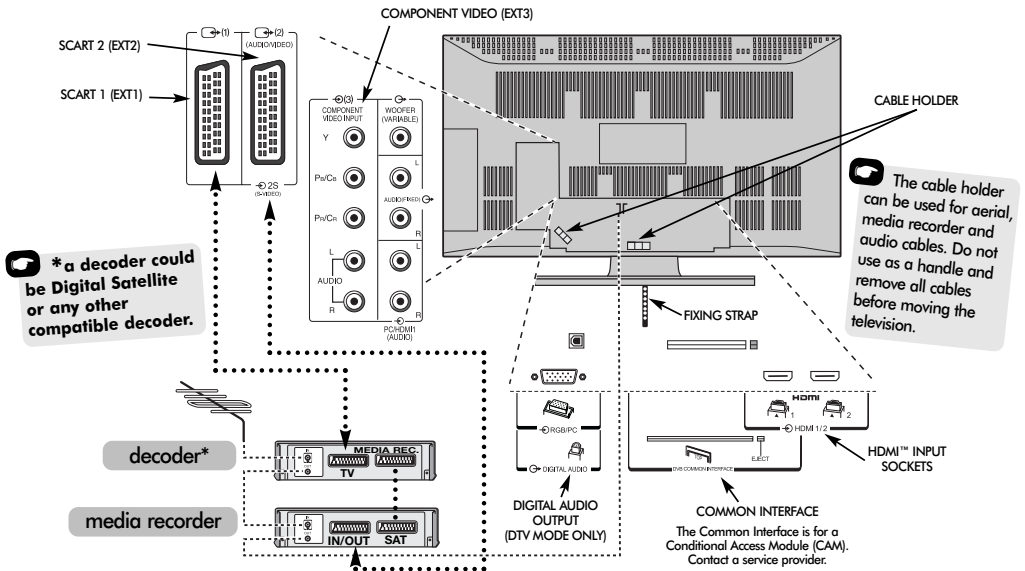

Aerial cables: - - - - -

Connect the aerial to the socket on the rear of the television. If you use a decoder* and/or a media recorder it is essential that the aerial cable is connected through the decoder and/or through the media recorder to the television.

SCART leads:

Connect the video recorder **IN/OUT** socket to the television. Connect the decoder **TV** socket to the television. Connect the media recorder **SAT** socket to the decoder **MEDIA REC** socket.

Before running **Auto tuning** put your decoder and media recorder to **Standby**.

The phono sockets alongside the COMPONENT VIDEO INPUT sockets will accept L and R audio signals.

The Digital Audio Output socket enables the connection of a suitable surround sound system. **NOTE: this output is always active.**

In addition there is a fixed external audio output which enables the connection of a suitable Hi-Fi unit. Make sure the **Speaker** option in the **Sound** menu is set to **Off**.

HDMI™ (High-Definition Multimedia Interface) is for use with a DVD, decoder or electrical equipment with digital audio and video output.

It is designed for best performance with 1080i and 1080p high-definition video signals but will also accept and display 480i, 480p, 576i, 576p and 720p signals. **NOTE:** For 1080p it is recommended that approved HDMI cable up to 5m long is used. If the unit has DVI output a special conversion cable from DVI to HDMI will be required.

PLEASE NOTE: Although this television is able to connect to HDMI equipment it is possible that some equipment may not operate correctly.

A wide variety of external equipment can be connected to the back of the television, therefore the relevant owners manuals for all additional equipment must be referred to.

We recommend SCART 1 for a decoder and SCART 2 for a media recorder. If connecting S-VIDEO equipment, set the **INPUT** for **EXT2**. See page 33.

If the television automatically switches over to monitor external equipment, return to normal television by pressing the desired programme position button. To recall external equipment, press **↺** to select between **DTV, EXT1, EXT2, EXT3, HDMI1, HDMI2, PC** or **ATV**.

HDMI, the HDMI logo, and High-Definition Multimedia Interface are trademarks or registered trademarks of HDMI Licensing, LLC.

Connecting a computer

Before connecting any external equipment, turn off all main power switches. If there is no switch remove the mains plug from the wall socket.

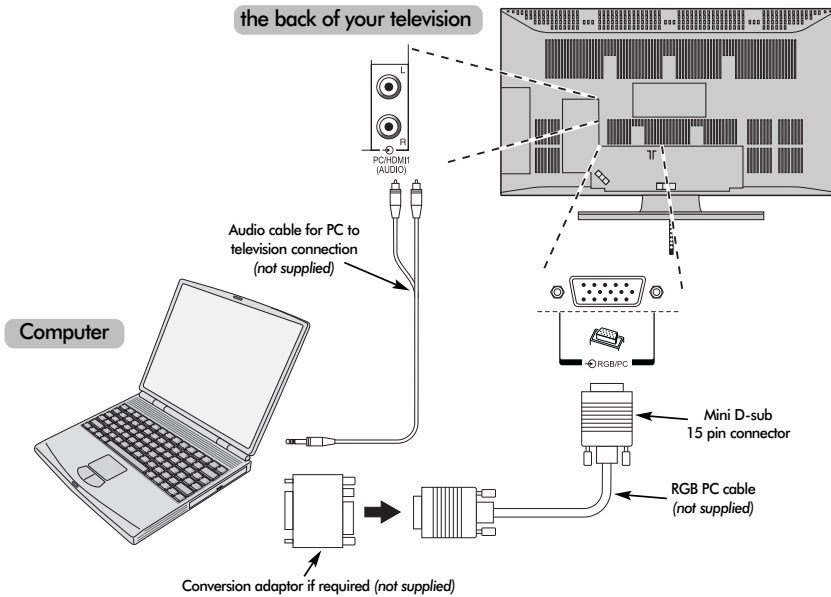

Connect the PC cable from the computer to the PC terminal on the back of the television.

Connect the audio cable to the PC/HDMI Audio socket on the back of the television. Select **PC** from the **PC/HDMI audio** options in the **AV connection** menu located in the **SET UP** menu.

Press the to select PC mode.

PLEASE NOTE:

Some PC models cannot be connected to this television.

An adaptor is not needed for computers with a DOS/V compatible mini D-sub 15 pin terminal.

A band may appear at the edges of the screen or parts of the picture may be obscured. This is due to scaling of the picture by the set, it is not a malfunction.

When PC input mode is selected some of the television's features will be unavailable e.g. **Manual setting** in the **SET UP** menu, **Colour**, **Tint**, **DNR** and **Black Stretch** in the **Picture settings** menu.

The following signals can be displayed:

VGA: 640 x 480/60 Hz (VESA)
VGA: 640 x 480/75 Hz (VESA)
SVGA: 800 x 600/60 Hz (VESA)
SVGA: 800 x 600/75 Hz (VESA)
XGA: 1024 x 768/60 Hz (VESA)
XGA: 1024 x 768/70 Hz (VESA)
XGA: 1024 x 768/75 Hz (VESA)
WXGA: 1280 x 768/60 Hz (VESA)
WXGA: 1280 x 768/60 Hz (VESA) – Reduced Blanking
WXGA: 1280 x 768/75 Hz (VESA)
WXGA: 1360 x 768/60Hz (VESA)
SXGA: 1280 x 1024/60 Hz
SXGA: 1280 x 1024/75 Hz

IMPORTANT NOTE: SXGA will display but it will not be to VESA standards.

When connecting a PC using HDMI the following signals can be accepted:

1080i 50/60Hz
1080p 50/60Hz
720p 50/60Hz

Controls and input connections

A wide variety of external equipment can be connected to the input sockets on the side of the television.

Whilst all the necessary adjustments and controls for the television are made using the remote control, the buttons on the television may be used for some functions.

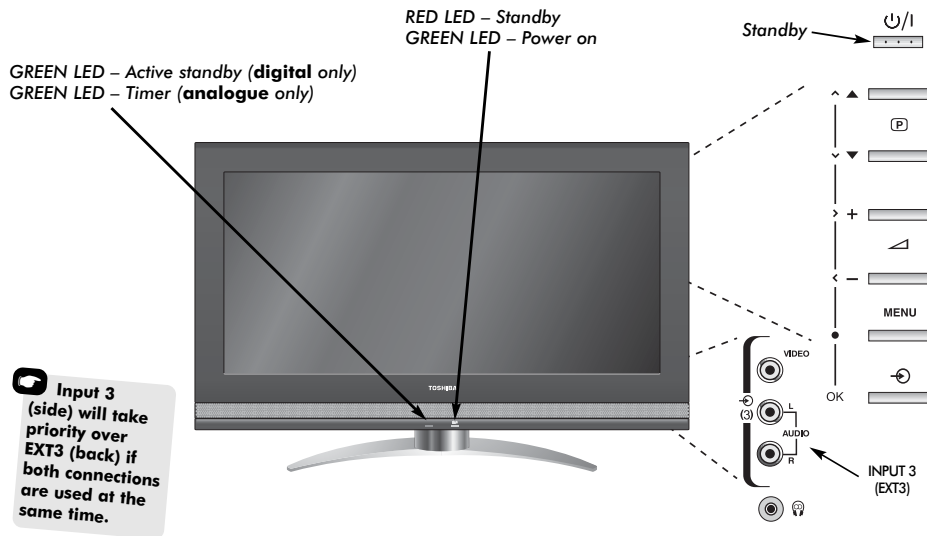

Switching on

If the RED LED is unlit check that the mains plug is connected to the power supply. If the picture does not appear press on the remote control, it may take a few moments.

To put the television into Standby press on the remote control, the GREEN active standby LED will appear (see 'Software Upgrade' section) next to the RED for a few moments then disappear. To view the television press again. The picture may take a few seconds to appear.

Using the remote control

Press the **MENU** button on the remote control to see the menus.

In **digital** mode the menu bar at the top of the screens will show three different topics shown in symbols. As each symbol is selected by pressing the or button on the remote control, its respective options will appear below.

In **analogue** mode the menu appears as a list of five topics. As each symbol is selected by pressing the or button on the remote control, its respective options will appear below.

To use the options press the and button on the remote control to move up and down through them and **OK**, or to select the required choice. Follow the on screen instructions. The functions of each menu are described in detail throughout the manual.

Using the controls and connections

To alter the volume press .

To alter the programme position press **P** .

Press **MENU** and , , or to control the sound and picture options.

Press **MENU** twice to finish.

When connecting sound equipment to **EXT3**, connect the audio output of the equipment to the phono sockets on the television.

To select the Input, press until the display shows **EXT3** as described on page 33. The television will automatically sense the type of signal.

Please always refer to the owner's manual of the equipment to be connected for full details.







Please note: Inserting the headphone plug will mute the sound from all speakers.

Tuning Digital television for the first time

Before switching on the television put your decoder and media recorder to **Standby** if they are connected and ensure the aerial is connected. To set up the television use the buttons on the remote control as detailed on page 6.

- 1 Press the  button, the **LOCAL OPTIONS** screen will appear. This screen will appear the first time that the television is switched on and each time the television is reset.



- 2 Press  to highlight **Country** and  or  to select. The television will now tune the stations for your country.
- 3 Using  highlight **Language**, then  or  to select.
- 4 Press **OK** to start tuning.

The **AUTO TUNING** screen will appear and the television will start to search for available stations. The progress bar will move along the line.

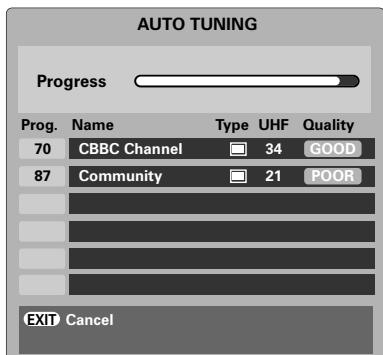

You must allow the television to complete the search.



When the search is complete the television will automatically select programme one.

The **AUTO TUNING** screen will display the total number of services found.



- 5 Use  or  to move through the list to select a programme then press **OK** to view.

NOTE: The time will be set automatically by transmission but can be advanced or decreased by up to 2 hours using **Local Time Settings**.

Digital auto tuning

NOTE: As new services are broadcast it will be necessary to re-tune the television in order to view them.

Auto tuning

Auto tuning will completely re-tune the television and can be used to up date the channel list.

It is recommended that Auto tuning is run periodically to ensure that all new services are added. All current programmes and settings, i.e. favourites and locked programmes, will be lost.

- 1 Press **MENU**, the **SETUP MENU** will appear. Use **▼** to highlight **Auto tuning**. Press **OK**.
- 2 A screen will appear warning that previous digital programmes and settings will be deleted. Press **OK** to continue with the **Auto tuning**.

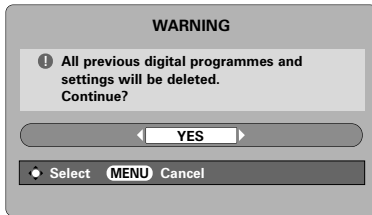

The television will start to search for all available stations.

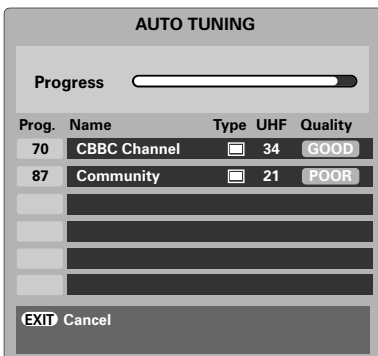

You must allow the television to complete the search.

When the search is complete the **Auto tuning** screen will display the total number of services found.



- 3 Use **▼** or **▲** to move through the list to select a programme then press **OK** to view.

Digital programme sorting, manual tuning

NOTE: When the television is switched off the mode being viewed at the time will automatically be selected when the television is switched back on.

Programme sorting

- 1 The station order may be changed to suit personal preference. Press **MENU**, the **SETUP MENU** will appear on screen.
- 2 Use **▼** to move down through the list and highlight **Programmes**. Press **OK**.



- 3 With the list of stations now showing use **▼** or **▲** to highlight the station you want to move and press **►**.

The selected station will be moved to the right of the screen.

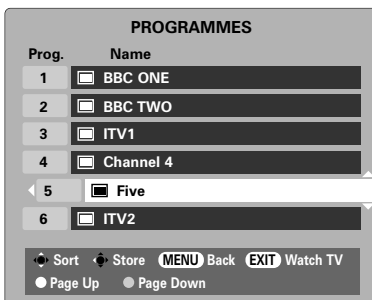

- 4 Use **▼** or **▲** to move through the list to your preferred position. As you do so the other stations will move to make room.
- 5 Press **◀** to store your move. Repeat as necessary, then press **EXIT**.

Manual tuning

This feature is available for service engineers or can be used for direct channel entry if the multiplex channel is known.

- 1 Select **Manual tuning** from the **SETUP MENU** and press **OK**.
- 2 Enter the multiplex number using the number buttons and then press **OK**. The television will automatically search for that multiplex.

When the multiplex is found any channels not currently on the programme list will be added and the programme information at the top of the screen will be updated.

- 3 Repeat as necessary. Press **EXIT** to finish.

Tuning **Analogue** mode for the first time

The **Quick Setup** feature will tune all **analogue** channels currently available in the area. To put the television into **ATV** mode press the **A/D** button.

- 1 Select **ATV** mode. The **Quick Setup** screen will appear.



- 2 Using ◀ or ▶ select your **language**, then press **OK**.
- 3 Then press ◀ or ▶ to select your **country**.
- 4 To start **Auto tuning** press **OK**.

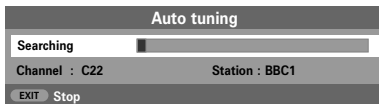

- 5 The search will begin for all available stations. The slide bar will move along the line as the search progresses.

You must allow the television to complete the search.

When the search is complete the television will automatically select programme position 1 and the **Manual tuning** screen will appear.

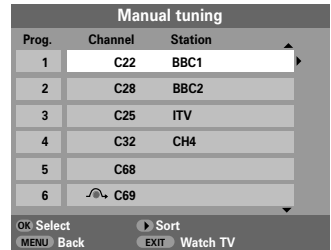

- 6 Use ▼ or ▲ to move through the list to select a programme then press **EXIT** to view.

The station order may be changed using the **Manual tuning** screen (see the **analogue** 'Sorting programme positions' section).

Analogue manual tune

The television can be tuned-in manually using **Manual tuning**. For example: if the television cannot be connected to a media recorder/decoder with a SCART lead or to tune-in a station on another **System**.

Use ◀ and ▶ to move across the screen and select any of these Manual Tune options.

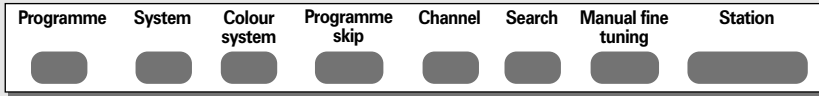

Programme: The number to be pressed on the remote control.

System: Specific to certain areas.

Colour system: Factory set to Auto, should only be changed if problems are experienced, *i.e.* NTSC input from external source.

Programme skip: means nothing has been stored or the facility to *skip* the channel is ON. See page 16.

Channel: The channel number on which a station is being broadcast.

Search: Search up and down for a signal.

Manual fine tuning: Only used if interference/weak signal is experienced. See page 37.

Station: Station identification. Use the ▲ or ▼ and ◀ or ▶ buttons to enter up to seven characters.

To allocate a programme position on the television for a decoder and media recorder: turn the decoder on, insert a pre-recorded film in the media recorder and press PLAY, then manually tune.

- 1 Press **MENU** and using ◀ or ▶ select the **SET UP** menu, with ▼ highlight **Manual tuning**, press **OK** to select.



- 2 Use ▲ or ▼ to highlight the programme position required e.g. we suggest **Prog. 0** for a media recorder.

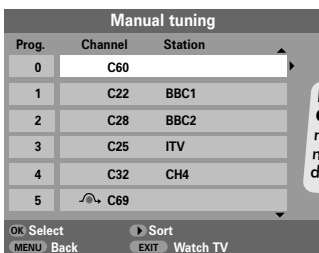

Different Channel numbers may be displayed

- 3 Press **OK** to select. If the programme is skipped, **Programme skip** must be removed before storing.



- 4 Press ▶ to select **System** and use ▲ or ▼ to change if required.

- 5 Then press ▶ to select **Search**.

- 6 Press ▲ or ▼ to begin the search. The search symbol will flash.



- 7 Each signal will show on the television, if it is not your media recorder, press ▲ or ▼ again to restart the search.

Analogue manual tune continued,

Auto tune

- 8** When your media recorder signal is found, press **▶** to move along to **Station**. With **▲**, **▼**, **◀** and **▶** put in the required characters, e.g. **VCR**.



- 9** Press **OK** to store.
- 10** Repeat for each **programme position** you want to tune or, press **MENU** to return to the list of channels and select the next number to tune.
- 11** Press **EXIT** when you have finished.
- 12** To name external equipment, e.g. DVD on EXT2, press **↶** to select **↶2**, then select **Manual setting** from the **SET UP** menu.
- 13** Press **▶** to select **Label** then using **▲**, **▼**, **◀** and **▶** put in the required characters. Press **OK**.



PLEASE NOTE This television has direct channel entry if the channel numbers are known. Select the **Manual tuning** screen in **Step 3**. Enter the **Programme number**, the **System**, then **C** for standard (terrestrial) channels or **S** for cable channels and the **Channel** number. Press **OK** to store.

Using Auto tuning

- 1** To set up the television using **Auto tuning**, press **MENU** and use **◀** or **▶** to select the **SET UP** menu.



- 2** Press **▼** to highlight **Language** and **◀** or **▶** to select.
- 3** Using **▼** highlight **Country**, then **◀** or **▶** to select. The television will now tune the stations for your country.
- 4** Press **▼** to highlight **Auto tuning**, then press **OK**.

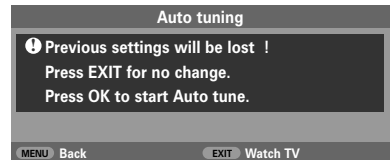

- 5** To start **Auto tuning** press **OK**.

You must allow the television to complete the search.

When the search is complete the television will automatically select programme position 1. This may not be a clear picture, so the station order can be changed (see 'Sorting programme positions' section).

Analogue programme skip, sorting programme positions

Programme skip

To prevent certain programmes from being viewed, the programme position can be skipped. The remote control must be removed as the channels will still be available using the number buttons. Programmes can then be watched as normal using the controls on the television, but the television will not show the skipped programme position.

- 1 Select **Manual tuning** from the **SET UP** menu.

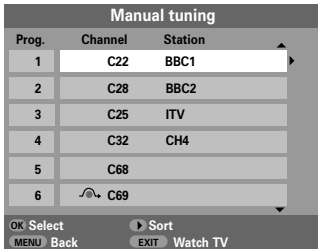

- 2 Use **▲** or **▼** to highlight the programme position to be skipped and press **OK** to select.
- 3 Press **▶** to select **Programme skip**.
- 4 Use **▲** or **▼** to turn **Programme skip** on. Press **OK**.

 on the screen indicates a skipped programme position.



- 5 Press **MENU** and repeat from **Step 2** or press **EXIT**.

Each programme position has to be *individually* selected. To turn **Programme skip** off, repeat the procedure for each position.

Skipped programme positions **cannot** be selected by **P ▲** and **P ▼** or by the controls on the television, but **can** still be accessed by the number buttons on the remote control.

Sorting programme positions

Channels may be moved and stored on the programme position of your choice.

- 1 Select **Manual tuning** from the **SET UP** menu.
- 2 With the list of stations now showing use **▼** or **▲** to highlight the station you want to move and press **▶**.

The selected station will be moved to the right of the screen.

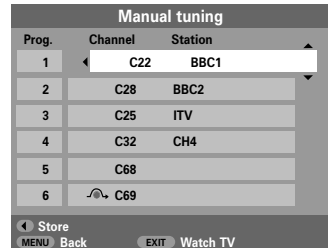

- 3 Use **▼** or **▲** to move through the list to your preferred position. As you do so the other stations will move to make room.
- 4 Press **◀** to store your move.
Repeat as necessary, then press **EXIT**.

Sound controls continued, SRS WOW™ sound effects, dual, stable sound®

Bass boost

Bass boost enhances the depth of the sound on the TV speakers. The difference will only be noticeable on sound with a strong bass.

- 1 In the **SOUND** menu press ▼ to highlight **Bass boost**. Use ◀ or ▶ to select **On**.
- 2 Then press ▼ to highlight **Bass boost level** and using ◀ or ▶ adjust to suit your preference.



When an active Super Woofer is connected to the Woofer Out connection on the back of the television, select **AV connection** in the **SET UP** menu, press ▼ to highlight **Woofer** and using ◀ or ▶ select **External**. (See 'Input Selection and AV Connections' section).

SRS WOW™ sound effects

SRS WOW™ is a suite of audio effects which use the stereo signals being broadcast to produce enhanced sound from the television's speakers. If mono sound is broadcast only **TruBass** will be available.

SRS 3D gives a rich sound experience, **FOCUS** concentrates the sound and gives the effect of it coming from the centre of the television, **TruBass** enhances the lower bass frequencies.

- 1 Press **MENU** and select the **SOUND** menu.
- 2 Use ▲ or ▼ to highlight **WOW** then press **OK**.



- 3 Press ▼ to highlight **SRS 3D** and using ◀ or ▶ select between **On** or **Off**.
- 4 Then press ▼ to highlight **FOCUS** and press ◀ or ▶ to select between **On** or **Off**.
- 5 Highlight **TruBass** and use ◀ or ▶ to select **Off**, **Low** or **High** to suit your preference.

NOTE: This feature is not available through headphones.

Dual – analogue only

If a programme or film is being broadcast with a soundtrack in more than one language, the **DUAL** feature allows selection between them.

- 1 Select the **SOUND** menu.
- 2 Use ▼ to highlight **Dual** then press ◀ or ▶ to choose between **Dual 1** or **Dual 2**.

Stable sound®

The **Stable Sound** feature limits high volume levels on the TV speakers, preventing the extreme changes in volume that can occur when channels are changed or a programme switches to a commercial.

- 1 Select the **SOUND** menu.
- 2 Use ▼ to highlight **Stable sound** then press ◀ or ▶ to select **On** or **Off**.

Widescreen viewing

Depending on the type of broadcast being transmitted, programmes can be viewed in a number of formats. Press the  button repeatedly to select between **PC**, **Exact scan**, **Wide**, **Super Live 2**, **Cinema 2**, **4:3**, **Super Live 1**, **Cinema 1**, **Subtitle** and **14:9**.

SUPER LIVE 1

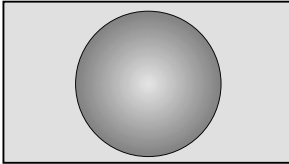

This setting will enlarge a 4:3 image to fit the screen by stretching the image horizontally and vertically, holding better proportions at the centre of the image. Some distortion may occur.

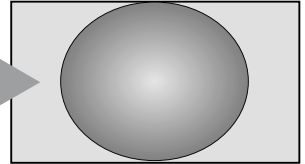

SUPER LIVE 2

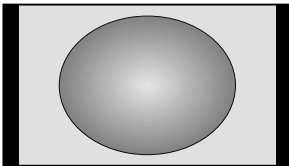

If a 'side panel format' signal is being received this setting will enlarge the image to fit the screen by stretching the image horizontally and vertically, holding better proportions at the centre of the image. Some distortion may occur.

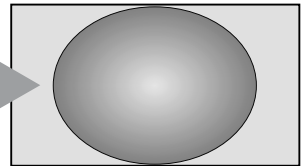

CINEMA 1

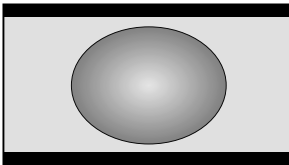

When watching 'letterbox format' films/video tapes, this setting will eliminate or reduce the black bars at the top and bottom of the screen by zooming in and selecting the image without distortion.

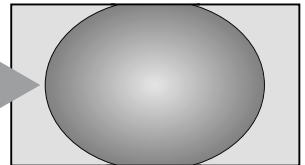

CINEMA 2

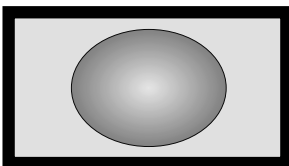

When watching 'all sides panel format' films/video tapes, this setting will eliminate or reduce the black bars at all sides of the screen by zooming in and selecting the image without distortion.

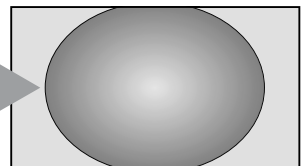

SUBTITLE

When subtitles are included on a letterbox format broadcast, this setting will raise the picture to ensure that all the text is displayed.

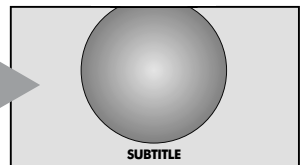

Widescreen viewing continued

14:9

Use this setting when watching a 14:9 broadcast.

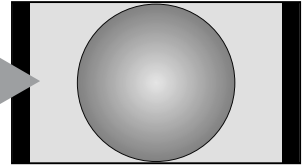

WIDE

Use this setting when watching a widescreen DVD, widescreen video tape or a 16:9 broadcast (when available). Due to the range of widescreen formats (16:9, 14:9, 20:9 etc.) black bars may be visible on the top and bottom of the screen.

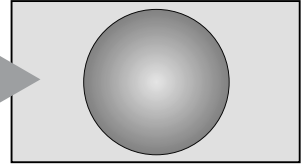

4:3

Use this setting to view a true 4:3 broadcast.

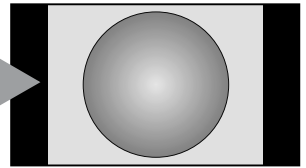

FULL HD MODELS

 This option is only available when watching a 1080 source.

EXACT SCAN



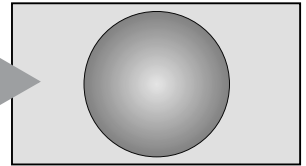

Use this setting when watching a 1080 source, it will display the image as transmitted without scaling or cropping the picture.

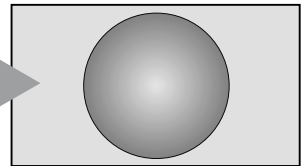

PC

When using a PC connected via HDMI this setting will show the picture without over scan, i.e. WYSIWYG.



Press the  button and a list of all the widescreen formats will appear on screen. Use  and  to highlight the required format and  to select.

When a PC is connected via HDMI it will be selectable in the widescreen format list.

PC
Exact Scan
Wide
Super Live 2
Cinema 2
4:3
Super Live 1
Cinema 1
Subtitle
14:9

Using the special functions to change the size of the displayed image (i.e. changing the height/width ratio) for the purposes of public display or commercial gain may infringe on copyright laws.

Picture controls

Most of the picture controls and functions are available in both **digital** and **analogue** modes. To access the required menus when in **digital** mode: press **MENU** and using ▼ select **TV setup**, press **OK** then ◀ or ▶ to select the desired menu. *PLEASE NOTE: features not available in digital mode will be greyed out.* To access the required menus when in **analogue** mode: press **MENU** and use ◀ or ▶ to select the desired menu.

Picture position – analogue only

The picture position may be adjusted to suit personal preference and can be particularly useful for external inputs.

- 1 In the **SET UP** menu press ▼ until **Picture position** is highlighted.



- 2 Press **OK** to view the options available for the picture format that has been selected.
- 3 Press ▲ and ▼ to select an option, then ◀ or ▶ to adjust the settings.

The options alter depending on the widescreen format chosen and when viewing connected equipment.

In **Cinema 2**:



To return to the original factory settings select **Reset** in the **Picture position** menu and press **OK**.

Backlight

Adjusting the **Backlight** can improve the clarity of the screen when viewing.

- 1 In the **PICTURE** menu press ▼ to select **Picture settings**, then press **OK**.

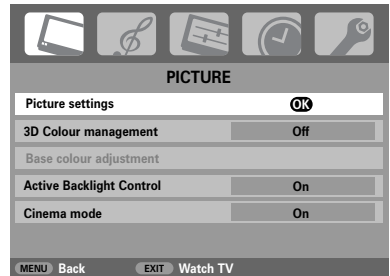

- 2 In the **Picture settings** menu press ▼ to select **Backlight**.
- 3 Press ◀ or ▶ to adjust.

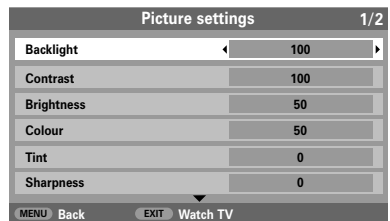

Picture controls continued

Picture preferences

This television offers the choice of personalising the picture style. Press \rightarrow / \leftarrow to view the different styles available:

Picture mode-1 to 3 are preset options and effect many features/settings within the television, **Picture mode-M** stores your own settings as detailed below:

- 1 Select **Picture settings** from the **PICTURE** menu.

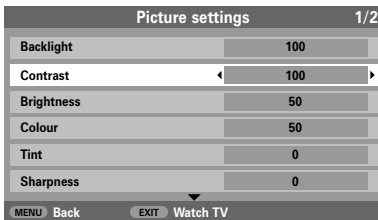

- 2 Use \leftarrow or \rightarrow to adjust the **Contrast**, **Brightness**, **Colour**, **Tint** and **Sharpness**.

Black stretch

Black Stretch increases the strength of dark areas of the picture which improves the definition.

- 1 In the **Picture settings** menu press ∇ until **Black Stretch** is highlighted.

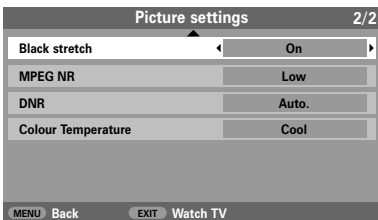

- 2 Press \leftarrow or \rightarrow to select between **On** and **Off**. The effect depends on the broadcast and is most noticeable on dark colours.

MPEG NR – Noise Reduction

When watching a DVD the compression may cause some words or picture elements to become distorted or pixelated.

Using the **MPEG NR** feature reduces this effect by smoothing out the edges.

- 1 Select **MPEG NR** from the **Picture settings** menu.

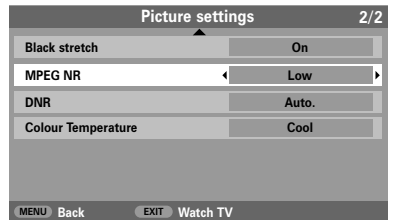

- 2 Use \leftarrow or \rightarrow to select a setting to suit your preference.

DNR – Digital Noise Reduction

DNR enables you to 'soften' the screen representation of a weak signal to reduce the noise effect.

- 1 Select **DNR** from the **Picture settings** menu.

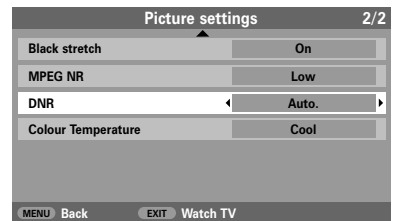

- 2 Use \leftarrow or \rightarrow to adjust. The differences may not always be noticeable (for the best result use lower settings as picture quality can be lost if the setting is too high).

Picture controls continued

Colour temperature

Colour Temperature increases the 'warmth' or 'coolness' of a picture by increasing the red or blue tint.

- 1 In the **Picture settings** menu press ▼ until **Colour Temperature** is highlighted.

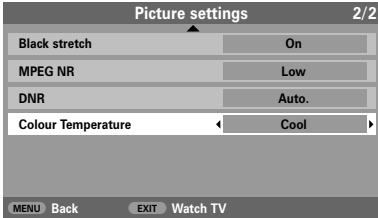

- 2 Press ◀ or ▶ to select between **Normal**, **Warm** and **Cool** to suit your preference.

3D Colour management

When **3D Colour management** is selected it allows the 'Base colour adjustment' feature to become available.

- 1 In the **PICTURE** menu press ▼ to select **3D Colour management**.

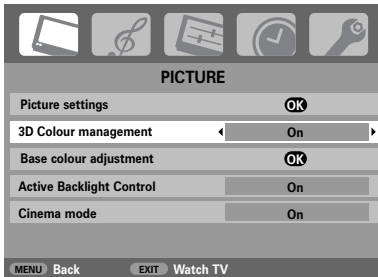

- 2 Press ◀ or ▶ to select **On** or **Off**.

Base colour adjustment

The **Base colour adjustment** feature allows the adjustment of individual colours to suit personal preference. This can be useful when using an external source.

- 1 In the **PICTURE** menu press ▼ to select **Base colour adjustment**, then press **OK**.

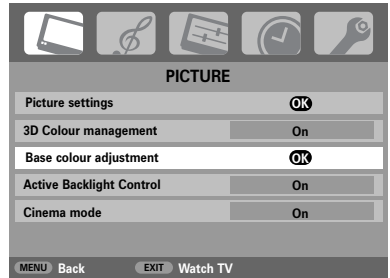

- 2 Press ▲ and ▼ to select an option, then ▶ to adjust the settings.

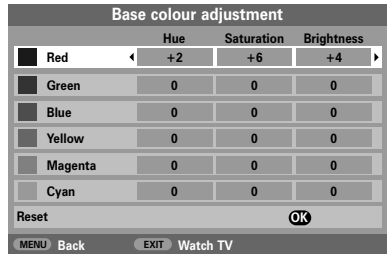

To return to the original factory settings select **Reset** and press **OK**.

Picture controls continued

Active Backlight Control

When **Active Backlight Control** is activated it will automatically optimise the backlighting levels for dark scenes.

- 1 In the **PICTURE** menu press ▼ to select **Active Backlight Control**.

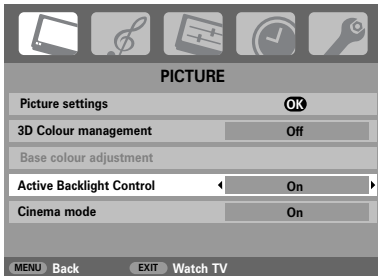

- 2 Press ◀ or ▶ to select **On** or **Off**.

Cinema mode

If there are lines or jagged edges in the film or programme being viewed, selecting **Cinema mode** can help correct this by smoothing out the picture.

- 1 In the **PICTURE** menu press ▼ to select **Cinema mode**.

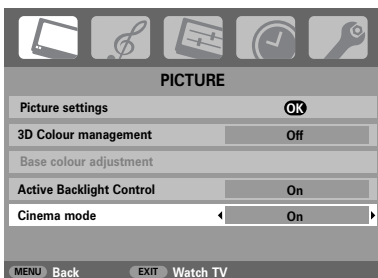

- 2 Press ◀ or ▶ to select **On** or **Off**.

NOTE: When a DVD with subtitles is being played this mode may not work correctly.

Antenna amplifier

If the signal being received by the television is too strong, this may result in picture interference and/or a buzzing sound. Setting **Antenna Amplifier** to **Off** reduces the signal strength, and can help to remove the interference.

- 1 In the **SET UP** menu press ▼ until **Antenna Amplifier** is highlighted.

- 2 With ◀ or ▶ select either **On** or **Off**.



Automatic format (Widescreen)

When this television receives a true Widescreen picture and **Auto format** is **On**, it will automatically be displayed in Widescreen format, irrespective of the television's previous setting.

- 1 Press **MENU** and ◀ or ▶ to select the **FUNCTION** menu.



- 2 Press ▼ to highlight **Auto format**, then ◀ or ▶ to select **On** or **Off**.

Picture controls continued, panel lock

4:3 stretch

When **4:3 stretch** is activated the size switching system changes 4:3 programs into a full screen picture.

- 1 In the **FUNCTION** menu press ▼ to highlight **4:3 stretch**.

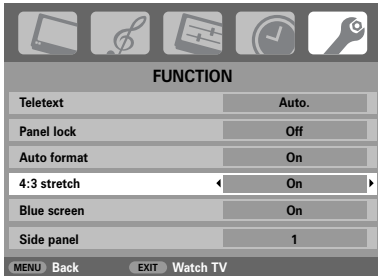

- 2 Press ◀ or ▶ to select **On** or **Off**.

Blue screen

When **Blue screen** is selected the screen will turn blue and the sound will be muted when no signal is received.

- 1 In the **FUNCTION** menu press ▼ to highlight **Blue screen**.



- 2 Press ◀ or ▶ to select **On** or **Off**.

Side panel adjustment

The **Side panel** feature lightens or darkens the band each side of the screen when in 4:3 or 14:9 format. This helps prevent image retention of the band and can also make viewing in bright or dark conditions more comfortable.

- 1 In the **FUNCTION** menu press ▼ until **Side panel** is highlighted.
- 2 Press ◀ or ▶ to adjust.

Picture still

This feature is used to hold a still image on the screen.

- 1 Press ▼ to hold an image on the screen, press ▼ again to cancel.

Panel lock

Panel lock disables the buttons on the television. All buttons on the remote control can still be used.

- 1 From the **FUNCTION** menu select **Panel lock** and choose **On** or **Off** using ◀ or ▶.



When **Panel lock** is **On**, a reminder will appear when the buttons on the television are pressed. **If the standby button is pressed the television will switch off and can only be brought out of standby by using the remote control.**

The timers

Programme timer – digital only

This feature will set the television to go to a specific channel at a certain time. It can be used to view a particular programme, or by setting the mode to daily or weekly, can be used to view a series of programmes.

- 1 Press **MENU** and ◀ or ▶ to select the **TIMER MENU**.



- 2 Press ▼ to select **Programme Timers**, then press **OK** to select.
- 3 Press ▼ to select the first programme to be timed, then press **OK**. The **SET TIMER** menu will now appear on screen.
- 4 Press ▲ and ▼ to go through the list adding the details of the programme to be timed by using the number buttons and ◀ and ▶ to make selections.

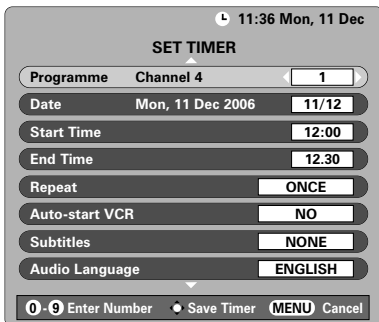

- 5 When all the details have been entered press **OK** to save the timer.

Auto-start VCR: If your Toshiba media recorder is AV link compatible setting this feature to **YES** will auto start/stop a recording.

PLEASE NOTE: When a timed programme is about to start, an information screen will appear offering the option of watching or cancelling the programme. The menus and other channels will not be available during the timed programme unless the programme timer is cancelled.

Sleep timer

The television can be set to turn itself off after a certain time.

- 1 Press **MENU** and ◀ or ▶ to select the **TIMER** menu.

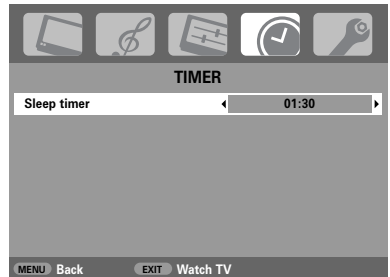

- 2 Press ▼ to select the **Sleep timer**. Use the number buttons to set the required time. For example, to switch the television off in one and a half hours enter 01:30, or press ◀ or ▶ to increase/decrease in steps of 10 minutes.
- 3 Press **EXIT** to finish.

Digital on-screen information and Programme Guide

When viewing in **digital** mode, the on-screen information and programme guide give access to programme details for all available channels.

Information

- 1 Select information by pressing **[I+]**, the information screen will appear giving details of the channel and programme currently being viewed.



- 2 To see details of any of the other channels currently available, press **▲** and **▼** to scroll up and down the channel list. As the channel is selected details of the programme currently being broadcast will appear.
- 3 Pressing the **YELLOW** button will activate **Showing also**, giving details of programmes which have started on other channels.
- 4 To record the following programme, with the information guide showing, press **▶**. The **Tune** option in the bottom section of the screen will change to **Record**, press **OK**. The **SET TIMER** screen will appear.



- 5 The details of the programme will have been added to the screen. Press **OK** to save.

Guide

- 1 Select the on-screen guide by pressing **GUIDE**, the guide screen will appear highlighting details of the channel and programme currently being viewed. This may take a few moments to appear.

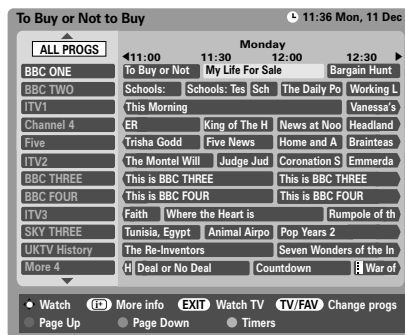

- 2 Press **◀** or **▶** for information of other programmes scheduled for the channel selected.
 - 3 For details of other channels currently available, press **▲** and **▼** to scroll up and down the channel list. As the channel is selected details of the programme currently being broadcast will appear, then press **◀** or **▶**.
 - 4 For information on a highlighted programme press **[I+]**. To set the timer for that programme press the **BLUE** button to bring up the **Programme timers** menu.
- NOTE:** Recording can be set from **both** the information screen and guide. In order for the recording operation to work the media recorder must be AV link compatible.
- 5 Press **▶▶** to move the **Guide** forward by 24 hours, press **◀◀** to go back. Pressing **▶▶** or **◀◀** will move the **Guide** forwards or backwards a page at a time.

Digital settings – parental control

In order to prevent viewing of unsuitable films and programmes, channels and menus can be locked. These can then only be accessed with a security code PIN when in **digital** mode.

Setting the PIN

- 1 Press **MENU** and **▶** to select the **FEATURE MENU**.

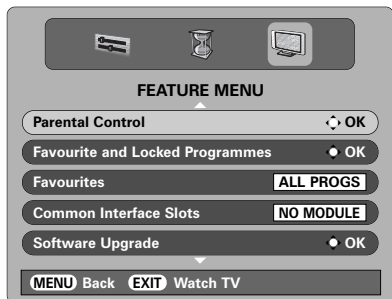

- 2 Use **▼** to select **Parental Control** then press **OK**.
- 3 Press **▼** to highlight **Change Pin** then press **OK**.



- 4 Using the number buttons enter a four digit number, when these have been entered the screen will ask you to confirm them by entering them again.

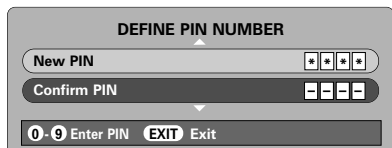

The PIN number is now set. To activate put the television into standby.

Mode

This feature locks various menus to prevent the television being returned or the settings being overridden.

- 1 In the **PARENTAL CONTROL** menu press **▼** to select **Mode**.



- 2 Use **◀** or **▶** to choose between **ON**, **LOCK MENU**, **LOCK INSTALL** and **OFF**.

When menus that have been locked are now selected they will only become available when the PIN is entered.

Digital settings – favourite programmes, locked programmes, encrypted programmes

Selecting favourite programmes

Favourite Programmes creates a list of the digital channels that are watched most. Four lists can be created, these can be a mixture of television, text and radio channels.

- 1 From the **FEATURE MENU** press **▼** to select **Favourite and Locked Programmes**.

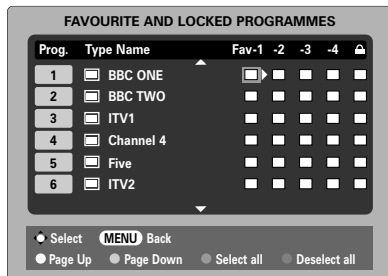

- 2 Use **▲** and **▼** to go through the list of channels pressing **OK** to select the ones required, a tick will appear in the box.
- 3 Press **▶** to select **List 2**. Follow the same procedure to make the selection. When all favourites have been selected press **MENU** to return to the **FEATURE** menu.
- 4 Use **▼** to highlight **Favourites** and **◀** or **▶** to select between **ALL**, **TV**, **RADIO**, **FAV-1** and **FAV-2**. The number of favourites available depends on how many lists have been created.

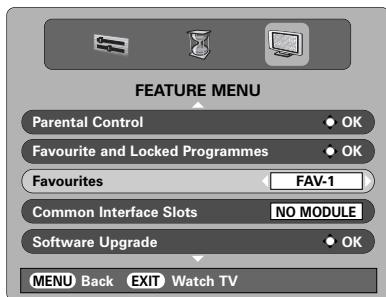

- 5 Press **EXIT**.

Using the **▲ P ▼** buttons will now only access those channels in **Favourite List 1** when **FAV-1** is selected.

Locking programmes

Locked Programmes stops the viewing of digital channels, they can only be accessed by entering the PIN.

- 1 From the **FEATURE MENU** press **▼** to select **Favourite and Locked Programmes**.
- 2 Press **▶** repeatedly to select the **Locked Programme** list.
- 3 Use **▲** and **▼** to go through the list of channels pressing **OK** to select the ones required, a padlock will appear in the box.

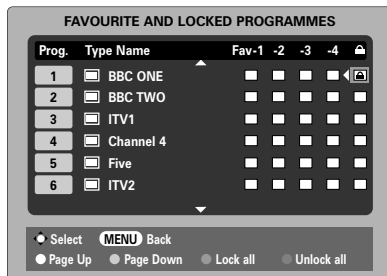

- 4 Press **EXIT** and put the television into standby.
- 5 When the television is switched back on and any of the channels in the **Locked Programme** list are selected the PIN must be entered before they can be accessed.

Encrypted programmes

Selecting **Encrypted Programmes** allows all encrypted programmes to be shown in the programme list even if they are not available to select.

- 1 In the **FEATURE MENU** press **▲** or **▼** to select **Encrypted Programmes**.
- 2 Use **◀** or **▶** to select **ON** or **OFF**.

NOTE: CAMs (Conditional Access Modules) are available from service providers (see 'Common Interface' section)

Digital settings continued – audio languages, audio output, subtitles, reset tv, common interface

Audio languages

This feature allows a programme or film to be viewed with a choice of soundtrack language, provided they are currently being broadcast.

- 1 In the **SETUP MENU** press ▼ to select **Local Options**.
- 2 Press **OK**, then press ▲ or ▼ to highlight **Audio Language**.

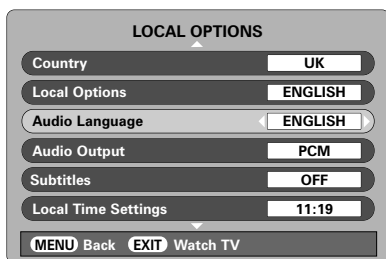

- 3 Use ◀ or ▶ to select an option.

NOTE: If more than one soundtrack is available, use ◂/▸ to select between them.

Audio output

When connecting a surround sound amplifier to the digital audio output (Sony/Philips Digital Interface Format [S/PDIF]), the following options can be selected.

PCM: this mode outputs PCM format to the digital audio output socket.

BITSTREAM: this mode outputs audio format (eg. Dolby Digital) to the digital audio output socket providing it is being broadcast. It will automatically mute the speakers.

- 1 In the **LOCAL OPTIONS** menu press ▼ to select **Audio output**.
- 2 Use ◀ or ▶ to select **PCM** or **Bitstream**.

Subtitles

This feature will show subtitles on the bottom of the screen in the selected language provided they are being broadcast.

- 1 In the **LOCAL OPTIONS** menu press ▼ to select **Subtitles**.
- 2 Use ◀ or ▶ to select an option.

Reset TV

Selecting **Reset TV** will delete all stored **digital** channels and settings. The television will return to factory settings and then auto tune.

- 1 In the **SETUP MENU** press ▼ until **Reset TV** is highlighted.
- 2 Press **OK** to select. A screen will appear warning that all digital settings will be lost, press **OK** to continue.

The Welcome screen will appear, press **OK** to continue, the television will then auto tune.

Common interface

The Common Interface Slot, situated on the back of the television, enables the insertion of a CAM (Conditional Access Module) and card. These are purchased from a service provider and allow additional subscription broadcasts to be viewed. For information see a service provider.

- 1 Insert the CAM and card into the Common Interface Slot, following the instructions provided with the CAM. A box will appear on screen to confirm that the CAM is loaded.
- 2 In the **FEATURE MENU** press ▲ or ▼ to select **Common Interface Slots**.
- 3 Details of the CAM should now be available. Use **OK** to select it. If two CAMs are inserted use ◀ or ▶ to select between the two.

Digital settings continued – software upgrade

Version

This feature can be used to check the version of software currently installed.

- 1 From the **FEATURE MENU** press ▲ or ▼ to select **Software upgrade**. Press **OK**.

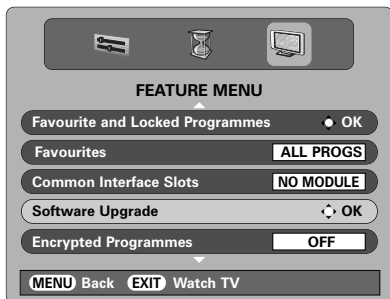

- 2 Press ▲ or ▼ to select **Version**. Use ◀ or ▶ to select. When the software has been updated there will be a choice of two versions available.

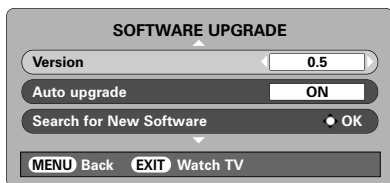

Auto Upgrade

If **Auto upgrade** is selected the software will automatically update as each version becomes available, provided the television is on or in standby. If the television is on, a screen prompt will appear showing the software download taking place.

- 1 In the **SOFTWARE UPGRADE** menu press ▲ or ▼ to select **Auto upgrade**.
- 2 Use ◀ or ▶ to select **ON** or **OFF**.

Searching for new software

If preferred, software upgrades can be searched for manually using **Search for New Software**.

- 1 In the **SOFTWARE UPGRADE** menu press ▲ or ▼ to select **Search for New Software**.

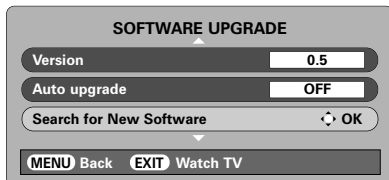

- 2 Press **OK**. The television will automatically start searching for a software upgrade, the progress bar will move along the line.



If an upgrade is found the television will automatically start downloading, if not a screen will appear stating that an upgrade is unavailable.

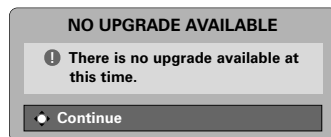

PC settings – picture position, clock phase, sampling clock, reset

Picture position

Connect the PC (as shown in the 'Connecting a PC' section) and ensure that a picture is showing on the television screen. The picture position may now be adjusted to suit personal preference.

- 1 Press **⊘** to select **PC**, then select **PC Setting** from the **SET UP** menu.



- 2 Press **OK**. Press **▲** and **▼** to select an option, then **◀** or **▶** to adjust the settings.

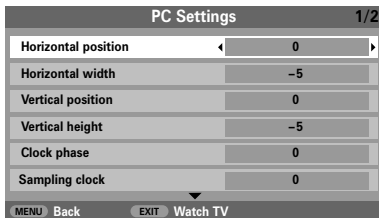

Clock phase

The **Clock phase** matches the PC signal with the LCD display. Adjusting this can clear horizontal stripes and picture blur.

- 1 In the **SET UP** menu press **▼** until **PC Setting** is highlighted.
- 2 Press **OK** to select, then **▼** to highlight **Clock phase**.
- 3 Use **◀** or **▶** to adjust until the picture clears.

Sampling clock

Adjusting the **Sampling clock** alters the number of pulses per scan, this will clear vertical lines on the screen.

- 1 In the **SET UP** menu press **▼** until **PC Setting** is highlighted.
- 2 Press **OK** to select, then **▼** to highlight **Sampling clock**.

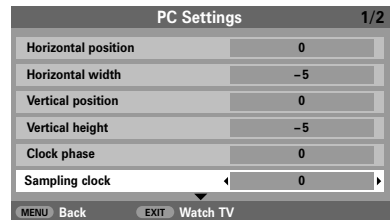

- 3 Use **◀** or **▶** to adjust until the picture clears.

Reset

To return to the original factory settings.

- 1 In the **SET UP** menu press **▼** until **PC Setting** is highlighted.
- 2 Press **OK** to select, then **▼** to highlight **Reset**.
- 3 Press **OK**.

NOTE: When a PC is connected using HDMI none of these functions will be available.

Input selection and AV connections

Defining the INPUT and OUTPUT sockets so that the television recognises connected equipment. See page 7 for a clear view of the back connection recommendations.



Most media recorders and decoders send a signal through the SCART lead to switch the television to the correct *input* socket.

Alternatively press the external source selection button  until the picture from connected equipment is shown.

This button must be used to view equipment connected using the COMPONENT VIDEO INPUT (**EXT3C**).

An **S** in the display e.g. 2S (**EXT 2S**), indicates the input is set for an S-Video signal.

Input selection

- 1 At any time by pressing  a list will appear on screen showing modes and all stored external equipment. Use  and  to highlight and **OK** to select.

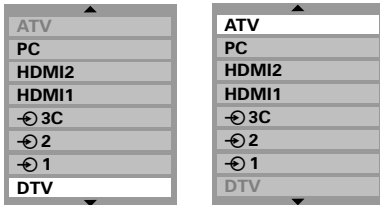

NOTE: When in **digital** mode **ATV** cannot be selected, in **analogue** mode **DTV** cannot be selected. To switch between **DTV** and **ATV** press the **A/D** button.

HDMI™ displays equipment connected to *Input HDMI* on the back of the television. It is designed for best performance with 1080i high definition signals.



PC displays a computer connected to *Input RGB/PC* on the back of the television.

INPUT signal selection

This specifies the type of signal going into SCART 2 (**EXT2**) on the back of the television. Please refer to the manufacturers instructions for the connected equipment.

- 1 In the **SET UP** menu press  until **AV connection** is highlighted, then press **OK**.



- 2 With  or  select either **AV** or **S-VIDEO** as the required *input* for **EXT2**.

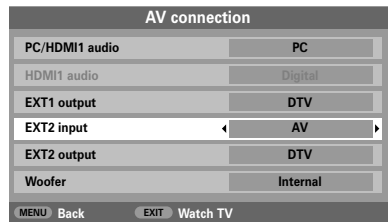

If the colour is missing try the alternative setting.

Input selection and AV connections continued

PC audio

In order to receive sound from a connected PC, plug the audio cable into the back of the television (as shown in 'Connecting a computer' section), then use the **PC/HDMI1 audio** settings.

- 1 In the **SET UP** menu press ▼ until **AV connection** is highlighted, then press **OK**.



- 2 Highlight **PC/HDMI1 audio** then use to ► select the **PC** option.

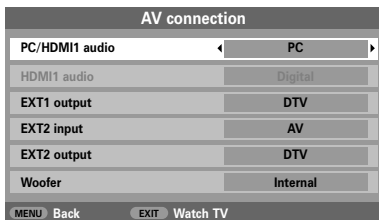

NOTE: Selecting the **PC** option will force HDMI into digital audio.

HDMI, the HDMI logo, and High-Definition Multimedia Interface are trademarks or registered trademarks of HDMI Licensing, LLC.

HDMI1 audio

If the connected HDMI source does not support digital audio, plug the audio cable into **PC/HDMI1 audio** on the back of the television (as shown in the 'Connecting a computer' section), then use the **HDMI1 audio** settings.

- 1 In the **AV connection** menu press ▼ to highlight **PC/HDMI1 audio** and using ► select **HDMI1**.
- 2 Then highlight **HDMI1 audio** and using ◀ or ▶ select **Auto**, **Digital** or **Analogue**.

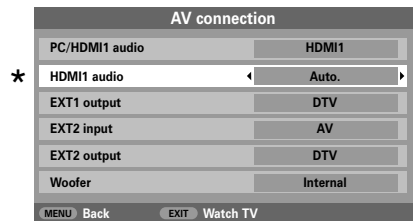

If the sound is missing select an alternative setting.

NOTE: HDMI1 supports digital and analogue sound, HDMI2 is digital sound only.

Certain formats of DVD disk may not output from this TV (32/44.1/48kHz and 16/20/24 bits are acceptable).

Analogue switch-off

This is a **digital** television which is integrated to allow the use of both **digital** and **analogue** services. However, during the lifetime of this set it is very likely that **analogue** services will be switched off to allow for more new **digital** services.

This 'switch-off' will happen in a number of phases, which will be advertised in your area well in advance. It is recommended that at each phase the television is re-tuned to ensure that existing and new **digital** services can be viewed without disruption (see the 'Auto tuning' section).

Analogue text services – setting up, general information, Auto and LIST modes

This television has a multi-page text memory, which takes a few moments to load. It offers two **Modes** of viewing text – **Auto** will display **Fastext**, if available. **LIST** will store your four favourite pages.

Selecting modes

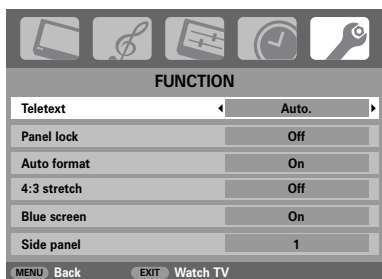

The text character set will be automatically chosen by the language setting in the **SET UP** menu.

- 1 Select **Teletext** from the **FUNCTION** menu.
- 2 With ◀ or ▶ choose **Auto.** or **LIST** then press **EXIT**.



Text information

The / / button:

To view text services press / / . Press again to superimpose the text over a normal broadcast picture and again to return to normal viewing. Programmes cannot be changed until text is cancelled.

The first text page shown will be the *initial* page.

Any text page can be accessed by entering the 3 digit page number using the numbered buttons, pressing the coloured buttons or pressing **P ▲** to advance to the next page and **P ▼** to go back to the previous page.

Sub-pages

If there are sub-pages they will automatically load into memory without changing the page on screen.

To access the sub-pages press  then use **P ▲** and **P ▼** to view them. A bar with numbers will appear on the side of the screen.

The sub-page you are viewing will be highlighted and, as the television loads any additional sub-pages the colour of the numbers will change, indicating that these pages have been loaded.

These sub-pages will remain available to view until another page is chosen or, in normal TV mode, the channel is changed.

Navigating pages using Auto.

If **Fastext** is available four coloured titles will appear at the base of the screen.

To access one of the four given subjects, press the relevant coloured button on the remote control.

For further information on your particular text system(s), see the broadcast text index page or, consult your local Toshiba dealer.

Navigating pages using LIST

The four coloured choices at the bottom of the screen are numbers – 100, 200, 300 and 400, which have been programmed into the television's memory. To view these pages press the relevant coloured buttons.

To change these stored pages press the relevant coloured button and enter the 3 digit number. This number will change in the top left of the screen and in the coloured highlight.

Press **OK** to store. The bars at the bottom of the screen will flash white. **Whenever OK is pressed all four page numbers showing at the bottom will be stored and the previous ones will be lost.**

If **OK** is not pressed the selection will be forgotten when text is cancelled.

Other pages may be viewed by entering the 3 digit page number – but **DO NOT** press **OK** or these pages will be stored.

Analogue text services – control buttons, Digital interactive services

Below is a guide to the functions of the remote control text buttons.



To display the index/initial page:

Press to access the index/initial page. The one displayed is dependant on the broadcaster.



To display a page of text:

Press to display text. Press again to superimpose text over a normal normal broadcast picture. Press again to return to normal television viewing. Programmes cannot be changed until this has been done.



To access sub-pages:

For use with **P** and **P** to view sub-pages when available.



To reveal concealed text:

To discover the solutions on quiz and joke pages press the button.



To hold a wanted page:

At times it is convenient to hold a page of text. Press and will appear in the top left of the screen. The page will be held on screen until the button is pressed again.



To enlarge the text display size:

Press once to enlarge the top half of the page, press again to enlarge the bottom half of the page. Press again to revert to normal size.



To select a page whilst viewing a normal picture:

Enter the page number then press , a normal picture will be displayed. The television will indicate when the page is present by displaying the page number at the top of the screen. Press to view the page.

To display news flashes:

Select the news flash page for the chosen text service (see the index page of text service). Press . The news flashes will be displayed as and when they are broadcast. Press again to cancel the display.

The news flash page must be cancelled before changing programmes.



Remember to cancel text before changing channels – press the button twice.

Digital interactive services

The **digital** interactive services are the up-to-date way of viewing service information, using computer-style formats, incorporating pictures and interactive views.

They offer high quality on-screen images with multi-colour photographic still images, advanced text and graphics and are user-friendly. These services are free to anyone with a digital television, however, they are not available for all digital stations and are dependant on the broadcaster.

- 1 Ensure that **digital** mode has been selected. Press **TEXT**, it may take a few moments to load.
- 2 To navigate the pages and use the pull-down menus, use the coloured buttons and **▲**, **▼**, **◀** and **▶** as directed.
- 3 Press **TEXT** again at any time to cancel.

Questions and Answers

Below are the answers to some of the most common queries.

For more information go to www.toshiba.co.uk

Q Why is there no sound or picture?

A Check the television is not in standby mode. Check the mains plug and all mains connections.

Q There is a picture, but why is there little or no colour?

A When using an **external** source, for instance, a poor quality video tape, if there is little or no colour, improvements may sometimes be achieved. The colour is factory set to **Auto**, to automatically display the best colour system.

To check that you have the best colour:

- 1 With the external source playing, select **Manual setting** from the **SET UP** menu.

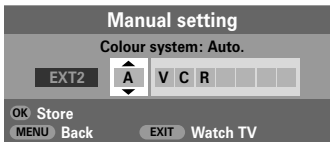

- 2 With **▲** or **▼** choose between **Auto.**, **PAL**, **SECAM**, **NTSC 4. 43** or **3. 58**.

Q Why doesn't the video/DVD being played show on screen?

A Make sure the VCR or DVD player is connected to the television as shown on page 7, then select the correct input by pressing **↻**.

Q Why is there a good video picture but no sound?

A Check all lead connections.

Q Why is there a picture but no sound?

A Check the volume has not been turned down or that sound mute has not been selected.

Q Why is the VCR/DVD picture in black and white?

A Check the correct **input** has been chosen, **S-VIDEO** or **AV**. See **AV connections** page 33.

Q Why is there picture and sound interference on all digital and analogue channels?

A The signal strength may be too strong. Set the **Antenna Amplifier** option in the **SET UP** menu to **Off**.

Q What else can cause a poor analogue picture?

A Interference or a weak signal. Try a different television station. **Manual fine tuning** may help.

- 1 Select the **Manual tuning** menu. Highlight the station and press **OK**, then press **▶** to select **Manual fine tuning**.

- 2 Using **▲** or **▼** adjust to get the best picture and sound. Press **OK** and then **EXIT**.



Q Why don't the controls on the front of the television work?

A Check that **Panel lock** is not **ON**.

Q Why doesn't the remote control work?

A Check the side switch on the remote control is in TV mode. Check the batteries aren't dead or inserted incorrectly.

Q Why is there a message permanently on the screen?

A Remove it by pressing **[+]**.

Questions and Answers continued

Q Why is the DTV main menu unavailable?

A Another mode is selected. Press **A/D** to select **DTV**.

Q Why are some of the menus locked?

A **Lock Menu** has been enabled (see 'Parental Controls' page).

Q Why is the digital channel locked?

A The channel has been selected in **Locked Programmes** (see 'Digital Settings' section).

Q Why can only certain digital channels be viewed?

A A **Favourite** list has been selected (see 'Favourite Programmes' section), set the feature to **ALL PROGS** or change channels by using the number buttons.

Q Why are some of the digital subscription channels unavailable?

A Your subscription needs upgrading. Contact your service provider.

Q Why is the soundtrack in English when a different audio language has been selected?

A The programme is currently being broadcast with an English soundtrack only.

Q Why is there incorrect or no sound when in DTV mode?

A Press **⏻/⏮** to check if the hard of hearing option has been selected.

Q Why is there no sound from my connected sound equipment?

A Check the **Speaker** option in the **Sound** menu is set to **Off**.

Q What can be done if the PIN number has been forgotten?

A Use the Master PIN code of 1276, then change to a number of your choice. Ensure that no-one else can use the Master PIN by removing the Owner's Manual.

Q Why are there vertical stripes on the screen when in PC mode?

A The **Sampling clock** may need adjustment. Select **PC Setting** from the **SET UP** menu, highlight **Sampling clock** and adjust until the lines clear.

Q Why are there horizontal stripes and/or blurred images on the screen when in PC mode?

A The **Clock phase** may need adjustment. Select **PC Setting** from the **SET UP** menu, highlight **Clock phase** and adjust until the picture clears.

Q Why when digital subtitles have been selected are they not showing on screen?

A Subtitles are not currently being transmitted by the broadcaster.

Q Why is there no digital text service?

A The **digital** programme being viewed is not broadcasting digital text. Try another **digital** programme.

Q Why are there problems with analogue text?



A Good performance of text depends on a good strong broadcast signal. This normally requires a roof or loft aerial. If the text is unreadable or garbled, check the aerial. Go to the *main index* page of the text service and look for the *User Guide*. This will explain the basic operation of text in some detail. If further information is needed on how to use text see the *text* section.

Questions and Answers continued

Q Why are there no analogue text sub-pages?

A There are none broadcast or they have not yet loaded. Press the  button to access. (See text section).

Q Why are the four coloured text numbers visible but no text?

A Text has been selected whilst viewing an external source i.e. DVD or VCR. No text will appear on screen or a box may appear stating no information is available. Select a broadcasting channel and press // to access.

Q Why does the GREEN Active Standby LED sometimes take longer to go out?

A When put into standby the television's active standby will automatically search all available channels for downloads, provided **Auto upgrade** is **On**. The time it takes to do this may vary.

Q Why are the colours wrong when an NTSC source is played?

A Connect the source via a SCART lead and play. Select **Manual setting** from the **SET UP** menu.

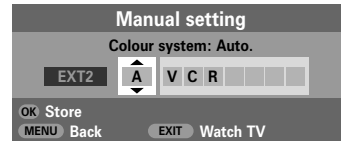

- 1 Set the Colour to **Auto**. and exit.
- 2 Go to the **Picture settings** menu and adjust the tint.

Q Why is there no sound from a PC connected via HDMI?

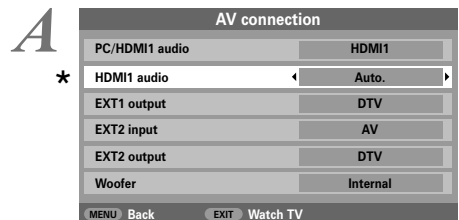

Press and hold the **OK** button for 5 seconds – the **Lip Sync Latency** menu will appear. Select between **On** and **Off**.



Cleaning the screen and cabinet...

Turn off the power, clean the screen and cabinet with a soft, dry cloth. We recommend that you **do not** use any proprietary polishes or solvents on the screen or cabinet as this may cause damage.

Disposal...

The following information is only for EU-member states:

The use of the symbol indicates that this product may not be treated as household waste. By ensuring this product is disposed of correctly, you will help prevent potential negative consequences for the environment and human health, which could otherwise be caused by inappropriate waste handling of this product. For more detailed information about recycling of this product, please contact your local city office, your household waste disposal service or the shop where you purchased the product.



Notes

For your own records

Information

Before connecting any external equipment, turn off all main power switches. If there is no switch remove the mains plug from the wall socket.

Connecting a computer

Signal information for Mini D-sub 15 pin connector

Pin No.	Signal name	Pin No.	Signal name
1	R	9	NC
2	G	10	Ground
3	B	11	NC
4	NC (not connected)	12	NC
5	NC	13	H-sync
6	Ground	14	V-sync
7	Ground	15	NC
8	Ground		

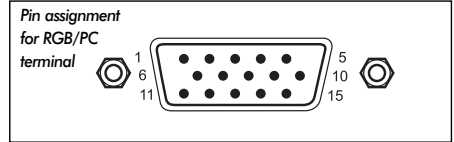

Connecting a DVD/STB via HDMI

Acceptable video signals through HDMI terminals

H. Active	V. Active	I/P	H. Frequency (kHz)	V. Frequency (Hz)	Pixel Frequency (MHz)
720	576	Prog	31.250	50.000	27.000
1280	720	Prog	37.500	50.000	74.250
1920	1080	Int	28.125	50.000	74.250
640	480	Prog	31.469	59.940	25.175
720	480	Prog	31.469	59.940	27.000
1280	720	Prog	44.955	59.940	74.176
1920	1080	Int	33.716	59.940	74.176
640	480	Prog	31.500	60.000	25.200
720	480	Prog	31.500	60.000	27.027
1280	720	Prog	45.000	60.000	74.250
1920	1080	Int	33.750	60.000	74.250
1920	1080	Prog	56.250	50.000	148.500
1920	1080	Prog	67.433	59.940	148.352
1920	1080	Prog	67.500	60.000	148.500

Int = Interlace; Prog = Progressive

Specifications and accessories

DVB-T Broadcast systems/channels

UK UHF 21-68

France VHF 05-10 (VHF 01-05)
UHF 21-69

Germany VHF 05-12
UHF 21-69

Switzerland VHF 05-12
UHF 21-69

Italy VHF 05-12 (D,E,F,G,H,H1,H2)
UHF 21-69

Spain UHF 21-69

Video Input PAL, SECAM, NTSC 3.58/4.43

External connections

EXT1 Input/Output 21-pin SCART RGB, A/V
Selectable output

EXT2 Input/Output 21-pin SCART A/V, S-video
Selectable output

EXT3 Input Phono jacks Y, P_B/C_B, P_R/C_R
Phono jacks A/V

EXT3 Input (Side) Phono jack Video
Phono jacks Audio L + R

HDMI 1/2 Input HDMI™ (1080p, LIP SYNC)

PC Input Mini D-sub 15-pin Analog RGB signal

PC/HDMI Audio Phono jacks Audio L + R

Digital Audio Output (S/PDIF) Optical

Output to Active Super Woofer Phono jack

Fixed Audio Output Phono jacks Audio L + R

Broadcast systems/channels

PAL-I UHF UK21-UK69

PAL-B/G UHF E21-E69
VHF E2-E12, S1-S41

SECAM-L UHF F21-F69
VHF F1-F10, B-Q

SECAM-D/K UHF R21-R69
VHF R1-R12

Stereo

Nicam
2 carrier system

Visible Screen Size (approx.)

Model 32	80cm
37	94cm
42	107cm

Display

16:9

Sound output (at 10% distortion)

Main 10W + 10W

Power consumption as specified in EN60107-1 : 1997

Model 32	154W
37	190W
42	241W

Standby (approx.)

Model 32	<1W
37	<1W
42	<1W

Dimensions (approx.)

Model 32	60cm (H)	80cm (W)	29cm (D)
37	67cm (H)	92cm (W)	29cm (D)
42	73cm (H)	103cm (W)	34cm (D)

(Height dimension includes foot stand)

Weight (approx.)

Model 32	18kg
37	22kg
42	27.5kg

Headphone socket

3.5mm stereo

Accessories

Remote control
2 batteries
(AAA, IEC R03 1.5V)

DVB is a registered trademark of the DVB Project



Printed on recycled paper. 100% Chlorine free.

Remember...

For television operation queries, please ring the helpline...



© Toshiba Information Systems (U.K.) Limited

All rights reserved.

Reproduction in whole or part without written permission is strictly prohibited.

Toshiba Information Systems (U.K.) Limited

Consumer Products Division,
European Service Centre,
Admiralty Way, Camberley,
Surrey, GU15 3DT, UK

Specification is subject to change without notice.

Originated by Zushi Illustration & Visualisation, Bristol, UK.

Free Manuals Download Website

<http://myh66.com>

<http://usermanuals.us>

<http://www.somanuals.com>

<http://www.4manuals.cc>

<http://www.manual-lib.com>

<http://www.404manual.com>

<http://www.luxmanual.com>

<http://aubethermostatmanual.com>

Golf course search by state

<http://golfingnear.com>

Email search by domain

<http://emailbydomain.com>

Auto manuals search

<http://auto.somanuals.com>

TV manuals search

<http://tv.somanuals.com>