

# TOSHIBA

# OWNER'S MANUAL

## Color Television

COLORSTREAM®

# 32AF43

# 36AF43



### Owner's Record

The model number and serial number are on the back of your TV. Record these numbers in the spaces below. Refer to these numbers whenever you communicate with your Toshiba dealer about this TV.

Model number:

Serial number:

Introduction

Connecting  
your TV

Using the  
Remote Control

Setting up  
your TV

Using the TV's  
Features

Appendix

Index

## Dear Customer,

Thank you for purchasing this Toshiba TV. This manual will help you use the many exciting features of your new TV. **Before operating the TV, please read this manual completely**, and keep it nearby for future reference.

## Safety Precautions

### WARNING

**TO REDUCE THE RISK OF FIRE OR ELECTRIC SHOCK, DO NOT EXPOSE THIS APPLIANCE TO RAIN OR MOISTURE.**

	<b>WARNING</b> RISK OF ELECTRIC SHOCK DO NOT OPEN	
<b>WARNING: TO REDUCE THE RISK OF ELECTRIC SHOCK, DO NOT REMOVE COVER (OR BACK). NO USER-SERVICEABLE PARTS INSIDE. REFER SERVICING TO QUALIFIED SERVICE PERSONNEL.</b>		

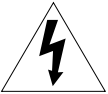
 The lightning symbol in the triangle tells you that the voltage inside this product may be strong enough to cause an electric shock. **DO NOT TRY TO SERVICE THIS PRODUCT YOURSELF.**

 The exclamation mark in the triangle tells you that important operating and maintenance instructions follow this symbol.

## NOTE TO CATV INSTALLERS IN THE USA

This is a reminder to call the CATV system installer's attention to Article 820-40 of the NEC, which provides guidelines for proper grounding and, in particular, specifies that the cable ground shall be connected to the grounding system of the building, as close to the point of cable entry as practical. For additional antenna grounding information, see items 25 and 26 on page 4.

## NOTICE OF POSSIBLE TV STAND INSTABILITY

 **DANGER: RISK OF SERIOUS PERSONAL INJURY OR DEATH!** Use this TV with the TOSHIBA TV stand recommended in the "Specifications" section only. Use with other stands may result in instability, causing possible injury or death.

## NOTICE OF POSSIBLE ADVERSE EFFECTS ON TV PICTURE TUBE

If a fixed (non-moving) pattern remains on the TV screen for long periods of time, the image can become permanently engrained in the picture tube. **This type of damage is NOT COVERED BY YOUR WARRANTY.** See item 33 on page 4.

## Child Safety

**It Makes A Difference Where Your TV Stands**



**Congratulations on your purchase! As you enjoy your new TV, keep these safety tips in mind:**

## The Issue

- If you are like most consumers, you have a TV in your home. Many homes, in fact, have more than one TV.
- The home theater entertainment experience is a growing trend, and larger TVs are popular purchases; however, they are not always supported on the proper TV stands.
- Sometimes TVs are improperly secured or inappropriately situated on dressers, bookcases, shelves, desks, audio speakers, chests, or carts. As a result, TVs may fall over, causing unnecessary injury.

## Toshiba Cares!

- The consumer electronics industry is committed to making home entertainment enjoyable and safe.
- The Consumer Electronics Association formed the Home Entertainment Support Safety Committee, comprised of TV and consumer electronics furniture manufacturers, to advocate children's safety and educate consumers and their families about television safety.

## Tune Into Safety

- One size does NOT fit all! Use appropriate furniture large enough to support the weight of your TV (and other electronic components).
- Use appropriate angle braces, straps, and anchors to secure your furniture to the wall (but never screw anything directly into the TV).
- Carefully read and understand the other enclosed instructions for proper use of this product.
- Do not allow children to climb on or play with furniture and TVs.
- Avoid placing any item on top of your TV (such as a VCR, remote control, or toy) that a curious child may reach for.
- Remember that children can become excited while watching a program and can potentially push or pull a TV over.
- Share our safety message about this hidden hazard of the home with your family and friends. Thank you!



2500 Wilson Blvd.  
Arlington, VA 22201 U.S.A.  
Tel. 703-907-7600 Fax 703-907-7690  
www.CE.org  
*CEA is the Sponsor, Producer and Manager of the International CES®*

# Important Safety Instructions

- 1) **Read these instructions.**
- 2) **Keep these instructions.**
- 3) **Heed all warnings.**
- 4) **Follow all instructions.**



- 5) **Do not use this apparatus near water.**



- 6) **Clean only with a dry cloth.**

- 7) **Do not block any ventilation openings.** Install in accordance with the manufacturer's instructions.

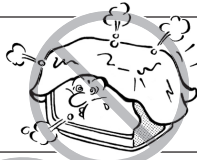

- 8) **Do not install near any heat sources** such as radiators, heat registers, stoves, or other apparatus (including amplifiers) that produce heat.



- 9) **Do not defeat the safety purpose of the polarized or grounding type plug.** A polarized plug has two blades with one wider than the other. A grounding type plug has two blades and a third grounding prong. The wide blade or the third prong are provided for your safety. If the provided plug does not fit into your outlet, consult an electrician for replacement of the obsolete outlet.

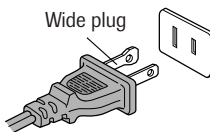

- 10) **Protect the power cord** from being walked on or pinched, particularly at plugs, convenience receptacles, and the point where it exits the apparatus.

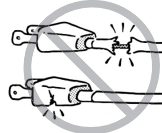

- 11) **Only use attachments/accessories specified by the manufacturer.**

- 12) **Use only with the cart, stand, tripod, bracket, or table specified by the manufacturer, or sold with the apparatus.** When a cart is used, use caution when moving the cart/apparatus combination to avoid injury from tip-over.



- 13) **Unplug this apparatus during lightning storms or when unused for long periods of time.**



- 14) **Refer all servicing to qualified service personnel.**

Servicing is required when the apparatus has been damaged in any way, such as power supply cord or plug is damaged, liquid has been spilled or objects have fallen into the apparatus, the apparatus has been exposed to rain or moisture, does not operate normally, or has been dropped.



- 15) **CAUTION:** To reduce the risk of electric shock, do not use the polarized plug with an extension cord, receptacle, or other outlet unless the blades can be inserted completely to prevent blade exposure.

# Installation, Care, and Service

## Installation

Follow these recommendations and precautions and heed all warnings when installing your TV:

- 16) Never modify this equipment. Changes or modifications may void: a) the warranty, and b) the user's authority to operate this equipment under the rules of the Federal Communications Commission.

- 17) **DANGER: RISK OF SERIOUS PERSONAL INJURY, DEATH, OR EQUIPMENT DAMAGE!** Never place the TV on an unstable cart, stand, or table. The TV may fall, causing serious personal injury, death, or serious damage to the TV.



- 18) Never place or store the TV in direct sunlight; hot, humid areas; areas subject to excessive dust or vibration; or locations with temperatures at or below 41°F (5°C).

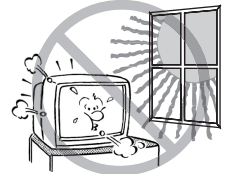

- 19) Always place the TV on the floor or a sturdy, level, stable surface that can support the weight of the unit.



- 20) Never place items such as vases, aquariums, or candles on top of the TV.



- 21) Never block or cover the slots or openings in the TV cabinet back, bottom, and sides. Never place the TV:
  - on a bed, sofa, rug, or similar surface;
  - too close to drapes, curtains, or walls; or
  - in a confined space such as a bookcase, built-in cabinet, or any other place with poor ventilation.



The slots and openings are provided to protect the TV from overheating and to help maintain reliable operation of the TV.

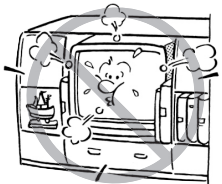

- 22) Never allow anything to rest on or roll over the power cord, and never place the TV where the power cord is subject to wear or abuse.

- 23) Never overload wall outlets and extension cords.



- 24) Always operate this equipment from a 120 VAC, 60 Hz power source only.



- 25) Always make sure the antenna system is properly grounded to provide adequate protection against voltage surges and built-up static charges (see Section 810 of the National Electric Code).

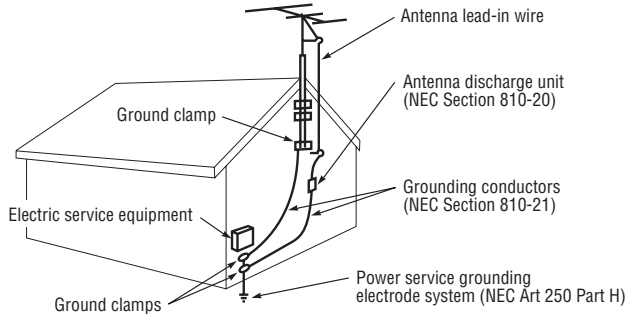

- 26) **! DANGER: RISK OF SERIOUS PERSONAL INJURY OR DEATH!**
- Use extreme care to make sure you are never in a position where your body (or any item you are in contact with, such as a ladder or screwdriver) can accidentally touch overhead power lines. Never locate the antenna near overhead power lines or other electrical circuits.
  - Never attempt to install any of the following during lightning activity:
    - a) an antenna system; or b) cables, wires, or any home theater component connected to an antenna or phone system.

## Care

For better performance and safer operation of your TOSHIBA TV, follow these recommendations and precautions:

- 27) Always sit approximately 10–25 feet away from the TV and as directly in front of it as possible. The picture can appear dull if you sit too far to the left or right of the TV, or if sunlight or room lights reflect on the screen. Turn the TV off to check for reflections on the screen, and then remove the source of reflections while viewing the TV.

- 28) Always unplug the TV before cleaning. Never use liquid or aerosol cleaners.

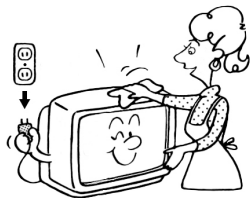

- 29) **! WARNING: RISK OF ELECTRIC SHOCK!** Never spill liquids or push objects of any kind into the TV cabinet slots.

- 30) [This item applies to projection TVs only.] If the air temperature rises suddenly (for example, when the TV is first delivered), condensation may form on the lenses. This can make the picture appear distorted or the color appear faded. If this happens, turn off the TV for 6 to 7 hours to allow the condensation to evaporate.

- 31) For added protection of your TV from lightning and power surges, always unplug the power cord and disconnect the antenna from the TV if you leave the TV unattended or unused for long periods of time.

- 32) During normal use, the TV may make occasional snapping or popping sounds. This is normal, especially when the unit is being turned on or off. If these sounds become frequent or continuous, unplug the power cord and contact a Toshiba Authorized Service Center.

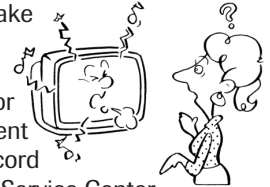

- 33) **Possible Adverse Effects on TV Picture Tube:** If a fixed (non-moving) pattern remains on the TV screen for long periods of time, the image can become permanently engrained in the picture tube and cause subtle but permanent ghost images. **This type of damage is NOT COVERED BY YOUR WARRANTY.** Never leave your TV on for long periods of time while it is displaying the following formats or images:

- **Fixed Images**, such as PIP/POP windows, stock tickers, video game patterns, TV station logos, and websites.
- **Special Formats** that do not use the entire screen. For example, viewing letterbox style (16:9) media on a normal (4:3) display (gray bars at top and bottom of screen); or viewing normal style (4:3) media on a widescreen (16:9) display (gray bars on left and right sides of screen).

## Service

- 34) **! WARNING: RISK OF ELECTRIC SHOCK!** Never attempt to service the TV yourself. Opening and removing the covers may expose you to dangerous voltage or other hazards. Refer all servicing to a Toshiba Authorized Service Center.

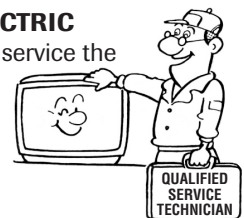

- 35) If you have the TV serviced:

- Ask the service technician to use only replacement parts specified by the manufacturer.
- Upon completion of service, ask the service technician to perform routine safety checks to determine that the TV is in safe operating condition.

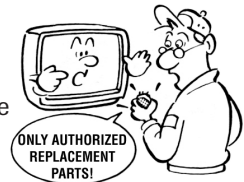

- 36) When the TV reaches the end of its useful life, ask a qualified service technician to properly dispose of the TV. Improper disposal may result in a picture tube implosion and possible personal injury.

# Contents

<b>Important Safety Information .....</b>	<b>2-4</b>	
<b>Introduction .....</b>	<b>6</b>	
Welcome to Toshiba .....	6	
Exploring your new TV .....	6	
<b>Connecting your TV .....</b>	<b>7</b>	
Note regarding picture quality .....	7	
Connecting a VCR .....	7	
Connecting a cable converter box .....	8	
Connecting a cable converter box and a VCR .....	8	
Connecting a DVD player or satellite receiver and a VCR .....	9	
Connecting a DVD player with component video and a VCR .....	10	
Connecting two VCRs .....	11	
Connecting a camcorder .....	12	
Connecting an audio system .....	12	
<b>Using the remote control .....</b>	<b>13</b>	
Preparing the remote control for use .....	13	
Installing the remote control batteries .....	13	
Location of controls on TV and remote control .....	14	
Programming the remote control to operate a cable converter box, satellite receiver, VCR, DVD player, or HTIB (home theater in a box) .....	15	
Remote control codes .....	15-16	
Using the remote control to operate a cable converter box, satellite receiver, VCR, DVD player, or HTIB (home theater in a box) .....	17	
<b>Setting up your TV .....</b>	<b>18</b>	
Learning about the menu system .....	18	
Changing the on-screen display language .....	19	
Programming channels into the channel memory .....	19	
Programming channels automatically .....	19	
Adding and erasing channels manually .....	20	
Changing channels .....	20	
Selecting the signal source .....	21	
Adjusting the IMAGE TILT feature .....	21	
Adjusting the IMAGE SHAPE feature .....	22	
<b>Using the TV's features .....</b>	<b>23</b>	
Adjusting the channel settings .....	23	
Switching between two channels .....	23	
Programming your favorite channels .....	23	
Labeling channels .....	24	
Adjusting the picture .....	25	
Adjusting the picture quality .....	25	
Adjusting the color temperature .....	25	
Selecting the picture preference mode .....	26	
Using the SVM (scan velocity modulation) feature .....	26	
Resetting your picture adjustments .....	27	
Using the closed caption feature .....	28	
Using the V-CHIP (parental control) feature .....	29	
Entering the PIN code .....	29	
If you forget your PIN code .....	29	
Using the SET RATING feature .....	30	
MPAA rating blocking (Independent rating system for movies) .....	30	
TV and YOUTH TV rating blocking (Independent rating system for broadcasters) ...	31	
Using the SET BLOCKING OPTIONS feature ....	32	
BLOCK MPAA UNRATED .....	32	
BLOCK TV NONE RATING .....	32	
Unblocking programs temporarily .....	32	
Using the BLOCK CHANNEL feature .....	33	
Using the VIDEO LOCK feature .....	34	
Using the GAME TIMER feature .....	35	
Using the NEW PIN CODE feature .....	35	
Adjusting the sound .....	36	
Muting the sound .....	36	
Using the MTS feature to select stereo/SAP broadcasts .....	36	
Using the SURROUND sound feature .....	37	
Adjusting the sound quality .....	37	
Resetting your audio adjustments .....	38	
Using the SBS (sub bass system) feature .....	38	
Turning off the built-in speakers .....	39	
Selecting fixed/variable AUDIO OUT .....	39	
Displaying on-screen information .....	40	
Setting the sleep timer .....	40	
Viewing the DEMO mode .....	40	
Understanding the auto power off feature .....	40	
Understanding the last mode memory feature .....	40	
<b>Appendix .....</b>	<b>41</b>	
Specifications .....	41	
Troubleshooting .....	42-43	
Limited United States Warranty .....	44	
Limited Canada Warranty .....	45	
<b>Index .....</b>	<b>47</b>	

## Introduction

### Welcome to Toshiba

Congratulations! You have purchased one of the finest TVs on the market. The goal of this manual is to guide you through setting up and operating your Toshiba TV as quickly as possible.

- This manual applies to models 32AF43 and 36AF43. The model and serial numbers are on the back of the TV. Write these numbers in the space on the front cover of this manual for future reference.
- You may need to purchase additional audio or video cables to connect other equipment to your TV. See “Connecting Your TV” on pages 7–12 for more information.
- Instructions in this manual are based on using the remote control. You also can use the controls on the TV if they have the same name as those referred to in the instructions.

**Please read all safety and operating instructions carefully, and keep this manual for future reference.**

### Exploring your new TV

You can operate your TV using the buttons on the remote control or TV front panel (behind the door). The TV's front and back panels provide all the terminal connections you will need to connect other devices to your TV.

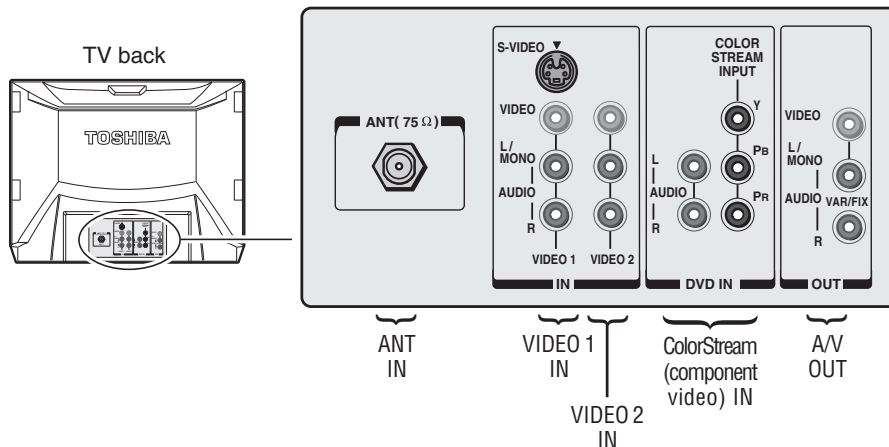
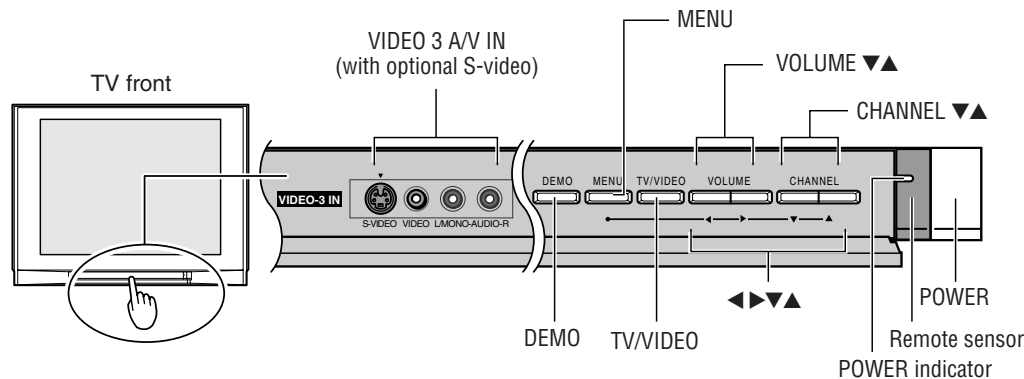
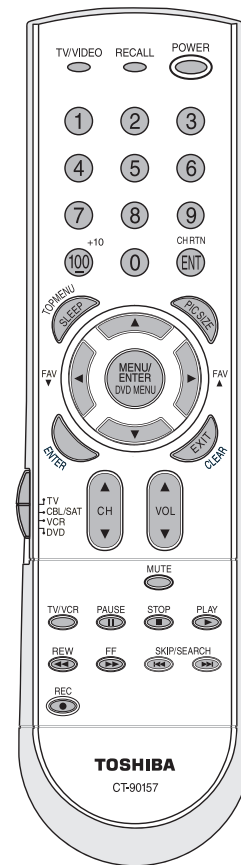

## Connecting your TV

**Note:** Cables are not supplied with your TV.

- **Coaxial cable** is the cable that comes in from your antenna, cable TV service, or cable converter box. Coaxial cable uses "F" connectors.
- **Standard stereo A/V cables** usually come in sets of three, and are typically color-coded according to use: yellow for video, red for stereo right audio, and white for stereo left (or mono) audio. Your TV's standard A/V inputs are color-coded in the same manner as the cables.
- **S-Video cable** is for use with video equipment that has S-Video connectors.
- **Component video cables** come in sets of three (typically color-coded red, green, and blue), and are for use with video equipment that has component video connectors. Your TV's ColorStream® (component video) inputs are color-coded in the same manner as the cables.

### NOTE REGARDING PICTURE QUALITY

When connecting video equipment to your Toshiba TV:

- **For GOOD picture quality:** Use a standard yellow video cable.
- **For BETTER picture quality:** If your equipment has S-video connectors, use an S-video cable **instead of** a standard yellow video cable. (You still must connect the standard red and white audio cables for full system connection, but *do not connect a standard yellow video cable at the same time* or the picture performance will be unacceptable.)
- **For BEST picture quality:** If your equipment has component video connectors, use component video cables **instead of** a standard yellow video cable or S-video cable. (You still must connect the standard red and white audio cables for full system connection.)

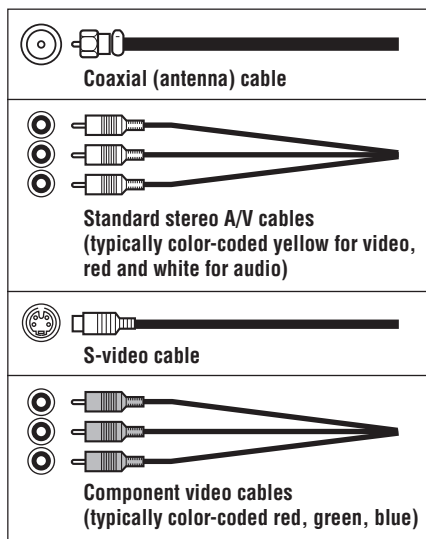

**CAUTION:** Do not plug in any power cords until you have finished connecting all equipment.

## Connecting a VCR

This connection allows you to watch local channels and video programs, play or record on the VCR while watching TV, and record one channel while watching another channel.

**You will need:**

- two coaxial cables
- one set of standard A/V cables

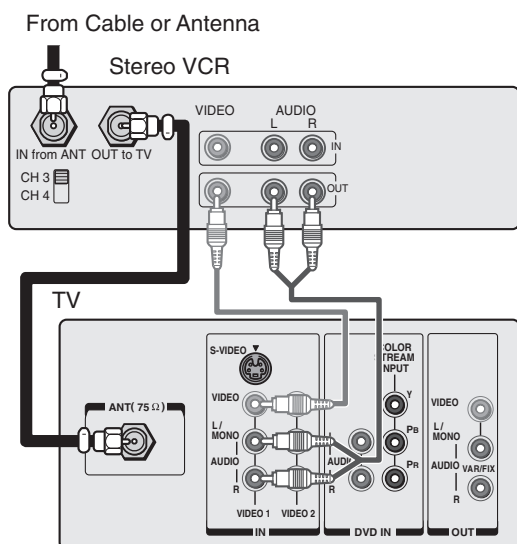

**Note:**

- If you have a mono VCR, connect L/Mono to the VCR's AUDIO OUT terminal using only one audio cable.
- If you have a VCR with S-video, use an S-video cable (plus the standard audio cables) instead of a standard video cable for better picture quality. Do not connect a standard video cable and an S-video cable to VIDEO-1 on the TV back (or VIDEO-3 on the TV front) at the same time, or the picture performance will be unacceptable.

**The unauthorized recording, use, distribution, or revision of television programs, videotapes, DVDs, and other materials is prohibited under the Copyright Laws of the United States and other countries, and may subject you to civil and criminal liability.**

## Connecting a cable converter box

This connection allows you to watch basic and premium channels. Tune the TV to channel 3 or 4 (whichever channel is vacant in your area), and then use the converter box to change channels.

### You will need:

- two coaxial cables

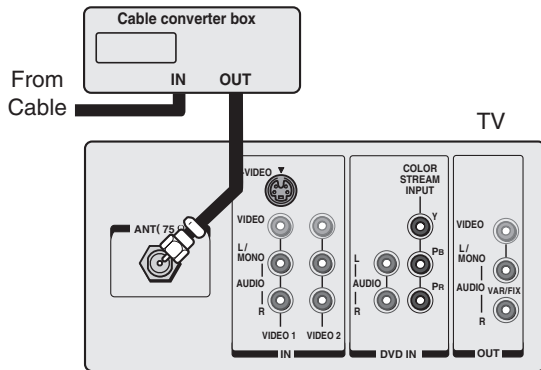

### Note:

When you use a converter box with your TV, the remote control may not operate certain features, such as channel ▲▼, channel block, favorite channels, or channel labels.

## Connecting a cable converter box and a VCR

This connection allows you to watch and record basic and premium cable channels, as well as watch videotapes.

Set the TV signal source to VIDEO 1 (see “Selecting the signal source” on page 21); tune the VCR to channel 3 or 4 (the same channel as the converter box output switch); and use the cable converter box to change channels.

### You will need:

- three coaxial cables
- one set of standard A/V cables

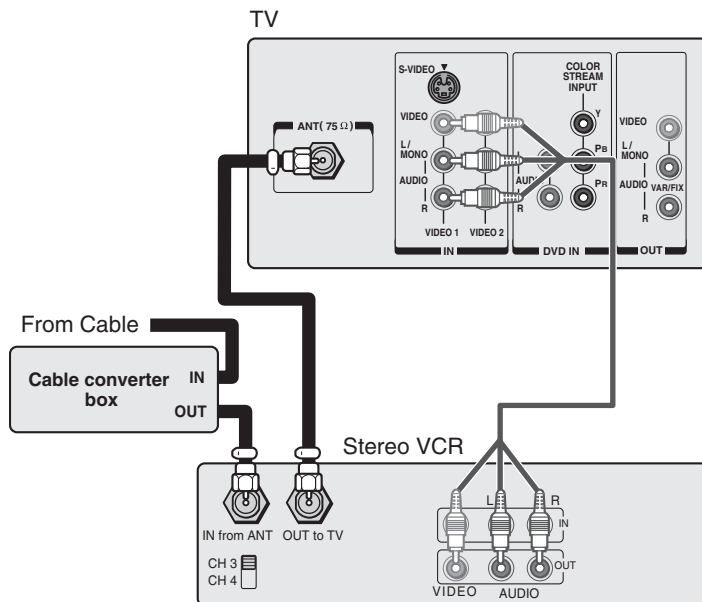

### Note:

- When you use a converter box with your TV, the remote control may not operate certain features, such as channel ▲▼, channel block, favorite channels, or channel labels.
- If you have a mono VCR, connect L/Mono to the VCR's AUDIO OUT terminal using only one audio cable.
- If you have a VCR with S-video, use an S-video cable (plus the standard audio cables) instead of a standard video cable for better picture quality. Do not connect a standard video cable and an S-video cable to VIDEO-1 on the TV back (or VIDEO-3 on the TV front) at the same time, or the picture performance will be unacceptable.

The unauthorized recording, use, distribution, or revision of television programs, videotapes, DVDs, and other materials is prohibited under the Copyright Laws of the United States and other countries, and may subject you to civil and criminal liability.



## Connecting a DVD player or satellite receiver and a VCR

This connection allows you to watch DVD/satellite, VCR, or TV programs, and record from the satellite receiver or TV. You can record one TV program while watching another TV program.

### You will need:

- two (or three, if satellite receiver is used) coaxial cables
- one set of standard A/V cables
- one S-video cable
- one pair of standard audio cables

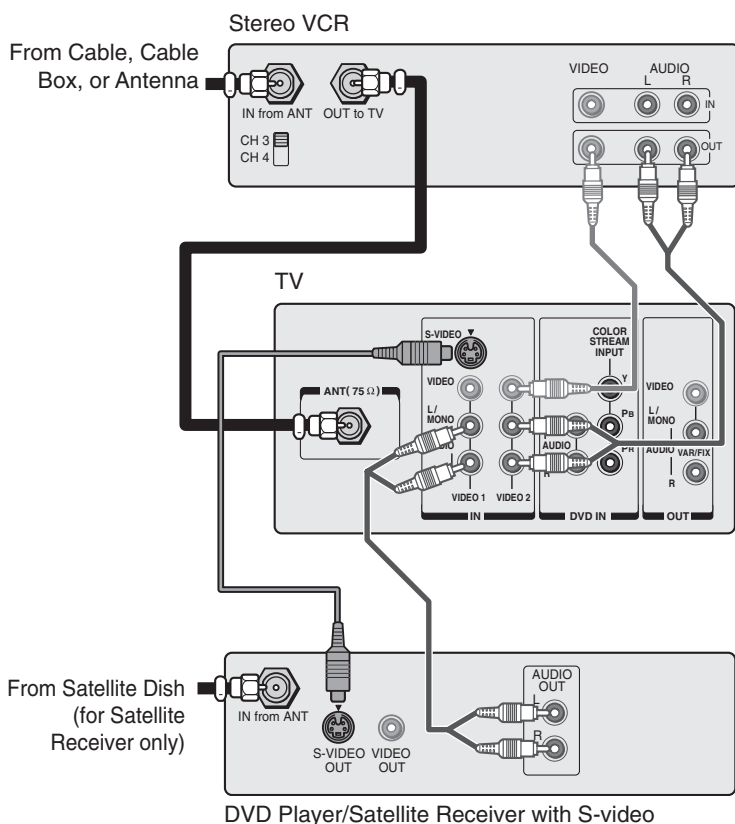

### Note:

- For the highest possible picture quality from a DVD player/satellite receiver that does not have component video connections, use an S-video cable (plus the standard audio cables) between the TV and DVD player/satellite receiver. **If your DVD player (or satellite receiver) has component video, see "Connecting a DVD player with component video and a VCR" on page 10.**
- Do not connect both an S-video cable and a standard video cable to VIDEO-1 on the TV back (or VIDEO-3 on the TV front) at the same time, or the picture performance will be unacceptable.
- Do not connect the DVD player/satellite receiver and VCR to the same A/V inputs on the TV. (See the illustration at left, which shows the DVD player/satellite receiver connected to VIDEO-1 and the VCR connected to VIDEO-2.)

The unauthorized recording, use, distribution, or revision of television programs, videotapes, DVDs, and other materials is prohibited under the Copyright Laws of the United States and other countries, and may subject you to civil and criminal liability.

## Connecting a DVD player with component video and a VCR

This connection allows you to watch DVD, VCR, or TV programs. You can record one TV program while watching another TV program. You also can record a TV program while watching a DVD.

Your TV has ColorStream® (component video) inputs. Connecting your TV to a DVD player with component video (such as a Toshiba DVD player with ColorStream®) can greatly enhance picture quality and realism.

### You will need:

- two coaxial cables
- one set of standard A/V cables
- one set of component video cables
- one pair of standard audio cables

From Cable, Cable Box, or Antenna

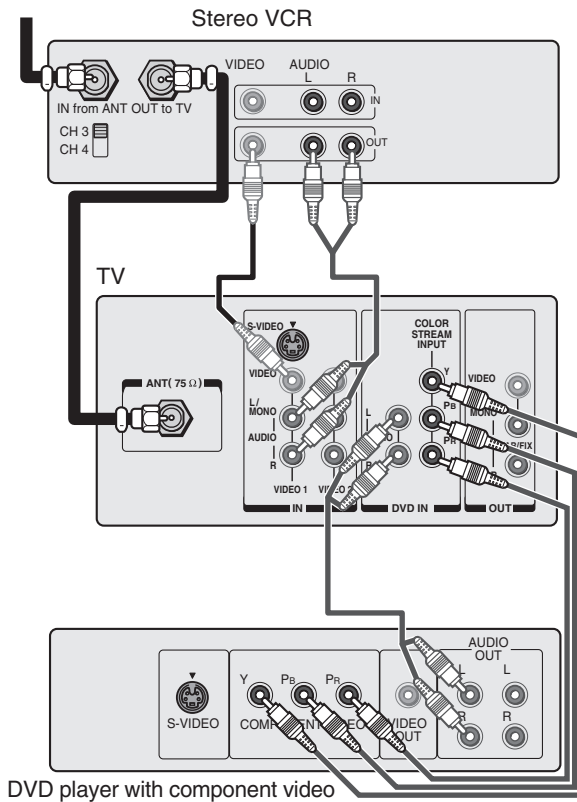

### Note:

- If your DVD player does not have component video connections, see "Connecting a DVD player or satellite receiver and a VCR" on page 9.
- The ColorStream (component video) inputs on this TV are for use with devices that output 480i interlaced signals ONLY. This TV will not accept or display 480p or 720p progressive scan signals or 1080i interlaced high-definition signals. **If you connect a high-definition set-top receiver, 480p progressive scan DVD player, or other similar device to the TV's ColorStream inputs, you must switch the device's output to 480i interlaced mode first.** Failure to do this will cause a poor picture or no picture to display.
- If you have a mono VCR, connect L/Mono to the VCR's AUDIO OUT terminal using only one audio cable.
- If you have a VCR with S-video, use an S-video cable instead of a standard video cable. Do not connect a standard video cable and an S-video cable to VIDEO-1 on the TV back (or VIDEO-3 on the TV front) at the same time, or the picture performance will be unacceptable.

The unauthorized recording, use, distribution, or revision of television programs, videotapes, DVDs, and other materials is prohibited under the Copyright Laws of the United States and other countries, and may subject you to civil and criminal liability.

## Connecting two VCRs

This connection allows you to record (dub/edit) from “VCR 1” to “VCR 2” (as illustrated below) while watching the videotape. You also can record from one TV channel while watching another channel.

### You will need:

- two coaxial cables
- two sets of standard A/V cables

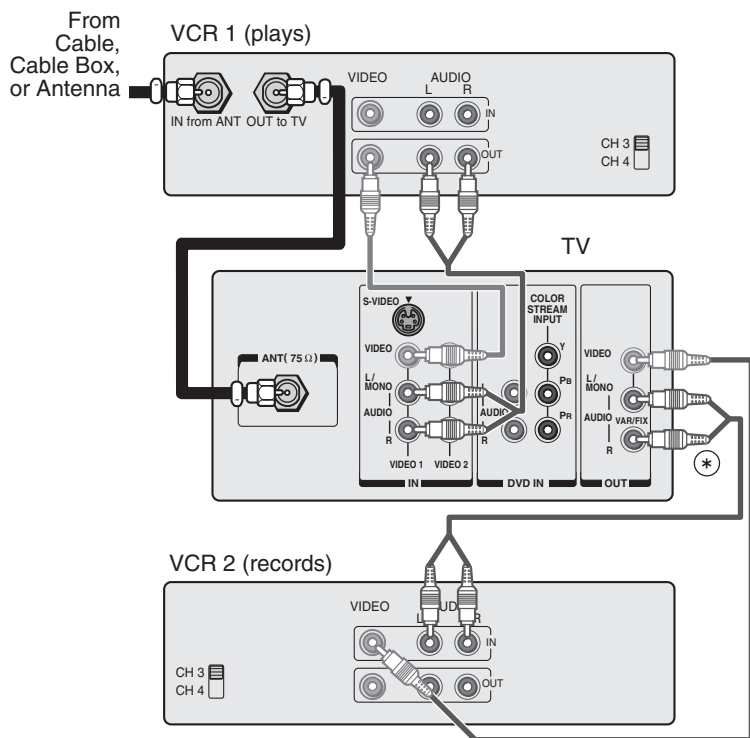

### Note:

- Do not connect the same VCR to the output and input connections on the TV at the same time. (See the illustration at left, which shows VCR1 connected to VIDEO-1 IN on the TV, and VCR2 connected to A/V OUT on the TV.)
- If your VCR has S-video, you can use an S-video cable (plus the standard audio cables) instead of a standard video cable for better picture quality. Do not connect both a standard video cable and an S-video cable to VIDEO-1 (or VIDEO-3) at the same time, or the picture performance will be unacceptable.
- To dub or edit, VCR 2 must select Line IN, and the TV must select VIDEO-1.
- **When recording to VCR 2, set AUDIO OUT to FIXED.** With AUDIO OUT set to FIXED, the TV's volume setting will not affect the sound level being recorded. See "Selecting fixed/variable AUDIO OUT" on page 39.

\* The AUDIO OUT connections can output either FIXED or VARIABLE audio. See "Selecting fixed/variable AUDIO OUT" on page 39.

**The unauthorized recording, use, distribution, or revision of television programs, videotapes, DVDs, and other materials is prohibited under the Copyright Laws of the United States and other countries, and may subject you to civil and criminal liability.**

## Connecting a camcorder

This connection allows you to watch videos recorded on a camcorder.

### You will need:

- one set of standard A/V cables (see notes at right)

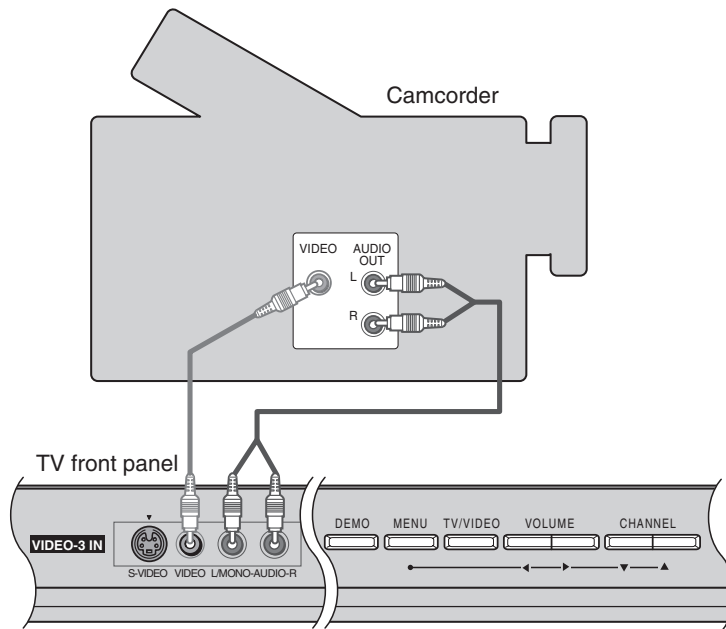

### Note:

- For better picture quality, if your camcorder has S-video, you can use an S-video cable (plus the standard audio cables) instead of a standard video cable.
- Do not connect both a standard video cable and an S-video cable at the same time, or the picture performance will be unacceptable.

## Connecting an audio system

This connection allows you to use an audio amplifier to adjust the audio level. This connection also allows you to use external speakers.

To control the audio, turn on the TV and the stereo amplifier, and turn off the built-in speakers. (See "Turning off the built-in speakers" on page 39.)

### You will need:

- one coaxial cable
- one pair of standard audio cables

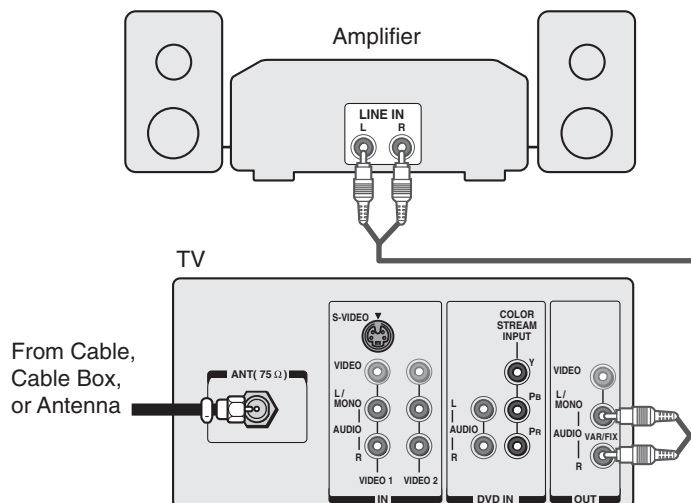

### Note:

- When using an external audio amplifier, if you set AUDIO OUT to VARIABLE, the volume of both the TV and amplifier must be set above 0 (zero) or you will not hear any sound. See "Selecting fixed/variable AUDIO OUT" on page 39.
- If you set AUDIO OUT to VARIABLE, the TV's volume controls will adjust the volume. If you set AUDIO OUT to FIXED, you must use the amplifier's volume controls to adjust the volume. See "Selecting fixed/variable AUDIO OUT" on page 39.

## Using the remote control

### Preparing the remote control for use

Your TV remote control can operate your TV and most cable converter boxes, satellite receivers, VCRs, DVD players, and HTIBs (home theater in a box), even if they are different brands.

#### If you have a Toshiba device:

Your TV remote control is preprogrammed to operate most Toshiba devices. See pages 14 and 17.

#### If you have a non-Toshiba device or a Toshiba device that the remote control is not preprogrammed to operate:

You can program the TV remote control so it will operate the other device. See pages 15–16.

### Installing the remote control batteries

- 1 Remove the battery cover from the back of the remote control.

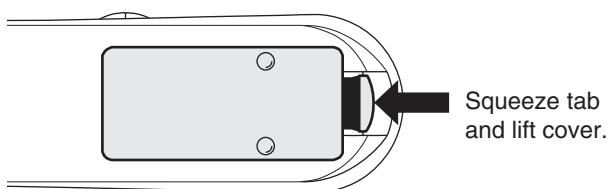

#### Caution:

- Dispose of batteries in a designated disposal area. Do not throw batteries into a fire.
- Do not mix battery types or combine used batteries with new ones.
- Remove dead batteries immediately to prevent battery acid from leaking into the battery compartment.
- If you do not intend to use the remote control for a long time, remove the batteries.

- 2 Install two “AA” size batteries, making sure to match the + and – signs on the batteries to the signs on the battery compartment.

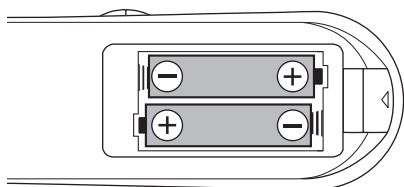

- 3 Reinsert the battery cover in the remote control until the tab snaps.

## Location of controls on TV and remote control

For details on the use of each control, refer to pages in brackets.

### TV front panel

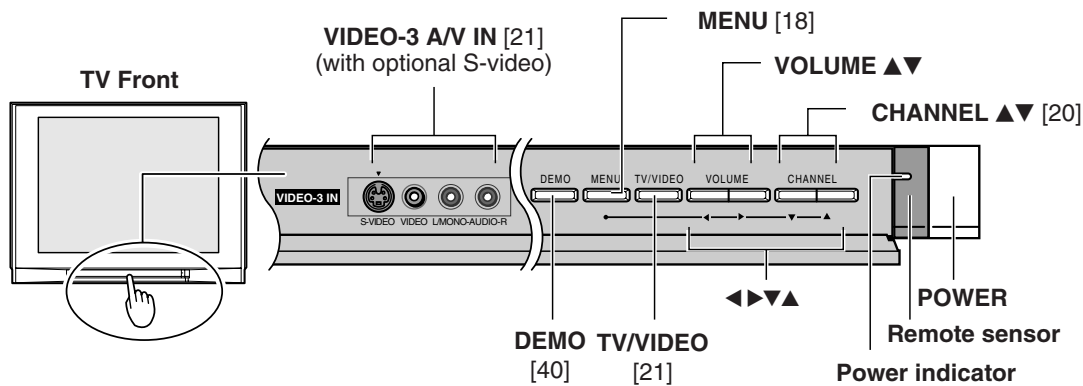

### Remote control

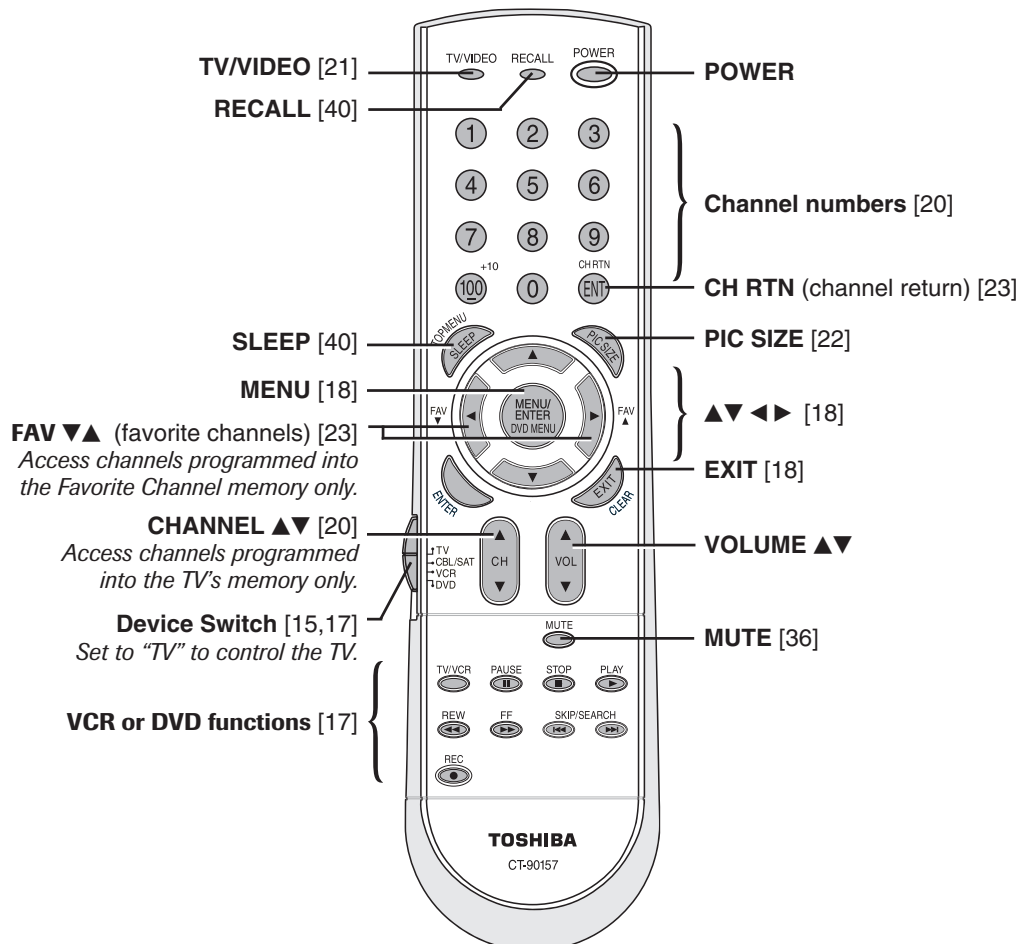

## Programming the remote control to operate a cable converter box, satellite receiver, VCR, DVD player, or HTIB (home theater in a box)

Your Toshiba TV remote control is preprogrammed to operate most Toshiba devices. To program your TV remote control to operate a non-Toshiba device or a Toshiba device that it is not preprogrammed to operate, follow the steps below. For details on using the remote control to operate the device, see page 17.

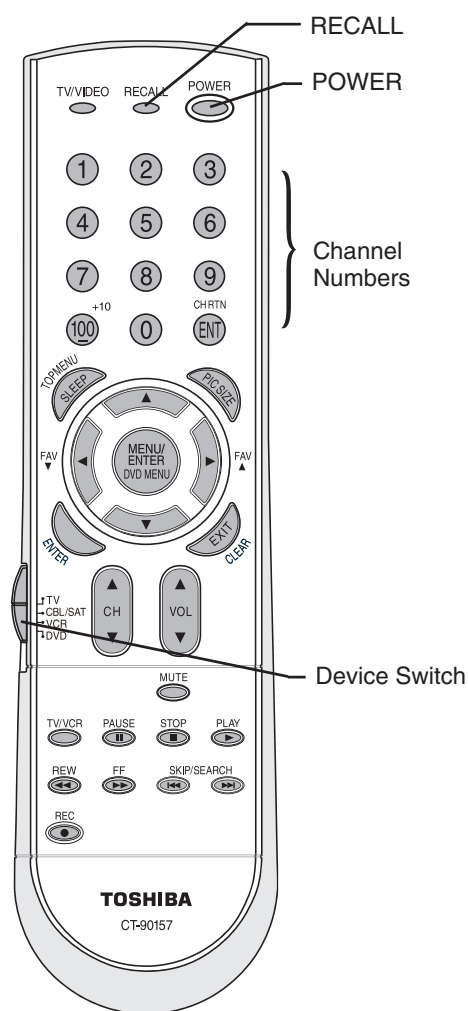

- 1 In the remote control code table (below and on the next page), find the code for your device. If more than one code is listed, try each one separately until you find one that works.
- 2 Set the Device Switch to the type of device you are programming the remote control to operate—CBL/SAT (for a cable converter box or satellite receiver), VCR (for a VCR or TV/VCR combo), or DVD (for a DVD player or HTIB [home theater in a box]).
- 3 While holding down RECALL, press the Channel Number buttons to enter the 3-digit code for your device.
- 4 To test the code, turn on the device, point the remote control at it, and press POWER.
  - If the correct code was entered, the device will turn off.
  - If the device does not respond, repeat steps 1–4 using another code.

**Note:** After programming the TV remote control to operate your other device, confirm that all necessary keys are operational. If some keys on the TV remote control do not operate certain features on your other device, reprogram the remote control using another code (if other codes are listed for your device). If, after trying all listed codes, the necessary buttons do not operate your device, use the device's original remote control.

- 5 Remember to set the Device Switch back to “TV” to control the TV.
- 6 For future reference, write down the code(s) you used:

DEVICE	CODE	DEVICE	CODE

### Note:

Each time you change the batteries, you must reprogram the remote control.

Some newer VCRs respond to either of two codes. These VCRs have a switch labeled “VCR1/VCR2.” If your VCR has this kind of switch and does not respond to the codes for your VCR brand, set the switch to the other position (“VCR1” or “VCR2”) and reprogram the remote control.

## Remote control codes

In some cases you may not be able to operate your device with the TV remote control. Your other device may use a code that is not recognized by the TV remote control. If this happens, you will need to use the remote control provided with the device.

### Cable converter box

ABC: 061, 062, 063, 082, 084, 087, 091, 092, 096, 098  
 Archer: 065, 092, 097, 099  
 Cableview: 064, 094  
 Century: 092  
 Citizen: 090, 092, 097  
 Contec: 083, 085, 086, 088, 093, 098  
 Diamond: 093  
 Eagle: 091  
 GE: 061, 062  
 Gemini: 069, 070, 094

General Instruments: 062, 089, 096  
 Hamlin: 093  
 Hitachi: 062, 095, 096  
 Jasco: 097  
 Jerrold: 062, 069, 071, 082, 086, 089, 091, 096  
 Magnavox: 072, 096  
 Memorex: 091, 092, 104  
 Multi Canal: 090  
 Novavision: 101  
 Panasonic: 081, 083, 085  
 Philco: 087

Philips: 066, 067, 068, 070, 072, 073, 074, 075, 091, 092  
 Pioneer: 076, 077  
 Proscan: 061, 062  
 Radio Shack: 092, 097, 099  
 RCA: 064, 081  
 Realistic: 065  
 Recoton: 102  
 Samsung: 077, 090  
 Scientific Atlanta: 063, 078, 079, 080, 088, 098, 101, 105

Sears: 095  
 Signature: 062  
 Signature 2000: 096  
 Sprucer: 081, 085  
 Starcom: 069, 082, 087, 096, 103, 104  
 Stargate: 069, 090  
 Sylvania: 095, 100  
 TeleView: 090  
 Texscan: 100  
 Tocom: 071, 084, 085  
 U. S. Electronics: 087, 096, 098  
 United Cable: 082

Universal: 065, 092, 097, 099, 102, 103  
 Wards: 096

### Satellite receiver

Alphastar: 038, 059  
 Chaparral: 034  
 DISH Network: 057  
 Drake: 020, 040, 044, 046, 050, 053  
 Echostar: 018, 041, 051  
 Express Vu: 057  
 Fujitsu: 027  
 GE: 008, 009, 013

## Remote control codes (cont.)

**Satellite receiver  
(cont.)**

General Instruments: 010, 011, 012, 022, 023, 031, 049  
 Hitachi: 033  
 Hughes: 033  
 Hughes Network Systems: 019  
 Intersat: 048  
 Janeil: 027  
 JVC: 017, 057  
 Kenwood: 029  
 Magnavox: 060  
 Optimus: 058  
 Pansat: 036, 052  
 Primestar: 015, 042  
 Proscan: 008, 009, 013  
 Radio Shack: 022, 023, 030  
 RCA: 008, 009, 013, 016  
 Realistic: 030  
 Samsung: 059  
 Sony: 014, 055  
 Star Choice: 057  
 Star Trak: 025, 026, 037, 054  
 STS: 024  
 Toshiba: 000, 001, 002, 003, 004, 005, 006, 007, 020, 031, 056  
 Uniden: 021, 028, 030, 032, 035, 039, 043, 045, 047, 058  
 Zenith: 027

**TV/VCR Combo**

Action: 078  
 GE: 059, 062  
 Goldstar: 065  
 Panasonic: 065  
 Precision: 078  
 Quasar: 065  
 Realistic: 079  
 Sony: 074  
 Toshiba: 057  
 Zenith: 065

**DVD/VCR Combo**

Go Video:  
 DVD=087, VCR=081  
 JVC:  
 DVD=088, VCR=082  
 RCA:  
 DVD=089, VCR=083  
 Samsung:  
 DVD=090, VCR=084  
 Sanyo:  
 DVD=091, VCR=085  
 Zenith:  
 DVD=092, VCR=086

**DVD player**

Aiwa: 006, 015  
 Apex: 016, 017  
 BOSE: 097  
 Broksonic: 018  
 Clarion: 019  
 Classic: 020  
 Daewoo: 021  
 Denon: 022, 023, 024, 025  
 Emerson: 026, 027  
 Fisher: 028  
 Funai: 027  
 GE: 001, 029, 030  
 Go Video: 087  
 GPX: 031  
 Hitachi: 005, 032, 033, 034, 035  
 JVC: 003, 007, 036, 042, 088  
 Kenwood: 037  
 Konka: 008, 009  
 Magnavox: 004, 038  
 Memorex: 039  
 Mintek: 040  
 NAD: 026  
 Nakamichi: 041  
 Norcent: 043  
 Onkyo: 044  
 Oritron: 058  
 Panasonic: 010, 045, 046, 047, 048, 049, 050  
 Philips: 004, 051  
 Pioneer: 052, 053, 054, 055  
 Proscan: 001, 056  
 Qwestar: 057, 058  
 RCA: 001, 002, 059, 089  
 Sampo: 060  
 Samsung: 061, 062, 086, 090  
 Sansui: 073  
 Sanyo: 063, 091  
 Sharp: 064, 067  
 Sherwood: 074  
 Sony: 011, 012, 065, 066, 068, 069, 070  
 Sylvania: 027  
 Teac: 071  
 Technics: 072  
 Techwood: 075  
 Toshiba: 000, 013, 076, 077, 078  
 Yamaha: 079, 080, 081  
 Zenith: 014, 082, 092

**Portable DVD player**

Aiwa: 093  
 Audiovox: 094, 095  
 Panasonic: 024, 096, 099  
 RCA: 098

**VCR**

Admiral: 049  
 Aiko: 019  
 Aiwa: 018  
 Akai: 003, 004, 037, 038, 039, 058, 069  
 Audiovox: 010  
 Bell & Howell: 007, 068  
 Broksonic: 008, 017  
 Calix: 010  
 Carver: 026  
 CCE: 019  
 Citizen: 009, 010, 011, 012, 013, 014, 015, 019, 057, 073  
 Colortyme: 005  
 Craig: 009, 010, 016, 061, 065, 079  
 Curtis Mathes: 001, 005, 009, 012, 014, 040, 048, 053, 056, 057  
 Daewoo: 011, 013, 015, 017, 018, 019, 057, 078  
 Daytron: 078  
 Denon: 063  
 Dimensia: 001, 048  
 Electrohome: 010, 020, 065  
 Emerson: 003, 008, 010, 011, 017, 018, 020, 028, 039, 054, 057, 062, 065, 068, 072  
 Fisher: 007, 016, 021, 022, 023, 057, 064, 068, 070, 071, 079  
 Fuji: 004, 041  
 Funai: 018, 073  
 Garrard: 018  
 GE: 001, 002, 009, 040, 042, 048, 056  
 Go Video: 056, 059, 061, 081  
 Goldstar: 005, 010, 014, 054, 056, 065, 067  
 Gradiente: 018, 065  
 Harman Kardon: 005  
 Hitachi: 024, 025, 035, 037, 042, 063, 070, 080  
 JBL: 076  
 JC Penney: 005, 006, 007, 008, 009, 010, 023, 024, 025, 026, 035, 056, 061, 063, 065  
 Jensen: 024, 025, 037, 050  
 JVC: 005, 006, 007, 014, 037, 043, 050, 062, 063, 068, 082  
 Kenwood: 005, 006, 007, 012, 014, 037, 043, 050, 053, 068, 071  
 Kodak: 010  
 LG: 010  
 Lloyds: 053, 073, 079  
 Logik: 061  
 LXI: 010  
 Magnasonic: 061, 065, 078  
 Magnavox: 026, 027, 034, 044, 057, 061, 072  
 Marantz: 005, 006, 007, 012, 014, 026, 053, 067  
 Memorex: 007, 009, 010, 016, 018, 034, 049, 063, 065, 066, 068, 075, 079  
 MGA: 020, 028, 039  
 MGN: 056  
 Minolta: 024, 025, 035, 063  
 Mitsubishi: 020, 024, 025, 028, 039, 043, 065  
 Montgomery Ward: 049  
 Motorola: 049  
 MTC: 009, 046, 061  
 Multitech: 009, 012, 018  
 NEC: 005, 006, 007, 012, 014, 037, 043, 053, 054, 067, 070  
 Nikko: 010  
 Noblex: 009  
 Optimus: 010, 049, 065  
 Optonica: 031  
 Orion: 054, 057, 062, 065, 068, 072  
 Panasonic: 036, 045, 046, 057, 061, 072, 079  
 Pentax: 012, 024, 025, 035, 042, 053, 063  
 Pentex Research: 014  
 Philco: 026, 027, 063  
 Philips: 026, 031, 044, 057  
 Pioneer: 006, 024, 043, 055  
 Portland: 012, 013, 015  
 Proscan: 001, 002, 048  
 Proton: 061  
 Quasar: 045  
 Radio Shack: 010, 031, 065  
 Radio Shack/Realistic: 007, 009, 010, 016, 018, 020, 021, 022, 031, 049  
 Radix: 010  
 RCA: 001, 002, 003, 009, 024, 025, 029, 035, 040, 042, 045, 048, 055, 056, 063, 071, 083  
 Realistic: 007, 009, 010, 011, 016, 018, 020, 021, 022, 031, 049, 051, 056, 060, 065, 075, 079

Ricoh: 047  
 Runco: 034  
 Samsung: 009, 011, 038, 056, 073, 084  
 Sansui: 006, 037, 043, 061  
 Sanyo: 007, 009, 016, 054, 064, 068, 071, 075, 079, 085  
 Scott: 008, 011, 017, 028, 030, 057, 065, 072  
 Sears: 007, 010, 016, 021, 022, 023, 024, 025, 035, 053, 057, 063, 064, 065, 068, 071, 075, 079  
 Sharp: 013, 020, 031, 049, 051, 060, 066  
 Shintom: 004, 025, 032, 061  
 Signature: 049  
 Signature 2000: 075  
 Singer: 047, 061  
 Sony: 004, 032, 033, 041, 052, 058, 070, 074, 076, 077, 080  
 STS: 035  
 Sylvania: 018, 026, 027, 028, 044, 072  
 Symphonic: 018, 050, 051, 053, 073, 079  
 Tandy: 007  
 Tashiko: 010  
 Tatung: 037  
 Teac: 018, 029, 037  
 Technics: 036  
 Teknika: 010, 018, 065  
 Toshiba: 057, 011, 021, 023, 024, 028, 030, 039, 074, 078, 079, 000  
 Totevision: 009, 010, 065  
 Unitech: 073  
 Unitech: 009  
 Vector Research: 005, 006, 011, 012, 053  
 Video Concepts: 005, 006, 011, 012, 039, 053  
 Wards: 009, 010, 011, 016, 018, 020, 024, 025, 031, 035, 049, 051, 056, 057, 060, 065, 066, 079  
 White Westinghouse: 073  
 XR-1000: 018  
 Yamaha: 005, 006, 007, 014, 037, 053  
 Zenith: 004, 032, 034, 041, 047, 069, 086

**HTIB**

Lasonic: 083  
 Panasonic: 084  
 Venturer: 085



## Using the remote control to operate a cable converter box, satellite receiver, VCR, DVD player, or HTIB (home theater in a box)

If you have a non-Toshiba device or a Toshiba device that the remote control is not preprogrammed to operate, you must first program the remote control to recognize the device (if you have not already done so). See pages 15–16.

### To use your TV remote control to operate a:

- cable converter box or satellite receiver, set the Device Switch to CBL/SAT.
- VCR, set the Device Switch to VCR.
- DVD player or HTIB, set the Device Switch to DVD.

### Note:

- Even after the TV remote control is programmed, it may not operate certain features on your other device. If this happens and you wish to use those features, you will need to use the device's original remote control.
- This illustration describes typical external device functions (not TV functions). The buttons on this remote control may or may not work as described for your specific device.

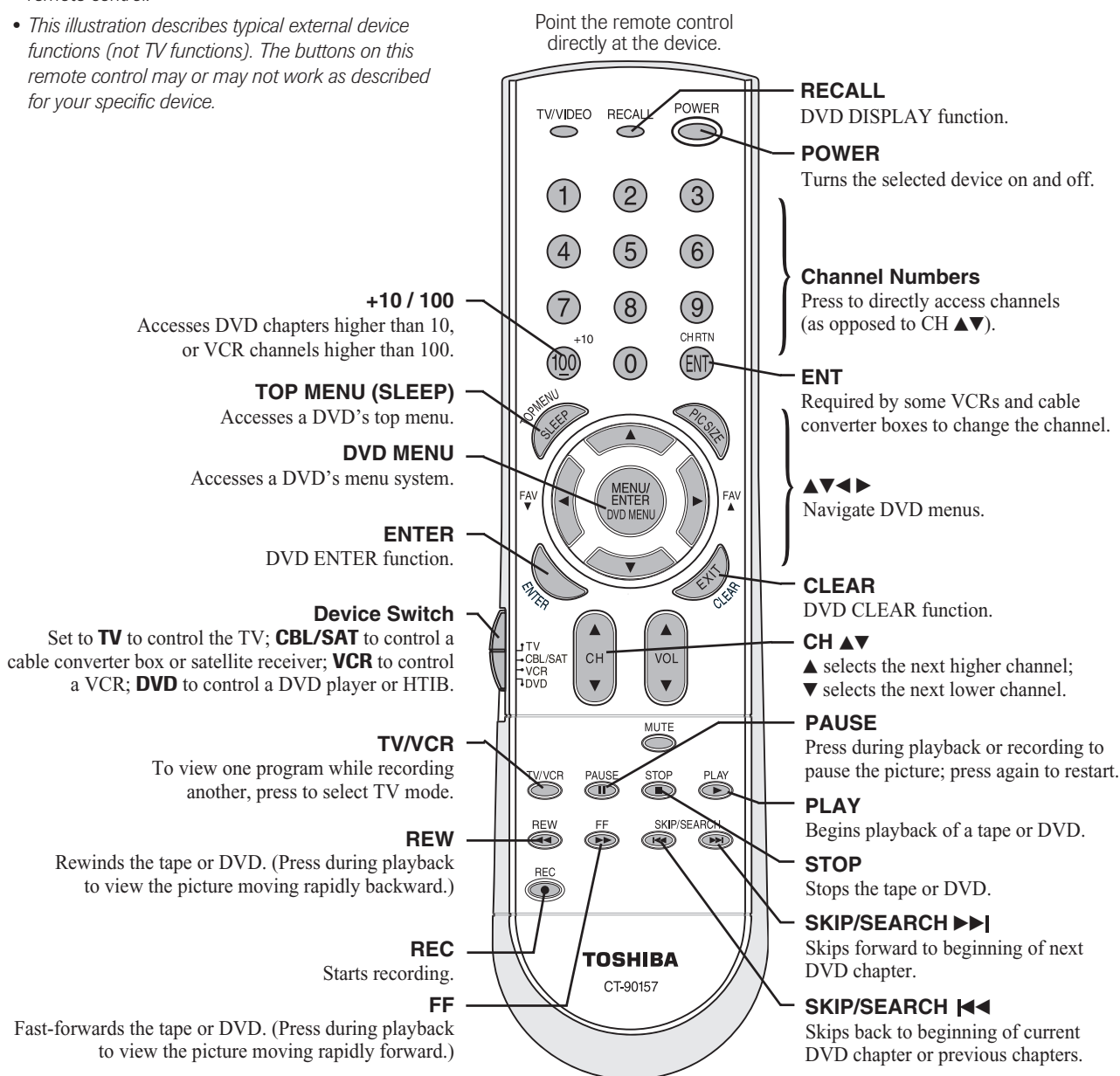

# Setting up your TV

## Learning about the menu system

After you have installed the batteries and programmed the remote control, you will need to set some preferences on the TV using the menu system. You can access the menus using the buttons on your TV or remote control.

- Press MENU to display the menu system.
- Press ◀ or ▶ to select a menu.
- Press ▲ or ▼ to select an item.
- Press ◀ or ▶ to select or adjust a setting.
- If you do not make a selection within 15 seconds, the main menus close automatically (6 seconds for the other menus).
- To close an on-screen display instantly, press EXIT.

**Note:** The TV front panel does not have an EXIT button.

All menu adjustments are saved automatically, whether or not you press EXIT to close the display.

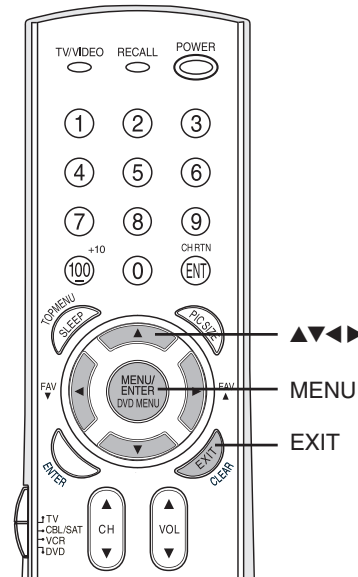

Setting up your TV

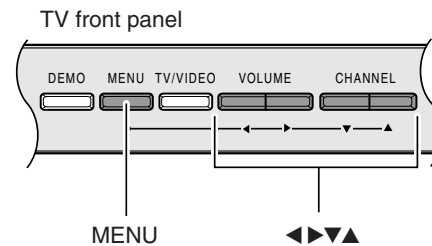
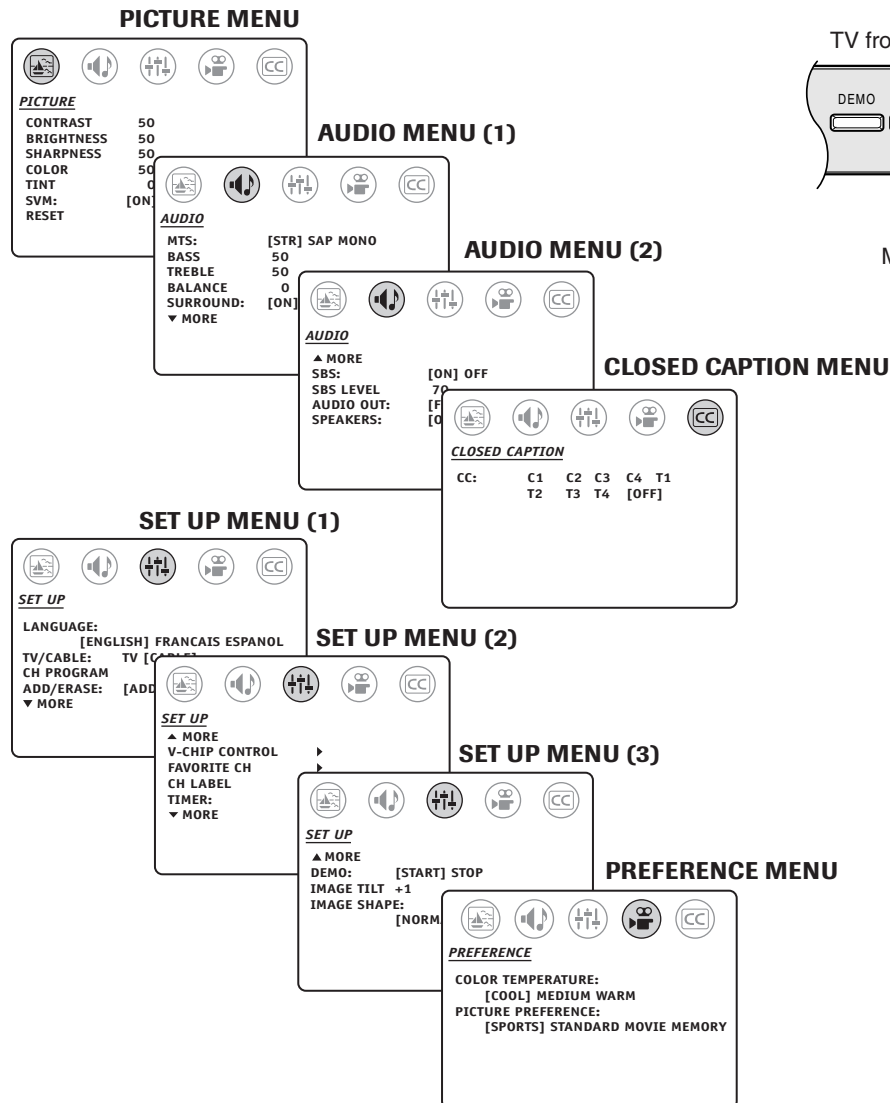

## Changing the on-screen display language

You can choose from three different languages (English, French and Spanish) for the on-screen display of adjustment menus and messages.

### To select an on-screen display language:

1. Press MENU, and then press ◀ or ▶ until the SET UP menu appears.
2. Press ▲ or ▼ to highlight LANGUAGE.
3. Press ◀ or ▶ to highlight your desired language.

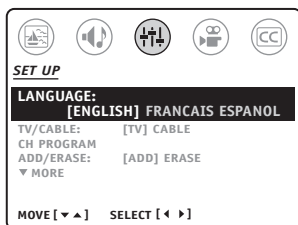

## Programming channels into the channel memory

When you press CHANNEL ▲ or ▼ on the remote control or TV front panel, your TV will stop only on the channels stored in the channel memory. Follow the steps below and on the next page to program channels into the channel memory.

### Programming channels automatically

Your TV can automatically detect all active channels in your area and store them in the channel memory. After the channels are stored automatically, you can manually add or erase individual channels

### To program channels automatically:

1. Press MENU, and then press ◀ or ▶ until the SET UP menu appears.
2. Press ▲ or ▼ until TV/CABLE is highlighted.
3. Press ◀ or ▶ to highlight either TV (if you use an antenna) or CABLE (if you have cable service).
4. Press ▼ to highlight CH PROGRAM.

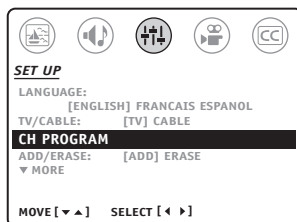
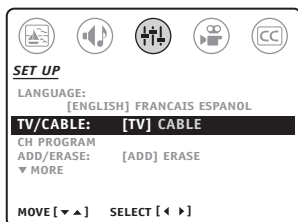

5. Press ◀ or ▶ to start channel programming. The TV will automatically cycle through all the TV or CABLE channels (depending on which you selected), and store all active channels in the channel memory.

While the TV is cycling through the channels, the message "CH PROGRAM" appears.

6. When channel programming is complete, the message "CH PROGRAMMING COMPLETED" appears.
7. Press CHANNEL ▲ or ▼ to view the programmed channels.

(Continued on next page)

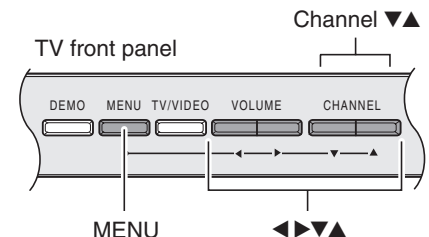
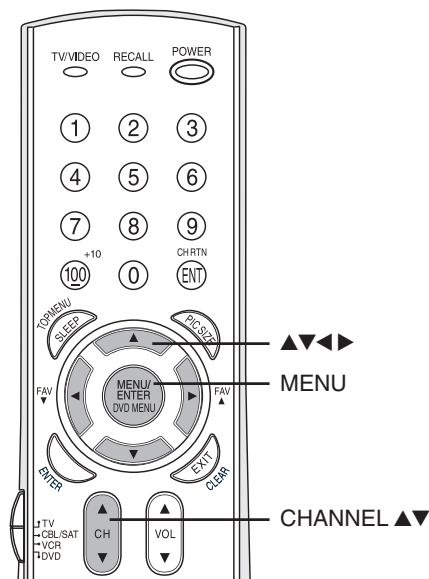

(Continued from previous page)

## Adding and erasing channels manually

After you automatically program the channels into the channel memory (see previous page), you can manually add or erase specific channels.

### To manually add or erase channels:

1. Select the channel you want to add or erase. If you are adding a channel, you must select the channel using the Channel Number buttons on the remote control.
2. Press MENU, and then press ◀ or ▶ until the SET UP menu appears.
3. Press ▲ or ▼ to highlight ADD/ERASE.

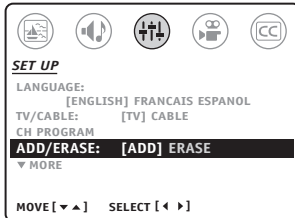

4. Press ◀ or ▶ to select ADD or ERASE, depending on the function you want to perform.
5. Repeat steps 1–4 for other channels you want to add or erase.

## Changing channels

### To change to the next programmed channel:

Press Channel ▲ or ▼ on the TV or remote control.

### To change to a specific channel (programmed or unprogrammed):

Press the Channel Numbers (0–9 and 100).

For channels 100 and higher, press the 100 button and then the next two numbers. For example, to select channel 125, press 100–2–5.

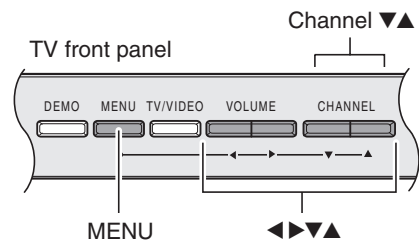
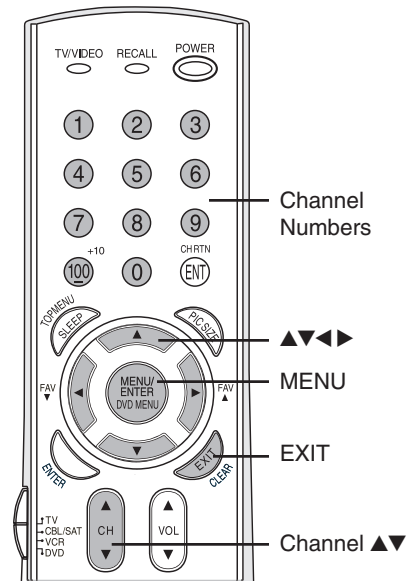

## Selecting the signal source

To view a program from other devices connected to your TV (through the VIDEO 1, VIDEO 2, VIDEO 3, or ColorStream inputs) or from the TV's antenna input (labeled "ANT" on the TV back panel, and designated as "TV" in the signal source menu, illustrated below), you must select the applicable signal source.

**Note:** If no device is connected to any of the inputs on the TV, no picture will display when you select that particular signal source. For device connection details, see "Connecting your TV" on pages 7-12.

### To select the signal source:

Press TV/VIDEO on the remote control or TV front panel. The current signal source displays in purple on-screen.

- Pressing TV/VIDEO on the remote control one time *displays* the current signal source. To change the source, continue pressing TV/VIDEO or use the Channel Numbers to select 0-4.
- Pressing TV/VIDEO on the TV one time *changes* the current signal source. Continue pressing TV/VIDEO to change the source.

**Note:**

- When the ColorStream signal source is active, the VIDEO OUT terminal outputs a black-and-white signal only. To receive a color VIDEO OUT signal, a standard video or S-video IN jack must be used instead of the ColorStream connections.

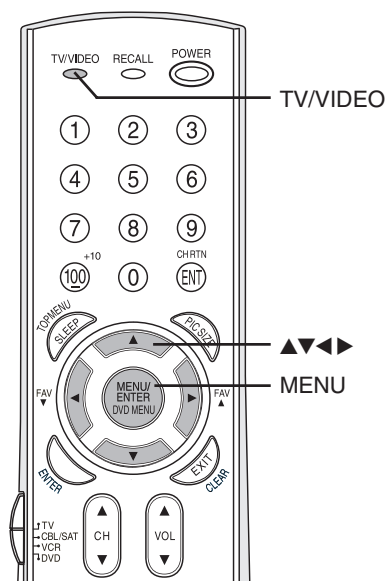
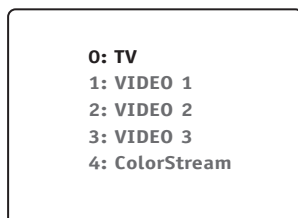

TV front panel

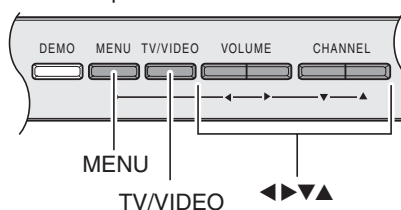

## Adjusting the IMAGE TILT feature

When you install or change the direction of the TV, the picture may become tilted (caused by terrestrial magnetism). If this happens, use the IMAGE TILT feature to obtain the best possible picture.

### To adjust the image tilt:

1. Press MENU, and then press ◀ or ▶ until the SET UP menu appears.
2. Press ▲ or ▼ to highlight IMAGE TILT.
3. Press ◀ or ▶ to correct the picture tilt (from -10 to +10).

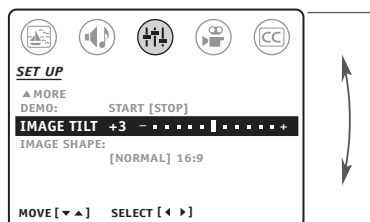

TV back panel

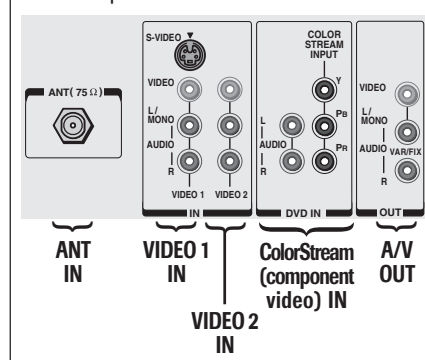

TV front panel

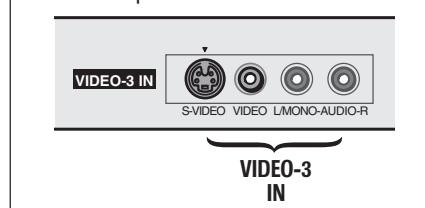

## Adjusting the IMAGE SHAPE feature

The IMAGE SHAPE feature allows you to adjust the shape of the image when viewing 16:9 (widescreen) content from an external device (for example, a DVD player). This feature enables you to watch 16:9 content in the highest possible resolution (when you select "16:9" mode in step 2, below). See "Notice of possible adverse effects on TV picture tube," below right.

### To adjust the image shape:

1. Press PIC SIZE on the remote control. The SET UP menu opens and IMAGE SHAPE is highlighted.

**Note:** You also can use the menu system to adjust the IMAGE SHAPE. Press MENU and then ◀ or ▶ to open the SET UP menu. Press ▲ or ▼ to highlight IMAGE SHAPE. Then go to step 2.

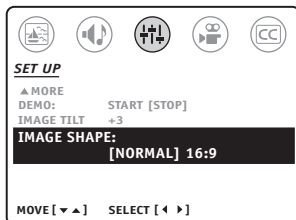

2. Press ◀ or ▶ to select NORMAL or 16:9 mode, as described below.
  - **NORMAL**—Displays the picture in normal/conventional 4:3 format, regardless of the signal type.
 

To use the NORMAL IMAGE SHAPE mode, you must first adjust your DVD player's menu settings to normal/conventional TV mode (4:3 aspect ratio).
  - **16:9**—Compresses the signal to letterbox (16:9) mode (with bars at the top and bottom of the screen), regardless of the signal type.
 

To use the 16:9 IMAGE SHAPE mode, you must first adjust your DVD player's menu settings to widescreen TV mode (16:9 aspect ratio).  
The 16:9 IMAGE SHAPE mode is not available when viewing an antenna signal source.

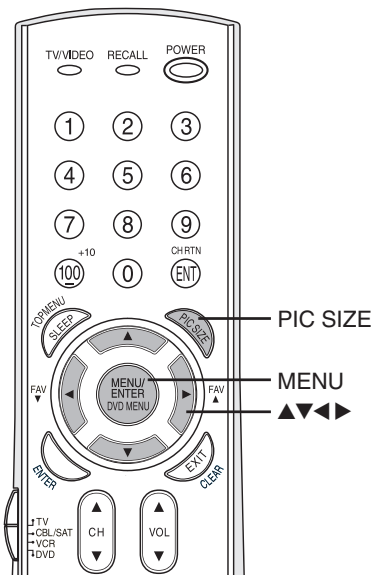

### Note:

- The factory (default) setting for the IMAGE SHAPE feature is "NORMAL."
- Aspect ratio is the ratio of width to height of your TV screen or of the image you are viewing.

### NOTICE OF POSSIBLE ADVERSE EFFECTS ON TV PICTURE TUBE

Avoid displaying stationary images on your TV screen for extended periods of time. Fixed (non-moving) images (such as black or gray bars on widescreen/16:9 format images) can become permanently engrained in the picture tube. **This type of damage is NOT COVERED BY YOUR WARRANTY because it is the result of misuse.** See item 33 on page 4.

# Using the TV's features

## Adjusting the channel settings

### Switching between two channels

You can switch between two channels without entering an actual channel number each time.

#### To switch between two channels:

1. Select the first channel you want to view.
2. Select a second channel using the Channel Numbers (0–9, 100).
3. Press CH RTN. The previous channel will display.

Each time you press CH RTN, the TV will switch back and forth between the last two channels you tuned the TV to.

### Programming your favorite channels

The favorite channel feature allows you to use the FAV ▼/FAV▲ keys to cycle through your favorite channels only, skipping over channels you do not usually watch.

You can program up to 12 of your favorite channels into the favorite channel memory.

#### To program a channel into the favorite channel memory:

1. Tune the TV to a channel you want to program as a favorite channel.
 

**Note:** The TV must be in "CABLE" mode to program a cable channel and in "TV mode" to program an antenna channel.  
Select TV/CABLE in the SET UP menu.
2. Press MENU, and then press ◀ or ▶ until the SET UP menu appears.
3. Press ▲ or ▼ to highlight FAVORITE CH, and then press ▶ to open the FAVORITE CH menu.
4. Press ◀ or ▶ to highlight SET, press ▼, and then press EXIT.

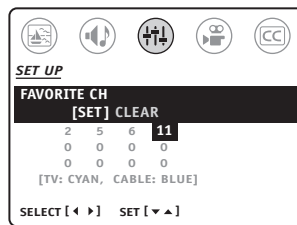
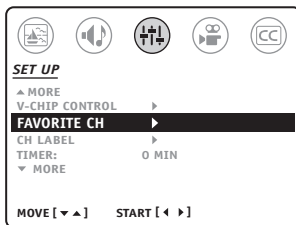

5. Repeat steps 1–4 for up to 12 channels.

#### To select your favorite channels:

Press FAV ▼ or FAV▲ on the remote control.

**Note:** You can still use CH ▲▼ to cycle through the channels you programmed into the "regular" channel memory on page 19.

#### To clear a channel from the favorite channel memory:

1. Tune the TV to a channel you want to clear from the favorite channel memory.
2. Press MENU, and then press ◀ or ▶ until the SET UP menu appears.
3. Press ▲ or ▼ to highlight FAVORITE CH, and then press ▶ to open the FAVORITE CH menu.
4. Press ◀ or ▶ to highlight CLEAR, press ▼, and then press EXIT.
5. Repeat steps 1–4 for other channels you want to clear from the favorite channel memory.

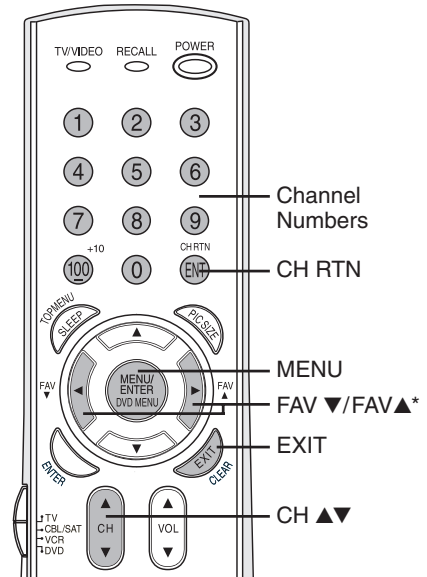
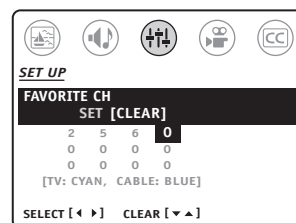

\*The FAV ▼/FAV▲ keys function as menu ◀/▶ keys when a menu is on-screen.

#### Note:

- Once programmed, antenna channels appear in light blue text and Cable channels appear in dark blue text in the FAVORITE CH menu (shown at left).

## Labeling channels

You can choose any four characters to identify a channel. Channel labels appear above the on-screen channel number display each time you turn on the TV, change the channel, or press RECALL. You can assign labels to a maximum of 32 channels.

### To create a channel label:

1. Tune the TV to the channel you want to label.
 

**Note:** The TV must be in "CABLE" mode to label a cable channel and in "TV mode" to label an antenna channel. Select TV/CABLE in the SET UP menu.
2. Press MENU, and then press ◀ or ▶ until the SET UP menu appears.
3. Press ▲ or ▼ to highlight CH LABEL, and then press ▶ to open the CH LABEL menu.
4. Press ◀ or ▶ to highlight SET.

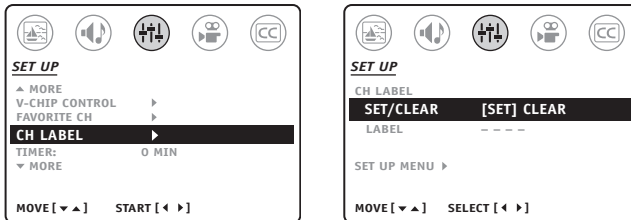

5. Press ▼ to highlight LABEL.
6. Repeatedly press ◀ or ▶ to select a character for the first space, and then press MENU. Repeat this step for all four characters.

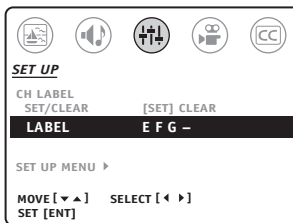

#### **Note:**

For a blank space in the label name, choose a blank space from the list of characters.

You must assign a character to all four spaces in the label or the label will not be assigned.

7. Repeat steps 1–6 for other channels you want to label.

### To erase a channel label:

1. Tune the TV to the channel whose label you want to erase.
 

**Note:** You must be in CABLE mode to erase a cable channel label and in TV mode to erase an antenna channel label. Select TV/CABLE in the SET UP menu.
2. Press MENU, and then press ◀ or ▶ until the SET UP menu appears.
3. Press ▲ or ▼ to highlight CH LABEL, and then press ▶ to open the CH LABEL menu.
4. Press ◀ or ▶ to highlight CLEAR, and then press ▼.

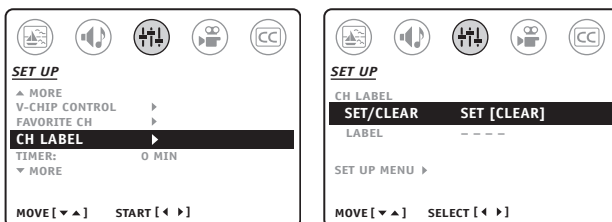

5. Press EXIT.
6. Repeat steps 1–5 to erase other channel labels.

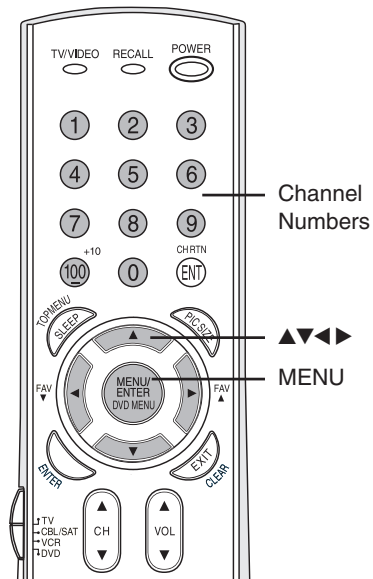



## Adjusting the picture

You can adjust the TV's picture to your personal preferences or to factory settings. The settings you can adjust include the picture quality (contrast, brightness, sharpness, color, tint) and color temperature. *See note at right.*

### Adjusting the picture quality

You can adjust the contrast, brightness, sharpness, color, and tint, as described in the following table. *See note at right.*

Selection	◀ Pressing ▶	
Contrast	lower	higher
Brightness	darker	lighter
Sharpness	softer	sharper
Color	paler	deeper
Tint	reddish	greenish

#### To adjust the picture quality:

1. Press MENU, and then press ◀ or ▶ until the PICTURE menu appears.
2. Press ▼ or ▲ until the quality you want to adjust is highlighted.
3. Press ◀ or ▶ to adjust the level.

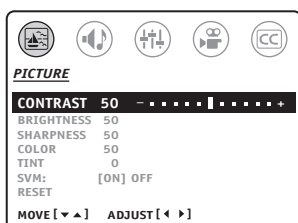

### Adjusting the color temperature

You can change the quality of the picture by selecting from three preset color temperatures (cool, medium, and warm), as described in the table below. *See note, above right.*

Mode	Picture Quality
Cool	Blueish
Medium	Neutral
Warm	Reddish

#### To adjust the color temperature:

1. Press MENU, and then press ◀ or ▶ until the PREFERENCE menu appears.
2. Press ▲ or ▼ to highlight COLOR TEMPERATURE.
3. Press ◀ or ▶ to highlight the mode you prefer.

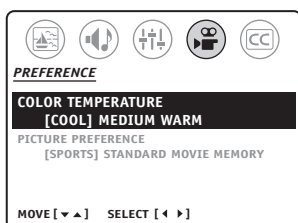

**Note:** The picture quality and color temperature adjustments you make are automatically saved in the MEMORY picture preference mode. You can select the MEMORY mode or choose preset options in the PREFERENCE menu. When you adjust the picture, the picture preference mode automatically changes to MEMORY. See "Selecting the picture preference mode" on page 26.

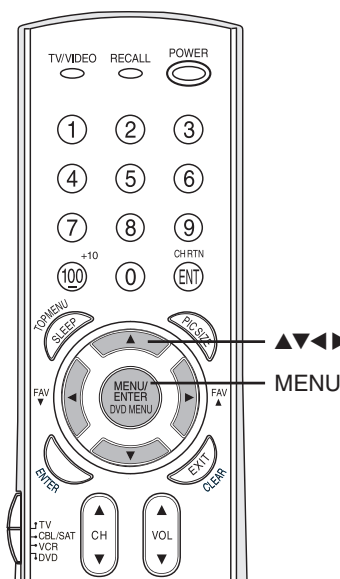

## Selecting the picture preference mode

You can select from four picture preference modes—Sports, Standard, Movie, and Memory—as described in the following table.

Mode	Picture Quality
Sports	Bright and dynamic picture (factory setting)
Standard	Standard picture setting (factory setting)
Movie	Movie-like picture setting (factory setting)
Memory	Your picture adjustments (see note at right)

### To select the picture preference mode:

1. Press MENU, and then press ◀ or ▶ until the PREFERENCE menu appears.
2. Press ▼ or ▲ to highlight PICTURE PREFERENCE.
3. Press ◀ or ▶ to highlight the mode you prefer.

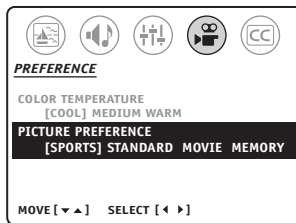

## Using the SVM (scan velocity modulation) feature

The SVM feature enhances picture sharpness.

### To turn on the SVM feature:

1. Press MENU, and then press ◀ or ▶ until the PICTURE menu appears.
2. Press ▲ or ▼ to highlight SVM.
3. Press ◀ or ▶ to highlight ON.

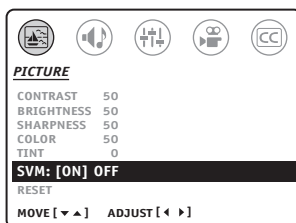

### To turn off the SVM feature:

Highlight OFF in step 3 above.

**Note:** The SVM feature can sometimes make the picture look artificial. If SVM is on, and you want the video material you are watching to look more natural, try turning off the SVM feature.

### Note:

The picture quality and color temperature adjustments you make (see page 25) are automatically saved in the MEMORY picture preference mode.

When you make picture adjustments, the picture preference mode automatically changes to MEMORY.

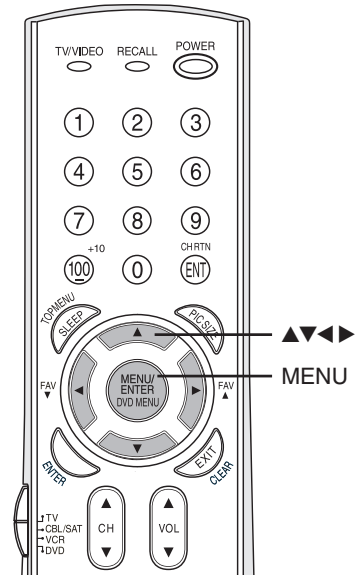

## Resetting your picture adjustments

The RESET function returns your picture adjustments to their factory settings, as described below.

Contrast ..... max (100)  
Brightness ..... center (50)  
Sharpness ..... center (50)  
Color ..... center (50)  
Tint ..... center (0)  
Color temperature ..... Cool  
SVM ..... ON  
Picture preference mode .... Sports

**Note:** The RESET function also returns your audio adjustments to their factory settings. See "Resetting your audio adjustments" on page 38.

### To reset your picture (and audio) adjustments:

1. Press MENU, and then press ◀ or ▶ until the PICTURE menu appears.
2. Press ▲ or ▼ to highlight RESET, and then press ▶.  
The screen displays the word "RESET."

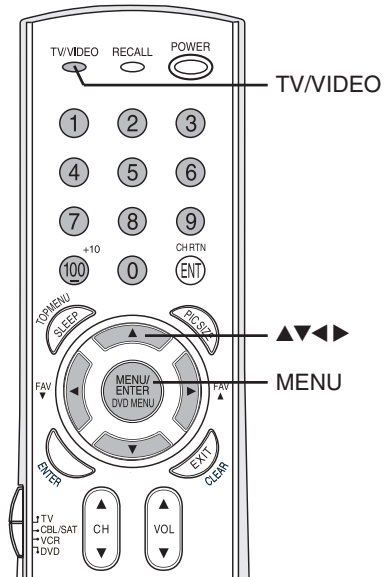
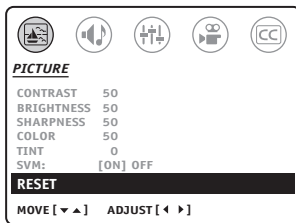

## Using the closed caption feature

The closed caption feature has two options:

- Captions—An on-screen display of the dialogue, narration, and sound effects of programs and videos that are closed-captioned (usually identified as “CC” in program guides).
- Text—An on-screen display of information not related to the program, such as weather or stock data (when provided by individual stations).

### To use the closed caption feature:

1. Tune the TV to the desired program or video.
2. Press MENU, and then press ◀ or ▶ until the CLOSED CAPTION menu appears.
3. Press ▼ or ▲ to highlight CC.

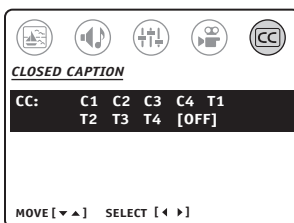

4. Press ◀ or ▶ to highlight the closed caption mode you prefer, as described below.

#### • To view captions:

Highlight C1, C2, C3, or C4. (C1 displays the primary language in your area.)

**Note:** If the program or video you selected is not closed-captioned, no captions will display on-screen.



#### • To view text:

Highlight T1, T2, T3, or T4.

**Note:** If text is not available, a black rectangle may appear on-screen. If this happens, turn off the closed caption feature.

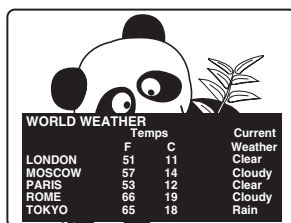

#### • To turn off the closed caption feature:

Highlight OFF.

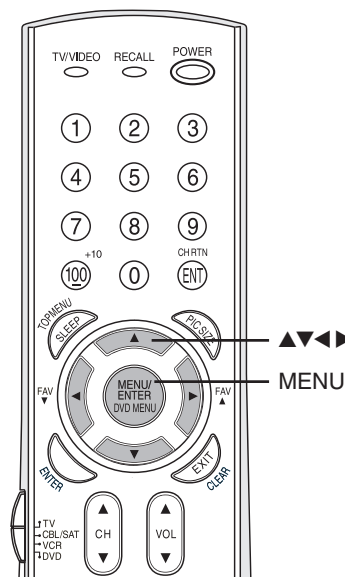

### Note:

A closed caption signal may not display correctly in the following situations:

- When a videotape has been dubbed
- When the signal reception is weak
- When the signal reception is nonstandard

## Using the V-CHIP (parental control) feature

The V-CHIP CONTROL menu includes the ENABLE BLOCKING, SET RATING, SET BLOCKING OPTIONS, NEW PIN CODE, BLOCK CHANNEL, VIDEO LOCK, and GAME TIMER functions. You can use these functions after entering the correct PIN code.

### Entering the PIN code

1. Press MENU, and then press ◀ or ▶ until the SET UP menu appears.
2. Press ▲ or ▼ to highlight V-CHIP CONTROL, and then press ▶.

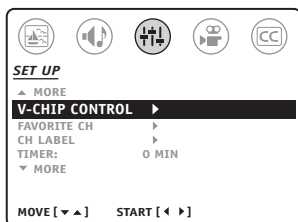

The PIN code entering screen (BLOCKING RESET or BLOCKING ACTIVE) appears, as follows:

- **BLOCKING RESET** status:

Press the Channel Number buttons (0–9) to store a new 4-digit PIN code.

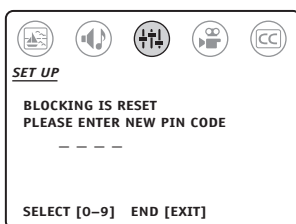

- **BLOCKING ACTIVE** status (when the PIN code is already stored):

Press the Channel Number buttons (0–9) to enter the 4-digit PIN code you previously stored.

If the wrong PIN code is entered, the message “Incorrect” will appear. Enter the code again.

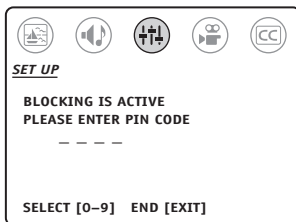

3. When the PIN code is entered, the V-CHIP CONTROL menu (illustrated below) opens.

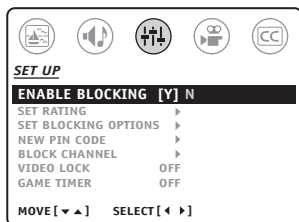

Continue to set each V-CHIP CONTROL item as described on pages 30–35.

### Note:

The V-Chip feature is only available for the U.S. V-Chip system. The Canadian V-Chip system (“Puce-V”) is not supported.

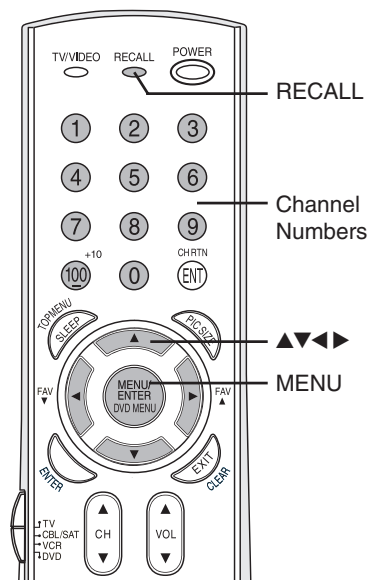

### If you forget your PIN code:

While the PIN code entering screen is displayed, press RECALL four times within 5 seconds. The PIN code you stored will be released (returned to BLOCKING RESET status).

## Using the SET RATING feature (V-Chip control)

Some TV programs and movies include signals that classify the content of the program (dialog, language, sex, violence). The SET RATING feature in the V-CHIP CONTROL menu detects these signals and blocks programs according to your rating selections. This feature includes blocking for MPAA, YOUTH TV, and TV ratings, as described below and on the next page.

**Note:**

The V-Chip function is only available for the U.S. V-Chip system. The Canadian V-Chip system (Puce-V) is not supported.

### MPAA rating blocking

(Independent rating system for movies)

To enable MPAA rating blocking and select the level of blocking:

1. Press MENU, and then press ◀ or ▶ until the SET UP menu appears.
2. Press ▲ or ▼ to highlight V-CHIP CONTROL, and then press ▶. The PIN code entering screen opens.
3. Press the Channel Numbers (0–9) to enter your 4-digit PIN code (see page 29). The V-CHIP CONTROL menu opens.
4. Press ▲ or ▼ to highlight ENABLE BLOCKING.
5. Press ◀ or ▶ to select “Y” to enable blocking.  
*Note: The ENABLE BLOCKING setting does not affect the BLOCK CHANNEL feature.*
6. Press ▲ or ▼ to highlight SET RATING, and then press ▶ to open the SET RATING menu.
7. Press ▲ or ▼ to highlight MPAA RATING.
8. Press ▶ to block (“X”) or ◀ to unblock (“✓”).

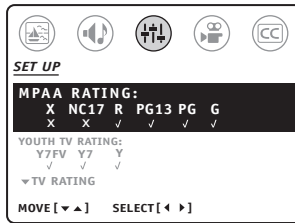
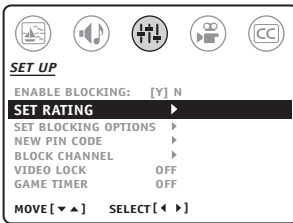
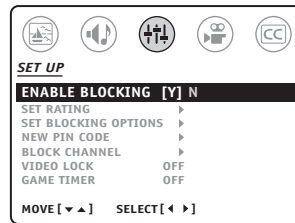
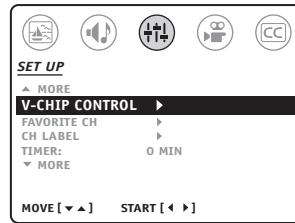

MPAA (movie) ratings that can be blocked	
X	X-rated (For adults only)
NC17	Not intended for anyone 17 and under
R	Restricted (Under 17 requires accompanying parent or adult guardian.)
PG13	Parents Strongly Cautioned (Some material may be inappropriate for children under 13)
PG	Parental Guidance Suggested (Some material may not be suitable for children)
G	General Audience (Appropriate for all ages)

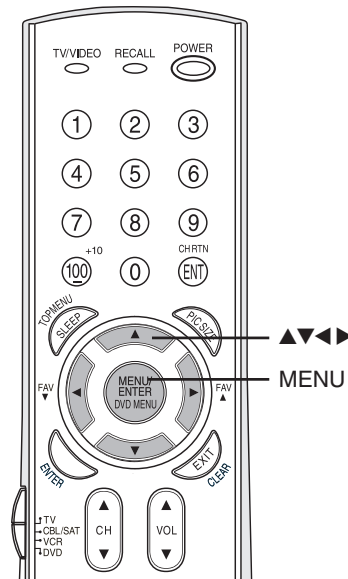

### To disable (unblock) MPAA rating blocking:

Follow steps 1–5 above, but select “N” in step 5 to disable blocking.

*Note: This also will unblock TV and YOUTH TV rating blocking (see next page).*

## TV and YOUTH TV rating blocking (Independent rating system for broadcasters)

### To enable TV (and YOUTH TV) rating blocking and select the level of blocking:

1. Press MENU, and then press ◀ or ▶ until the SET UP menu appears.
2. Press ▲ or ▼ to highlight V-CHIP CONTROL, and then press ▶. The PIN code entering screen opens.
3. Press the Channel Numbers (0–9) to enter your 4-digit PIN code (see page 29). The V-CHIP CONTROL menu opens.
4. Press ▲ or ▼ to highlight ENABLE BLOCKING.

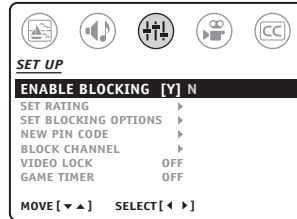
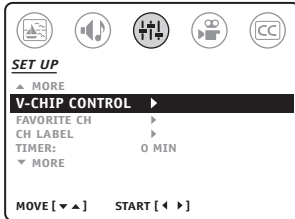

5. Press ◀ or ▶ to select “Y” to enable blocking.  
**Note:** The ENABLE BLOCKING setting does not affect the BLOCK CHANNEL feature.
6. Press ▲ or ▼ to highlight SET RATING, and then press ▶ to open the SET RATING menu.

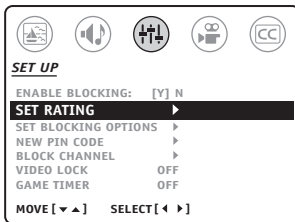

7. Press ▲ or ▼ to highlight TV RATING (or YOUTH TV RATING), and then press ▶ to display the TV RATING menu.
8. Press ▼ or ▲ to select an item (for example, DIALOG, as illustrated below).

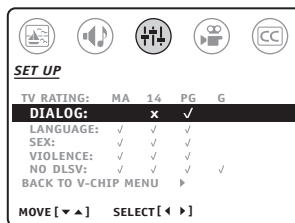

9. Press ▶ to block (“X”) or ◀ to unblock (“✓”).
10. Repeat steps 8 and 9 to set the next item.

### To disable (unblock) TV and YOUTH TV rating blocking:

Follow steps 1–5 above, but select “N” in step 5 to disable blocking.

**Note:** This also will unblock MPA rating blocking (see previous page).

TV and YOUTH TV ratings that can be blocked	
MA	Mature Audience Only (This program is designed to be viewed by adults only and may be unsuitable for children under 17.) <b>L) Crude or indecent language</b> <b>S) Explicit sexual activity</b> <b>V) Graphic violence</b>
14	Parents Strongly Cautioned (This program contains some material many parents would find unsuitable for children under 14 years of age.) <b>D) Intensely suggestive dialog</b> <b>L) Strong, coarse language</b> <b>S) Intense sexual situations</b> <b>V) Intense violence</b>
PG	Parental Guidance Suggested (This program contains material parents may find unsuitable for younger children.) <b>D) Some suggestive dialog</b> <b>L) Infrequent coarse language</b> <b>S) Some sexual situations</b> <b>V) Moderate violence</b>
G	General Audience (Most parents would find this program suitable for all ages.)
Y7, Y7FV	Directed to Older Children (This program is designed for children age 7 and above. Note: Programs in which fantasy violence may be more intense or more combative than other programs in this category are rated Y7FV.)
Y	All Children (This program is designed to be appropriate for all children)

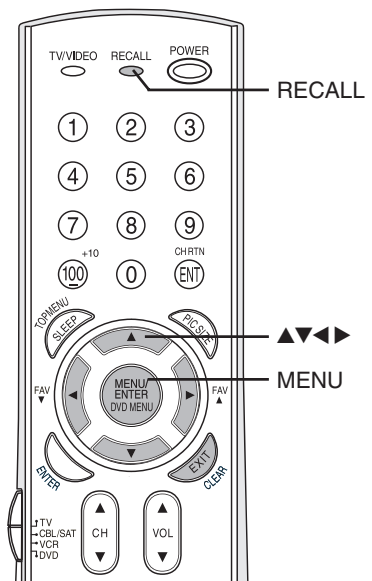

Press RECALL to display the rating of the TV program you are currently watching.

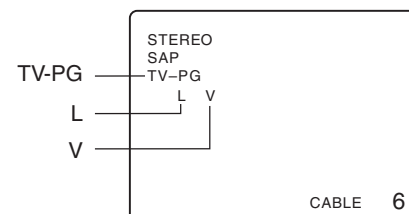

## Using the SET BLOCKING OPTIONS feature (V-Chip control)

The SET BLOCKING OPTIONS feature in the V-CHIP CONTROL menu allows blocking of unrated movies ("MPAA UNRATED") and unrated TV shows ("TV NONE RATING").

### To use the SET BLOCKING OPTIONS feature:

1. Press MENU, and then press ◀ or ▶ until the SET UP menu appears.
2. Press ▲ or ▼ to highlight V-CHIP CONTROL, and then press ▶. The PIN code entering screen opens.
3. Press the Channel Numbers (0–9) to enter your 4-digit PIN code (see page 29). The V-CHIP CONTROL menu opens.
4. Press ▲ or ▼ to highlight SET BLOCKING OPTIONS, and then press ▶ to open the SET BLOCKING OPTIONS menu.
5. Press ▲ or ▼ to highlight an item, as described below.

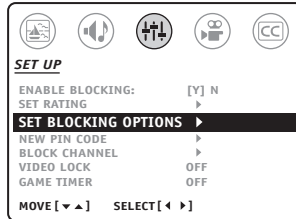

### BLOCK MPAA UNRATED:

After highlighting "BLOCK MPAA UNRATED," press ◀ or ▶ to select "Y" to block (or "N" to unblock) programs listed as not rated in the MPAA rating system.

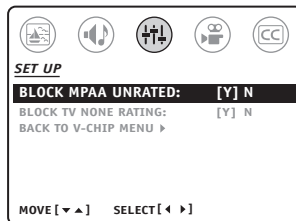

### BLOCK TV NONE RATING:

After highlighting "BLOCK TV NONE RATING," press ◀ or ▶ to select "Y" to block (or "N" to unblock) programs listed as not rated in the Parental Guidelines rating system.

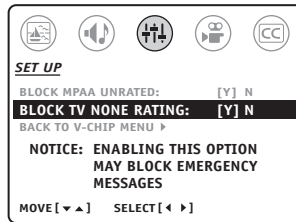

### BACK TO V-CHIP MENU:

After highlighting "BACK TO V-CHIP MENU," press ▶ to return to the V-CHIP CONTROL menu.

## Unblocking programs temporarily

1. If you try to watch a TV program that exceeds the rating limits you set, the TV will enter the block mode.
2. To temporarily unblock the program (and all other blocked programs), press MUTE.
3. Press the Channel Numbers (0–9) to enter your 4-digit PIN code.

If the wrong PIN code is entered, the message "Incorrect PIN code" appears. Enter the code again.

If the correct code is entered, blocking will be disabled (unblocked) and the normal picture will appear.

**All blocking is disabled (unblocked) until the TV is turned off, and will be enabled (blocked) when the TV is turned on again.**

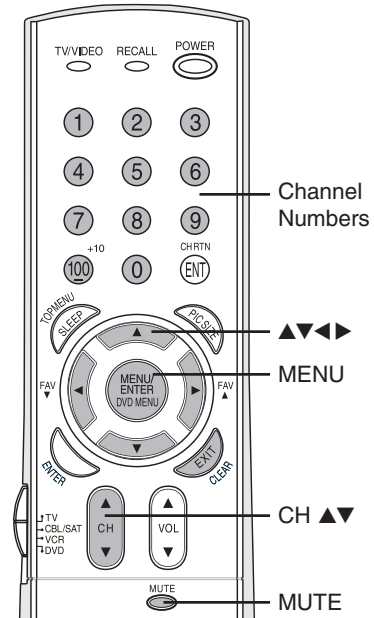

### Caution:

Setting the BLOCK TV NONE RATING to "Y" (blocked) may block reception of emergency broadcasts. The menu will display the note "Enabling this option may block emergency messages" to warn you of this possibility.

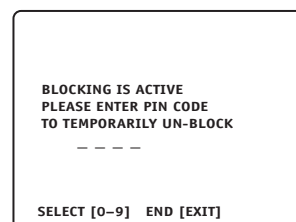
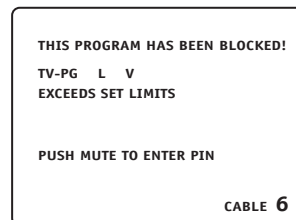



## Using the BLOCK CHANNEL feature (V-Chip control)

With the BLOCK CHANNEL feature, you can block specific channels. You will not be able to tune blocked channels until you clear the setting.

You can block a maximum of four channels.

If you try to tune a blocked channel, the nearest unblocked channel will appear.

**Note:** The BLOCK CHANNEL feature is not affected by the ENABLE BLOCKING setting (as described under "MPAA rating blocking" on page 30).

### To block a channel:

1. Tune the TV to the channel you want to block.
2. Press MENU, and then press ◀ or ▶ until the SET UP menu appears.
3. Press ▲ or ▼ to highlight V-CHIP CONTROL, and then press ▶. The PIN code entering screen opens.

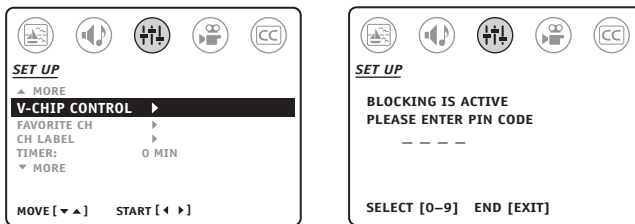

4. Press the Channel Numbers (0–9) to enter your 4-digit PIN code (see page 29). The V-CHIP CONTROL menu opens.
5. Press ▲ or ▼ to highlight BLOCK CHANNEL, and then press ▶ to open the BLOCK CHANNEL menu.
6. Press ◀ or ▶ to highlight SET, and then press ▼. The blocked channel number appears in the list.

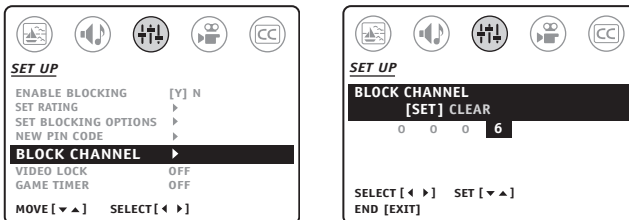

7. Press EXIT.
8. Repeat steps 1–7 for other channels you want to block.

### To unblock a channel:

Follow steps 1–8 above, but select CLEAR in step 6.

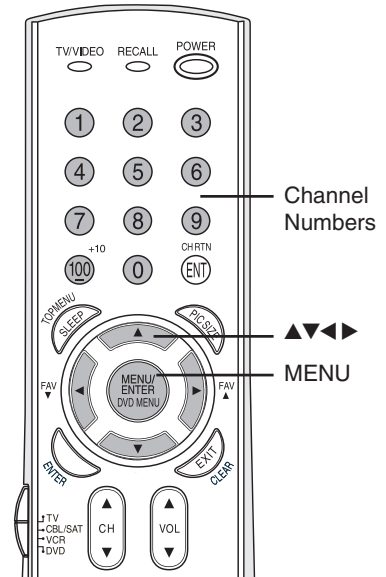
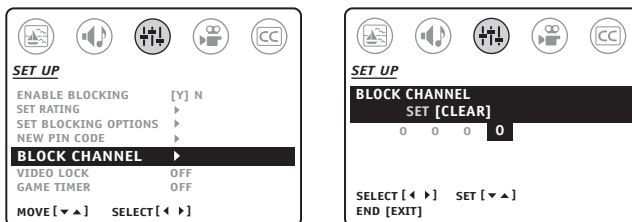

## Using the VIDEO LOCK feature (V-Chip control)

You can use the VIDEO LOCK feature to block the external video input sources (VIDEO 1, VIDEO 2, VIDEO 3, ColorStream) and channels 3 and 4.

You will not be able to view the external video input sources using the TV/VIDEO button or Channel Numbers unless the VIDEO LOCK feature is set to OFF.

**Note:** The VIDEO LOCK feature is not affected by the ENABLE BLOCKING setting (as described under "MPAA rating blocking" on page 30).

### To use the VIDEO LOCK feature:

1. Press MENU, and then press ◀ or ▶ until the SET UP menu appears.
2. Press ▲ or ▼ to highlight V-CHIP CONTROL, and then press ▶. The PIN code entering screen opens.

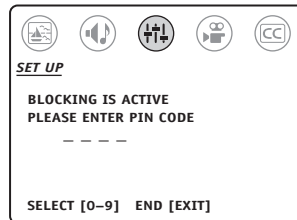
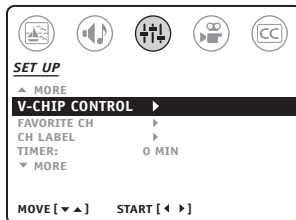

3. Press the Channel Numbers (0–9) to enter your 4-digit PIN code (see page 29). The V-CHIP CONTROL menu opens.
4. Press ▲ or ▼ to highlight VIDEO LOCK.

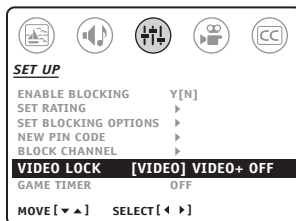

5. Press ◀ or ▶ to highlight the level of video blocking you want, as described below.
  - VIDEO : Blocks VIDEO 1, VIDEO 2, VIDEO 3, and ColorStream.
  - VIDEO+ : Blocks VIDEO 1, VIDEO 2, VIDEO 3, ColorStream, and channels 3 and 4. This option should be used if you use the antenna terminal to play videotapes.
  - OFF : Unblocks all video input sources.

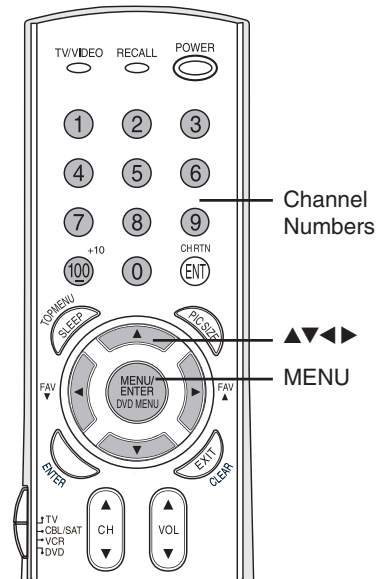

## Using the GAME TIMER feature (V-Chip control)

You can use the GAME TIMER feature to automatically activate the VIDEO LOCK feature, to set a time limit for playing a video game (30, 60, 90, or 120 minutes).

### To set the game timer:

1. Press MENU, and then press ◀ or ▶ until the SET UP menu appears.
2. Press ▲ or ▼ to highlight V-CHIP CONTROL, and then press ▶. The PIN code entering screen opens.
3. Use the Channel Number keys to enter your PIN code. The V-CHIP CONTROL menu opens.
4. Press ▲ or ▼ to highlight GAME TIMER.
5. Press ◀ or ▶ to select the amount of time until the game timer is activated (VIDEO LOCK)—30, 60, 90, or 120 minutes.

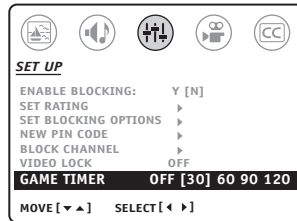
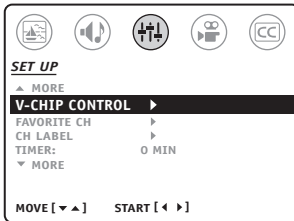

After the game timer is set, the screen will display the amount of time left on the game timer.

### To turn off the game timer:

Highlight OFF in step 5 above.

## Using the NEW PIN CODE feature (V-Chip control)

Use this feature to create a new PIN code.

1. Press MENU, and then press ◀ or ▶ until the SET UP menu appears.
2. Press ▲ or ▼ to highlight V-CHIP CONTROL, and then press ▶. The PIN code entering screen opens.

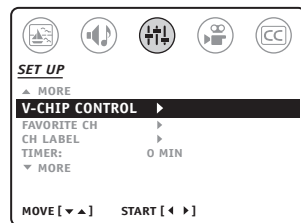

3. Use the Channel Number keys to enter your PIN code. The V-CHIP CONTROL menu opens.
4. Press ▲ or ▼ to highlight NEW PIN CODE.
5. Press the Channel Numbers (0–9) to enter a new 4-digit code. The new PIN code is now active.

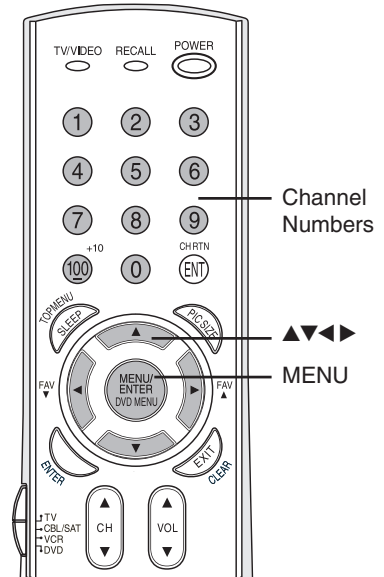
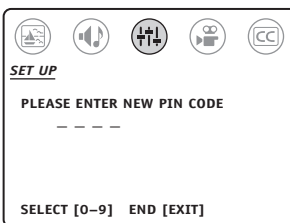
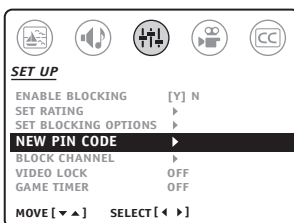

### Note:

To watch a VIDEO source after the game timer has activated the video lock, you will need to set the VIDEO LOCK feature to OFF (see page 34).

### Note:

You need to know your current PIN code to use the NEW PIN CODE feature. If you do not remember your current PIN code, press RECALL four times within 5 seconds while the PIN code entering screen is displayed. This clears the existing PIN code and enables you to select a new PIN code.

## Adjusting the sound

### Muting the sound

Press MUTE to temporarily turn off the sound. While the sound is off, the screen will briefly display the word MUTE in the lower right corner. To restore the sound, press MUTE again.

When you press MUTE, the CLOSED CAPTION feature is automatically activated. To deactivate this feature, press MUTE again. This feature works only when the Closed Caption mode is set to OFF. See “Using the closed caption feature” on page 28 for details.

### Using the MTS feature to select stereo/SAP broadcasts

The MTS (multi-channel TV sound) feature provides high-fidelity stereo sound. The MTS feature also can transmit a second audio program (SAP) containing a second language, music, or other audio information (when provided by individual stations).

When the TV receives a stereo or SAP broadcast, the word “STEREO” or “SAP” appears on-screen every time the TV is turned on, the channel is changed, or RECALL is pressed.

**Note:** The MTS feature is not available when the TV is in VIDEO mode.

#### To listen to stereo sound:

1. Press MENU, and then press ◀ or ▶ until the AUDIO menu appears.
2. Press ▲ or ▼ to highlight MTS.
3. Press ◀ or ▶ to highlight STR.

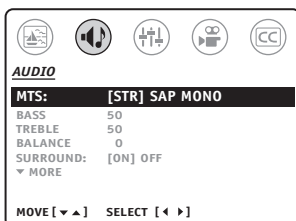

You can leave your TV in STR mode because it automatically outputs the type of sound being broadcast (stereo or monaural). If the stereo sound is noisy, select MONO to reduce the noise. The word “STR” or “SAP” displays in yellow in the menu when the TV receives the signal.

#### To listen to SAP (if available):

1. Press MENU, and then press ◀ or ▶ until the AUDIO menu appears.
2. Press ▲ or ▼ to highlight MTS.
3. Press ◀ or ▶ to highlight SAP. You will hear the station’s second audio program (if available) from the speakers while viewing the original program’s picture. **See note at right.**

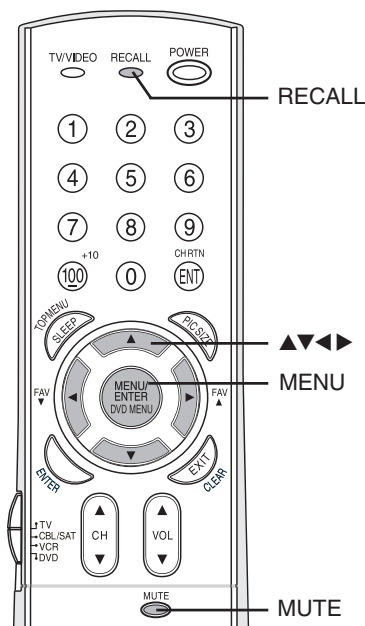

#### Note:

- A second audio program (SAP) can be heard only on those TV stations that offer it. For example, a TV station might broadcast music (or another language) as a second audio program. If you have SAP on, you will see the current program on the screen but hear music (or the other language) instead of the program’s normal audio.
- If you have SAP on and the station you are watching is not broadcasting a second audio program, the station’s normal audio will be output; however, occasionally there is no sound at all in this instance. If this happens, set the MTS feature to STR mode.

## Using the SURROUND sound feature

The SURROUND sound feature expands the audio listening field wider and deeper to create exceptional sound quality from the TV's speakers. This feature uses stereo signals from a TV broadcast or video input.

### To turn on the SURROUND sound feature:

1. Press MENU, and then press ◀ or ▶ until the AUDIO menu appears.
2. Press ▲ or ▼ to highlight MTS.
3. Press ▶ to highlight STR.
4. Press ▼ to highlight SURROUND.
5. Press ◀ or ▶ to highlight ON.

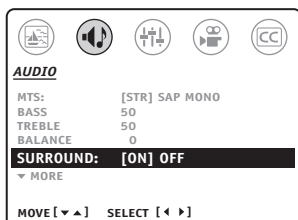

### To turn off the surround sound feature:

Highlight OFF in step 5 above.

## Adjusting the sound quality

You can change the quality of your TV's sound by adjusting the bass, treble, and balance.

### To adjust the sound quality:

1. Press MENU, then press ◀ or ▶ until the AUDIO menu appears.
2. Press ▲ or ▼ to highlight the sound quality you want to adjust.

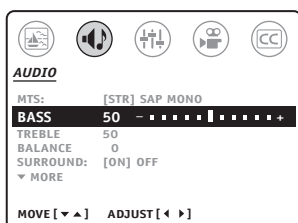

3. Press ◀ or ▶ to adjust the level:
  - ◀ makes the sound quality weaker or decreases the balance in the right channel, depending on the item selected.
  - ▶ makes the sound quality stronger or decreases the balance in the left channel, depending on the item selected.

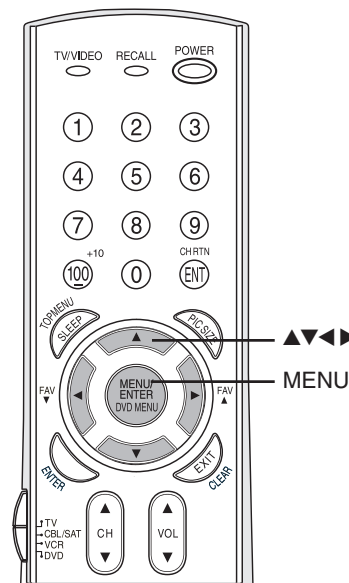

## Resetting your audio adjustments

The RESET function (in the PICTURE menu) returns your audio adjustments to the following factory settings:

- Bass ..... center (50)
- Treble ..... center (50)
- Balance ..... center (0)

### To reset your audio (and picture) adjustments:

1. Press MENU, and then press ◀ or ▶ until the PICTURE menu appears.
2. Press ▲ or ▼ to highlight RESET, and then press ▶.  
The screen displays the word "RESET."

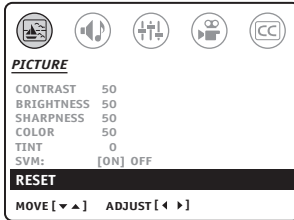

**Note:** The RESET function also returns your picture adjustments to their factory settings. See "Resetting your picture adjustments" on page 27.

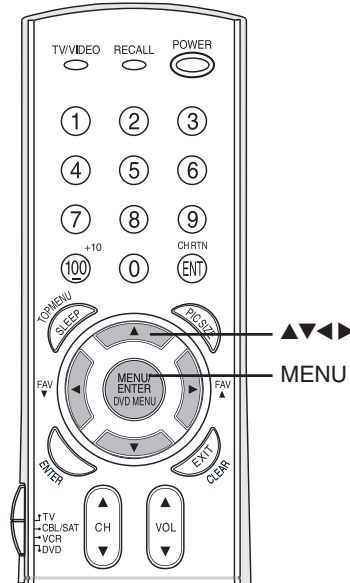

## Using the SBS (sub bass system) feature

The sub-bass system enhances bass performance, even when the volume is low.

### To turn on the SBS feature and adjust the SBS level:

1. Press MENU, and then press ◀ or ▶ until the AUDIO menu appears.
2. Press ▲ or ▼ to highlight SBS.
3. Press ◀ or ▶ to highlight ON.
4. Press ▲ or ▼ to highlight SBS LEVEL.
5. Press ▶ to increase the SBS level.  
Press ◀ to decrease the SBS level.

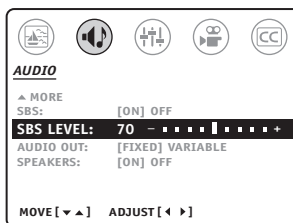
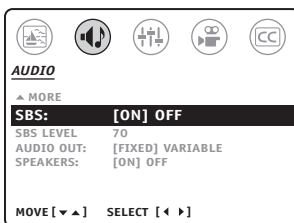

**Note:**

- Adjusting the SBS level will not affect the VARIABLE AUDIO output (page 39).
- If the SBS level is adjusted when the SBS feature is OFF, the SBS feature is automatically turned ON.

### To turn off the SBS feature:

Highlight OFF in step 3 above.

## Turning off the built-in speakers

Use this feature to turn off the TV speakers when you connect external speakers to your TV. (See “Connecting an audio system” on page 12.)

### To turn off the built-in speakers:

1. Press MENU, and then press ◀ or ▶ until the AUDIO menu appears.
2. Press ▲ or ▼ to highlight SPEAKERS.
3. Press ◀ or ▶ to highlight OFF.

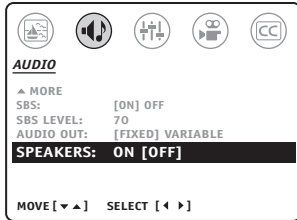

### To turn on the built-in speakers:

Highlight ON in step 3 above.

## Selecting fixed/variable AUDIO OUT

If you connect external audio equipment (such as a stereo audio amplifier or surround sound system) to the TV's AUDIO OUT terminal, you can use the AUDIO OUT feature to select either fixed or variable audio output.

- If you set AUDIO OUT to FIXED, you must use the volume controls on the audio equipment to adjust the sound level coming through the audio equipment (the TV's volume setting will have no effect).
- If you set AUDIO OUT to VARIABLE, you can use the volume controls on either the TV or the audio equipment to adjust the sound level coming through the audio equipment.

#### Note:

- Fixed audio output provides a cleaner signal than variable audio output.
- For details on connecting an audio amplifier to the TV's AUDIO OUT terminals, see “Connecting an audio system” on page 12.

### To select the AUDIO OUT sound:

1. Press MENU, then press ◀ or ▶ until the AUDIO menu appears.
2. Press ▲ or ▼ to highlight AUDIO OUT.
3. Press ◀ or ▶ to highlight FIXED or VARIABLE.

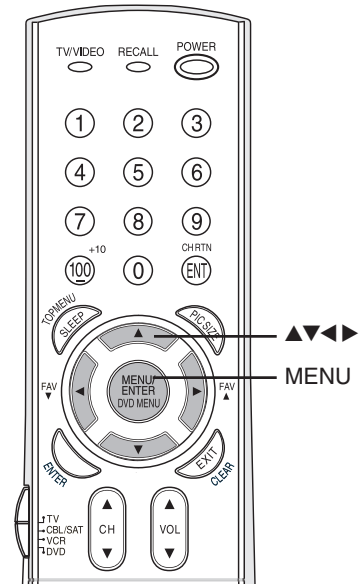
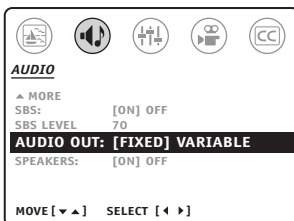

## Displaying on-screen information

Press **RECALL** to display the following information on-screen:

- Channel number or VIDEO mode selected
- Channel label (if set)
- Stereo or SAP (second audio program) audio status
- V-CHIP rating status

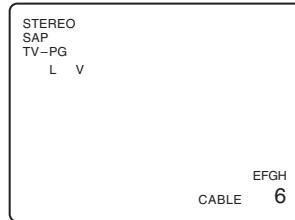

## Setting the sleep timer

**To set the sleep timer to automatically turn off the TV:**

1. Press **SLEEP** to display the SET UP menu. **TIMER** will be highlighted.
2. Press **▶** to increase (or **◀** to decrease) the amount of time until the TV turns off automatically, in 10-minute increments to a maximum of 180.
3. Press **EXIT**.

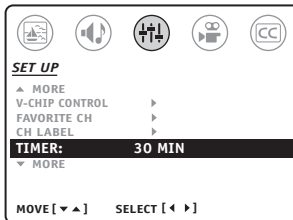

**To cancel the sleep timer:**

Set the sleep timer to 0 in step 2 above, or turn off the TV.

## Viewing the DEMO mode

When you press **DEMO** on the TV, the TV will automatically demonstrate several features of your TV.

**To view the DEMO mode:**

Press **DEMO**. *Also see note at right.*

**To stop the DEMO mode:**

Press **DEMO** or **POWER** on the TV, or press **RECALL**, **EXIT**, or **POWER** on the remote control.

## Understanding the auto power off feature

The TV will automatically turn itself off after approximately 15 minutes if it is tuned to a vacant channel or a station that completes its broadcast for the day. This feature does not work in VIDEO mode.

## Understanding the last mode memory feature

If the power is cut off while you are viewing the TV, the last mode memory feature automatically turns on the TV when the power is resupplied.

If the power is going to be off for a long time or you are going to be away from your TV, unplug the power cord to prevent the TV from turning on in your absence.

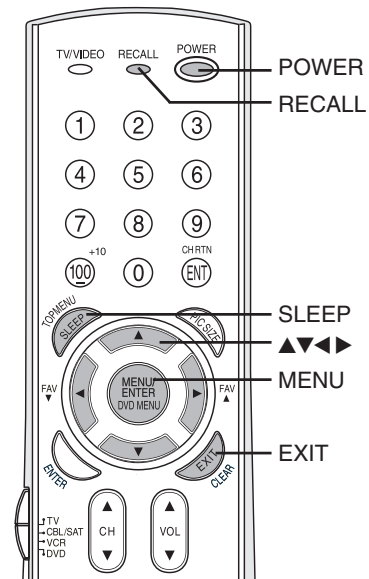

### Note :

To display the amount of time remaining until the TV turns off automatically, press **SLEEP** once. To close the display, press **EXIT**.

### Note:

You also can use the menu system to view the DEMO mode:

1. Press **MENU**.
2. Press **◀** or **▶** to highlight the **SET UP** menu.
3. Press **▲** or **▼** to highlight **DEMO**.
4. Press **◀** or **▶** to highlight **START**.

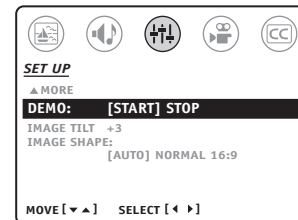



# Appendix

## Specifications

Television System	NTSC standard	
Channel Coverage	VHF: 2 through 13 UHF: 14 through 69 Cable TV: Mid band (A-8 through A-1, A through I) Super band (J through W) Hyper band (AA through ZZ, AAA, BBB) Ultra band (65 through 94, 100 through 125)	
Power Source	120 V AC, 60 Hz	
Power Consumption	32AF43: 111 W (average) 36AF43: 111 W (average)	
Audio Power	5 W + 5 W	
Speaker Type	Two 2-3/8 × 4-3/4 inches (60 × 120 mm)	
Video/Audio Terminals	S-VIDEO INPUT Y: 1 V(p-p), 75 ohm, negative sync. C: 0.286 V(p-p) (burst signal), 75 ohm VIDEO/AUDIO INPUT VIDEO: 1 V(p-p), 75 ohm, negative sync. AUDIO: 150 mV(rms) (30% modulation equivalent, 47 kohm) ColorStream™ (component video) INPUT Y: 1V(p-p), 75 ohm Pb: 0.7 V(p-p), 75 ohm Pr: 0.7 V(p-p), 75 ohm AUDIO: 150 mV(rms), 47 kohm VIDEO/AUDIO OUTPUT VIDEO: 1 V(p-p), 75 ohm, negative sync. AUDIO: 150 mV(rms) (30% modulation equivalent, 4.7 kohm) VARIABLE AUDIO OUTPUT 0–300 mV(rms) (30% modulation equivalent, 4.7 kohm)	
Dimensions	<u>32AF43</u> Width: 34-1/2 inches (876.3 mm) Height: 26-1/2 inches (673.1 mm) Depth: 22-5/8 inches (574.7 mm)	<u>36AF43</u> Width: 38-3/16 inches (970 mm) Height: 29-9/16 inches (750.9 mm) Depth: 24-1/4 inches (616 mm)
Weight	32AF43: 144 lbs. (65.3 kg) 36AF43: 196 lbs. (88.9 kg)	
Supplied Accessories	Remote control with 2 size “AA” alkaline batteries	
Optional TV stand	32AF43: ST3263 36AF43: ST3663	

**Design and specifications are subject to change without notice.**

## Troubleshooting

Before calling a service technician, please check the following table for a possible cause of the problem and some solutions.

Problem	Solution
TV will not turn on	<ul style="list-style-type: none"> <li>• Make sure the power cord is plugged in, and then press POWER.</li> <li>• If the TV is plugged into a surge suppressor or multiple outlet extension, make sure the suppressor/extension is plugged in and turned on.</li> <li>• The remote control batteries may be dead. Replace the batteries (p. 13).</li> </ul>
Picture problems	<ul style="list-style-type: none"> <li>• Check all connections (pgs. 7–12).</li> <li>• If using an antenna, the reception may be poor. Use a highly directional outdoor antenna.</li> <li>• The current station may have broadcast difficulties. Try another channel.</li> <li>• Press the TV/VIDEO button (on the remote control or TV front panel) to make sure the correct signal source is selected (p. 21). If no device is connected to the inputs on the TV (pgs. 7–12), no picture will display when you select that particular signal source.</li> <li>• If you have a VCR connected, press the TV/VCR button on the remote control to make sure it is set correctly (p. 17). Also, try turning off the VCR. Also, check VCR connections (pgs. 7–11).</li> <li>• Make sure the remote control device switch is set to the correct position for the signal source you are trying to view (p. 14).</li> <li>• Make sure the TV/CABLE setting (in the SET UP menu) corresponds with your signal source (TV antenna or cable) (p. 21).</li> <li>• Adjust the PICTURE menu settings (pgs. 25–27).</li> <li>• If you have two VCRs connected to your TV, do not connect the same VCR to the TV's output and input connections at the same time (p. 11).</li> <li>• If you have both a DVD player (or satellite receiver) and a VCR connected, make sure both are not connected to the <u>same</u> A/V IN terminals on the TV (p. 9).</li> <li>• Do not connect a standard video cable and an S-video cable to VIDEO-1 on the TV back (or VIDEO-3 on the TV front) at the same time (pgs. 7–12).</li> <li>• The SVM feature can sometimes make the picture look artificial. If SVM is on, and you want the video material you are watching to look more natural, try turning off the SVM feature (p. 26).</li> </ul>
<i>Cannot view external device signals or channel 3 or 4</i>	<ul style="list-style-type: none"> <li>• If you cannot view signals from an external device connected to VIDEO 1, VIDEO 2, VIDEO 3, and/or ColorStream, or from channels 3 or 4, set VIDEO LOCK to OFF (p. 34).</li> <li>• The game timer may have enabled the video lock. Set VIDEO LOCK to OFF (p. 34).</li> <li>• Make sure the remote control device switch is set to the correct position (p. 14).</li> </ul>
<i>Black box on screen</i>	<ul style="list-style-type: none"> <li>• Set the CLOSED CAPTION feature to OFF (p. 28).</li> </ul>
<i>Poor color or no color</i>	<ul style="list-style-type: none"> <li>• The station may have broadcast difficulties. Try another channel.</li> <li>• Adjust the TINT and/or COLOR in the PICTURE menu (p. 25).</li> <li>• If you change the direction of the TV while the TV is on, the picture may suffer from color shading. If so, turn off the TV and allow it to cool for about 30 minutes, and then turn on the TV again. The picture should improve.</li> <li>• When the ColorStream signal source is active, the VIDEO OUT terminal outputs a black-and-white signal only. To receive a color VIDEO OUT signal, a standard video or S-video IN jack must be used instead of the ColorStream connections (p. 21).</li> </ul>
<b><i>This TV displays 480i signals only</i></b>	<ul style="list-style-type: none"> <li>• This TV will not accept or display 480p or 720p progressive scan signals or 1080i interlaced high-definition signals. If you connect a high-definition set-top receiver, 480p progressive scan DVD player, or other similar device to the TV's ColorStream inputs, <b>you must switch the device's output to 480i interlaced mode first</b> (p. 10).</li> </ul>
Sound problems	<ul style="list-style-type: none"> <li>• Check the antenna/cable connections (pgs. 7–12).</li> <li>• The station may have broadcast difficulties. Try another channel.</li> <li>• The sound may be muted. Press VOLUME.</li> <li>• If you hear no sound, try setting the MTS feature to STR mode (p. 36).</li> <li>• If you hear audio that seems "incorrect" for the program you are watching (such as music or a foreign language), the SAP mode may be on. Set the MTS feature to STR mode (p. 36).</li> <li>• Make sure the SPEAKERS function in the AUDIO menu is set correctly (p. 39).</li> <li>• If you are not receiving a second audio program from a known SAP source, make sure the MTS feature is set to SAP mode (p. 36).</li> <li>• When using an external audio amplifier, if you set AUDIO OUT to VARIABLE, the volume of both the TV and amplifier must be set above 0 (zero) or you will not hear any sound (p. 12, 39).</li> <li>• When recording to a second VCR, set AUDIO OUT to FIXED (pgs. 11 and 39).</li> </ul>

## Troubleshooting

Problem	Solution
Remote control problems	<ul style="list-style-type: none"><li>• Make sure the remote control device switch is set to the correct position (p. 14).</li><li>• Remove all obstructions between the remote control and the TV.</li><li>• The remote control batteries may be dead. Replace the batteries (p. 13).</li><li>• Your TV remote control may not operate certain features on your external device. Refer to the owner's manuals for your other devices to determine their available features. If your TV remote control does not operate a specific feature on another device, use the remote control that came with the device (p. 13).</li></ul>
Channel tuning problems	<ul style="list-style-type: none"><li>• Make sure the remote control device switch is set to the correct position (p. 14).</li><li>• Make sure the TV/CABLE setting corresponds with the signal source (TV antenna or cable) (p. 21).</li><li>• The channel may have been erased from the channel memory by the ADD/ERASE feature. Add the channel to the channel memory (p. 20).</li><li>• The channel may be blocked by the BLOCK CHANNEL feature. Unblock the channel (p. 33).</li></ul>
Closed caption problems	<ul style="list-style-type: none"><li>• If you select one of the caption modes (C1, C2, C3, or C4) but the program you are watching is not closed-captioned, no captions will display on-screen (p. 28).</li><li>• A closed caption signal may not display correctly in the following situations: a) when a videotape has been dubbed; b) when the signal reception is weak; or c) when the signal reception is nonstandard. If closed captions display incorrectly, set the closed caption feature to OFF (p. 28).</li></ul>
<i>Black box on screen</i>	<ul style="list-style-type: none"><li>• If you select one of the text modes (T1, T2, T3, or T4) but text is not available, a black rectangle may appear on-screen. If this happens, set the closed caption feature to OFF (p. 28).</li></ul>
V-Chip (blocking) problems	<ul style="list-style-type: none"><li>• If you forget your PIN code: While the PIN code entering screen is displayed, press RECALL four times within 5 seconds. The PIN code you stored will be reset (p. 29).</li><li>• The V-Chip feature is only available for the U.S. V-Chip system. The Canadian V-Chip system ("Puce-V") is not supported (p. 30).</li></ul>
<i>Cannot see emergency broadcasts</i>	<ul style="list-style-type: none"><li>• Setting the BLOCK TV NONE RATING to "Y" (blocked) may block reception of emergency broadcasts. The BLOCK TV NONE RATING menu will display the note "Enabling this option may block emergency messages" to warn you of this possibility (p. 32).</li></ul>

# Limited United States Warranty

## for 27" FST PURE® and All Larger Television Models

Toshiba America Consumer Products, Inc. ("TACP") and Toshiba Hawaii, Inc. ("THI") make the following limited warranties to original consumers in the United States. THESE LIMITED WARRANTIES EXTEND TO THE ORIGINAL CONSUMER PURCHASER OR ANY PERSON RECEIVING THIS TELEVISION AS A GIFT FROM THE ORIGINAL CONSUMER PURCHASER AND TO NO OTHER PURCHASER OR TRANSFEREE.

PRODUCTS PURCHASED IN THE U.S.A. AND USED IN CANADA ARE NOT COVERED BY THESE WARRANTIES.

PRODUCTS PURCHASED IN CANADA AND USED IN THE U.S.A. ARE NOT COVERED BY THESE WARRANTIES.

### Limited One (1) Year Warranty on Parts and Labor\*

TACP/THI warrant this television and its parts against defects in materials or workmanship for a period of one (1) year after the date of original retail purchase. DURING THIS PERIOD, TACP/THI WILL, AT TACP/THI'S OPTION, REPAIR OR REPLACE A DEFECTIVE PART WITH A NEW OR REFURBISHED PART WITHOUT CHARGE TO YOU FOR PARTS OR LABOR. TACP/THI Authorized Service Station personnel will come to your home when warranty service is required. Depending on the type of repair required, either the service will be performed in your home or the set will be taken to the TACP/THI Authorized Service Station for repair and returned to your home at no cost to you.

### Limited Two (2) Year Warranty on Picture Tube\*

TACP/THI further warrant the picture tube in this television against defects in materials or workmanship for a period of two (2) years after the date of original retail purchase. DURING THIS PERIOD, TACP/THI WILL, AT TACP/THI'S OPTION, REPAIR OR REPLACE A DEFECTIVE PICTURE TUBE WITH A NEW OR REFURBISHED PICTURE TUBE WITHOUT CHARGE TO YOU, EXCEPT THAT, IF A DEFECTIVE PICTURE TUBE IS REPAIRED OR REPLACED AFTER ONE (1) YEAR FROM THE DATE OF THE ORIGINAL RETAIL PURCHASE, YOU PAY LABOR CHARGES INVOLVED IN THE REPAIR OR REPLACEMENT.

### Rental Units

The warranty for rental units begins with the date of first rental or thirty (30) days from the date of shipment to the rental firm, whichever comes first.

### \*Commercial Units

Televisions sold and used for commercial purposes have a limited ninety (90) day warranty for all parts, labor, and picture tubes.

### Owner's Manual and Product Registration Card

Read this owner's manual thoroughly before operating this television. Complete and mail the enclosed product registration card within ten days after you, or the person who has given you this product as a gift, purchased this television. Returning the product registration card will enable TACP/THI to provide you with better customer service and improved product support. Failure to return the product registration card will not affect your rights under this warranty.

### Your Responsibility

THE ABOVE WARRANTIES ARE SUBJECT TO THE FOLLOWING CONDITIONS:

- (1) You must provide your bill of sale or other proof of purchase.
- (2) All warranty servicing of this television must be made by an Authorized TACP/THI Service Station.
- (3) The warranties from TACP and THI are effective only if the television is purchased and operated in the U.S.A. or Puerto Rico.

- (4) Labor service charges for set installation, setup, adjustment of customer controls, and installation or repair of antenna systems are not covered by these warranties. Reception problems caused by inadequate antenna systems are your responsibility.
- (5) Warranties extend only to defects in materials or workmanship as limited above and do not extend to any television or parts that have been lost or discarded by you or to damage to television or parts caused by misuse, accident, Acts of God (such as lightning or fluctuations in electric power), improper installation, improper maintenance, or use in violation of instructions furnished by TACP/THI; or to units that have been modified or had the serial number removed, altered, defaced, or rendered illegible.

### How to Obtain Warranty Services

If, after following all of the operating instructions in this manual and checking the "Troubleshooting" section, you find that service is needed:

- (1) To find the nearest TACP/THI Authorized Service Station:  
For televisions purchased in the United States, except Hawaii, visit TACP's web site at [www.toshiba.com/tacp](http://www.toshiba.com/tacp), or call toll free 1-800-631-3811.  
For televisions purchased in Hawaii, contact Toshiba Hawaii, Inc., 327 Kamakee Street, Honolulu, HI 96814, (808) 591-9281.
- (2) Present your bill of sale or other proof of purchase to the Authorized Service Station. Authorized TACP/THI Service Station personnel will come to your home when warranty service is required. Depending on the type of repair required, either the service will be performed in your home or the set will be taken to the Authorized Service Station for repair and returned to your home at no cost to you.

**For additional information, visit TACP's web site:  
[www.toshiba.com/tacp](http://www.toshiba.com/tacp).**

ALL WARRANTIES IMPLIED BY THE LAW OF ANY STATE OF THE U.S.A., INCLUDING THE IMPLIED WARRANTIES OF MERCHANTABILITY AND FITNESS FOR A PARTICULAR PURPOSE, ARE EXPRESSLY LIMITED TO THE DURATION OF THE LIMITED WARRANTIES SET FORTH ABOVE. WITH THE EXCEPTION OF ANY WARRANTIES IMPLIED BY THE LAW OF ANY STATE OF THE U.S.A. AS HEREBY LIMITED, THE FOREGOING WARRANTY IS EXCLUSIVE AND IN LIEU OF ALL OTHER WARRANTIES, GUARANTEES, AGREEMENTS, AND SIMILAR OBLIGATIONS OF TACP OR THI WITH RESPECT TO THE REPAIR OR REPLACEMENT OF ANY PARTS. IN NO EVENT SHALL TACP OR THI BE LIABLE FOR CONSEQUENTIAL OR INCIDENTAL DAMAGES.

No person, agent, distributor, dealer, or company is authorized to change, modify, or extend the terms of these warranties in any manner whatsoever. The time within which action must be commenced to enforce any obligation of TACP or THI arising under this warranty or under any law of the United States or of any state thereof is hereby limited to 90 days from the date you discover, or should have discovered, the defect. This limitation does not apply to implied warranties arising under the law of any state of the U.S.A.

THIS WARRANTY GIVES YOU SPECIFIC LEGAL RIGHTS, AND YOU MAY ALSO HAVE OTHER RIGHTS, WHICH MAY VARY FROM STATE TO STATE IN THE U.S.A. SOME STATES OF THE U.S.A. DO NOT ALLOW LIMITATIONS ON THE DURATION OF AN IMPLIED WARRANTY, LIMITATIONS ON THE TIME WITHIN WHICH AN ACTION MAY BE BROUGHT, OR THE EXCLUSION OR LIMITATION OF INCIDENTAL OR CONSEQUENTIAL DAMAGES; THEREFORE, THE ABOVE LIMITATIONS OR EXCLUSIONS MAY NOT APPLY TO YOU UNDER SUCH CIRCUMSTANCES.

FST PURE® is a registered trademark of Toshiba America Consumer Products, Inc.  
REV. MAR02

# Limited Canada Warranty

## for 27" FST PURE® and All Larger Television Models

Toshiba of Canada Limited ("TCL") makes the following limited warranties to original consumers in Canada.

THESE LIMITED WARRANTIES EXTEND TO THE ORIGINAL CONSUMER PURCHASER OR ANY PERSON RECEIVING THIS TELEVISION AS A GIFT FROM THE ORIGINAL CONSUMER PURCHASER AND TO NO OTHER PURCHASER OR TRANSFEREE.

PRODUCTS PURCHASED IN THE U.S.A. AND USED IN CANADA ARE NOT COVERED BY THESE WARRANTIES.

PRODUCTS PURCHASED IN CANADA AND USED IN THE U.S.A. ARE NOT COVERED BY THESE WARRANTIES.

### Limited One (1) Year Warranty on Parts and Labor\*

TCL warrants this television and its parts against defects in materials or workmanship for a period of one (1) year after the date of original retail purchase. DURING THIS PERIOD, TCL WILL, AT TCL'S OPTION, REPAIR OR REPLACE A DEFECTIVE PART WITH A NEW OR REFURBISHED PART WITHOUT CHARGE TO YOU FOR PARTS OR LABOR. TCL Authorized Service Depot personnel will come to your home when warranty service is required.

Depending on the type of repair required, either the service will be performed in your home or the set will be taken to the TCL Authorized Service Depot for repair and returned to your home at no cost to you. IN-HOME SERVICE ONLY APPLIES WITHIN 100 KILOMETERS OF AN AUTHORIZED TCL SERVICE DEPOT.

### Limited Two (2) Year Warranty on Picture Tube\*

TCL further warrants the picture tube in this television against defects in materials or workmanship for a period of two (2) years after the date of original retail purchase. DURING THIS PERIOD, TCL WILL, AT TCL'S OPTION, REPAIR OR REPLACE A DEFECTIVE PICTURE TUBE WITH A NEW OR REFURBISHED PICTURE TUBE WITHOUT CHARGE TO YOU, EXCEPT THAT, IF A DEFECTIVE PICTURE TUBE IS REPAIRED OR REPLACED AFTER ONE (1) YEAR FROM THE DATE OF THE ORIGINAL RETAIL PURCHASE, YOU PAY LABOR CHARGES INVOLVED IN THE REPAIR OR REPLACEMENT.

### Rental Units

The warranty for rental units begins with the date of first rental or thirty (30) days from the date of shipment to the rental firm, whichever comes first.

### \*Commercial Units

Televisions sold and used for commercial purposes have a limited ninety (90) day warranty for all parts, labor, and picture tubes.

### Owner's Manual

Read this owner's manual thoroughly before operating this television.

### Your Responsibility

THE ABOVE WARRANTIES ARE SUBJECT TO THE FOLLOWING CONDITIONS:

- (1) You must provide your bill of sale or other proof of purchase.
- (2) All warranty servicing of this television must be made by an Authorized TCL Service Depot.
- (3) The warranties from TCL are effective only if the television is purchased in Canada from an authorized TCL dealer and operated in Canada.

- (4) Labor service charges for set installation, setup, adjustment of customer controls, and installation or repair of antenna systems are not covered by these warranties. Reception problems caused by inadequate antenna systems are your responsibility.
- (5) Warranties extend only to defects in materials or workmanship as limited above and do not extend to any television or parts that have been lost or discarded by you or to damage to television or parts caused by misuse, accident, Acts of God (such as lightning or fluctuations in electric power), improper installation, improper maintenance, or use in violation of instructions furnished by TCL; or to units that have been modified or had the serial number removed, altered, defaced, or rendered illegible.

### How to Obtain Warranty Services

If, after following all of the operating instructions in this manual and checking the "Troubleshooting" section, you find that service is needed:

- (1) To find the nearest TCL Authorized Service Depot, visit TCL's web site: [www.toshiba.ca](http://www.toshiba.ca).
- (2) Present your bill of sale or other proof of purchase to the Authorized Service Depot. Authorized TCL Service Depot personnel will come to your home when warranty service is required. Depending on the type of repair required, either the service will be performed in your home or the set will be taken to the Authorized Service Depot for repair and returned to your home at no cost to you. IN-HOME SERVICE ONLY APPLIES WITHIN 100 KILOMETERS OF AN AUTHORIZED TCL SERVICE DEPOT.

**For additional information, visit TCL's web site:  
[www.toshiba.ca](http://www.toshiba.ca)**

ALL WARRANTIES IMPLIED BY THE LAW OF ANY PROVINCE OF CANADA, INCLUDING THE IMPLIED WARRANTIES OF MERCHANTABILITY AND FITNESS FOR A PARTICULAR PURPOSE, ARE EXPRESSLY LIMITED TO THE DURATION OF THE LIMITED WARRANTIES SET FORTH ABOVE. WITH THE EXCEPTION OF ANY WARRANTIES IMPLIED BY THE LAW OF ANY PROVINCE OF CANADA AS HEREBY LIMITED, THE FOREGOING WARRANTY IS EXCLUSIVE AND IN LIEU OF ALL OTHER WARRANTIES, GUARANTEES, AGREEMENTS, AND SIMILAR OBLIGATIONS OF TCL WITH RESPECT TO THE REPAIR OR REPLACEMENT OF ANY PARTS. IN NO EVENT SHALL TCL BE LIABLE FOR CONSEQUENTIAL OR INCIDENTAL DAMAGES.

No person, agent, distributor, dealer, or company is authorized to change, modify, or extend the terms of these warranties in any manner whatsoever. The time within which action must be commenced to enforce any obligation of TCL arising under this warranty or under any law of Canada or of any province thereof, is hereby limited to 90 days from the date you discover, or should have discovered, the defect. This limitation does not apply to implied warranties arising under the law of any province of Canada.

THIS WARRANTY GIVES YOU SPECIFIC LEGAL RIGHTS, AND YOU MAY ALSO HAVE OTHER RIGHTS, WHICH MAY VARY FROM PROVINCE TO PROVINCE IN CANADA. SOME PROVINCES OF CANADA DO NOT ALLOW LIMITATIONS ON THE DURATION OF AN IMPLIED WARRANTY, LIMITATIONS ON THE TIME WITHIN WHICH AN ACTION MAY BE BROUGHT, OR THE EXCLUSION OR LIMITATION OF INCIDENTAL OR CONSEQUENTIAL DAMAGES; THEREFORE, THE ABOVE LIMITATIONS OR EXCLUSIONS MAY NOT APPLY TO YOU UNDER SUCH CIRCUMSTANCES.

FST PURE® is a registered trademark of Toshiba America Consumer Products, Inc.  
REV. MAR02

# Index

## A

A/V receiver connection .....	12
Antenna cables .....	7
Audio cables .....	7
AUDIO OUT sound, selecting .....	39
Audio system connection .....	12
Auto power off .....	40

## B

BLOCK CHANNEL .....	33
Blocking (V-Chip) .....	29–35

## C

Cable box connection .....	8
Camcorder connection .....	12
Channel label .....	24
CH RTN button .....	23
Channel Number buttons .....	23
Channel programming	
ADD/ERASE .....	20
Automatic programming .....	19
TV/CABLE selection .....	21
Channel ▲▼ buttons .....	20
Closed caption .....	28
ColorStream® .....	10
Component video cables .....	7
Connection diagrams .....	7–12

## D

DEMO button .....	40
DVD connection .....	9

## F G I

FAV ▲/FAV ▼ buttons .....	23
Favorite channels .....	23
Front of the TV .....	6
Game timer .....	35
IMAGE SHAPE .....	22
IMAGE TILT .....	21

## L M

Language selection .....	19
Last mode memory .....	40
Menu system .....	18
MTS feature .....	36
MUTE button .....	36

## P

PIC SIZE button .....	14, 22
Picture adjustments	
Color temperature .....	25
Picture preference mode .....	26
Picture quality .....	25
Resetting .....	27
SVM .....	26

## R

RECALL button .....	40
Remote control	
Battery installation .....	13
Learning about the buttons .....	14, 17
Programming .....	15
Remote control codes .....	15–16
Resetting picture and audio adjustments .....	27, 38

## S

SAP sound .....	36
Satellite receiver connection .....	9
SLEEP timer .....	40
Sound quality adjustments .....	36
SPEAKERS on/off .....	39
SVM .....	26
Specifications .....	41
Stereo sound .....	36
Sub bass system (SBS) .....	38
Surround sound .....	37
S-video cables .....	7

## T

Tilt correction .....	21
Troubleshooting .....	42–43
TV/VIDEO button .....	21

## V

### V-CHIP

BLOCKING OPTION .....	32
ENABLE BLOCKING .....	32
MPAA RATING .....	32
NEW PIN CODE .....	35
PIN code, entering .....	29
TV RATING .....	32
Unblocking programs .....	32
VCR connection .....	7–11
Video cables .....	7
VIDEO LOCK .....	34

## W

Warranty .....	44, 45
----------------	--------

## **TOSHIBA AMERICA CONSUMER PRODUCTS, INC.**

HEAD OFFICE/82 TOTOWA ROAD, WAYNE, NEW JERSEY 07470  
NATIONAL SERVICE DIVISION:1420B TOSHIBA DRIVE, LEBANON, TN 37087

## **TOSHIBA HAWAII, INC.**

HEAD OFFICE/327 KAMAKEE STREET, HONOLULU, HAWAII 96814, U.S.A. TEL: (808) 591-9281

## **TOSHIBA OF CANADA LTD.**

HEAD OFFICE/191 McNABB STREET MARKHAM, ONTARIO L3R 8H2, CANADA TEL: (905) 470-5400  
SERVICE CENTERS/TORONTO: 191 McNABB STREET MARKHAM, ONTARIO L3R 8H2, CANADA TEL: (905) 470- 5400  
MONTREAL: 1643, NORTH SERVICE RD., TRANS-CANADA HIGHWAY, DORVAL QUEBEC, H9P 1J1, CANADA  
TEL: (514) 856-4100  
VANCOUVER: 22171 FRASERWOOD WAY, RICHMOND, B.C. V6W 1J5, CANADA TEL: (604) 303-2500

MANUFACTURED BY

**TOSHIBA AMERICA CONSUMER PRODUCTS, INC.**

ColorStream and StableSound are registered trademarks of Toshiba America Consumer Products, Inc.

PRINTED IN USA  
(03-03) R

# **TOSHIBA**

## Free Manuals Download Website

<http://myh66.com>

<http://usermanuals.us>

<http://www.somanuals.com>

<http://www.4manuals.cc>

<http://www.manual-lib.com>

<http://www.404manual.com>

<http://www.luxmanual.com>

<http://aubethermostatmanual.com>

Golf course search by state

<http://golfingnear.com>

Email search by domain

<http://emailbydomain.com>

Auto manuals search

<http://auto.somanuals.com>

TV manuals search

<http://tv.somanuals.com>