

TOSHIBA

TOSHIBA Operation Unit

LKBST-65-TF12 SERIES

Owner's Manual

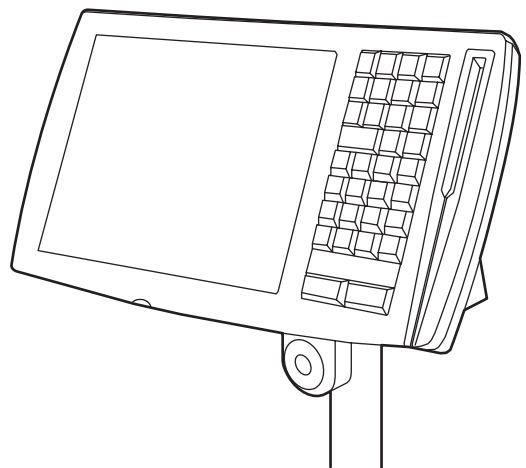

CE Compliance (for EU only)

This product complies with the requirements of EMC Directive including their amendments.

"This Class A digital apparatus meets all requirements of the Canadian Interference-Causing Equipment Regulations."

"Cet appareil numérique de la classe A respecte toutes les exigences du Règlement sur le matériel brouilleur du Canada."

FCC Notice

This equipment has been tested and found to comply with the limits for a Class A digital device, pursuant to Part 15 of the FCC Rules. These limits are designed to provide reasonable protection against harmful interference when the equipment is operated in a commercial environment. This equipment generates, uses, and can radiate radio frequency energy and, if not installed and used in accordance with the instruction manual, may cause harmful interference to radio communications. Operation of this equipment in a residential area is likely to cause harmful interference in which case the user will be required to correct the interference at his own expense.

Changes or modifications not expressly approved by manufacturer for compliance could void the user's authority to operate the equipment.

<Caution> In USA and Canada:

For use with UL Listed POS Terminals or Cash Registers.

WARNING

This is a Class A product. In a domestic environment this product may cause radio interference in which case the user may be required to take adequate measures.

ATTENTION

Ce produit est de classe A. Dans un environnement domestique, il peut causer des interférences radio. Auquel cas, l'utilisateur sera amené à prendre les mesures adéquates.

Warnung

Dies ist ein Klasse A Produkt. In einer örtlichen Umgebung kann dieses Gerät Funkstörungen verursachen.

Atención

Este es un producto de la clase A. En ambientes domésticos éste producto puede causar radio interferencias en cuyo caso el usuario deberá tomar las medidas oportunas.

VERWITTINGING

Dit is een klasse A produkt. Het gebruik hiervan kan radio interferenties veroorzaken die de gebruiker ertoe kunnen dwingen sommige maatregelen te moeten treffen.

Avviso

Questo è un apparecchio di Classe A. In un ambiente residenziale questo apparecchio può provocare radiodisturbi. In questo caso può essere richiesto all'utilizzatore di prendere misure adeguate.

CAUTION!

1. *This manual may not be copied in whole or in part without prior written permission of TOSHIBA TEC.*
2. *The contents of this manual may be changed without notification.*
3. *Please refer to your local Authorised Service representative with regard to any queries you may have in this manual.*

Safety Summary

Personal safety in handling or maintaining the equipment is extremely important. Warnings and Cautions necessary for safe handling are included in this manual. All warnings and cautions contained in this manual should be read and understood before handling or maintaining the equipment.

Do not attempt to effect repairs or modifications to this equipment. If a fault occurs that cannot be rectified using the procedures described in this manual, turn off the power, unplug the machine, then contact your authorized TOSHIBA TEC representative for assistance.

Meanings of Each Symbol



This symbol indicates warning items (including cautions). Specific warning contents are drawn inside the Δ symbol. (The symbol on the left indicates a general caution.)



This symbol indicates prohibited actions (prohibited items). Specific prohibited contents are drawn inside or near the $\text{\textcircled{X}}$ symbol. (The symbol on the left indicates “no disassembling”.)



This symbol indicates actions which must be performed. Specific instructions are drawn inside or near the \bullet symbol. (The symbol on the left indicates “disconnect the power cord plug from the outlet”.)



WARNING

This indicates that there is the risk of **death** or **serious injury** if the machines are improperly handled contrary to this indication.



Prohibited

Do not plug in or unplug the power cord plug with wet hands as this may cause **electric shock**.



Any other than the specified AC voltage is prohibited.

Do not use voltages other than the voltage (AC) specified on the rating plate, as this may cause **fire** or **electric shock**.



Prohibited

If the machines share the same outlet with any other electrical appliances that consume large amounts of power, the voltage will fluctuate widely each time these appliances operate. Be sure to provide an exclusive outlet for the machine as this may cause **fire** or **electric shock**.

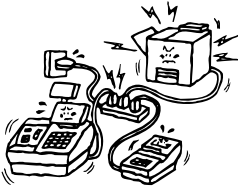

Prohibited

Do not place metal objects or water-filled containers such as flower vases, flower pots or mugs, etc. on top of the machines. If metal objects or spilled liquid enter the machines, this may cause **fire** or **electric shock**.



Prohibited

Do not insert or drop metal, flammable or other foreign objects into the machines through the ventilation slits, as this may cause **fire** or **electric shock**.



Prohibited

Do not scratch, damage or modify the power cords. Also, do not place heavy objects on, pull on, or excessively bend the cords, as this may cause **fire** or **electric shock**.



Disconnect the plug.



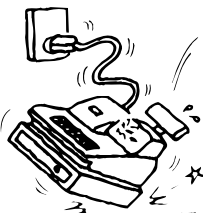



If the machines are dropped or their cabinets damaged, first turn off the power switches and disconnect the power cord plugs from the outlet, and then contact your authorized TOSHIBA TEC representative for assistance. Continued use of the machine in that condition may cause **fire** or **electric shock**.

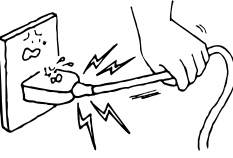

Disconnect the plug.

Continued use of the machines in an abnormal condition such as when the machines are producing smoke or strange smells may cause **fire** or **electric shock**. In these cases, immediately turn off the power switches and disconnect the power cord plugs from the outlet. Then, contact your authorized TOSHIBA TEC representative for assistance.

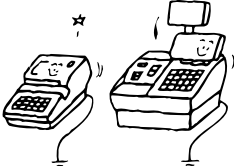

 <p>Disconnect the plug.</p> 	<p>If foreign objects (metal fragments, water, liquids) enter the machines, first turn off the power switches and disconnect the power cord plugs from the outlet, and then contact your authorized TOSHIBA TEC representative for assistance. Continued use of the machine in that condition may cause fire or electric shock.</p>	 <p>Disconnect the plug.</p> 	<p>When unplugging the power cords, be sure to hold and pull on the plug portion. Pulling on the cord portion may cut or expose the internal wires and cause fire or electric shock.</p>
 <p>Connect a grounding wire.</p> 	<p>Ensure that the equipment is properly grounded. Extension cables should also be grounded. Fire or electric shock could occur on improperly grounded equipment.</p>	 <p>No disassembling.</p> 	<p>Do not remove covers, repair or modify the machine by yourself. You may be injured by high voltage, very hot parts or sharp edges inside the machine. Unauthorized modification is prohibited.</p>



CAUTION

This indicates that there is the risk of personal **Injury** or **damage** to objects if the machines are improperly handled contrary to this indication.

Precautions

The following precautions will help to ensure that this machine will continue to function correctly.

- Try to avoid locations that have the following adverse conditions:
 - * Temperatures out of the specification
 - * Direct sunlight
 - * High humidity
 - * Shared power source
 - * Excessive vibration
 - * Dust/Gas
- Do not subject the machine to sudden shocks.
- Do not press the keys too hard. Keys will operate correctly if they are touched lightly.
- Clean the cover and keyboard, etc. by wiping with a dry cloth or a cloth soaked with detergent and wrung out thoroughly. Never use thinner or other volatile solvent for cleaning.
- At the end of the day, turn the power OFF, then clean and inspect the exterior of the machine.
- Try to avoid using this equipment on the same power supply as high voltage equipment or equipment likely to cause mains interference.
- USE ONLY TOSHIBA TEC SPECIFIED consumables.
- DO NOT STORE the consumables where they might be exposed to direct sunlight, high temperatures, high humidity, dust, or gas.
- When moving the machine, take hold of the drawer and lift the machine.
- Do not place heavy objects on top of the machines, as these items may become unbalanced and fall causing **injury**.
- Do not block the ventilation slits of the machines, as this will cause heat to build up inside the machines and may cause **fire**.
- Do not lean against the machine. It may fall on you and could cause **injury**.
- Place the machine on a stable and level surface.

Request Regarding Maintenance

- Utilize our maintenance services.
After purchasing the machine, contact your authorized TOSHIBA TEC representative for assistance once a year to have the inside of the machine cleaned. Otherwise, dust will build up inside the machines and may cause a **fire** or a **malfunction**. Cleaning is particularly effective before humid rainy seasons.
- Our preventive maintenance service performs the periodic checks and other work required to maintain the quality and performance of the machines, preventing accidents beforehand.
For details, please consult your authorized TOSHIBA TEC representative for assistance.
- Using insecticides and other chemicals
Do not expose the machines to insecticides or other volatile solvents. This will cause the cabinet or other parts to deteriorate or cause the paint to peel.

TABLE OF CONTENTS

	Page
1. INTRODUCTION -----	1- 1
1.1 Accessories -----	1- 1
2. SPECIFICATIONS -----	2- 1
2.1 Basic Specifications -----	2- 1
2.2 Options -----	2- 1
3. APPEARANCE -----	3- 1
3.1 Front View -----	3- 1
3.2 Control Lock and Mode Selector Keys-----	3- 2
4. SETUP PROCEDURE -----	4- 1
4.1 Precautions for Setup-----	4- 1
4.2 Setup Procedure -----	4- 1
5. ADJUSTMENT -----	5- 1
5.1 Tilt Angle Adjustment -----	5- 1
5.2 Brightness Adjustment-----	5- 1
5.3 Speaker Volume Adjustment-----	5- 2
5.4 Key Tone Volume Adjustment -----	5- 2
6. GENERAL MAINTENANCE -----	6- 1
6.1 Cleaning-----	6- 1
7. TROUBLESHOOTING -----	7- 1

1. INTRODUCTION

Thank you for purchasing the TOSHIBA LKBST-65 Operation Unit.

This Operation Unit is comprised of a high brightness 12.1-inch color TFT (800x600 dots, 65,536 or 260,000 colours) with Touch Panel and a keyboard.

The Operation Unit has been developed exclusive to the TOSHIBA ST-7000 series high-grade POS terminal which is designed for specialty store.





The keyboard unit has a maximum of 40 keys (including numeric keys).

This manual describes the functions and handling of this unit and should be read carefully to help gain maximum performance and life from your unit.

For most queries please refer to this manual and keep it safe for future reference.

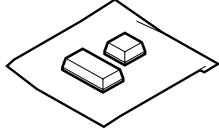
1.1 Accessories

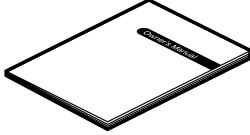
Confirm that all the following accessories are contained in the carton. If any accessories are missing or damaged, contact your nearest TOSHIBA TEC service representative.

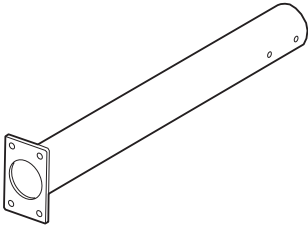
<ul style="list-style-type: none"> RS-232C Dummy (1 pc.) 	<ul style="list-style-type: none"> Key Cap Set (1 set) (1x1: 18 pcs., 1x2: 3 pcs.) 
<ul style="list-style-type: none"> Mode Selector Key Set (1 set) REG, MA, X, S keys: 2 keys each 	<ul style="list-style-type: none"> Owner's Manual (1 pc.) 
<ul style="list-style-type: none"> Double Sems Screw M4x8 (4 pcs.) 	<ul style="list-style-type: none"> Bind Screw M3x6 (2 pcs.) 
<ul style="list-style-type: none"> Pole (1 pc.) 	

2. SPECIFICATIONS

2.1 Basic Specifications

Item		Description
Display	Display Size	12.1-inch
	View Area	248.0 (W) x 186.5 (H) mm
	Active Area	246.0 (W) x 184.5 (H) mm
	Resolution	800 (W) x 600 (H) dots
	Number of Colors	64K color (65,536 colors) or 260,000 colors
	Dot Pitch	0.3075 (W) x 0.3075 (H) mm
	Display Mode	Transparency
	Driving Method	TFT
	Back light	Fluorescent lamp x 2 pcs. Side light type
Touch Panel	Panel Size	12.1-inch
	View Area	250.0 (W) x 185.5 (H) mm
	Active Area	243.8 (W) x 181.1 (H) mm
	Mode	Analog Resistor film (Grass + PET)
	Transparency Rate	80% or more
	Input Method	Finger touch or Pen (See NOTE 1.)
	Resolution	1024 (W) x 1024 (H)
Speaker	The built-in speaker of the LKBST-65 is activated when connecting the speaker signal from the control unit (ST-7000 series) via an interface cable. (See NOTE 2.)	
Keyboard	Number of keys	Max. 40 keys
	Number of Control Locks	Cylinder Lock type: 1 unit (8 positions)
	Key Tone	Key depression: 1 tone Alarm: 2 tones (Selectable by the software)
	Volume	Adjustable with the control on the bottom of the unit.
Magnetic Card Reader	ISO Track 1 & 2 (Option)	
Power Supply Voltage	DC12V \pm 10%, DC5V \pm 5%	
Current Consumption	DC12V: 0.8A, DC5V: 0.6A (including 0.1 A for expansion keyboard)	
Power Source	ST-7000 series	
Operating Temperature	5 to 35°C	
Humidity	10 to 90 % (No condensation)	
Dimensions	433 (W) x 239.2 (H) x 165.6 (D) mm (See NOTE 3.)	
Weight	Approx. 4.6 Kg	
Body Color	FW-2 (Fair White-2)	

- NOTES:**
- For pen input method, use a pen which meets the following conditions.
Material: POM (Polyester) Pen top: SR0.8mm
 - When the built-in speaker of the LKBST-65 is activated, that of the POS terminal does not work.
 - The depth (D) here indicates when the tilt angle is 80°. The height (H) doesn't include the pole length.

2.2 Options

The following option kits are available for the LKBST-65. For details, contact your nearest TOSHIBA TEC sales representative.

Option Name	Type	Description
Magnetic Card Reader	MCRST-50-3-QM-R	ISO, track 1 and 2 type Magnetic Card Reader Kit
Stand Kit	KITLKBST-56-QM-R	Used to the LKBST-65 for stand type

3. APPEARANCE

3.1 Front View

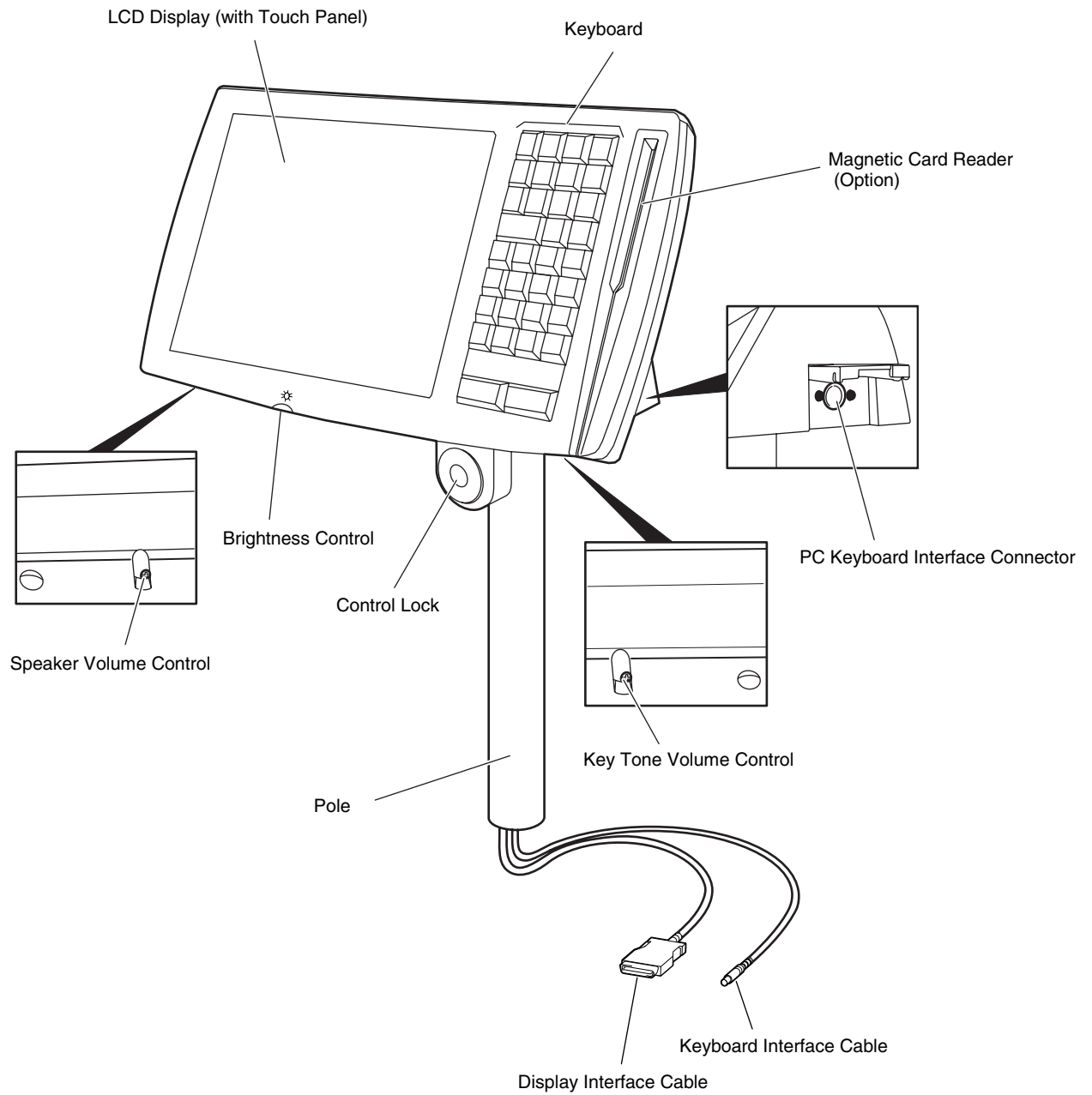

3.2 Control Lock and Mode Selector Keys

Control Lock

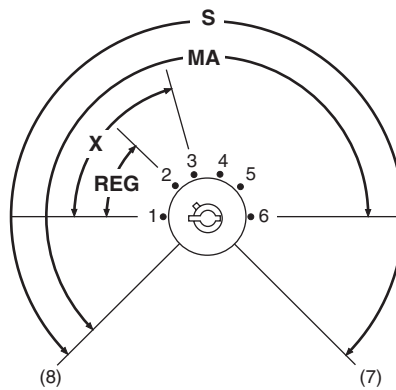

Mode Selector Keys

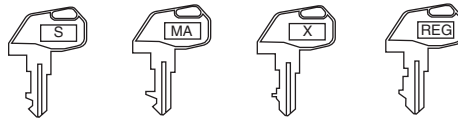

- The key can be inserted or removed at Position 1 or 2 of the Control Lock.

4. SETUP PROCEDURE

CAUTION:

The installation should be performed by an authorized installing dealer. Please contact your nearest TOSHIBA TEC representative.

NOTE: The following option kits are required for connecting the unit to the POS terminal.

ST-7000-2E/F series: KIT-7000-DSP1-QM-R

ST-7000-1C series: KIT-7000-DSP3-QM-R

4.1 Precautions for Setup

1. Avoid locations where the unit might get wet. If water or liquids enter the unit, this may cause fire, electric shock or damage to the unit.
2. NEVER connect the unit to other than the TOSHIBA ST-7000 series POS terminal. Doing so may damage the unit.
3. Do not place the unit on unstable, slanted surface, or where it might be subject to vibration, as it may drop or fall and cause injury.
4. Avoid locations where the LCD reflects the direct sunlight or room light, as the LCD may become too glaring to see.

4.2 Setup Procedure

1. Turn OFF the POS terminal.
2. Place the unit on a level and stable surface.
3. Connect the unit to the POS terminal by the Display Interface Cable and Keyboard Interface Cable.
4. Turn ON the POS terminal.
5. Adjust the brightness and tilt angle.

< Rear view of the ST-7000-2E/F series + KIT-7000-DSP1-QM-R >

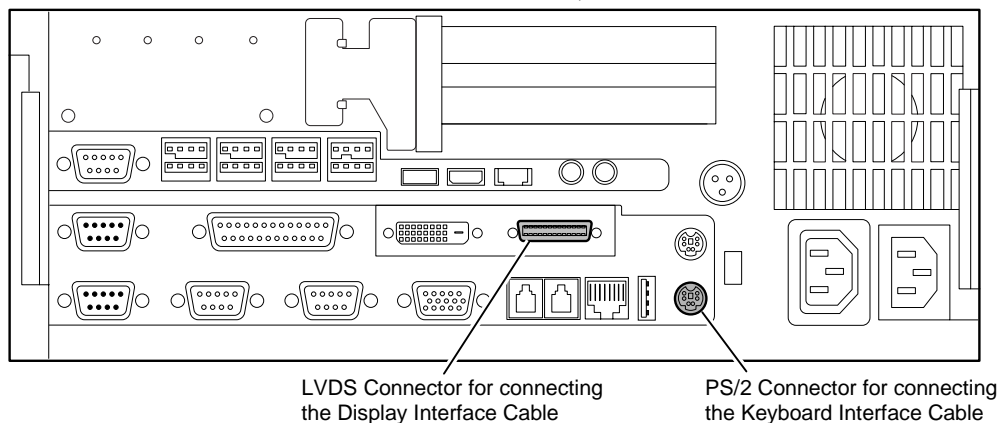

< Rear view of the ST-7000-1C series + KIT-7000-DSP3-QM-R >

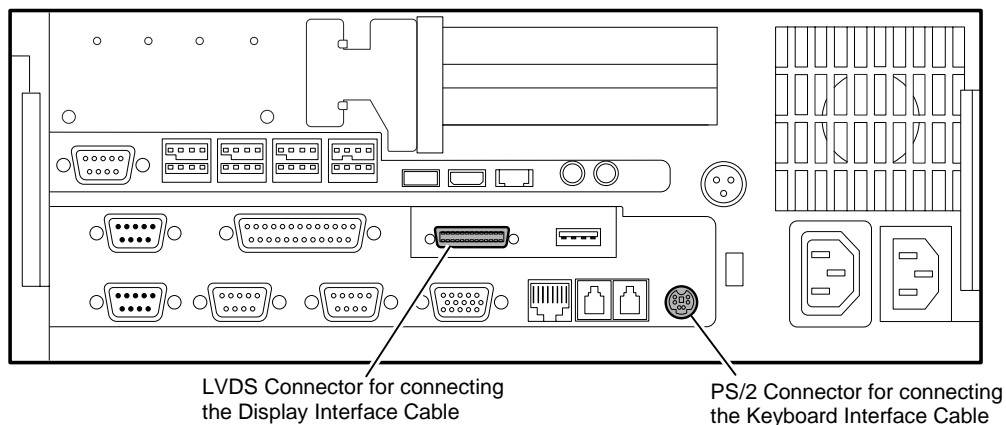

5. ADJUSTMENT

Tilt angle, Brightness, Speaker Volume and Key Tone Volume are adjustable on the unit.

CAUTION:

1. Be careful not to catch your fingers by tilt unit when changing the display angle.
2. Do not adjust the tilt angle by holding the LCD panel. Doing so may damage the unit. Be sure to hold the LCD Frame.

5.1 Tilt Angle Adjustment

The tilt angle is adjustable freely within a range of 40° to 80°.

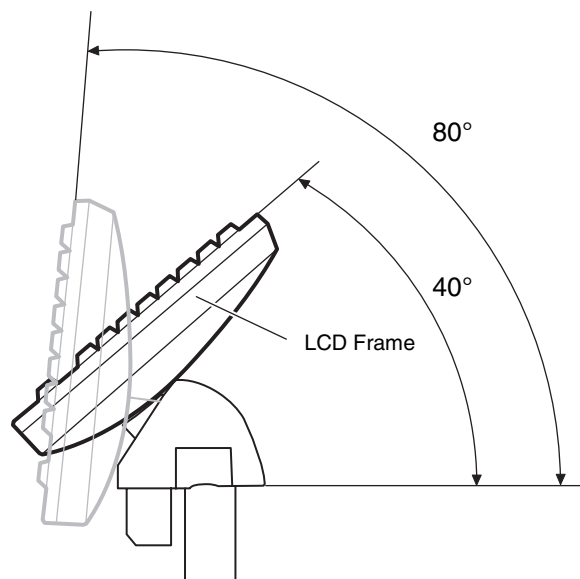

NOTE: When adjusting the tilt angle, be sure to hold the LCD Frame.

5.2 Brightness Adjustment

The brightness is adjusted with the control provided on the bottom of the unit.

To make the LCD brighter, turn the control clockwise. To make it darker, turn the control counterclockwise.

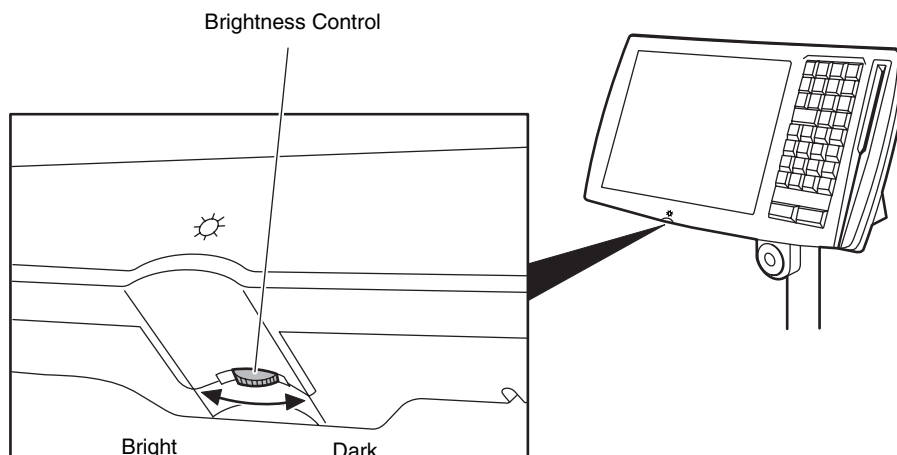

5.3 Speaker Volume Adjustment

The speaker volume is adjustable with the speaker volume control on the left of the rear cover as shown below. Adjust the volume with a small Phillips head screwdriver. Clockwise turn will turn up the volume and counterclockwise turn will turn down the volume.

- NOTES:**
1. Before adjusting the speaker volume, fully turn the speaker volume control on the front of the ST-7000 clockwise.
 2. Select either the speaker of the ST-7000 series or that of the LKBST-65. When the speaker of the ST-7000 series is selected, the volume cannot be adjusted on the LKBST-65.

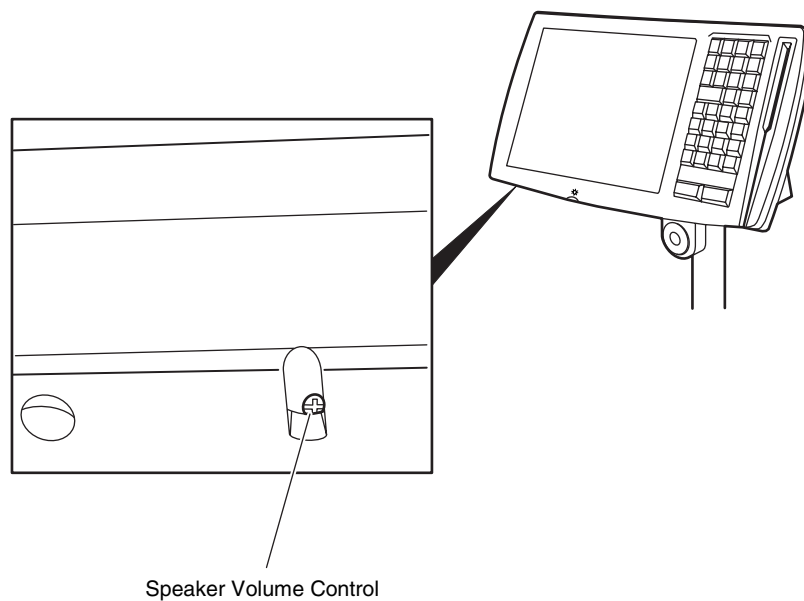

5.4 Key Tone Volume Adjustment

The key tone volume control is provided on the right of the rear cover as shown below. Adjust the volume with a small Phillips head screwdriver. To turn up the volume, turn the control clockwise. To turn down, turn it counterclockwise.

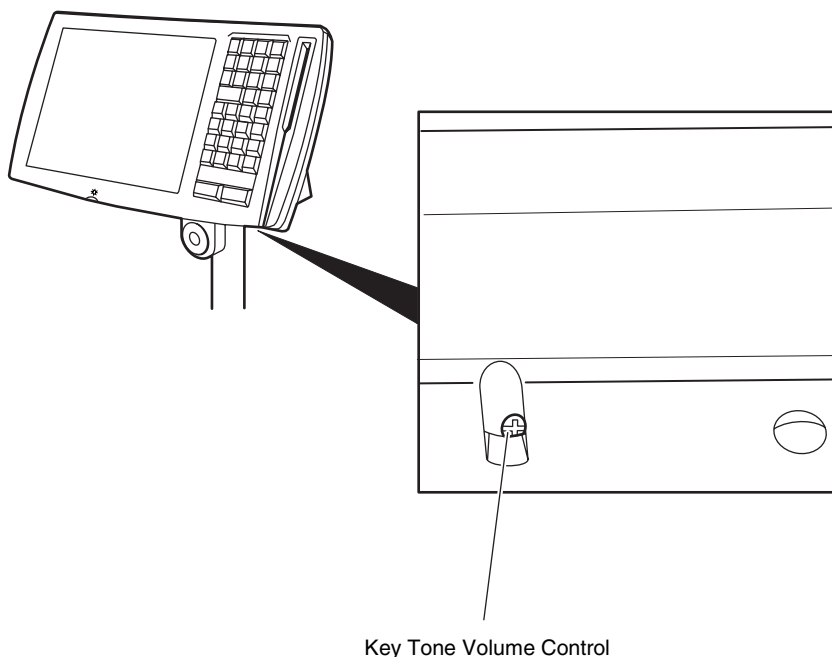

6. GENERAL MAINTENANCE

6.1 Cleaning

WARNING!

1. *Be sure to disconnect the power cord of the POS terminal prior to performing any maintenance.*
2. *Do not pour water directly on or wipe the LCD with a soaked cloth, as this may cause fire, electric shock, or machine failure.*

CAUTION!

1. *Never use a solvent like thinners or benzene for cleaning. Using such solvents may discolor the covers.*
2. *Do not use any sharp object to clean the LCD display. Doing so may cause an LCD display failure.*
3. *Do not insert nozzle of an air blower into the magnetic card reader slot. Doing so may damage the scanning head, resulting in the magnetic card reader failure.*

To help retain the high quality and performance of your unit, it should be cleaned regularly. The greater the usage on the machine, the more frequent the cleaning. (i.e. low usage = weekly : high usage = daily)

- **Cleaning the LCD**

Clean the surface of the LCD display with a soft dry cloth or with an electrostatic free cleaner for automated office equipment.

- **Cleaning the Covers**

Wipe the covers with a soft dry cloth or soft cloth slightly moistened with mild detergent. After using detergent for cleaning, be sure to wipe it off with a slightly moistened cloth.

- **Cleaning the Magnetic Card Reader (Option)**

Remove any dust from the slot of the magnetic card reader with an air blower. To clean the card reader head, use a head cleaning card available on the market.

7. TROUBLESHOOTING

WARNING!

If you cannot solve a problem with the following solutions, do not attempt to repair it yourself. Turn the power OFF, unplug the POS terminal, then contact your TOSHIBA TEC representative for assistance.

Problem	Check Point	Solution
The unit does not turn on by turning on the POS terminal.	<ul style="list-style-type: none"> • Are the cables connected properly? • Is the power supplied to the POS terminal? 	<ul style="list-style-type: none"> • Properly connect the display interface cable again. • Turn the POS terminal power switch to on.
The LCD display is hard to see.	<ul style="list-style-type: none"> • Does the LCD display reflect sunlight or room light? • Is the brightness adjusted properly? 	<ul style="list-style-type: none"> • Refer to Page 5-1 and adjust the display tilt angle. • Refer to page 5-1 and adjust the brightness properly.
The speaker of unit does not sound or sounds too soft.	<ul style="list-style-type: none"> • Has the volume of the POS terminal been fully turned up? • Has the volume of the LKBST-65 been properly adjusted? 	<ul style="list-style-type: none"> • Turn up the volume of the POS terminal fully. • Refer to page 5-2 and adjust the volume of the LKBST-65 properly.
Magnetic Card Reader does not read the data.	<ul style="list-style-type: none"> • Does the used card comply with the standard? • Is the card reading direction correct? • Are the other cards read correctly? 	<ul style="list-style-type: none"> • Use Track 1 and 2 complying with ISO. • Insert the card so that the magnetic strip faces the scanning head. • If other cards are read correctly, the card itself may be wrong. (a low-magnetic card, scratches, etc.) If other cards are also not read, the magnetic card reader itself may be wrong. Then, contact the nearest TOSHIBA TEC representative for assistance.

English

Waste Recycling information for users:

Following information is only for EU-member states:

The crossed out wheeled bin symbol is used to indicate that the product must not be treated as general household waste. By ensuring that this product is disposed of correctly you will be helping to prevent potentially negative consequences for the environment and human health, which could otherwise be caused by incorrect waste handling of this product. For more detailed information about the take-back and recycling of this equipment, please contact the supplier that provided you with the product in question.



French

Information aux utilisateurs concernant le recyclage des déchets:

Les informations suivantes sont uniquement destinées aux pays membres de l'Union Européenne:

L'utilisation du symbole de "poubelle à roulettes barrée" indique que ce produit ne doit pas être traité comme un déchet ménager classique.

En vous assurant que ce produit est correctement mis au rebut, vous participerez à la prévention de l'environnement et de la santé publique, contre des conséquences négatives potentielles qui pourraient résulter d'un traitement inapproprié des déchets de ce produit. Pour obtenir des informations complémentaires concernant la récupération et le recyclage de ce produit, veuillez contacter le fournisseur auprès duquel vous avez acheté le produit.



German

Wiederverwertungsinformationen für Verbraucher:

Die folgenden Informationen gelten nur für EU-Mitgliedsstaaten:

Das durchgestrichene Mülltonnensymbol weist darauf hin, dass dieses Produkt nicht wie allgemeiner Haushaltsmüll behandelt werden darf.

Indem Sie aktiv mitwirken, dieses Produkt ordnungsgemäß zu entsorgen, helfen Sie mit, mögliche negative Auswirkungen auf die Umwelt sowie die menschliche Gesundheit zu vermeiden, die sonst durch die unsachgemäße Entsorgung dieses Produktes beeinträchtigt werden könnten.

Für nähere Informationen zur Rücknahme und Wiederverwertung dieses Produktes wenden sie sich bitte an den Lieferanten, von dem Sie dieses Produkt erworben haben.



Spanish

Información para usuarios sobre el reciclaje de residuos:

La siguiente información sólo concierne a los Estados Miembros de la UE:

El uso del símbolo de un contenedor con ruedas tachado indica que este producto no puede ser tratado como si fuera un residuo doméstico.

Asegurando que nos deshacemos de este producto de forma correcta, ayudaremos a evitar potenciales consecuencias negativas tanto para el medio ambiente como para la salud pública, que podrían producirse debido a un tratamiento inapropiado de este producto. Para obtener una información más detallada sobre la recogida y reciclaje de su producto, por favor, póngase en contacto con el proveedor donde lo compró.



Dutch

Gebruikersinformatie over het recycleren van afval:

De volgende informatie geldt enkel in EU-lidstaten:

Het symbool met de doorkruiste afvalbak geeft aan dat dit product niet mag worden behandeld als algemeen huishoudelijk afval.

Door dit product op de juiste manier van de hand te doen beschermt u het milieu en de volksgezondheid tegen mogelijke negatieve gevolgen, die anders zouden kunnen voortvloeien uit het onjuist verwerken van de resten van dit product.

Voor gedetailleerde informatie over het terugnemen en recycleren van dit product, gelieve contact op te nemen met de leverancier van dit product.



Italian

Informazioni sul riciclo del prodotto:

Le seguenti informazioni riguardano gli stati membri EU:

Il simbolo con il bidone sbarrato indica il non poter smaltire questo prodotto come rifiuto domestico.

L'accertamento che questo prodotto sia smaltito correttamente contribuirà ad impedire le potenziali conseguenze negative per l'ambiente e la salute umana che potrebbero essere causati, al contrario, dall'errato smaltimento dello stesso. Per informazioni più dettagliate sulle modalità di resa e riciclaggio di questo prodotto mettetevi in contatto con il fornitore da cui l'avete acquistato.



Portuguese

Informação sobre reciclagem:

A informação que se segue é apenas dirigida a países membros da CEE:

A utilização deste símbolo indica que este produto não pode ser tratado como lixo comum.

Ao assegurar-se que este produto é tratado correctamente está a ajudar a prevenir potenciais consequências negativas para o ambiente e para a saúde humana, que poderiam ser causadas pelo inapropriado tratamento deste produto.

Para mais informação sobre a reciclagem e tratamento deste produto, contacte o seu fornecedor.





TOSHIBA TEC CORPORATION

E PRINTED IN JAPAN
EO1-19039

Free Manuals Download Website

<http://myh66.com>

<http://usermanuals.us>

<http://www.somanuals.com>

<http://www.4manuals.cc>

<http://www.manual-lib.com>

<http://www.404manual.com>

<http://www.luxmanual.com>

<http://aubethermostatmanual.com>

Golf course search by state

<http://golfingnear.com>

Email search by domain

<http://emailbydomain.com>

Auto manuals search

<http://auto.somanuals.com>

TV manuals search

<http://tv.somanuals.com>