

TOSHIBA

OWNER'S MANUAL
LCD Monitor

P32LSA

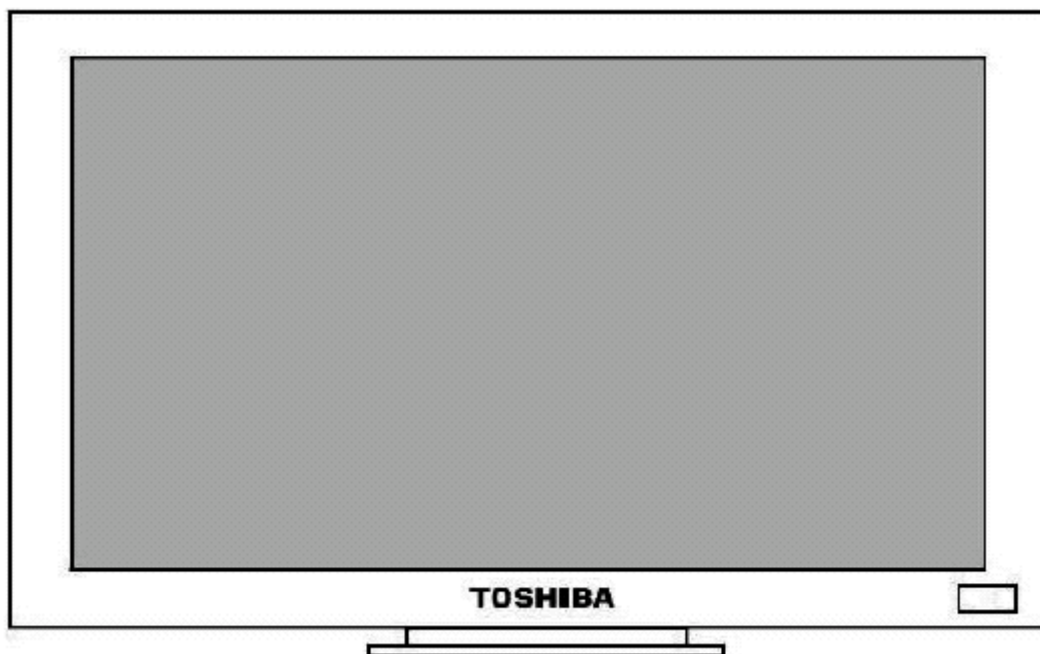



Contents

Safety Instructions -----	3
Notes and Cautions for Use -----	10
■ On usage-----	10
■ On disposal or handing over to a new owner -----	10
■ Exemptions-----	10
Features -----	11
Names and Functions of Controls <Unit> -----	12
Names and Functions of Controls <Remote control> -----	14
Battery Installation -----	15
Supplied Accessories -----	16
Connection -----	17
Connecting the Power Cord -----	18
Installation -----	19
Dimension -----	24
Power On/Off -----	26
■ Main power switch-----	26
■ POWER button on the Remote control-----	26
Menu Function -----	27
■ Function of each button-----	27
■ OSD lock/unlock control-----	27
■ Menu display chart-----	28
■ Factory default setting-----	29
Input Signal -----	30
■ Input signal -----	30
A Guide to Simple Problem Solving -----	31
■ For inquiries-----	31

Safety Instructions







Before using the unit, please read this manual thoroughly to help protect against damage your own and other people's property your property from potential damage and ensure your own and other people personal safety.
Be sure to observe the following instructions with understanding meaning of signs and figures below.

Meaning of Signs

Sign	Meaning of Sign
 Warning	Disregard may cause death or serious injury*¹.
 Caution	Disregard may cause injury*² or material damage*³.

- * 1: "Serious injury" refers to blindness, burns (by both high and low temperature), electric shock, break in bones poisoning which cause hangover or require hospitalization or a long term treatment.
- * 2: "Injury" refers to wounds, burns, electric shock which does not require hospitalization nor a long term treatment.
- * 3: "Material damage" refers to damages extended to houses, household effects, livestock, pets.

Example of figure

Figure	Meaning of Figure
 Prohibition	“  “ shows prohibited matter. The contents are written or shown by picture at inside or near the figure.
 Instruction	“  “ shows instructed matter. The contents are written or shown by picture at inside or near the figure.
 High-tension current	“  “ shows caution. The contents are written or shown by picture at inside or near the figure. The figure on the left shows caution for High-tension current.



Malfunction or Trouble

If smoke or peculiar smells comes from the unit, remove the power plug from the outlet immediately.

If the unit is still used in this condition, it may cause a fire or an electric shock.

Make sure that the smoke or smell has stopped, then contact your dealer for inspection.



If when there isn't picture or sound, remove the power plug from the outlet immediately.

If the unit is still used in this condition, it may cause a fire or an electric shock.

Contact your dealer for inspection.



If water is spilled or objects are dropped inside the unit, remove the power plug from the outlet immediately.

If the unit is still used in this condition, it may cause a fire or an electric shock.

Contact your dealer for inspection.



If the unit is dropped or the cabinet is damaged, remove the power plug from the outlet immediately.

If the unit is still used in this condition, it may cause a fire or an electric shock. Contact your dealer for inspection.

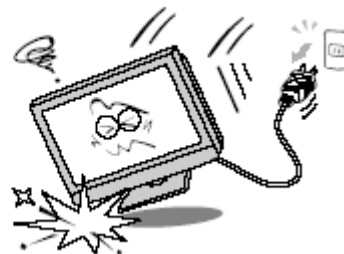

To turn off the power of the unit, press “ ” on the main power switch.

• The power standby/on indicator goes off and you cannot turn the unit on/ off by using the POWER button on the remote control. (To turn on/off the unit by the remote control, press the main power switch again and light the power standby/on indicator.)

• When you turn off the unit by pressing the POWER button on the remote control, the main power of the unit is not turned off.

• To disconnect the unit completely from power supply, remove the power plug from the outlet.

If the power cord or plug is damaged or becomes hot, turn off the main power switch of the unit, make sure the power plug has cooled and remove the power plug from the outlet.

If the unit is still used in this condition, it may cause a fire or an electric shock. Contact your dealer for replacement.

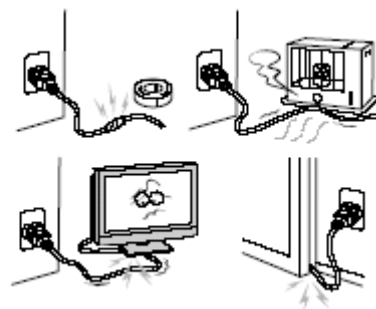

Installation

When installing the unit, use the specified stand.

If not, the unit may fall down and cause an injury.



Do not place the unit in locations of high humidity, such as a bathroom or close to a humidifier.

This may cause a fire or an electric shock.

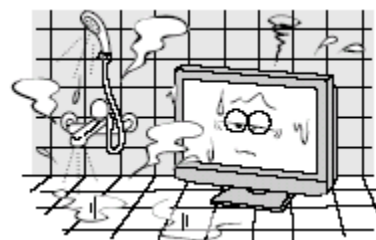

Do not place the unit in an unstable location, such as a shaky table or incline.

The unit may fall down and cause injury or damage.
Install the unit on a horizontal, stable surface.

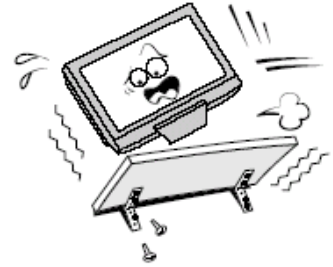

Do not place the unit in a location subject to vibration.

The unit may fall down because of the vibration and may cause an injury.



Insert the power plug fully into a 100-240V AC outlet.

- If you use an outlet other than 100 240 V AC, it may cause fire or electric shock.
- Improper insertion of the plug may cause heat and fire.
- Do not use a damaged power plug or worn outlet.



Do not place objects on the unit.

If metal or liquid (when putting vase, glass or cosmetics) get into the unit, it may cause fire or electric shock.

If you put heavy objects on the unit, it may fall down and cause injury.



When installing the unit, have your dealer arrange for professional installations.

If the installation work is not correct, it may cause injury.



Use

Never repair, modify or disassemble the unit by yourself.

It may cause a fire or an electric shock because dangerous voltages exists in the unit. Consult your dealer for internal inspection and repairs.

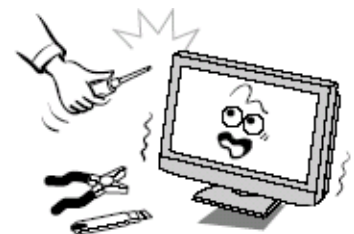

Follow these precautions for the power cord and lug.

Do not damage, modify such as by extending, or heat (such as by pressing near heating equipment).

Do not pull, place heavy objects or pinch.

Do not bend, twist or bunch up.

Fire or electric shock may result.

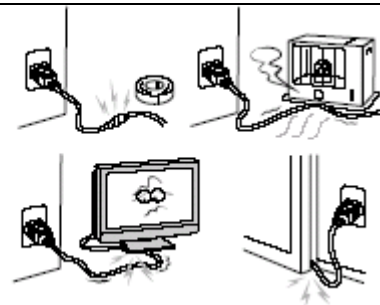

Do not insert objects inside the unit.

If metallic materials or combustibles such as paper get inside the unit from ventilation holes and other places, it may cause a fire or an electric shock.

Be especially careful that children do not insert objects in the unit.



If there is thunder or lightning, do not touch the unit or the power plug.

You may suffer an electric shock.

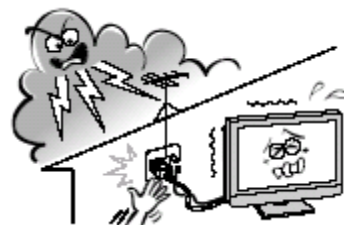

Cleaning

If dust has collected on the power plug connectors, remove the plug from the outlet and clean off the dust.

This dust may cause a fire due to reduced insulation of the plug.

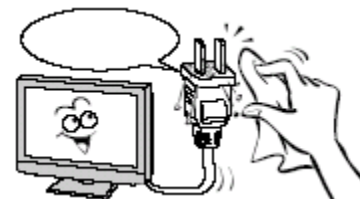

Caution

Installation

Do not install the unit where humidity is high.

If the unit is installed in direct sunlight, a closed car or near a stove, it may cause overheating or electric shock. Also the cabinet or other parts may distort or be damaged, and electric shock may result.



Do not install the unit where it is exposed to humidity, oil, smoke or excessive dust.

If the unit is installed next to a humidistat, a stove or in a location where there is a large quantity of dust, it may cause a fire or electric shock.



Take measures to prevent the unit from falling down.

If not, the unit may fall down and cause injury.



Do not block the ventilation holes on the unit.

The inside of the unit will overheat if the ventilation holes are sealed, which may result in a fire.

- When installing the unit near a wall, keep the unit at least 10 cm from the wall.
- Do not place the unit in a closet or bookshelf where ventilation is poor.
- Do not spread a newspaper, tablecloth or curtain over the unit.
- Do not place the unit on an unstable surface, such as a rug, or a cushion, etc.
- Do not place the unit so that it is facing up or down, or on its side.

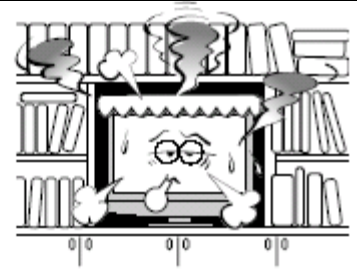

Precautions for moving the unit:

- When moving the unit, be sure to remove the plug from the wall outlet and disconnect wiring cables between equipment and detach any securing anchors. If not, fire or electric shock may result if the power cord is damaged, injury may occur by the unit falling down.
- When unpacking or carrying the unit, at least two people are needed. Make sure the units upright,
- Do not carry the unit with the screen facing up or down.
- Handle the unit so as not to jolt the unit.



Do not overload outlets or cables beyond their capacity.

Do not use extension cords.

Electric shock or fire may result.



Use

Do not pull the power cord when removing the plug from the wall outlet.

If the power cord is yanked, the cord may become damaged and fire or electric shock may occur. Always hold the plug firmly when removing it.



Never insert or remove the power plug with wet hands.

This may cause electric shock.

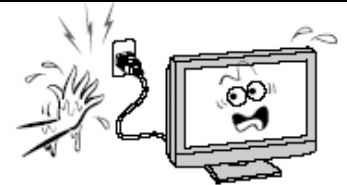

Do not climb or stand on the unit.

If may drop, fall down, break or cause an injury.



If the unit will not be used for a long period of time, remove the power plug from the wall outlet for safety.

If not, in the case of malfunction, it may cause fire.



Precautions for the remote control batteries:

Only use the specified battery type.

Be sure to insert batteries by matching the + and -.

Do not recharge, heat, disassemble, short or throw batteries into a fire.

Do not use the batteries beyond their usage period (designated on the batteries), do not leave worn out batteries in the unit.

Do not mix different types of batteries together.

Do not mix a new battery with a used one.

If these precautions are not observed, it may lead to battery leakage or explosion and cause burn and injury.

If leaked liquid gets into your eyes or gets in touch with your skin, it may hurt your eyes or your skin. If leaked liquid gets into your eyes or mouth or comes in contact with your skin, rinse the contacted area with clean water immediately and consult your doctor. If the leaked liquid comes in contact with your cloth, rinse the contacted area with clean water immediately. If the leaked liquid comes in contact with other equipments, clean them without touching the leaked liquid.



Do not push or jolt the LCD panel

The glass of the LCD panel may break and cause injury.

If the screen glass breaks, crystalline liquid leakage may occur. Do not touch crystalline liquid (liquid).

If leaked liquid gets into your eyes or comes in contact with your skin, it may hurt your eyes or your skin. If leaked liquid gets into your eyes or mouth or comes in contact with your skin, rinse the contacted area with clean water immediately and consult your doctor. If the leaked liquid comes in contact with your cloth, rinse the contacted area with clean water immediately. Should the leaked liquid comes in contact with other equipment, clean them without touching the leaked liquid.



This product contains chemicals, including lead, known to the State of California to cause birth defects or other reproductive harm.

Wash hands after handling.



Cleaning

Remove the power plug before cleaning.

If not, it may cause electric shock.

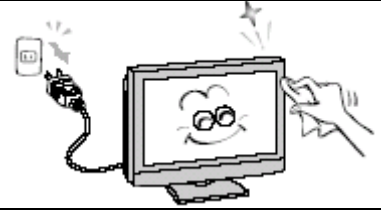

Consult your dealer for internal cleaning once a year.

If you allow dust to accumulate on the unit, it may cause fire or malfunction when you operate it.

Cleaning is effective especially before the rainy season when humidity is high.

Refer to your dealer about the service charge for internal cleaning.

Notes and Cautions for Use

■ On usage

- Some parts of the body are hot during operation. Please be careful.
- In case of moving long-distance, wrap the unit with blanket to avoid damages. Be careful not to bump the unit.
- Do not spray on the unit volatile liquid like insecticide. Do not expose long time to rubber or vinyl. It will damage the coating.

■ On disposal or handing over to a new owner

- It is recommended to initialize the unit by resetting "PICTURE" and "SETUP" menu.
- Do not mix with other general waste.
- Do not dispose LCD monitor in waste treated by a waste treatment center.
- This unit has a lamp inside which includes mercury. For disposal, please follow regulation of your district

■ Exemptions

- Toshiba is not liable for any damage caused by natural disaster (such as earthquake, thunder, etc.), fires, acts by third parties, accidents, owner's intentional misuse and fault, or uses in other improper conditions.
- Toshiba is not liable for incidental damages (such as profit loss or interruption in business, modification or erasure of record data, etc.) caused by use or inability to use of this product.
- Toshiba is not liable for any damage caused by neglect of the instructions described in the owner's manual.
- Toshiba is not liable for any damage caused by misuse or malfunction through simultaneous use of this product and the connected equipment or software.
- Toshiba is not liable for any damage caused by neglect of the instructions described about the installation stand in the owner's manual.
- Toshiba is not liable for any damage caused by improper installation.

Features

High-resolution HD panel

You can enjoy extreme fine pictures with a big flat LCD monitor panel of 3,150,000 pixel.

MVA system less-reflection black TFT LCD panel

MVA system and Black TFT LCD panel offer bright and wide images with clear contrast. Even placed near the window, the unit shows bright and clear images with little reflection. The viewing angles of the monitor are as wide as 170° both horizontally and vertically, enough to enjoy clear images at any view angle.

Varieties of terminals are available

Video system Input: You have 3 choices of terminals for Video system Input.

VIDEO RCA
S-VIDEO Mini Din 4pin
Y-Pb-Pr Mini Din 8pin

RGB: You have 2 choices of terminals for RGB Input.

RGB ANALOG D-Sub 15 pins
RGB DIGITAL DVI-D 24 pins

Dimmer function

With the photo sensor inside, the panel will adjust the brightness according to the surrounding light intensity. There are two brightness level pre-setting. Under bright condition, it will adjust to the bright mode. Under dim condition, panel will adjust to dim mode automatically.

Names and Functions of Controls <Unit>

Front

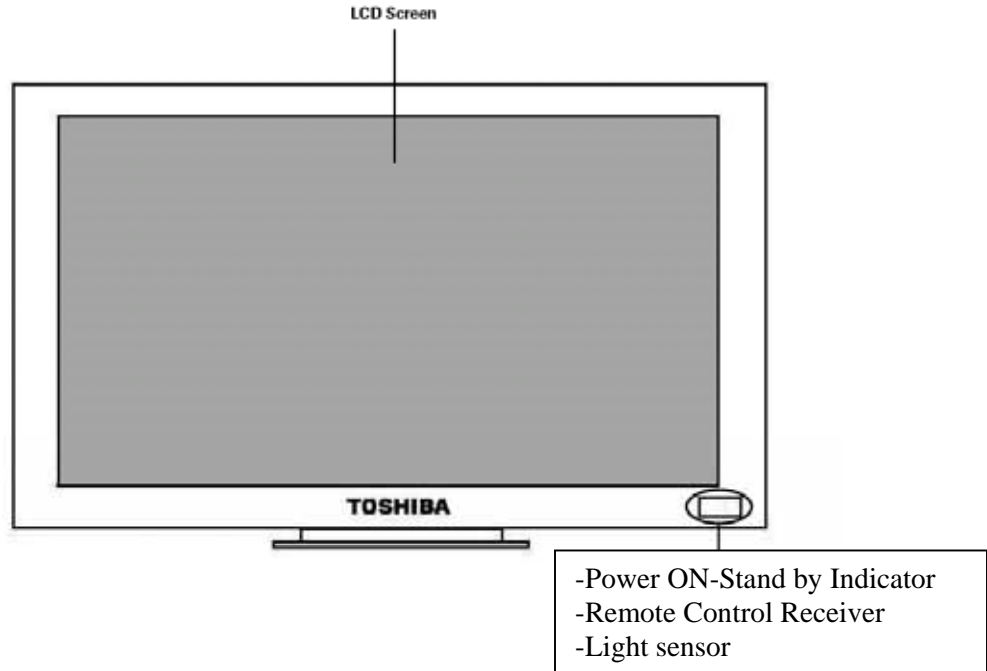

Side Controls

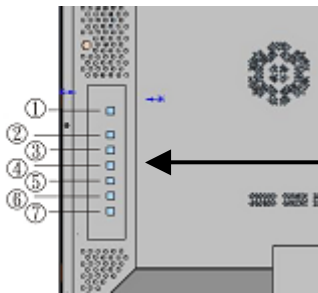

- Power (standby / on)
- Enter (activate selection)
- ▷ / + (scroll right for Menu items / volume increase)
- ◁ / - (scroll left for Menu items / volume decrease)
- (scroll down for Menu items)
- (scroll up for Menu items)
- Menu/ Exit (OSD control Menu button / Access Main / Sub-menu / Quick Menu Selection)

Back

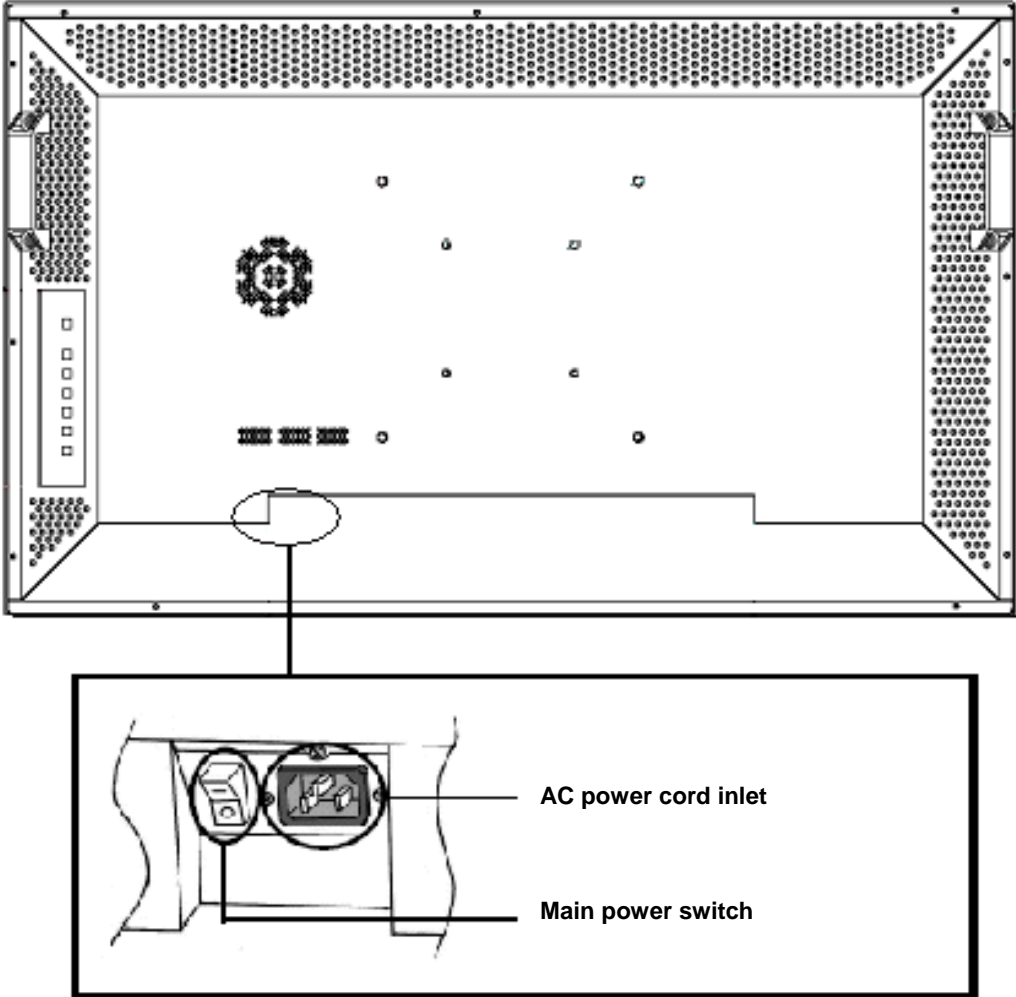

Names and Functions of Controls <Remote control>

(Option)

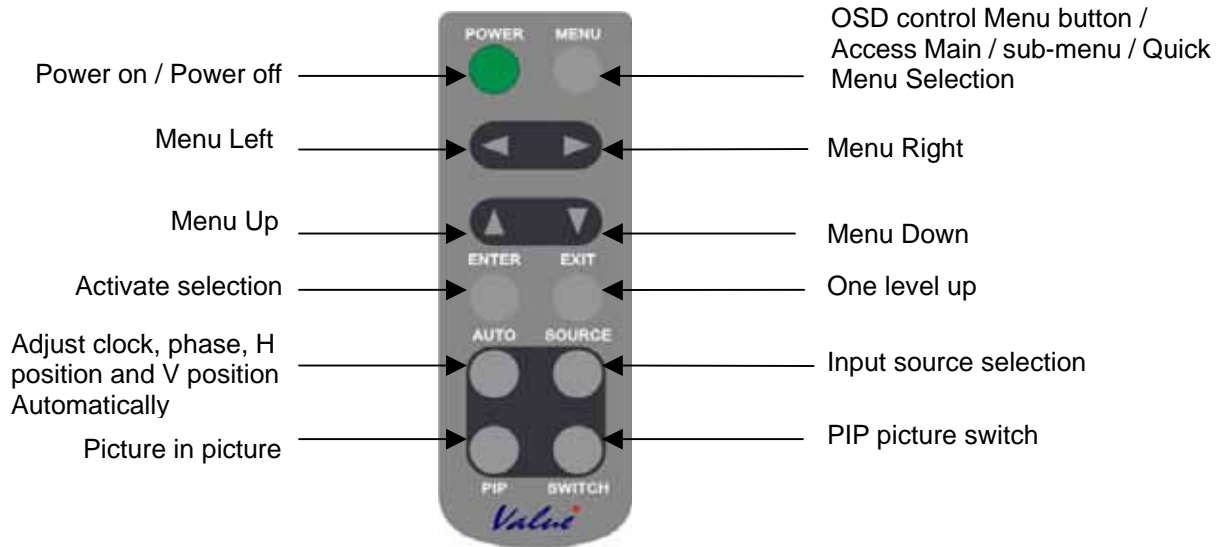

Battery Installation

(Option)

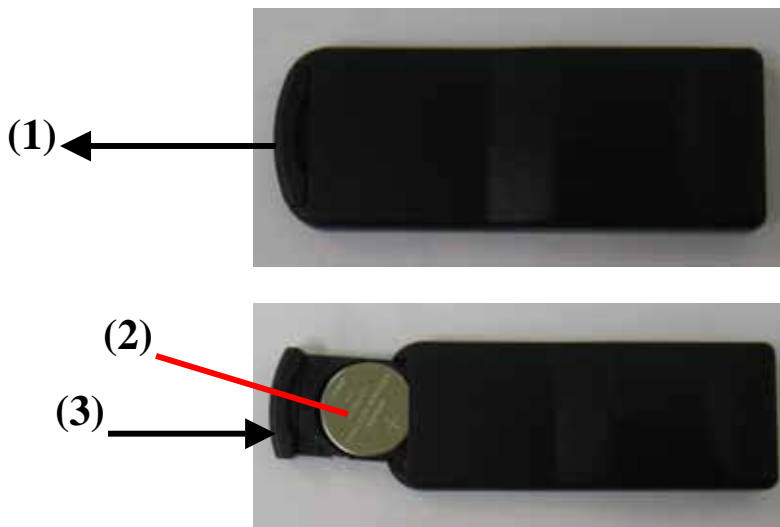

To replace batteries inside

- 1) Push down a little as (1) in the picture and pull the back cover
- 2) Replace with the new batteries as (2), 1 piece Lithium battery (CR2032) make sure the polarity of batteries are correct.
- 3) Place back cover and slide it is as (3) in the picture.
- 4) Used batteries need to follow the city rule to discard.
- 5) Avoid keeping used, old batteries inside the remote control, causing leakage of internal liquid resulting metal rust or fatal damage to the remote control hand unit.

CAUTION

Risk of explosion if battery is replaced by an incorrect type.
Dispose of used batteries according to the instructions.

Effective range

- Point the remote control at remote sensor on LCD monitor.

About the remote control

- Do not drop, shake or bump.
- Do not wet, do not place on wet materials.
- Do not dismantle.
- Do not place in locations exposed to high temperature or high humidity levels.

Supplied Accessories

Please check all are supplied.

Power Cord x 1 (1.8m)

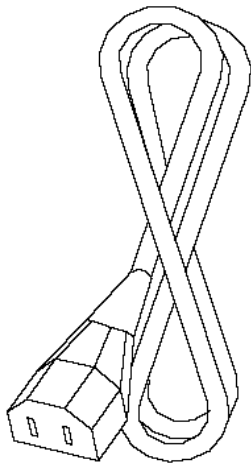

Owner's Manual x 1

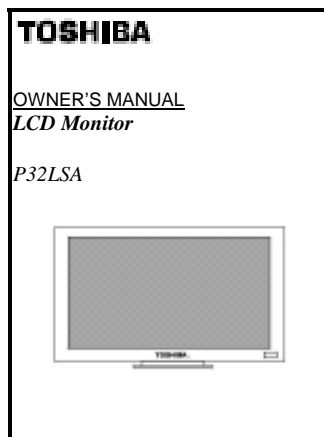

M4 Screws x 4 pieces



M6 Screws x 4 pieces



Connection

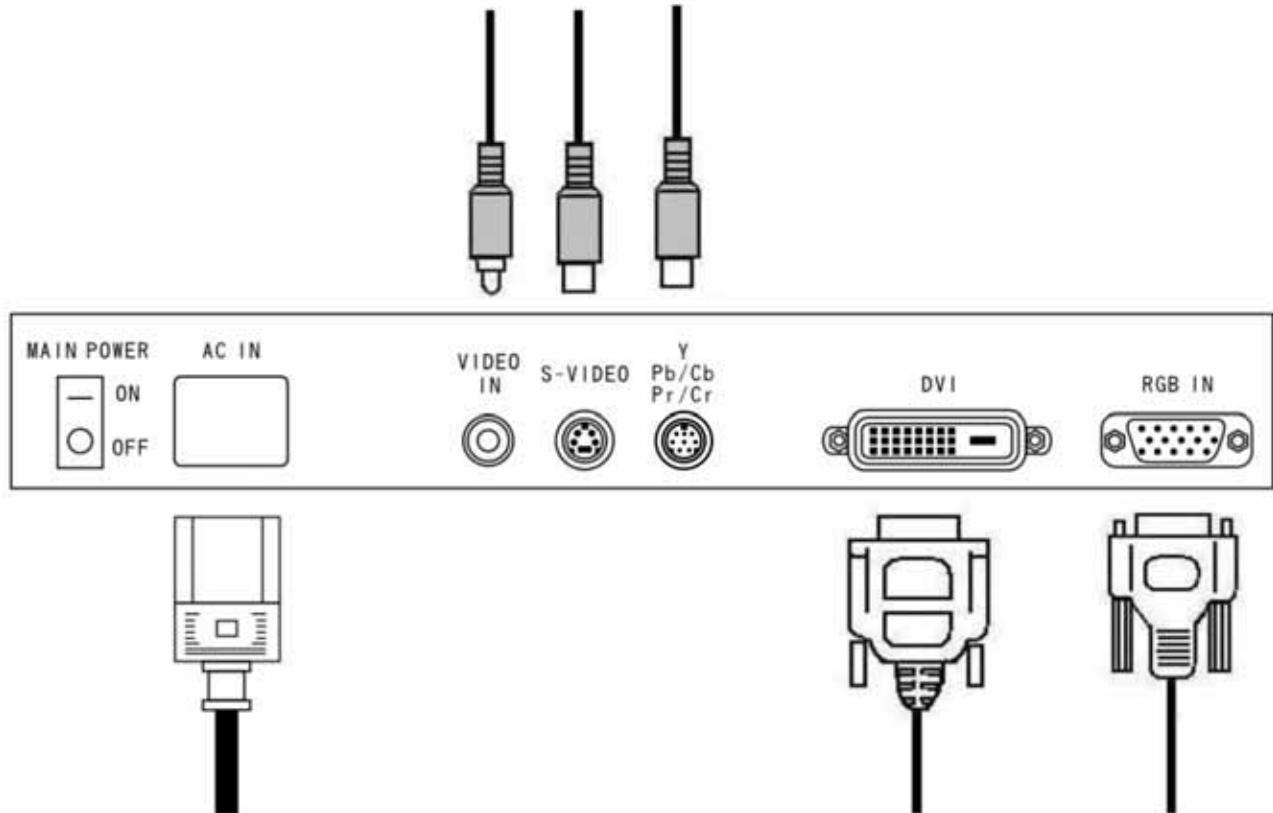

■ VIDEO SYSTEM INPUT

You can select VIDEO input from 3 terminals below;

	Terminal Type	Suitable signals
VIDEO-IN	RCA	NTSC/PAL
S-VIDEO	S-Video Mini Din 4pin	NTSC/PAL
YUV (Y Pb/Cb Pr/Cr)	Component Mini Din 8 pin	NTSC/PAL

- Suitable signal is automatically selected.

■ RGB INPUT

You can select RGB input from 2 terminals below;

	Terminal Type	Suitable signals
RGB ANALOG	D-Sub 15 pin	RGB ANALOG
RGB DIGITAL	DVI-D 24 pin	RGB DIGITAL

Connecting the Power Cord

Caution: Please turn off the main power switch before connecting.

[Back]

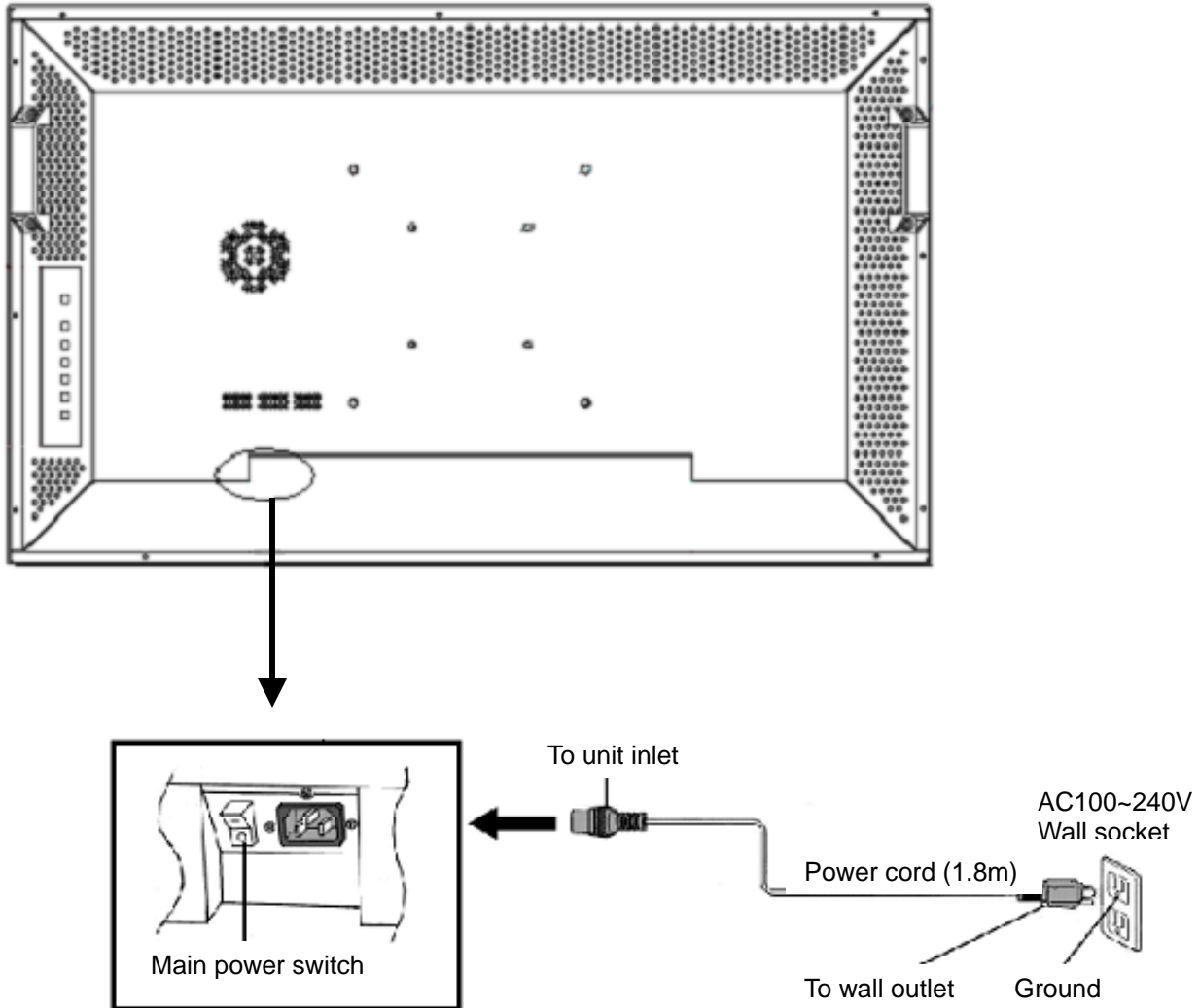

Installation

Wall hanging accessory is available when you hang the monitor on the wall.

Please follow the process mentioned on page 20-22.

When you install the monitor on the ceiling or on the floor, please follow the process on page 23.



To a service technician

- For safety, make sure the place has enough strength to hold the whole weight of the monitor and the frames (*1). If necessary, reinforce the place before installation.
- At least two people are needed for installation.
- Be careful not to lose removed screws or parts.
- Before starting installation, discuss well with customers about the position to install, and get their agreement.
- After installation, check the installation is correct and safe.

*1: About the material and the structure of the wall, ceiling and floor to install LCD monitor

Where to install the LCD monitor

If the wall is made of thin plywood or plastered board, it cannot hold the weight.

The chart below shows adaptable anchors for each material. Please check well the structure and strength of the place to install, and choose the best method for safety.

Adaptable anchors / screws for each material

Material	Anchor
Plastered board	Impossible to install in Plastered board or Plywood board. Install in the tie beam instead of the wall.
Plywood board	
Concrete	Whole anchor or Bolt
Block	Tie lock anchor
ALC	
Mortar	
Brick	
Wooden pillar	Coach bolt (diameter: 6mm x length: 60mm)

For assembly, a screwdriver with more than 300mm shaft is needed.

How to install the monitor on the wall

In case of using option bracket (FPT-WA5)

1. Remove the stand of the LCD monitor

- To avoid damage, spread blanket on the table to put the LCD monitor on.
- To remove the stand of the LCD monitor, put the LCD monitor on the edge of the table, and remove the screws on the stand.
- Described below is one example of how to install the unit on the wall. The wall hanging accessory will need to be manufactured according to the installation, so consult your dealer before the installation work.

2. Wall hanging accessory

Wall hanging accessory is available at the shop.

*: In the package, the bracket and the frame of wall hanging accessory are assembled. Please separate the bracket and the frame at first. After the bracket is fixed on the wall, fix the frame on the LCD monitor.

3. Remove the frame from the bracket

Hold the lower part of the frame and raise it up to remove from the bracket.

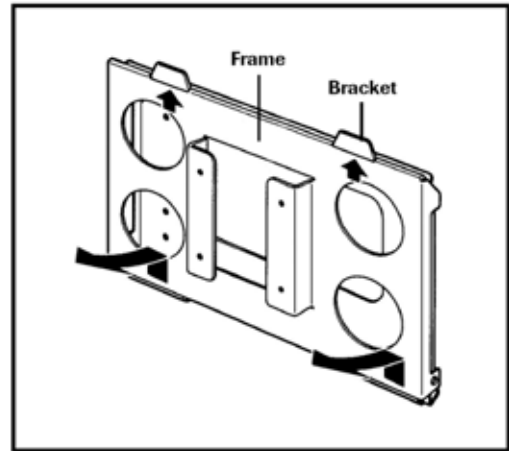

4. Fix the bracket on the wall

- Fix the bracket on the wall firmly with anchors or screws (not supplied).
Make sure anchors or screws are stable.
(Choose appropriate anchors or screws depending on the structure and material of the wall.)
- Refer to the chart on page 19 to check the condition of the wall, and choose the safe and appropriate way for installation.

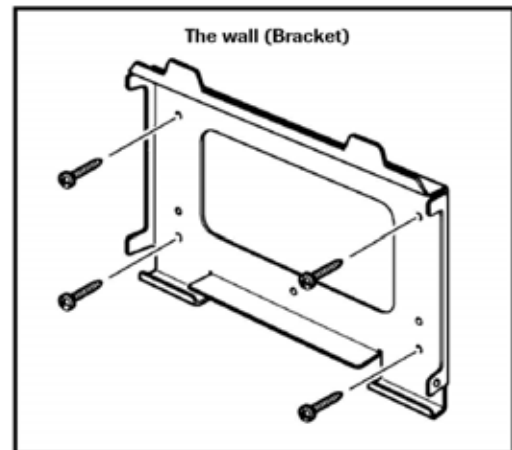

5. Using Supplied screws, fix the frame on the LCD monitor

- To avoid damaging, spread blanket on the flat space, and place the LCD monitor with its panel down.
- Refer to the illustration, and mount the frame on the LCD monitor with four M4 screws.

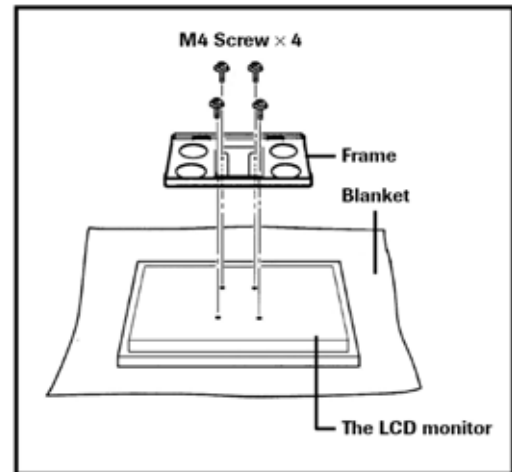

6. Wire before hanging on the wall

- On wiring, refer to page 17 – 18.
- Pay attention to the positions of auxiliary equipment or bracket on the wall, when you decide the route to wire.

7. Mount the LCD monitor on the bracket

*: When mounting, at least two people are needed.

- Raise the LCD monitor, and insert the projection of the bracket.
- Hold the lower part of the LCD monitor and raise a little, push into the lower part of the bracket.

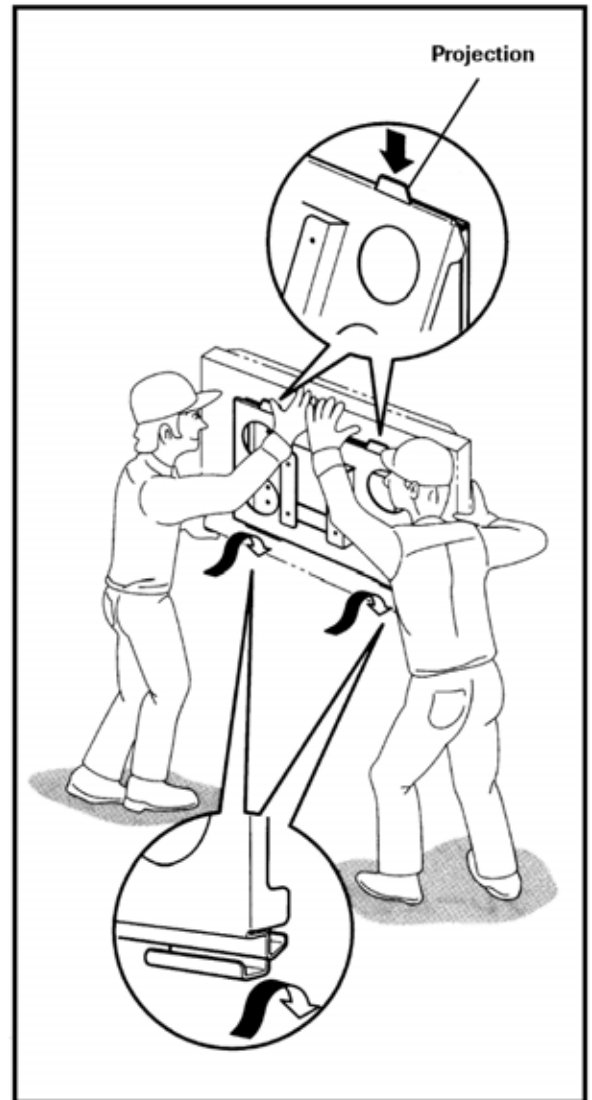

- Fasten with supplied screws

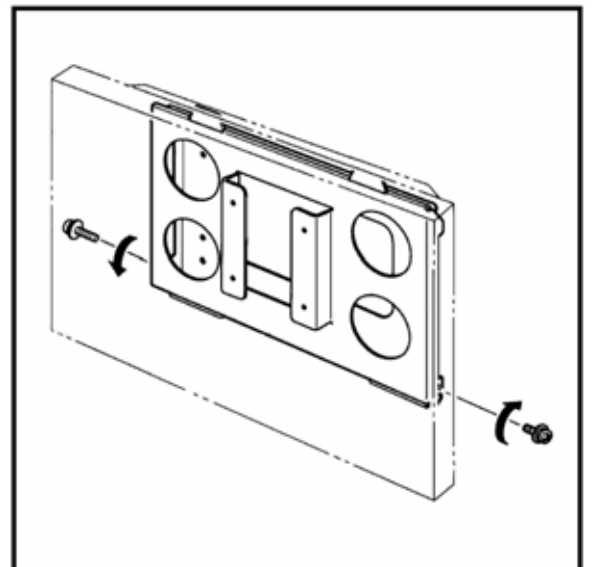

How to install the LCD monitor on the floor

1. Remove the stand of the LCD monitor

- To avoid damage, spread blanket on the table to put the LCD monitor on.
- To remove the stand of the LCD monitor, put the LCD monitor on the edge of the table, and remove the screws on the stand.

2. Floor installation brace for LCD monitor

The floor installation brace will be manufactured according to the installation.

Before the installation work, please consult your dealer for the floor installation brace.

3. Fixing the floor installation brace to the floor

- Fix the brace to the floor firmly with anchors or screws (not supplied).
- Refer to the chart on page 19 to check the installation conditions, and choose a safe and appropriate way to install.

4. Wiring and mounting of the LCD monitor

- For wiring details, refer to pages 17 – 18.
- Raise the LCD monitor and fix it to the floor installation brace with screws.

At least two people are needed for this work.

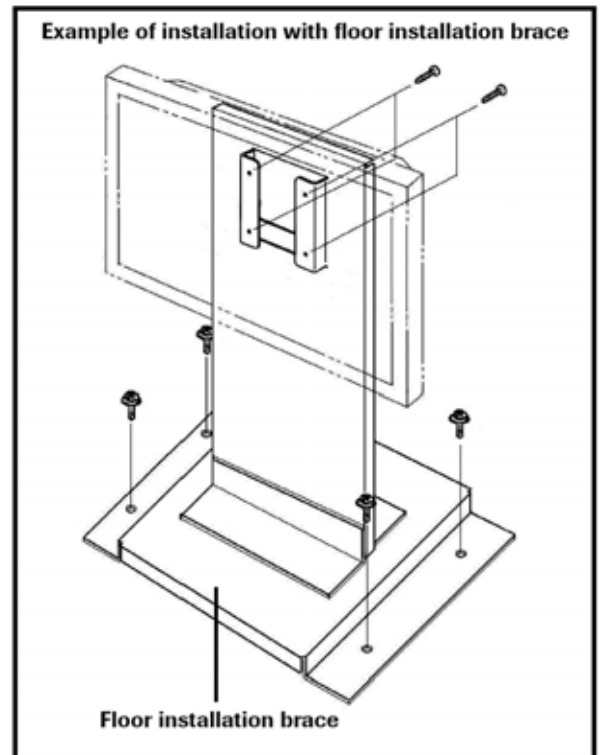

How to install the LCD monitor to the ceiling

1. Remove the stand of the LCD monitor

- To avoid damage, spread blanket on the table to put the LCD monitor on.
- To remove the stand of the LCD monitor, put the LCD monitor on the edge of the table, and remove the screws on the stand.

2. Ceiling installing bracket for LCD monitor

The ceiling installing bracket will be manufactured according to the installation.

Before the installation work, please consult your dealer for the ceiling installing bracket.

3. Fixing the ceiling installing bracket on the ceiling

- Fix the bracket on the ceiling firmly with anchors or screws (not supplied).
- Refer to the chart on page 19 to check the installation conditions, and choose a safe and appropriate way to install.

4. Wiring and mounting of the LCD monitor

- For wiring details, refer to pages 17 – 18.
- Raise the LCD monitor and fix it on the ceiling installing bracket with screws.

At least two people are needed for this work.

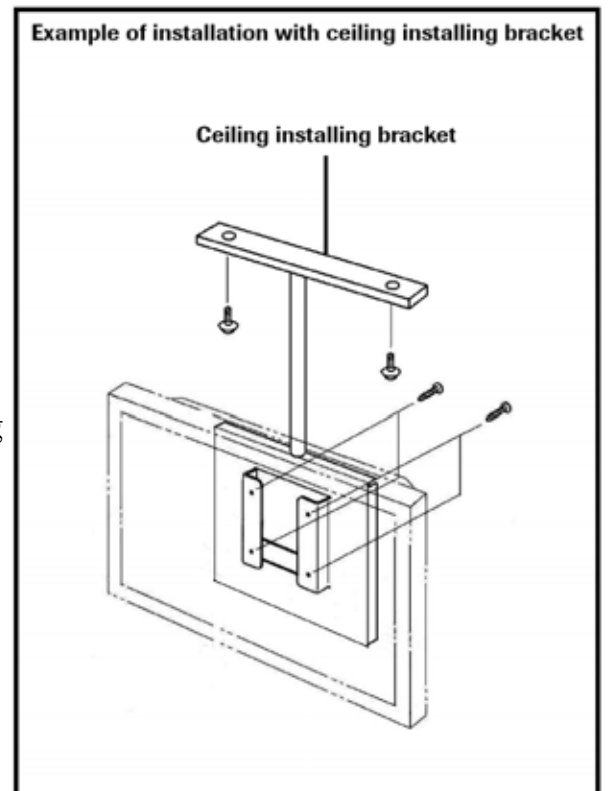

Dimension

■ Front

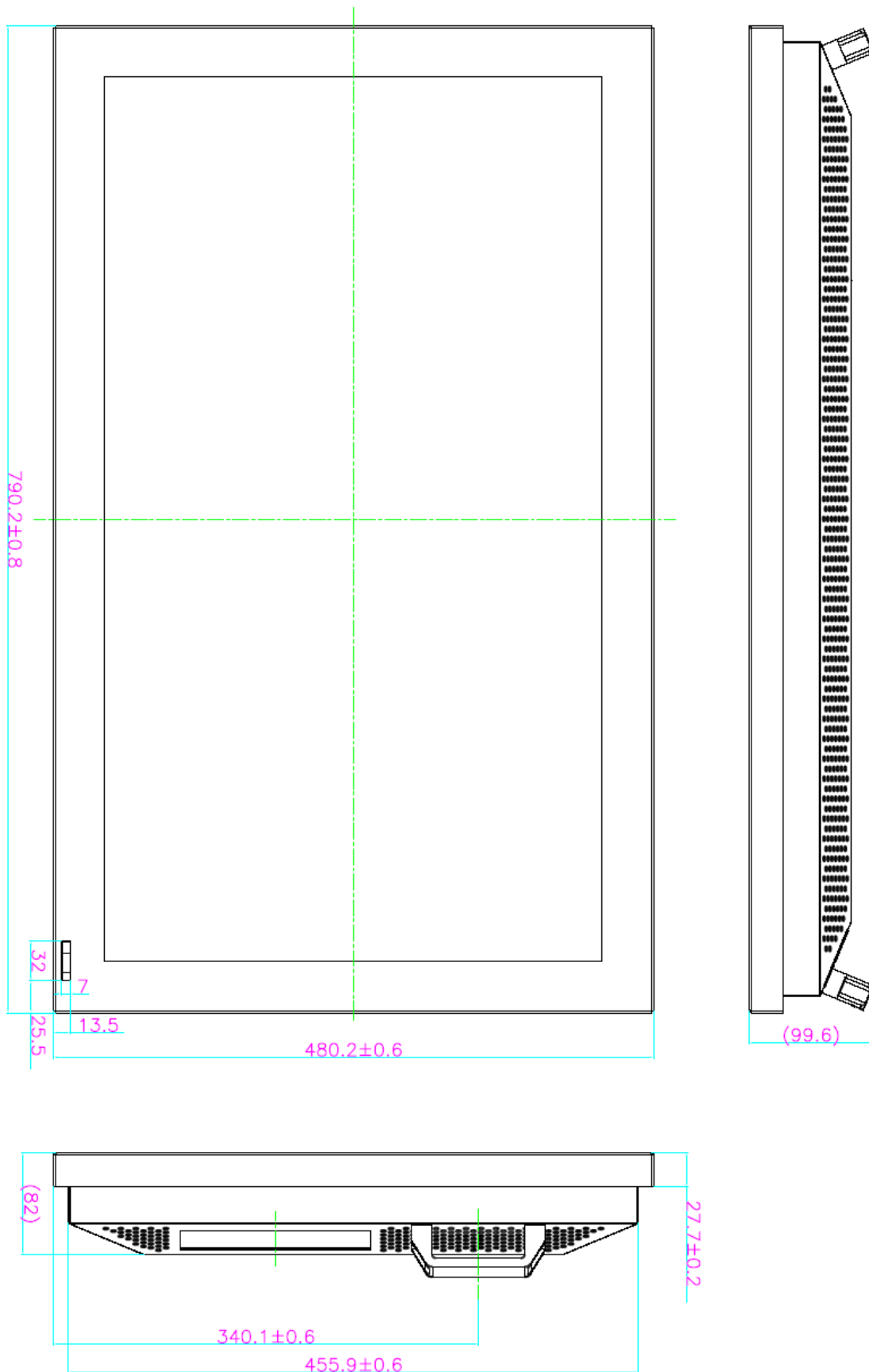

■ Back

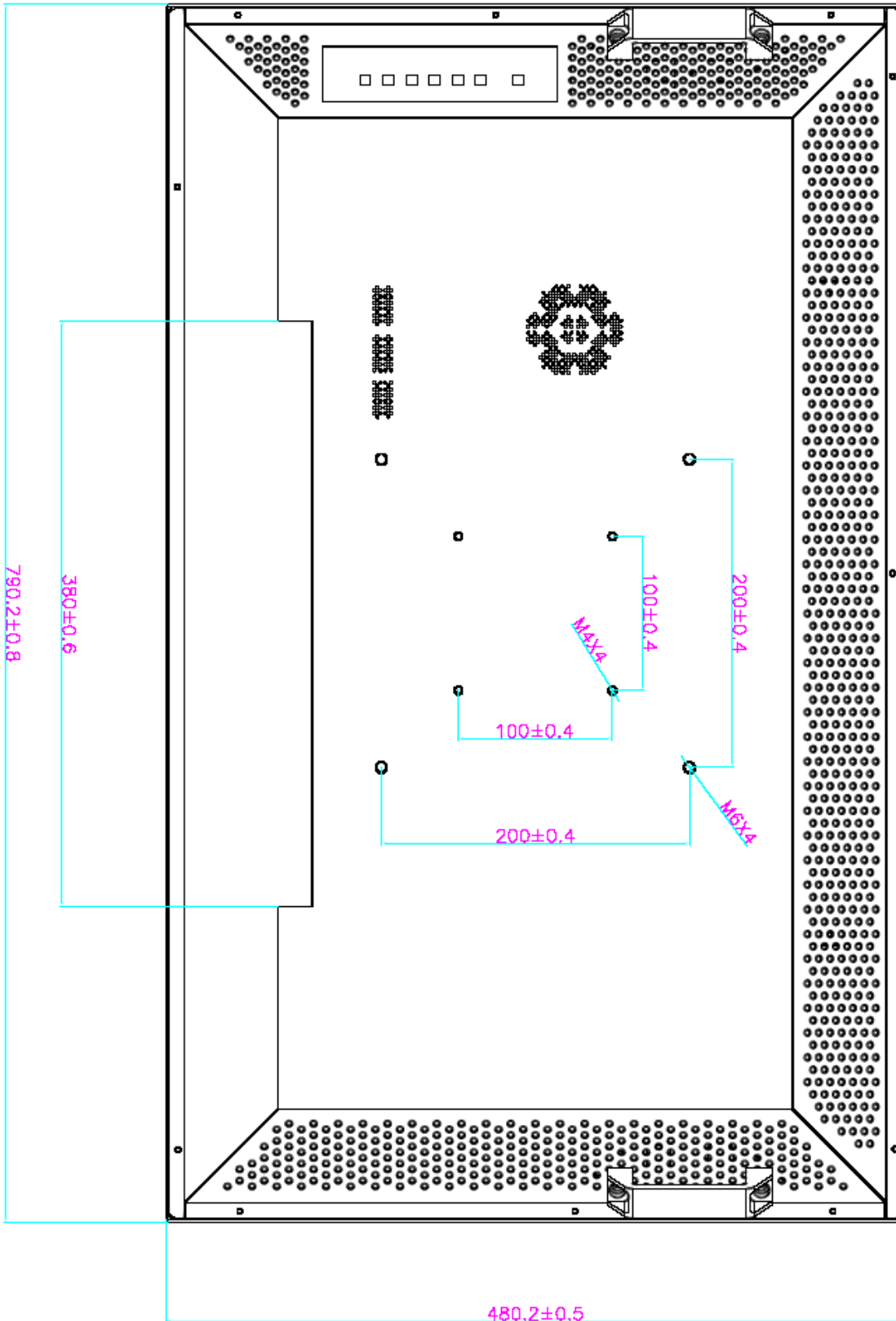

Power On/Off

Before turn on, wire all the cable connecting to auxiliary equipment, external speakers, power cord, etc. There are two controls for power, Main power switch and POWER (standby / on) button.

■ Main power switch

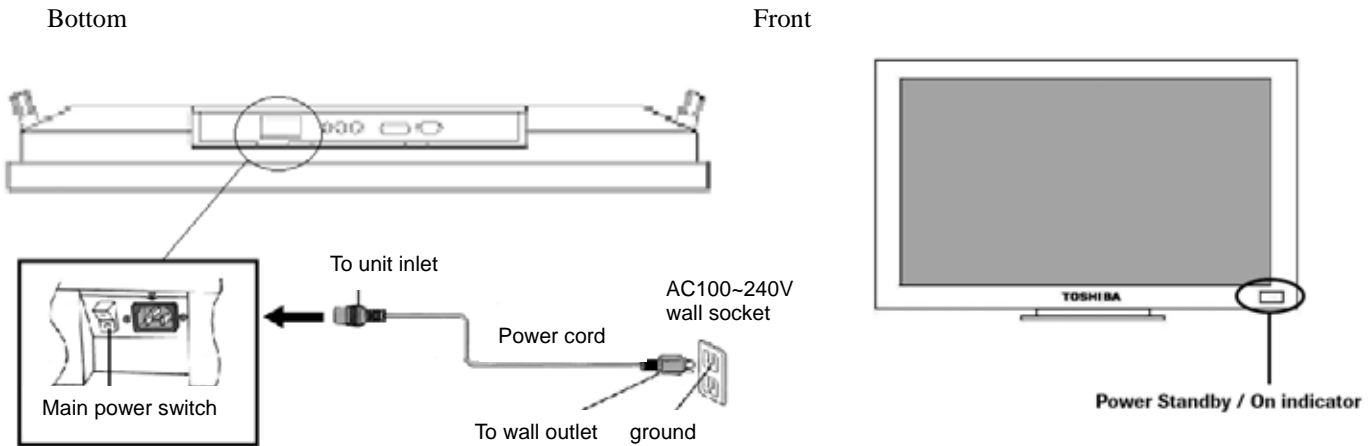

Mode	Standby	Power on
LED indicator	Orange	Green

If Main power switch is not On, you cannot turn on the unit by the POWER (Standby / On) button.

■ POWER button on the remote control (Option)

About the control by the POWER button on the unit side on, refer to page 12.

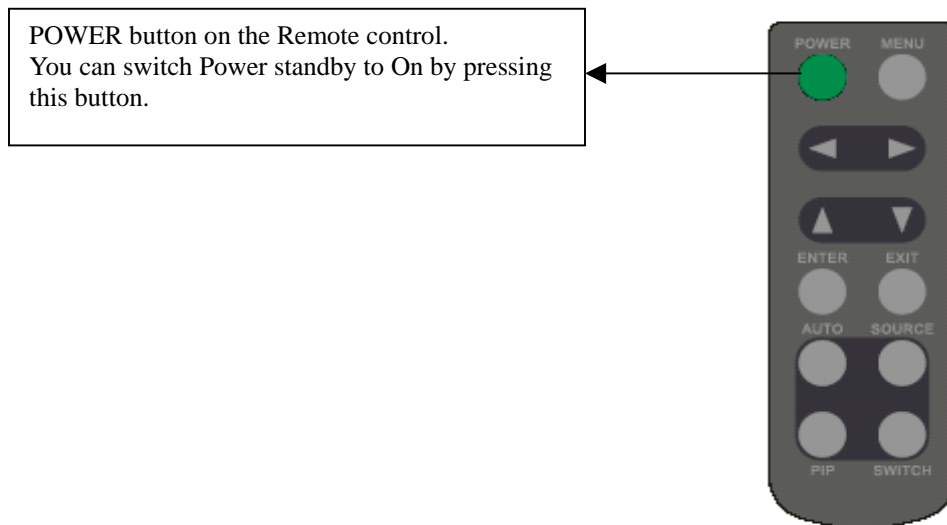

Menu Function

Display Menu, you can adjust pictures and sound or set various functions with the buttons on the remote control. The following are summary of Menu Function. For details, please see to refer pages.

■ Function of each button

Side of the unit

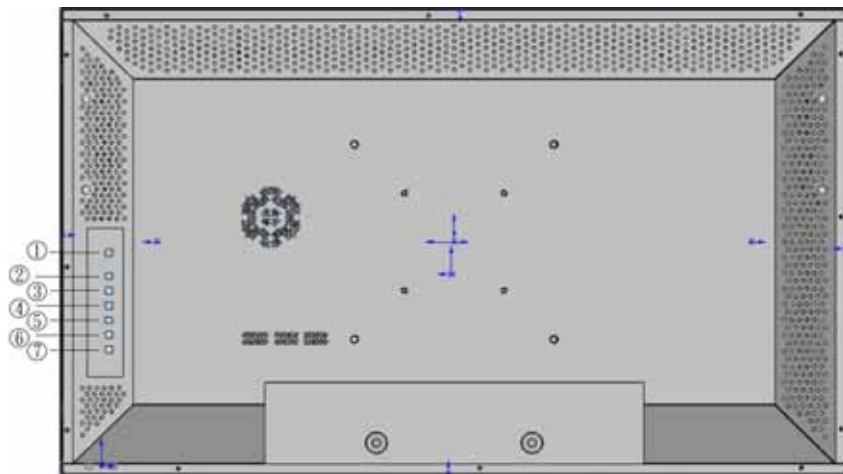

Remote control (option)



Side of the unit:

No.	Key	Descriptions
1	Power	Power on / Power off
2	Enter	Activate selection
3	▷/+	Menu Right / Volume Increase
4	◁/-	Menu Left / Volume Decrease
5		Menu Down
6		Menu Up
7	Menu / Exit	OSD control Menu button / Access Main / Sub-menu / Quick Menu Selection

Remote control

No.	Key	Descriptions
1	Power	Power on / Power off
2	Auto	Adjust clock, phase, H position and V position Automatically
3	Source	Input source selection
4	PIP	Picture in picture
5	Switch	PIP picture switch
6	Enter	Activate selection
7	Menu	OSD control menu button / Access Main / Sub-menu / Quick menu selection
8	Exit	One Level up
9		Menu Up
10		Menu Down
11	◁	Menu Left
12	▷	Menu Right

■ OSD lock/unlock control:

1. Use control push buttons at side:

Lock: Press (▷/+) and () at the same time and OSD will be locked.

Unlock: Press (▷/+) and () at the same time again and OSD will be unlocked.

2. Use remote controller:

Lock: Press Enter, Enter, Exit, Exit, Enter and Exit on the controller by sequence and OSD will be locked.

Unlock: Press Enter, Enter, Exit, Exit, Enter and Exit on the controller by sequence again and OSD will be unlocked

■ Menu display chart

MAIN MENU

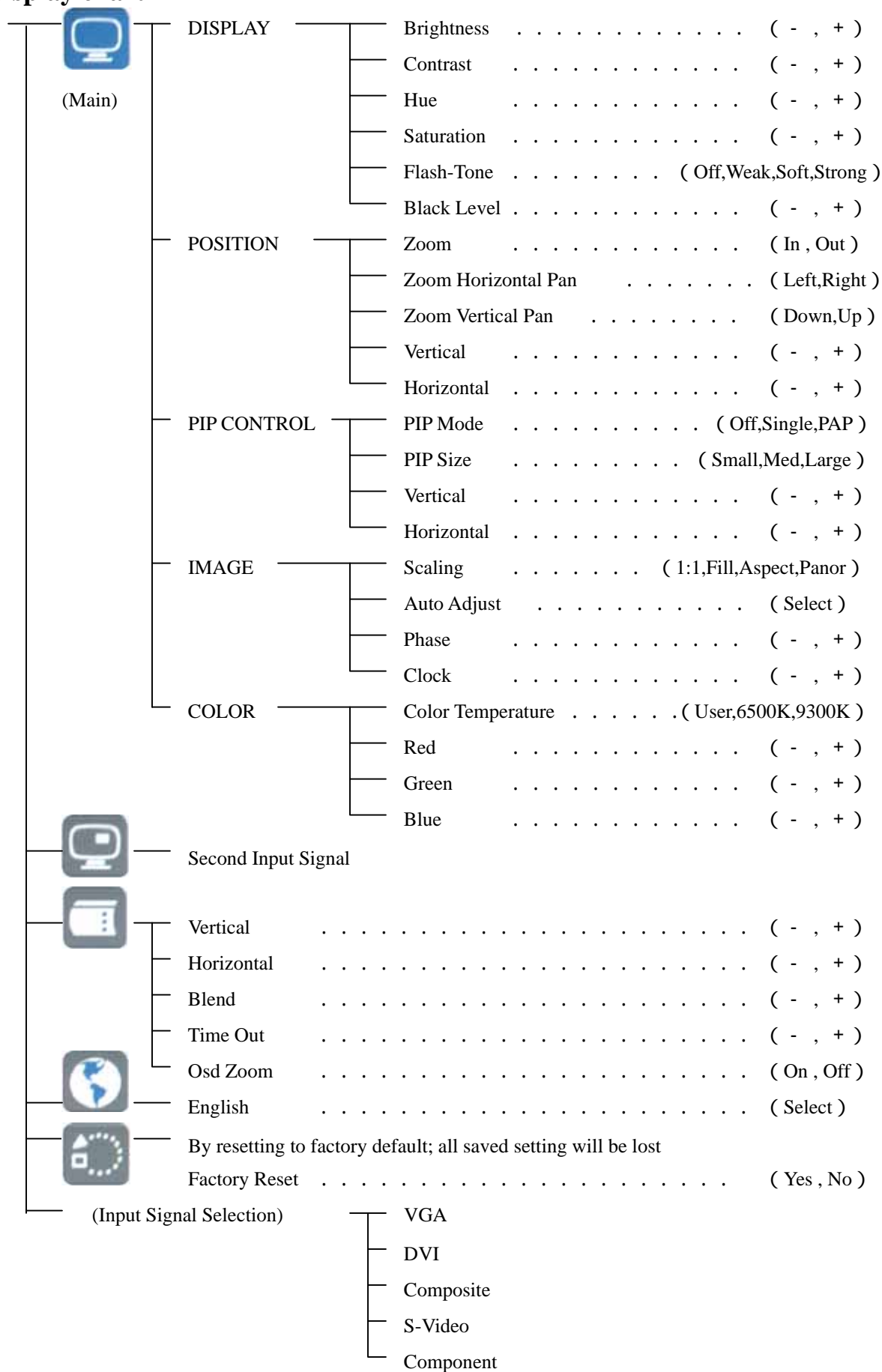

■ Factory default setting

Item	Default
Power switch	Off
Brightness	80
Contrast	50
Color temp.	User
Red	50
Green	50
Blue	50
Language	English
Auto Configuration	On

Input Signal

Input signal Format for RGB DVI input signal (Timing)

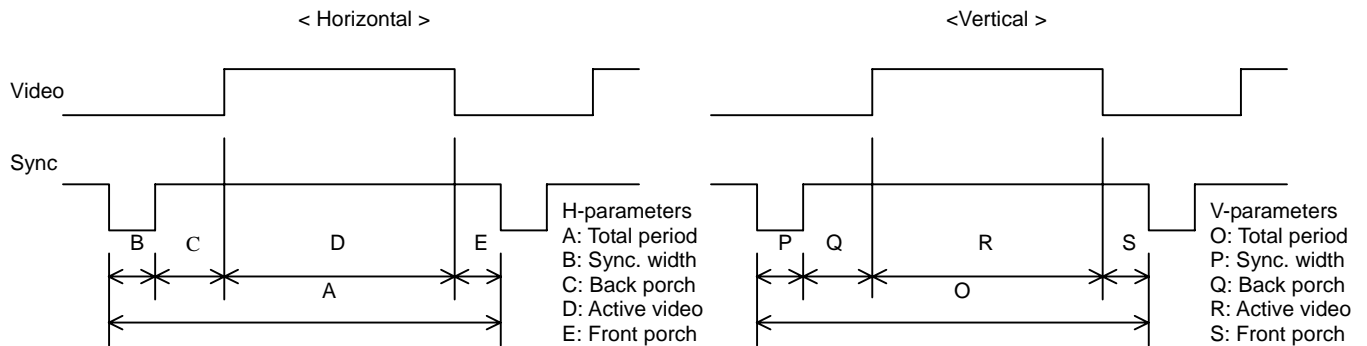

Item	Video Mode		fH (kHz)	fV (Hz)	Dot clock (MHz)	Sync polarity		Horizontal (dot)					Vertical (line)					Analog	Digital (Optional)
						H	V	A	B	C	D	E	O	P	Q	R	S		
1	VESA	VGA 640x480	31.469	59.940	25.175	N	N	800	96	48	640	16	526	2	33	480	11	O	O
2			37.861	72.809	31.500	N	N	832	40	128	640	24	520	3	28	480	9	O	O
3			37.500	75.000	31.500	N	N	840	64	120	640	16	500	3	16	480	1	O	O
4		SVGA 800x600	35.156	56.250	36.000	P	P	1024	72	128	800	24	625	2	22	600	1	O	-
5			37.879	60.317	40.000	P	P	1056	128	88	800	40	628	4	23	600	1	O	O
6			48.077	72.188	50.000	P	P	1040	120	64	800	56	666	6	23	600	37	O	O
7		XGA 1024x768	46.875	75.000	49.500	P	P	1056	80	160	800	16	625	3	21	600	1	O	O
8			48.363	60.004	65.000	N	N	1344	136	160	1024	24	806	6	29	768	3	O	O
9			56.476	70.069	75.000	N	N	1328	136	144	1024	24	806	6	29	768	3	O	O
10		SXGA	1280x1024	60.023	75.029	78.750	P	P	1312	96	176	1024	16	800	3	28	768	1	O
11	67.500			75.000	108.000	P	P	1600	128	256	1152	64	900	3	32	864	1	O	O
12	63.981			60.020	108.000	P	P	1688	112	248	1280	48	1066	3	38	1024	1	O	O
13	VGA TEXT	720x400	79.976	75.025	135.000	P	P	1688	144	248	1280	16	1066	3	38	1024	1	O	-
14			31.469	70.087	28.322	N	P	900	108	45	720	27	449	2	35	400	12	O	O
15			35.000	66.667	30.240	N	N	864	64	96	640	64	525	3	39	480	3	O	-
16	Macintosh	832x624	49.725	74.500	57.283	N	N	1152	64	224	832	32	667	3	39	624	1	O	-
17		1024x768	60.150	74.720	80.000	N	N	1330	96	168	1024	42	805	3	31	768	3	O	-

Item	Video Mode		fH (kHz)	fV (Hz)	Dot Clock (MHz)
18	NTSC	NTSC 358-443	15.734	59.94	16.521
19	PAL	PAL SECAM	15.625	50.00	16.406

A Guide to Simple Problem Solving

Before calling service personnel, please check the following chart for a possible cause to the trouble you are experiencing.

Symptom	Check these things	Page
No picture	. Make sure the power cord is plugged in.	18
	. Maybe the power is Off or Standby.	26
	. Check whether the auxiliary equipment is connected.	17
	. Check the input setting is correct.	27,28
	. Signal may not be suitable.	28
The remote control does not operate	. Make sure the batteries are inserted matching the + and – marks of the battery compartment.	15
	. The batteries may be exhausted.	
	. Use the remote control aiming at the remote control sensor.	
The picture color is pale, or not clear	. Check the picture quality adjustment.	28
	. If you are using YUV terminals, make sure cables are correctly connected.	17

■ For inquiries and repair

Please refer to the shop you bought the unit for repair and inquiries.

Note

USER-INSTALLER CAUTION

YOUR AUTHORITY TO OPERATE THIS FCC CERTIFIED EQUIPMENT COULD BE VOIDED IF YOU MAKE CHANGES OR MODIFICATIONS NOT EXPRESSLY APPROVED BY THIS PART RESPONSIBLE FOR COMPLIANCE TO PART 15 OF THE FCC RULES.

NOTE:

This equipment has been tested and found to comply with the limits for a Class A digital device, pursuant to part 15 of the FCC rules. These limits are designed to provide reasonable protection against harmful interference when the equipment is operated in a commercial environment.

This equipment generates, uses, and can radiate radio frequency energy and, if not installed and used in accordance with the instruction manual, may cause harmful interference to radio communications. Operation of this equipment in a residential area is likely to cause harmful interference in which case the user will be required to correct the interference at his own expense.



It may be against copyright regulation to broadcast commercial video software or unit programs for commercial purpose using this product, or to rewrite such software or programs with wipe-mirror function.

Please refer to a entitled party for approval in advance.



This is a Class A product. In a domestic environment this product may cause radio interference in which case the user may be required to take adequate measures.

Annex

Suggested text for the notice indicating compliance with this Standard:

This Class A digital apparatus complies with Canadian ICES-003.

Cet appareil numerique de la classe A est conforme a la norme NMB-003 du Canada.

About trademarks

VGA, SVGA, XGA and SXGA are trademarks or registered trademarks of International Business Machine Corporation.

TOSHIBA LIGHTING & TECHNOLOGY CORPORATION

Free Manuals Download Website

<http://myh66.com>

<http://usermanuals.us>

<http://www.somanuals.com>

<http://www.4manuals.cc>

<http://www.manual-lib.com>

<http://www.404manual.com>

<http://www.luxmanual.com>

<http://aubethermostatmanual.com>

Golf course search by state

<http://golfingnear.com>

Email search by domain

<http://emailbydomain.com>

Auto manuals search

<http://auto.somanuals.com>

TV manuals search

<http://tv.somanuals.com>