

900MHz DIGITAL SPREAD SPECTRUM CORDLESS TELEPHONE
DIGITAL ANSWERING SYSTEM

SX-2981



The **FIRST** thing to do after unpacking your new cordless telephone is:

CHARGE THE BATTERY !

Please read and follow the few instructions on

PAGE 2

BEFORE YOU DO ANYTHING ELSE.

GETTING STARTED: DO THIS FIRST!

FIRST, CHARGE THE HANDSET BATTERY!

- **Set your new phone in an out-of-the-way place near a power outlet where it will not be disturbed.**
- Plug the AC adaptor into the wall outlet.
- Plug the AC adaptor cord into the power jack on the base unit.
- Take the cover off the handset battery compartment; plug the battery connector into the receptacle inside the battery compartment and replace the cover. The connector only goes in one way.
- Place the handset into the base unit's charging cradle. The CHARGE LED should light. If not, see TROUBLESHOOTING, page 48.
- The battery charging period has now started. From now until the 12~16 hours period is complete, do not let anything cause the handset to be removed from electrical contact with the base unit's charging pins or power to be removed from the base unit.

SECOND,

- **Before you can take advantage of the Caller ID and Call Waiting features, you must subscribe to these services from your local telephone company.**
- Name and number caller ID only work in conjunction with service provided by your local telephone company.

THIRD, Enter your AREA CODE, see page 16

INTRODUCTION

FEATURES

Toshiba America Consumer Products, Inc., takes pride in presenting the new 900 MHz cordless telephone and digital answering system. The Toshiba cordless telephone features a 16-digit x 3-line dot matrix liquid crystal display (LCD) for caller ID on Call Waiting and speed dial programming and calling. The sleek new design provides face-up battery charging even when wall mounted. Other features are summarized below.

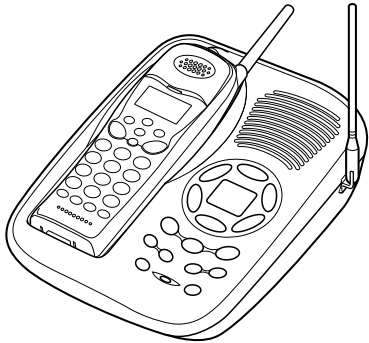

- 900 MHz Digital Spread Spectrum Transmission with Extended Talk Range
- 20 Channel Auto Scanning
- All Digital Recording System (Approx. 15 min. Recording Time)
- 50 Name & Number Caller ID
- Digital Duplex Speakerphone
- Digital Call Protect Privacy Scrambling and Digital Security Code
- Advanced Message Management Design
- Voice Guidance/Time Stamp
- Long Standby Battery Life (10 days)
- 3-Way Conversation
- One Way Page/Handset Locator
- Last Number Redial (32 digits)
- 20 Speed-dial numbers (20 digits)
- Any-Key Answer
- Reversible Charging System
- Hearing Aid Compatible/HAC Volume
- Desk/Wall Mountable
- Headset Jack
- 3 Mailboxes
- Custom Greeting Message/Pre-Recorded Greeting Message
- Memo Recording
- Caller ID on Call Waiting
- Backlit 3-Line Alphanumeric LCD Display
- Volume Control (4 Level)
- Ringer Volume and Tone Control

TABLE OF CONTENTS

Preparation

INTRODUCTION	3
Features	3
IMPORTANT SAFETY INSTRUCTIONS	6
LOCATION OF CONTROLS	8
Handset	8
Base unit	9
INSTALLATION	10
Setting up the base unit (Desk top mounting)	10
AC adaptor information	10
Setting up the base unit (wall mounting)	11
Wall mount template	11
Charging the battery pack	12
Setting the dial mode	14
Setting or canceling the Auto Talk function	15
Setting or canceling caller ID on call waiting	15
Setting the area code	16
Using a handset (optional)	17

Basics

BASIC OPERATION	18
Making a call	18
Receiving a call	18
3-number redial	19
Out of range	19
Handset earpiece volume setting	19
Handset ringer volume setting	19
Ringer off	19
Tone/Pause	20
Interference or static	20
Base speakerphone	20
Switching from the speakerphone to the handset	20
Base speaker volume setting	21
3-way conversation	21
Paging the handset	21
MEMORY DIALING	22
Storing numbers	22
Steps for entering names and special characters	24
If you make a mistake while entering a name	25

TABLE OF CONTENTS

Dialing a stored number25
Editing and deleting stored numbers26

Caller ID/Call waiting

CALLER ID/CALL WAITING28
Answering a call with caller ID service28
Searching caller ID memory29
Calling back from the caller ID list29
Editing caller ID data30
Transferring CID number to speed-dial memory30
Deleting caller ID data31
Call Waiting33
Call Waiting options34

Answering system

USING THE MENU MODE36
Recording the greeting message37
Changing the greeting message37
Setting the clock38
Setting the security code (PIN)39
Setting the base ringer volume39
Setting the number of rings40
Setting the recording time40
USING THE ANSWERING MACHINE41
Turning the answering machine ON & OFF41
Playing recorded messages42
Deleting recorded messages43
Screening incoming calls43
Leaving a memo in the designated mailbox44
Using the mailbox from the remote location44
Recording a phone conversation (2 WAY REC)45
Calling in from a remote location46
Table of commands47

Additional Information

TROUBLESHOOTING48
WARRANTY/SERVICE51
REMOTE OPERATION CARDS53

IMPORTANT SAFETY INSTRUCTIONS

When using your telephone equipment, basic safety precautions should always be followed to reduce the risk of fire, electric shock and injury.

- 1 Read and understand all instructions.
- 2 Follow all warnings and instructions marked on the product.
- 3 Unplug this product from the wall outlet before cleaning. Do not use liquid cleaners or aerosol cleaners. Use a dry cloth for cleaning.
- 4 Do not use this product near water sources, such as bath tubs, wash bowls, kitchen sinks, laundry tubs, wet basements, or swimming pools.
- 5 Do not place this product on an unstable cart, stand, or table. The telephone may fall, causing serious damage to the telephone.
- 6 Slots and openings in the cabinet and the back or bottom are provided for ventilation. To protect it from overheating, these openings must not be blocked or covered. The openings should never be blocked by placing the product on a bed, sofa, rug, or other similar surface. This product should never be placed near or over a radiator or heat register. This product should not be placed in a built-in installation unless proper ventilation is provided.
- 7 Do not allow anything to rest on the power cord. Do not locate this product where the cord can be stepped on or tripped over.
- 8 Do not overload wall outlets and extension cords as this can result in the risk of fire or electric shock.
- 9 Never push objects of any kind into this product through cabinet slots as they may touch dangerous voltage points or short out parts that could result in a risk of fire or electric shock. Never spill liquid of any kind on the product.
- 10 Do not disassemble this product. Opening or removing covers puts you at risk of electrical shock, and incorrect reassembly can cause shocks, sparks or other damage during subsequent use.
- 11 Take this product to a qualified service technician under any of the following conditions:
 - A. When the power supply cord is damaged or frayed.
 - B. If liquid has been spilled into the product.
 - C. If the product has been exposed to rain or water.
 - D. If the product does not operate normally according to the operating instructions. Adjust only those controls covered by this manual. Improper adjustment of other controls may result in serious damage to the unit or your home.
 - E. If the product has been dropped or the cabinet has been damaged.
 - F. If the product exhibits a distinct change in performance.
- 12 Do not use the telephone in the vicinity of a gas leak.

IMPORTANT SAFETY INSTRUCTIONS

The RBRC™ Seal



The RBRC™ Seal on the (easily removable) nickel-cadmium battery (contained in our product) indicates that Toshiba America Consumer Products, Inc. (TACP) is voluntarily participating in an industry program to collect and recycle these batteries at the end of their useful lives, when taken out of service within the United States. The RBRC™ program provides a convenient alternative to placing used nickel-cadmium batteries into the trash or municipal waste, which is illegal in some areas. TACP's payments to RBRC™ make it easy for you to drop off the spent battery at local retailers of replacement nickel-cadmium batteries, or at authorized TACP product service centers. You may also contact your local recycling center for information on where to return the spent battery. Please call 1-800-8-BATTER for information on Ni-Cd battery recycling in your area. TACP's involvement in this program is part of its commitment to protecting our environment and conserving natural resources. RBRC™ is a trademark of Rechargeable Battery Recycling Corporation.

CAUTION: TO REDUCE THE RISK OF FIRE OR INJURY TO PERSONS BY THE BATTERY, READ AND FOLLOW THESE INSTRUCTIONS.

BATTERIES

- 1 Use only the appropriate type and size battery pack specified in the instruction manual provided for this product.
- 2 Do not dispose of the battery pack in a fire. The cell may explode. Check with State and local codes for possible special disposal instructions.
- 3 Do not open or mutilate the battery pack. Released electrolytes are corrosive and may cause damage to the eyes or skin. It may be toxic if swallowed.
- 4 Exercise care in handling the batteries. Contact with conductive materials such as rings, bracelets and keys may cause the battery to short out, resulting in overheating which could burn.
- 5 Charge the battery pack provided with or identified for use with this product only in accordance with the instructions and limitations specified in the instruction manual provided for this product.
- 6 Observe proper polarity orientation between the battery pack and the battery charger.

ATTENTION: THE PRODUCT THAT YOU HAVE PURCHASED CONTAINS A RECHARGEABLE BATTERY. UNDER VARIOUS STATE AND LOCAL LAWS, IT MAY BE ILLEGAL TO DISPOSE OF THIS BATTERY INTO THE MUNICIPAL WASTE STREAM. PLEASE CHECK WITH YOUR LOCAL GOVERNMENT FOR DETAILS IN YOUR AREA REGARDING RECYCLING OPTIONS OR PROPER DISPOSAL.

SAVE THESE INSTRUCTIONS

TO HELP PROTECT THE ENVIRONMENT, THIS PRODUCT MAY CONTAIN RECYCLED OR RECONDITIONED PARTS AND MATERIALS.

LOCATION OF CONTROLS

HANDSET

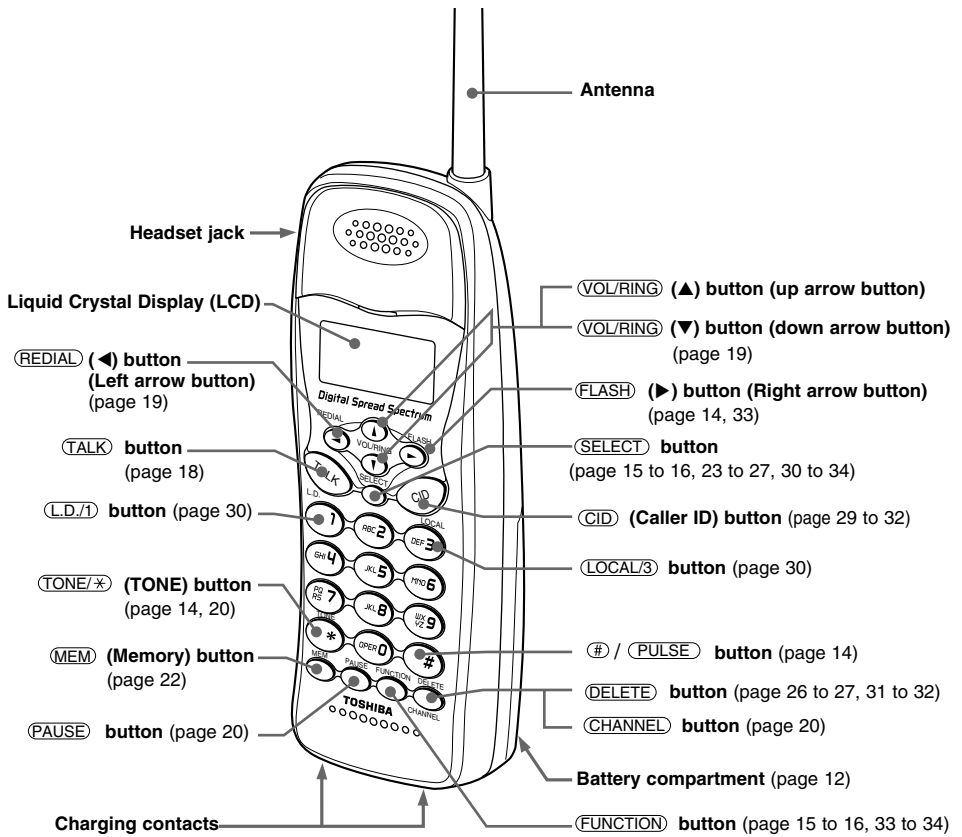

SUPPLIED ACCESSORIES:

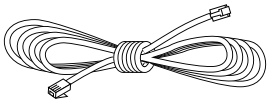

Modular Line Cord
Part # RC008231

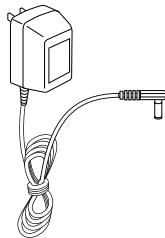

AC Adaptor
TAC-2981
Part # RC009792

LOCATION OF CONTROLS

BASE UNIT

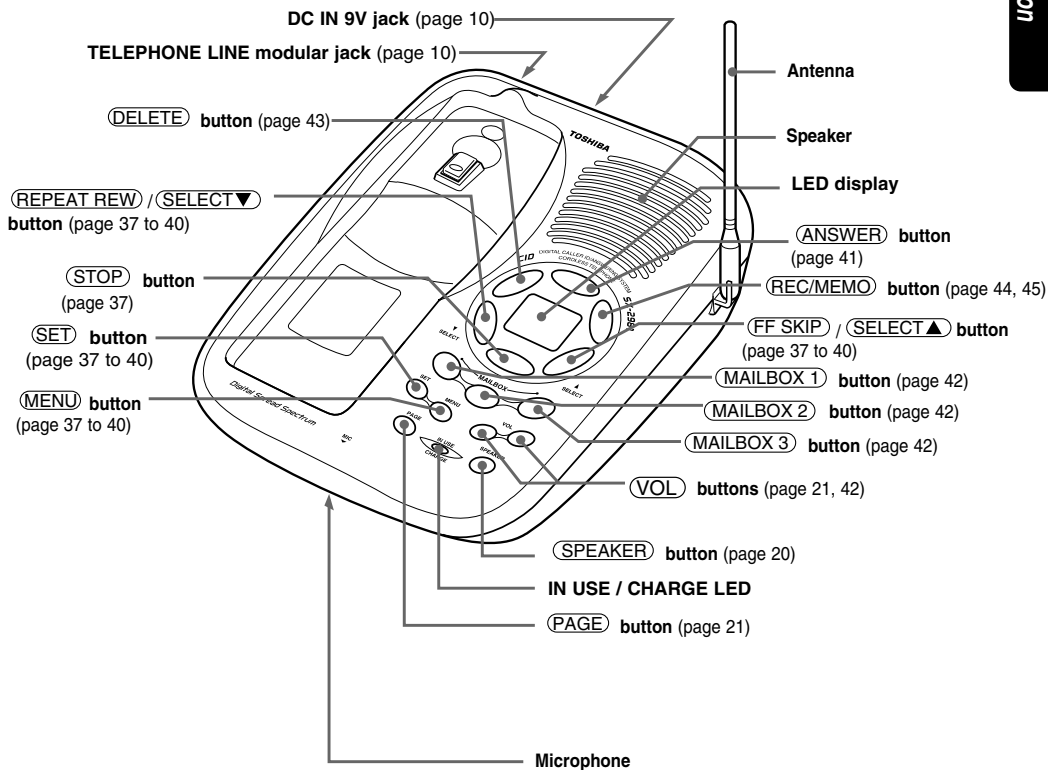

For purchase of accessories, please call 1-877-644-7373.

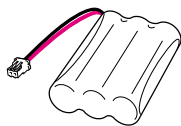

Owner's manual
Part # RC009812

Rechargeable Battery Pack
Toshiba TRB-8000
Part # RC004931

Quick Reference Guide
Part # RC009813

INSTALLATION

SETTING UP THE BASE UNIT (DESK TOP MOUNTING)

For setting up the base unit follow the instructions below.

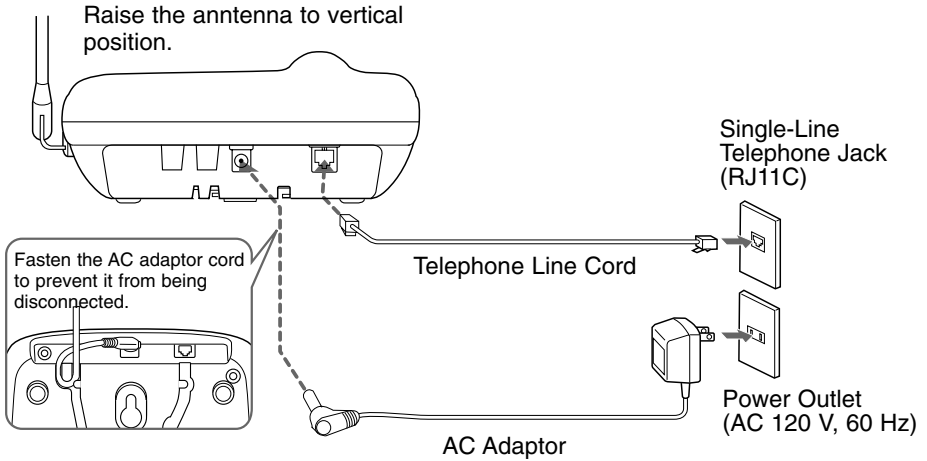

- Plug the AC adaptor firmly into the base unit and the AC 120V outlet.
- USE ONLY WITH Supplied AC ADAPTOR (TAC-2981 power source AC 120V 60Hz/DC9V).
- Connect the AC adapter to a continuous power supply.

AC ADAPTOR INFORMATION

Use only the supplied AC adaptor, or one matching its specifications exactly with this product. Incorrect voltage may damage the unit or cause it to function improperly.

TOSHIBA
AC ADAPTOR
MODEL NO.: TAC-2981

INPUT : AC 120V 60Hz 7W
OUTPUT : DC 9V 350mA

⊖ ⊕

3509035003CT

UL 12J2
US E82456
LISTED

CLASS 2 POWER SUPPLY
FOR USE WITH TELEPHONES

TOSHIBA AMERICA
CONSUMER PRODUCTS, INC.
F4
MADE IN CHINA

SETTING UP THE BASE UNIT (WALL MOUNTING)

MOUNTING ON A STANDARD WALL PLATE:

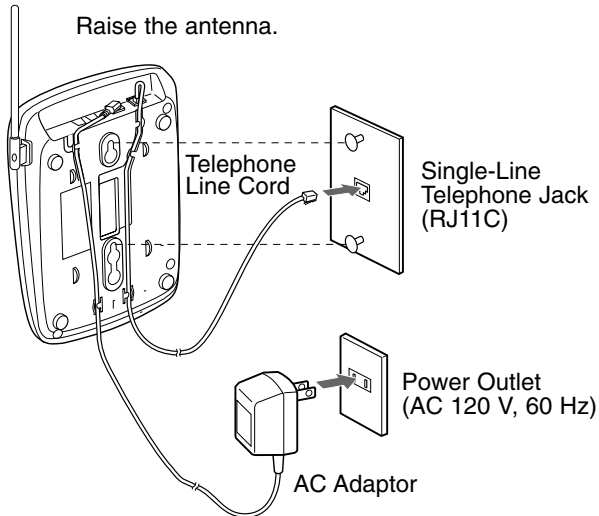

- Route the cords through the guides.
- Place the base unit on the posts of the wall plate and push down until it is firmly seated.

NOTES:

- **Do not use any outlet controlled by a wall switch.**
- **If you don't have a standard wall plate, cut out the template on this page and use it to position two screws (minimum length of 1 $\frac{3}{8}$ inches) into the wall with the heads protruding about $\frac{1}{4}$ inch.**

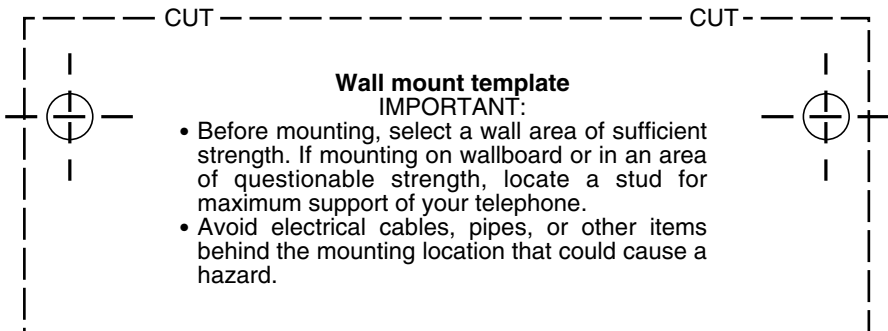

INSTALLATION

CHARGING THE BATTERY PACK

It is important to charge the battery for 12-16 hours continuously without any interruption before you use the handset for the first time.

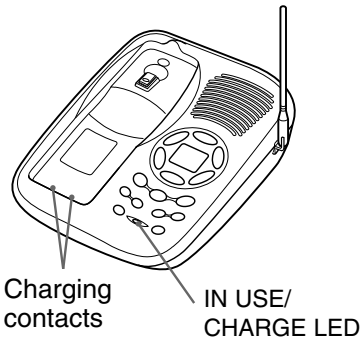
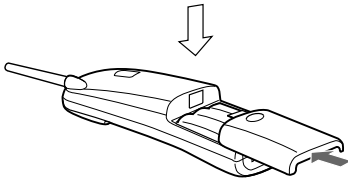
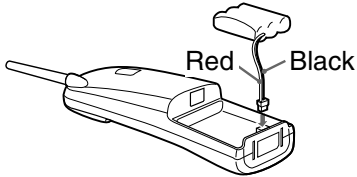

- 1** Remove the battery cover on the back of the handset by sliding it down.
- 2** Plug the battery pack cord into the connector with the correct polarity. (black and red wires).
- 3** Place the battery pack in the battery compartment.
- 4** Put the battery cover back by sliding until it snaps into place. Make sure not to get the wires of the battery pack caught in the cover.
- 5** Place the handset on the base unit. Be sure the IN USE/CHARGE LED lights. If the IN USE/CHARGE LED does not light, make sure the AC adaptor is plugged in securely.

INSTALLATION

NOTES:

- *Use only the supplied battery pack (TRB-8000 power source 600mAh, 3.6VDC)*
- *The battery pack is not charged properly if the charging contacts are dirty or tarnished. Clean the contacts occasionally with a dry cloth.*

After the battery pack is fully charged;

Operation	Approx. battery life
While in use (Talk mode)	up to 6 hours
While not in use (Standby mode)	up to 10 days

When "Low Battery" blinks on the LCD, all handset buttons are disabled and the battery needs to be charged. If this occurs during a call, you hear short beeps. Finish the call as soon as possible and place the handset on the base unit.



NOTES:

- *If a call comes in when the battery is too low to operate properly, you will be unable to answer the call or the call will be disconnected.*
- *The redial memory numbers backup for up to 2 minutes while you replace the battery pack.*
- *If you must replace the battery pack during a telephone call, complete the replacement of the battery pack within 30 seconds, and you can return to the original call.*

INSTALLATION

Before using the Handset, make sure to read the following instructions.

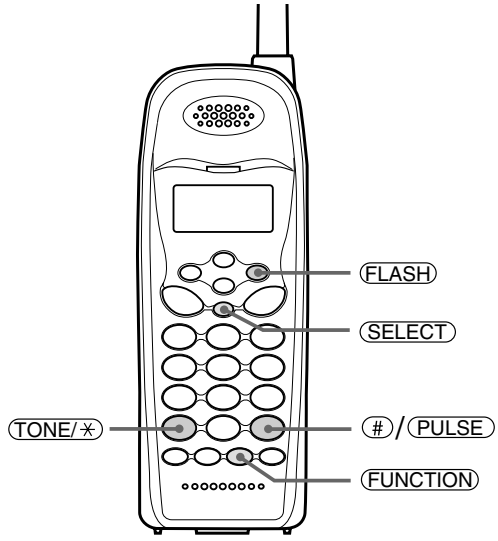

SETTING THE DIAL MODE

Depending on your dialing system, set the mode as follows:

1 Press and hold **FLASH** until you hear a confirmation tone.

2 To set the dial mode for pulse dialing, press **#/PULSE**. Or to set the dial mode for tone dialing press **TONE/***. A confirmation tone sounds to indicate the setting is complete.

Dial Mode:Pulse
Tone - Press *
Pulse - Press #

Dial Mode:Tone
Tone - Press *
Pulse - Press #

TONE/* ↓
Tone Dialing

#/PULSE ↓
Pulse Dialing

SETTING OR CANCELING THE AUTO TALK FUNCTION

If the handset is placed on the base unit, you can answer a call by lifting the handset from the base unit (Auto Talk). If the handset is not on the base unit, you can answer a call by pressing any one of the buttons (Any-key Answer function). When the Auto Talk function is set to ON, the Any-key Answer function is also set to ON.

When the Auto Talk function is set to OFF, you can lift the handset and view the caller ID information before taking the call. This function is factory preset to OFF.

1 Press **(FUNCTION)**. The LCD displays the current setting.

```
1▶Auto Talk:Off
2 CIDCW      :On
3 Area Code:
```

2 Press **(SELECT)**. Each time you press **(SELECT)**, the On/Off setting will be switched.

3 Press **(FUNCTION)**. The handset returns to standby mode.

```
1▶Auto Talk:On
2 CIDCW      :On
3 Area Code:
```

SETTING OR CANCELING CALLER ID ON CALL WAITING

This function is preset to ON so that you will receive caller ID on Call Waiting when you subscribe to both local telephone company services.

When you set this function to Opt, you can use any of the six pre-programmed Call Waiting Options (See page 34 "Call Waiting Options").

If you do not subscribe to these services, be sure to set this function to OFF.

1 Press **(FUNCTION)**. The LCD displays the current setting.

```
1▶Auto Talk:Off
2 CIDCW      :On
3 Area Code:615
```

2 Press **(▼)** or **(②)** to move the pointer to CIDCW and press **(SELECT)**. Each time you press **(SELECT)**, the On/Off/Opt setting will be switched.

```
1 Auto Talk:Off
2▶CIDCW      :On
3 Area Code:615
```

3 Press **(FUNCTION)** and replace the handset on the base unit.

INSTALLATION

SETTING THE AREA CODE

It is necessary to program your area code so that local calls will be displayed properly on caller ID.

1 Press **(FUNCTION)**.

```
1▶Auto Talk:Off
2 CIDCW      :0n
3 Area Code:
```

2 Press **(▼)** or **(3)** to move the pointer to Area Code.

```
1 Auto Talk:Off
2 CIDCW      :0n
3▶Area Code:
```

3 Press **(SELECT)**.

```
1 Auto Talk:Off
2 CIDCW      :0n
3 Area Code:615
```

Enter a 3-digit area code. For example, enter "615."
If you enter a wrong number, press **(DELETE)**.

4 Press **(SELECT)**.

```
1 Auto Talk:Off
2 CIDCW      :0n
3▶Area Code:615
```

Confirmation tone sounds.

5 Press **(FUNCTION)**.

The handset returns to the standby mode.

NOTES:

- *Change your area code when you move to another location that has a different area code.*
- *When you make a call or redial to a number within your area code, only the last 7 digits of the phone number are dialed when you set the area code.*
- *During call-back, however, the phone will include the area code from where the call originated when it automatically redials the number. To avoid this problem, always be sure to set the area code of your phone so that the phone will automatically exclude the area code when the incoming code is the same as that of the phone.*

USING A HEADSET (OPTIONAL)

You can use an optional headset (part#: RC 008260) that has a 3/32-inch (2.5mm) plug.

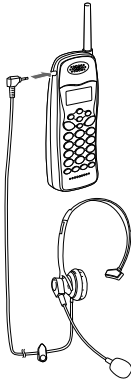

To connect the headset, open the rubber cover on the left side of the handset, then insert the headset's plug into the jack.

With a headset connected, you can make or answer calls as usual using the keys on the handset.

When you finish using the headset, disconnect it from the handset and close the rubber cover to protect the jack.

NOTES:

- *The handset's earspeaker and microphone are turned off with a headset connected.*
- *Pressing the **VOL/RING** (**▲, ▼**) button of the handset also controls the connected headset's volume.*
- *If you place the handset on the base unit while the headset is connected, be sure the handset is placed properly.*

BASIC OPERATION

Before using the Handset, make sure to read the following instructions.

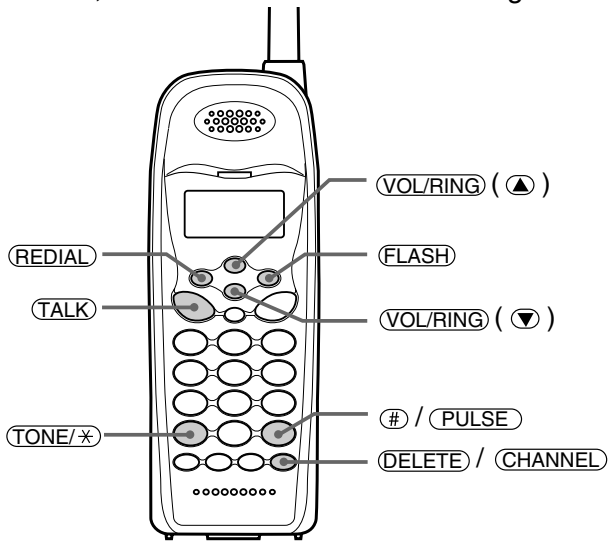

MAKING A CALL

Handset On The Base	Handset Off The Base
<ol style="list-style-type: none"> 1) Pick up the handset. 2) Press TALK. 3) Listen for the dial tone. 4) Dial the number. <p style="text-align: center;">OR</p> <ol style="list-style-type: none"> 1) Pick up the handset. 2) Dial the number, then press TALK. 	<ol style="list-style-type: none"> 1) Press TALK. 2) Listen for the dial tone. 3) Dial the number. <p style="text-align: center;">OR</p> <p>Dial the number, then press TALK.</p>
<p>To hang up: Press TALK, or return the handset to the base (Auto Standby).</p>	

NOTE:

To delete a wrong number, press or **◀**, **▶** and **DELETE**. To delete all numbers, press and hold **DELETE**.

RECEIVING A CALL

Handset On The Base	Handset Off The Base
<p>Pick up the handset (Auto Talk) or press TALK. To use the Auto TALK function, see page15.</p>	<p>Press any button (When the Auto Talk is set to on) or press TALK.</p>
<p>To hang up: Press TALK, or return the handset to the base (Auto Standby).</p>	

BASIC OPERATION

3-NUMBER REDIAL

You can redial any of the last three numbers dialed from the **handset**:

- 1** Press **(REDIAL)** in standby mode. The last dialed number (Redial 1) appears.
Each time you press **(REDIAL)**, the LCD displays one of the three last dialed numbers (Redial 1 to Redial 3).
- 2** After the desired number has been selected, press **(TALK)**. The call will be connected.

NOTES:

- *The handset redials only up to 32 digits even for a number that exceeds this limit.*
- *When you press **(REDIAL)** after pressing **(TALK)** or **(FLASH)**, the latest dialed number will be dialed automatically.*

OUT OF RANGE

During a call, as you begin to move too far from the base unit, the noise increases. Then, you should move close to the base unit. If you travel out-of-range, your call terminates. (See page 20 “Interference or static”).

HANDSET EARPIECE VOLUME SETTING

To adjust the earpiece volume, press **(VOL/RING)** (**(▼)** or **(▲)**) during a call.

HANDSET RINGER VOLUME SETTING

To adjust the ringer volume, press **(VOL/RING)** (**(▼)** or **(▲)**) during standby mode.

RINGER OFF

You can turn off the handset ringer.

During standby mode or when you set the ringer volume, press and hold **(VOL/RING)** (**(▼)**) till “Ringer Off” appears.

To resume the Ringer, press **(VOL/RING)** (**(▼)** or **(▲)**).

Ringer Off

BASIC OPERATION

TONE/PAUSE

To	Do this
To temporarily switch to tone dial (When the handset is set to pulse mode), see page 14.	Press (TONE/*) . The following numbers will be sent as tone dialing.
To enter a pause within the dialing sequence	Press (PAUSE) . "P" appears in the display which represents a pause.

EXAMPLE : To make a call "0 **(PAUSE)** 12345678" with tone dialing in pulse mode, press **(TONE/*)** **(0)** **(PAUSE)** **(1)** **(2)** **(3)** **(4)** **(5)** **(6)** **(7)** **(8)**.

INTERFERENCE OR STATIC

If you hear noise during a call, press **(CHANNEL)** to select another channel. The LCD displays "Scanning" while changing a channel.

Talk 0:15
Scanning

BASE SPEAKERPHONE

Press **(SPEAKER)**.

To hang up, press **(SPEAKER)**.

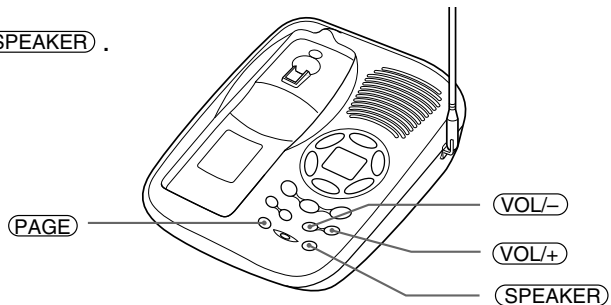

SWITCHING FROM THE SPEAKERPHONE TO THE HANDSET

To switch to the handset while you are using the base unit speakerphone, pick up the handset from the base unit. Then you can continue talking with the handset.

BASIC OPERATION

BASE SPEAKER VOLUME SETTING

To adjust the base unit speaker volume, press **(VOL+)** or **(VOL-)**.

3-WAY CONVERSATION

The phone permits 3-way conversation between the handset, base, and out side line.

WHEN SPEAKING ON THE HANDSET

- 1 Press **(SPEAKER)** on the base to join the 3-way conversation.
- 2 To hang up, press **(SPEAKER)** on the base. The handset will still be connected to the call.

WHEN SPEAKING ON THE BASE

- 1 Press **(TALK)** on the handset to join the 3-way conversation.
- 2 To hang up, return the handset to the base, or press **(TALK)** on the handset. The base will still be connected to the call.

NOTE:

*Pressing the **(SPEAKER)** on the base while dialing with the handset will set the 3-way conversation mode, and dialing is not affected.*

PAGING THE HANDSET

- 1 To locate the handset while it is off the base, press **(PAGE)**. The handset beeps for 60 seconds.

Paging

To stop paging, press **(PAGE)** or any key at the handset, or return the handset to the base unit.

NOTE:

You cannot page the handset during a call.

MEMORY DIALING

You can store up to 20 telephone numbers and their associated names in the memory.

NOTES:

- Always press a button within 20 seconds or the phone will return to standby.
- If you press a wrong button, an error tone sounds and the handset returns to standby mode.
- If you receive an incoming call or a pager call from the base unit during the operation, the operation will be cancelled.

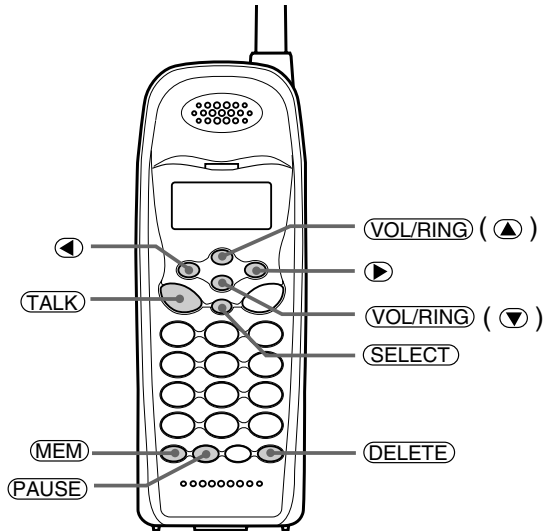

STORING NUMBERS

You can store up to 20 digits including #, *, and PAUSE as a telephone number, and up to 13 characters as a name in one memory address.

- 1 Pick up the handset and press and hold **MEM** till a beep sounds.

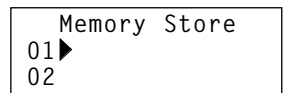

- 2 Enter a two-digit number (01-20), or press ▼, ▲ to select a free memory location number.

MEMORY DIALING

3 Press **(SELECT)**.

4 To enter a name, use the number keys.

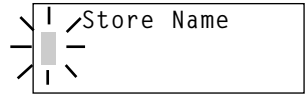

- See the steps for storing names and special characters. (see page 24)
- If a name is not required, go to step 5.

5 Press **(SELECT)**.

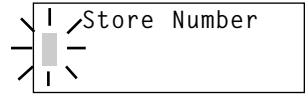

6 Enter a telephone number to be stored.

NOTES:

- **By pressing (PAUSE), you can insert a 2-second pause in the memory dial to make a long distance call or call through a PBX.**
- **If you make a mistake, press (RIGHT) or (LEFT) to move the cursor to the desired location.**
- **Press (DELETE) to delete characters as needed.**

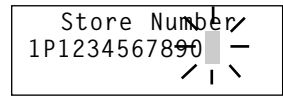

7 Press **(SELECT)**. A confirmation beep sounds and the number is stored.

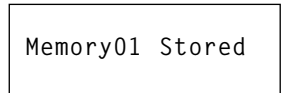

8 The LCD returns to Memory Store screen. To store more names and numbers, return to step 2. If you do not store a name, only the memory location <Memory01> appears.

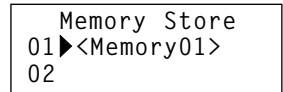

9 To finish the operation, press **(MEM)** or return the handset to the base unit.

MEMORY DIALING

STEPS FOR ENTERING NAMES AND SPECIAL CHARACTERS

Refer to the letters on the number buttons to select the desired letter. Each button selects a character as shown below.

Keys	Number of times key is pressed								
	1	2	3	4	5	6	7	8	9
1	1								
ABC 2	A	B	C	a	b	c	2		
DEF 3	D	E	F	d	e	f	3		
GHI 4	G	H	I	g	h	i	4		
JKL 5	J	K	L	j	k	l	5		
MNO 6	M	N	O	m	n	o	6		
PO RS 7	P	Q	R	S	p	q	r	s	7
TUV 8	T	U	V	t	u	v	8		
WX YZ 9	W	X	Y	Z	w	x	y	z	9
0	*	#	-	&	()	blank	0	

For example, to enter "Ted Doe" and 1 - 1 2 3 - 4 5 6 - 7 8 9 0

- 1 Pick up the handset and press and hold **(MEM)** until the confirmation tone sounds.
- 2 Enter a number or press **(▼)**, **(▲)** to select a free memory location number.
- 3 Press **(SELECT)**.
- 4 Press **(8)** once.
- 5 Press **(3)** five times then press **(▶)** to move the cursor to the right.
- 6 Press **(3)** four times then press **(▶)** twice to enter a space.
- 7 Press **(3)** once.
- 8 Press **(6)** six times.
- 9 Press **(3)** five times.

MEMORY DIALING

10 When finished, press **(SELECT)**.

11 Press **(1)** **(1)** **(2)** **(3)** **(4)** **(5)** **(6)** **(7)** **(8)** **(9)** **(0)** to be stored.

12 Press **(SELECT)**.

IF YOU MAKE A MISTAKE WHILE ENTERING A NAME

Use **(◀)** or **(▶)** to move the cursor to the incorrect character. Press **(DELETE)** to erase the wrong entry, then enter the correct character. To delete all characters, press and hold **(DELETE)**.

DIALING A STORED NUMBER

1 Pick up the handset and press **(MEM)**.

```
01▶Ted Doe
02 DOE JOHN
03 MOM AND DAD
```

2 Press **(▼)**, **(▲)** or enter a two-digit number (01-20) to display the desired destination.

NOTE:

*When you press **(SELECT)**, the LCD displays both the name and the telephone number.*

*When the stored phone number has 14 or more digits, **→** is displayed next to the 12th digit. Press **(▶)** to see the rest of the numbers, and **(◀)** to return.*

```
01▶1123456789012
02 011813554329→
03
```

3 Press **(TALK)**. The selected number will be dialed.

NOTE:

*If you press **(MEM)** while you are selecting a location, memory selection is cancelled and the handset returns to standby.*

MEMORY DIALING

EDITING AND DELETING STORED NUMBERS

You can delete a number or simply store another one in its place. When you store a new phone number, the data stored in that memory location is deleted automatically.

1 Pick up the handset and press and hold **(MEM)**. The confirmation tone sounds.

```
Memory Store
01▶Ted Doe
02 DOE JOHN
```

2 Enter a two-digit number (01-20) or press **(▼)**, **(▲)** to select the memory location you want to edit/delete.

3 Press **(SELECT)**.

```
▶Edit Memory01
Delete Memory01
Go Back
```

4 Press **(▼)** or **(▲)** to select the desired function and press **(SELECT)**. To edit the stored data, select “Edit Memory.” To delete the data, select “Delete Memory.” To return to the previous screen, select “Go Back.”

```
▶Edit Memory01
Delete Memory01
Go Back
```

5 To edit data, go to step **a**. To delete data, go to step **b**.

a EDITING THE NAME AND TELEPHONE NUMBER

Use the number buttons and **(◀)** or **(▶)** buttons to edit the name. (See “Storing Numbers” on page 22 for instructions on how to enter names).

(1) Press **(DELETE)** to erase a character at the cursor position. The next character on the right moves to the cursor position.

```
Store Name
Ted Dee | -
  / | \
```

(2) Press **(SELECT)**.

```
Store Number
1234567890 | -
  / | \
```

(3) Press **(DELETE)** to erase numbers, and enter the correct number.

(4) Press **(SELECT)**. A confirmation tone sounds and the number is stored. Press **(MEM)** or return the handset to the base unit.

```
Memory01 Stored
```

MEMORY DIALING

b DELETING THE STORED DATA

- (1) Press **▲** or **▼** to move the pointer to select **Yes** or **No**.

```
Delete Memory01?  
Yes  
▶No
```

- (2) Press **SELECT** or **DELETE**.

If **Yes** is selected: A confirmation tone sounds and the number is erased.

```
Memory01 Deleted
```

If **No** is selected: The LCD returns to the "Memory Store" display.

```
Memory Store  
01▶Ted Doe  
02 DOE JOHN
```

- (3) Press **MEM**, or return the handset to the base unit.

CALLER ID/CALL WAITING

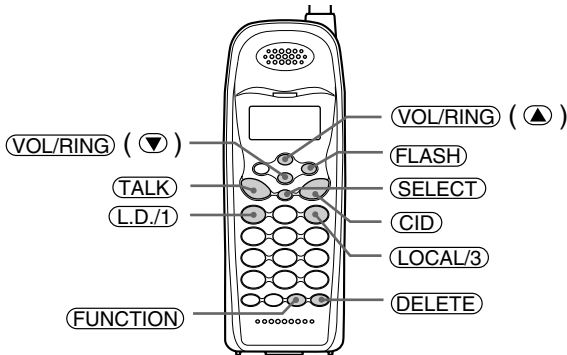

NOTES

- Before you can take advantage of the Caller ID and Call Waiting features, you must subscribe to these services from your local telephone company.
- Name and number caller ID only work in conjunction with service provided by your local telephone company.

ANSWERING A CALL WITH CALLER ID SERVICE

1 When the caller ID message is received, the display shows the caller's phone number along with the date and time. The incoming call information is stored in Caller ID record.

If the Caller ID service includes the caller's name, the caller's name appears on the display (up to 15 characters).

Caller's name _____	Incoming Call SMITH JOHN
Caller's phone number _____	123-456-7890

You may receive any one of the following messages;

When invalid data is receivedIncomplete Data
 When a private name is receivedPrivate Name
 When a private number is receivedPrivate Number
 When an unknown name is receivedUnknown Name
 When an unknown number is receivedUnknown Number

2 When you pick up the phone, the display changes to "Talk".

NOTES:

- If you answer a call before the Caller ID message is received (for example, before the second ring), the Caller ID message will not appear and store.
- When the call is received via a telephone company that does not offer Caller ID service, the caller's phone number and name do not appear and store. (This includes international calls).
- When the call is via a Private Branch exchange (PBX), the caller's phone number and name may not appear and store.
- Data errors appear as "■".

Talk	0:00
Volume	Medium

CALLER ID/CALL WAITING

SEARCHING CALLER ID MEMORY

To review who has called, follow the steps below.

The caller ID memory retains a listing of the 50 most recent callers.

- 1 Pick up the handset and press **(CID)**.

If new caller ID data does not exist:

Total:02

If there is new caller ID data:

New :01
Total:02

- 2 Press **(v)** to display the latest incoming call.

Press **(u)** to see previous incoming call.

1/7 9:30AM 12
DOE JOHN
555-2563

- 3 Press **(CID)** to return to standby mode.

CALLING BACK FROM THE CALLER ID LIST

- 1 Pick up the handset and press **(CID)**. Then, press **(v)** or **(u)** to display the number you wish to call.

1/7 9:30AM 12
SMITH JOHN
456-7890

- 2 Press **(TALK)**.
The displayed number will be dialed.

~~TALK~~
4567890

NOTE:

To enter a number for a long distance call, see "EDITING CALLER ID DATA" page 30. It is not necessary to add a "1" when dialing some area codes. If in doubt, check your local telephone directory.

CALLER ID/CALL WAITING

EDITING CALLER ID DATA

You can edit the Caller ID data.

- 1 Pick up the handset and press **(CID)**. Then, press **(▼)** or **(▲)** repeatedly to display the Caller ID data you want to edit.
- 2 Press **(L.D./1)** for a long distance call prefix “1” and **(LOCAL/3)** for area code setting and cancellation.

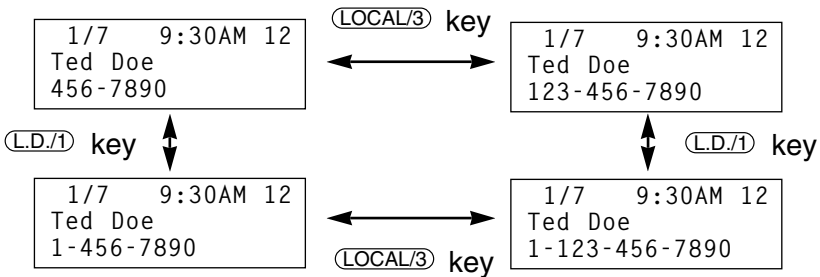

NOTE:

Before you use **(LOCAL/3)** for area code setting and cancellation, make sure the **AREA CODE** is set (See page 16).

- 3 After editing Caller ID data, you can make the call or store procedures.

To make a call, press **(TALK)**.

To store into memory dial, press **(MEM)**. Then, select memory location with **(▼)** or **(▲)** and press **(SELECT)**.

TRANSFERING CID NUMBER TO SPEED-DIAL MEMORY

- 1 Pick up the handset and press **(CID)**. Then, press **(▼)** or **(▲)** to indicate the number you want to store in the memory.
- 2 Press **(MEM)**.
- 3 Enter a two-digit number (01-20) or press **(▼)**, **(▲)** to select memory location.

Select Location
01 ▶
02

CALLER ID/CALL WAITING

- 4 Press **(SELECT)**. A confirmation tone sounds and the Caller ID data is stored. Press **(CID)** to return to standby.

If you select a memory location which is already stored:

Press **(▲)** to select “Yes” and press **(SELECT)**.

Replace Memory? Yes ▶No

A confirmation tone sounds and the new data overwrites the old data. The LCD returns to the Caller ID display screen.

If you select No :

The LCD returns to the Caller ID display screen.
Press **(CID)** to return to standby mode.

DELETING CALLER ID DATA

DELETE INDIVIDUAL CALLER ID DATA:

- 1 Pick up the handset and press **(CID)**. Then, press **(▼)** or **(▲)** to display the caller ID number you want to delete from the memory.
- 2 Press **(DELETE)**.
Press **(▲)** or **(▼)** to select Yes or No.
- 3 Press **(SELECT)** or **(DELETE)**. If you select “Yes”, you hear a confirmation tone and the LCD displays the next caller ID data. If there is none, the LCD displays the number of calls.

Delete Message? ▶Yes No

If you select “No”, the LCD returns to the Call ID display screen.

- 4 Press **(CID)** to return to standby.

CALLER ID/CALL WAITING

DELETE ALL CALLER ID DATA:

1 Press **CID**.

New :01
Total:02

2 Press **DELETE**.
Press **▲** or **▼** to select Yes or No.

Delete All?
Yes
▶No

3 Press **SELECT** or **DELETE**.
If you select **Yes**, a confirmation tone sounds and the LCD displays "Total:00".

Total:00

If you select **No**, the LCD displays the number of Caller ID calls.

New :01
Total:02

4 Press **CID** to return to the standby mode.

CALLER ID/CALL WAITING

CALL WAITING

"Caller ID" and "Call waiting" are separate services. CIDCW (Caller ID on Call Waiting) performs the same as regular Caller ID on a call waiting number. You must subscribe to the CIDCW services before you can use the following features. The "Call waiting" service can also be used independently. Please contact your local telephone company for details.

With Caller ID on Call Waiting, you can see who is calling to decide if you want to interrupt your current conversation to answer the incoming call.

1 Before answering a call, check to see that the caller's name and telephone number are displayed on the screen. To switch to the waiting call, press **(FLASH)** on the handset. The first caller is put on hold.

2 To switch back to the first caller, press **(FLASH)** again.

NOTES:

- Pressing **(FLASH)** without having received a Call Waiting signal may disconnect the current line.
- When CIDCW is set to Opt in the Caller ID setup menu (See page 15), pressing **(FUNCTION)** after receiving a call waiting call allows you to view a list of ways to handle the new call. Choose an option using the **(▲)** and **(▼)**, and press **(SELECT)** to active.

CALLER ID/CALL WAITING

CALL WAITING OPTIONS

Your phone gives you new options for call waiting. At the touch of a button, you can ask callers to hold, drop them or conference them into your current call. You may be required to subscribe to both Call Waiting and Call Waiting Options to use these features.

Follow these steps to use call waiting options. This is an example for “Conference”.

Talk 0:02
TOSHIBA CORP
817-858-3300

↓ Press (FUNCTION).

1▶ Ask to Hold
2 Tell Busy
3 Answer /Drop 1

↓ Press ▲ or ▼,
or number key (1-6).

4▶ Conference
5 Drop First
6 Drop Last

↓ Press (SELECT).

Talk 0:03
Conferenced

↓ Press (FUNCTION).

1▶ Ask to Hold
2 Tell Busy
3 Answer /Drop 1

↓

4 Conference
5 Drop First
6▶ Drop Last

↓

Talk 2:30
Call Dropped

You receive a call waiting call.

A list of options appears.
(For more information on the options,
see the table on page 35.)

Select one of six options.

To select “Conference”, press (4) or
scroll down to “Conference”.

This option allows you to have a 3-way
conference call with your first and
second callers.

The list of options appears.

- To drop 1st caller, press (5) or scroll down to “Drop First”, then (SELECT).
- To drop 2nd caller, press (6) or scroll down to “Drop Last”, then (SELECT).

A confirmation screen appears.

CALLER ID/CALL WAITING

The options you can choose are shown below:

No.	Option	Meaning
1	Ask to Hold	Prerecorded message asks 2nd caller to hold, and the waiting call is put on hold.
2	Tell Busy	Prerecorded message tells 2nd caller you are busy, and the waiting call is disconnected.
3	Answer / Drop 1	Disconnects 1st caller and answers 2nd caller.
4	Conference	Starts a 3-way conference call with both callers.
5	Drop First	Disconnects 1st caller.
6	Drop Last	Disconnects 2nd caller.

NOTES:

- *When using any of the options listed above, an extra charge might apply.*
- *Not all options are available in all areas. Check with your local telephone company for details.*

USING THE MENU MODE

Menu mode allows you to set the following Answering System functions. The following MENU MODE instructions assume that every setting starts from standby mode.

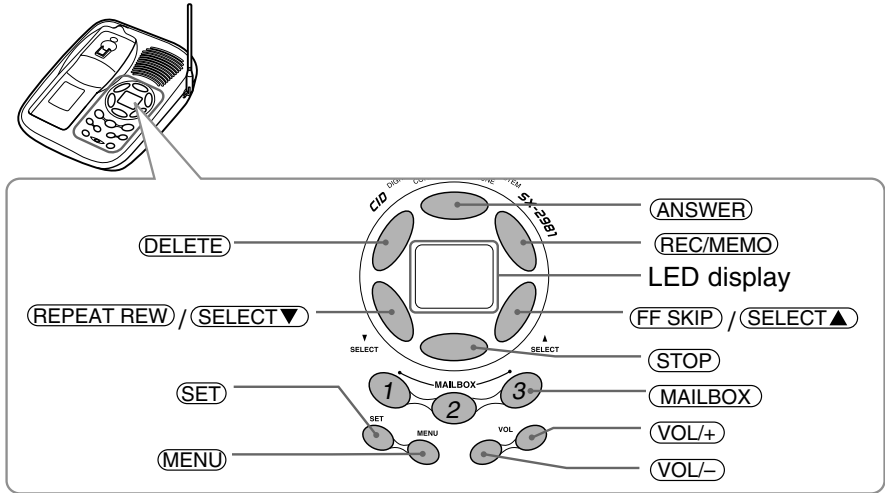

Menu No.	Function	
Menu1	Greeting message	--
Menu2	Clock	[0] - [59], [R], [P], [- -]
Menu3	Security code (PIN)	[00] - [99]
Menu4	Ringer volume	[H], [Lo], [OF]
Menu5	Ring time	[2], [4], [6], [65]
Menu6	Recording time	[1], [4], [R]
Standby	Return to standby	[0] - [58], [FL], [R]

NOTES:

- If you make no entries within 20 seconds, or 20 seconds pass after a voice prompt/guidance or greeting, you will hear a long beep and the answering machine returns to standby. Note that time-out for clock setting is 2 minutes.
- Receiving a call or pressing talk will cancel the setting. If you press (STOP), the setting is canceled and returns to standby.
- You can scroll to the next menu option by pressing (MENU).
- You can use (VOL+) or (VOL-) to adjust the announcement volume level during voice prompt/guidance.

USING THE MENU MODE

RECORDING THE GREETING MESSAGE

You can record a personalized greeting message (up to 30 seconds) or use the pre-recorded message. When a call is received, the answering machine answers the call and plays the greeting message.

- 1** Press **(MENU)** once.
You hear the pre-recorded message or current greeting message.
- 2** Press **(REC/MEMO)** and you will hear the guidance.
Start to record your greeting message.

For example:
"I can not come to the phone right now. Please leave a message after the tone".
- 3** To finish recording your greeting message, press **(REC/MEMO)** or **(STOP)** or **(SET)**.
You hear a long beep and your greeting plays back.

NOTE:

*You can delete your greeting message by pressing **(DELETE)** after step 1.*

CHANGING THE GREETING MESSAGE

You can change between the pre-recorded greeting message and your own recorded greeting message.

- 1** Press **(MENU)** once.
The current greeting message will be played.
- 2** Press **(SELECT▲)** or **(SELECT▼)** to change to the other.
- 3** Press **(STOP)** to exit the system.

USING THE MENU MODE

SETTING THE CLOCK

During playback, the answering machine announces the day and time that each message was recorded.

- 1** Press **(MENU)** twice.
The system announces the current time.
- 2** Press **(SET)**.
You hear the current day and the LED display shows the numbers [0] through [6].
- 3** Press **(SELECT▲)** or **(SELECT▼)** until the correct day is announced.
- 4** Press **(SET)**.
- 5** Press **(SELECT▲)** or **(SELECT▼)** until you hear the correct hour setting. The LED display shows the numbers [1] through [12] as each hour is announced.
- 6** Press **(SET)**.
- 7** Press **(SELECT▲)** or **(SELECT▼)** until you hear the correct minute setting. The LED display shows the numbers [00] through [59] as each minute is announced.
- 8** Press **(SET)**.
- 9** Press **(SELECT▲)** or **(SELECT▼)** until you hear AM or PM.
The LED display shows [A] or [P].
- 10** Press **(SET)**.
The answering machine announces the time that you have set.

NOTE:

If you do not complete the setting procedure within 2 minutes, the setting procedure is cancelled.

USING THE MENU MODE

SETTING THE SECURITY CODE (PIN)

To access your answering machine when you are away from home, you need to identify yourself with a security code or Personal Identification Number (PIN). You can select any two digit number between 00 and 99 as your security code (PIN).

- 1** Press **(MENU)** three times.
You hear the current setting, and the LED display shows the current security code (PIN).
- 2** Press **(SET)** to change the security code (PIN).
The system announces the current security code (PIN).
- 3** Press **(SELECT▲)** or **(SELECT▼)** until the desired number appears.
- 4** Press **(SET)** to set the security code (PIN).
The answering machine announces the new security code (PIN).

SETTING THE BASE RINGER VOLUME

Select one of three ringer volume settings (*H* : High, *L* : Low, *OFF* : off).

- 1** Press **(MENU)** four times.
You hear the current ringer volume, and the LED display shows the ringer volume.
- 2** Press **(SET)** .
- 3** Press **(SELECT▲)** or **(SELECT▼)** until the desired ringer volume appears (*H* : High, *L* : Low, *OFF* : off).
- 4** Press **(SET)** to set the ringer volume.
The system announces the ringer volume that you have set.

NOTE:

If the base ringer is set to off, and the handset is on the base, both the base and handset ringers are disabled.

USING THE MENU MODE

SETTING THE NUMBER OF RINGS

Select one of four ring time settings (2 : 2 rings, 4 : 4 rings, 6 : 6 rings, 5 : Toll Saver).

- 1 Press **(MENU)** five times.
The current ring time is displayed on the LED display.
- 2 Press **(SET)** to change the ring time.
- 3 Press **(SELECT▲)** or **(SELECT▼)** or until the desired ring time appears (2 : 2 rings, 4 : 4 rings, 6 : 6 rings, 5 : Toll Saver).
- 4 Press **(SET)** to set the new ring time.
The answering machine announces the ring time that you have set.

TS (TOLL SAVER MODE): The phone answers at the second ring when there are new messages, and the fourth ring when there are no new messages.

When you check the message from the outside phone, hang up if you hear the third ring to save the toll charge.

SETTING THE RECORDING TIME

Select one of two maximum recording times or Announce Only (1 : 1 minute, 4 : 4 minutes, R : Announce only).

- 1 Press **(MENU)** six times.
The LED display shows the current recording time.
- 2 Press **(SET)** to change the recording time.
- 3 Press **(SELECT▲)** or **(SELECT▼)** until the desired time appears (1 : 1 minute, 4 : 4 minutes, R : Announce only).
- 4 Press **(SET)** to set the new recording time.
The system announces the recording time that you have set.

A (Announce Only): If you set the recording time to A, the selected greeting message will be announced and no incoming message will be accepted. The LED display shows " R ".

USING THE ANSWERING MACHINE

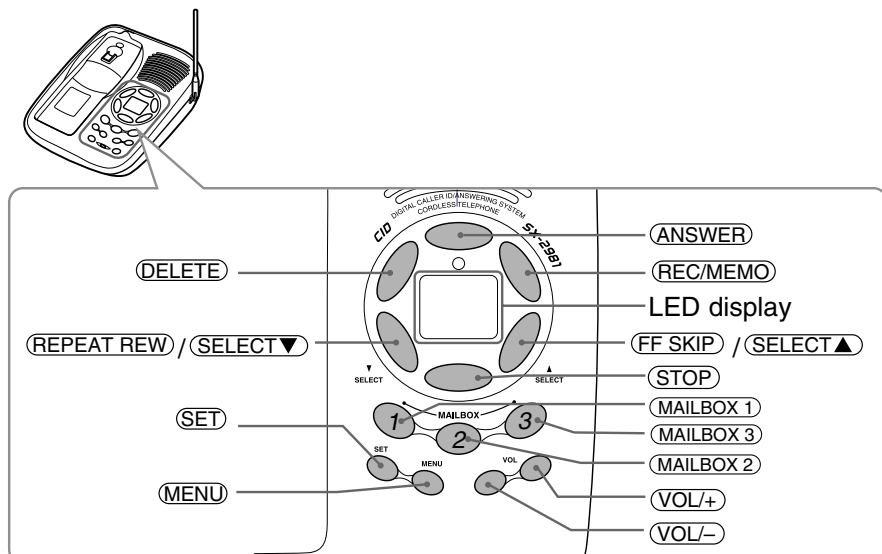

TURNING THE ANSWERING MACHINE ON & OFF

Press **(ANSWER)** to turn the answering machine on. The ANSWER LED will light, and the number of messages appears on the LED display. The greeting message will be played and you hear a long beep.

To turn the answering machine off, press **(ANSWER)**. The LED display turns off.

NOTE:

If the message storage area is full, the LED display shows "FL" and the system announces "No remaining time" after the greeting message. You should delete messages (see page 43). Otherwise, the system cannot record any new messages.

USING THE ANSWERING MACHINE

PLAYING RECORDED MESSAGES

After the answering machine has recorded the message, the total number of new messages stored in all mailboxes flashes on the LED display and the mailbox indicator that contains the new message flashes.

1 Press the desired **(MAILBOX)** button.

The answering machine announces the number of new and old messages, then plays the new messages. The message number appears as each message plays, and the answering machine announces the day and time of the call at the end of each message.

To play all the messages after playing the new messages, press **(MAILBOX)** button again.

During playback, see the table below for more operation.

To repeat the previous message	Press (REPEAT REW) (within 2 seconds after the beginning of message).
To repeat the current message	Press (REPEAT REW) (after 2 seconds after the beginning of message).
To skip the message	Press (FF SKIP) .
To rewind the message in double speed	Press and hold (REPEAT REW) .
To playback the message in double speed	Press and hold (FF SKIP) .
To delete a message	Press (DELETE) during playback of the message you want to delete.
To stop playback	Press (STOP) .
To delete all messages	Press and hold (DELETE) in standby mode until you hear "Please select mailbox". Then, press the desired (MAILBOX) .
To adjust the speaker volume (0-9)	Press (VOL+) or (VOL-) repeatedly.

USING THE ANSWERING MACHINE

DELETING RECORDED MESSAGES

To delete all messages:

Press and hold **DELETE** in standby mode until you hear “Please select mailbox”. Then, press the desired **MAILBOX**.

If there are messages that you have not listened to, an error tone sounds and the messages will not be deleted.

To delete individual messages:

While playing back of the message you want to delete, press **DELETE**. The message is deleted and the next message will be played.

NOTE: To maintain maximum record time, it is a good idea to delete the old messages.

SCREENING INCOMING CALLS

You can screen calls when the answering machine is on.

- 1** After the answering machine answers, the base speaker lets you hear the caller as the machine records the message.
- 2** To answer the call immediately, simply pick up the handset (when the Auto Talk is set to on), press **SPEAKER** on the base or press **TALK** if the handset is away from the base. The answering machine will disconnect automatically.

NOTES:

- If the speaker volume is set to 0, you can not use the call screening feature.
- When the answering machine plays the greeting message, the LCD displays [Answering].

USING THE ANSWERING MACHINE

LEAVING A MEMO TO THE DESIGNATED MAILBOX

You can use the base unit to record a memo (up to 10 minutes), as a reminder to yourself or as a message for someone else in the household. A memo is stored and played back like any other incoming message, and the Selected Mailbox LED will blink to indicate that a message has been received.

1 Hold down **REC/MEMO** till a beep sounds.

The Answering machine announces “Please select mailbox”.

2 Press **MAILBOX 1**, **MAILBOX 2**, or **MAILBOX 3** to select the mailbox. The TAD announces “record your message after the tone” and -- appears in the message counter window.

3 When the tone sounds, speak your message. When you finish the memo, press **REC/MEMO** or **STOP**.

NOTE:

The Answering machine can not record a memo less than two seconds long.

USING THE MAILBOX FROM THE REMOTE LOCATION

You can record the messages from specific callers in a designated mailbox. For example, when you are away from your home, you might want to record your message separately from other messages.

1 Press ***** and mailbox number while the caller is hearing the greeting message.

For example, press *****, **2** to record the message in mailbox 2. The answering machine announces “Mailbox 2” and becomes ready to record the message.

NOTE:

Unless specified above, the incoming messages are recorded in mailbox 1.

USING THE ANSWERING MACHINE

RECORDING A PHONE CONVERSATION (2 WAY REC)

You can record a telephone conversation that is already in progress with the handset (up to 10 minutes). The conversation is stored and played back like an incoming message.

1 During a call with the handset, press and hold **REC/MEMO** till a beep sounds. The "--" appears on the LED display. Recording starts and both parties hear the intermittent beeps.

2 To stop recording, press **REC/MEMO** or **STOP**. You hear a long beep.

NOTE:

- *When recording a conversation, all number keys are disabled. Stop recording if you need to use any other handset keys.*
- *The answering machine stores a recorded conversation as a message on mailbox 1.*
- *The answering machine can not record a conversation less than two seconds long, or a call using the speakerphone.*

USING THE ANSWERING MACHINE

CALLING IN FROM A REMOTE LOCATION

You can retrieve messages or change answering machine settings by calling your phone from a touch-tone phone. Even if the answering machine has been left off, you can still access it by turning it on first.

1 IF THE ANSWERING MACHINE IS OFF:

Let the phone ring at least 10 times. The line will connect and you will hear several short beeps. Press **#** and enter your security code (PIN).

IF THE ANSWERING MACHINE IS ON:

After playing your greeting message, press **#** and enter your security code (PIN).

- ### 2
- The answering machine announces the number of new and old messages for each mailbox, then you will hear "To play incoming message, press pound 2. For help, press pound zero." Then the answering system beeps about every two seconds, prompting you to enter a remote command. This is the command prompt.

To playback the incoming messages and repeat, skip or delete, go to step **a**. To use other remote commands, go to step **3**.

a PLAYBACK THE INCOMING MESSAGES

1. At the command prompt, press **#** and **2**. The ANSWERING MACHINE announces "Please select mailbox".
2. Press **#** and the mailbox number. For example, to listen to the messages in mailbox 1, press **#** and **1**.

- ### 3
- Press **#** and the appropriate number button that corresponds to the operation you want (see TABLE OF COMMANDS on next page).

- ### 4
- When you have finished, press **#** and **5** or hang up to exit the system.

NOTES:

- *When entering your security code (PIN), the second digit must be entered within 2 seconds after the first one.*
- *If you enter a wrong security code (PIN) 3 times, the line will be disconnected.*

USING THE ANSWERING MACHINE

- Enter the command within 15 seconds while you hear intermittent beeps. Otherwise, the line is disconnected.
- When you call your phone while the message storage area is full, you will hear several short beeps after the 10th ring. Enter **#** and your security code (PIN), then you can continue to enter the commands.
- During operation from a remote location, [r] , appears on the LED display.

TABLE OF COMMANDS

The following commands can only be accepted after pressing **#** **2** (Playback), then **#** and MAILBOX number (1-3).*¹

OPERATION (during playback)	Press
To repeat an incoming message	# 1 * ²
To skip to the next message	# 3
To delete individual messages	# 4
To stop playback	# 5

The following commands are accepted during command prompt.

OPERATION	Press
To delete all the messages in the desired MAILBOX	# 4 then # and MAILBOX number (1-3)
To stop operation	# 5
To turn the answering system on	# 6
To record a memo message (Up to 4 minutes)	# 7 then # and MAILBOX number (1-3)
To stop recording a memo	# 5 or # 7
To record your greeting message	# 8
To stop recording your greeting message	# 5 or # 8
To turn the answering system off	# 9
To play Help Guidance	# 0

NOTES:

*¹ If you have more messages after 4 minutes have passed, you must press **#** **2** again listen to the rest of the messages.

*² If you press **#** **1** , within about 4 seconds after a message begins playing, the ANSWERING MACHINE replays the previous message. If the current message is the first new message, the ANSWERING MACHINE plays back from the beginning of the current message(it does not play old message).

For your handy reference guide, cut out the remote operation cards on page 53.

TROUBLESHOOTING

Should any problem occur with the unit, use the following simple tests to determine whether or not servicing is required.

PROBLEM	SOLUTION
The handset battery pack does not charge.	• The charging contacts of the handset and base are not clean. → Clean them with a dry cloth.
	• The battery is not connected with correct polarity. → Install the battery pack correctly.
	• The battery is several years old. → Replace with a new battery.
Battery pack becomes low quickly.	• The battery was not fully charged at the initial charging. → Charge the battery for 12 to 16 hours without any interruption.
	• The battery is several years old. → Replace with a new battery.
Can not make or receive calls. Can not hear dial tone.	• The AC adaptor of the base unit is disconnected. → Plug the AC adaptor into the base unit and the AC 120V outlet.
	• The battery is low. → Place the handset on the base unit to recharge.
	• Telephone line cord is disconnected. → Check both ends of the telephone jack.
	• The previous call was not disconnected. → Press (TALK) to disconnect the line.
	• Trouble with the telephone line. → Check an extension line.
	• Outlet used is controlled by a wall switch in its OFF position. → Relocate it to another outlet.
	• The handset is too far from the base unit. → Bring the handset near the base unit.
	• Dial setting needs to be changed → Press and hold (FLASH) then choose the appropriate setting.
	• The battery is low. → Return the handset to the base.
The handset does not ring or receive a page.	• The handset is located away from the base or the battery has been discharged. → Return the handset to charge when your call is finished.
	• The digital security code is changed. → Remove the handset from the base unit and press and hold (PAGE) . While the handset is emitting, return the handset to the base unit.
	• The battery is low. → Place the handset on the base unit to recharge.

TROUBLESHOOTING

PROBLEM	SOLUTION
The handset does not ring.	<ul style="list-style-type: none"> • The ringer control is set to OFF. → Turn the ringer control ON.
CHARGE LED will not light when the handset is placed on the base.	<ul style="list-style-type: none"> • The charging contacts of the handset and the base are not clean. → Clean them with a dry cloth. • The AC adaptor of the base unit is disconnected. → Plug the AC adaptor firmly into the base unit and AC 120V outlet. • The handset is not on the base. → Place the handset on the base properly.
Noise or interference.	<ul style="list-style-type: none"> • The handset is too far from the base unit. → Bring the handset near the base unit. • The battery is low. → Place the handset on the base unit to recharge. • The base unit is located in a place with high interference. → Relocate to another outlet. • Interference from TV, Microwave oven, computer and electrical appliances. → Press (CHANNEL) to select a clearer channel, or relocate the base unit. • Excessive line noise. → Check with another telephone. • The volume control is set too high. → Reduce volume to a lower setting. • The base antenna is not in a vertical position. → Lift the antenna to a vertical position.
The unit does not operate properly.	<ul style="list-style-type: none"> • The phone needs to be reset. → Disconnect the AC adaptor and reconnect it within few seconds.
When the handset is returned to the base unit with the volume level set at Maximum, a momentary squeal or howling sound may sometimes be heard.	<ul style="list-style-type: none"> • This is normal. → It may be prevented by changing the volume setting to High, Medium or Low before returning the handset to the base unit.

TROUBLESHOOTING

PROBLEM	SOLUTION
The answering machine does not answer the call.	<ul style="list-style-type: none"> The recording capacity is full. → Delete some or all of the recorded messages.
Answering machine does not play.	<ul style="list-style-type: none"> No message is recorded. → This is normal.
The messages are not recorded/incomplete.	<ul style="list-style-type: none"> The message was too long or too short. → The message should not be longer than the recording time (1 or 4 minutes), or shorter than 2 seconds.
	<ul style="list-style-type: none"> The recording capacity became full. → Delete recorded messages.
	<ul style="list-style-type: none"> The phone was answered during recording.
The answering machine does not respond to remote operation.	<ul style="list-style-type: none"> You are not calling from a touch tone phone. → Call from a touch tone phone.
	<ul style="list-style-type: none"> The security code (PIN) you entered was wrong. → Make sure you entered the correct security code (PIN). → If the answering machine is turned off, let the phone ring at least 10 times. The line will connect and you will hear several short beeps. Press # and enter your security code (PIN).
The LED display shows "A" (Announce only).	<ul style="list-style-type: none"> This is normal. The recording time is set to A (announce only). → Set the REC TIME to 1 or 4 minute setting.
Can not delete messages.	<ul style="list-style-type: none"> There is a message that has not been played. → Play the new message, then delete messages.
The phone does not display the Caller ID/Call Waiting data.	<ul style="list-style-type: none"> You have to subscribe to Caller ID/Caller ID on Call Waiting services. → Check with your local telephone company.
	<ul style="list-style-type: none"> You answered the call before Caller ID data was received. → Let the phone ring twice before you answer the call.
	<ul style="list-style-type: none"> The call is via PBX. → See page 28.
	<ul style="list-style-type: none"> The battery is not fully charged. → Charge the battery.
Auto talk and Any-key feature do not work.	<ul style="list-style-type: none"> Auto talk feature has been set to OFF. → Set this feature to ON. (Any-key feature automatically set to ON)

WARRANTY/SERVICE

SERVICE REQUIREMENTS

If the cordless telephone should malfunction, or need changes or modifications, all repairs will be performed by an authorized Toshiba Service Station. This unit has been registered with the FCC for direct connection to the telephone network. Under the FCC program, no customer is authorized to repair this unit. This applies to units either in or out of warranty. If an unauthorized repair is performed, the registration of the unit for direct connection to the network will be null and void. If the unit is still in warranty, the remainder of the warranty period will also be null and void.

It is the responsibility of users requiring service to report the need for service to the Toshiba dealer.

IMPORTANT INSTRUCTIONS TO USERS

Your telephone equipment has been designed and constructed to conform to federal regulations and can be connected to the phone line as described in this manual.

Please note that each product connected to the telephone line places a certain load on the line. We designate this as the unit's "Ringer Equivalence Number."

It is most unlikely, but...If your telephone equipment should cause problems on the phone line, the phone company has the right to temporarily discontinue your service. If this happens, the phone company will notify you and give you the opportunity to correct the problem. Also, you need to know that the phone company does have the right to make changes in their lines and/or equipment.

If these changes might affect your telephone equipment (or require changes in the telephone equipment or its connection), the phone company will notify you in writing, so you have the chance to take whatever action necessary to ensure uninterrupted phone service.

FCC REQUIREMENTS

You are no longer required by the FCC to notify your local telephone company of your intent to connect a new telephone. Your local telephone company may call you and request information about your phone such as: the brand name, model number, registration number, and ringer equivalence number. This information is provided on a label located at the bottom of the base unit and handset.

You may not directly connect your telephone equipment to coin telephone services. Check with your local telephone company if you wish to connect your telephone equipment to a party line service. Some party line services require a special adaptor or modification to your telephone.

It should be noted that some cordless telephones operate at frequencies that may cause interference to nearby TVs and VCRs; to minimize or prevent such interference, the base of the cordless telephone should not be placed near or on top of a TV or VCR; and, if interference is experienced, moving the cordless telephone farther away from the TV or VCR will often reduce or eliminate the interference.

WARRANTY/SERVICE

TELEPHONE/TELEPHONE ANSWER MACHINE LIMITED WARRANTY

Toshiba America Consumer Products, Inc. ("TACP"), and Toshiba Hawaii, Inc. ("THI"), make the following limited warranties. These limited warranties extend to the original consumer purchaser or any person receiving this set as a gift from the original consumer purchaser and to no other purchaser or transferee.

Limited One (1) Year Warranty of Labor and parts

TACP/THI warrant this product and its parts against defects in materials or workmanship for a period of one (1) year after the date of original retail purchase. During this period, TACP/THI will repair or replace your defective product with a new or refurbished unit at TACP's option.

Owner's Manual

You should read the owner's manual thoroughly before operating this product.

Your Responsibility

The above warranties are subject to the following conditions.

- (1) You must provide a copy of your bill of sale or other proof of purchase.
- (2) These warranties are effective only if the product is purchased and operated within the USA or Puerto Rico.

(3) Within the continental U.S.A., if you should find a defective product within the warranty period please call 1-877-644-7373.

(4) Warranties extend only to defects in materials or workmanship as limited above and do not extend to any product or parts which have been lost or discarded by you, or to damage to products or parts caused by misuse, accident, damage caused by Acts of God, such as lightning or fluctuations in electric power, improper installation, improper maintenance or use in violation of instructions furnished by us; or to units which have been altered or modified without authorization of TACP/THI, or to damage to products or parts thereof which have had the serial number removed, altered, defaced or rendered illegible.

(5) Physically damaged products are not acceptable for repair or exchange within or after the warranty period expires.

How to Obtain Warranty Service

In the event a problem should develop with your product, please proceed as follows;

In The Continental United States contact: **In Hawaii contact:**

www.toshiba.com/tacp

Toshiba Hawaii, Inc.
327 Kamakee Street,
Honolulu, HI 96814
(808)-591-9261

All warranties implied by state law, including the implied warranties of merchantability and fitness for a particular purpose, are expressly limited to the duration of the limited warranties set forth above. With the exception of any warranties implied by state law as hereby limited, the foregoing warranty is exclusive and in lieu of all other warranties, guarantees, agreements and similar obligations of manufacturer or seller with respect to the repair or replacement of any parts. In no event shall TACP/THI be liable for consequential or incidental damages.

No person, agent, distributor, dealer or company is authorized to change, modify or extend the terms of these warranties in any manner whatsoever. The time within which an action must be commenced to enforce any obligation of TACP/THI arising under the warranty or under any statute or law of the United States or any state thereof, is hereby limited to ninety(90) days from the date you discover, or should have discovered, the defect. This limitation does not apply to implied warranties arising under state law.

This warranty gives you specific legal rights and you may also have other rights which may vary from state to state. Some states do not allow limitation on how long an implied warranty lasts, when an action may be brought, or the exclusion or limitation of incidental or consequential damages, so the above provisions may not apply to you.

REMOTE OPERATION CARDS

CUT

REMOTE OPERATION OF SX-2981

- A** Call your machine from touch tone phone. After your machine answers, enter # and security code (PIN) pressing each digit for at least 1 second. If you enter # and PIN correctly, your machine sounds invitation tone after the announcement. Now enter the command (# and number) by pressing the keypad.
- B** To playback incoming and memo messages, press #2 then (Ⓜ) and desired MAILBOX number. To skip, press #3 during playback.
- To repeat, press #1 during playback. To delete individual message, press #4 during playback. To delete all the messages in the desired MAILBOX, press #4 then (Ⓜ) and desired MAILBOX number during playback.
- C** To record memo message, press #7 then (Ⓜ) and desired MAILBOX number. To record greeting message, press #8. To stop recording, press #5. To turn on the answer mode, press #6. To turn off the answer mode, press #9.
- D** To stop operation, press #5.

TOSHIBA

OPERACIONES POR CONTROL REMOTO SX-2981

- A** Llame a su teléfono desde un teléfono de teclado. Después que su teléfono conteste, introduzca # y el código de seguridad (PIN) presionando cada dígito durante 1 segundo como mínimo. Si introduce correctamente # y el PIN, su teléfono emitirá un tono de invitación después del anuncio. Luego introduzca el mandato (# y un número) presionando las teclas.
- B** Para reproducir los mensajes recibidos y los memorandos presione #2 después (Ⓜ) y el número del MAILBOX (buzón) deseado. Para saltar presione #3 durante la reproducción. Para repetir presione #1 durante la reproducción.
- Para borrar un mensaje particular, presione #4 durante la reproducción. Para borrar todos los mensajes en un buzón deseado, presione #4 después (Ⓜ) y el número del MAILBOX (buzón) deseado durante la reproducción.
- C** Para grabar mensajes de memorando presione #7 después (Ⓜ) y el número del MAILBOX (buzón) deseado. Para grabar un mensaje de contestación presione #8. Para detener la grabación presione #5. Para activar o desactivar el modo de contestación presione #6. Para desactivar el modo de contestación presione #9.
- D** Para detener la operación, presione #5.

TOSHIBA

REMOTE OPERATION CARDS

CUT

WHILE PLAYING THE GREETING MESSAGE, PRESS (#) AND PIN

<p>MESSAGE REPEAT # 1</p>	<p>MESSAGE PLAYBACK # 2 then # and selected mailbox number</p>	<p>MESSAGE SKIP # 3 (during playback)</p>
<p>INDIVIDUAL MESSAGE DELETE # 4 (during playback)</p> <p>ALL MESSAGES DELETE in a desired MAILBOX # 3 then # and the desired mailbox number</p>	<p>RECORD STOP/ OPERATION STOP # 5</p>	<p>ANSWER ON # 6</p>
<p>MEMO RECORD # 7 then # and selected mailbox number</p>	<p>GREETING RECORD # 8</p>	<p>ANSWER OFF # 9</p>
	<p>HELP GUIDANCE # 0</p>	<p>REMOTE ACCESS # PIN</p>

← Fold here

DURANTE LA REPRODUCCIÓN DEL MENSAJE DE CONTESTACIÓN, PRESIONE (#) Y PIN

<p>REPETICIÓN DE MENSAJE # 1</p>	<p>REPRODUCCIÓN DE MENSAJE # 2 después # y el número del buzón seleccionado</p>	<p>SALTO DE MENSAJE # 3 (durante la reproducción)</p>
<p>BORRADO DE UN MENSAJE PARTICULAR # 4 (durante la reproducción)</p> <p>BORRADO DE TODOS LOS MENSAJES en un MAILBOX (buzón) deseado # 4 después # y el número del buzón deseado</p>	<p>DETENCIÓN DE GRABACIÓN/OPERACIÓN # 5</p>	<p>ACTIVACIÓN DE CONTESTACIÓN # 6</p>
<p>GRABACIÓN DE MENSAJE DE MEMORANDO # 7 después # y el número del buzón seleccionado</p>	<p>GRABACIÓN DE MENSAJE DE CONTESTACIÓN # 8</p>	<p>DESACTIVACIÓN DE CONTESTACIÓN # 9</p>
	<p>ASISTENCIA ANUNCIO # 0</p>	<p>ACCESO AL CONTROL REMOTO # PIN</p>

← Doble aquí

For technical assistance, purchase of accessories or service, please access www.toshiba.com/tacp.

IMPORTANT

We suggest you record the following information and retain for your records along with your bill of sale or equipment document.

Model no. _____ **Serial no.** _____
Purchase date _____ **Dealer** _____
Dealer address _____

© 2001 TOSHIBA AMERICA CONSUMER PRODUCTS, INC.

Free Manuals Download Website

<http://myh66.com>

<http://usermanuals.us>

<http://www.somanuals.com>

<http://www.4manuals.cc>

<http://www.manual-lib.com>

<http://www.404manual.com>

<http://www.luxmanual.com>

<http://aubethermostatmanual.com>

Golf course search by state

<http://golfingnear.com>

Email search by domain

<http://emailbydomain.com>

Auto manuals search

<http://auto.somanuals.com>

TV manuals search

<http://tv.somanuals.com>