

# TOSHIBA

# OWNER'S MANUAL

## Color Television

COLORSTREAM<sup>®</sup> SRS<sup>™</sup>  
by SRS (S)<sup>®</sup>

# 32HF72

# 36HF72

### Owner's Record

The model number and serial number are on the back of your TV. Record these numbers in the spaces below. Refer to these numbers whenever you communicate with your Toshiba dealer about this TV.

Model:

Serial No.:



Introduction

Connecting  
your TV

Using the  
Remote Control

Setting up  
your TV

Using the TV's  
Features

Appendix

Index

## Dear Customer,

Thank you for purchasing this Toshiba TV. This manual will help you use the many exciting features of your new TV.

**Before operating the TV, please read this manual completely, and keep it nearby for future reference.**

## Safety Precautions

### WARNING

**TO REDUCE THE RISK OF FIRE OR ELECTRIC SHOCK, DO NOT EXPOSE THIS APPLIANCE TO RAIN OR MOISTURE.**

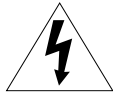

**WARNING**  
RISK OF ELECTRIC SHOCK  
DO NOT OPEN



**WARNING: TO REDUCE THE RISK OF ELECTRIC SHOCK, DO NOT REMOVE COVER (OR BACK). NO USER-SERVICEABLE PARTS INSIDE. REFER SERVICING TO QUALIFIED SERVICE PERSONNEL.**

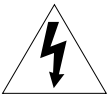

The lightning symbol in the triangle tells you that the voltage inside this product may be strong enough to cause an electric shock. **DO NOT TRY TO SERVICE THIS PRODUCT YOURSELF.**



The exclamation mark in the triangle tells you that important operating and maintenance instructions follow this symbol.

## NOTE TO CATV INSTALLERS IN THE USA

This is a reminder to call the CATV system installer's attention to Article 820-40 of the NEC, which provides guidelines for proper grounding and, in particular, specifies that the cable ground shall be connected to the grounding system of the building, as close to the point of cable entry as practical. For additional antenna grounding information, see items 24 and 25 on page 4.

## NOTICE OF POSSIBLE TV STAND INSTABILITY



**DANGER: RISK OF SERIOUS PERSONAL INJURY OR DEATH!** Use this TV with the TOSHIBA TV stand recommended in the "Specifications" section only. Use with other stands may result in instability, causing possible injury or death.

## NOTICE OF POSSIBLE ADVERSE EFFECTS ON TV PICTURE TUBE

If a fixed (non-moving) pattern remains on the TV screen for long periods of time, the image can become permanently engrained in the picture tube. **This type of damage is NOT COVERED BY YOUR WARRANTY.** See item 32 on page 4.

## Child Safety

**It Makes A Difference Where Your TV Stands**



**Congratulations on your purchase! As you enjoy your new TV, keep these safety tips in mind:**

### The Issue

- If you are like most Americans, you have a TV in your home. Many homes, in fact, have more than one TV.
- The home theater entertainment experience is a growing trend, and larger TVs are popular purchases; however, they are not always supported on the proper TV stands.
- Sometimes TVs are improperly secured or inappropriately situated on dressers, bookcases, shelves, desks, audio speakers, chests, or carts. As a result, TVs may fall over, causing unnecessary injury.

### Toshiba Cares!

- The consumer electronics industry is committed to making home entertainment enjoyable and safe.
- The Consumer Electronics Association formed the Home Entertainment Support Safety Committee, comprised of TV and consumer electronics furniture manufacturers, to advocate children's safety and educate consumers and their families about television safety.

### Tune Into Safety

- One size does NOT fit all! Use appropriate furniture large enough to support the weight of your TV (and other electronic components).
- Use appropriate angle braces, straps, and anchors to secure your furniture to the wall (but never screw anything directly into the TV).
- Carefully read and understand the other enclosed instructions for proper use of this product.
- Do not allow children to climb on or play with furniture and TVs.
- Avoid placing any item on top of your TV (such as a VCR, remote control, or toy) that a curious child may reach for.
- Remember that children can become excited while watching a program and can potentially push or pull a TV over.
- Share our safety message about this hidden hazard of the home with your family and friends. Thank you!



2500 Wilson Blvd.  
Arlington, VA 22201 U.S.A.  
Tel. 703-907-7600 Fax 703-907-7690  
www.CE.org

*CEA is the Sponsor, Producer and Manager of the International CES®*

05/02.2

# Important Safety Instructions

- 1) **Read these instructions.**
- 2) **Keep these instructions.**
- 3) **Heed all warnings.**
- 4) **Follow all instructions.**



- 5) **Do not use this apparatus near water.**



- 6) **Clean only with a dry cloth.**

- 7) **Do not block any ventilation openings.** Install in accordance with the manufacturer's instructions.

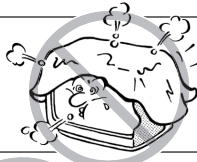

- 8) **Do not install near any heat sources** such as radiators, heat registers, stoves, or other apparatus (including amplifiers) that produce heat.



- 9) **Do not defeat the safety purpose of the polarized or grounding type plug.** A polarized plug has two blades with one wider than the other. A grounding type plug has two blades and a third grounding prong. The wide blade or the third prong are provided for your safety. If the provided plug does not fit into your outlet, consult an electrician for replacement of the obsolete outlet.

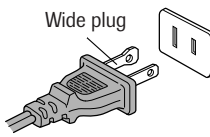

**CAUTION:** To reduce the risk of electric shock, do not use the polarized plug with an extension cord, receptacle, or other outlet unless the blades can be inserted completely to prevent blade exposure.

- 10) **Protect the power cord** from being walked on or pinched, particularly at plugs, convenience receptacles, and the point where it exits the apparatus.

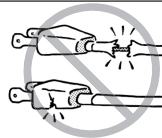

- 11) **Only use attachments/accessories specified by the manufacturer.**

- 12) **Use only with the cart, stand, tripod, bracket, or table specified by the manufacturer, or sold with the apparatus.** When a cart is used, use caution when moving the cart/apparatus combination to avoid injury from tip-over.



- 13) **Unplug this apparatus during lightning storms or when unused for long periods of time.**



- 14) **Refer all servicing to qualified service personnel.** Servicing is required when the apparatus has been damaged in any way, such as power supply cord or plug is damaged, liquid has been spilled or objects have fallen into the apparatus, the apparatus has been exposed to rain or moisture, does not operate normally, or has been dropped.



05/02.2

# Installation, Care, and Service

## Installation

Follow these recommendations and precautions and heed all warnings when installing your TV:

- 15) Never modify this equipment. Changes or modifications may void: a) the warranty, and b) the user's authority to operate this equipment under the rules of the Federal Communications Commission.

- 16) **DANGER: RISK OF SERIOUS PERSONAL INJURY, DEATH, OR EQUIPMENT DAMAGE!** Never place the TV on an unstable cart, stand, or table. The TV may fall, causing serious personal injury, death, or serious damage to the TV.



- 17) Never place or store the TV in direct sunlight; hot, humid areas; areas subject to excessive dust or vibration; or locations with temperatures at or below 41°F (5°C).

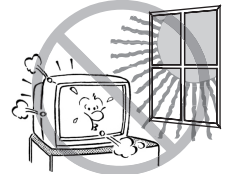

- 18) Always place the TV on the floor or a sturdy, level, stable surface that can support the weight of the unit.



- 19) Never place items such as vases, aquariums, or candles on top of the TV.



- 20) Never block or cover the slots or openings in the TV cabinet back, bottom, and sides. Never place the TV:
  - on a bed, sofa, rug, or similar surface;
  - too close to drapes, curtains, or walls; or
  - in a confined space such as a bookcase, built-in cabinet, or any other place with poor ventilation.



The slots and openings are provided to protect the TV from overheating and to help maintain reliable operation of the TV.

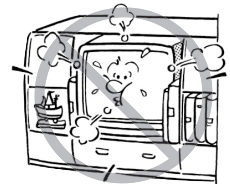

- 21) Never allow anything to rest on or roll over the power cord, and never place the TV where the power cord is subject to wear or abuse.

- 22) Never overload wall outlets and extension cords.



- 23) Always operate this equipment from a 120 VAC, 60 Hz power source only.



- 24) Always make sure the antenna system is properly grounded to provide adequate protection against voltage surges and built-up static charges (see Section 810 of the National Electric Code).

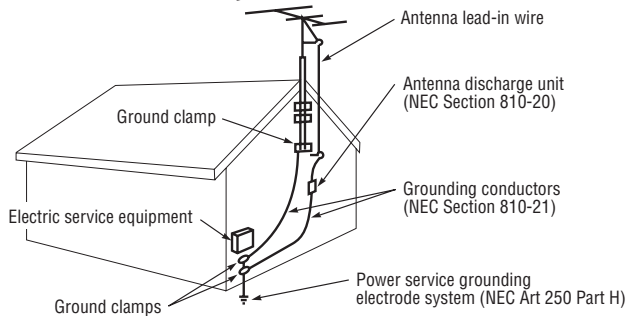

- 25) **! DANGER: RISK OF SERIOUS PERSONAL INJURY OR DEATH!**
- Use extreme care to make sure you are never in a position where your body (or any item you are in contact with, such as a ladder or screwdriver) can accidentally touch overhead power lines. Never locate the antenna near overhead power lines or other electrical circuits.
  - Never attempt to install any of the following during lightning activity:
    - a) an antenna system; or b) cables, wires, or any home theater component connected to an antenna or phone system.

## Care

For better performance and safer operation of your TOSHIBA TV, follow these recommendations and precautions:

- 26) Always sit approximately 10–25 feet away from the TV and as directly in front of it as possible. The picture can appear dull if you sit too far to the left or right of the TV, or if sunlight or room lights reflect on the screen. Turn the TV off to check for reflections on the screen, and then remove the source of reflections while viewing the TV.

- 27) Always unplug the TV before cleaning. Never use liquid or aerosol cleaners.

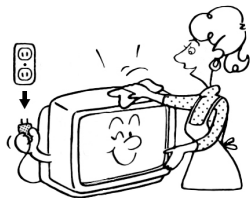

- 28) **! WARNING: RISK OF ELECTRIC SHOCK!** Never spill liquids or push objects of any kind into the TV cabinet slots.

- 29) [This item applies to projection TVs only.] If the air temperature rises suddenly (for example, when the TV is first delivered), condensation may form on the lenses. This can make the picture appear distorted or the color appear faded. If this happens, turn off the TV for 6 to 7 hours to allow the condensation to evaporate.

- 30) For added protection of your TV from lightning and power surges, always unplug the power cord and disconnect the antenna from the TV if you leave the TV unattended or unused for long periods of time.

- 31) During normal use, the TV may make occasional snapping or popping sounds. This is normal, especially when the unit is being turned on or off. If these sounds become frequent or continuous, unplug the power cord and contact a Toshiba Authorized Service Center.

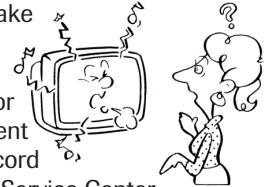

- 32) **Possible Adverse Effects on TV Picture Tube:** If a fixed (non-moving) pattern remains on the TV screen for long periods of time, the image can become permanently engrained in the picture tube and cause subtle but permanent ghost images. **This type of damage is NOT COVERED BY YOUR WARRANTY.** Never leave your TV on for long periods of time while it is displaying the following formats or images:

- **Fixed Images**, such as PIP/POP windows, stock tickers, video game patterns, TV station logos, and websites.
- **Special Formats** that do not use the entire screen. For example, viewing letterbox style (16:9) media on a normal (4:3) display (gray bars at top and bottom of screen); or viewing normal style (4:3) media on a widescreen (16:9) display (gray bars on left and right sides of screen).

## Service

- 33) **! WARNING: RISK OF ELECTRIC SHOCK!** Never attempt to service the TV yourself. Opening and removing the covers may expose you to dangerous voltage or other hazards. Refer all servicing to a Toshiba Authorized Service Center.

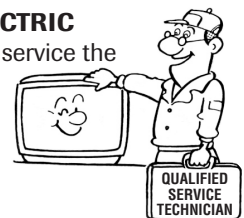

- 34) If you have the TV serviced:

- Ask the service technician to use only replacement parts specified by the manufacturer.
- Upon completion of service, ask the service technician to perform routine safety checks to determine that the TV is in safe operating condition.

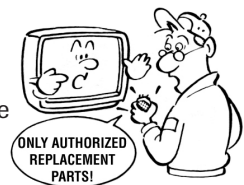

- 35) When the TV reaches the end of its useful life, ask a qualified service technician to properly dispose of the TV. Improper disposal may result in a picture tube implosion and possible personal injury.

<b>Important Safety Information .....</b>	<b>2-4</b>	Using the Multi-Window feature .....	31
<b>Introduction .....</b>	<b>6</b>	Using the favorite function .....	31
Welcome to Toshiba .....	6	Using the strobe function .....	31
Exploring your new TV .....	6	Using the LOCKS menu .....	32
<b>Note regarding Quick Connect Guide .....</b>	<b>6</b>	Entering the PIN code .....	32
<b>Connecting your TV .....</b>	<b>7</b>	If you cannot remember your PIN code .....	32
Connecting a VCR .....	7	Using the V-CHIP menu .....	33
Connecting a cable converter box .....	8	ENABLE BLOCKING .....	33
Connecting a cable converter box and VCR .....	8	TV RATING (Independent rating system for broadcasters) .....	33
Connecting a DVD player or satellite receiver and a VCR .....	9	MPAA RATING (Independent rating system for movies) .....	34
Connecting a DVD player with ColorStream® (component video) and a VCR .....	10	BLOCKING OPTION .....	34
Connecting a DTV receiver/set-top box with ColorStream® (component video) and a VCR .....	11	Unlocking programs temporarily .....	35
Connecting two VCRs .....	12	Locking channels .....	35
Connecting a camcorder .....	12	Locking video inputs .....	36
Connecting an audio system .....	13	Using the front panel lock feature .....	37
Connecting an A/V receiver .....	13	Changing the PIN code .....	37
<b>Using the remote control .....</b>	<b>14</b>	Adjusting the picture .....	38
Preparing the remote control for use .....	14	Selecting the picture mode .....	38
Installing the remote control batteries .....	14	Adjusting the picture quality .....	38
Using the remote control with a VCR or a cable TV converter .....	14	Saving new preference .....	39
Programming the remote control for use with a non-Toshiba VCR or cable TV converter .....	15	Using the flesh tone feature .....	39
VCR code table .....	16	Using the CableClear™ DNR (digital noise reduction) feature .....	39
Cable TV converter code table .....	17	Selecting the color temperature .....	40
Learning about the remote control .....	18	Resetting picture adjustments .....	40
<b>Setting up your TV .....</b>	<b>19</b>	Selecting the cinema mode .....	40
Learning about the menu system .....	19	Selecting the video input source .....	41
Changing the on-screen display language .....	20	Labeling the video input sources .....	41
Selecting the antenna input .....	20	Using the closed caption feature .....	42
Adding channels to the TV's memory .....	21	Setting the sleep timer .....	43
Programming channels automatically .....	21	Setting the clock .....	43
Adding and erasing channels manually .....	21	Adjusting the sound .....	44
Using the Quick Connect Guide .....	22	Muting the sound .....	44
Adjusting the tilt correction feature .....	23	Selecting stereo/SAP broadcasts .....	44
Changing channels .....	23	Using the SRS™ 3D surround sound feature .....	45
Changing channels using SpeedSurf .....	23	Adjusting the sound quality .....	45
<b>Using the TV's features .....</b>	<b>24</b>	Resetting audio adjustments .....	46
Adjusting the channel settings .....	24	Using the sub-bass system (SBS) .....	46
Switching between two channels using Channel Return .....	24	Turning off the built-in speakers .....	47
Switching between two channels using Surf Lock™ .....	24	Selecting the Audio OUT sound .....	47
Programming your favorite channels .....	24	Using the StableSound® feature .....	48
Labeling channels .....	26	Selecting the background of the menu display .....	48
Viewing the wide-screen picture formats .....	27	Displaying on-screen information .....	48
Selecting the image shape .....	27	Viewing the demo mode .....	49
Watching PIP/double-window .....	29	Understanding the auto power off feature .....	49
Switching the main and sub-pictures .....	30	Understanding the last mode memory feature .....	49
Changing the position of the small picture .....	30	<b>Appendix .....</b>	<b>50</b>
Freezing the sub-picture .....	30	Specifications .....	50
		Troubleshooting .....	51
		Limited United States Warranty .....	52
		Limited Canada Warranty .....	53
		<b>Index .....</b>	<b>54</b>

## Introduction

### Welcome to Toshiba

Congratulations! You have purchased one of the finest TVs on the market. The goal of this manual is to guide you through setting up and operating your Toshiba TV as quickly as possible.

This manual applies to models 32HF72 and 36HF72. Before you start reading, check your model number by looking at the rear of the TV.

Instructions in this manual are based on using the remote control. You can also use the controls on the TV if they have the same name as those on the remote control.

Please read all the safety and operating instructions carefully, and keep the manual for future reference.

### Exploring your new TV

You can operate your TV using the buttons on the front panel or the remote control. The back panel and front panel (behind the door) provide all the terminal connections you will need to connect other equipment to your TV. See "Connecting your TV" on page 7.

### Note regarding Quick Connect Guide

The **Quick Connect Guide** automatically appears on-screen the first time the TV is turned on. This feature provides on-screen instructions to guide you through initial setup of your TV.

To stop the **Quick Connect Guide**, either press EXIT or turn off the TV.

See page 22 for details.

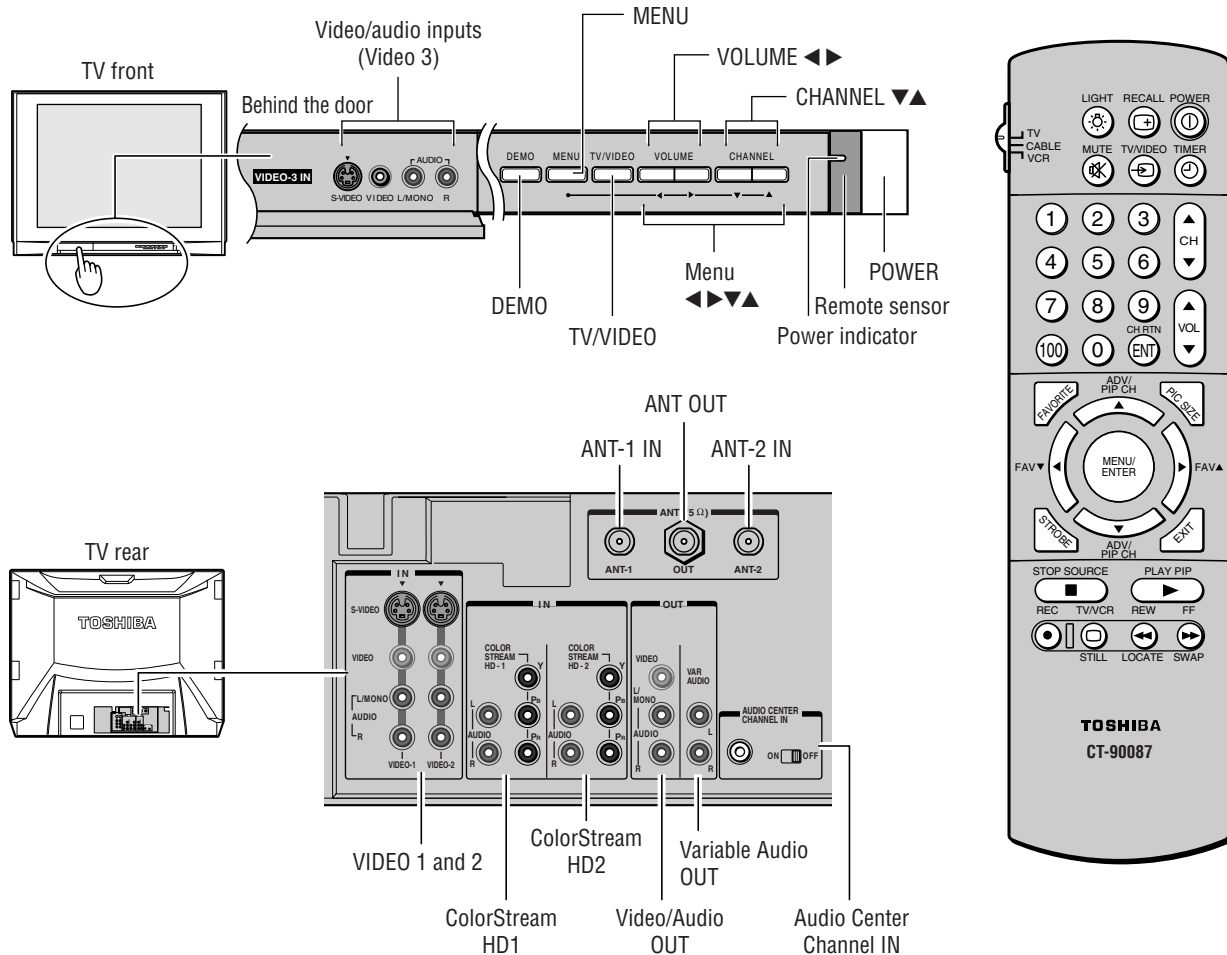

## Connecting your TV

**Note:** Cables are not supplied with your TV.

- **Coaxial cable** is the cable that comes in from your antenna, cable TV service, or cable converter box. Coaxial cable uses "F" connectors.
- **Standard stereo A/V cables** usually come in sets of three, and are typically color-coded according to use: yellow for video, red for stereo right audio, and white for stereo left (or mono) audio. Your TV's standard A/V inputs are color-coded in the same manner as the cables.
- **S-Video cable** is for use with video equipment that has S-Video connectors.
- **Component video cables** come in sets of three (typically color-coded red, green, and blue), and are for use with video equipment that has component video connectors. Your TV's ColorStream® (component video) inputs are color-coded in the same manner as the cables.

### NOTE REGARDING PICTURE QUALITY

When connecting video equipment to your Toshiba TV:

- **For GOOD picture quality:** Use a standard yellow video cable.
- **For BETTER picture quality:** If your equipment has S-video connectors, use an S-video cable *instead of* a standard yellow video cable. (You still must connect the standard red and white audio cables for full system connection, but *do not connect a standard yellow video cable at the same time* or the picture performance will be unacceptable.)
- **For BEST picture quality:** If your equipment has component video connectors, use component video cables *instead of* a standard yellow video cable or S-video cable. (You still must connect the standard red and white audio cables for full system connection.)

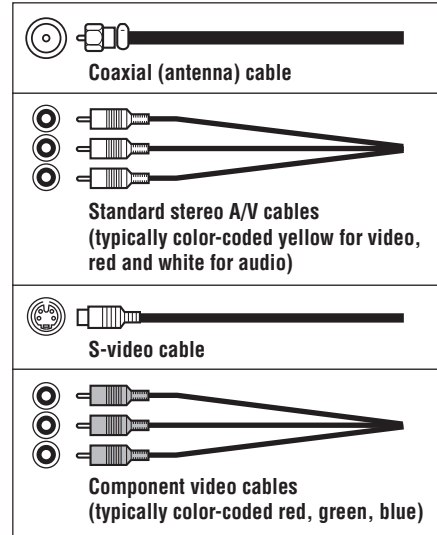

**CAUTION:** Do not plug in any power cords until you have finished connecting all equipment.

## Connecting a VCR

This connection allows you to watch local channels and video programs, play or record on the VCR while watching TV, and record from one channel while watching another channel.

You will need:

- two coaxial cables (one or more may be provided by your cable company)
- one set of A/V cables

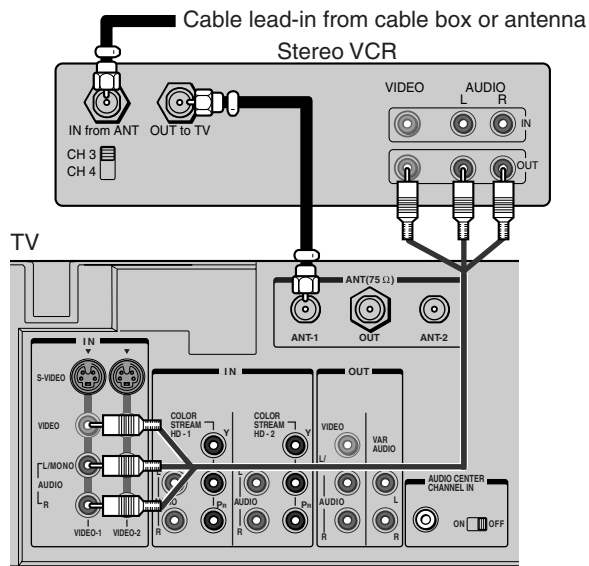

### Note:

If you have a mono VCR, connect L/Mono to VCR Audio OUT using only one audio cable.

If you have an S-VHS VCR, use an S-video cable (in the S-video jacks) instead of the standard video cable.

Do not connect a standard video cable and an S-video cable to Video-1 (or Video-2) at the same time, or the picture performance will be unacceptable.

The unauthorized recording, use, distribution, or revision of television programs, videotapes, DVDs, and other materials is prohibited under the Copyright Laws of the United States and other countries, and may subject you to civil and criminal liability.

## Connecting a cable converter box

This connection allows you to watch basic and premium cable channels.

To use the TV's features, select ANT-1. To view premium channels, select ANT-2, tune the TV to channel 3 or 4 (whichever channel is vacant in your area), and use the converter box to change channels.

You will need:

- three coaxial cables (one or more may be provided by your cable company)

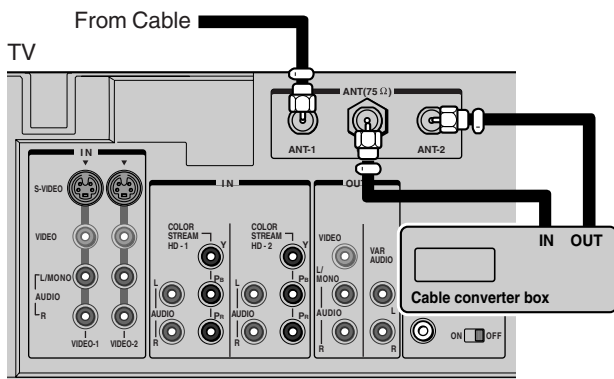

### Note:

When you use a converter box with your TV, the remote control will not operate some features, such as programming your favorite channels, labeling channels, and locking channels.

## Connecting a cable converter box and VCR

This connection allows you to watch and record basic and premium cable channels, watch videotapes, and record one channel while watching another channel. To use the TV's features, select ANT-1.

To view premium channels or record with the VCR, select ANT-2, tune the TV to channel 3 or 4 (whichever channel is vacant in your area), and use the converter box to change channels.

You will need:

- four coaxial cables (one or more may be provided by your cable company)
- one set of standard A/V cables

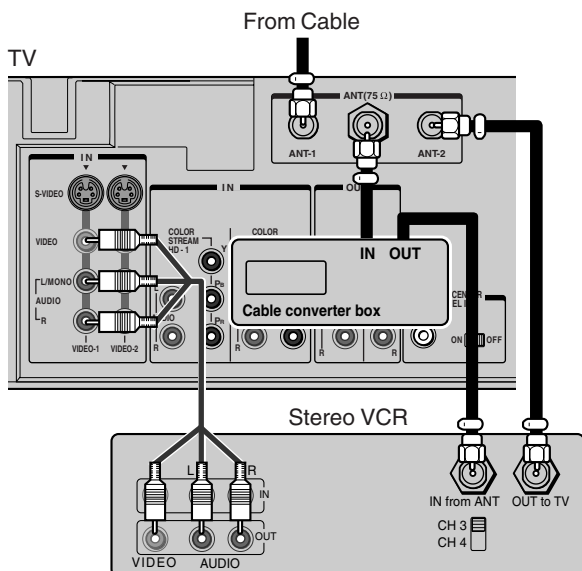

### Note:

If you have a mono VCR, connect L/Mono to VCR Audio OUT using only one audio cable.

If you have an S-VHS VCR, use an S-video cable (in the S-video jacks) instead of a standard video cable. Do not connect a standard video cable and an S-video cable to Video-1 (or Video-2) at the same time, or the picture performance will be unacceptable.

When you use a converter box with your TV, the remote control will not operate some features, such as programming your favorite channels, labeling channels, and blocking channels.

The unauthorized recording, use, distribution, or revision of television programs, videotapes, DVDs, and other materials is prohibited under the Copyright Laws of the United States and other countries, and may subject you to civil and criminal liability.



## Connecting a DVD player or satellite receiver and a VCR

This connection allows you to watch DVD/satellite, VCR, and TV programs, record one TV channel while watching another channel, and record satellite channels.

You will need:

- two (or three, if satellite receiver is used) coaxial cables (one or more may be provided by your cable or satellite company)
- two sets of standard A/V cables
- one pair of standard audio cables
- one S-video cable (between the TV and DVD player/satellite receiver)

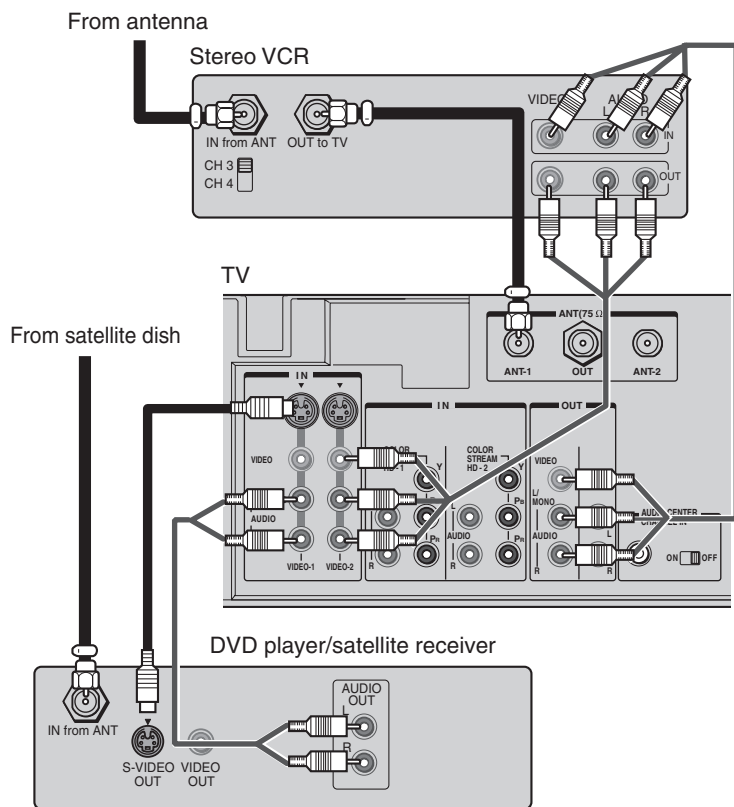

### Note:

For the highest possible picture quality from a non-component video DVD player/satellite receiver, use an S-video cable between the TV and DVD player/satellite receiver. (If your DVD player or satellite receiver has component video connections, see page 10).

Do not connect both an S-video cable and a standard video cable between the TV and DVD player/satellite receiver at the same time, or the picture performance will be unacceptable.

Do not connect the DVD player/satellite receiver and VCR to the same video channel on the TV. (See the illustrations, which show the DVD player/satellite receiver connected to Video-1 on the TV and the VCR connected to Video-2 on the TV.)

The unauthorized recording, use, distribution, or revision of television programs, videotapes, DVDs, and other materials is prohibited under the Copyright Laws of the United States and other countries, and may subject you to civil and criminal liability.

## Connecting a DVD player with ColorStream® (component video) and a VCR

This connection allows you to watch DVD, VCR, and TV programs, and record TV programs.

Your TV has ColorStream® (component video) inputs. Connecting your TV to a DVD player with component video (such as a Toshiba DVD player with ColorStream®) can greatly enhance picture quality and realism.

- To record one TV program while watching another TV program, tune the VCR to the channel to record, and tune the TV to the channel to watch.
- To record a TV program while watching a DVD, tune the VCR to the channel to record, and select VIDEO 1 on the TV (see “Selecting the antenna input” on page 20).

You will need:

- two coaxial cables (one or more may be provided by your cable company)
- two sets of standard A/V cables
- one pair of audio cables
- one set of component video cables (one S-video cable for a DVD player without component video; see notes at right)

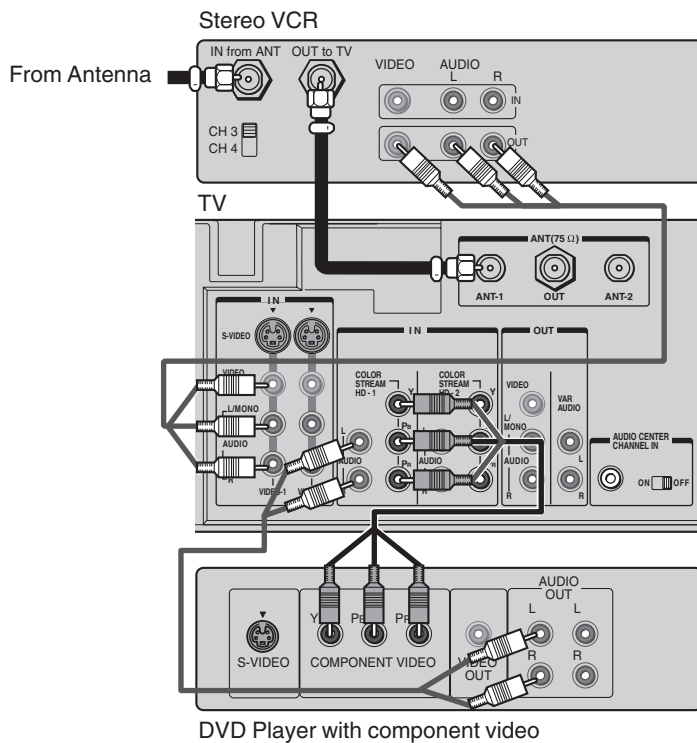

### Note:

For the highest possible picture quality, use component video cables between the TV and DVD player. You can connect the component video cables from the DVD player to either ColorStream jack on the TV (HD1 or HD2).

The ColorStream HD1 and HD2 jacks can be used with Progressive (480p) and Interlaced (480i, 1080i) scan systems.

If your DVD player does not have component video connections, use the S-video connections (plus the standard audio connections) instead of the ColorStream connections; however, do not connect both S-Video and standard video cables between the TV and DVD player at the same time.

The unauthorized recording, use, distribution, or revision of television programs, videotapes, DVDs, and other materials is prohibited under the Copyright Laws of the United States and other countries, and may subject you to civil and criminal liability.

## Connecting a DTV receiver/set-top box with ColorStream® (component video) and a VCR

This connection allows you to watch DTV (digital TV), VCR, and TV programs, and record DTV and TV programs.

Your TV has ColorStream (component video) inputs. Connecting your TV to a DTV receiver with component video can greatly enhance picture quality and realism.

- To record and watch a DTV program, select LINE IN on the VCR, and select ColorStream HD2 (or VIDEO 1 for a non-ColorStream connection) on the TV (see “Selecting the antenna input” on page 20).
- To record a TV program while watching a DTV program, tune the VCR to the channel to record, and select ColorStream HD2 on the TV.
- To record and watch the same TV program, tune the VCR to the channel to record, and select VIDEO 1 on the TV.
- To record one TV program while watching another TV program, tune the VCR to the channel to record, and tune the TV to the channel to watch.

You will need:

- three coaxial cables (one or more may be provided by your cable company)
- two sets of standard A/V cables
- one pair of audio cables
- one set of component video cables (one S-video cable for a DTV receiver without component video; see notes at right)

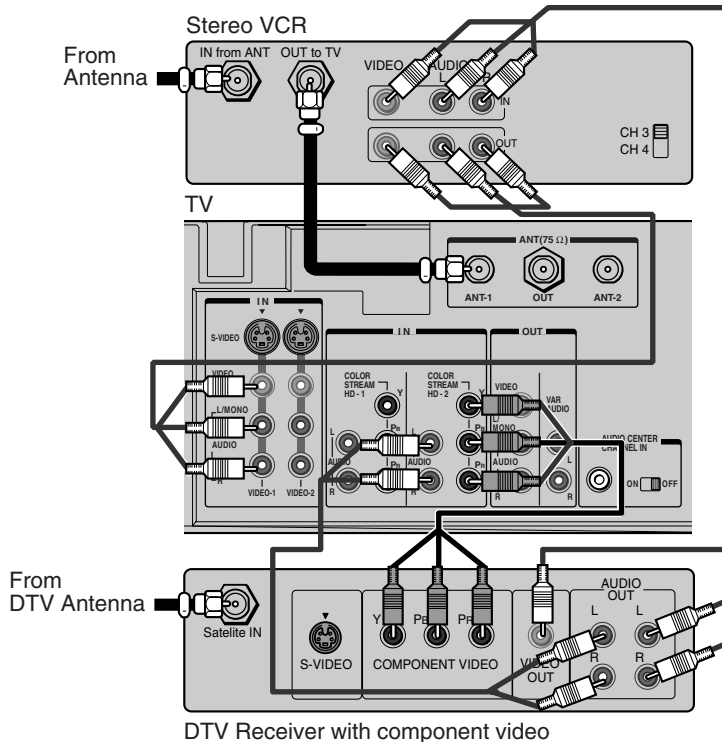

### Note:

For the highest possible picture quality, use component video cables between the TV and DTV receiver. You can connect the component video cables from the DTV receiver to either ColorStream jack on the TV (HD1 or HD2).

The ColorStream HD1 and HD2 jacks can be used with Progressive (480p) and Interlaced (480i, 1080i) scan systems.

If your DTV receiver does not have component video connections, use the S-video connections (plus the standard audio connections) instead of the ColorStream connections. Do not connect both an S-video and a standard video cable between the TV and DTV receiver at the same time.

To monitor recording, set the TV to VIDEO 1.

The unauthorized recording, use, distribution, or revision of television programs, videotapes, DVDs, and other materials is prohibited under the Copyright Laws of the United States and other countries, and may subject you to civil and criminal liability.

## Connecting two VCRs

This connection allows you to record (dub/edit) from one VCR to another VCR while watching a videotape. You can also record from one TV channel while watching another TV channel.

You will need:

- two coaxial cables (one or more may be provided by your cable company)
- two sets of standard A/V cables

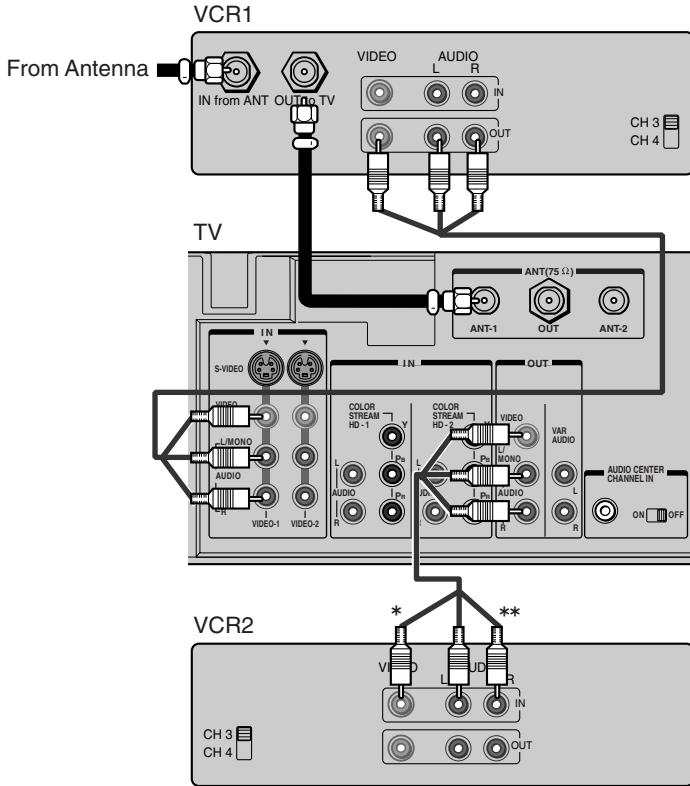

**Note:**

If you have S-VHS VCRs, use S-video cables instead of standard video cables for better picture performance. Do not connect both a standard video cable and an S-video cable to Video-1 (or Video-2) at the same time, or the picture performance will be unacceptable.

Do not connect the same VCR to the output and input jacks on the TV at the same time.

To dub or edit, VCR 2 must select Line IN, and the TV must select VIDEO 1 (see "Selecting the antenna input" on page 20).

\* The Video OUT jack does not output the PIP picture.

\*\* The Audio OUT jacks can output the sound of either the Main or PIP picture (see "Selecting the Audio OUT sound" on page 47).

The unauthorized recording, use, distribution, or revision of television programs, videotapes, DVDs, and other materials is prohibited under the Copyright Laws of the United States and other countries, and may subject you to civil and criminal liability.

## Connecting a camcorder

This connection allows you to watch video materials recorded on a camcorder.

You will need:

- one set of standard A/V cables

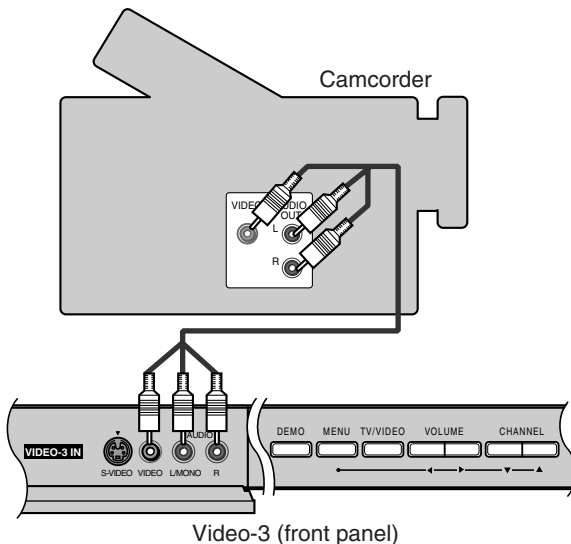

**Note:**

If you have an S-VHS camcorder, use an S-video cable between the S-video jacks on the camcorder and TV instead of a standard video cable. Do not connect both a standard video cable and an S-video cable at the same time, or the picture performance will be unacceptable.

## Connecting an audio system

This connection allows you to use an audio amplifier to adjust the audio level. This also allows you to use external speakers.

To control the audio, turn on the TV and the stereo amplifier, and turn off the built-in speakers (see “Turning off the built-in speakers” on page 47).

You will need:

- one pair of audio cables

### Note:

To hear sound when using an external audio amplifier, the volume of both the TV and the amplifier must be set above 0 (zero).

For example, if the volume of the TV is set to 0, you will not be able to hear any sound, even if the volume of the amplifier is at its highest level.

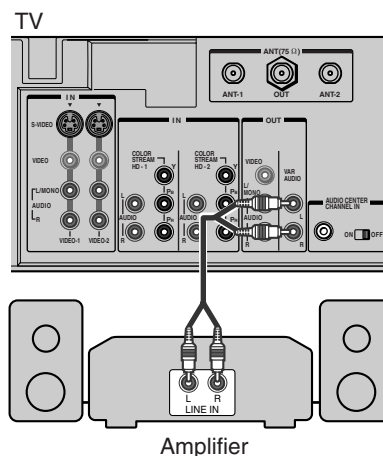

## Connecting an A/V receiver

This connection allows you to use an audio/video (A/V) receiver to enhance your TV's sound.

If you have a system with Dolby Pro Logic® surround sound, you can add to the realism of the sound by using the TV's internal speakers as center channel speakers.

You will need:

- one coaxial cable (may be provided by your cable company)
- one set of standard A/V cables
- one single audio cable for the audio center channel

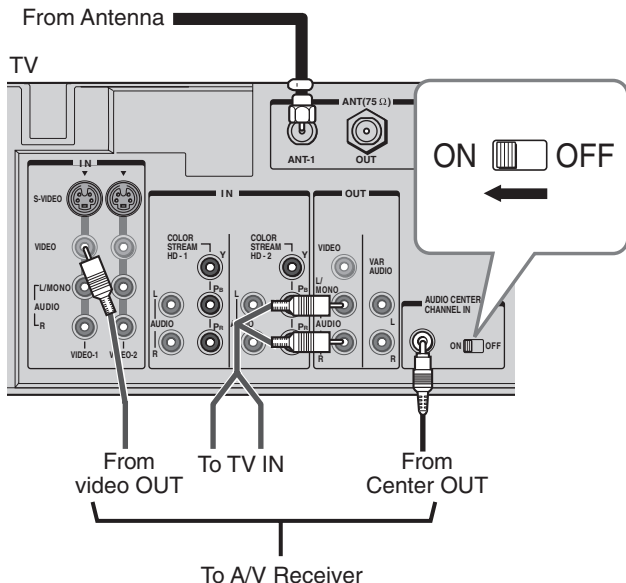

### Note:

Refer to the instructions provided with your A/V receiver for details about your surround sound system.

When the Audio Center Channel ON/OFF switch is in the ON position, the TV speakers will function only as center channel speakers. At this time, the SBS feature should be set to OFF. See page 46.

Adjust the volume for the center channel speakers using the center level control on the A/V receiver.

To use the TV speakers as normal speakers, set the Audio Center Channel ON/OFF switch to the OFF position.

### Caution:

To avoid damaging the speakers:

- Turn off the TV before connecting or disconnecting the Audio Center Channel cable.
- Do not connect from the A/V receiver's Center Speaker OUT (amplified signal) to the TV's Audio Center Channel IN.

### Dolby Pro Logic\* surround sound system connection example

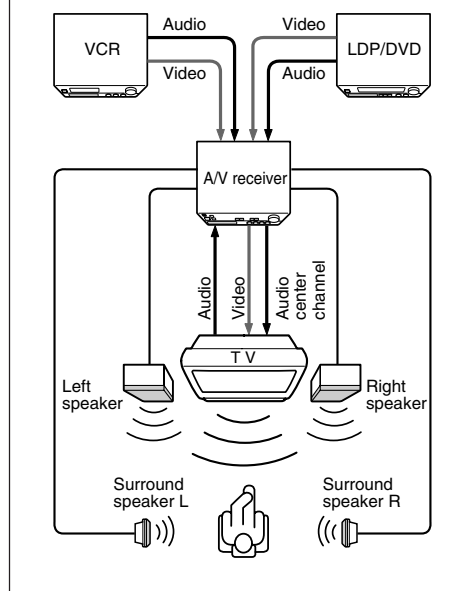

\*Dolby Pro Logic is a registered trademark of Dolby Laboratories Licensing Corporation.

## Using the remote control

### Preparing the remote control for use

With the remote control, you can operate your TV, most VCR models, and cable TV converters together, even if they are different brands. If you will be using your TV with a Toshiba VCR, your remote control is already programmed and ready to use. If you own different brands of VCRs and/or converters, you first have to program your remote control. (See “Programming the remote control for use with a non-Toshiba VCR or a cable TV converter” on page 15.)

### Installing the remote control batteries

To install the batteries:

1. Slide the battery cover off the back of the remote control.

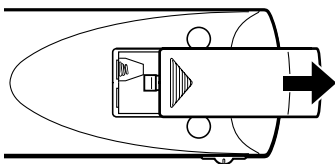

2. Install two “AA” size alkaline batteries. Match the + and - signs on the batteries to the signs on the battery compartment.

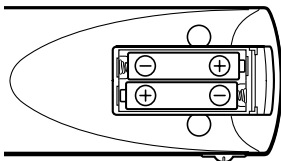

3. Slide the battery cover back on to the remote control until the lock snaps.

### Using the remote control with a VCR or a cable TV converter

To control a VCR:

If you have a non-Toshiba VCR, program the remote control to recognize your VCR brand (see “Programming the remote control for use with a non-Toshiba VCR or a cable TV converter” on page 15).

Set the TV/CABLE/VCR switch to the VCR position. The shaded buttons shown at right will then control the VCR. The unshaded buttons will operate the TV as usual.

To control a cable TV converter:

If you have a non-Toshiba cable TV converter, program the remote control to recognize your converter brand (see “Programming the remote control for use with a non-Toshiba VCR or a cable TV converter” on page 15).

Set the TV/CABLE/VCR switch to the CABLE position. The shaded buttons in the top portion of the illustration at right will control the cable TV converter.

#### Note:

Your TV's remote control may not operate certain features on your VCR, cable TV converter, or other electronic device.

Refer to the owner's manuals for your other devices to determine their available features.

If your TV's remote control does not operate a specific feature on a device, use the remote control that came with the device.

#### Caution:

- Dispose of batteries in a designated disposal area. Do not throw batteries into a fire.
- Do not mix battery types or combine used batteries with new ones.
- If the remote control does not operate correctly, or if the operating range becomes reduced, replace both batteries with new ones.
- If the batteries are dead or if you will not use the remote control for a long time, remove the batteries to prevent battery acid from leaking into the battery compartment.

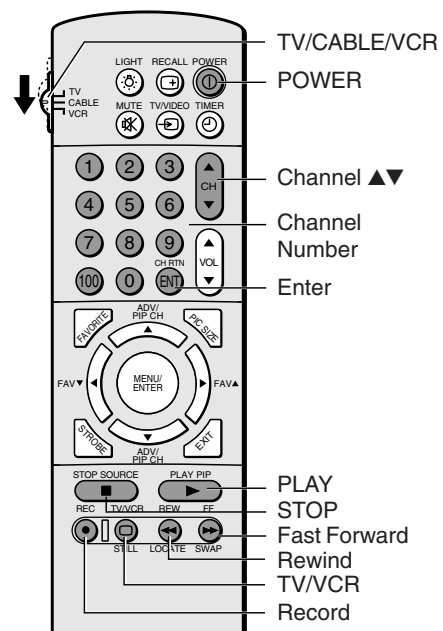

## Programming the remote control for use with a non-Toshiba VCR or a cable TV converter

The remote control is pre-programmed to operate Toshiba VCRs. To use the remote control to operate a non-Toshiba VCR or cable converter, follow the steps below to program the remote control.

1. Refer to the "VCR code table" or "Cable TV converter code table" on pages 16–17 to find the corresponding code for your VCR or cable TV converter brand.  
If more than one code is listed, try each one separately until you find the one that works.
2. If you are reprogramming the remote control to operate your:
  - **VCR:** Set the TV/CABLE/VCR switch on the remote control to VCR.
  - **Cable converter:** Set the TV/CABLE/VCR switch on the remote control to CABLE.
3. While holding down the RECALL button, press the Number buttons (0–9) to enter the three-digit code for your VCR or cable TV converter.
4. Point the remote control at the VCR or converter and press POWER to test the code.  
If the VCR or converter responds, you have entered the correct code.  
If the VCR or converter does not respond, you may have entered the wrong code. Repeat steps 1–4 using another code.
5. Reset the TV/CABLE/VCR switch to TV to control the TV.

For future reference, write down the code(s) you used:

VCR code \_\_\_\_\_

Cable TV converter code \_\_\_\_\_

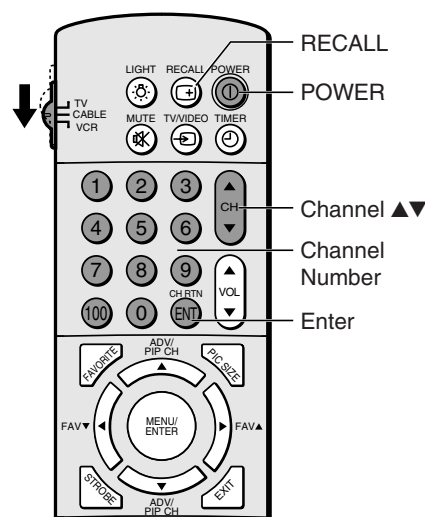

### Note:

- Each time you replace the batteries, you must reprogram the remote control.
- Some newer VCRs are capable of working on either of two remote codes. These VCRs have a switch labeled "VCR1/VCR2." If your VCR has this kind of switch and does not respond to any of the codes for your VCR brand, set the switch to the other position (VCR1 or VCR2) and reprogram the remote control.

**VCR code table**

<b>Brand name</b>	<b>Code number</b>				
Adventura	019	Jensen	060	Quasar	054,096
Aiko	297	JVC	027,060,086	Radio Shack	019,056,344
Aiwa	019	Kenwood	057,060,086	Radix	056
Akai	060,068,080,125, 261	KLH	091	Randex	056
American High	054	Kodak	054,056	RCA	061,079,084,096, 124,125,168,221
Asha	259	Lloyd	019	Realistic	019,054,056,065, 066,067,081,085, 123,259
Audiovox	056	Lloyd's	227	Ricoh	053
Beaumarck	259	Logik	091	Runco	058
Bell & Howell	123	LXI	056	Samsung	064,259
Brandt	206	Magnavox	054,058,100,129, 168	Sanky	058,067
Broksonic	140,203,230,314, 380	Magnin	259	Sansui	060,086
Calix	056	Marantz	054,100	Sanyo	065,066,123,259
Canon	054	Marta	056	Scott	062,064,140,203, 229,230,231
Capehart	039	Masushita	054	Sears	054,056,061,065, 066,073,085,123, 124
Carver	100	MEI	054	Sharp	067,081
CCE	091,297	Memorex	019,054,056,058, 065,066,067,123, 259	Shintom	091
Citizen	056,297	MGA	062,080	Shogun	259
Colt	091	MGN Technology	259	Singer	091
Craig	056,066,091,259	Minolta	061,124	Sony	051,052,053,054
Curtis Mathes	054,060,079	Mitsubishi	062,080,086,094, 192,233,261	STS	061
Cybernex	259	Motorola	054,067	Sylvania	019,054,062,100, 129
Daewoo	039,064,297	MTC	019,259	Symphonic	019,344
Daytron	039	Multitech	019,091	Tatung	060
Dynatech	019	Nad	077	Teac	019,060
Electrohome	056	NEC	057,059,060,069, 086	Technics	054,181
Electroponic	056	Nikko	056	Teknika	019,054,056,071
Emerex	051	Noblex	259	Telefunken	060,206
Emerson	019,021,056,062, 080,087,140,203, 227,228,230,231, 297,313,314,380, 498	Olympus	054	TMK	227,259
Fisher	066,073,085,123	Optimus	056,067,077,123	Toshiba	062,064,085,229, 231,385
Fuji	052,054	Optonica	081	Totevision	056,259
Funai	019,344	Orion	498	Unitech	259
Garrard	019,344	Panasonic	054,096,181,244	Vector	064
GE	054,079,084,221	Penney	054,056,057,059, 061,073,259	Vector Research	057,059
Go Video	251,298	Pentax	061,084,124	Video Concepts	059,064,080
Goldstar	037,056,057	Philco	054	Videosonic	259
Gradiente	019	Philips	054,081,100,129	Wards	019,054,061,066, 067,081,091,168, 231,259
Harley Davidson	019	Pilot	056	XR-1000	019,054,091
Harman/Kardon	057,094	Pioneer	077,086	Yamaha	057
Harwood	087,091	Portland	039	Zenith	052,053,058
Headquarter	065	Protec	091		
HI-Q	066	Pulsar	058		
Hitachi	060,061,084,124, 254	Quarter	065		
		Quartz	065		



## Cable TV converter code table

Brand name	Code number		
ABC	020,022,026,027,	Samsung	059,163
	030,032,033,036,	Scientific Atlanta	025,027,036,296
	066	Signal	034,059
Antronix	041	Signature	030
Archer	041,058,172	SL Marx	059
Belcor	075	Sprucer	040
Cable Star	075	Standard	
Cabletenna	041	Components	174
Cableview	041	Starcom	022,034,066
Century	172	Stargate	034,059
Citizen	172	Starquest	034
Colour Voice	044,050	Sylvania	020
Comtronics	059,079	Teleview	059
Contec	038	Texscan	020
Dae Ryung	027	Tocom	031,032,078
Eastern	021	Toshiba	019
Focus	419	Tusa	034
Garrard	172	Unika	041,172
GC Electronics	035,075	United Artists	026
Gemini	034,089	United Cable	022
General Instrument	030,295	Universal	041,058,075,096,
GoldStar	059,163		172,210
Hamlin	028,039,053,278,	Viewstar	046,079,230
	292	Zenith	019
Hitachi	030	Zentek	419
Hytex	026		
Jasco	172		
Jerrold	022,030,031,033,		
	034,043,066,295		
Macom	052		
Magnavox	046		
Memorex	019		
Movie Time	175		
NSC	089,175		
Oak	026,038,267		
Panasonic	019,040,126		
Paragon	019		
Philips	044,046,047,048,		
	049,050,172		
Pioneer	042,163,552		
Popular Mechanics	419		
Pulsar	019		
RCA	040		
Recoton	419		
Regal	039,278,292		
Regency	021		
Rembrandt	030,089		
Runco	019		

## Learning about the remote control

**POWER** turns the TV on and off

**RECALL** displays screen information (page 48)

**LIGHT** illuminates the keypad for five seconds

**TIMER** sets the TV to turn off at a specific time (page 43)

**TV/VIDEO** selects video input source (pages 20, 41)

**MUTE** mutes the sound (page 44)

**TV/CABLE/VCR** switches between TV, Cable and VCR (pages 14-15)

**Channel ▲ ▼** cycles through programmed channels (page 23)

**Channel Numbers** allow direct access to channels (page 23)

**Volume ▲ ▼** adjusts the volume level

**CH RTN** returns to the memorized channel (page 24)

**PICTURE SIZE** cycles through the three picture formats: Normal, Letterbox, and Compression (page 27)

**MENU** allows access to on-screen programming menus (page 19)

**ENTER** sets programmed menu information (page 19)

**▲ ▼ ◀ ▶** select or adjust programming menus (page 19)

**PIP Channel ▲ ▼** selects the PIP (sub-picture) channel (page 29)

**FAV ▼ ▲** cycles through favorite channels (page 25)

**FAVORITE** allows access to the favorite channel search function (page 31)

**STROBE** allows access to multi-window function (page 31)

**EXIT** exits programming menus (page 19)

**PIP** turns the PIP/double-window feature on and off (page 29)

**SOURCE** selects the PIP/double-window picture source (page 29)

**STILL** freezes the PIP/double-window picture (page 30)

**LOCATE** moves the small picture (page 30)

**SWAP** switches the main and sub pictures (page 30)

**VCR Functions** allow access to VCR functions (page 14)

**STOP** stops a videotape

**REC** starts recording a videotape

**PLAY** plays a videotape

**FF** fast forwards a videotape

**REW** rewinds a videotape

**TV/VCR** toggles between TV and VCR when viewing while recording

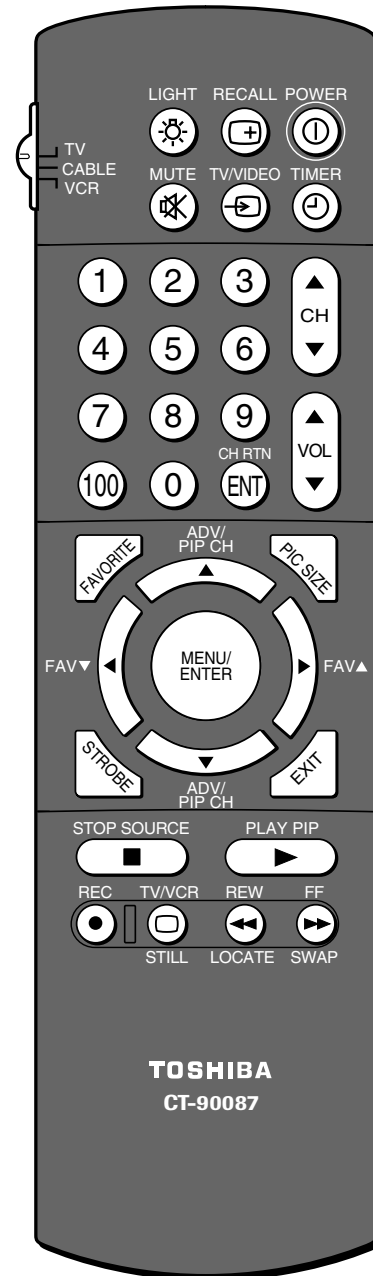

**Note:**

The error message "Not Available" will appear if you press a key for a function that is not available.

# Setting up your TV

## Learning about the menu system

After you have installed the batteries and programmed the remote control, you will need to set some preferences on the TV using the menu system. You can access the menus using the buttons on your TV or remote control.

1. Press MENU to display menu.
2. Press ◀ or ▶ to select menu.
3. Press ▲ or ▼ select an item.
4. Press ◀ or ▶ to select or adjust a setting.

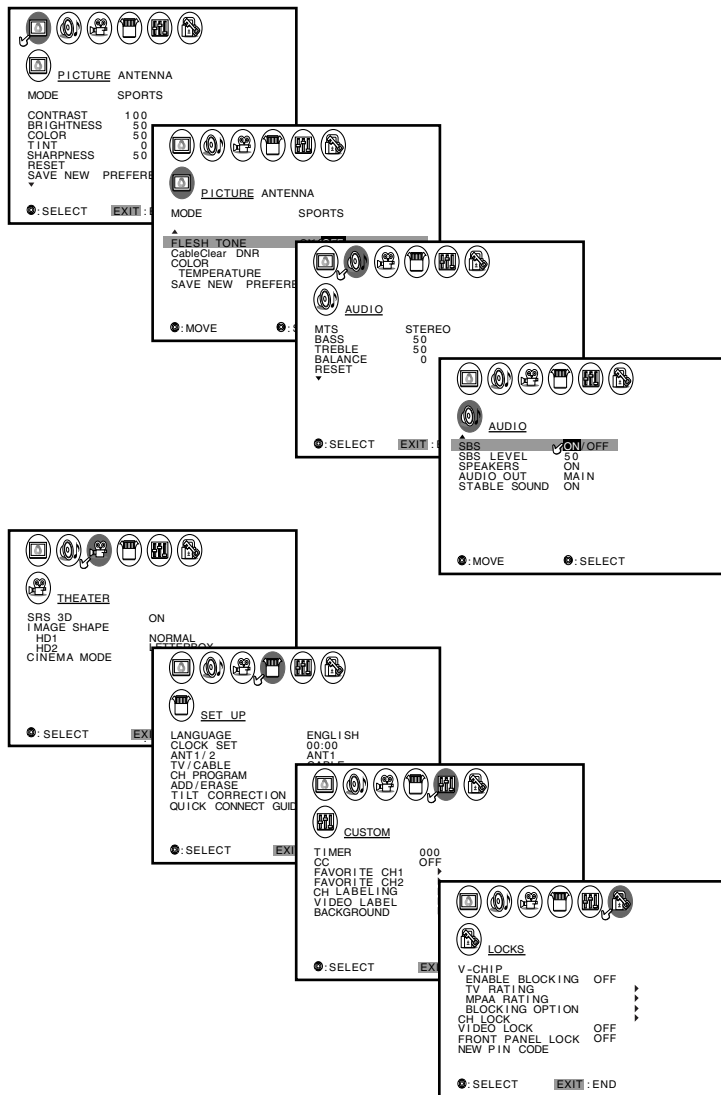

- Press ENTER to activate the function settings in the menus.
- The main menu display will disappear automatically if you do not make a selection within 15 seconds. If you want to close all the on-screen displays instantly, press EXIT.

## Note regarding Quick Connect Guide

The **Quick Connect Guide** automatically appears on-screen the first time the TV is turned on. This feature provides on-screen instructions to guide you through initial setup of your TV.

To stop the **Quick Connect Guide**, either press EXIT or turn off the TV.

See page 22 for details.

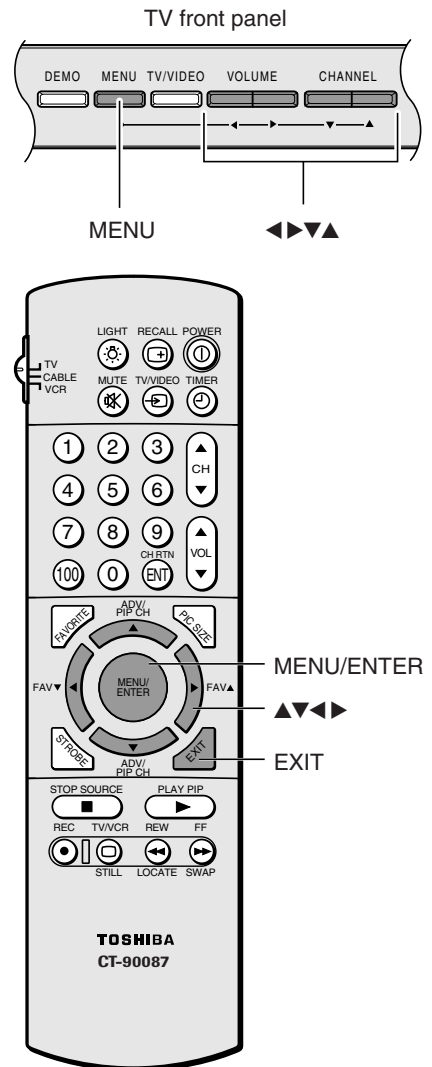

### Note:

You can change the background of the menu. See page 48 for details.

## Changing the on-screen display language

Choose from three different languages (English, French and Spanish) for the on-screen display of adjustment menus and messages.

To select a language:

1. Press MENU, and then press ◀ or ▶ until the SET UP menu appears.
2. Press ▲ or ▼ to highlight LANGUAGE.

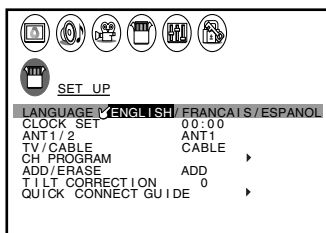

3. Press ◀ or ▶ to highlight your desired language.

## Selecting the antenna input

You can connect to two different antenna input sources (ANT 1 or ANT 2).

To select the antenna input using the TV/VIDEO button:

1. Press TV/VIDEO on the remote control or the TV (see illustrations below). The current signal source displays in purple.
2. Continue pressing the TV/VIDEO button to select ANT 1 or ANT 2.

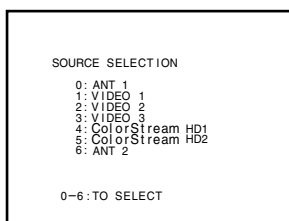

Pressing TV/VIDEO on the remote control displays the current signal source (press TV/VIDEO again or 0-6 to change)

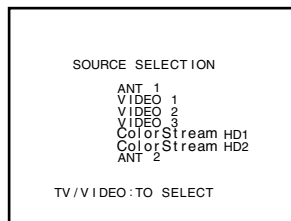

Pressing TV/VIDEO on the TV changes the current signal source

To select the antenna input using the menu system:

1. Press MENU, and then press ◀ or ▶ to highlight the SET UP menu.
2. Press ▲ or ▼ to highlight ANT 1/2.

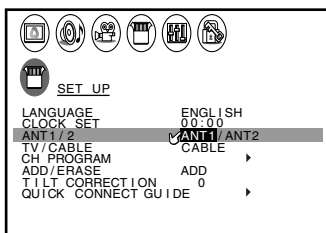

3. Press ◀ or ▶ to highlight either ANT 1 or ANT 2, depending on the antenna terminal you wish to use.

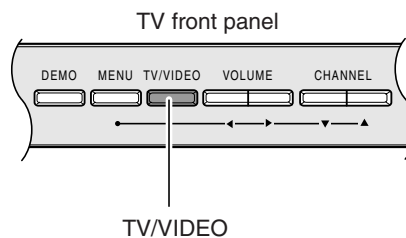
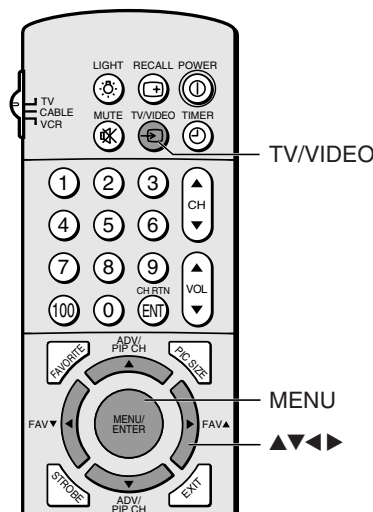
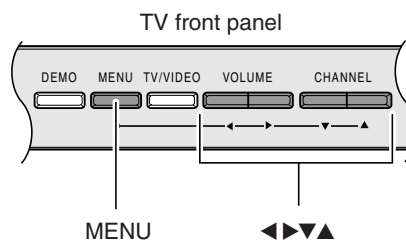

## Adding channels to the TV's memory

When you press Channel ▲ or ▼, your TV will stop only on the channels stored in the TV's channel memory.

Follow the steps below and on the next page to program all active channels into the TV's memory.

### Programming channels automatically

Your TV can automatically detect all active channels in your area and store them in its memory. After the channels are stored automatically, you can manually add or erase individual channels (see below).

To program channels automatically:

1. Press MENU, and then press ◀ or ▶ until the SET UP menu appears.
2. Press ▲ or ▼ until the TV/CABLE is highlighted.
3. Press ◀ or ▶ to highlight either TV or CABLE, depending on which you use. If you use an antenna, highlight TV; if you use cable, highlight CABLE.

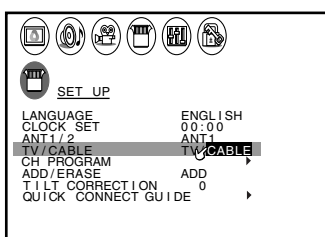

4. Press ▼ to select CH PROGRAM.

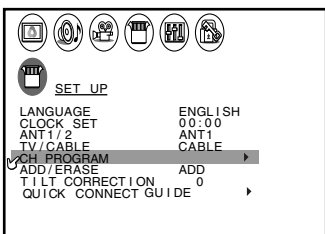

5. Press ◀ or ▶ to start channel programming. The TV will automatically cycle through all the TV or Cable channels (depending on which you selected), and store all active channels in the channel memory.

While the TV is cycling through the channels, the message "Programming Now—Please Wait" appears.

6. When channel programming is complete, the message "Completed" appears.
7. Press Channel ▲ or ▼ to view the programmed channels.

### Adding and erasing channels manually

After you have programmed the channels automatically, you can manually add or erase specific channels.

To add or erase channels:

1. Select the channel you want to add or erase. If you are adding a channel, you must select the channel using the Channel Number buttons.
2. Press MENU, and then press ◀ or ▶ until the SET UP menu appears.

#### Note:

To tune the TV to a channel not programmed in the channel memory, you must use the Channel Number buttons on the remote control.

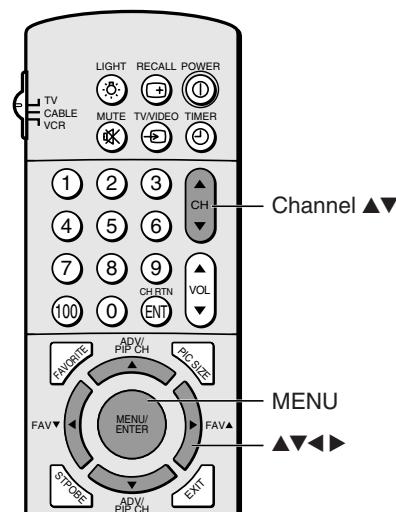

(continued on next page)

3. Press ▲ or ▼ to highlight ADD/ERASE.

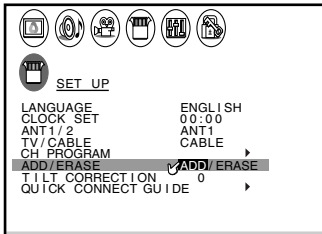

4. Press ◀ or ▶ to select ADD or ERASE, depending on the function you want to perform.
5. Repeat steps 1–4 for other channels you want to add or erase.

## Using the Quick Connect Guide

The Quick Connect Guide automatically starts the first time the TV is turned on. This feature provides on-screen instructions to guide you through initial setup of your TV.

You can change the current settings any time.

1. Press MENU, and then press ◀ or ▶ until the SET UP menu appears.
2. Press ▲ or ▼ to highlight “QUICK CONNECT GUIDE.”

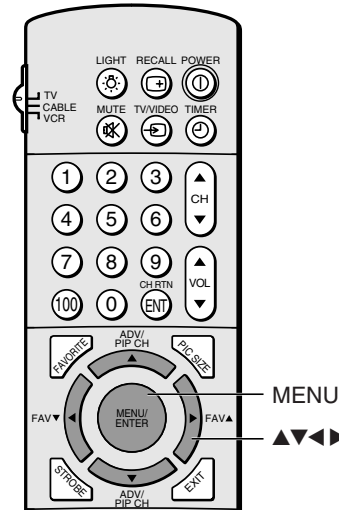
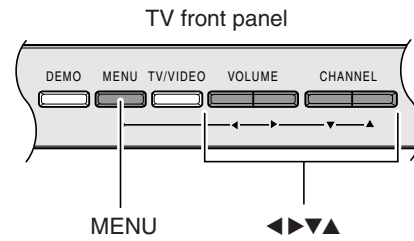
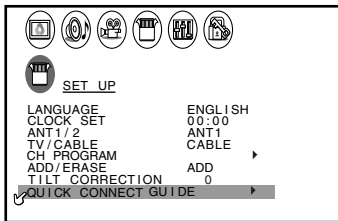

**Note:**

To stop the Quick Connect Guide, press EXIT or turn off the TV.

3. Press ◀ or ▶ to enter the Quick Connect Guide mode.  
Advance the setup according to the guide displayed on-screen.
  - Press ◀ or ▶ to make a selection.
  - Press MENU to continue to the next screen.

The Quick Connect Guide will guide you through the following items.

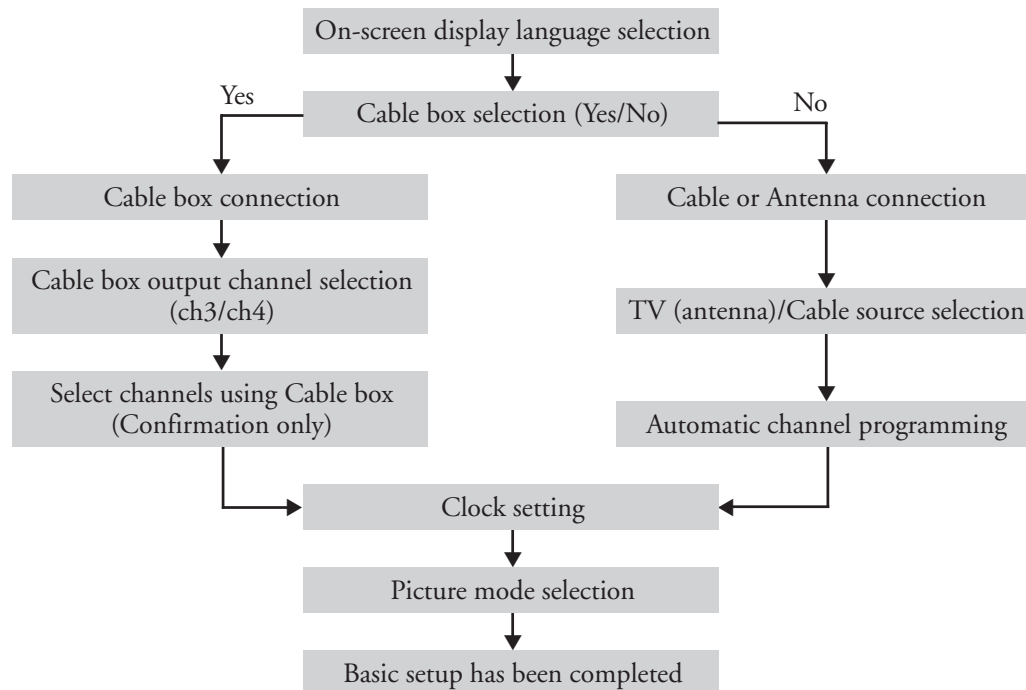

## Adjusting the tilt correction feature

When you install the TV or change the direction of the TV, the picture may suffer from color shading and/or tilt of the picture because of terrestrial magnetism. If so, the following adjustment should be made for the best possible picture.

To adjust the tilt correction:

1. Press MENU, then press ◀ or ▶ until the SET UP menu appears.
2. Press ▲ or ▼ to highlight TILT CORRECTION.
3. Press ◀ or ▶ to correct any tilt of the picture between +10 and -10.

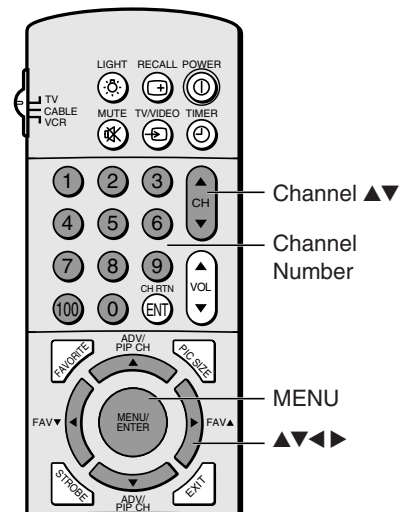
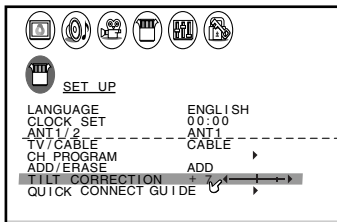

TV front panel

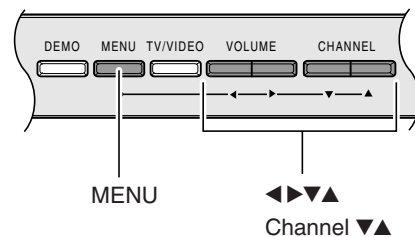

## Changing channels

To change to a specific channel (programmed or unprogrammed):

Press the Channel Number buttons (0–9 and 100).

For channels 100 and higher, press the 100 button, and then the next two numbers. For example, to select channel 125, press 100, 2, 5.

To change to the next programmed channel:

Press Channel ▲ or ▼ on the TV or remote control.

## Changing channels using SpeedSurf

To use SpeedSurf to change to a specific programmed channel:

1. Press and hold Channel ▲ or ▼ for about one second. The TV will enter the SpeedSurf mode.

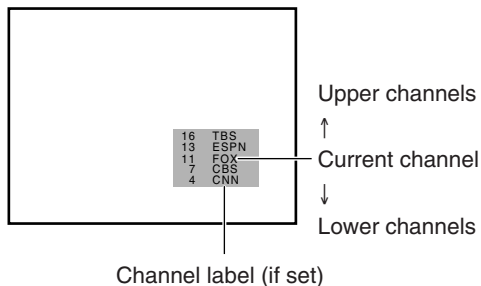

2. Repeatedly press or hold Channel ▲ or ▼ while the SpeedSurf mode is on-screen to scroll the channel list. Release the button to display the highlighted channel.

# Using the TV's features

## Adjusting the channel settings

### Switching between two channels using Channel Return

The Channel Return feature allows you to switch between two channels without entering an actual channel number each time.

1. Select the first channel (or video mode) you want to view.
2. Select a second channel using the Channel Number buttons (0–9, 100).
3. Press CH RTN. The previous channel will display.

Each time you press CH RTN, the TV will switch back and forth between the last two channels that were selected.

### Switching between two channels using SurfLock™

The SurfLock™ feature temporarily “memorizes” one channel in the CH RTN button, so you can return to that channel quickly from any other channel by pressing CH RTN.

To memorize a channel in the CH RTN button:

1. Select the channel you want to program into the CH RTN button.
2. Press and hold CH RTN for about 2 seconds until the message “Channel Memorized” appears (flashing) on the screen. The channel has been programmed into the CH RTN button.
3. Continue to change channels until your desired channel is selected.
4. Press CH RTN. The memorized channel will be selected.

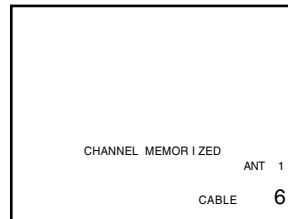

The TV will return to the memorized channel one time only. Once you press CH RTN and then change channels again, the CH RTN button memory will be cleared and the button will function as Channel Return, by switching back and forth between the last two channels that were selected.

### Programming your favorite channels

You can preset up to 9 of your favorite channels each for FAVORITE CH1 and FAVORITE CH2 modes using the Favorite Channel Programming feature. Because this feature scans through only your favorite channels, it allows you to skip other channels you do not normally watch.

To program your favorite channels:

1. Press MENU, and then press ◀ or ▶ until the CUSTOM menu appears.
2. Press ▲ or ▼ to highlight FAVORITE CH1 or FAVORITE CH2.

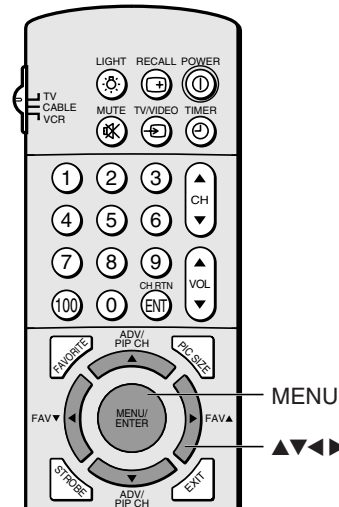
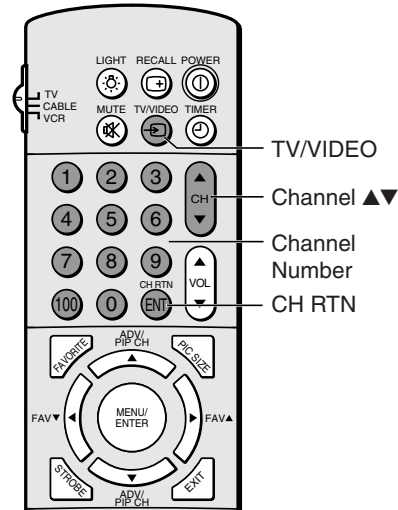
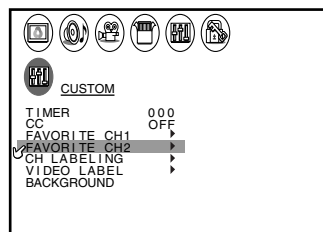
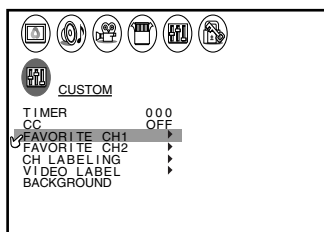



- Press ◀ or ▶ to display the FAVORITE CH1 menu, for example. CH INPUT will be highlighted.

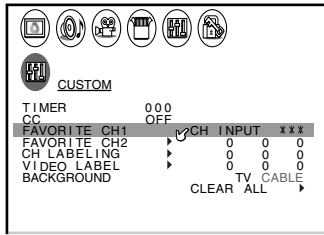

- Press the Channel Number buttons to enter one of your favorite channels.
- Press ENTER.
- Repeat steps 4 and 5 for other channels.

To select your favorite channels:

Press FAV ▼ or ▲.

To quickly scan through your favorite channels in a 9-picture multi-window:

Press FAVORITE (see page 31).

To clear a favorite channel:

- Press MENU, and then press ◀ or ▶ until the CUSTOM menu appears.
- Press ▲ or ▼ to highlight FAVORITE CH2, for example.
- Press ◀ or ▶ to display the FAVORITE CH2 menu.

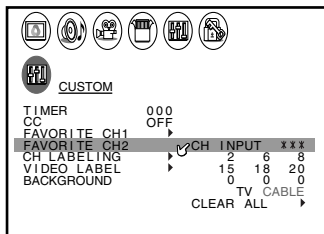

- Press ▲▼◀▶ to highlight the channel you want to clear, then press ENTER.

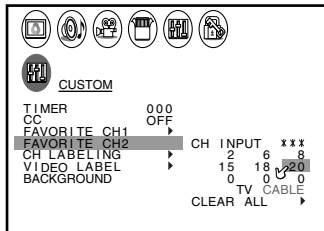

- Repeat step 4 for other channels.

To clear all favorite channels at once:

Press ▲ or ▼ to highlight CLEAR ALL in step 4 above, and then press ◀ or ▶ to clear all favorite channels at once.

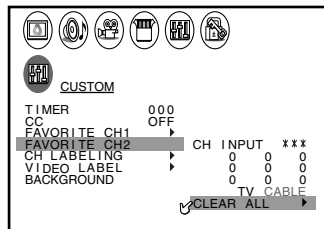

**Note:**

- The FAV ▼▲ buttons operate as MENU ◀▶ buttons when a menu is on-screen.
- The favorite channel feature is not available in ANT2 mode.

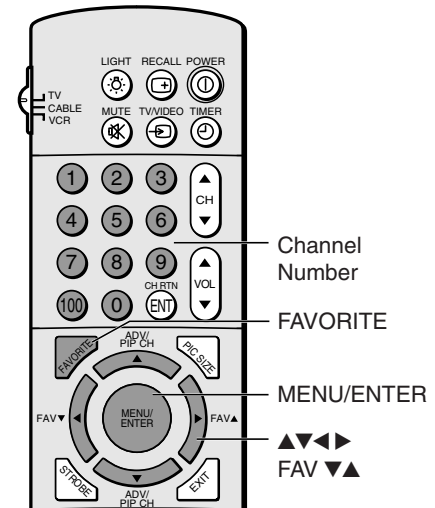

## Labeling channels

Channel labels appear above the on-screen channel number display each time you turn on the TV, change a channel, or press RECALL. You can choose any four characters to identify a channel.

To create channel labels:

1. Press MENU, and then press ◀ or ▶ until the CUSTOM menu appears.
2. Press ▲ or ▼ to highlight CH LABELING.
3. Press ◀ or ▶ to display the CH LABELING menu.  
CH INPUT will be highlighted.

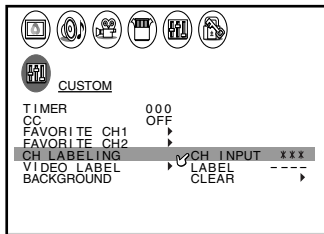

4. Press the Channel Number buttons to select a channel you want to label.

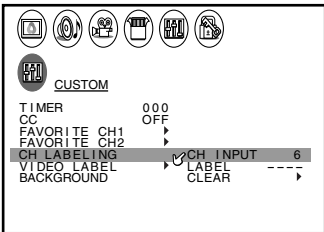

5. Press ▼ to highlight LABEL.
6. Press ◀ or ▶ repeatedly to select a character for the first space, and then press ENTER.

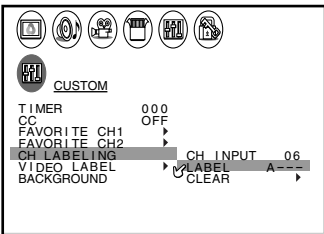

7. Repeat step 6 to enter the rest of the characters.  
If you would like a blank space in the label name, you must choose an empty space from the list of characters. Otherwise, a dash “-” will appear in that space.
8. Repeat steps 4–7 for other channels. You can assign labels to a maximum of 32 channels.

To erase channel labels:

1. Press MENU, and then press ◀ or ▶ until the CUSTOM menu appears.
2. Press ▲ or ▼ to highlight CH LABELING.
3. Press ◀ or ▶ to display the CH LABELING menu.
4. Press ▼ to highlight CH INPUT, then select the channel you want to clear with the Channel Number buttons.

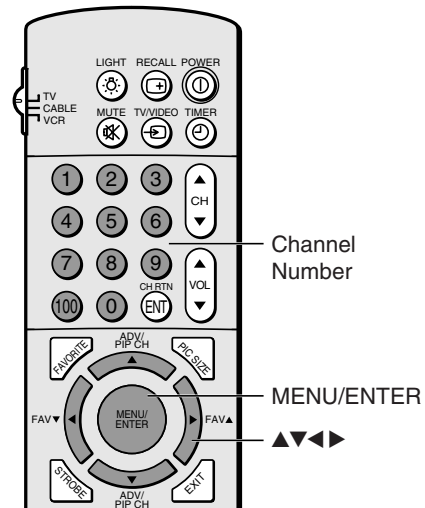

5. Press ▼ to highlight CLEAR.

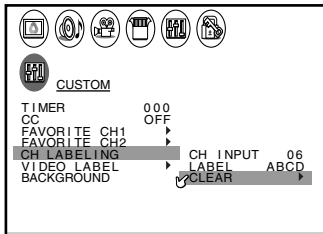

6. Press ◀ or ▶ to erase the channel label.
7. Repeat steps 4–6 to erase other channel labels.

## Viewing the wide-screen picture formats

You can view programs that have the conventional TV picture format (4:3 aspect ratio) and the wide-screen format (16:9 aspect ratio). This feature is available for TV or DVD video signals input from the ColorStream HD1 and HD2 jacks.

### Selecting the image shape

1. Make sure the ColorStream HD1 or HD2 mode is selected. (See page 41 for details.)
2. Press PIC SIZE repeatedly to select either Normal, Letterbox, or Compression image shape, as described below.

**Note:** The message “Not Available” will appear when the PIC SIZE button is pressed in a mode other than ColorStream HD1 or HD2.

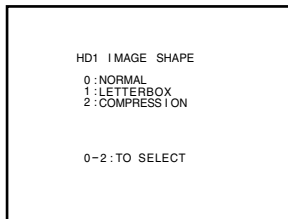

While the above menu is on-screen, select the desired picture size by pressing the corresponding number button (0–2).

### Normal mode

The Normal picture size displays the picture in the conventional 4:3 aspect ratio. A wide (16:9) picture signal is stretched vertically to fill the screen.

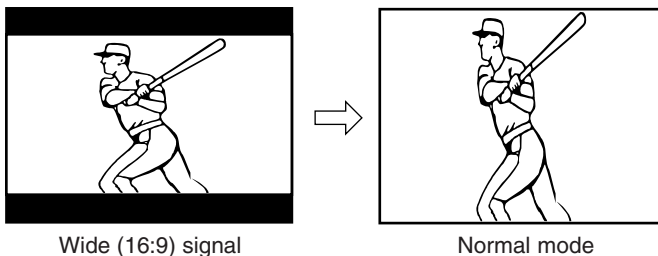

(continued on next page)

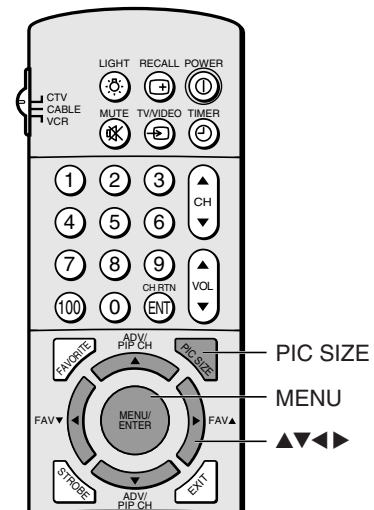

### NOTICE OF POSSIBLE ADVERSE EFFECTS ON TV PICTURE TUBE

Avoid displaying stationary images on your TV screen for extended periods of time. Fixed (non-moving) images (such as still PIP/POP windows or black/gray bars in wide-screen picture or PIP/POP formats) can become permanently engraved in the picture tube. **This type of damage is NOT COVERED BY YOUR WARRANTY** because it is the result of misuse. See item 32 on page 4.

## Letterbox and Compression modes

The Letterbox and Compression modes display a wide picture (16:9) with bars at top and bottom. The picture retains its true proportion.

### Letterbox (recommended mode):

- The picture is vertically compressed, with gray bars at top and bottom.
- The picture quality is lower than in the Compression mode because of a reduction in the scanning lines.
- There is a slightly lower chance of permanently engraining stationary patterns in the picture tube than in Compression mode because there is a small amount of raster in the bars at the top and bottom.

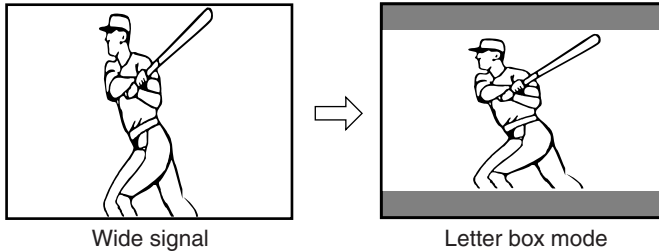

### Compression:

- The picture is vertically compressed, with black bars at the top and bottom.
- The exact image is reproduced and the picture quality is better because of more effective use of scanning lines.
- There is a greater chance of permanently engraining stationary patterns in the picture tube than in the Letterbox mode, since there is no raster in the bars at the top and bottom.

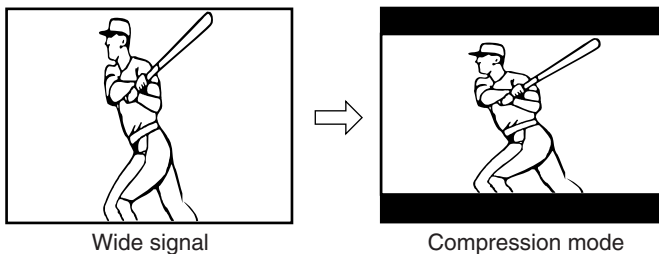

### Note:

You can also change the image shape using the menu system. Select **IMAGE SHAPE** **HD1** or **HD2** in the **THEATER** menu.

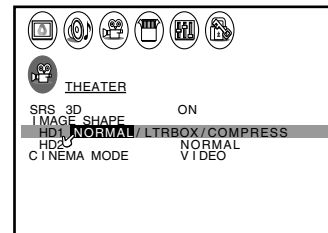

### NOTICE OF POSSIBLE ADVERSE EFFECTS ON TV PICTURE TUBE

Avoid displaying stationary images on your TV screen for extended periods of time. Fixed (non-moving) images (such as still PIP/POP windows or black/gray bars in wide-screen picture or PIP/POP formats) can become permanently engrained in the picture tube. **This type of damage is NOT COVERED BY YOUR WARRANTY** because it is the result of misuse. See item 32 on page 4.

## Watching PIP/double-window

The PIP/double-window feature allows you to watch two pictures at the same time. The sub-picture can be a TV broadcast or come from an external source, such as a VCR.

To display a TV broadcast as a sub-picture:

1. Select the program you want to watch.
2. Press PIP once to display a small picture. A window 1/9 the size of the screen will appear. Press PIP a second time to display a double-window.

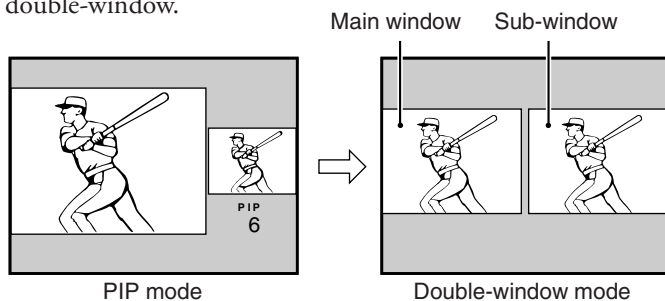

3. Press PIP CH ▲▼ to choose the program you want to be displayed as a sub-picture.

If the V-CHIP feature is active and you try to watch a TV program that exceeds the rating limits you set, the TV will enter into the program block mode. See “Using V-CHIP menu” on page 33.

Example: PIP mode

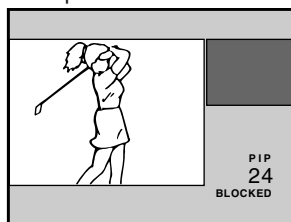

To display a picture from an external source as a sub-picture:

1. Make sure you have connected the external source equipment properly. For more information, see the “Connecting your TV” on page 7.
2. Turn on the TV and select the program you want to watch.
3. Press PIP once to display a small picture. A window 1/9 the size of the screen will appear. Press PIP a second time to display a double-window.
4. Press SOURCE repeatedly to select the input source (TV, VIDEO 1, VIDEO 2 or VIDEO 3) for the sub-picture. The selected source will be displayed in purple. ColorStream HD1 and HD2 can not be selected.

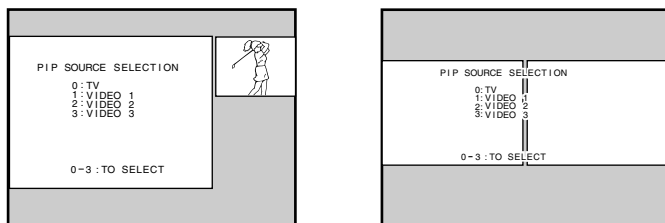

While the above menu is on the screen, you can select the desired signal input source by pressing the corresponding number button (0-3).

To turn PIP off:

Press PIP once or twice, depending on the size of the sub-picture screen you selected.

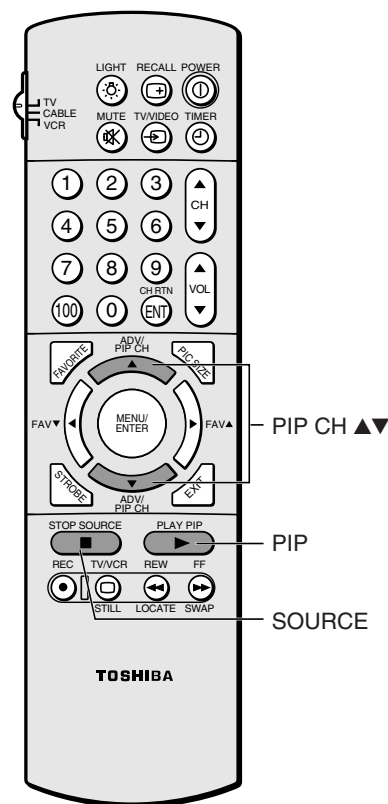

### Note:

- PIP/double-window can not be turned on when the ColorStream input (HD1 or HD2) is being viewed.
- You can not display the signal sources input through the ANT-2 terminal as a sub-picture.

### NOTICE OF POSSIBLE ADVERSE EFFECTS ON TV PICTURE TUBE

Avoid displaying stationary images on your TV screen for extended periods of time. Fixed (non-moving) images (such as still PIP/POP windows or black/gray bars in wide-screen picture or PIP/POP formats) can become permanently engrained in the picture tube. **This type of damage is NOT COVERED BY YOUR WARRANTY** because it is the result of misuse. See item 32 on page 4.

(continued on next page)

## Switching the main and sub-pictures

Press SWAP while you are using the PIP feature to switch the main and sub-pictures. The main and sub-pictures will switch each time you press the SWAP button.

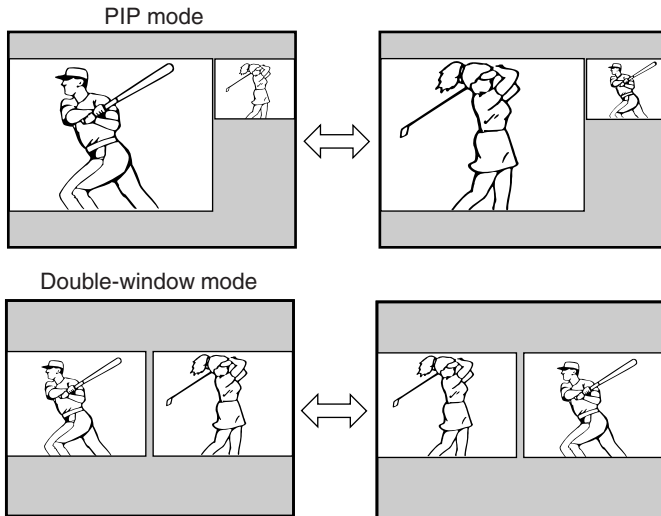

## Changing the position of the small picture

Press LOCATE repeatedly while you are watching a small picture. The display position of the small picture will change in the following order:

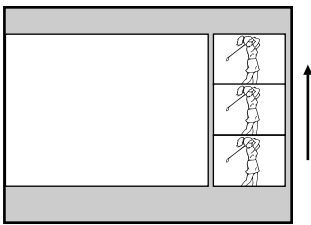

**Note:** The LOCATE button is not available in double-window mode.

## Freezing the sub-picture

Press STILL while you are watching a sub-picture. The sub-picture will become a still picture. To return to the moving picture, press STILL again.

Example: PIP mode

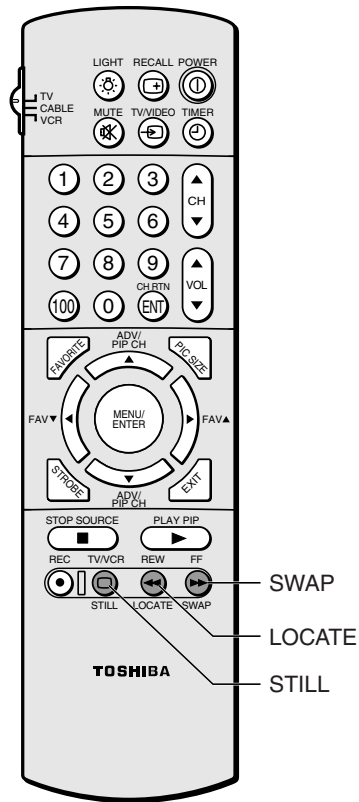
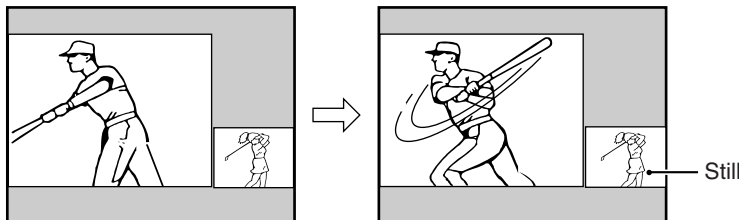

### NOTICE OF POSSIBLE ADVERSE EFFECTS ON TV PICTURE TUBE

Avoid displaying stationary images on your TV screen for extended periods of time. Fixed (non-moving) images (such as still PIP/POP windows or black/gray bars in wide-screen picture or PIP/POP formats) can become permanently engrained in the picture tube. **This type of damage is NOT COVERED BY YOUR WARRANTY** because it is the result of misuse. See item 32 on page 4.

## Using the Multi-Window feature

The Multi-Window feature provides two functions. The Favorite function (9-picture multi-search) scans the channels you programmed in the TV memory using the FAVORITE CH function. The Strobe function is convenient when watching a quickly moving picture such as a sports program.

### Using the favorite function

1. Press FAVORITE to scan the channels you programmed in the TV memory using the favorite channel function (page 24). A 9-picture multi-window search will start. The first window will display a moving picture.
2. Press ▲▼◀▶ to select the channel you want to see. (The selected channel will display a moving picture in the multi-window.)
3. Press ENTER to display the channel you selected in step 2 as a normal picture.

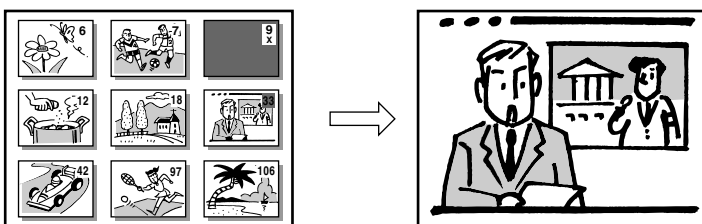

Each time you press FAVORITE, the display will change in the following order:

FAVORITE CH1 — FAVORITE CH2 — off

To cancel the favorite function:

Press FAVORITE once or twice.

### Using the strobe function

Press STROBE to start the strobe function. A 9-picture multi-window strobe starts for the current main picture.

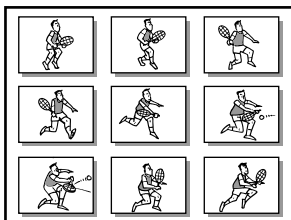

For example, you can watch a decisive moment of a sports program that has been recorded previously.

To cancel the strobe function:

Press STROBE again.

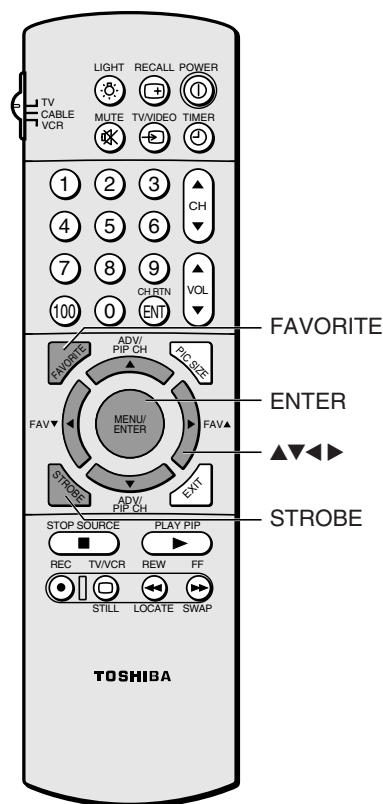

#### Note:

- When the main picture source is ColorStream, the FAVORITE and STROBE buttons are not available.
- If the V-CHIP feature is active and you try to scan a TV program that exceeds the rating limits you set, a black window will appear with an "X" in the upper right corner. However, during Favorite channel scanning, the V-CHIP may not block channels properly.

#### NOTICE OF POSSIBLE ADVERSE EFFECTS ON TV PICTURE TUBE

Avoid displaying stationary images on your TV screen for extended periods of time. Fixed (non-moving) images (such as still PIP/POP windows or black/gray bars in wide-screen picture or PIP/POP formats) can become permanently engrained in the picture tube. **This type of damage is NOT COVERED BY YOUR WARRANTY** because it is the result of misuse. See item 32 on page 4.

## Using the LOCKS menu

The LOCKS menu includes the V-Chip, CH Lock, Video Lock, and New PIN Code functions. You can use these functions after entering the correct PIN code.

### Entering the PIN code

1. Press MENU, and then press ◀ or ▶ until the LOCKS menu appears.

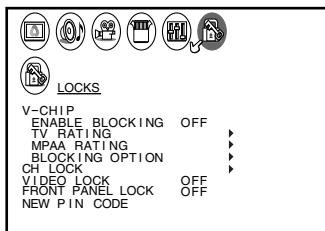

2. Press ▲ or ▼ to display the PIN code entering screen.

- Blocking Reset status: Set your 4-digit code by pressing the Number buttons (0–9), and then press ENTER.
- When the PIN code is already stored: Press the Number buttons (0–9) to enter the 4-digit PIN code used for blocking channels, and then press ENTER.

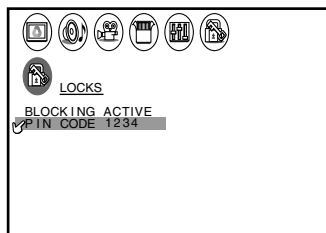
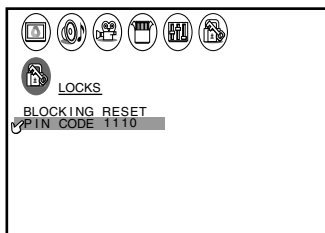

If the wrong PIN code is entered, the message “Incorrect” appears. Enter the code again, and then press ENTER.

### If you cannot remember your PIN code

While the PIN code entering screen is displayed, press RECALL four times within five seconds. The PIN code will be released (Blocking Reset status restored).

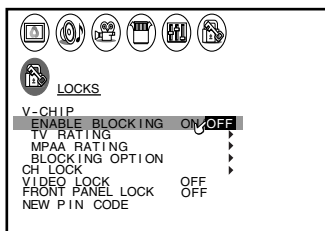

Continue to set each item following the steps on the next page.

### Note:

The V-Chip function is available only for the U.S. V-Chip system. The Canadian V-Chip system is not supported.

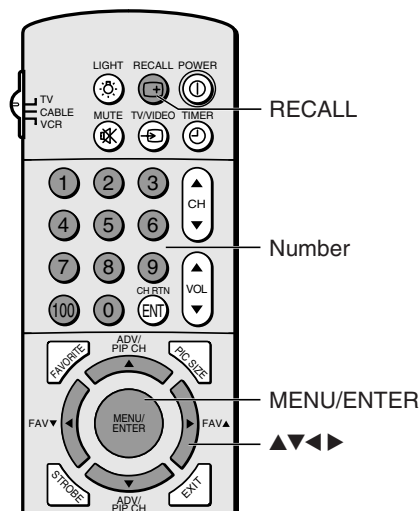



## Using the V-CHIP menu

Some TV programs and movies include signals that classify the content of the program (violence, sex, dialog, language). The V-CHIP control feature in this TV detects the signals and blocks the programs according to your selections. To use this feature, perform the following setup.

### ENABLE BLOCKING

1. From the LOCKS menu, select ENABLE BLOCKING.
2. Press ◀ or ▶ to select ON or OFF.  
ON : To enable your setting (Lock)  
OFF: To release your setting (Unlock)

**Note:** The CH LOCK function is not affected by this selection.

### TV RATING (Independent rating system for broadcasters)

1. From the LOCKS menu, select TV RATING.
2. Press ◀ or ▶ to display the TV RATING menu.
3. Press ▼ or ▲ to select an item.
4. Press ▶ to lock (displays "X")  
Press ◀ to unlock (displays "✓")
5. Repeat steps 3 and 4 to set the next item.

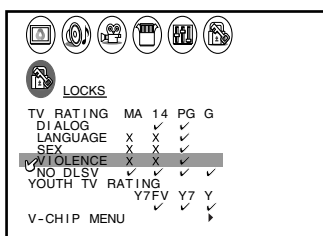

The TV age-based ratings and content themes you can be lock are listed in the table below.

Ratings	Description and Content themes
MA	Mature Audience Only (This program is specifically designed to be viewed by adults and therefore may be unsuitable for children under 17.) <b>L) Crude or indecent language S) Explicit sexual activity V) Graphic violence</b>
14	Parents Strongly Cautioned (This program contains some material that many parents would find unsuitable for children under 14 years of age.) <b>D) Intensely suggestive dialog L) Strong, coarse language S) Intense sexual situations V) Intense violence</b>
PG	Parental Guidances Suggested (This program contains material that parents may find unsuitable for younger children.) <b>D) Some suggestive dialog L) Infrequent coarse language S) Some sexual situations V) Moderate violence</b>
G	General Audience (Most parents would find this program suitable for all ages.)
Y7, Y7FV	Directed to Older Children (This program is designed for children age 7 and above. Note: Programs in which fantasy violence may be more intense or more combative than other programs in this category are designated Y7FV.)
Y	All Children (This program is designed to be appropriate for all children.)

### Note:

The V-Chip function is available only for the U.S. V-Chip system. The Canadian V-Chip system is not supported.

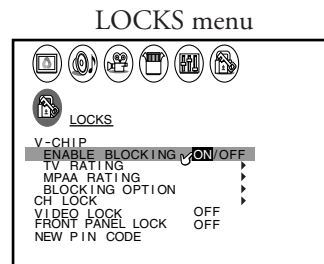

To select each item:

Press ▼ or ▲.

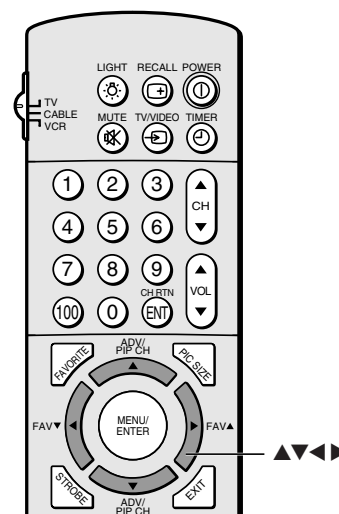

Press RECALL to display the rating of the TV program you are currently watching.

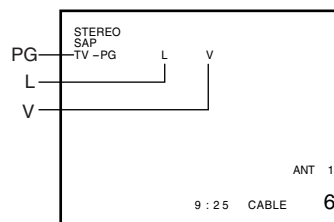

## MPAA RATING (Independent rating system for movies)

1. From the LOCKS menu, select MPAA RATING.
2. Press ◀ or ▶ to display the MPAA RATING menu, then press ▼ or ▲ to highlight MPAA RATING.

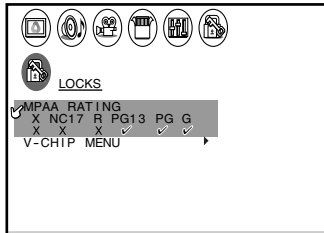

## LOCKS menu

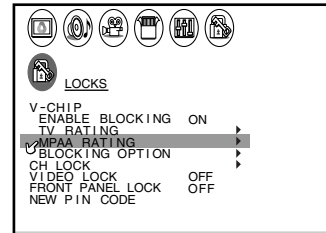

To select each item:  
Press ▼ or ▲.

3. Press ▶ to lock (“X”) or press ◀ to unlock (“✓”).

The movie ratings you can lock are described as follows:

- X : X-rated (For adults only)
- NC17: Not intended for anyone 17 and under
- R : Restricted (Under 17 requires accompanying parent or adult guardian.)
- PG13 : Parents Strongly Cautioned (Some material may be inappropriate for children under 13)
- PG : Parental Guidance Suggested (Some material may not be suitable for children)
- G : General Audience (Appropriate for all ages)

## BLOCKING OPTION

1. From the LOCKS menu, select BLOCKING OPTION.
2. Press ◀ or ▶ to display the BLOCKING OPTION menu, then press ▲ or ▼ to select item.

MPAA UNRATED:

Press ◀ or ▶ to select ON (Lock) or OFF (Unlock) for unrated programs in the MPAA rating system.

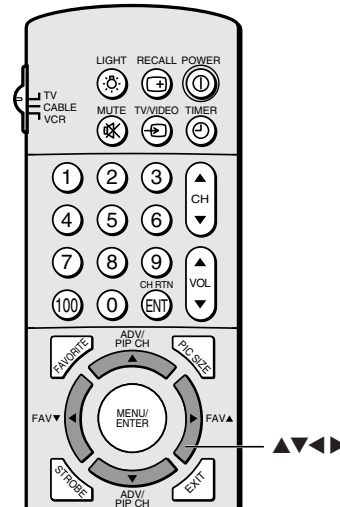
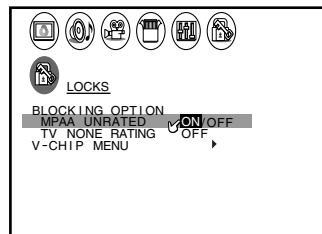
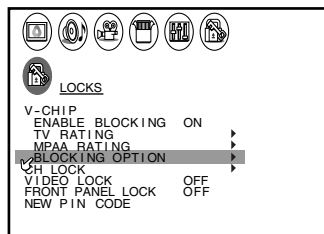

## TV NONE RATING

Press ◀ or ▶ to select ON (Lock) or OFF (Unlock) for programs rated NONE in the TV PARENTAL GUIDELINES.

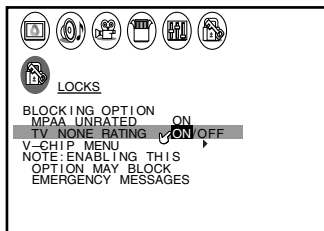

### Caution:

Be aware that setting the TV None Rating to ON may block the broadcast of emergency information. The menu will display the note, “Enabling this option may block emergency messages” to warn you of this possibility.

V-CHIP MENU:

Press ◀ or ▶ to return to the LOCKS menu.

## Unlocking programs temporarily

1. If you try to watch a TV program that exceeds the rating limits you set, the TV enters into the program lock mode.

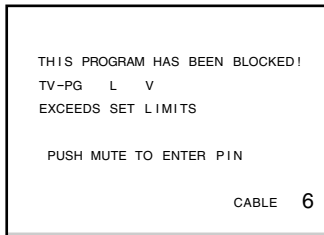

2. To temporarily unlock the program, press MUTE.
3. Press the Number buttons (0-9) to enter your 4-digit pin code.

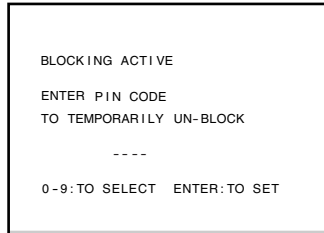

4. Press ENTER.
- If the number is correct, the lock mode will be released and the normal picture will appear.
- All locking is disabled until the TV is turned off, and will be enabled when the TV is turned on again.

## Locking channels

With the CH LOCK feature, you can lock specific channels. The TV will not be able to tune locked channels with the Channel ▲ ▼ buttons or Channel Number buttons, unless you clear the setting.

You can lock a maximum of nine channels.

**Note:** The CH LOCK function is not affected by the ENABLE BLOCKING setting (page 33).

To lock channels:

1. From the LOCKS menu, select CH LOCK.
2. Press ◀ or ▶ to display the CH LOCK menu. CH INPUT will be highlighted.
3. Press the Channel Number buttons to enter the channel you want to lock.
4. Press ENTER.

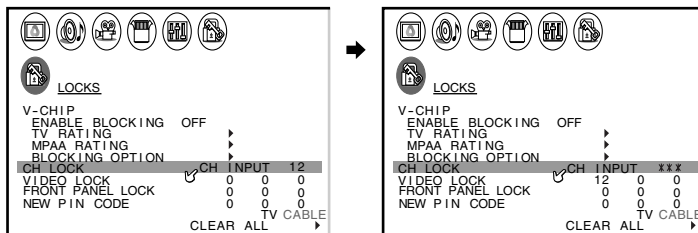

5. Repeat steps 3 and 4 for other channels.

(continued on next page)

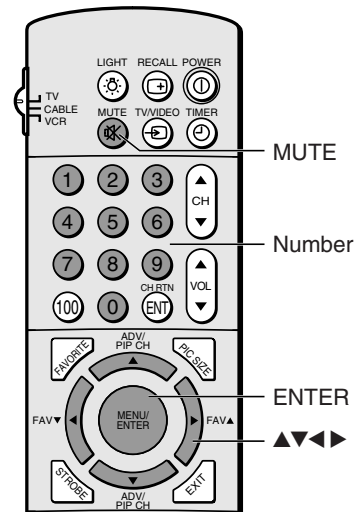

## LOCKS menu

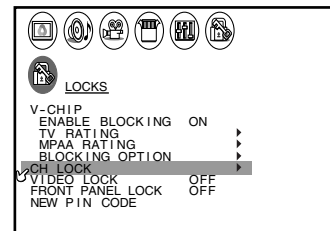

To select each item:

Press ▼ or ▲.

To unlock individual channels:

1. From the LOCKS menu, select CH LOCK.
2. Press ◀ or ▶ to display the CH LOCK menu.
3. Press ▲▼◀▶ to highlight the channel you want to unlock, then press ENTER.

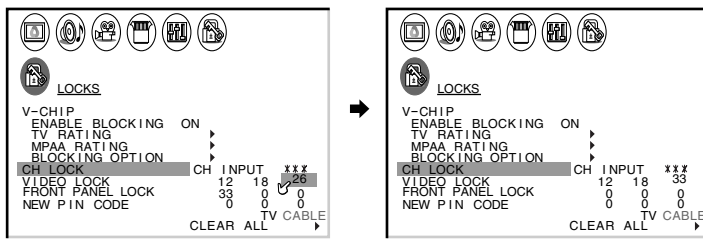

4. Repeat step 3 for other channels.

To unlock all locked channels at once:

Press ▲ or ▼ to highlight CLEAR ALL, and then press ◀ or ▶.

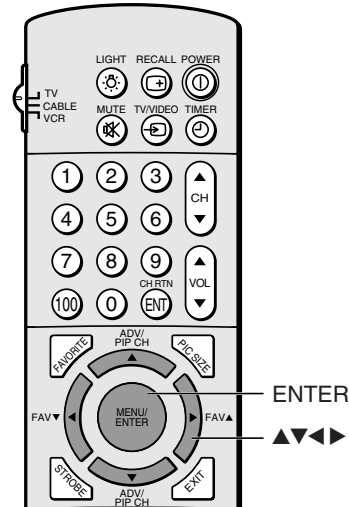
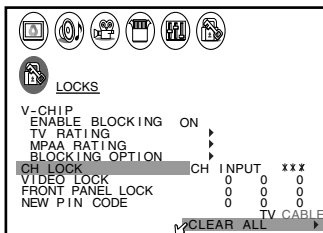

## Locking video inputs

With the VIDEO LOCK feature, you can lock out the input sources (Video 1, Video 2, Video 3, ColorStream HD1, ColorStream HD2) and channels 3 and 4.

You will not be able to select the input sources with the TV/VIDEO button or Channel buttons unless you clear the setting.

To set up the video lock:

1. From the LOCKS menu, select VIDEO LOCK.
2. Press ◀ or ▶ to highlight the level of video locking you want (Video, Video+, or Off), as follows:  
 VIDEO : Locks Video 1, Video 2, Video 3, ColorStream HD1 and HD2.  
 VIDEO+ : Locks Video 1, Video 2, Video 3, ColorStream, HD1/HD2, and channels 3 and 4. This option should be used if you use the antenna terminal to play a video tape.  
 OFF : Unlocks all video input sources.

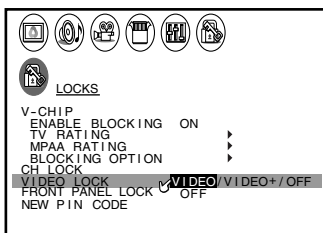

## Using the front panel lock feature

Lock the front panel buttons to prevent the buttons from being pressed accidentally (by children, for example). When the front panel lock is ON, all control buttons on the TV front panel (except POWER) do not operate.

To lock the front panel:

1. From the LOCKS menu, select FRONT PANEL LOCK.
2. Press ◀ or ▶ to highlight ON.

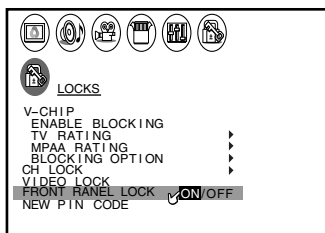

If a button on the front panel is pressed, the message “Not Available” appears.

To unlock the front panel:

Highlight OFF in step 2 above, or press and hold the VOLUME ◀ button on the TV for about 10 seconds until the message “Front Panel Lock: Off” appears on-screen.

## Changing the PIN code

1. From the LOCKS menu, select NEW PIN CODE.
2. Press the Number buttons (0–9) to enter a 4-digit code. The numbers you enter will replace the dashes in the display.

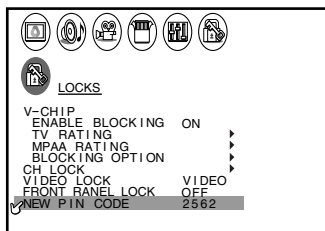

3. Press ENTER. The new PIN code is now active.

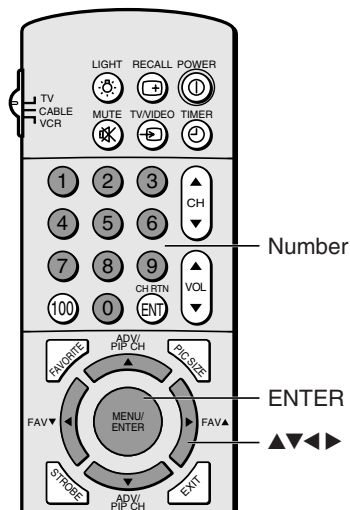
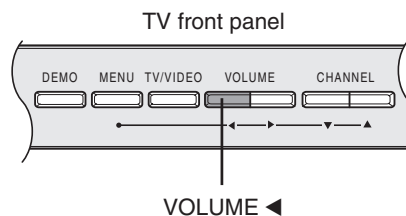
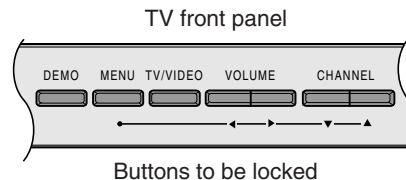

## Adjusting the picture

### Selecting the picture mode

You can select your desired picture type from four picture modes: Sports, Standard, Movie, and Preference.

Mode	Picture Quality
Sports	Bright and dynamic picture (factory setting)
Standard	Standard picture setting (factory setting)
Movie	Movie-like picture setting (factory setting)
Preference	Your personal preference*

\*(see "Saving new preference" on page 39.)

To select the picture mode:

1. Press MENU, and then press ◀ or ▶ until the PICTURE menu appears.
2. Press ▼ or ▲ to select MODE.
3. Press ◀ or ▶ to highlight the mode you prefer.

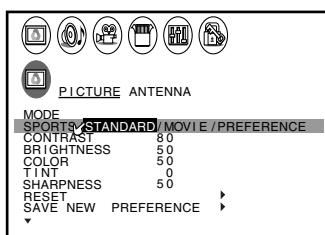

### Adjusting the picture quality

You can adjust the picture quality to your personal preferences, including the contrast, brightness, color, tint, sharpness, flesh tone, noise reduction and color temperature.

Selection	◀ Pressing ▶	
contrast	lower	higher
brightness	darker	lighter
color	paler	deeper
tint	reddish	greenish
sharpness	softer	sharper

To adjust the picture quality:

1. Press MENU, and then press ◀ or ▶ until the PICTURE menu appears.
2. Press ▼ or ▲ until the item you want to adjust is highlighted.
3. Press ◀ or ▶ to adjust the level.

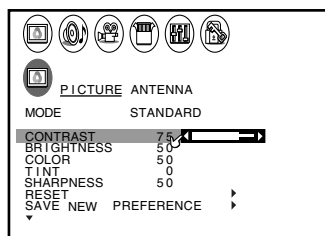

The PICTURE quality adjustments you make (contrast, brightness, color, tint, and sharpness) can be saved in the TV's memory with the SAVE NEW PREFERENCE feature (see page 39). You can keep these settings or choose factory set options, as described in "Selecting the picture mode" above.

### Note:

If you select one of the factory-set picture modes (SPORTS, STANDARDS, or MOVIE) and then change a picture quality setting (for example, increase the contrast), the picture mode automatically changes to PREFERENCE in the Picture menu.

To save your new picture quality settings, you must select SAVE NEW PREFERENCE (see page 39) before closing the Picture menu, or the TV will return to the previous picture mode.

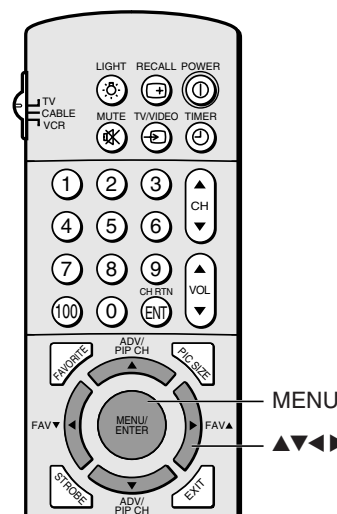
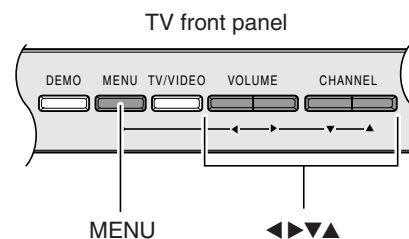

## Saving new preference

You can save the PICTURE qualities (contrast, brightness, color, tint, and sharpness) you adjusted in the picture preference mode.

To save your new preferences:

1. Press MENU, and then press ◀ or ▶ until the PICTURE menu appears.
2. Press ▲ or ▼ to highlight SAVE NEW PREFERENCE.
3. Press ◀ or ▶. When complete, the menu displays “DONE.”

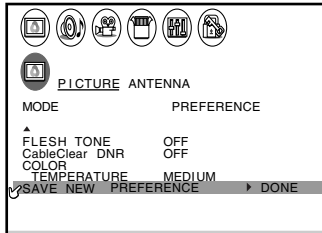

The mode automatically changes to PREFERENCE.

You can choose your saved preferences any time by selecting PREFERENCE mode in the PICTURE menu (see “Selecting the picture mode” on page 38).

## Using the flesh tone feature

This feature displays natural flesh tones by correcting the tint.

To turn on the flesh tone feature:

1. Press MENU, and then press ◀ or ▶ until the PICTURE menu appears.
2. Press ▲ or ▼ to highlight FLESH TONE.
3. Press ◀ or ▶ to highlight ON.

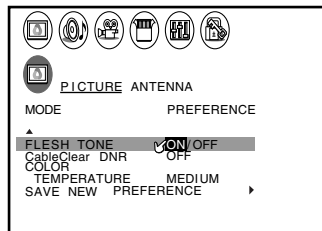

## Using the CableClear™ DNR (digital noise reduction) feature

This feature allows you to reduce visible interference in your TV picture. This is useful when receiving a broadcast with a weak signal (especially cable channels) or playing back a video cassette or disc damaged by repeated use.

To turn on the CableClear™ DNR feature:

1. Press MENU, and then press ◀ or ▶ until the PICTURE menu appears.
2. Press ▲ or ▼ to highlight CableClear DNR.
3. Press ◀ or ▶ to highlight AUTO.

To turn off the CableClear™ DNR feature:

Highlight OFF in step 3 above.

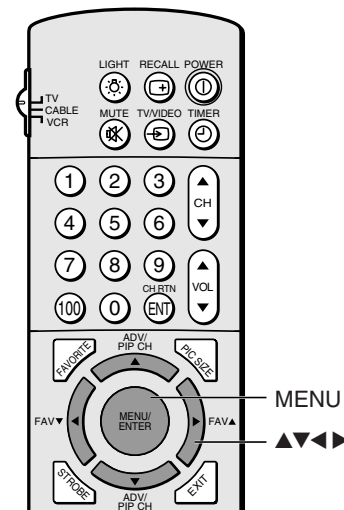
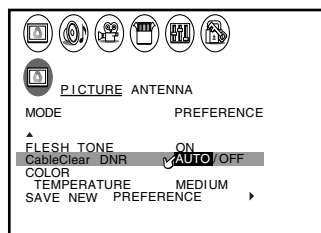

### Note:

The “CableClear DNR” display will change to “DNR” in VIDEO mode.

## Selecting the color temperature

You can change the quality of the picture by selecting from three preset color temperatures: cool, medium, and warm.

To select the color temperature:

1. Press MENU, and then press ◀ or ▶ until the PICTURE menu appears.
2. Press ▲ or ▼ to highlight COLOR TEMPERATURE.
3. Press ◀ or ▶ to highlight the mode you prefer.

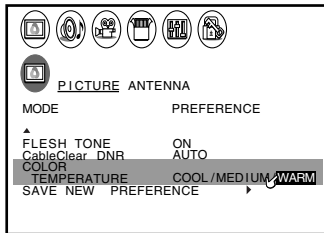

Mode	Picture Quality
cool	blueish
medium	neutral
warm	reddish

## Resetting picture adjustments

The RESET function adjusts the picture qualities to the following factory settings:

Contrast .....	max (100)	Color temperature .....	Cool
Brightness .....	center (50)	CableClear™ DNR .....	Auto
Color .....	center (50)	Mode .....	Sports
Tint .....	center (0)		
Sharpness .....	center (50)		

To reset the picture adjustments:

1. Press MENU, and then press ◀ or ▶ until the PICTURE menu appears.
2. Press ▲ or ▼ to highlight RESET.
3. Press ◀ or ▶. The menu displays “DONE.”

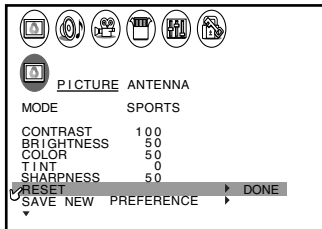

## Selecting the cinema mode

When you view a DVD movie (3-2 pulldown processed) from a DVD player connected to the ColorStream (component video) inputs on the TV, smoother and more natural motion can be obtained by setting the CINEMA MODE to FILM.

To set the CINEMA MODE to FILM:

1. Press MENU, and then press ◀ or ▶ until the THEATER menu appears.
2. Press ▲ or ▼ to highlight CINEMA MODE.
3. Press ◀ or ▶ to select FILM.

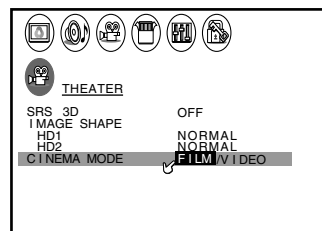

To turn off the CINEMA MODE:

Select VIDEO in step 3 above.

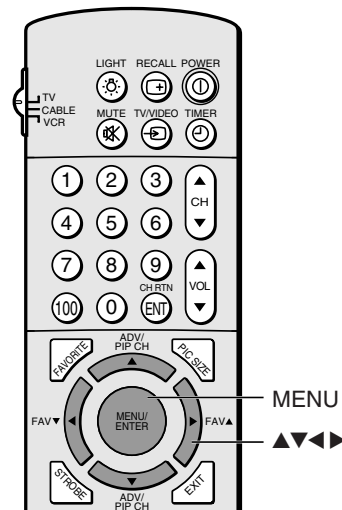



## Selecting the video input source

Press TV/VIDEO on the remote control or TV to view a signal coming from another device connected to your TV, such as a VCR or video disc player. You can select ANT 1, VIDEO 1, VIDEO 2, VIDEO 3, ColorStream HD1, ColorStream HD2, or ANT 2 depending on which input jacks are used for connecting the devices (see "Connecting your TV" on page 7.)

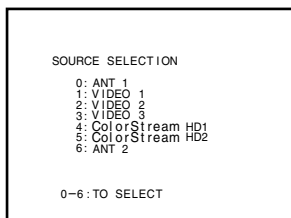

Pressing TV/VIDEO on the remote control *displays* the current signal source (press TV/VIDEO again or 0-6 to *change*)

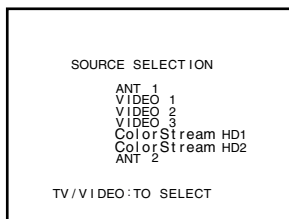

Pressing TV/VIDEO on the TV *changes* the current signal source

### Note:

- When ColorStream HD 1 or HD 2 is selected, the video OUT jack does not output a signal. To receive a video OUT signal, use a video or S-video IN connection instead of the ColorStream connection.
- If you select ColorStream HD1 or HD2 while the PIP/Double-Window is active, the window will close.

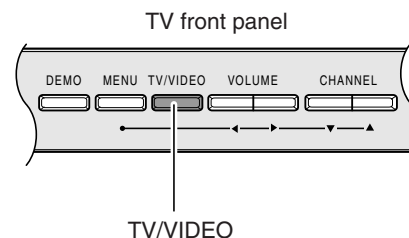

## Labeling the video input sources

The video label feature allows you to label each input source for your TV from the following preset list of labels:

- : Uses the default label name
- VCR : Video cassette recorder
- DVD : DVD video
- DTV : Digital TV set-top box
- SAT : Satellite box
- CBL : Cable box

To label the video input sources:

- Press MENU, and then press ◀ or ▶ until the CUSTOM menu appears.
- Press ▲ or ▼ to highlight VIDEO LABEL.

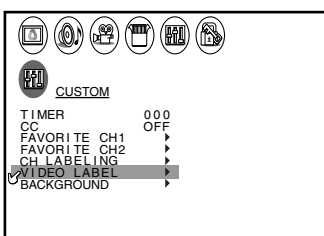

- Press ◀ or ▶ to display the VIDEO LABEL menu.
- Press ▲ or ▼ to highlight the video source you want to label.
- Press ◀ or ▶ to select the desired label for that input source.

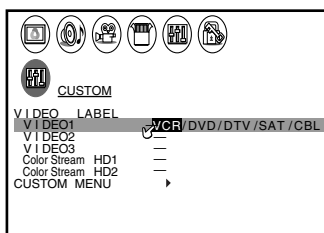

- Finish labeling the other video sources as desired. To return to the previous menu, press ▲ or ▼ to highlight CUSTOM MENU, and then press ◀ or ▶.
- To exit the menu, press EXIT.

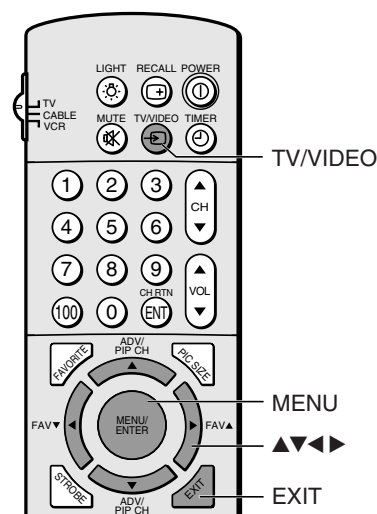

## Using the closed caption feature

The closed caption feature has two options:

- Captions—An on-screen display of the dialogue, narration, and sound effects of TV programs and videos that are closed captioned (usually marked as “CC” in TV listings).
- Text—An on-screen display of information not related to the current program, such as weather or stock data (when provided by individual stations).

To view captions or text:

1. Tune the TV to the desired program.
2. Press MENU, and then press ◀ or ▶ until the CUSTOM menu appears.
3. Press ▼ or ▲ to highlight CC.

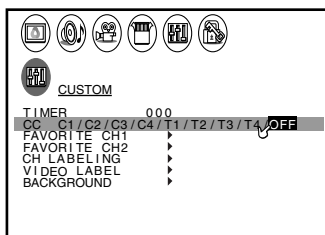

4. Press ◀ or ▶ to highlight the desired closed caption mode, as follows:

- To view captions, highlight C1, C2, C3, or C4 (C1 displays translation of the primary language in your area).

**Note:** If the program or video you selected is not closed captioned, no captions will display on the screen.



- To view text, highlight T1, T2, T3, or T4.

**Note:** If text is not available in your area, a black rectangle may appear on your screen. If this happens, turn the Closed Caption feature OFF.

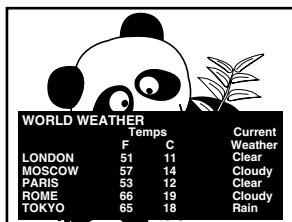

To turn off the Closed Caption feature:

Highlight OFF in step 4.

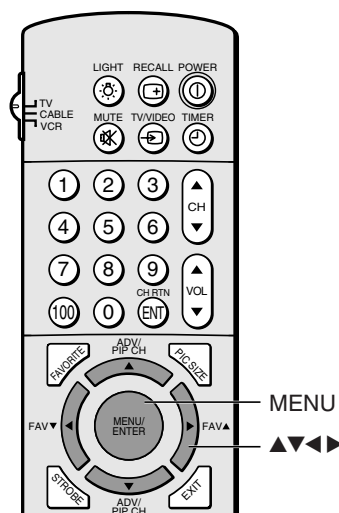

### Note:

A closed caption signal may not display in the following situations:

- when a videotape has been dubbed
- when the signal reception is weak
- when the signal reception is nonstandard

## Setting the sleep timer

To set the sleep timer to turn off the TV automatically:

1. Press **TIMER** to set the length of time until the TV turns off.

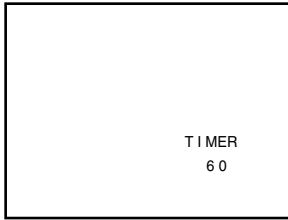

Every time you press **TIMER**, the time display will increase by 10 minutes, to a maximum of 180 minutes.

0 → 10 → 20 ----- → 170 → 180 → 0 → 10 MIN.

To cancel the sleep timer:

Press **TIMER** until it is set to 0.

The timer can also be set using the on-screen menu:

1. Press **MENU**, and then press ◀ or ▶ until the **CUSTOM** menu appears.
2. Press ▲ or ▼ to highlight **TIMER**.
3. After the number position starts to blink, press the Number buttons (0-9) to enter the length of time until the TV turns off automatically.
4. Press **ENTER** to start the timer.

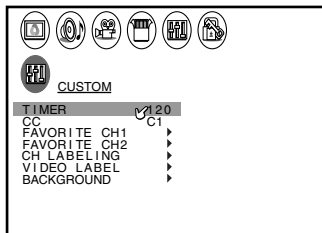

## Setting the clock

To set the clock:

1. Press **MENU**, and then press ◀ or ▶ until the **SET UP** menu appears.
2. Press ▲ or ▼ to highlight **CLOCK SET**.
3. After the number position starts to blink, press the Number buttons (0-9) to enter the correct time. The clock operates on a 12-hour cycle.
4. Press **ENTER** to start the clock.

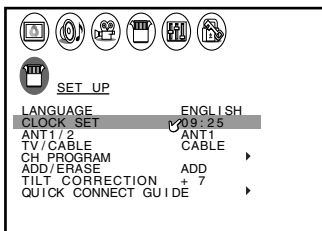

To display the time on-screen:

Press **RECALL**.

### Note :

To display the amount of time left until the TV turns off automatically, press **TIMER** once.

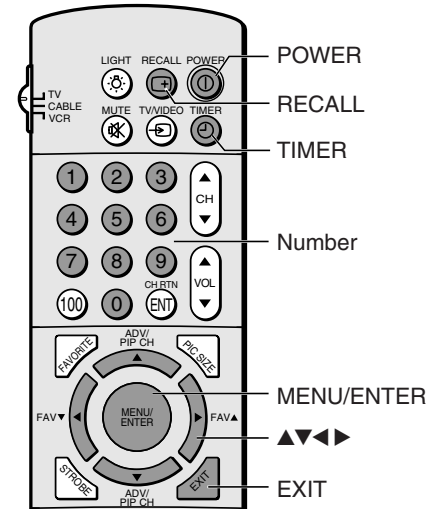

### Note :

If the TV's power source is interrupted (for example, the power cord is unplugged or a power failure occurs), the clock must be reset.

## Adjusting the sound

### Muting the sound

Press MUTE to temporarily reduce (1/2 MUTE) or turn off (MUTE) the sound. While the sound is off, the screen will display “1/2 MUTE” or “MUTE” in the lower right corner. Every time you press the button, the mute mode will change in the following order.

→ Normal → 1/2 MUTE → MUTE →

When you press MUTE, the closed caption feature is automatically activated. To deactivate this feature, press MUTE again. This feature works only when the closed caption mode is set to OFF. See “Using the closed caption feature” on page 42 for more information.

### Selecting stereo/SAP broadcasts

The multi-channel TV sound (MTS) feature allows you to listen to high-fidelity stereo sound while watching TV. MTS can also transmit a second audio program (SAP) containing a second language, music, or other audio information (when provided by individual stations).

When the TV receives a stereo or SAP broadcast, the word STEREO or SAP appears on-screen every time the TV is turned on, the channel is changed, or the RECALL button is pressed.

The MTS feature is not available when the TV is in VIDEO mode.

To listen to stereo sound:

1. Press MENU, and then press ◀ or ▶ until the AUDIO menu appears.
2. Press ▲ or ▼ to highlight MTS.
3. Press ◀ or ▶ to highlight STEREO.

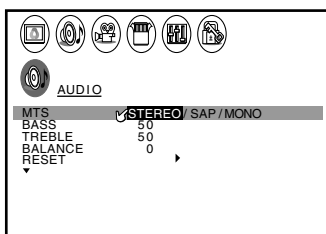

You can leave your TV in STEREO mode because it will automatically output the type of sound being broadcast (stereo or monaural). The word “STEREO” or “SAP” displays in yellow in the menu when the TV receives the signal.

If the stereo sound is noisy, select MONO to reduce the noise.

To listen to SAP (if available):

1. Press MENU, and then press ◀ or ▶ until the AUDIO menu appears.
2. Press ▲ or ▼ to highlight MTS.
3. Press ◀ or ▶ to highlight SAP. You will hear the station's second audio program (if available) from the speakers, while viewing the original program's picture (see note at right).

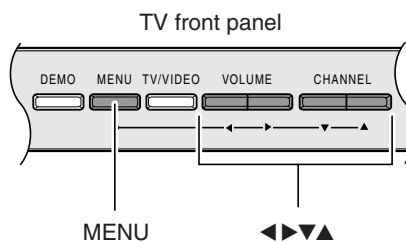
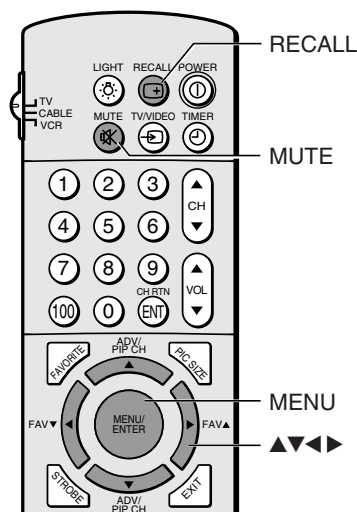

#### Note :

A second audio program (SAP) can be heard only on those TV stations that offer it.

For example, a station might broadcast music as a second audio program. If you have SAP on, you will see the current program on the screen but hear music instead of the program's normal audio.

However, if you have SAP on, and the station you are watching is not currently broadcasting a second audio program, you will see the picture but not hear any sound. If this happens, put the TV in STEREO mode so you can hear the station's normal audio.

## Using the SRS\* 3D surround sound feature

The SRS 3D surround sound feature expands the audio listening field wider and deeper to create exceptional sound quality from the TV's speakers. The feature uses stereo signals from a TV broadcast or video input.

To turn on the SRS 3D surround:

1. Select STEREO mode (see "Selecting stereo/SAP broadcasts" on page 44).
2. Press MENU, and then press ◀ or ▶ until the THEATER menu appears.
3. Press ▲ or ▼ to highlight SRS 3D.
4. Press ◀ or ▶ to highlight ON.

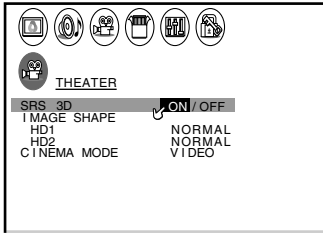

To turn off the SRS 3D surround:

Highlight OFF in step 4 above.

In general, you can leave your TV in ON mode because it will automatically produce the type of sound being broadcast (surround stereo or monaural).

## Adjusting the sound quality

You can change the quality of your TV's sound by adjusting the bass, treble, and balance.

To adjust the sound quality:

1. Press MENU, and then press ◀ or ▶ until the AUDIO menu appears.
2. Press ▲ or ▼ to highlight the item you want to adjust.

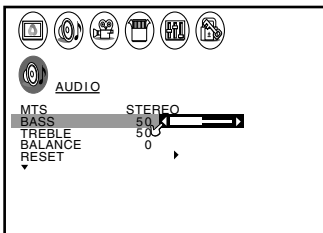

3. Press ◀ or ▶ to adjust the level.
  - ◀ makes the sound quality weaker or decreases the balance in the right channel, depending on the item selected.
  - ▶ makes the sound quality stronger or decreases the balance in the left channel, depending on the item selected.

### Note:

If the broadcast is monaural, the SRS 3D effect does not work.

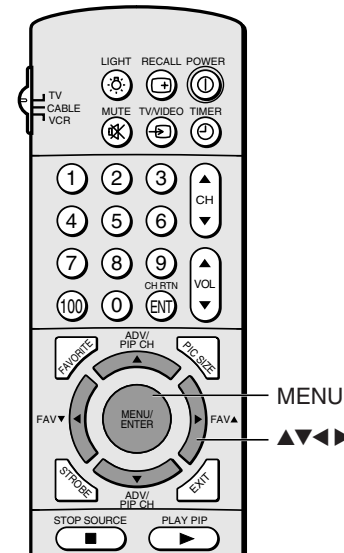

\*SRS and the (●) symbol are trademarks of SRS Labs, Inc.  
SRS technology is incorporated under license from SRS Labs, Inc.

## Resetting audio adjustments

The RESET function returns the audio adjustments to the following factory settings:

- Bass ..... center (50)
- Treble ..... center (50)
- Balance ..... center (0)

To reset the audio adjustments:

1. Press MENU, and then press ◀ or ▶ until the AUDIO menu appears.
2. Press ▲ or ▼ to highlight RESET.
3. Press ◀ or ▶. The menu displays "DONE."

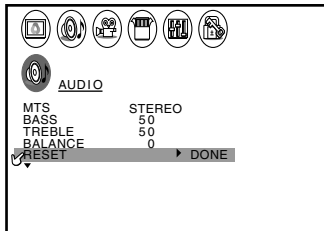

## Using the sub-bass system (SBS)

The sub-bass system allows you to enhance bass performance, even when the sound volume is low.

To turn on the SBS:

1. Press MENU, and then press ◀ or ▶ until the AUDIO menu appears.
2. Press ▲ or ▼ to highlight SBS.
3. Press ◀ or ▶ to highlight ON.

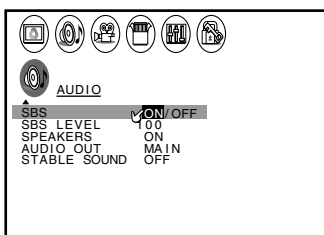

To adjust the SBS level:

4. Press ▲ or ▼ to highlight SBS LEVEL.
5. Press ◀ or ▶ to adjust the SBS level.

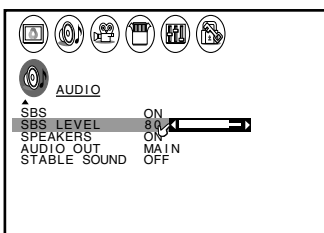

To turn off the SBS:

Highlight OFF in step 3 above.

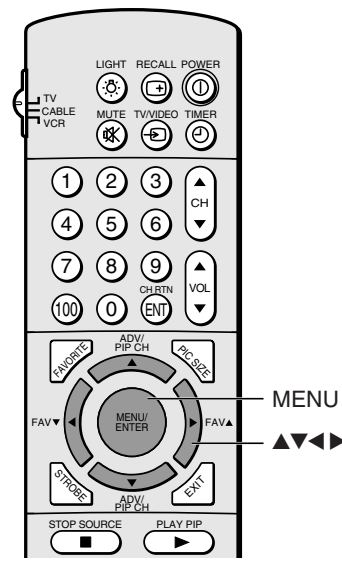

### Note:

- The SBS signal does not pass through the "Variable Audio OUT" jacks (see "Connecting an audio system" on page 13); however, the AUDIO menu will appear when the buttons are pressed.
- While in the SBS OFF mode, if the SBS level is adjusted, the SBS is automatically set ON.

## Turning off the built-in speakers

Use this feature to turn off the TV speakers when you connect an audio system (See “Connecting an audio system” on page 13).

To turn off the built-in speakers:

1. Press MENU, then press ◀ or ▶ until the AUDIO menu appears.
2. Press ▲ or ▼ to highlight SPEAKERS.
3. Press ◀ or ▶ to highlight OFF.

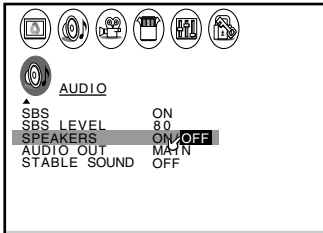

To turn on the built-in speakers:

Highlight ON in step 3 above.

## Selecting the Audio OUT sound

This feature allows you to select the sound source (MAIN or PIP) that is output from the Audio OUT jacks (See “Connecting two VCRs” on page 12).

This is useful when amplifying or recording the PIP/double-window sound with external equipment while hearing the sound of the main picture through the built-in speakers.

To select the Audio OUT sound:

1. Press MENU, and then press ◀ or ▶ until the AUDIO menu appears.
2. Press ▲ or ▼ to highlight AUDIO OUT.
3. Press ◀ or ▶ to select MAIN or PIP.

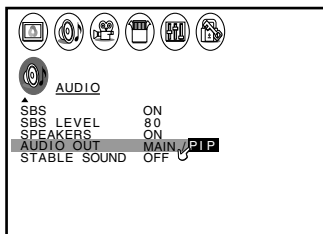

- MAIN: Outputs the sound of the main program.
- PIP : Outputs the sound of the PIP/double-window program.

### Note:

Make sure the volume control of your audio amplifier is set to a moderate listening level.

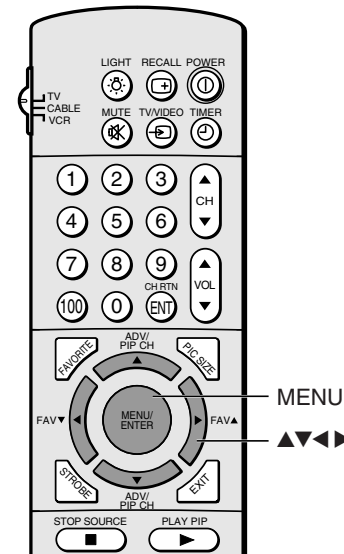

## Using the StableSound® feature

When the signal source is changed, the StableSound® feature limits the highest volume level to prevent extreme changes in volume (for example, to prevent the sudden increase in volume that often happens when a TV program switches to a commercial).

To turn on the StableSound® feature:

1. Press MENU, and then press ◀ or ▶ until the AUDIO menu appears.
2. Press ▲ or ▼ to highlight STABLE SOUND.
3. Press ◀ or ▶ to select ON.

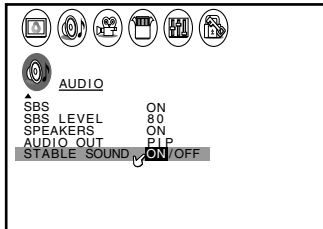

To turn off the StableSound feature:

Highlight OFF in step 3 above.

## Selecting the background of the menu display

You can change the background of the menu display by selecting from two preset types: shaded and solid (gray).

To select the background:

1. Press MENU, and then press ◀ or ▶ until the CUSTOM menu appears.
2. Press ▲ or ▼ to highlight BACKGROUND.
3. Press ◀ or ▶ to select either a SHADED or SOLID background.

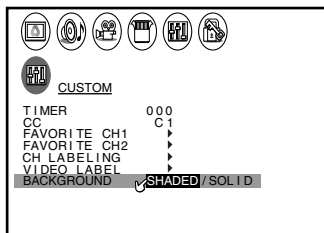

## Displaying on-screen information

Press RECALL to display the following information on-screen:

- Antenna mode (when in TV mode)
- Channel number or VIDEO mode selected
- Time (if set)
- Channel label (if set)
- Stereo or SAP audio status
- V-CHIP rating status
- Image shape status (when in ColorStream mode)

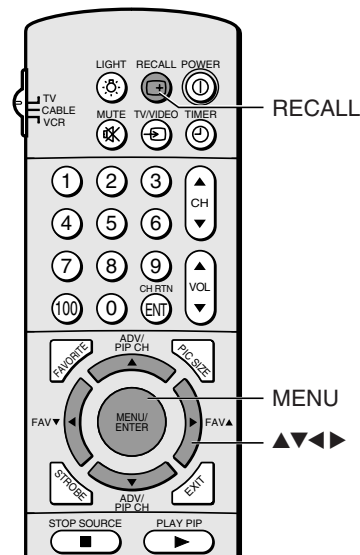
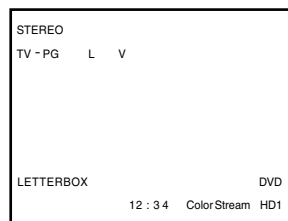
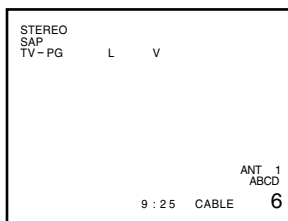



## Viewing the demo mode

The demo mode automatically demonstrates several of your TV's features. This function is provided for demonstration purposes only.

To start the demo:

Press DEMO on the TV front panel.

To stop the demo:

Press DEMO again.

## Understanding the auto power off feature

The TV will automatically turn itself off after approximately 15 minutes if it is tuned to a vacant channel or a station that completes its broadcast for the day. This feature does not work in VIDEO mode.

## Understanding the last mode memory feature

If the power is cut off while you are viewing the TV, the Last Mode Memory feature turns the TV on automatically when the power is resupplied.

If the power is going to be off for a long time and you are going to be away from your TV, unplug the power cord to prevent the TV from turning on in your absence.

# Appendix

## Specifications

Television System	NTSC standard
Channel Coverage	VHF: 2 through 13 UHF: 14 through 69 Cable TV: Mid band (A-8 through A-1, A through I) Super band (J through W) Hyper band (AA through ZZ, AAA, BBB) Ultra band (65 through 94, 100 through 125)
Power Source	120 V AC, 60 Hz
Power Consumption	32HF72: 186 W (average) 36HF72: 180 W (average)
Audio Power	10 W + 10 W
Speaker Type	Two 2-3/8 × 4-3/4 inches (60 × 120 mm)
Video/Audio Terminals	S-VIDEO INPUT Y: 1 V(p-p), 75 ohm, negative sync. C: 0.286 V(p-p) (burst signal), 75 ohm VIDEO/AUDIO INPUT VIDEO: 1 V(p-p), 75 ohm, negative sync. AUDIO: 150 mV(rms) (30% modulation equivalent, 47 k ohm) ColorStream® (component video) INPUT Y: 1V(p-p), 75 ohm PB: 0.7 V(p-p), 75 ohm PR: 0.7 V(p-p), 75 ohm AUDIO: 150 mV(rms), 47 k ohm VIDEO/AUDIO OUTPUT VIDEO: 1 V(p-p), 75 ohm, negative sync. AUDIO: 150 mV(rms) (30% modulation equivalent, 4.7 k ohm) VARIABLE AUDIO OUTPUT 0–300 mV(rms) (30% modulation equivalent, 4.7 k ohm) AUDIO CENTER CHANNEL INPUT 300 mV(rms) (30% modulation equivalent, 10 k ohm)
Dimensions	32HF72: Width 34-1/2 inches (875 mm) Height 26-1/2 inches (673 mm) Depth 22-5/8 inches (575 mm) 36HF72: Width 38-3/16 inches (970 mm) Height 29-9/16 inches (751 mm) Depth 24-1/4 inches (615 mm)
Mass	32HF72: 151 lbs. (68.5 kg) 36HF72: 203 lbs. (92.1 kg)
Supplied Accessories	Remote Control with 2 size “AA” alkaline batteries
Optional TV stand	32HF72: ST3262 36HF72: ST3662

Design and specifications are subject to change without notice.

## Troubleshooting

Before calling a service technician, please check the following table for a possible cause of the problem and some solutions.

<b>Problem</b>	<b>Solution</b>
TV will not turn on	<ul style="list-style-type: none"> <li>• Make sure the power cord is plugged in, then press POWER.</li> <li>• The remote control batteries may be dead. Replace the batteries.</li> </ul>
No picture, no sound	<ul style="list-style-type: none"> <li>• Check the antenna/cable connections.</li> </ul>
No sound, picture OK	<ul style="list-style-type: none"> <li>• The sound may be muted. Press VOLUME.</li> <li>• The station may have broadcast difficulties. Try another channel.</li> <li>• Check that the SPEAKERS function in AUDIO menu is set properly.</li> <li>• Check that the AUDIO CENTER CHANNEL switch is set properly.</li> </ul>
Poor picture, sound OK	<ul style="list-style-type: none"> <li>• Check the antenna connections.</li> <li>• The station may have broadcast difficulties. Try another channel.</li> <li>• Adjust the PICTURE menu.</li> </ul>
Poor reception of broadcast channels	<ul style="list-style-type: none"> <li>• The station may have broadcast difficulties. Try another channel.</li> <li>• Check the antenna connections.</li> <li>• If you are using a VCR, make sure the TV/VCR button is set correctly.</li> </ul>
Cannot receive above channel 13	<ul style="list-style-type: none"> <li>• Make sure the TV/CABLE switch is set to the mode that corresponds with the signal source type (cable company or outside antenna).</li> </ul>
Black box appears on the screen	<ul style="list-style-type: none"> <li>• The closed caption feature may be set to one of the Text modes (T1, T2, T3, or T4). Turn closed captioning OFF.</li> </ul>
Unable to select a certain channel	<ul style="list-style-type: none"> <li>• The channel may be locked out with the CH LOCK feature, or erased with the ADD/ERASE feature.</li> </ul>
Multiple images	<ul style="list-style-type: none"> <li>• The station may have broadcast difficulties. Try another channel.</li> <li>• Antenna reception may be poor. Use a highly directional outdoor antenna.</li> </ul>
Poor color or no color	<ul style="list-style-type: none"> <li>• The station may have broadcast difficulties. Try another channel.</li> <li>• Adjust the TINT and/or COLOR in the PICTURE menu.</li> </ul>
No stereo or SAP sound from a known MTS broadcast	<ul style="list-style-type: none"> <li>• Make sure the MTS feature is set properly.</li> </ul>
The front panel buttons do not operate	<ul style="list-style-type: none"> <li>• Check the FRONT PANEL LOCK feature.</li> </ul>
The remote control does not operate	<ul style="list-style-type: none"> <li>• Check if the TV/CABLE/VCR switch is properly set.</li> <li>• Remove all obstructions between the remote control and the remote control sensor in the TV.</li> <li>• The remote control batteries may be dead. Replace the batteries.</li> </ul>
Cannot access signal input sources (Video1, Video2, Video3, ColorStream HD1/HD2) and/or Channels 3 and 4.	<ul style="list-style-type: none"> <li>• Check the VIDEO LOCK feature.</li> </ul>

# Limited United States Warranty

## for 27" FST PURE® and All Larger Television Models

Toshiba America Consumer Products, Inc. ("TACP") and Toshiba Hawaii, Inc. ("THI") make the following limited warranties to original consumers in the United States. **THESE LIMITED WARRANTIES EXTEND TO THE ORIGINAL CONSUMER PURCHASER OR ANY PERSON RECEIVING THIS TELEVISION AS A GIFT FROM THE ORIGINAL CONSUMER PURCHASER AND TO NO OTHER PURCHASER OR TRANSFEREE.**

PRODUCTS PURCHASED IN THE U.S.A. AND USED IN CANADA ARE NOT COVERED BY THESE WARRANTIES.

PRODUCTS PURCHASED IN CANADA AND USED IN THE U.S.A. ARE NOT COVERED BY THESE WARRANTIES.

### Limited One (1) Year Warranty on Parts and Labor\*

TACP/THI warrant this television and its parts against defects in materials or workmanship for a period of one (1) year after the date of original retail purchase. **DURING THIS PERIOD, TACP/THI WILL, AT TACP/THI'S OPTION, REPAIR OR REPLACE A DEFECTIVE PART WITH A NEW OR REFURBISHED PART WITHOUT CHARGE TO YOU FOR PARTS OR LABOR.** TACP/THI Authorized Service Station personnel will come to your home when warranty service is required. Depending on the type of repair required, either the service will be performed in your home or the set will be taken to the TACP/THI Authorized Service Station for repair and returned to your home at no cost to you.

### Limited Two (2) Year Warranty on Picture Tube\*

TACP/THI further warrant the picture tube in this television against defects in materials or workmanship for a period of two (2) years after the date of original retail purchase. **DURING THIS PERIOD, TACP/THI WILL, AT TACP/THI'S OPTION, REPAIR OR REPLACE A DEFECTIVE PICTURE TUBE WITH A NEW OR REFURBISHED PICTURE TUBE WITHOUT CHARGE TO YOU, EXCEPT THAT, IF A DEFECTIVE PICTURE TUBE IS REPAIRED OR REPLACED AFTER ONE (1) YEAR FROM THE DATE OF THE ORIGINAL RETAIL PURCHASE, YOU PAY LABOR CHARGES INVOLVED IN THE REPAIR OR REPLACEMENT.**

### Rental Units

The warranty for rental units begins with the date of first rental or thirty (30) days from the date of shipment to the rental firm, whichever comes first.

### \*Commercial Units

Televisions sold and used for commercial purposes have a limited ninety (90) day warranty for all parts, labor, and picture tubes.

### Owner's Manual and Product Registration Card

Read this owner's manual thoroughly before operating this television. Complete and mail the enclosed product registration card within ten days after you, or the person who has given you this product as a gift, purchased this television. Returning the product registration card will enable TACP/THI to provide you with better customer service and improved product support. Failure to return the product registration card will not affect your rights under this warranty.

### Your Responsibility

THE ABOVE WARRANTIES ARE SUBJECT TO THE FOLLOWING CONDITIONS:

- (1) You must provide your bill of sale or other proof of purchase.
- (2) All warranty servicing of this television must be made by an Authorized TACP/THI Service Station.
- (3) The warranties from TACP and THI are effective only if the television is purchased and operated in the U.S.A. or Puerto Rico.
- (4) Labor service charges for set installation, setup, adjustment of customer controls, and installation or repair of antenna

systems are not covered by these warranties. Reception problems caused by inadequate antenna systems are your responsibility.

- (5) Warranties extend only to defects in materials or workmanship as limited above and do not extend to any television or parts that have been lost or discarded by you or to damage to television or parts caused by misuse, accident, Acts of God (such as lightning or fluctuations in electric power), improper installation, improper maintenance, or use in violation of instructions furnished by TACP/THI; or to units that have been modified or had the serial number removed, altered, defaced, or rendered illegible.

### How to Obtain Warranty Services

If, after following all of the operating instructions in this manual and checking the "Troubleshooting" section, you find that service is needed:

- (1) To find the nearest TACP/THI Authorized Service Station: For televisions purchased in the United States, except Hawaii, visit TACP's web site at [www.toshiba.com/tacp](http://www.toshiba.com/tacp), or call toll free 1-800-631-3811. For televisions purchased in Hawaii, contact Toshiba Hawaii, Inc., 327 Kamakee Street, Honolulu, HI 96814, (808) 591-9281.
- (2) Present your bill of sale or other proof of purchase to the Authorized Service Station. Authorized TACP/THI Service Station personnel will come to your home when warranty service is required. Depending on the type of repair required, either the service will be performed in your home or the set will be taken to the Authorized Service Station for repair and returned to your home at no cost to you.

**For additional information, visit TACP's web site:**  
[www.toshiba.com/tacp](http://www.toshiba.com/tacp)

ALL WARRANTIES IMPLIED BY THE LAW OF ANY STATE OF THE U.S.A., INCLUDING THE IMPLIED WARRANTIES OF MERCHANTABILITY AND FITNESS FOR A PARTICULAR PURPOSE, ARE EXPRESSLY LIMITED TO THE DURATION OF THE LIMITED WARRANTIES SET FORTH ABOVE. WITH THE EXCEPTION OF ANY WARRANTIES IMPLIED BY THE LAW OF ANY STATE OF THE U.S.A. AS HEREBY LIMITED, THE FOREGOING WARRANTY IS EXCLUSIVE AND IN LIEU OF ALL OTHER WARRANTIES, GUARANTEES, AGREEMENTS, AND SIMILAR OBLIGATIONS OF TACP OR THI WITH RESPECT TO THE REPAIR OR REPLACEMENT OF ANY PARTS. IN NO EVENT SHALL TACP OR THI BE LIABLE FOR CONSEQUENTIAL OR INCIDENTAL DAMAGES.

No person, agent, distributor, dealer, or company is authorized to change, modify, or extend the terms of these warranties in any manner whatsoever. The time within which action must be commenced to enforce any obligation of TACP or THI arising under this warranty or under any law of the United States or of any state thereof is hereby limited to 90 days from the date you discover, or should have discovered, the defect. This limitation does not apply to implied warranties arising under the law of any state of the U.S.A.

THIS WARRANTY GIVES YOU SPECIFIC LEGAL RIGHTS, AND YOU MAY ALSO HAVE OTHER RIGHTS, WHICH MAY VARY FROM STATE TO STATE IN THE U.S.A. SOME STATES OF THE U.S.A. DO NOT ALLOW LIMITATIONS ON THE DURATION OF AN IMPLIED WARRANTY, LIMITATIONS ON THE TIME WITHIN WHICH AN ACTION MAY BE BROUGHT, OR THE EXCLUSION OR LIMITATION OF INCIDENTAL OR CONSEQUENTIAL DAMAGES; THEREFORE, THE ABOVE LIMITATIONS OR EXCLUSIONS MAY NOT APPLY TO YOU UNDER SUCH CIRCUMSTANCES.

FST PURE® is a registered trademark of Toshiba America Consumer Products, Inc.  
REV. MAR02

# Limited Canada Warranty

## for 27" FST PURE® and All Larger Television Models

Toshiba of Canada Limited ("TCL") makes the following limited warranties to original consumers in Canada.

THESE LIMITED WARRANTIES EXTEND TO THE ORIGINAL CONSUMER PURCHASER OR ANY PERSON RECEIVING THIS TELEVISION AS A GIFT FROM THE ORIGINAL CONSUMER PURCHASER AND TO NO OTHER PURCHASER OR TRANSFEREE.

PRODUCTS PURCHASED IN THE U.S.A. AND USED IN CANADA ARE NOT COVERED BY THESE WARRANTIES.

PRODUCTS PURCHASED IN CANADA AND USED IN THE U.S.A. ARE NOT COVERED BY THESE WARRANTIES.

### Limited One (1) Year Warranty on Parts and Labor\*

TCL warrants this television and its parts against defects in materials or workmanship for a period of one (1) year after the date of original retail purchase. DURING THIS PERIOD, TCL WILL, AT TCL'S OPTION, REPAIR OR REPLACE A DEFECTIVE PART WITH A NEW OR REFURBISHED PART WITHOUT CHARGE TO YOU FOR PARTS OR LABOR. TCL Authorized Service Depot personnel will come to your home when warranty service is required. Depending on the type of repair required, either the service will be performed in your home or the set will be taken to the TCL Authorized Service Depot for repair and returned to your home at no cost to you. IN-HOME SERVICE ONLY APPLIES WITHIN 100 KILOMETERS OF AN AUTHORIZED TCL SERVICE DEPOT.

### Limited Two (2) Year Warranty on Picture Tube\*

TCL further warrants the picture tube in this television against defects in materials or workmanship for a period of two (2) years after the date of original retail purchase. DURING THIS PERIOD, TCL WILL, AT TCL'S OPTION, REPAIR OR REPLACE A DEFECTIVE PICTURE TUBE WITH A NEW OR REFURBISHED PICTURE TUBE WITHOUT CHARGE TO YOU, EXCEPT THAT, IF A DEFECTIVE PICTURE TUBE IS REPAIRED OR REPLACED AFTER ONE (1) YEAR FROM THE DATE OF THE ORIGINAL RETAIL PURCHASE, YOU PAY LABOR CHARGES INVOLVED IN THE REPAIR OR REPLACEMENT.

### Rental Units

The warranty for rental units begins with the date of first rental or thirty (30) days from the date of shipment to the rental firm, whichever comes first.

### \*Commercial Units

Televisions sold and used for commercial purposes have a limited ninety (90) day warranty for all parts, labor, and picture tubes.

### Owner's Manual

Read this owner's manual thoroughly before operating this television.

### Your Responsibility

THE ABOVE WARRANTIES ARE SUBJECT TO THE FOLLOWING CONDITIONS:

- (1) You must provide your bill of sale or other proof of purchase.
- (2) All warranty servicing of this television must be made by an Authorized TCL Service Depot.
- (3) The warranties from TCL are effective only if the television is purchased in Canada from an authorized TCL dealer and operated in Canada.
- (4) Labor service charges for set installation, setup, adjustment of customer controls, and installation or repair of antenna systems are not covered by these warranties. Reception problems caused by inadequate antenna systems are your responsibility.

- (5) Warranties extend only to defects in materials or workmanship as limited above and do not extend to any television or parts that have been lost or discarded by you or to damage to television or parts caused by misuse, accident, Acts of God (such as lightning or fluctuations in electric power), improper installation, improper maintenance, or use in violation of instructions furnished by TCL; or to units that have been modified or had the serial number removed, altered, defaced, or rendered illegible.

### How to Obtain Warranty Services

If, after following all of the operating instructions in this manual and checking the "Troubleshooting" section, you find that service is needed:

- (1) To find the nearest TCL Authorized Service Depot, visit TCL's web site: [www.toshiba.ca](http://www.toshiba.ca).
- (2) Present your bill of sale or other proof of purchase to the Authorized Service Depot. Authorized TCL Service Depot personnel will come to your home when warranty service is required. Depending on the type of repair required, either the service will be performed in your home or the set will be taken to the Authorized Service Depot for repair and returned to your home at no cost to you. **IN-HOME SERVICE ONLY APPLIES WITHIN 100 KILOMETERS OF AN AUTHORIZED TCL SERVICE DEPOT.**

**For additional information, visit TCL's web site:  
[www.toshiba.ca](http://www.toshiba.ca)**

ALL WARRANTIES IMPLIED BY THE LAW OF ANY PROVINCE OF CANADA, INCLUDING THE IMPLIED WARRANTIES OF MERCHANTABILITY AND FITNESS FOR A PARTICULAR PURPOSE, ARE EXPRESSLY LIMITED TO THE DURATION OF THE LIMITED WARRANTIES SET FORTH ABOVE. WITH THE EXCEPTION OF ANY WARRANTIES IMPLIED BY THE LAW OF ANY PROVINCE OF CANADA AS HEREBY LIMITED, THE FOREGOING WARRANTY IS EXCLUSIVE AND IN LIEU OF ALL OTHER WARRANTIES, GUARANTEES, AGREEMENTS, AND SIMILAR OBLIGATIONS OF TCL WITH RESPECT TO THE REPAIR OR REPLACEMENT OF ANY PARTS. IN NO EVENT SHALL TCL BE LIABLE FOR CONSEQUENTIAL OR INCIDENTAL DAMAGES.

No person, agent, distributor, dealer, or company is authorized to change, modify, or extend the terms of these warranties in any manner whatsoever. The time within which action must be commenced to enforce any obligation of TCL arising under this warranty or under any law of Canada or of any province thereof, is hereby limited to 90 days from the date you discover, or should have discovered, the defect. This limitation does not apply to implied warranties arising under the law of any province of Canada.

THIS WARRANTY GIVES YOU SPECIFIC LEGAL RIGHTS, AND YOU MAY ALSO HAVE OTHER RIGHTS, WHICH MAY VARY FROM PROVINCE TO PROVINCE IN CANADA. SOME PROVINCES OF CANADA DO NOT ALLOW LIMITATIONS ON THE DURATION OF AN IMPLIED WARRANTY, LIMITATIONS ON THE TIME WITHIN WHICH AN ACTION MAY BE BROUGHT, OR THE EXCLUSION OR LIMITATION OF INCIDENTAL OR CONSEQUENTIAL DAMAGES; THEREFORE, THE ABOVE LIMITATIONS OR EXCLUSIONS MAY NOT APPLY TO YOU UNDER SUCH CIRCUMSTANCES.

FST PURE® is a registered trademark of Toshiba America Consumer Products, Inc.  
REV. MAR02

# Index

## A

A/V cables (standard) .....	7
A/V receiver connection .....	13
ANT 1/2 .....	20
Antenna cables (coaxial) .....	7
AUDIO OUT sound, selecting .....	47
Audio system connection .....	13
Auto power off .....	49

## B

BACKGROUND selection .....	48
Back of the TV .....	6

## C

CableClear™ DNR .....	39
Cable converter box connection .....	8
Camcorder connection .....	12
CH ▲▼ buttons .....	23
CH LABEL .....	26
CH LOCK .....	35
CH RTN button .....	24
Channel Number buttons .....	23
Channel programming	
ADD/ERASE .....	21
Automatic programming .....	21
TV/CABLE selection .....	21
Cinema mode .....	40
Clock, setting .....	43
Closed caption .....	42
ColorStream (component) cables .....	7
Color temperature .....	40

## D

DEMO mode .....	49
Double-window .....	29
DTV receiver connection .....	11
DVD connection .....	9, 10

## F I

FAV ▼▲ buttons .....	25
FAVORITE button .....	31
Favorite channels, programing .....	24
Front of the TV .....	6
Front panel lock .....	37
Image shape selection .....	27

## L M

Labeling channels .....	26
Labeling video inputs .....	41
Language selection .....	20
Last mode memory .....	49
Locking channels .....	35
Locking video inputs .....	36
Locks menu .....	32
Menu system .....	19
MTS feature .....	44
Multi-Window feature .....	31
MUTE button .....	44

## P

Picture adjustments	
COLOR TEMPERATURE .....	40
FLESH TONE .....	39
Picture mode .....	38
Picture quality .....	38
PIP feature	
LOCATE button .....	30
PIP button .....	29
PIP CH ▲▼ buttons .....	29
SOURCE button .....	29
STILL button .....	30
SWAP button .....	30
PIC SIZE button .....	27

## Q R

Quick connect guide .....	22
RECALL button .....	48
Remote control	
Battery installation .....	14
Learning about the buttons .....	18
Programming .....	15
RESET .....	40, 46

## S

S-video cables .....	7
SAP sound .....	44
Satellite receiver connection .....	9
Set-top box connection .....	11
Sleep timer .....	43
Sound quality adjustments .....	45
SPEAKERS on/off .....	47
Specifications .....	50
SpeedSurf mode .....	23
SRS 3D surround .....	45
StableSound® .....	48
Stereo sound .....	44
STROBE button .....	31
Sub-bass system (SBS) .....	46
SurfLock™ .....	24

## T

TILT CORRECTION .....	23
TIMER button .....	43
Troubleshooting .....	51
TV/VIDEO button .....	20, 41

## V

V-CHIP	
BLOCKING OPTION .....	34
ENABLE BLOCKING .....	33
MPAA RATING .....	34
NEW PIN CODE .....	37
TV RATING .....	33
Unlocking programs temporarily .....	35
VCR connection .....	7-12
VIDEO LABEL .....	41
VIDEO LOCK .....	36

## W

Warranty .....	52, 53
----------------	--------

## **TOSHIBA AMERICA CONSUMER PRODUCTS, INC.**

HEAD OFFICE: 82 TOTOWA ROAD, WAYNE, NJ 07470, U.S.A.  
NATIONAL SERVICE DIVISION: 1420-B TOSHIBA DRIVE, LEBANON, TN 37087, U.S.A.

## **TOSHIBA HAWAII, INC.**

HEAD OFFICE: 327 KAMAKEE STREET, HONOLULU, HI 96814, U.S.A. – TEL: (808) 591-9281

## **TOSHIBA OF CANADA LTD.**

HEAD OFFICE: 191 McNABB STREET, MARKHAM, ONTARIO, L3R 8H2, CANADA – TEL: (905) 470-5400

**SERVICE CENTERS:**

TORONTO: 191 McNABB STREET, MARKHAM, ONTARIO L3R 8H2, CANADA – TEL: (905) 470-5400

MONTREAL: 1643 NORTH SERVICE RD., TRANS-CANADA HIGHWAY, DORVAL QUEBEC, H9P 1J1, CANADA – TEL: (514) 856-4100

VANCOUVER: 22171 FRASERWOOD WAY, RICHMOND, B.C., V6W 1J5, CANADA – TEL: (604) 303-2500

MANUFACTURED BY

**TOSHIBA AMERICA CONSUMER PRODUCTS, INC.**

ColorStream and StableSound are registered trademarks of Toshiba America Consumer Products, Inc.  
CableClear and SurfLock are trademarks of Toshiba America Consumer Products, Inc.

PRINTED IN USA  
(02-06) R

# **TOSHIBA**

23565661

## Free Manuals Download Website

<http://myh66.com>

<http://usermanuals.us>

<http://www.somanuals.com>

<http://www.4manuals.cc>

<http://www.manual-lib.com>

<http://www.404manual.com>

<http://www.luxmanual.com>

<http://aubethermostatmanual.com>

Golf course search by state

<http://golfingnear.com>

Email search by domain

<http://emailbydomain.com>

Auto manuals search

<http://auto.somanuals.com>

TV manuals search

<http://tv.somanuals.com>