

TOSHIBA

OWNER'S MANUAL

Color Television

COLORSTREAM® SRS WOW

32HF73

36HF73



Owner's Record

The model number and serial number are on the back of your TV. Record these numbers in the spaces below. Refer to these numbers whenever you communicate with your Toshiba dealer about this TV.

Model number:

Serial number:

Introduction

Connecting your TV

Using the Remote Control

Setting up your TV

Using the TV's Features

Appendix

Index

Dear Customer,

Thank you for purchasing this Toshiba TV. This manual will help you use the many exciting features of your new TV.

Before operating the TV, please read this manual completely, and keep it nearby for future reference.

Safety Precautions

WARNING

TO REDUCE THE RISK OF FIRE OR ELECTRIC SHOCK, DO NOT EXPOSE THIS APPLIANCE TO RAIN OR MOISTURE.

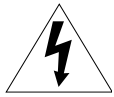

WARNING
RISK OF ELECTRIC SHOCK
DO NOT OPEN



WARNING: TO REDUCE THE RISK OF ELECTRIC SHOCK, DO NOT REMOVE COVER (OR BACK). NO USER-SERVICEABLE PARTS INSIDE. REFER SERVICING TO QUALIFIED SERVICE PERSONNEL.



The lightning symbol in the triangle tells you that the voltage inside this product may be strong enough to cause an electric shock. **DO NOT TRY TO SERVICE THIS PRODUCT YOURSELF.**



The exclamation mark in the triangle tells you that important operating and maintenance instructions follow this symbol.

NOTE TO CATV INSTALLERS IN THE USA

This is a reminder to call the CATV system installer's attention to Article 820-40 of the NEC, which provides guidelines for proper grounding and, in particular, specifies that the cable ground shall be connected to the grounding system of the building, as close to the point of cable entry as practical. For additional antenna grounding information, see items 25 and 26 on page 4.

NOTICE OF POSSIBLE TV STAND INSTABILITY



DANGER: RISK OF SERIOUS PERSONAL INJURY OR DEATH! Use this TV with the TOSHIBA TV stand recommended in the "Specifications" section only. Use with other stands may result in instability, causing possible injury or death.

EXEMPTIONS

TACP/THI/TCL are not liable for:

- (1) damage caused by natural disaster (such as thunder, fire, earthquake), use by third person, accidents, owner's intentional misuse, or use in other improper conditions;
- (2) incidental damages (such as profit loss or interruption in business, modification or erasure of record data, and so forth) caused by use or misuse of this product;
- (3) damage caused by neglect of the instructions described in the owner's manual; and
- (4) damage caused by misuse or malfunction through simultaneous use of this product and the connected equipment.

Child Safety

It Makes A Difference Where Your TV Stands



Congratulations on your purchase! As you enjoy your new TV, keep these safety tips in mind:

The Issue

- If you are like most consumers, you have a TV in your home. Many homes, in fact, have more than one TV.
- The home theater entertainment experience is a growing trend, and larger TVs are popular purchases; however, they are not always supported on the proper TV stands.
- Sometimes TVs are improperly secured or inappropriately situated on dressers, bookcases, shelves, desks, audio speakers, chests, or carts. As a result, TVs may fall over, causing unnecessary injury.

Toshiba Cares!

- The consumer electronics industry is committed to making home entertainment enjoyable and safe.
- The Consumer Electronics Association formed the Home Entertainment Support Safety Committee, comprised of TV and consumer electronics furniture manufacturers, to advocate children's safety and educate consumers and their families about television safety.

Tune Into Safety

- One size does NOT fit all! Use appropriate furniture large enough to support the weight of your TV (and other electronic components).
- Use appropriate angle braces, straps, and anchors to secure your furniture to the wall (but never screw anything directly into the TV).
- Carefully read and understand the other enclosed instructions for proper use of this product.
- Do not allow children to climb on or play with furniture and TVs.
- Avoid placing any item on top of your TV (such as a VCR, remote control, or toy) that a curious child may reach for.
- Remember that children can become excited while watching a program and can potentially push or pull a TV over.
- Share our safety message about this hidden hazard of the home with your family and friends. Thank you!



2500 Wilson Blvd.
Arlington, VA 22201 U.S.A.
Tel. 703-907-7600 Fax 703-907-7690
www.CE.org

CEA is the Sponsor, Producer and Manager of the International CES®

Important Safety Instructions

- 1) **Read these instructions.**
- 2) **Keep these instructions.**
- 3) **Heed all warnings.**
- 4) **Follow all instructions.**



- 5) **Do not use this apparatus near water.**



- 6) **Clean only with a dry cloth.**

- 7) **Do not block any ventilation openings.** Install in accordance with the manufacturer's instructions.

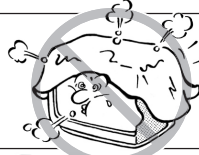

- 8) **Do not install near any heat sources** such as radiators, heat registers, stoves, or other apparatus (including amplifiers) that produce heat.

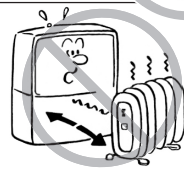

- 9) **Do not defeat the safety purpose of the polarized or grounding type plug.** A polarized plug has two blades with one wider than the other. A grounding type plug has two blades and a third grounding prong. The wide blade or the third prong are provided for your safety. If the provided plug does not fit into your outlet, consult an electrician for replacement of the obsolete outlet.

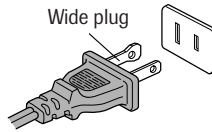

- 10) **Protect the power cord** from being walked on or pinched, particularly at plugs, convenience receptacles, and the point where it exits the apparatus.

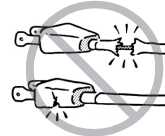

- 11) **Only use attachments/accessories specified by the manufacturer.**

- 12) **Use only with the cart, stand, tripod, bracket, or table specified by the manufacturer, or sold with the apparatus.** When a cart is used, use caution when moving the cart/apparatus combination to avoid injury from tip-over.



- 13) **Unplug this apparatus during lightning storms or when unused for long periods of time.**

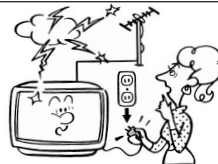

- 14) **Refer all servicing to qualified service personnel.**

Servicing is required when the apparatus has been damaged in any way, such as power supply cord or plug is damaged, liquid has been spilled or objects have fallen into the apparatus, the apparatus has been exposed to rain or moisture, does not operate normally, or has been dropped.

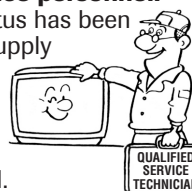

- 15) **CAUTION:** To reduce the risk of electric shock, do not use the polarized plug with an extension cord, receptacle, or other outlet unless the blades can be inserted completely to prevent blade exposure.

Installation, Care, and Service

Installation

Follow these recommendations and precautions and heed all warnings when installing your TV:

- 16) Never modify this equipment. Changes or modifications may void: a) the warranty, and b) the user's authority to operate this equipment under the rules of the Federal Communications Commission.

- 17) **DANGER: RISK OF SERIOUS PERSONAL INJURY, DEATH, OR EQUIPMENT DAMAGE!** Never place the TV on an unstable cart, stand, or table. The TV may fall, causing serious personal injury, death, or serious damage to the TV.



- 18) Never place or store the TV in direct sunlight; hot, humid areas; areas subject to excessive dust or vibration; or locations with temperatures at or below 41°F (5°C).

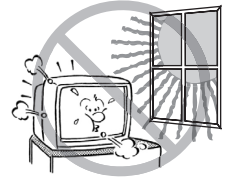

- 19) Always place the TV on the floor or a sturdy, level, stable surface that can support the weight of the unit.



- 20) Never place items such as vases, aquariums, or candles on top of the TV.



- 21) Never block or cover the slots or openings in the TV cabinet back, bottom, and sides. Never place the TV:

- on a bed, sofa, rug, or similar surface;
- too close to drapes, curtains, or walls; or
- in a confined space such as a bookcase, built-in cabinet, or any other place with poor ventilation.



The slots and openings are provided to protect the TV from overheating and to help maintain reliable operation of the TV.



- 22) Never allow anything to rest on or roll over the power cord, and never place the TV where the power cord is subject to wear or abuse.

- 23) Never overload wall outlets and extension cords.



- 24) Always operate this equipment from a 120 VAC, 60 Hz power source only.



- 25) Always make sure the antenna system is properly grounded to provide adequate protection against voltage surges and built-up static charges (see Section 810 of the National Electric Code).

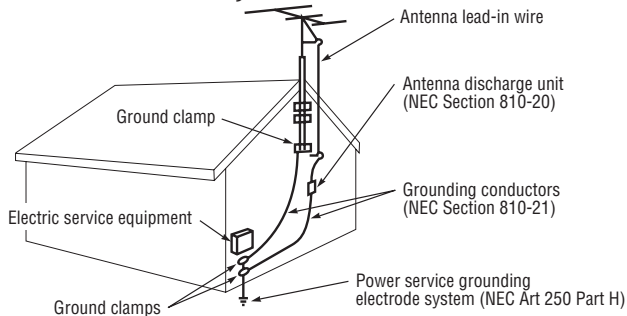

- 26) **! DANGER: RISK OF SERIOUS PERSONAL INJURY OR DEATH!**
- Use extreme care to make sure you are never in a position where your body (or any item you are in contact with, such as a ladder or screwdriver) can accidentally touch overhead power lines. Never locate the antenna near overhead power lines or other electrical circuits.
 - Never attempt to install any of the following during lightning activity:
 - a) an antenna system; or b) cables, wires, or any home theater component connected to an antenna or phone system.

Care

For better performance and safer operation of your TOSHIBA TV, follow these recommendations and precautions:

- 27) Always sit approximately 10–25 feet away from the TV and as directly in front of it as possible. The picture can appear dull if you sit too far to the left or right of the TV, or if sunlight or room lights reflect on the screen. Turn the TV off to check for reflections on the screen, and then remove the source of reflections while viewing the TV.

- 28) Always unplug the TV before cleaning. Never use liquid or aerosol cleaners.

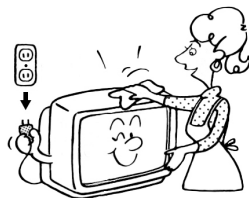

- 29) **! WARNING: RISK OF ELECTRIC SHOCK!** Never spill liquids or push objects of any kind into the TV cabinet slots.

- 30) [This item applies to projection TVs only.] If the air temperature rises suddenly (for example, when the TV is first delivered), condensation may form on the lenses. This can make the picture appear distorted or the color appear faded. If this happens, turn off the TV for 6 to 7 hours to allow the condensation to evaporate.

- 31) For added protection of your TV from lightning and power surges, always unplug the power cord and disconnect the antenna from the TV if you leave the TV unattended or unused for long periods of time.

- 32) During normal use, the TV may make occasional snapping or popping sounds. This is normal, especially when the unit is being turned on or off. If these sounds become frequent or continuous, unplug the power cord and contact a Toshiba Authorized Service Center.

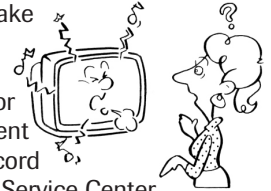

- 33) **Possible Adverse Effects on TV Picture Tube:** If a fixed (non-moving) pattern remains on the TV screen for long periods of time, the image can become permanently engrained in the picture tube and cause subtle but permanent ghost images. **This type of damage is NOT COVERED BY YOUR WARRANTY.** Never leave your TV on for long periods of time while it is displaying the following formats or images:

- **Fixed Images**, such as PIP/POP windows, stock tickers, video game patterns, TV station logos, and websites.
- **Special Formats** that do not use the entire screen. For example, viewing letterbox style (16:9) media on a normal (4:3) display (gray bars at top and bottom of screen); or viewing normal style (4:3) media on a widescreen (16:9) display (gray bars on left and right sides of screen).

Service

- 34) **! WARNING: RISK OF ELECTRIC SHOCK!** Never attempt to service the TV yourself. Opening and removing the covers may expose you to dangerous voltage or other hazards. Refer all servicing to a Toshiba Authorized Service Center.

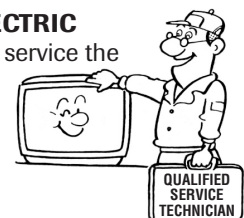

- 35) If you have the TV serviced:

- Ask the service technician to use only replacement parts specified by the manufacturer.
- Upon completion of service, ask the service technician to perform routine safety checks to determine that the TV is in safe operating condition.

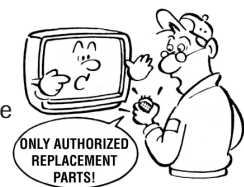

- 36) When the TV reaches the end of its useful life, ask a qualified service technician to properly dispose of the TV. Improper disposal may result in a picture tube implosion and possible personal injury.

Important Safety Information	2-4		
Introduction	6		
Welcome to Toshiba	6		
Exploring your new TV	6		
Note regarding Quick Connect Guide	6		
Connecting your TV	7		
Connecting a VCR	7		
Connecting a cable converter box	8		
Connecting a cable converter box and VCR	8		
Connecting a DVD player or satellite receiver and a VCR	9		
Connecting a DVD player with ColorStream® (component video) and a VCR	10		
Connecting a DTV receiver/set-top box with ColorStream® (component video) and a VCR	11		
Connecting two VCRs	12		
Connecting a camcorder	12		
Connecting a device to the DVI/HDCP input	13		
Connecting an audio system	14		
Connecting an A/V receiver	14		
Using the remote control	15		
Preparing the remote control for use	15		
Installing the remote control batteries	15		
Programming the remote control to operate a cable converter box, satellite receiver, VCR, DVD player, or HTIB (home theater in a box)	16		
Remote control codes	16		
Remote control codes (cont.)	17		
Using the remote control to operate a cable converter box, satellite receiver, VCR, DVD player, or HTIB (home theater in a box)	18		
Learning about the remote control	19		
Setting up your TV	20		
Learning about the menu system	20		
Changing the on-screen display language	21		
Selecting the antenna input	21		
Adding channels to the TV's memory	22		
Programming channels automatically	22		
Adding and erasing channels manually	22		
Using the Quick Connect Guide	23		
Changing channels	24		
Changing channels using SpeedSurf	24		
Adjusting the tilt correction feature	24		
Using the TV's features	25		
Adjusting the channel settings	25		
Switching between two channels using Channel Return	25		
Switching between two channels using SurfLock™ ..	25		
Programming your favorite channels	25		
Labeling channels	27		
Viewing the wide-screen picture formats	28		
Selecting the image shape	28		
Using the auto aspect feature	30		
Selecting the cinema mode	30		
Using the POP double-window feature	31		
Switching the main and POP pictures	32		
Freezing the POP picture	32		
		Adjusting the size of the double-window	32
		Double-Window with keeping aspect ratio	33
		Using the programmed channel search function	33
		Using the favorite channel search function	34
		About the auto favorite feature	34
		Using the LOCKS menu	35
		Entering the PIN code	35
		If you cannot remember your PIN code	35
		Using the V-CHIP menu	36
		ENABLE BLOCKING	36
		TV RATING (Independent rating system for broadcasters)	36
		MPAA RATING (Independent rating system for movies)	37
		BLOCKING OPTION	37
		Unlocking programs temporarily	38
		Locking channels	38
		Locking video inputs	39
		Using the game timer	40
		Using the front panel lock feature	40
		Changing the PIN code	40
		Adjusting the picture	41
		Selecting the picture mode	41
		Adjusting the picture quality	41
		Saving new preference	42
		Using the flesh tone feature	42
		Using the CableClear™ DNR feature	42
		Selecting the color temperature	43
		Selecting the display format (540p/1080i)	43
		Resetting picture adjustments	43
		Selecting the video input source	44
		Labeling the video input sources	44
		Using the closed caption feature	45
		Setting the ON-timer	46
		Setting the sleep timer	46
		Setting the clock	47
		Selecting the background of the menu display	47
		Adjusting the sound	48
		Muting the sound	48
		Selecting stereo/SAP broadcasts	48
		Using the WOW™ surround sound feature	49
		Adjusting the sound quality	49
		Resetting your audio adjustments	50
		Using the sub-bass system (SBS)	50
		Turning off the built-in speakers	51
		Selecting the Audio OUT sound	51
		Using the StableSound® feature	52
		Displaying on-screen information	52
		Viewing the demo mode	53
		Understanding the auto power off feature	53
		Understanding the last mode memory feature	53
		Appendix	54
		Specifications	54
		Troubleshooting	55
		Limited United States Warranty	56
		Limited Canada Warranty	57
		Index	58

Introduction

Welcome to Toshiba

Congratulations! You have purchased one of the finest color TVs on the market. The goal of this manual is to guide you through setting up and operating your Toshiba TV as quickly as possible.

This manual applies to models 32HF73 and 36HF73. Before you start reading, check your model number on the back of the TV.

Instructions in this manual are based on using the remote control. You can also use the controls on the TV if they have the same name as those on the remote control.

Please read all the safety and operating instructions carefully, and keep the manual for future reference.

Exploring your new TV

You can operate your TV using the buttons on the front panel or the remote control. The back panel and front panel (behind the door) provide all the terminal connections you will need to connect other equipment to your TV. See "Connecting your TV" on page 7.

Illustrations represent 32HF73.

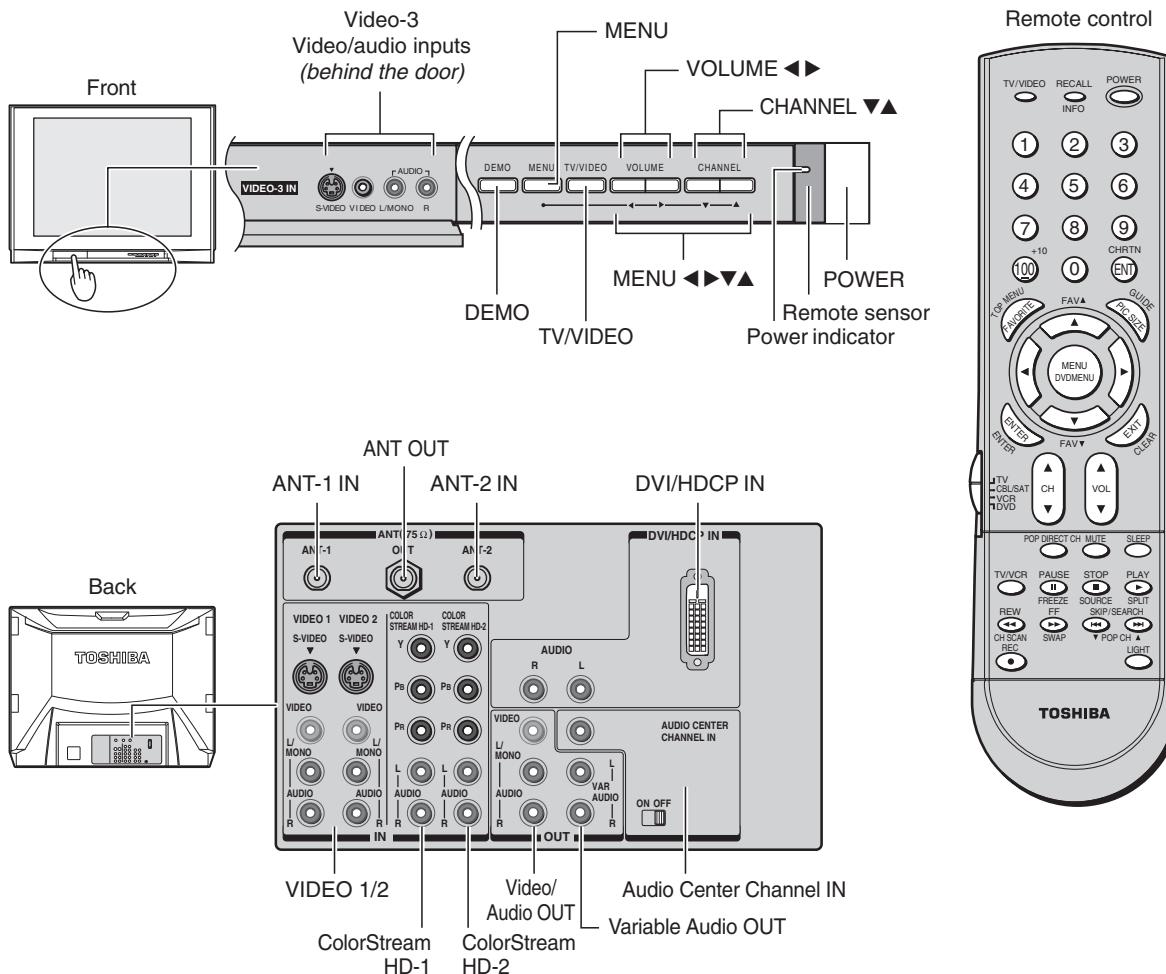

Note regarding Quick Connect Guide

The **Quick Connect Guide** automatically appears on-screen the first time the TV is turned on. This feature provides on-screen instructions to guide you through initial setup of your TV.

To stop the **Quick Connect Guide**, either press EXIT or turn off the TV.

See page 23 for details.

Connecting your TV

Note: Cables are not supplied with your TV.

- **Coaxial cable** is the cable that comes in from your antenna, cable TV service, or cable converter box. Coaxial cable uses "F" connectors.
- **Standard A/V (audio/video) cables** usually come in sets of three, and are typically color-coded according to use: yellow for video, red for stereo right audio, and white for stereo left (or mono) audio. On your TV's back panel, the standard A/V inputs are color-coded in the same manner as the cables.
- **S-Video cable** is for use with video equipment that has an S-Video input.
- **Component video cables** come in sets of three, and are for use with video equipment that has component video inputs. (ColorStream® is Toshiba's brand of component video.)
- **DVI-D digital single-link cable** is for use with video equipment that has a DVI-D digital single-link connector (see page 13).

NOTE REGARDING PICTURE QUALITY

When connecting video equipment to your Toshiba TV:

- **For GOOD picture quality:** Use a standard yellow video cable.
- **For BETTER picture quality:** If your equipment has an S-video input, use an S-video cable **instead of** a standard yellow video cable. (You still must connect the standard red and white audio cables for full system connection, but **do not connect the standard yellow video cable at the same time**, or the picture performance will be unacceptable.)
- **For BEST picture quality:** If your equipment has component video (or DVI) inputs, use either component video cables (or a DVI cable) **instead of** a standard video or S-video cable. (You still must connect the standard red and white audio cables for full system connection, but **do not connect the standard yellow video cable or an S-Video cable at the same time**.)

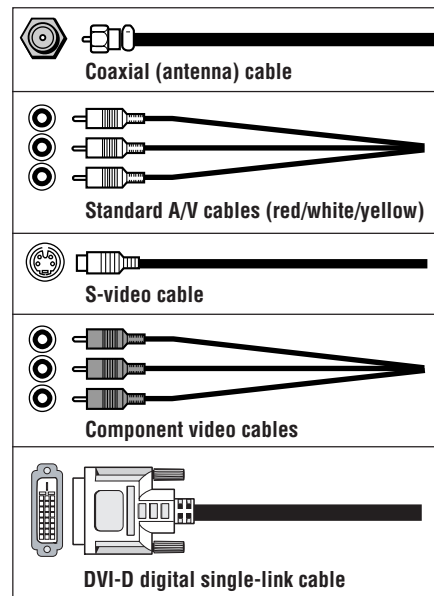

CAUTION:

Do not plug in any power cords until you have finished connecting all equipment.

Connecting a VCR

This connection allows you to watch local channels and video programs, play or record on the VCR while watching TV, and record from one channel while watching another channel.

You will need:

- two coaxial cables
- one set of A/V cables

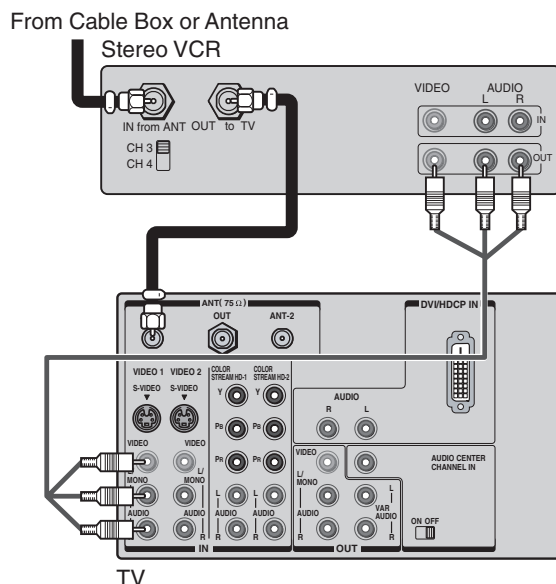

Note:

If you have a mono VCR, connect L/Mono to VCR Audio OUT using only one audio cable.

If you have a VCR with S-video, use an S-video cable (in the S-video jacks) instead of the regular video cable.

Do not connect a regular video cable and an S-video cable to Video 1 (or Video 2) at the same time, or the picture performance will be unacceptable.

The unauthorized recording, use, distribution, or revision of television programs, videotapes, DVDs, and other materials is prohibited under the Copyright Laws of the United States and other countries, and may subject you to civil and criminal liability.

Connecting a cable converter box

This connection allows you to watch basic and premium cable channels. To watch basic cable and use the TV's features, select ANT-1. To view premium channels, select ANT-2, tune the TV to channel 3 or 4 (whichever channel is vacant in your area), and use the converter box to change channels.

You will need:

- three coaxial cables

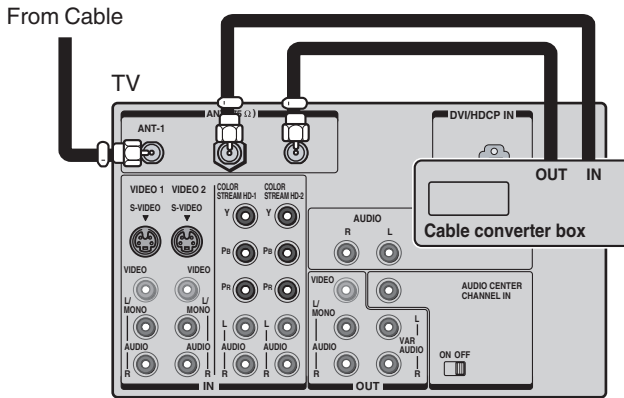

Note:

When you use a converter box with your TV, the remote control will not operate some features, such as programming your favorite channels, labeling channels, and locking channels.

Connecting a cable converter box and VCR

This connection allows you to watch and record basic and premium cable channels, watch videotapes, and record one channel while watching another channel. To watch basic cable and use the TV's features, select ANT-1.

To view premium channels or record with the VCR, select ANT-2, tune the TV to channel 3 or 4 (whichever channel is vacant in your area), and use the converter box to change channels.

You will need:

- four coaxial cables
- one set of A/V cables

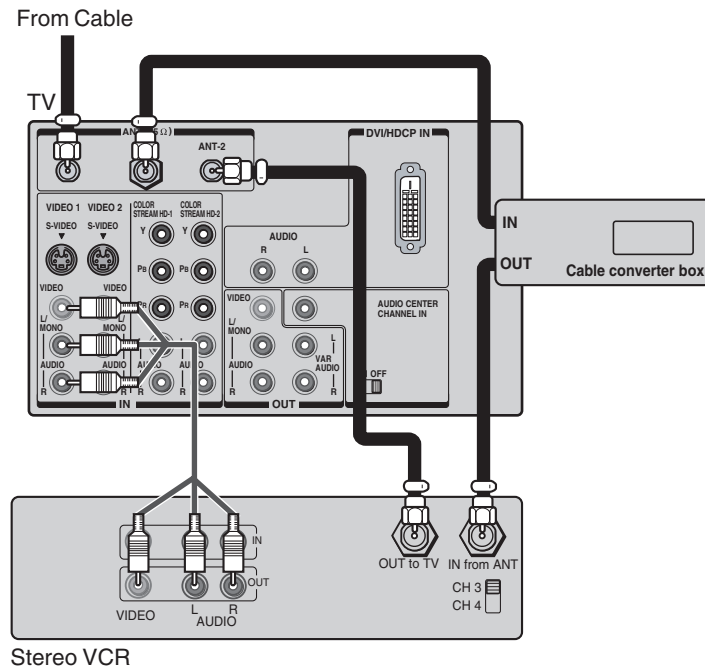

Note:

If you have a mono VCR, connect L/Mono to VCR Audio OUT using only one audio cable.

If you have a VCR with S-video, use an S-video cable (in the S-video jacks) instead of a regular video cable. Do not connect a regular video cable and an S-video cable to Video 1 (or Video 2) at the same time.

When you use a converter box with your TV, the remote control will not operate some features, such as programming your favorite channels, labeling channels, and locking channels.

The unauthorized recording, use, distribution, or revision of television programs, videotapes, DVDs, and other materials is prohibited under the Copyright Laws of the United States and other countries, and may subject you to civil and criminal liability.

Connecting a DVD player or satellite receiver and a VCR

This connection allows you to watch DVD/satellite, VCR, and TV programs, and record one TV channel while watching another channel.

You will need:

- two coaxial cables (three if satellite receiver is used)
- one set of A/V cable
- one pair of audio cables
- one S-video cable (between the TV and DVD player/satellite receiver)

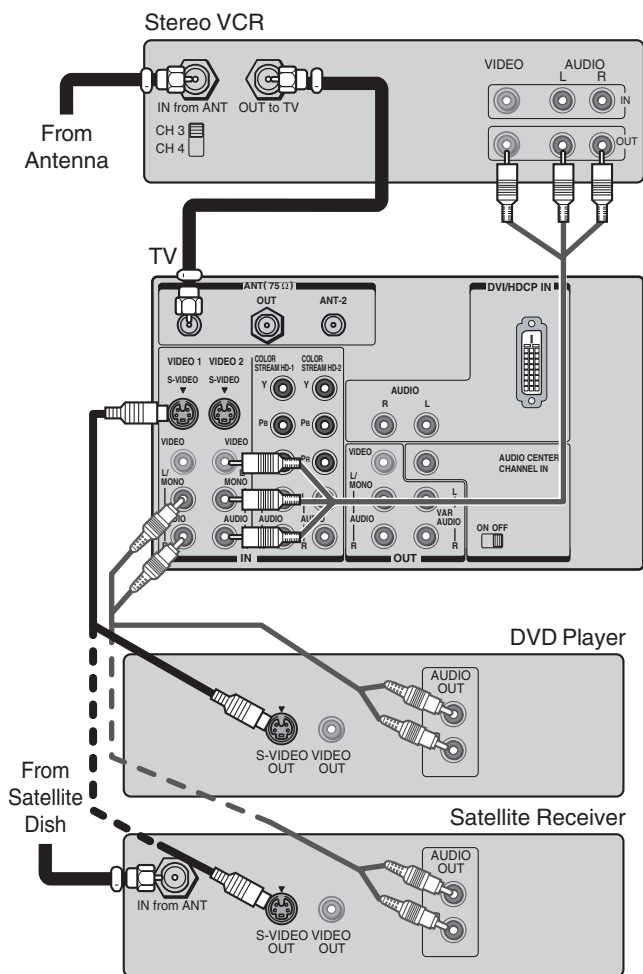

Note:

For the highest possible picture quality from a non-ColorStream DVD player/satellite receiver, you must use an S-video cable between the TV and DVD player/satellite receiver. (If your DVD player or satellite receiver is ColorStream-compatible, see page 10).

Do not connect both an S-video cable and a regular video cable between the TV and DVD player/satellite receiver at the same time. Doing so will distort the picture.

Do not connect the DVD player/satellite receiver and VCR to the same video channel on the TV. (See the illustrations, which show the DVD player/satellite receiver connected to Video 1 on the TV, and the VCR connected to Video 2 on the TV.)

The unauthorized recording, use, distribution, or revision of television programs, videotapes, DVDs, and other materials is prohibited under the Copyright Laws of the United States and other countries, and may subject you to civil and criminal liability.

Connecting a DVD player with ColorStream® (component video) and a VCR

This connection allows you to watch DVD, VCR, and TV programs, and record TV programs.

Your TV has ColorStream® (component video) inputs. Connecting your TV to a DVD player with component video inputs (such as a Toshiba DVD player with ColorStream®) can greatly enhance picture quality and realism.

- To record one TV program while watching another TV program, tune the VCR to the channel to record, and tune the TV to the channel to watch.
- To record a TV program while watching a DVD, tune the VCR to the channel to record, and select ColorStream HD-1 on the TV (see “Selecting the antenna input” on page 21).

You will need:

- two coaxial cables
- one set of A/V cable
- one pair of audio cable
- one set of component video cables (one S-video cable for a DVD player without component video inputs; see notes at right)

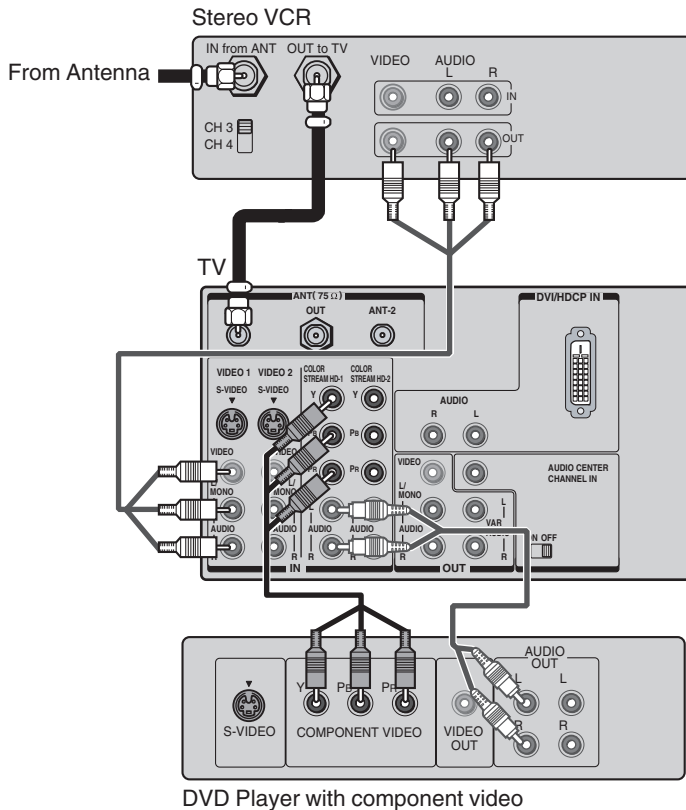

Note:

For the highest possible picture quality, use component video cables between the TV and DVD player. You can connect the component video cables from the DVD player to either ColorStream jack on the TV (HD-1 or HD-2).

The ColorStream HD-1 and HD-2 jacks can be used with Progressive (480p, 720p) and Interlace (480i, 1080i) scan systems.

If your DVD player does not have component video inputs, use the S-video connections (plus the standard audio connections) instead of the ColorStream connections; however, do not connect both S-Video and standard video cables between the TV and DVD player at the same time. See page 9.

The unauthorized recording, use, distribution, or revision of television programs, videotapes, DVDs, and other materials is prohibited under the Copyright Laws of the United States and other countries, and may subject you to civil and criminal liability.

Connecting a DTV receiver/set-top box with ColorStream® (component video) and a VCR

This connection allows you to watch DTV (digital TV), VCR, and TV programs, and record DTV and TV programs.

Your TV has ColorStream (component video) inputs. Connecting your TV to a DTV receiver with component video inputs can greatly enhance picture quality and realism.

- To record and watch a DTV program, select LINE IN on the VCR, and select ColorStream HD-2 (or VIDEO 1 for a non-ColorStream connection) on the TV (see “Selecting the antenna input” on page 21).
- To record a TV program while watching a DTV program, tune the VCR to the channel to record, and select ColorStream HD-2 on the TV.
- To record and watch the same TV program, tune the VCR to the channel to record, and select VIDEO 1 on the TV.
- To record one TV program while watching another TV program, tune the VCR to the channel to record, and tune the TV to the channel to watch.

You will need:

- three coaxial cables
- two sets of A/V cables
- one pair of audio cables
- one set of component video cables (one S-video cable for a DTV receiver without component video; see notes at right)

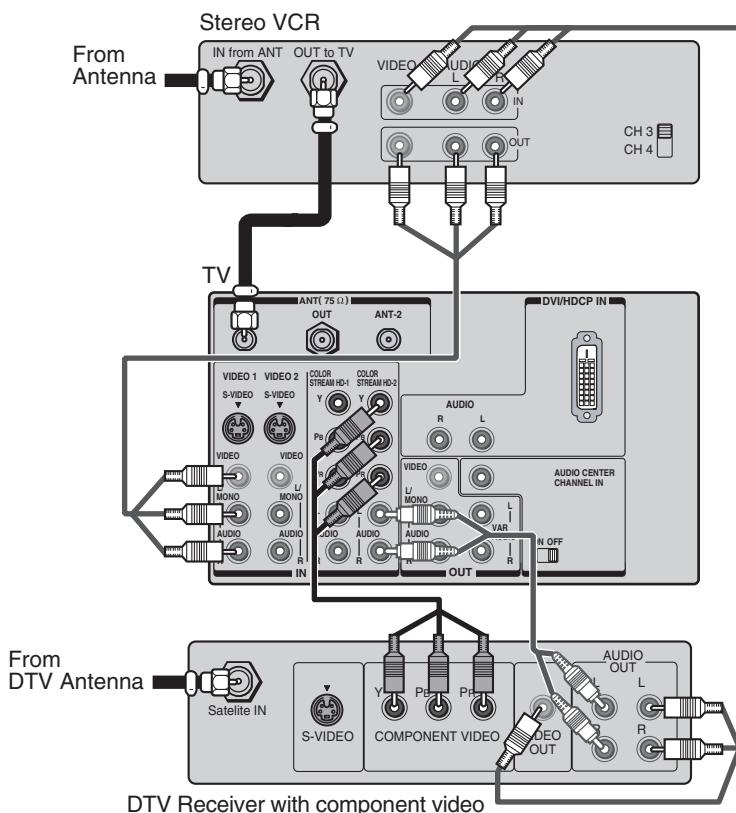

Note:

For the highest possible picture quality, use component video cables between the TV and DTV receiver. You can connect the component cables from the DTV receiver to either ColorStream jack on the TV (HD-1 or HD-2).

The ColorStream HD-1 and HD-2 jacks can be used with Progressive (480p, 720p) and Interlace (480i, 1080i) scan systems.

If your DTV receiver does not have component video inputs, use the S-video and standard audio connections instead of the ColorStream connections. Do not connect both an S-video and a standard video cable between the TV and DTV receiver at the same time.

To monitor recording, set the TV to VIDEO 1.

The unauthorized recording, use, distribution, or revision of television programs, videotapes, DVDs, and other materials is prohibited under the Copyright Laws of the United States and other countries, and may subject you to civil and criminal liability.

Connecting two VCRs

This connection allows you to record (dub/edit) from one VCR to another VCR while watching a videotape. You can also record from one TV channel while watching another TV channel.

You will need:

- two coaxial cables
- two sets of A/V cables

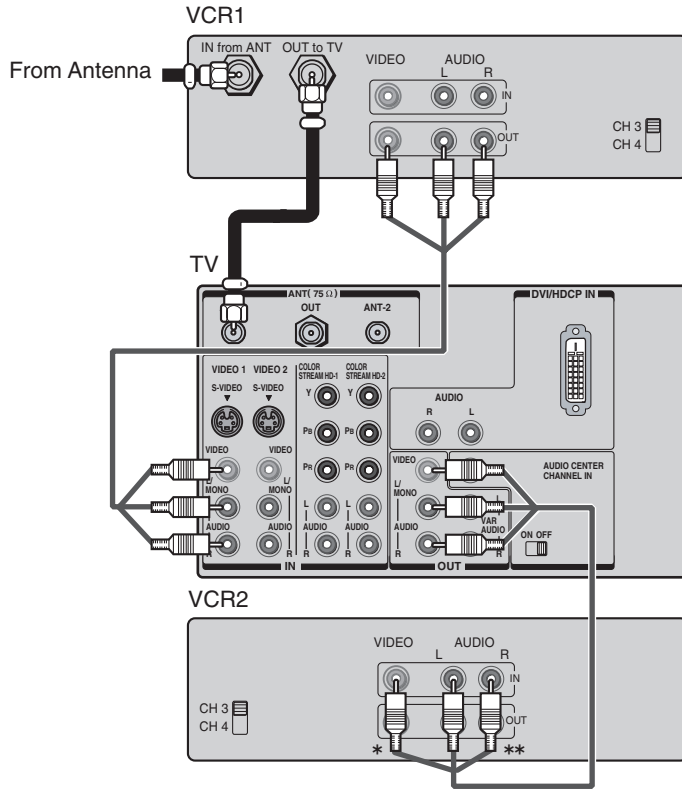

Note:

If you have VCRs with S-video, use S-video cables instead of standard video cables for better picture performance. Do not connect both a standard video cable and an S-video cable to Video 1 (or Video 2) at the same time, or the picture performance will be unacceptable.

Do not connect the same VCR to the output and input jacks on the TV at the same time.

To dub or edit, VCR 2 must select Line IN, and the TV must select VIDEO 1 (see "Selecting the antenna input" on page 21).

* The Video OUT jack does not output the POP picture.

** The Audio OUT jacks can output the sound of either the Main or POP picture (see "Selecting the Audio OUT sound" on page 51).

The unauthorized recording, use, distribution, or revision of television programs, videotapes, DVDs, and other materials is prohibited under the Copyright Laws of the United States and other countries, and may subject you to civil and criminal liability.

Connecting a camcorder

This connection allows you to watch video materials recorded on a camcorder.

You will need:

- one set of A/V cables

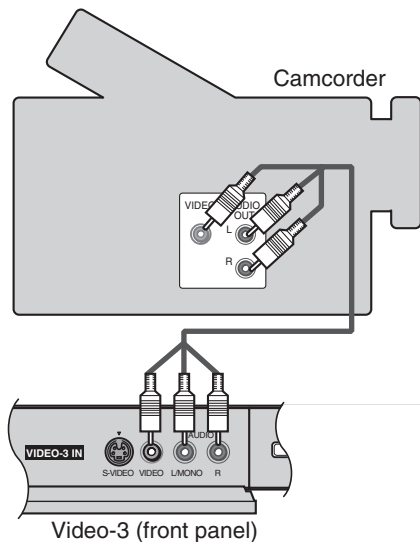

Note:

If you have a camcorder with S-video, use an S-video cable between the S-video jacks on the camcorder and TV instead of a standard video cable. Do not connect both a standard video cable and an S-video cable at the same time, or the picture performance will be unacceptable.

Connecting a device to the DVI/HDCP input

The DVI/HDCP¹ input on your TV is designed to accept HDCP program material in digital form from EIA/CEA-861-compliant² consumer electronic devices, such as a set-top box or DVD player equipped with a DVI-D digital single-link output connection.³

The DVI/HDCP input is designed for best performance with 1080i high-definition video signals. The DVI/HDCP input also will accept and display 480p and 480i picture signals.

Note: *This TV is not intended for connection to and should not be used with a PC (personal computer).*

You will need:

- one DVI-D digital single-link cable

Note: *For proper operation, the DVI-D cable length should not exceed 3m (9.8 ft). The recommended length is 2m (6.6 ft).*

- one pair of standard audio cables

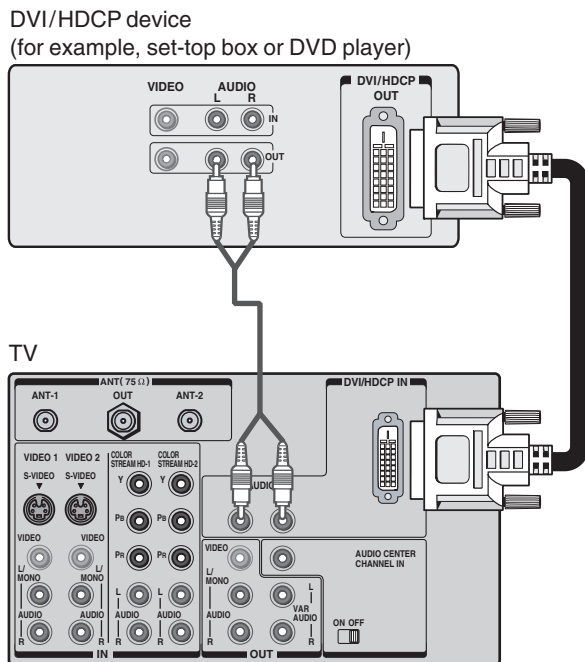

Note:

¹ DVI/HDCP = Digital Visual Interface/ High-bandwidth Digital Content Protection.

² EIA/CEA-861 compliance covers the transmission of uncompressed digital video with high-bandwidth digital content protection, which is being standardized for future reception of high-definition video signals.

³ Consult your consumer electronics dealer for availability.

Caution:

To ensure that the DVI/HDCP device is reset properly, it is recommended that you follow these procedures:

- When turning on your electronic components, **turn on the TV first**, and then the DVI/HDCP device.
- When turning off your electronic components, **turn off the DVI/HDCP device first**, and then the TV.

Connecting an audio system

This connection allows you to use an audio amplifier to adjust the audio level. This also allows you to use external speakers.

To control the audio, turn on the TV and the stereo amplifier, and turn off the built-in speakers (see “Turning off the built-in speakers” on page 51).

You will need:

- one pair of audio cables

Note:

To hear sound when using an external audio amplifier, the volume of both the TV and the amplifier must be set above 0 (zero).

For example, if the volume of the TV is set to 0, you will not be able to hear any sound, even the volume of the amplifier is at its highest level.

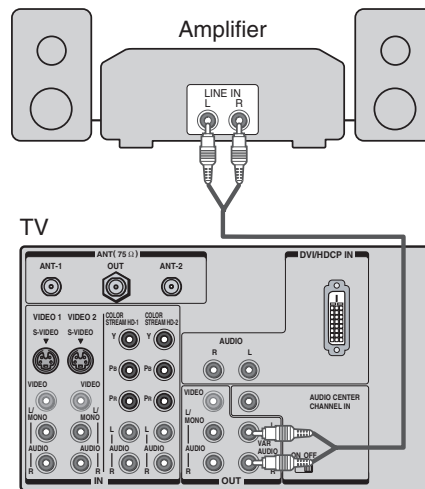

Connecting an A/V receiver

This connection allows you to use an audio/video (A/V) receiver to enhance your TV's sound.

If you have a sound system with “Dolby Surround Pro Logic”, you can add to the realism of the sound by using the TV's internal speakers as center channel speakers.

You will need:

- one set of A/V cables
- one single audio cable for the audio center channel

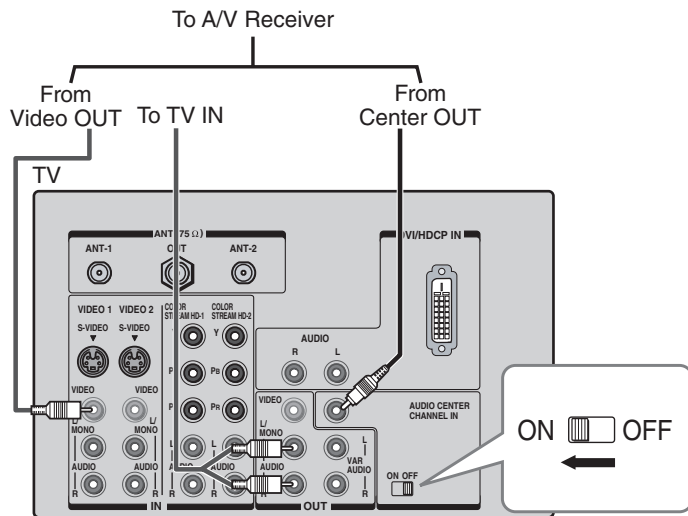

Note:

Refer to the instructions provided with your A/V receiver for details about your surround sound system.

When the Audio Center Channel ON/OFF switch is in the ON position, the TV speakers will function only as center channel speakers. At this time, the SBS feature should be set OFF. See page 50.

Adjust the volume for the center channel speakers using the center level control on the A/V receiver.

To use the TV speakers as normal speakers, set the Audio Center Channel ON/OFF switch to the OFF position.

Caution:

To avoid damaging the speakers, turn the TV off before connecting or disconnecting the Audio Center Channel audio cable.

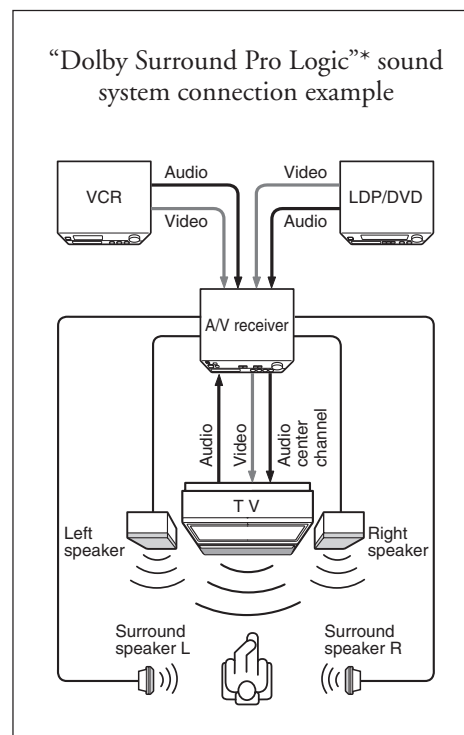

* “Dolby” and “Pro Logic” are trademarks of Dolby Laboratories.

Using the remote control

Preparing the remote control for use

Your TV remote control can operate your TV and most cable converter boxes, satellite receivers, VCRs, DVD players, and HTIBs (home theater in a box), even if they are different brands.

If you have a Toshiba device:

Your TV remote control is preprogrammed to operate most Toshiba devices. See page 18.

If you have a non-Toshiba device or a Toshiba device that the remote control is not preprogrammed to operate:

You can program the TV remote control so it will operate the other device. See pages 16–18.

Installing the remote control batteries

1. Remove the battery cover from the back of the remote control.

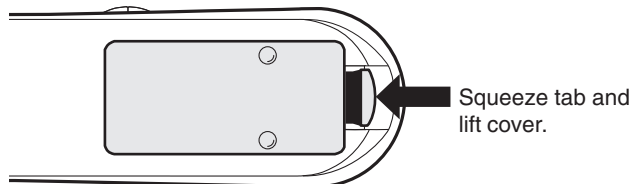

2. Install two “AA” size batteries, making sure to match the + and – signs on the batteries to the signs on the battery compartment.

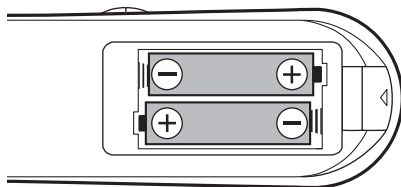

3. Reinsert the battery cover in the remote control until the tab snaps.

Caution:

- Dispose of batteries in a designated disposal area. Do not throw batteries into a fire.
- Do not mix battery types or combine used batteries with new ones.
- If the remote control does not operate correctly, or if the operating range becomes reduced, replace both batteries with new ones.
- If the batteries are dead or if you will not use the remote control for a long time, remove the batteries to prevent battery acid from leaking into the battery compartment.

Note:

If your Toshiba TV remote control does not operate all the features of your other device, use the original remote control for that device.

Programming the remote control to operate a cable converter box, satellite receiver, VCR, DVD player, or HTIB (home theater in a box)

Your Toshiba TV remote control is preprogrammed to operate most Toshiba devices. To program your TV remote control to operate a non-Toshiba device (or a Toshiba device that it is not preprogrammed to operate), follow the steps below. For details on using the remote control to operate the device, see page 18.

- In the remote control code table (below and on the next page), find the code for your device. If more than one code is listed, try each one separately until you find one that works.
- Set the Device Switch to the type of device you are programming the remote control to operate — **CBL/SAT** (for a cable converter box or satellite receiver), **VCR** (for a VCR or TV/VCR combo), or **DVD** (for a DVD player or HTIB [home theater in a box]).
- While holding down **RECALL**, press the **Channel Number** buttons to enter the 3-digit code for your device.
- To test the code, turn on the device, point the remote control at it, and press **POWER**.
 - If the correct code was entered, the device will turn off.
 - If the device does not respond, repeat steps 1 – 4 using another code.
 - If the device does not respond to another code, you will need to use the remote control that came with the device.
- Remember to set the **Device Switch** back to **TV** to control the TV.
- For future reference, write down the code(s) you used:

DEVICE	CODE	DEVICE	CODE

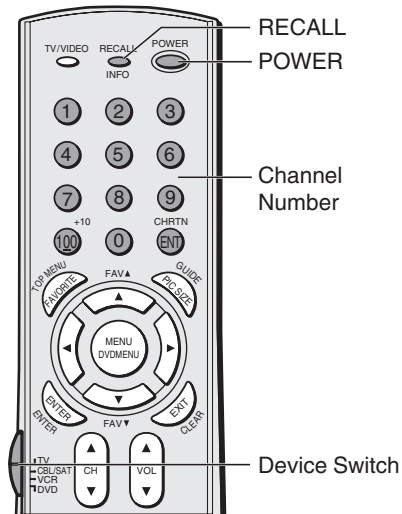

Note:

Every time you change the batteries, you will need to reprogram the remote control. Some newer VCRs respond to either of two codes. These VCRs have a switch labeled "VCR1/VCR2." If your VCR has this kind of switch and does not respond to the codes for your VCR brand, set the switch to the other position ("VCR1" or "VCR2") and reprogram the remote control.

Remote control codes

In some cases you may not be able to operate your device with the TV remote control. Your other device may use a code that is not recognized by the TV remote control. If this happens, you will need to use the remote control provided with the device.

Cable converter box				
ABC: 061, 062, 063, 082, 084, 087, 091, 092, 096, 098	Hamlin: 093	RCA: 064, 081	U. S. Electronics: 087, 096, 098	General Instruments: 010, 011, 012, 022, 023, 031, 049
Archer: 065, 092, 097, 099	Hitachi: 062, 095, 096	Realistic: 065	United Cable: 082	Hitachi: 033
Cableview: 064, 094	Jasco: 097	Recoton: 102	Universal: 065, 092, 097, 099, 102, 103	Hughes: 033
Century: 092	Jerrold: 062, 069, 071, 082, 086, 089, 091, 096	Samsung: 077, 090	Wards: 096	Hughes Network Systems: 019
Citizen: 090, 092, 097	Magnavox: 072, 096	Scientific Atlanta: 063, 078, 079, 080, 088, 098, 101, 105		Intersat: 048
Contec: 083, 085, 086, 088, 093, 098	Memorex: 091, 092, 104	Sears: 095		Janeil: 027
Diamond: 093	Multi Canal: 090	Signature: 062		JVC: 017, 057
Eagle: 091	Novavision: 101	Signature 2000: 096		Kenwood: 029
GE: 061, 062	Panasonic: 081, 083, 085	Sprucer: 081, 085		Magnavox: 060
Gemini: 069, 070, 094	Philco: 087	Starcom: 069, 082, 087, 096, 103, 104		Optimus: 058
General Instruments: 062, 089, 096	Philips: 066, 067, 068, 070, 072, 073, 074, 075, 091, 092	Stargate: 069, 090		Pansat: 036, 052
	Pioneer: 076, 077	Sylvania: 095, 100		Primestar: 015, 042
	Proscan: 061, 062	TeleView: 090		Proscan: 008, 009, 013
	Radio Shack: 092, 097, 099	Texscan: 100		Radio Shack: 022, 023, 030
		Tocom: 071, 084, 085		

Remote control codes (cont.)

Satellite receiver (cont.)

RCA: 008, 009, 013, 016
Realistic: 030
Samsung: 059
Sony: 014, 055
Star Choice: 057
Star Trak: 025, 026, 037, 054
STS: 024
Toshiba: 000, 001, 002, 003, 004, 005, 006, 007, 020, 031, 056
Uniden: 021, 028, 030, 032, 035, 039, 043, 045, 047, 058
Zenith: 027

TV/VCR Combo

Action: 078
GE: 059, 062
Goldstar: 065
Panasonic: 065
Precision: 078
Quasar: 065
Realistic: 079
Sony: 074
Toshiba: 057
Zenith: 065

DVD/VCR Combo

Go Video:
DVD=087, VCR=081
JVC:
DVD=088, VCR=082
RCA:
DVD=089, VCR=083
Samsung:
DVD=090, VCR=084
Sanyo:
DVD=091, VCR=085
Zenith:
DVD=092, VCR=086

DVD player

Aiwa: 006, 015
Apex: 016, 017
BOSE: 097
Broksonic: 018
Clarion: 019
Classic: 020
Daewoo: 021
Denon: 022, 023, 024, 025
Emerson: 026, 027
Fisher: 028
Funai: 027
GE: 001, 029, 030
Go Video: 087
GPX: 031

Hitachi: 005, 032, 033, 034, 035
JVC: 003, 007, 036, 042, 088
Kenwood: 037
Konka: 008, 009
Magnavox: 004, 038
Memorex: 039
Mintek: 040
NAD: 026
Nakamichi: 041
Norcent: 043
Onkyo: 044
Oritron: 058
Panasonic: 010, 045, 046, 047, 048, 049, 050
Philips: 004, 051
Pioneer: 052, 053, 054, 055
Proscan: 001, 056
Qwestar: 057, 058
RCA: 001, 002, 059, 089
Sampo: 060
Samsung: 061, 062, 086, 090
Sansui: 073
Sanyo: 063, 091
Sharp: 064, 067
Sherwood: 074
Sony: 011, 012, 065, 066, 068, 069, 070
Sylvania: 027
Teac: 071
Technics: 072
Techwood: 075
Toshiba: 000, 013, 076, 077, 078
Yamaha: 079, 080, 081
Zenith: 014, 082, 092

Portable DVD player

Aiwa: 093
Audiovox: 094, 095
Panasonic: 024, 096, 099
RCA: 098

VCR

Admiral: 049
Aiko: 019
Aiwa: 018
Akai: 003, 004, 037, 038, 039, 058, 069
Audiovox: 010
Bell & Howell: 007, 068
Broksonic: 008, 017
Calix: 010
Carver: 026
CCE: 019
Citizen: 009, 010, 011, 012, 013, 014, 015, 019, 057, 073

Colortype: 005
Craig: 009, 010, 016, 061, 065, 079
Curtis Mathes: 001, 005, 009, 012, 014, 040, 048, 053, 056, 057
Daewoo: 011, 013, 015, 017, 018, 019, 057, 078
Daytron: 078
Denon: 063
Dimensia: 001, 048
Electrohome: 010, 020, 065
Emerson: 003, 008, 010, 011, 017, 018, 020, 028, 039, 054, 057, 062, 065, 068, 072
Fisher: 007, 016, 021, 022, 023, 057, 064, 068, 070, 071, 079
Fuji: 004, 041
Funai: 018, 073
Garrard: 018
GE: 001, 002, 009, 040, 042, 048, 056
Go Video: 056, 059, 061, 081
Goldstar: 005, 010, 014, 054, 056, 065, 067
Gradiente: 018, 065
Harman Kardon: 005
Hitachi: 024, 025, 035, 037, 042, 063, 070, 080
JBL: 076
JC Penney: 005, 006, 007, 008, 009, 010, 023, 024, 025, 026, 035, 056, 061, 063, 065
Jensen: 024, 025, 037, 050
JVC: 005, 006, 007, 014, 037, 043, 050, 062, 063, 068, 082
Kenwood: 005, 006, 007, 012, 014, 037, 043, 050, 053, 068, 071
Kodak: 010
LG: 010
Lloyds: 053, 073, 079
Logik: 061
LXI: 010
Magnasonic: 061, 065, 078
Magnavox: 026, 027, 034, 044, 057, 061, 072
Marantz: 005, 006, 007, 012, 014, 026, 053, 067

Memorex: 007, 009, 010, 016, 018, 034, 049, 063, 065, 066, 068, 075, 079
MGA: 020, 028, 039
MGN: 056
Minolta: 024, 025, 035, 063
Mitsubishi: 020, 024, 025, 028, 039, 043, 065
Montgomery Ward: 049
Motorola: 049
MTC: 009, 046, 061
Multitech: 009, 012, 018
NEC: 005, 006, 007, 012, 014, 037, 043, 053, 054, 067, 070
Nikko: 010
Noblex: 009
Optimus: 010, 049, 065
Optonica: 031
Orion: 054, 057, 062, 065, 068, 072
Panasonic: 036, 045, 046, 057, 061, 072, 079
Pentax: 012, 024, 025, 035, 042, 053, 063
Pentex Research: 014
Philco: 026, 027, 063
Philips: 026, 031, 044, 057
Pioneer: 006, 024, 043, 055
Portland: 012, 013, 015
Proscan: 001, 002, 048
Proton: 061
Quasar: 045
Radio Shack: 010, 031, 065
Radio Shack/Realistic: 007, 009, 010, 016, 018, 020, 021, 022, 031, 049
Radix: 010
RCA: 001, 002, 003, 009, 024, 025, 029, 035, 040, 042, 045, 048, 055, 056, 063, 071, 083
Realistic: 007, 009, 010, 011, 016, 018, 020, 021, 022, 031, 049, 051, 056, 060, 065, 075, 079
Ricoh: 047
Runco: 034
Samsung: 009, 011, 038, 056, 073, 084
Sansui: 006, 037, 043, 061

Sanyo: 007, 009, 016, 054, 064, 068, 071, 075, 079, 085
Scott: 008, 011, 017, 028, 030, 057, 065, 072
Sears: 007, 010, 016, 021, 022, 023, 024, 025, 035, 053, 057, 063, 064, 065, 068, 071, 075, 079
Sharp: 013, 020, 031, 049, 051, 060, 066
Shintom: 004, 025, 032, 061
Signature: 049
Signature 2000: 075
Singer: 047, 061
Sony: 004, 032, 033, 041, 052, 058, 070, 074, 076, 077, 080
STS: 035
Sylvania: 018, 026, 027, 028, 044, 072
Symphonic: 018, 050, 051, 053, 073, 079
Tandy: 007
Tashiko: 010
Tatung: 037
Teac: 018, 029, 037
Technics: 036
Teknika: 010, 018, 065
Toshiba: 000, 011, 021, 023, 024, 028, 030, 039, 057, 074, 078, 079
Totevision: 009, 010, 065
Unitec: 073
Unitech: 009
Vector Research: 005, 006, 011, 012, 053
Video Concepts: 005, 006, 011, 012, 039, 053
Wards: 009, 010, 011, 016, 018, 020, 024, 025, 031, 035, 049, 051, 056, 057, 060, 065, 066, 079
White Westinghouse: 073
XR-1000: 018
Yamaha: 005, 006, 007, 014, 037, 053
Zenith: 004, 032, 034, 041, 047, 069, 086

HTIB

Lasonic: 083
Panasonic: 084
Venturer: 085

Using the remote control to operate a cable converter box, satellite receiver, VCR, DVD player, or HTIB (home theater in a box)

If you have a non-Toshiba device or a Toshiba device that the remote control is not preprogrammed to operate, you must first program the remote control to recognize the device (if you have not already done so). See pages 16 and 17.

To use your TV remote control to operate a:

- cable converter box or satellite receiver, set the **Device Switch** to CBL/SAT.
- VCR, set the **Device Switch** to VCR.
- DVD player or HTIB, set the **Device Switch** to DVD.

Note:

Even after the TV remote control is programmed, it may not operate certain features on your other device. If this happens and you wish to use those features, you will need to use the device's original remote control.

Point the remote control directly at the device.

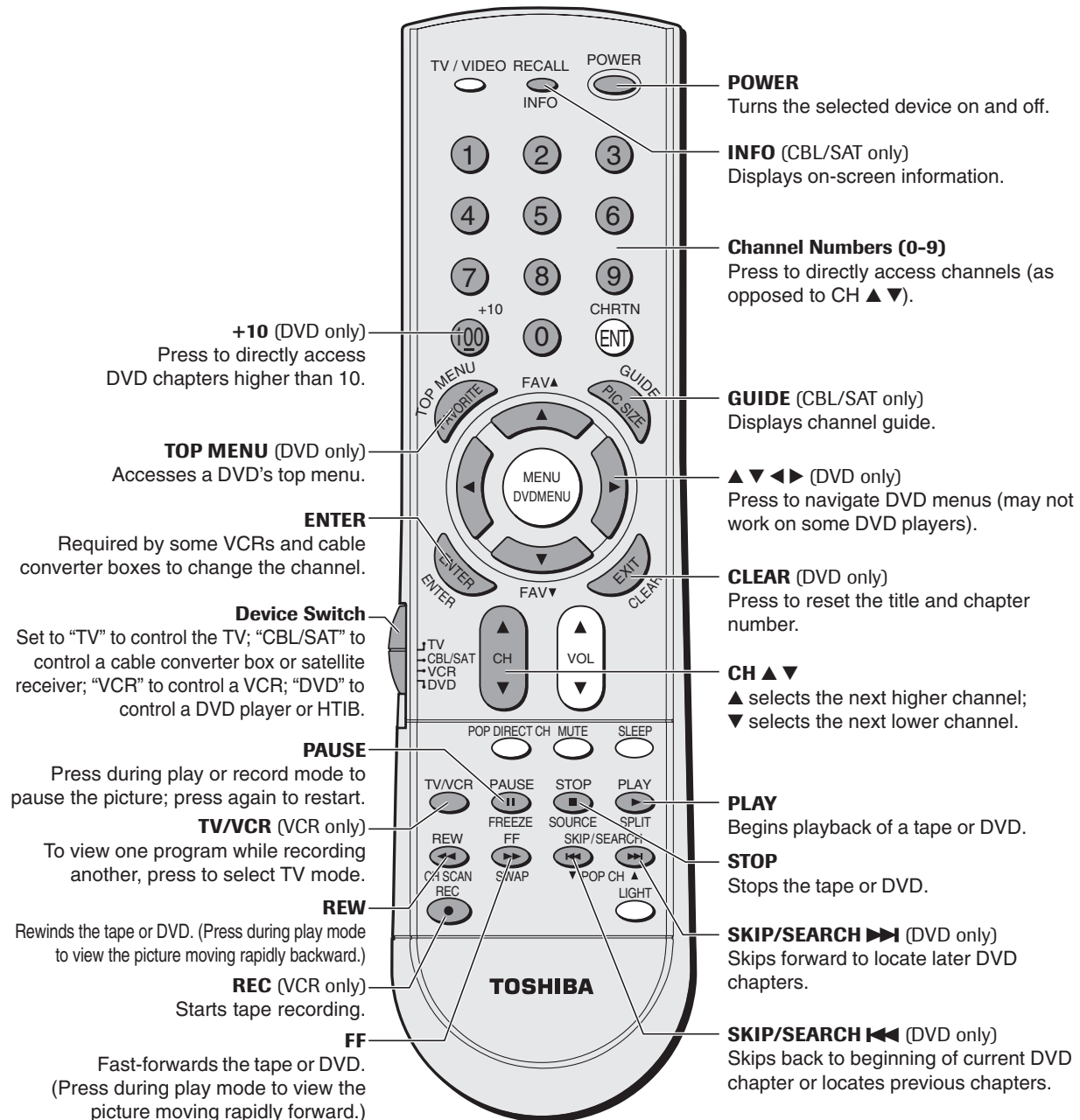

Learning about the remote control

The buttons used for operating the TV only are described here.

POWER turns the TV on and off

RECALL displays screen information (page 52)

SLEEP sets the TV to turn off at a specific time (page 46)

TV/VIDEO selects video input source (page 44)

MUTE mutes the sound (page 48)

Device Switch switches between TV, CLB/SAT, VCR, and DVD (Pages 16-18)
Set to "TV" to control the TV.

CH (channel) ▲ ▼ cycles through programmed channels (page 24)

Channel Numbers (0-9, 100) allow direct access to channels (page 24)

VOL (volume) ▲ ▼ adjusts the volume level

CH RTN returns to the memorized channel (page 25)

MENU allows access to on-screen programming menus (page 20)

ENTER sets programmed menu information (page 20)

▲ ▼ ◀ ▶ select or adjust programming menus (page 20)

POP CH ▲ ▼ selects the POP (picture-out-picture) channel (page 31)

FAV ▲ ▼ cycles through favorite channels (page 26)

FAVORITE allows access to the favorite channel search function (page 34)

PIC SIZE cycles through the three picture sizes: Normal, Compression, and Zoom (page 28)

EXIT exits programming menus (page 20)

SPLIT turns the POP feature on and off (page 31)

SOURCE selects the POP picture source (page 31)

FREEZE freezes the POP picture (page 32)

SWAP switches the main and POP pictures (page 32)

POP DIRECT CH allows direct access to POP channels (page 31)

CH SCAN allows access to the programmed channel search function (page 33)

LIGHT illuminates the keypad for five seconds

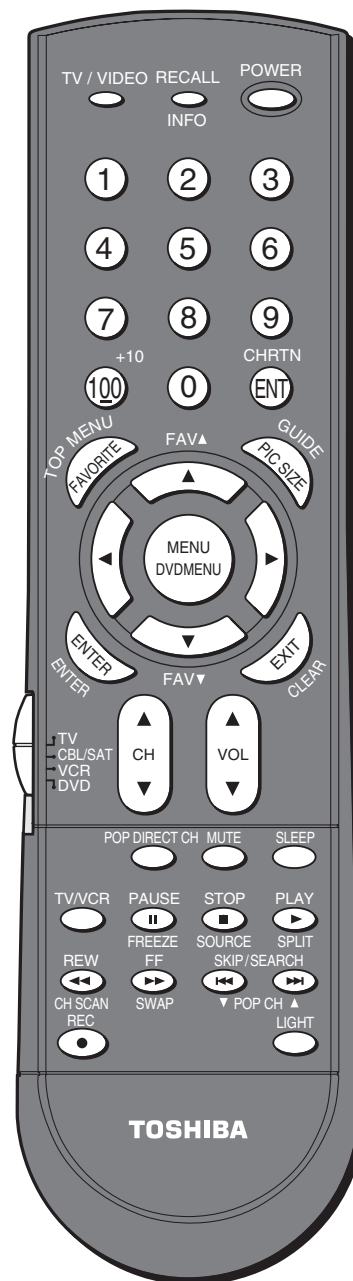

Note:

The error message "Not Available" will appear if you press a key for a function that is not available.

Setting up your TV

Learning about the menu system

After you have installed the batteries and programmed the remote control, you will need to set some preferences on the TV using the menu system. You can access the menu using the buttons on your TV or remote control.

1. Press MENU to display the menu system.
2. Press ◀ or ▶ to select menu.
3. Press ▲ or ▼ select an item.
4. Press ◀ or ▶ to select or adjust a setting.

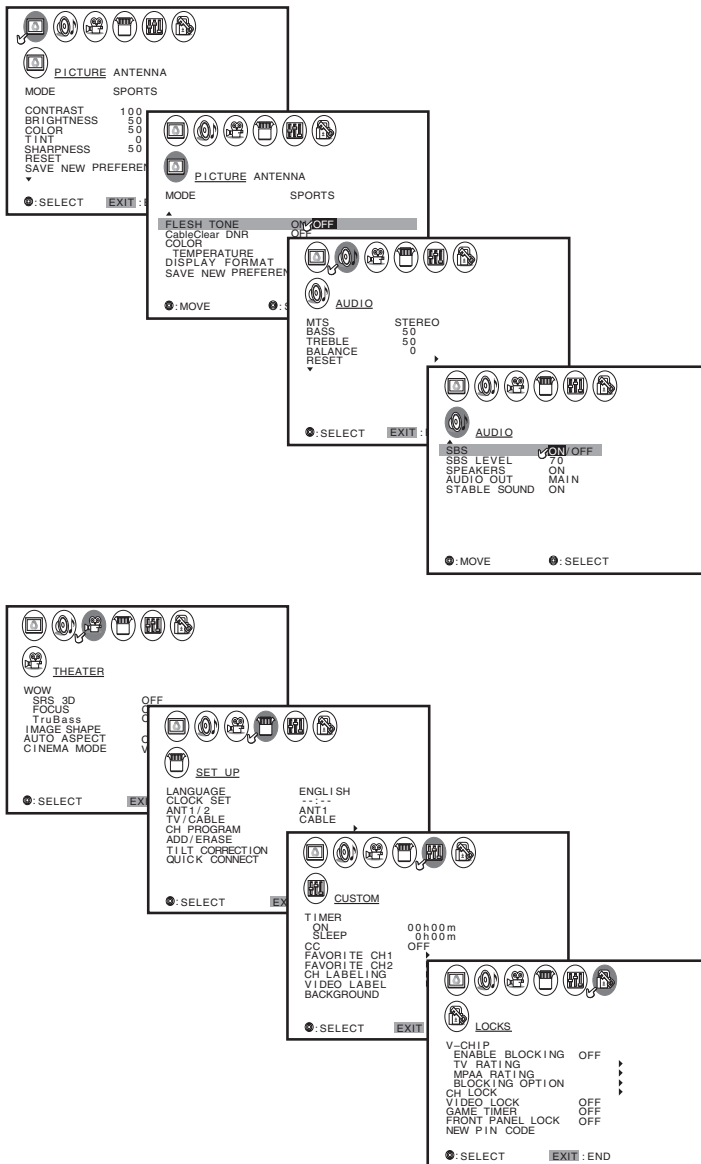

- Press ENTER to activate the function settings in the menus.
- The main menu display will disappear automatically if you do not make a selection within 15 seconds. If you want to close all the on-screen displays instantly, press EXIT.

Note regarding Quick Connect Guide

The **Quick Connect Guide** automatically appears on-screen the first time the TV is turned on. This feature provides on-screen instructions to guide you through initial setup of your TV.

To stop the **Quick Connect Guide**, either press EXIT or turn off the TV.

See page 23 for details.

TV front panel

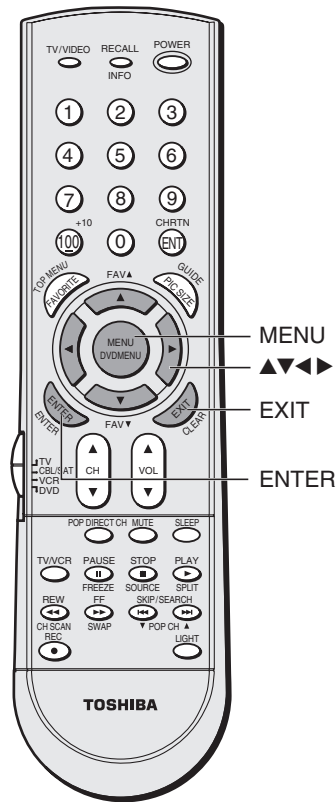
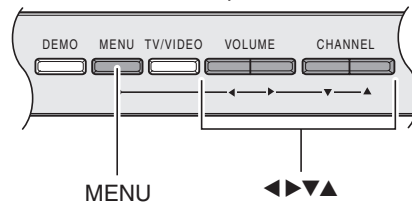

Note:

You can change the background of the menu. See page 47 for details.

Changing the on-screen display language

You can choose from three different languages (English, French and Spanish) for the on-screen display of adjustment menus and messages.

To select a language:

1. Press MENU, and then press ◀ or ▶ until the SET UP menu appears.
2. Press ▲ or ▼ to highlight LANGUAGE.

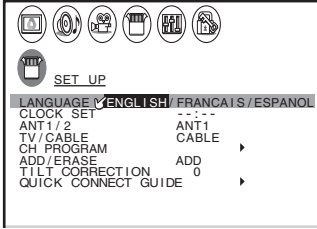

3. Press ◀ or ▶ to highlight your desired language.

Selecting the antenna input

You can connect to two different antenna input sources (ANT 1 or ANT 2).

To select the antenna input using the menu system:

1. Press MENU, and then press ◀ or ▶ to highlight the SET UP menu.
2. Press ▲ or ▼ to highlight ANT 1/2.

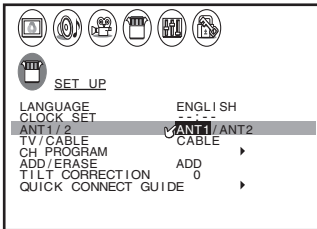

3. Press ◀ or ▶ to highlight either ANT 1 or ANT 2, depending on the antenna terminal you wish to use.

To select the antenna input using the TV/VIDEO button:

1. Press the TV/VIDEO button on the remote control or TV (see illustrations below). The current signal source displays in purple.
2. Continue pressing the TV/VIDEO button to select ANT 1 or ANT 2.

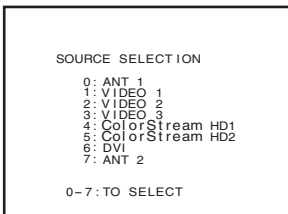

Pressing TV/VIDEO on the remote control displays the current signal source (press TV/VIDEO again or 0-7 to change)

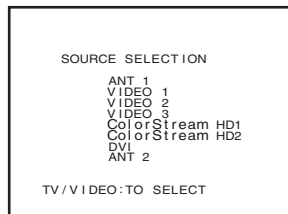

Pressing TV/VIDEO on the TV changes the current signal source

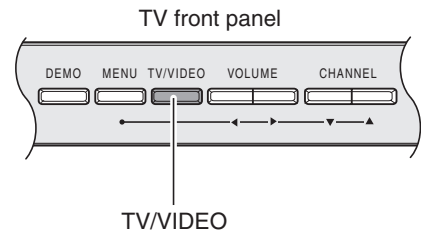
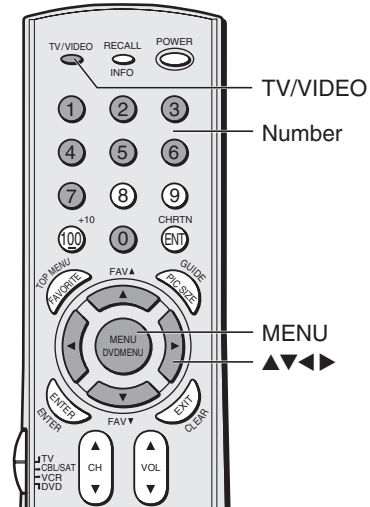
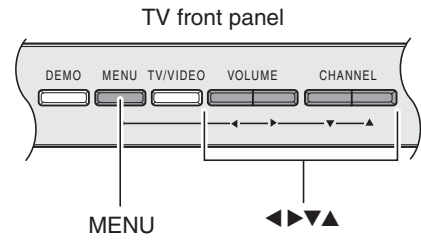

Please note the following regarding the DVI source selection:

This TV is not intended for connection to and should not be used with a PC (personal computer). See "Connecting a device to the DVI/HDCP input" on page 13 for details.

Adding channels to the TV's memory

When you press Channel ▲ or ▼, your TV will stop only on the channels stored in the TV's channel memory.

Follow the steps below and on the next page to program all active channels into the TV's memory.

Programming channels automatically

Your TV can automatically detect all active channels in your area and store them in its memory. After the channels are stored automatically, you can manually add or erase individual channels (see "Adding and erasing channels manually," below).

To program channels automatically:

1. Press MENU, and then press ◀ or ▶ until the SET UP menu appears.
2. Press ▲ or ▼ until the TV/CABLE is highlighted.
3. Press ◀ or ▶ to highlight either TV or CABLE, depending on which you use. If you use an antenna, highlight TV; if you use cable, highlight CABLE.

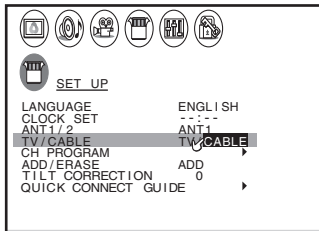

4. Press ▼ to select CH PROGRAM.

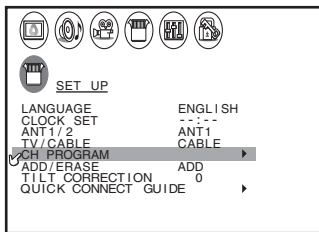

5. Press ◀ or ▶ to start channel programming. The TV will automatically cycle through all the TV or Cable channels (depending on which you selected), and store all active channels in the channel memory.

While the TV is cycling through the channels, the message "Programming Now—Please Wait" appears.

6. When channel programming is complete, the message "Completed" appears.
7. Press Channel ▲ or ▼ to view the programmed channels.

Adding and erasing channels manually

After you have programmed the channels automatically, you can manually add or erase specific channels.

To add or erase channels:

1. Select the channel you want to add or erase. If you are adding a channel, you must select the channel using the Channel Number buttons.
2. Press MENU, and then press ◀ or ▶ until the SET UP menu appears.

Note:

To tune the TV to a channel not programmed in the channel memory, you must use the Channel Number buttons on the remote control.

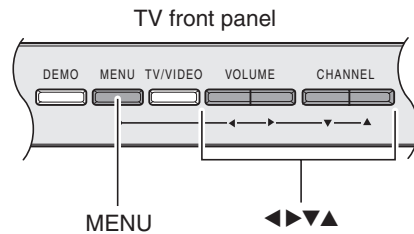
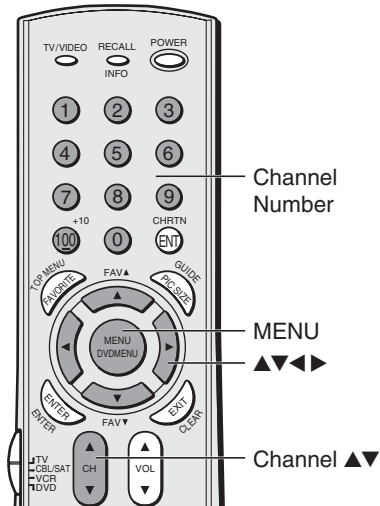

(continued on next page)

- Press ▲ or ▼ to highlight ADD/ERASE.

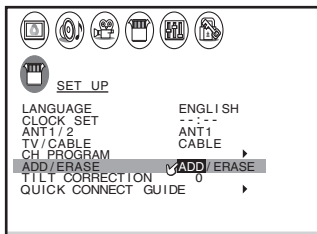

- Press ◀ or ▶ to select ADD or ERASE, depending on the function you want to perform.
- Repeat steps 1-4 for other channels you want to add or erase.

Using the Quick Connect Guide

The Quick Connect Guide automatically starts the first time the TV is turned on.

You can change the current settings any time.

- Press MENU, and then press ◀ or ▶ until the SET UP menu appears.
- Press ▲ or ▼ to highlight "QUICK CONNECT GUIDE".

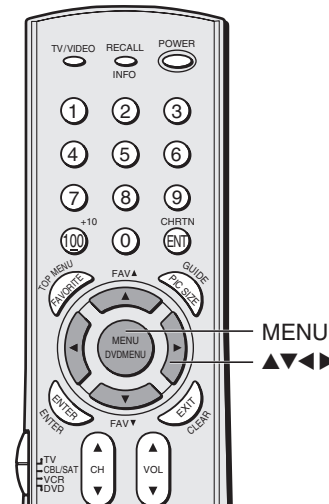
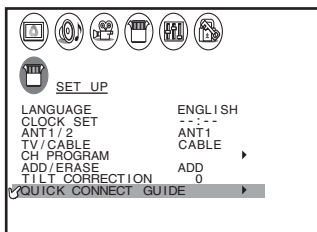

- Press ◀ or ▶ to enter the Quick Connect Guide mode. Advance the setup according to the guide displayed on the screen. You can set up the following items.

Note:

To stop the Quick Connect Guide, press EXIT or turn off the TV.

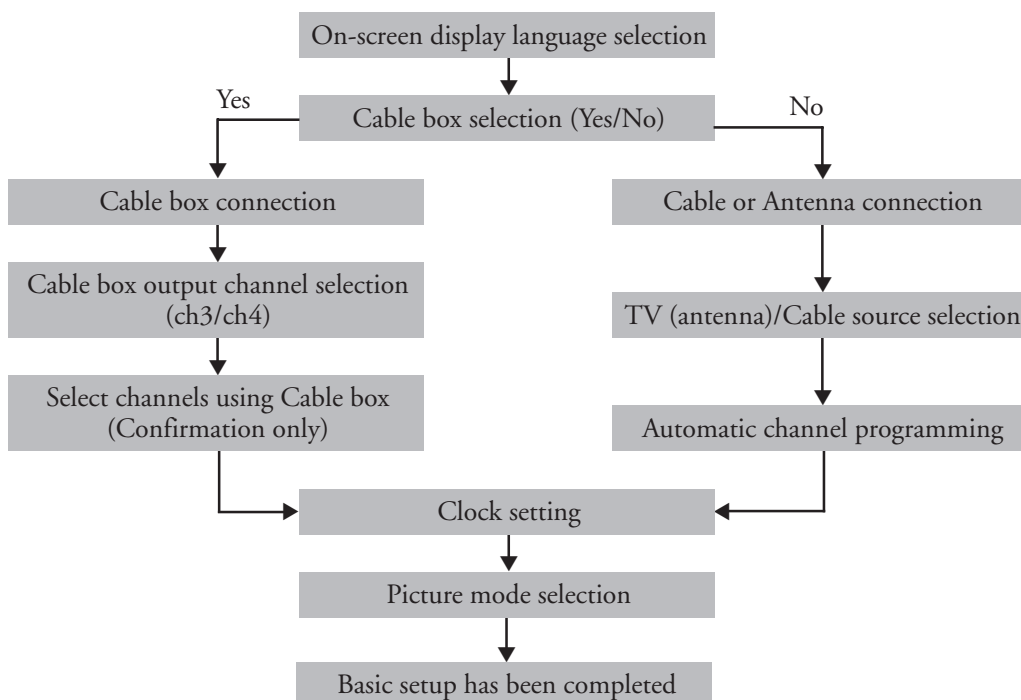

Changing channels

To change to a specific channel (programmed or unprogrammed):

Press the Channel Number buttons (0–9 and 100).

For channels 100 and higher, press the 100 button, and then the next two numbers. For example, to select channel 125, press 100, 2, 5.

To change to the next programmed channel:

Press Channel ▲ or ▼ on the TV or remote control.

Changing channels using SpeedSurf

To use SpeedSurf to change to a specific programmed channel:

1. Press and hold Channel ▲ or ▼ for about one second. The TV will enter the SpeedSurf mode.

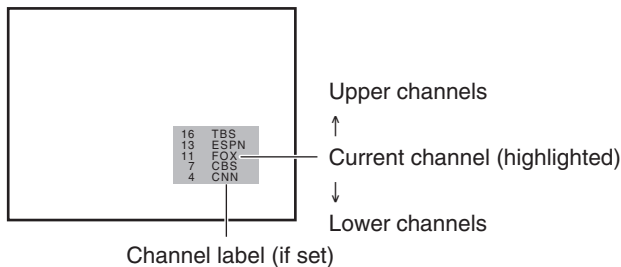

2. Repeatedly press or hold Channel ▲ or ▼ while the SpeedSurf mode is on-screen to scroll the channel list. Release the button to display the highlighted channel.

Adjusting the tilt correction feature

When you install the TV or change the direction of the TV, the picture may suffer from color shading and/or tilt of the picture by the terrestrial magnetism. If so, the following adjustment should be made for the best possible picture.

To adjust the tilt correction:

1. Press MENU, then press ◀ or ▶ until the SET UP menu appears.
2. Press ▲ or ▼ to highlight TILT CORRECTION.
3. Press ◀ or ▶ to correct any tilt of the picture between +10 and -10.

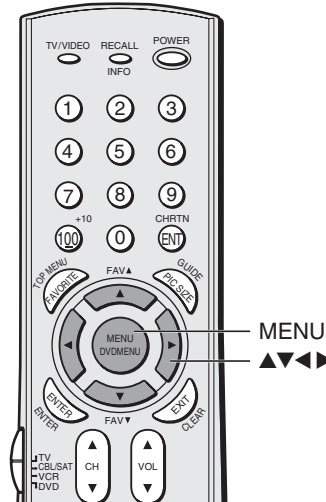
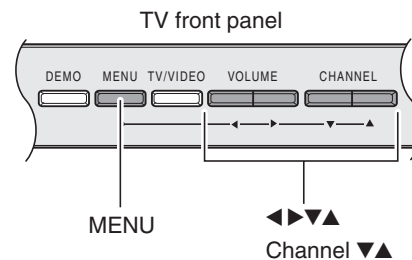
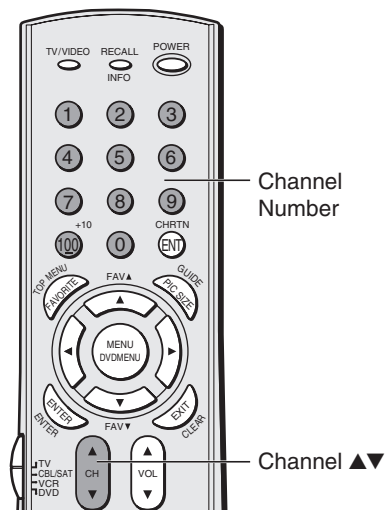
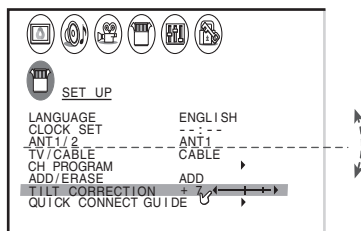

Using the TV's features

Adjusting the channel settings

Switching between two channels using Channel Return

The Channel Return feature allows you to switch between two channels without entering an actual channel number each time.

1. Select the first channel (or video mode) you want to view.
2. Select a second channel using the Channel Number buttons (0-9, 100).
3. Press CH RTN. The previous channel will display.

Each time you press CH RTN, the TV will switch back and forth between the last two channels that were selected.

Switching between two channels using SurfLock™

The SurfLock™ feature temporarily “memorizes” one channel in the CH RTN button, so you can return to that channel quickly from any other channel by pressing CH RTN.

To memorize a channel in the CH RTN button:

1. Select the channel you want to program into the CH RTN button.
2. Press and hold CH RTN for about 2 seconds until the message “Channel Memorized” appears (flashing) on the screen. The channel has been programmed into the CH RTN button.
3. Continue to change channels until your desired channel is selected.
4. Press CH RTN. The memorized channel will be selected.

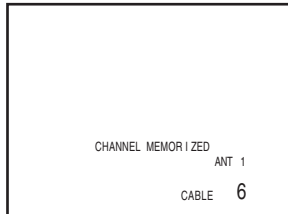

The TV will return to the memorized channel one time only. Once you press CH RTN and then change channels again, the CH RTN button memory will be cleared and the button will function as Channel Return, by switching back and forth between the last two channels that were selected.

Programming your favorite channels

You can preset up to 7 of your favorite channels each for FAVORITE CH1 and FAVORITE CH2 modes using the Favorite Channel Programming feature. Because this feature scans through only your favorite channels, it allows you to skip other channels you do not normally watch.

To program your favorite channels:

1. Press MENU, and then press ◀ or ▶ until the CUSTOM menu appears.
2. Press ▲ or ▼ to highlight FAVORITE CH1 or FAVORITE CH2.

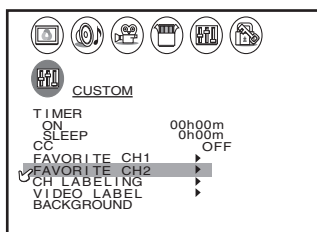
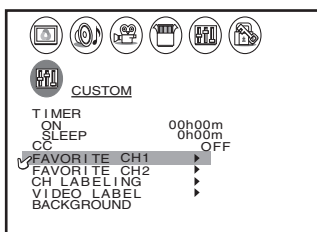

(continued on next page)

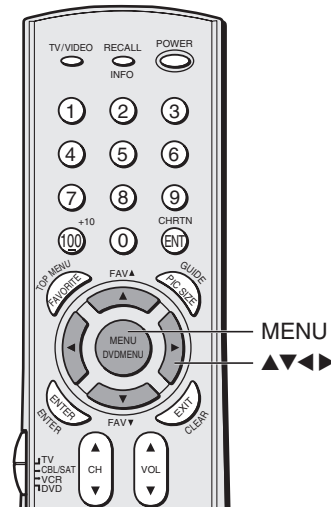
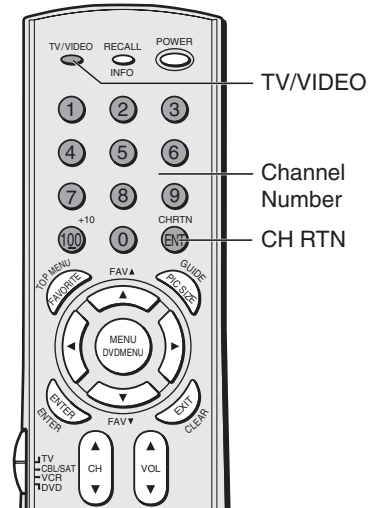

- Press ◀ or ▶ to display the FAVORITE CH1 menu, for example. CH INPUT will be highlighted.

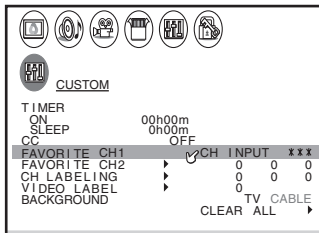

- Press the Channel Number buttons to enter one of your favorite channels.
- Press ENTER.
- Repeat steps 4 and 5 for other channels.

To select your favorite channels:

Press FAV ▲ or ▼.

To quickly scan through your favorite channels in a seven-picture multi-window:

Press FAVORITE (see page 34).

To clear a favorite channel:

- Press MENU, and then press ◀ or ▶ until the CUSTOM menu appears.
- Press ▲ or ▼ to highlight FAVORITE CH2, for example.
- Press ◀ or ▶ to display the FAVORITE CH2 menu.

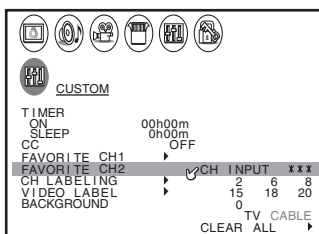

- Press ▲▼◀▶ to highlight the channel you want to clear, then press ENTER.

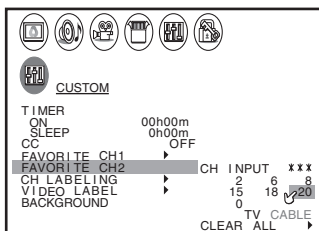

- Repeat step 4 for other channels.

To clear all favorite channels at once:

Press ▲ or ▼ to highlight CLEAR ALL in step 4 above, and then press ◀ or ▶ to clear all favorite channels at once.

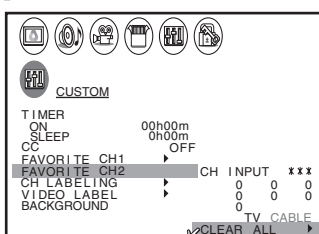

Note:

- The FAV ▲▼ buttons operate as MENU ▲▼ buttons when a menu is on-screen.
- The favorite channel feature is not available in ANT2 mode.

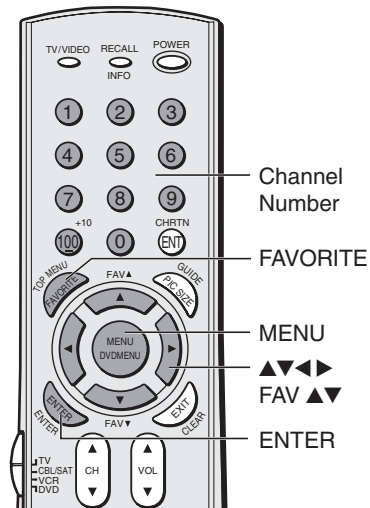

Labeling channels

Channel labels appear above the on-screen channel number display each time you turn on the TV, change a channel, or press RECALL. You can choose any four characters to identify a channel.

To create channel labels:

1. Press MENU, and then press ◀ or ▶ until the CUSTOM menu appears.
2. Press ▲ or ▼ to highlight CH LABELING.
3. Press ◀ or ▶ to display the CH LABELING menu. CH INPUT will be highlighted.

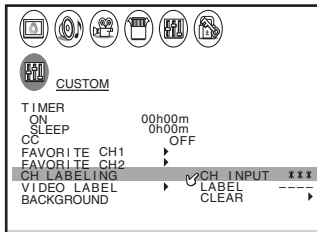

4. Press the Channel Number buttons to select a channel you want to label.

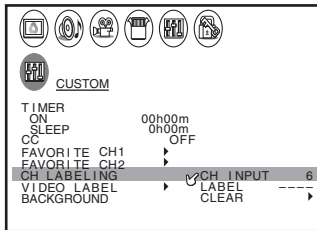

5. Press ▼ to highlight LABEL.
6. Press ◀ or ▶ repeatedly to select a character for the first space, and then press ENTER.

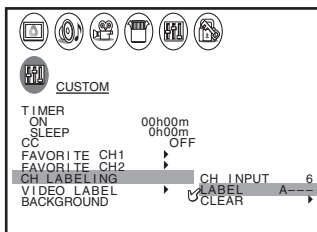

7. Repeat step 6 to enter the rest of the characters.
If you would like a blank space in the label name, you must choose an empty space from the list of characters. Otherwise, a dash “-” will appear in that space.
8. Repeat steps 4–7 for other channels. You can assign labels to a maximum of 32 channels.

To erase channel labels:

1. Press MENU, and then press ◀ or ▶ until the CUSTOM menu appears.
2. Press ▲ or ▼ to highlight CH LABELING.
3. Press ◀ or ▶ to display the CH LABELING menu.
4. Select the channel you want to clear with the Channel Number buttons.

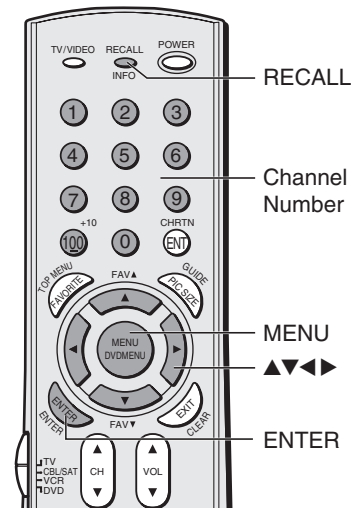

(continued on next page)

5. Press ▼ to highlight CLEAR.

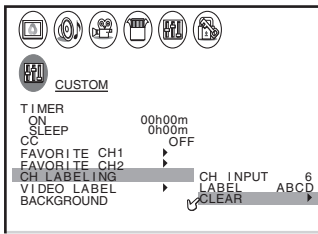

6. Press ◀ or ▶ to erase the channel label.

7. Repeat steps 4–6 to erase other channel labels.

Viewing the wide-screen picture formats

You can view programs that have the conventional TV picture format (4:3 aspect ratio) and the wide-screen format (16:9 aspect ratio). This feature is available for TV or DVD video signals input from the VIDEO 1-3, ColorStream HD1, HD2 and DVI jacks.

Selecting the image shape

1. Make sure the VIDEO 1-3, ColorStream HD1, HD2 or DVI mode is selected. (See page 44 for details.)
2. Press PIC SIZE repeatedly to select either Normal, Compression, or Zoom image shape, as described below.

- 480i/480p signal source/VIDEO 1-3:
 → NORMAL → COMPRESSION → ZOOM →
- 1080i/720p signal source:
 → NORMAL → COMPRESSION →

Note: The message "Not Available" will appear when the PIC SIZE button is pressed in the TV mode.

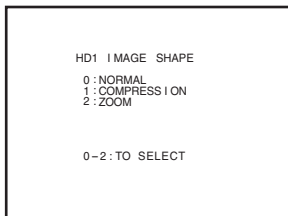

While the above menu is on-screen, select the desired picture size by pressing the corresponding number button (0–2).

Normal mode

The Normal picture size displays the picture in the conventional 4:3 aspect ratio. A wide (16:9) picture signal is stretched vertically to fill the screen.

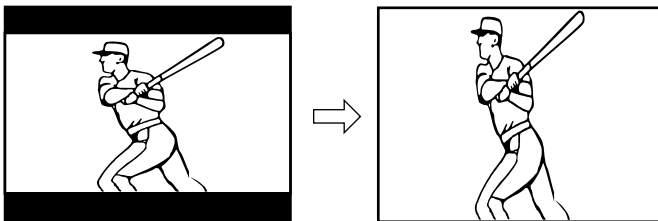

Wide (16:9) signal

Normal mode

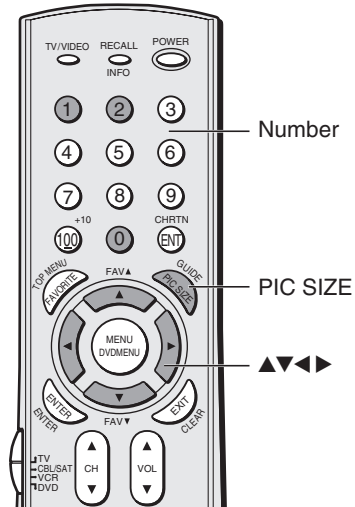

NOTICE OF POSSIBLE ADVERSE EFFECTS ON TV PICTURE TUBE

Avoid displaying stationary images on your TV screen for extended periods of time. Fixed (non-moving) images (such as still PIP/POP windows or black/gray bars in wide-screen picture or PIP/POP formats) can become permanently engrained in the picture tube. **This type of damage is NOT COVERED BY YOUR WARRANTY** because it is the result of misuse. See item 33 on page 4.

Compression

- The picture is vertically compressed, with black bars at the top and bottom.
- The exact image is reproduced and the picture quality is better because of more effective use of scanning lines.

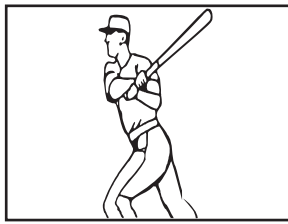

Squeezed signal

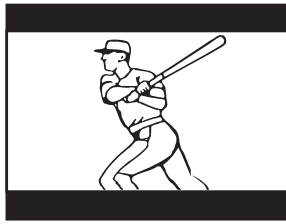

Compression mode

Zoom

A picture is expanded by 1.33 times.

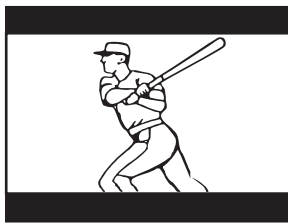

Wide (16:9) signal

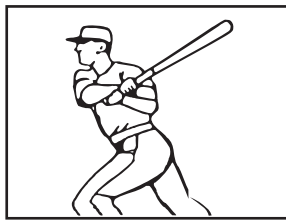

Zoom mode

Note:

You can also change the image shape using the menu system. Select **IMAGE SHAPE** in the **THEATER** menu.

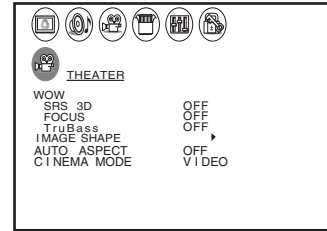

NOTICE OF POSSIBLE ADVERSE EFFECTS ON TV PICTURE TUBE

Avoid displaying stationary images on your TV screen for extended periods of time. Fixed (non-moving) images (such as still PIP/POP windows or black/gray bars in wide-screen picture or PIP/POP formats) can become permanently engrained in the picture tube. **This type of damage is NOT COVERED BY YOUR WARRANTY** because it is the result of misuse. See item 33 on page 4.

Using the auto aspect feature

When receiving 480i signal, the TV will automatically change the image shape by reading aspect information (ID-1 data) from the input signal. If the signal does not include aspect information (ID-1 data), the image shape mode you set is selected.

To turn on the auto aspect:

1. Press MENU, and then press ◀ or ▶ until the THEATER menu appears.

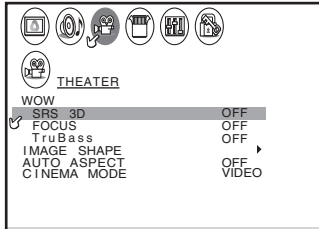

2. Press ▲ or ▼ to highlight AUTO ASPECT, and then press ◀ or ▶ to select ON.

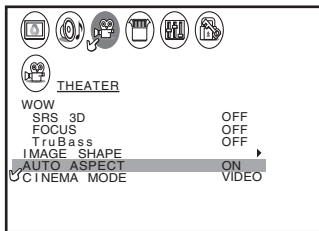

Aspect information (ID-1 data)	Image shape to be selected
4:3 Normal	Normal
16:9 Full	Compression
4:3 Letter box	Normal
Not Defined	User-set mode

Selecting the cinema mode

When you view a DVD movie (3-2 pulldown processed) from a DVD player connected to the ColorStream (component video) or DVI/HDCP inputs on the TV, smoother and more natural motion can be obtained by setting the CINEMA MODE to FILM (auto).

To set the CINEMA MODE to FILM (auto):

1. Press MENU, and then press ◀ or ▶ until the THEATER menu appears.
2. Press ▲ or ▼ to highlight CINEMA MODE.
3. Press ◀ or ▶ to select FILM (auto).

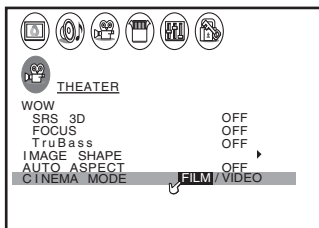

To set the CINEMA MODE to VIDEO (off):

Press ◀ or ▶ to select VIDEO in step 3 above.

Note:

- This feature does not operate for the antenna (cable) and DVI input sources.
- The image shape selection is possible even when the auto aspect is active (ON). In this case, the image shape you selected is valid until the input source is changed or auto aspect is turned ON again.
- If the signal includes incorrect aspect information (ID-1 data), the picture will deteriorate and auto aspect may not operate correctly. In such a case, turn OFF the auto aspect.

NOTICE OF POSSIBLE ADVERSE EFFECTS ON TV PICTURE TUBE

Avoid displaying stationary images on your TV screen for extended periods of time. Fixed (non-moving) images (such as still PIP/POP windows or black/gray bars in wide-screen picture or PIP/POP formats) can become permanently engrained in the picture tube. **This type of damage is NOT COVERED BY YOUR WARRANTY** because it is the result of misuse. See item 33 on page 4.

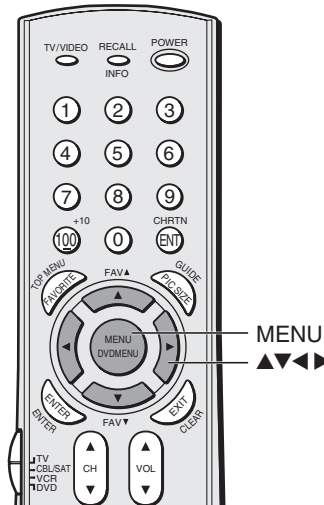

Using the POP double-window feature

The POP (picture-out-picture) feature splits the screen into a double window that allows you to watch two programs at the same time. The POP program can come from a TV broadcast or an external source, such as a VCR.

To display a TV broadcast in the POP window:

1. Press SPLIT to display the POP window.

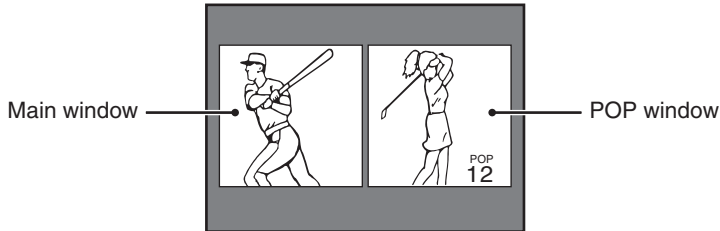

2. Select channels of the POP window in the following two ways:
 - To change to a specific channels, press POP DIRECT CH. While "POP" is on the screen, press the Channel Number buttons (0-9 and 100).
 - To change the next programmed channels, press POP CH ▼▲.

If the V-CHIP feature is active and you try to watch a TV program that exceeds your set rating limits, the program will be blocked (see "Using the V-CHIP menu" on page 36).

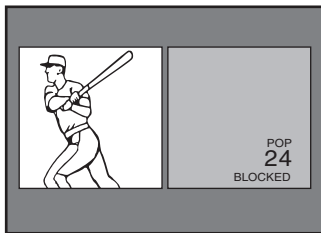

To display a picture from an external source in the POP window:

1. Connect the external source equipment (see "Connecting your TV" on page 7).
2. Select the TV program you want to watch in the main window.
3. Press SPLIT to display the POP window.
4. Repeatedly press SOURCE to select the input source for the POP window (VIDEO 1, VIDEO 2, VIDEO 3, ColorStream HD1, or ColorStream HD2 only; you cannot select DVI in POP mode). The current source will display in purple.
5. You can play a tape as the POP picture, or select a channel for the POP window using the VCR's channel keys.

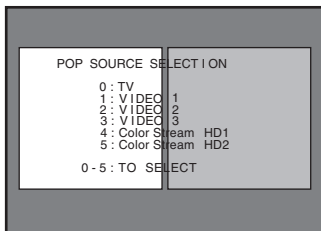

While the above menu is on the screen, you can select the desired signal input source by pressing the corresponding number button (0-5).

To close the POP window:

Press SPLIT again or EXIT.

Note:

- The SPLIT buttons on the remote control operate the TV's POP features.
- You cannot access POP features when viewing DVI input.
- You cannot display the ANT-2 signal source in the POP window.
- You can choose to hear the sound of either the main or POP program (see "Selecting the Audio OUT sound" on page 51).

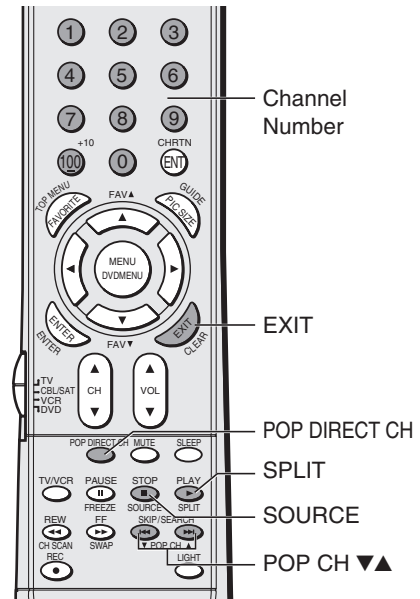

NOTICE OF POSSIBLE ADVERSE EFFECTS ON TV PICTURE TUBE

Avoid displaying stationary images on your TV screen for extended periods of time. Fixed (non-moving) images (such as still PIP/POP windows or black/gray bars in wide-screen picture or PIP/POP formats) can become permanently engrained in the picture tube. **This type of damage is NOT COVERED BY YOUR WARRANTY** because it is the result of misuse. See item 33 on page 4.

Switching the main and POP pictures

Press SWAP while you are using the POP feature to switch the main and POP pictures.

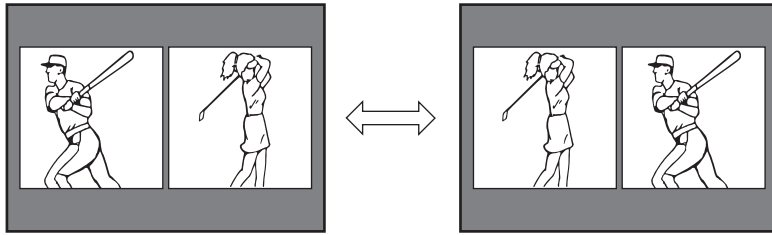

Freezing the POP picture

1. Press FREEZE while the POP is not on the screen. The POP window will appear with a still picture.
2. Press FREEZE again to renew the still picture.

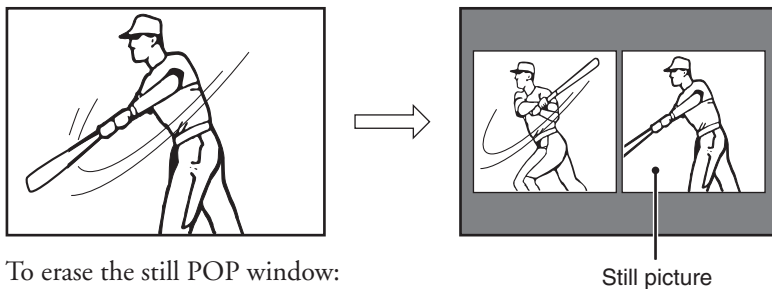

To erase the still POP window:
Press EXIT.

Adjusting the size of the double-window

When the input signals of the main and POP pictures are 480i, you can adjust the size of each window. Continuously pressing ◀ or ▶ changes the size in 9 steps.

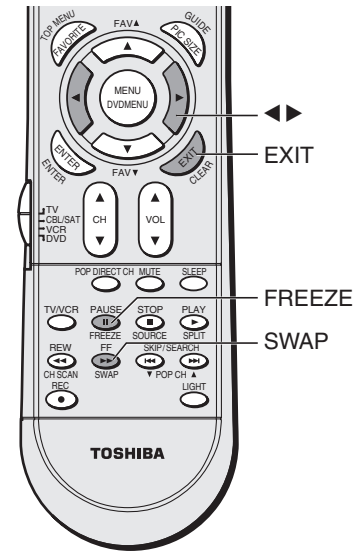
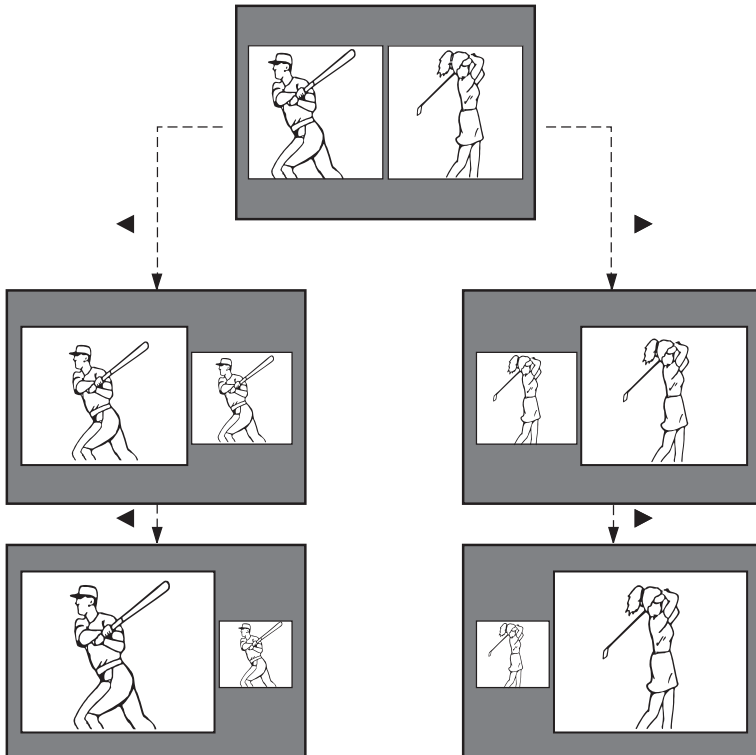

Note:

If the signal format other than 480i is received, this feature is not available. "Not available" will appear on the screen.

NOTICE OF POSSIBLE ADVERSE EFFECTS ON TV PICTURE TUBE

Avoid displaying stationary images on your TV screen for extended periods of time. Fixed (non-moving) images (such as still PIP/POP windows or black/gray bars in wide-screen picture or PIP/POP formats) can become permanently engrained in the picture tube. **This type of damage is NOT COVERED BY YOUR WARRANTY** because it is the result of misuse. See item 33 on page 4.

Double-Window with keeping aspect ratio

The Double-Window displays the pictures with various aspect ratio according to the input signal format.



Using the programmed channel search function

You can use the programmed channel search function to quickly scan your programmed channels (see “Adding channels to TV’s memory ” on page 22).

1. Press CH SCAN.
The TV automatically enters POP mode, and begins a seven-picture scan of your programmed channels in the POP window.

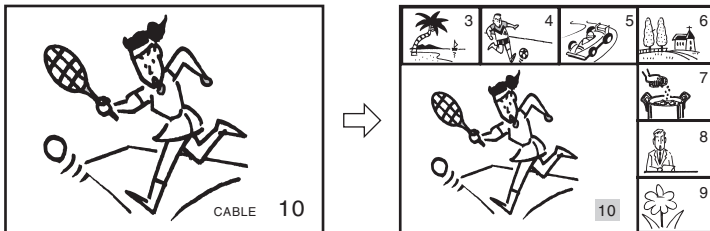

2. Press ▲▼◀▶ to select one of the seven pictures (becomes a moving picture). The main picture is an always moving picture.
3. Press ENTER to display the channel you selected in step 2 as a normal picture.

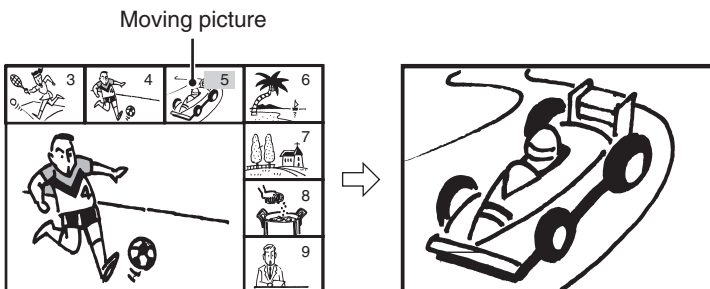

Note:

The auto aspect feature does not operate in the Double-Window mode.

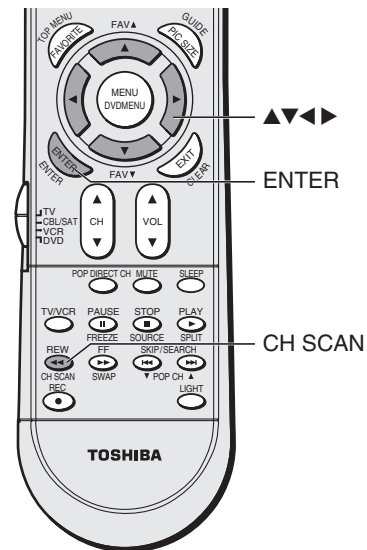

Note:

This feature does not operate in the DVI mode.

NOTICE OF POSSIBLE ADVERSE EFFECTS ON TV PICTURE TUBE

Avoid displaying stationary images on your TV screen for extended periods of time. Fixed (non-moving) images (such as still PIP/POP windows or black/gray bars in wide-screen picture or PIP/POP formats) can become permanently engrained in the picture tube. **This type of damage is NOT COVERED BY YOUR WARRANTY** because it is the result of misuse. See item 33 on page 4.

Using the favorite channel search function

You can use the favorite channel search function to quickly scan your favorite channels (see “Programming your favorite channels” on page 25).

1. Press FAVORITE.
The TV automatically enters POP mode, and begins a seven-picture scan of your favorite channels in the POP window.

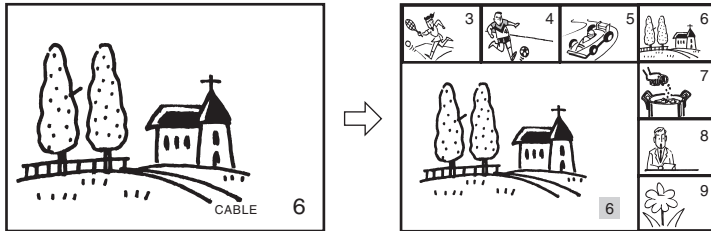

2. Press ▲▼◀▶ to select one of the seven pictures (becomes a moving picture). The main picture is an always moving picture.
3. Press ENTER to display the channel you selected in step 2 as a normal picture.

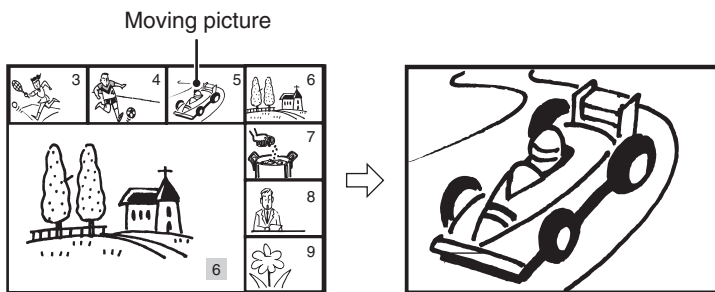

Every time you press FAVORITE, the POP window scans your favorite channels in the following order:

FAVORITE CH1 — FAVORITE CH2 — Off

About the auto favorite feature

If your TV is in the program lock mode, after 4 seconds, the TV starts the auto favorite channel search function. See page 38 for details.

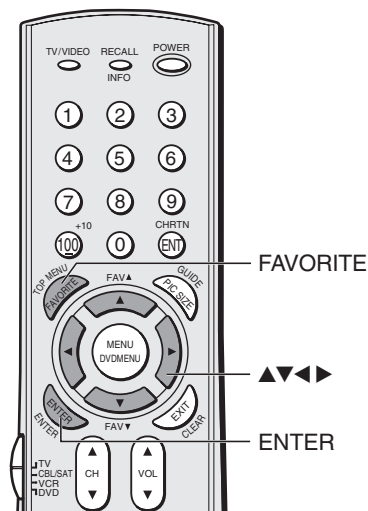
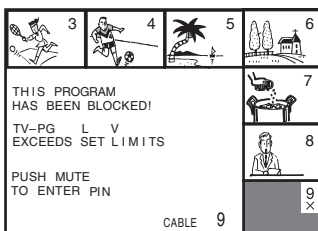

Note:

This feature does not operate in the DVI mode.

NOTICE OF POSSIBLE ADVERSE EFFECTS ON TV PICTURE TUBE

Avoid displaying stationary images on your TV screen for extended periods of time. Fixed (non-moving) images (such as still PIP/POP windows or black/gray bars in wide-screen picture or PIP/POP formats) can become permanently engrained in the picture tube. **This type of damage is NOT COVERED BY YOUR WARRANTY** because it is the result of misuse. See item 33 on page 4.

Using the LOCKS menu

The LOCKS menu includes the V-Chip, CH Lock, Video Lock, and New PIN Code functions. You can use these functions after entering the correct PIN code.

Entering the PIN code

1. Press MENU, and then press ◀ or ▶ until the LOCKS menu appears.

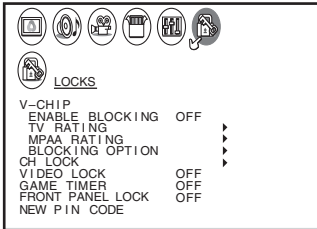

2. Press ▲ or ▼ to display the PIN code entering mode.

- Blocking Reset status: Set your 4-digit code by pressing the Number buttons (0-9), and then press ENTER.
- When the PIN code is already stored: Press the Number buttons (0-9) to enter the 4-digit PIN code used for blocking channels, and then press ENTER.



If the wrong PIN code is entered, the message “Incorrect” appears. Enter the code again, and then press ENTER.

If you cannot remember your PIN code

While the PIN code entering screen is displayed, press RECALL four times within five seconds. The PIN code will be released (Blocking Reset status restored).

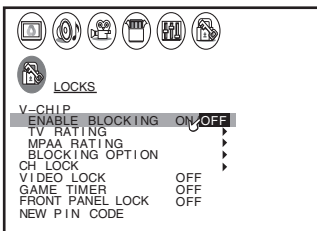

Continue to set each item following the steps on the next page.

Note:

The V-Chip function is available only for the U.S. V-Chip system. The Canadian V-Chip system is not supported.

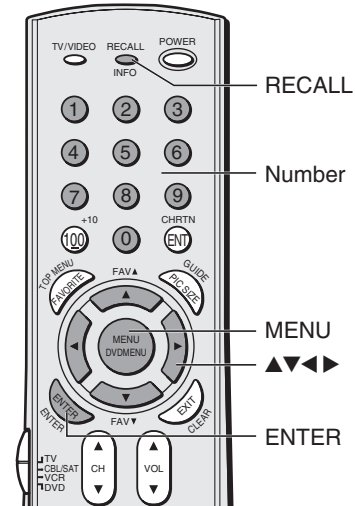

Using the V-CHIP menu

Some TV programs and movies include signals that classify the content of the program (violence, sex, dialog, language). The V-CHIP control feature in this TV detects the signals and blocks the programs according to your selections. To use this feature, perform the following setup.

ENABLE BLOCKING

1. From the LOCKS menu, select ENABLE BLOCKING.
2. Press ◀ or ▶ to select ON or OFF.
ON : To enable your setting (Lock)
OFF: To release your setting (Unlock)

Note: The CH LOCK function is not affected with this selection.

TV RATING (Independent rating system for broadcasters)

1. From the LOCKS menu, select TV RATING.
2. Press ◀ or ▶ to display the TV RATING menu.
3. Press ▼ or ▲ to select item.
4. Press ▶ to lock (display "X")
Press ◀ to unlock (display "✓")
5. Repeat steps 3 and 4 to set the next item.

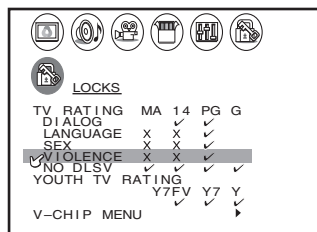

The TV age-based ratings and content themes you can be lock are listed in the table below.

Ratings	Description and Content themes
MA	Mature Audience Only (This program is specifically designed to be viewed by adults and therefore may be unsuitable for children under 17.) L) Crude or indecent language S) Explicit sexual activity V) Graphic violence
14	Parents Strongly Cautioned (This program contains some material that many parents would find unsuitable for children under 14 years of age.) D) Intensely suggestive dialog L) Strong, coarse language S) Intense sexual situations V) Intense violence
PG	Parental Guidances Suggested (This program contains material that parents may find unsuitable for younger children.) D) Some suggestive dialog L) Infrequent coarse language S) Some sexual situations V) Moderate violence
G	General Audience (Most parents would find this program suitable for all ages.)
Y7, Y7FV	Directed to Older Children (This program is designed for children age 7 and above. Note: Programs in which fantasy violence may be more intense or more combative than other programs in this category are designated Y7FV.)
Y	All Children (This program is designed to be appropriate for all children.)

Note:

The V-Chip function is available only for the U.S. V-Chip system. The Canadian V-Chip system is not supported.

LOCKS menu

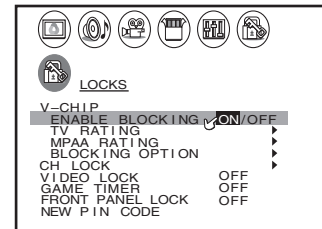

To select each item:

Press ▼ or ▲.

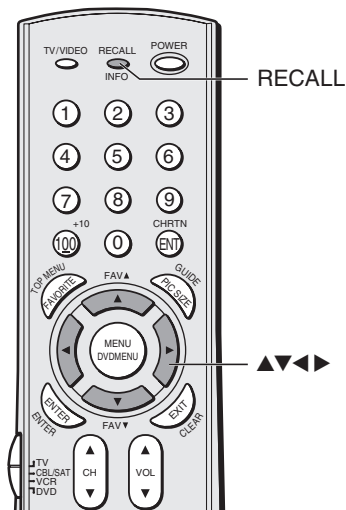

Press RECALL to display the rating of the TV program you are currently watching.

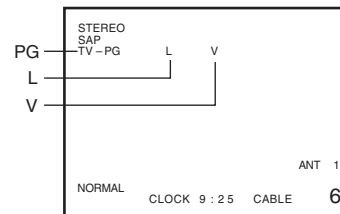

MPAA RATING (Independent rating system for movies)

1. From the LOCKS menu, select MPAA RATING.
2. Press ◀ or ▶ to display the MPAA RATING menu, then press ▼ or ▲ to highlight MPAA RATING.

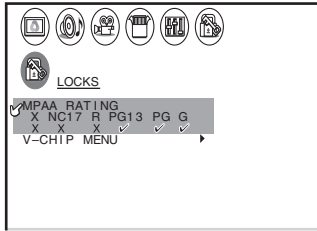

3. Press ▶ to lock ("X") or press ◀ to unlock ("✓").

The movie ratings you can lock are described as follows:

- X : X-rated (For adults only)
- NC17: Not intended for anyone 17 and under
- R : Restricted (Under 17 requires accompanying parent or adult guardian.)
- PG13 : Parents Strongly Cautioned (Some material may be inappropriate for children under 13)
- PG : Parental Guidance Suggested (Some material may not be suitable for children)
- G : General Audience (Appropriate for all ages)

BLOCKING OPTION

1. From the LOCKS menu, select BLOCKING OPTION.
2. Press ◀ or ▶ to display the BLOCKING OPTION menu, then press ▲ or ▼ to select item.

MPAA UNRATED:

Press ◀ or ▶ to select ON (Lock) or OFF (Unlock) for unrated programs in the MPAA rating system.

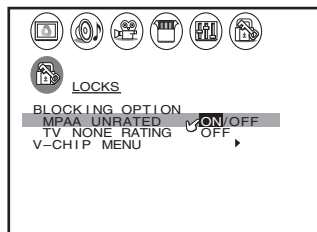
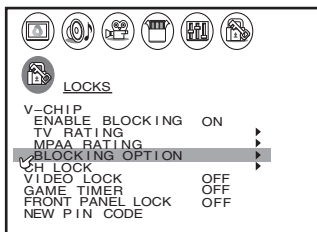

TV NONE RATING

Press ◀ or ▶ to select ON (Lock) or OFF (Unlock) for programs rated NONE in the TV PARENTAL GUIDELINES.

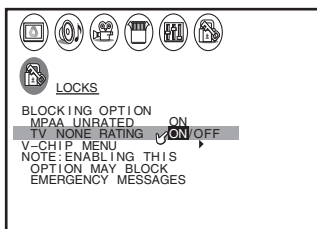

V-CHIP MENU:

Press ◀ or ▶ to return to the LOCKS menu.

LOCKS menu

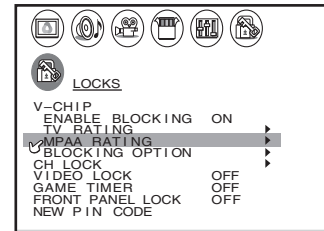

To select each item:

Press ▼ or ▲.

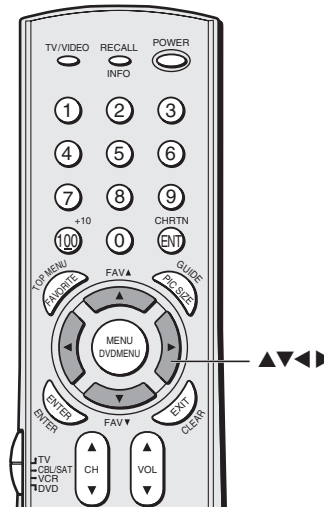

Caution

Be aware that setting the TV None Rating to ON may block the broadcast of emergency information. The menu will display the note, "Enabling this option may block emergency messages" to warn you of this possibility.

Unlocking programs temporarily

1. If you try to watch a TV program that exceeds the rating limits you set, the TV enters program lock mode. After 4 seconds, the TV starts the auto favorite channel search function (see page 34). You can either unlock the program temporarily (see steps 2-4) or select a non-locked program to watch.

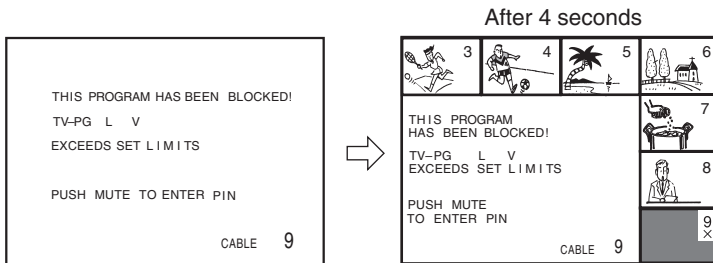

2. To temporarily unlock the program, press MUTE.
3. Press the Number buttons (0-9) to enter your 4-digit PIN code.

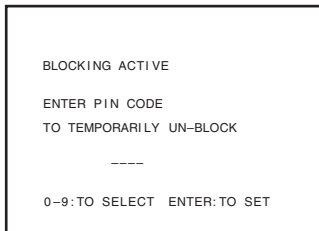

4. Press ENTER.

If the correct code is entered, the program lock mode is released and the normal picture appears.

All locking is disabled until the TV is turned off, and will be enabled when the TV is turned on again.

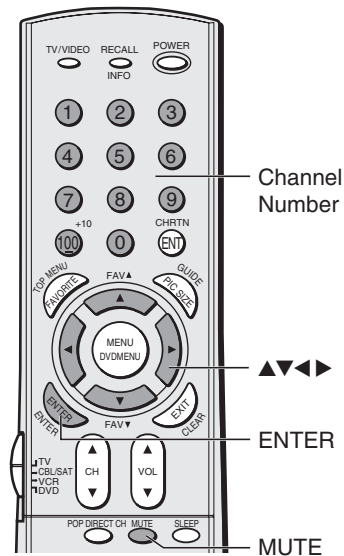

Locking channels

With the CH LOCK feature, you can lock specific channels. The TV will not be able to tune locked channels with the Channel \blacktriangle \blacktriangledown buttons or Channel Number buttons, unless you clear the setting. You can lock a maximum of nine channels.

To lock channels:

1. From the LOCKS menu, select CH LOCK.
2. Press \blacktriangleleft or \blacktriangleright to display the CH LOCK menu. CH INPUT will be highlighted.
3. Press the Channel Number buttons to enter the channel you want to lock.
4. Press ENTER.

LOCKS menu

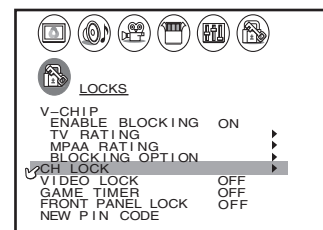

To select each item:
Press \blacktriangledown or \blacktriangle .

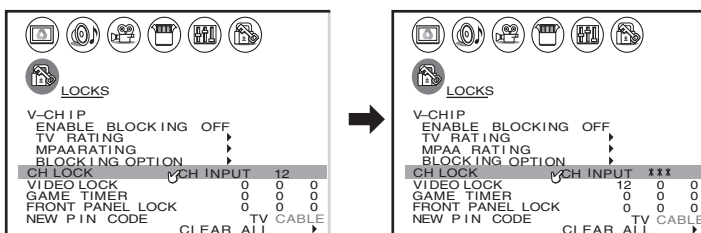

5. Repeat steps 3 and 4 for other channels.

To unlock individual channels:

1. From the LOCKS menu, select CH LOCK.
2. Press ◀ or ▶ to display the CH LOCK menu.
3. Press ▲▼◀▶ to highlight the channel you want to unlock, then press ENTER.

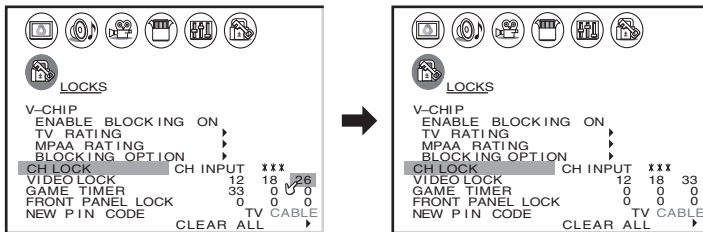

4. Repeat step 3 for other channels.

To unlock all locked channels at once:

Press ▲ or ▼ to highlight CLEAR ALL, and then press ◀ or ▶.

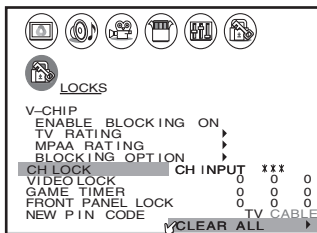

Locking video inputs

With the VIDEO LOCK feature, you can lock out the input sources (Video 1, Video 2, Video 3, ColorStream HD1, ColorStream HD2, DVI/HDCP) and channels 3 and 4.

You will not be able to select the input sources with the TV/VIDEO button or Channel buttons unless you clear the setting.

To set up the video lock:

1. From the LOCKS menu, select VIDEO LOCK.
2. Press ◀ or ▶ to highlight the level of video locking you want (Video, Video+, or Off), as follows:
 VIDEO : Locks Video 1, Video 2, Video 3, ColorStream HD1, HD2, and DVI/HDCP.

VIDEO+ : Locks Video 1, Video 2, Video 3, ColorStream, HD1/HD2, DVI/HDCP, and channels 3 and 4. This option should be used if you use the antenna terminal to play a video tape.

Note: Make sure the POP is not on channel 3 or 4.

OFF : Unlocks all video input sources.

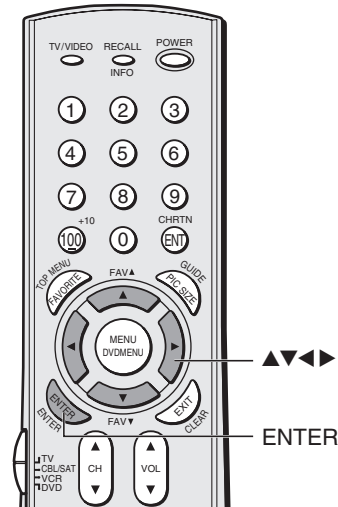
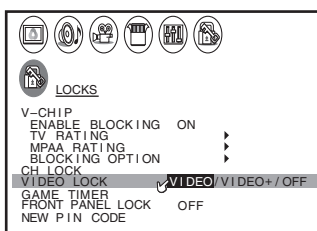

Using the game timer

This feature allows you to restrict the time which has chosen the video mode. When the time set up beforehand is passed, the last tuned channel will be selected automatically (The VIDEO LOCK is set to VIDEO).

To set the game timer:

1. From the LOCKS menu, select GAME TIMER.
2. Press ◀ or ▶ to select the length of time until the video mode is blocked from among 30, 60, 90 and 120 minutes. When the number is highlighted, the timer will start countdown.

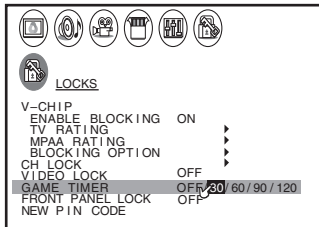

To cancel the timer:

Select OFF in step 2 above.

Using the front panel lock feature

Lock the front panel buttons to prevent the buttons from being pressed accidentally (by children, for example). When the front panel lock is in ON, all control buttons on the TV front panel (except POWER) do not operate.

To lock the front panel:

1. From the LOCKS menu, select FRONT PANEL LOCK.
2. Press ◀ or ▶ to highlight ON.

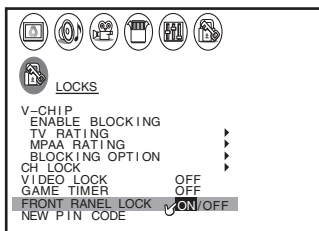

If a button on the front panel is pressed, the message “Not Available” appears.

To unlock the front panel:

Highlight OFF in step 2 above, or press and hold the VOL ◀ button on the TV for about 10 seconds until the message “Front Panel Lock: Off” appears on the screen.

Changing the PIN code

1. From the LOCKS menu, select NEW PIN CODE.
2. Press the Number buttons (0-9) to enter a 4-digit code. The numbers you enter will replace the dashes in the display.

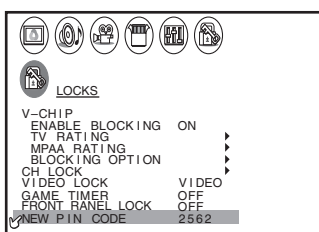

3. Press ENTER.

The new PIN code is now active.

Note:

After the game timer operates, set the VIDEO LOCK to “OFF” if necessary.

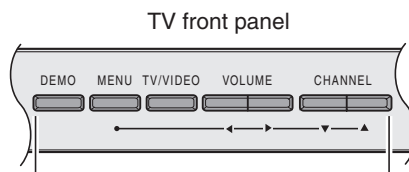

Buttons to be locked

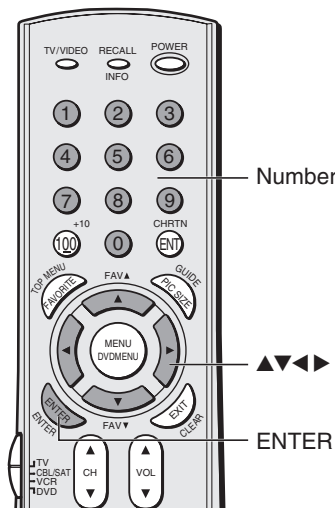
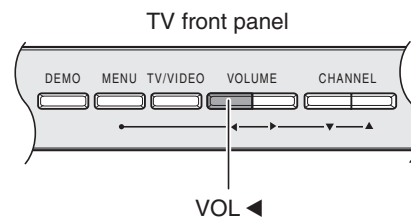

Adjusting the picture

Selecting the picture mode

You can select your desired picture type from four picture modes: Sports, Standard, Movie, and Preference.

Mode	Picture Quality
Sports	Bright and dynamic picture (factory setting)
Standard	Standard picture setting (factory setting)
Movie	Movie-like picture setting (factory setting)
Preference	Your personal preference*

*(see "Saving new preference" on page 42.)

To select the picture mode:

1. Press MENU, and then press ◀ or ▶ until the PICTURE menu appears.
2. Press ▼ or ▲ to select MODE.
3. Press ◀ or ▶ to highlight the mode you prefer.

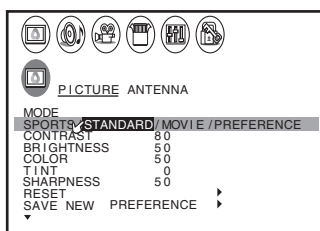

Adjusting the picture quality

You can adjust the picture quality to your personal preferences, including the contrast, brightness, color, tint, sharpness, flesh tone, noise reduction and color temperature.

Selection	◀ Pressing ▶	
contrast	lower	higher
brightness	darker	lighter
color	paler	deeper
tint	reddish	greenish
sharpness	softer	sharper

To adjust the picture quality:

1. Press MENU, and then press ◀ or ▶ until the PICTURE menu appears.
2. Press ▼ or ▲ until the item you want to adjust is highlighted.
3. Press ◀ or ▶ to adjust the level.

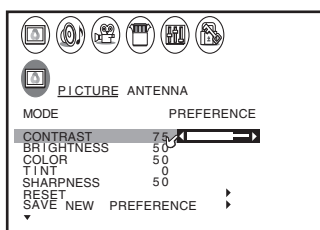

The PICTURE qualities you adjusted can be saved in the TV's memory with the SAVE NEW PREFERENCE feature (see page 42). You can keep these settings or choose factory set options, as described under "Selecting the picture mode" above.

Note:

If you select one of the factory-set picture modes (SPORTS, STANDARDS, or MOVIE) and then change a picture quality setting (for example, increase the contrast), the picture mode automatically changes to PREFERENCE in the Picture menu.

To save your new picture quality settings, you must select SAVE NEW PREFERENCE (see page 42) before closing the Picture menu or the TV will return to the previous picture mode.

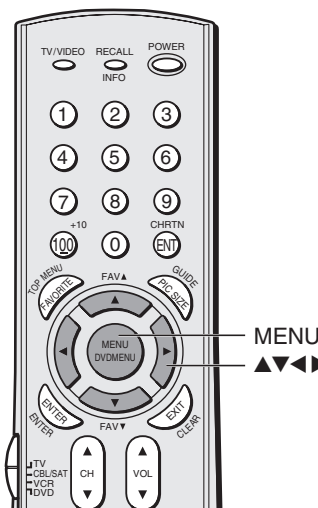
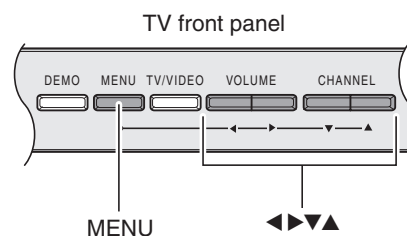

Saving new preference

You can save the PICTURE qualities (contrast, brightness, color, tint, and sharpness) you adjusted in the picture preference mode.

To save your new preferences:

1. Press MENU, and then press ◀ or ▶ until the PICTURE menu appears.
2. Press ▲ or ▼ to highlight SAVE NEW PREFERENCE.
3. Press ◀ or ▶. When complete, the menu displays “DONE”.

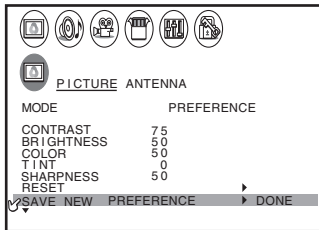

The mode automatically change to PREFERENCE (see “Selecting the picture mode” on page 41).

Using the flesh tone feature

This feature displays natural flesh tones by correcting the tint.

To turn on the flesh tone feature:

1. Press MENU, and then press ◀ or ▶ until the PICTURE menu appears.
2. Press ▲ or ▼ to highlight FLESH TONE.
3. Press ◀ or ▶ to highlight ON.

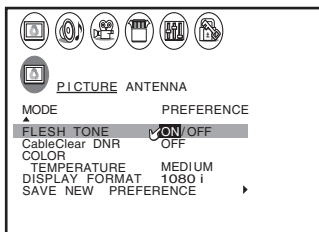

Using the CableClear™ DNR feature

This feature allows you to reduce visible interference in your TV picture. This is useful when receiving a broadcast with a weak signal (especially Cable channel) or playing back a video cassette or disc damaged by repeated use.

To turn on CableClear™ DNR:

1. Press MENU, and then press ◀ or ▶ until the PICTURE menu appears.
2. Press ▲ or ▼ to highlight CableClear DNR.
3. Press ◀ or ▶ to highlight AUTO.

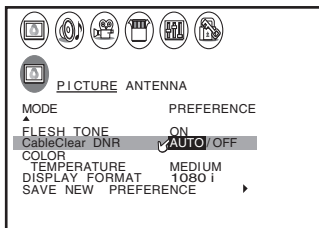

To turn off CableClear DNR:

Highlight OFF in step 3 above.

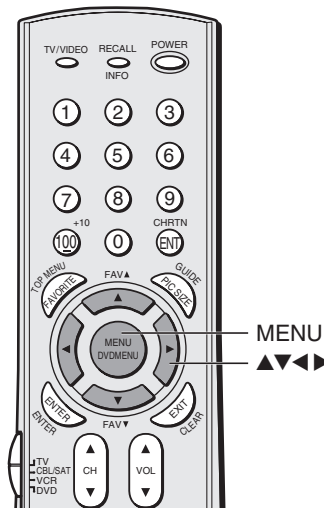

Note:

- This feature is not available for the DVI mode (fixed to OFF).
- “CableClear DNR” display will change to “DNR” in the ColorStream mode.

Selecting the color temperature

You can change the quality of the picture by selecting from three preset color temperatures: cool, medium, and warm.

To select the color temperature:

1. Press MENU, and then press ◀ or ▶ until the PICTURE menu appears.
2. Press ▲ or ▼ to highlight COLOR TEMPERATURE.
3. Press ◀ or ▶ to highlight the mode you prefer.

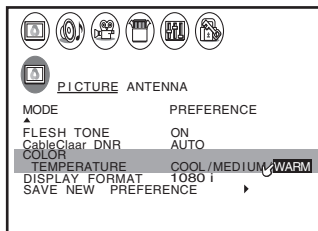

Mode	Picture Quality
cool	blueish
medium	neutral
warm	reddish

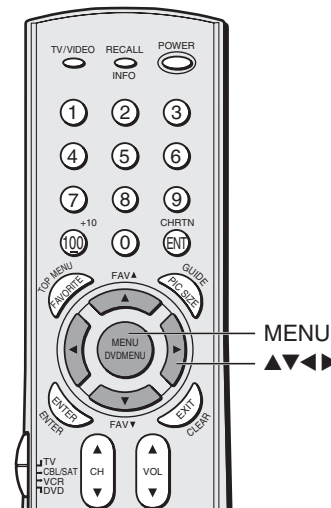

Selecting the display format (540p/1080i)

This feature is to convert the input signal 480p to 540p or 1080i.

To select the display format:

1. Press MENU, and then press ◀ or ▶ until the PICTURE menu appears.
2. Press ▲ or ▼ to highlight DISPLAY FORMAT.
3. Press ◀ or ▶ to select 540p or 1080i as you desire.

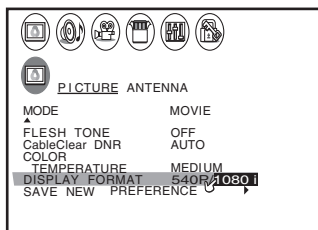

Note:

This feature is available only for 480p input. 1080i is always output when the signal other than 480p is input.

Resetting picture adjustments

The RESET function adjusts the picture qualities to the following factory settings:

Contrast	max (100)	Color temperature	cool
Brightness	center (50)	CableClear DNR	auto
Color	center (50)	Mode	sports
Tint	center (0)		
Sharpness	center (50)		

To reset the picture adjustments:

1. Press MENU, and then press ◀ or ▶ until the PICTURE menu appears.
2. Press ▲ or ▼ to highlight RESET.
3. Press ◀ or ▶. The menu displays “DONE”.

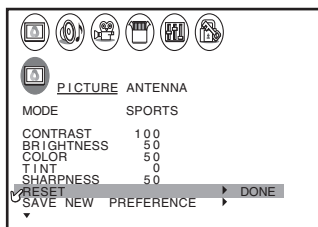

Selecting the video input source

Press the TV/VIDEO on the remote control or the TV to view a signal coming from another device connected to your TV, such as a VCR or video disc player (see illustrations below). You can select ANT 1, VIDEO 1, VIDEO 2, VIDEO 3, ColorStream HD1, ColorStream HD2, DVI, or ANT 2 depending on which input jacks are used for connecting the devices (see "Connecting your TV" on page 7).

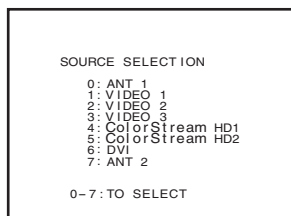

Pressing TV/VIDEO on the remote control displays the current signal source (press TV/VIDEO again or 0-7 to change)

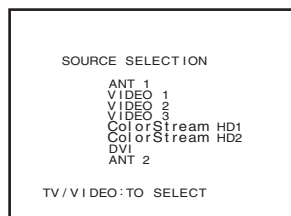

Pressing TV/VIDEO on the TV changes the current signal source

Note:

- When ColorStream HD 1 or HD 2 is selected, the video OUT jack does not output a signal. To receive a video OUT signal, use a video or S-video IN connection instead of the ColorStream connection.
- If you select DVI while the POP picture is active, the POP window will close.

Please note the following regarding the DVI source selection:

This TV is not intended for connection to and should not be used with a PC (personal computer). See "Connecting a device to the DVI/HDCP input" on page 13 for details.

Labeling the video input sources

The video label feature allows you to label each input source for your TV from the following preset list of labels:

- : Uses the default label name
- VCR : Video cassette recorder
- DVD : DVD video
- DTV : Digital TV set-top box
- SAT : Satellite box
- CBL : Cable box
- HD : DVI/HDCP device (see page 13.)

To label the video input sources:

- Press MENU, and then press ◀ or ▶ until the CUSTOM menu appears.
- Press ▲ or ▼ to highlight VIDEO LABEL.

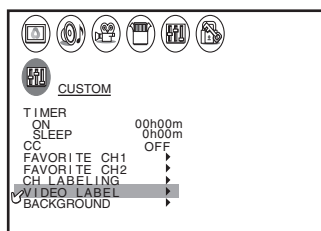

- Press ◀ or ▶ to display the VIDEO LABEL menu.
- Press ▲ or ▼ to highlight the video source you want to label.
- Press ◀ or ▶ to select the desired label for that input source.

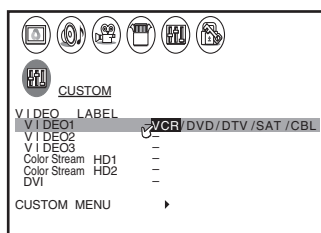

- Finish labeling the other video sources as desired. To return to the previous menu, press ▲ or ▼ to highlight CUSTOM MENU, and then press ◀ or ▶.
- To exit the menu, press EXIT.

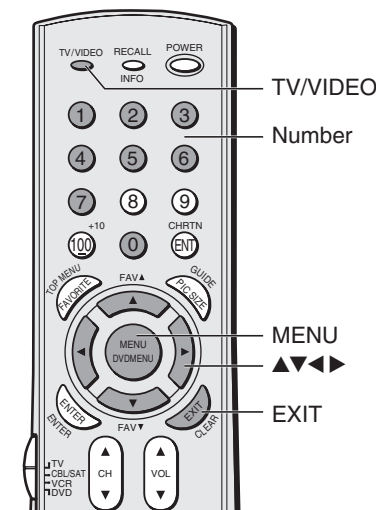
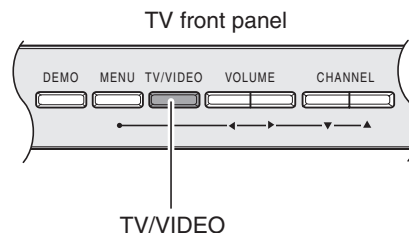

Note:

The HD (high-definition) label is available for DVI mode only (see "Selecting the video input source" above, and "Connecting a device to the DVI/HDCP input" on page 13).

Using the closed caption feature

The closed caption feature has two options:

- Captions—An on-screen display of the dialogue, narration, and sound effects of TV programs and videos that are closed captioned (usually marked as “CC” in TV listings).
- Text—An on-screen display of information not related to the current program, such as weather or stock data (when provided by individual stations).

To view captions or text:

1. Tune the TV to the desired program.
2. Press MENU, and then press ◀ or ▶ to display CUSTOM menu.
3. Press ▲ or ▼ to highlight CC.

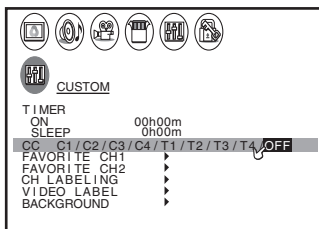

4. Press ◀ or ▶ to highlight the desired closed caption mode, as follows:

- To view captions, highlight C1, C2, C3, or C4 (C1 displays translation of the primary language in your area).

Note: If the program or video you selected is not closed captioned, no captions will display on the screen.



- To view text, highlight T1, T2, T3, or T4.

Note: If text is not available in your area, a black rectangle may appear on your screen. If this happens, turn the Closed Caption feature OFF.

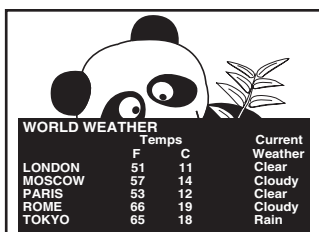

To turn off the Closed Caption feature:
Highlight OFF in step 4.

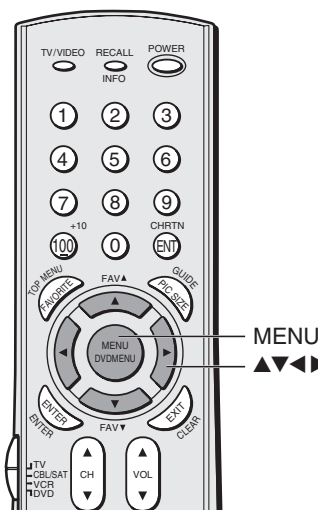

Note:

A closed caption signal may not display in the following situations:

- when a videotape has been dubbed
- when the signal reception is weak
- when the signal reception is nonstandard

Setting the ON-timer

To set the ON-timer to turn the TV on automatically:

1. Press MENU, and then press ◀ or ▶ until the CUSTOM menu appears.
2. Press ▲ or ▼ to highlight ON.
3. After the number position starts to blink, press the Number buttons (0-9) to enter the length of time until the TV turns on automatically.
You can set the ON-timer by 10 minutes, up to 12h00m.
4. Press ENTER to start the timer.

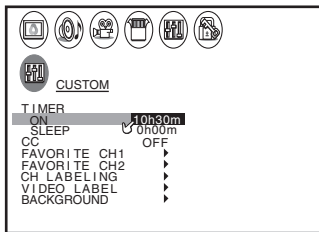

5. Press POWER to turn off the TV.
The TV will turn on automatically after the time you preset.

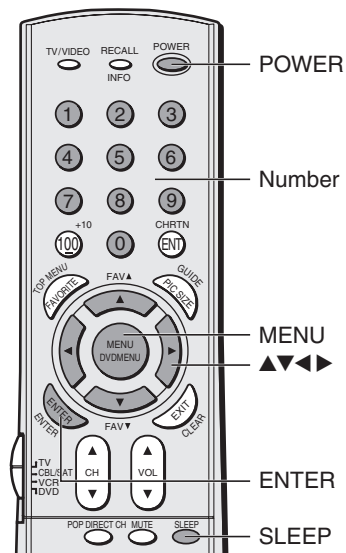

Setting the sleep timer

To set the sleep timer to turn the TV off automatically:

1. Press SLEEP to set the length of time until the TV turns off.

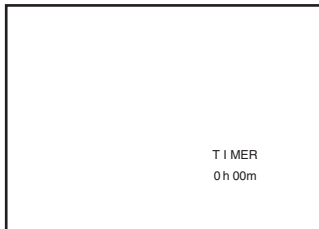

Every time you press the button, the time display will increase by 10 minutes, up to 3 hours.

0h00m → 0h10m → 0h20m ----- → 2h50m → 3h00m → 0h00m

To cancel the sleep timer:

Press SLEEP until it is set to 0h00m.

The timer can also be set using the on-screen menu:

1. Press MENU, and then press ◀ or ▶ until the CUSTOM menu appears.
2. Press ▲ or ▼ to highlight SLEEP.
3. After the number position starts to blink, press the Number buttons (0-9) to enter the length of time until the TV turns off automatically.
4. Press ENTER to start the timer.

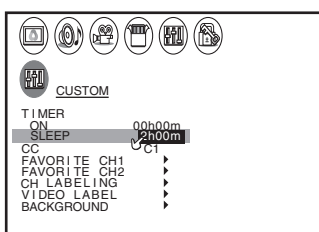

Note :

When an instant power failure occurs, the timer setting may be cleared.

To display the amount of time left until the TV turns on or off automatically, press RECALL.

Setting the clock

To set the clock:

1. Press MENU, and then press ◀ or ▶ until the SET UP menu appears.
2. Press ▲ or ▼ to highlight CLOCK SET.
3. After the number position starts to blink, press the Number buttons (0-9) to enter the correct time. The clock operates on a 24-hour cycle.
4. Press ENTER to start the clock.

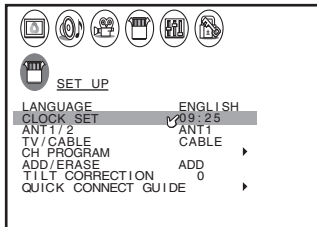

To display the time on-screen:

Press RECALL.

Selecting the background of the menu display

You can change the background of the menu display by selecting from two preset types: shaded and solid (gray).

To select the background:

1. Press MENU, and then press ◀ or ▶ until the CUSTOM menu appears.
2. Press ▲ or ▼ to highlight BACKGROUND.
3. Press ◀ or ▶ to select either a SHADED or SOLID background.

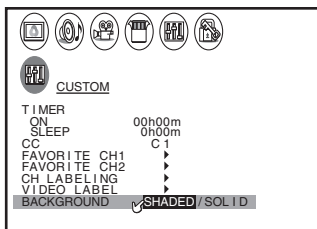

Note :

If the TV's power source is interrupted (the power cord is unplugged or a power failure occurs), the clock must be reset.

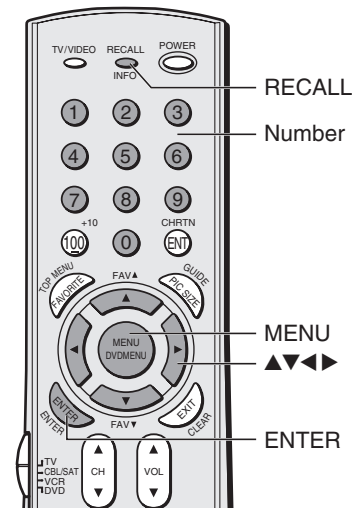

Adjusting the sound

Muting the sound

Press MUTE to temporarily reduce (1/2 MUTE) or turn off (MUTE) the sound. While the sound is reduced, the screen will display “1/2 MUTE” or “MUTE” in the lower right corner. Every time you press the button, the mute mode will change in the following order.

→ Normal → 1/2 MUTE → MUTE →

When you select “MUTE” mode, the closed caption feature is automatically activated. To deactivate this feature, deactivate MUTE. This feature works only when the closed caption mode is set to OFF. See “Using the closed caption feature” on page 45 for more information.

Selecting stereo/SAP broadcasts

The multi-channel TV sound (MTS) feature allows you to listen to high-fidelity stereo sound while watching TV. MTS can also transmit a second audio program (SAP) containing a second language, music, or other audio information (when provided by individual stations).

When the TV receives a stereo or SAP broadcast, the word STEREO or SAP appears on-screen every time the TV is turned on, the channel is changed, or the RECALL button is pressed.

The MTS feature is not available when the TV is in VIDEO mode.

To listen to stereo sound:

1. Press MENU, and then press ◀ or ▶ until the AUDIO menu appears.
2. Press ▲ or ▼ to highlight MTS.
3. Press ◀ or ▶ to highlight STEREO.

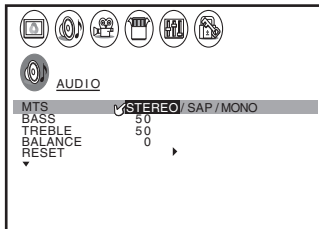

You can leave your TV in STEREO mode because it will automatically output the type of sound being broadcast (stereo or monaural). The word “STEREO” or “SAP” displays in yellow in the menu when the TV receives the signal.

If the stereo sound is noisy, select MONO to reduce the noise.

To listen to SAP (if available):

1. Press MENU, and then press ◀ or ▶ until the AUDIO menu appears.
2. Press ▲ or ▼ to highlight MTS.
3. Press ◀ or ▶ to highlight SAP. You will hear the station's second audio program (if available) from the speakers, while viewing the original program's picture (see note at right).

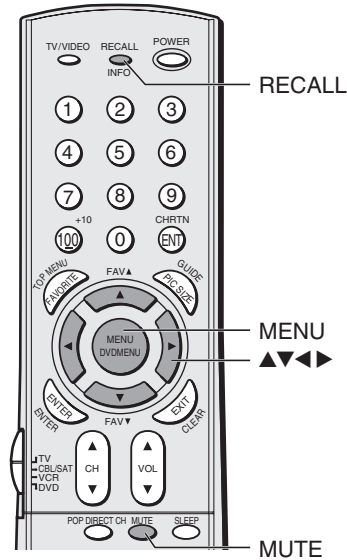

TV front panel

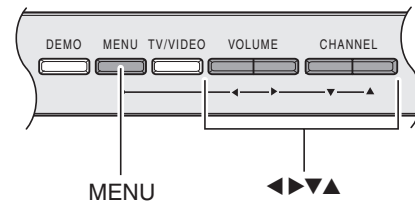

Note :

A second audio program (SAP) can be heard only on those TV stations that offer it.

For example, a station might broadcast music as a second audio program. If you have SAP on, you will see the current program on the screen but hear music instead of the program's normal audio.

If you have SAP on and the station you are watching is not broadcasting a second audio program, the station's normal audio will be output.

However, occasionally there is no sound at all in this instance.

If this happens, set the MTS feature to STEREO mode.

Using the WOW™ surround sound feature

WOW is the latest audio enhancement technology combined with SRS 3D and TruBass of SRS Labs individual technologies. The feature uses stereo signals from a TV broadcast or video input.

To adjust the WOW feature:

1. Select STEREO mode (See “Selecting stereo/SAP broadcasts” on page 48).
2. Press MENU, and then press ◀ or ▶ until the THEATER menu appears.
3. Press ▲ or ▼ to highlight the desired WOW feature you want to adjust, then press ◀ or ▶ to adjust the item.

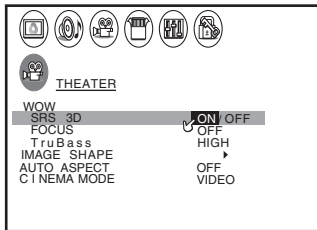

- SRS 3D — To turn on or off the surround sound effect.
- FOCUS — To turn on or off the vocal emphasis effect.
- TruBass — To select your desired bass expansion level (HIGH, LOW or OFF).

Adjusting the sound quality

You can change the quality of your TV's sound by adjusting the bass, treble, and balance.

To adjust the sound quality:

1. Press MENU, and then press ◀ or ▶ until the AUDIO menu appears.
2. Press ▲ or ▼ to highlight the item you want to adjust.

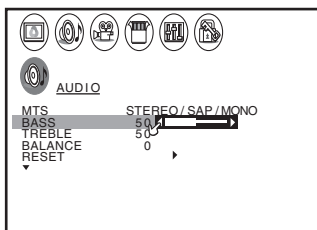

3. Press ◀ or ▶ to adjust the level.
 - ◀ makes the sound quality weaker or decreases the balance in the right channel, depending on the item selected.
 - ▶ makes the sound quality stronger or decreases the balance in the left channel, depending on the item selected.

Note:

If the broadcast is monaural, the SRS 3D effect does not work.

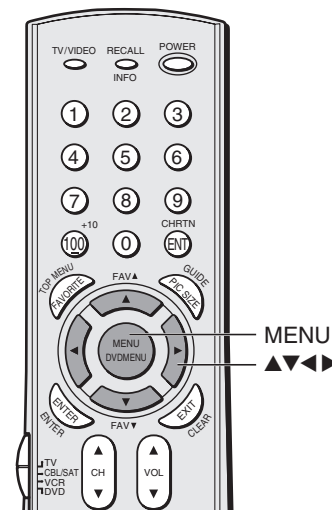

Resetting your audio adjustments

The RESET function returns the audio adjustments to the following factory settings:

- Bass center (50)
- Treble center (50)
- Balance center (0)

To reset the audio adjustments:

1. Press MENU, and then press ◀ or ▶ until the AUDIO menu appears.
2. Press ▲ or ▼ to highlight RESET.
3. Press ◀ or ▶. The menu displays “DONE”.

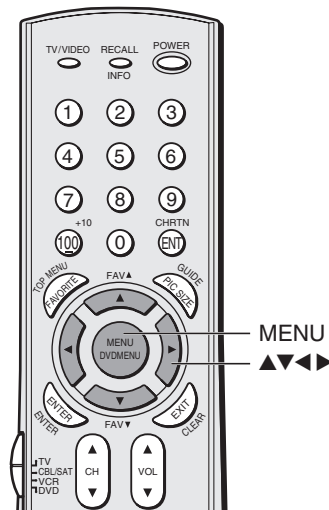
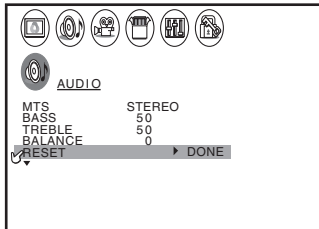

Note:

While in the SBS OFF mode, if the SBS level is adjusted, the SBS is automatically set ON.

Using the sub-bass system (SBS)

The sub-bass system allows you to enhance bass performance, even when the sound volume is low.

To turn on the SBS:

1. Press MENU, and then press ◀ or ▶ until the AUDIO menu appears.
2. Press ▲ or ▼ to highlight SBS.
3. Press ◀ or ▶ to highlight ON.

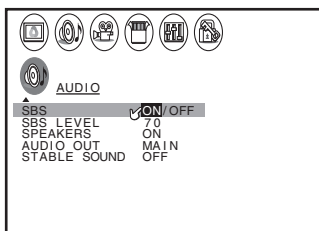

To adjust the SBS level:

4. Press ▲ or ▼ to highlight SBS LEVEL.
5. Press ◀ or ▶ to adjust the SBS level.

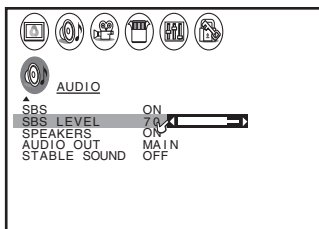

To turn off the SBS:

Highlight OFF in step 3 above.

Turning off the built-in speakers

Use this feature to turn the TV speakers off when you connect an audio system (See “Connecting an audio system” on page 14).

To turn off the built-in speakers:

1. Press MENU, then press ◀ or ▶ until AUDIO menu appears.
2. Press ▲ or ▼ to highlight SPEAKERS.
3. Press ◀ or ▶ to highlight OFF.

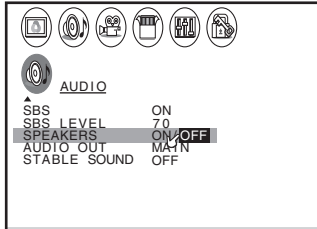

To turn on the built-in speakers:

Highlight ON in step 3 above.

Selecting the Audio OUT sound

This feature allows you to select the sound source (MAIN or POP) that is output from the Audio OUT jacks (See “Connecting two VCRs” on page 12).

This is useful when amplifying or recording the POP sound with external equipment while hearing the sound of the main picture through the built-in speakers.

To select the Audio OUT sound:

1. Press MENU, and then press ◀ or ▶ until the AUDIO menu appears.
2. Press ▲ or ▼ to highlight AUDIO OUT.
3. Press ◀ or ▶ to select MAIN or POP.

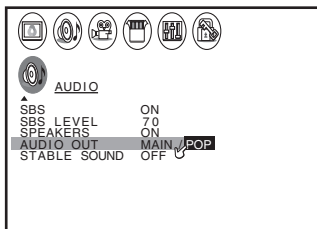

- MAIN: Outputs the sound of the main program.
- POP : Outputs the sound of the POP program.

Note:

- Make sure the volume control of your audio amplifier is set to a moderate listening level.
- When the POP is not on the screen, the sound of the main program is output, even if the POP sound is selected.

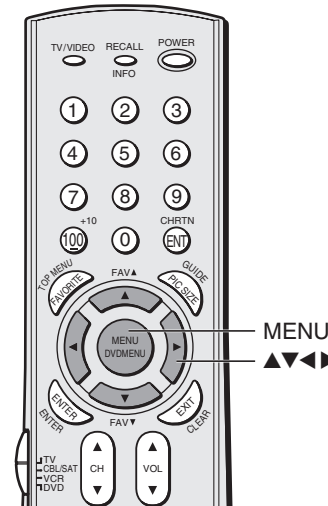

Using the StableSound® feature

When the signal source is changed, the StableSound® feature limits the highest volume level to prevent extreme changes in volume (for example, to prevent the sudden increase in volume that often happens when a TV program switches to a commercial).

To turn on the StableSound® feature:

1. Press MENU, and then press ◀ or ▶ until the AUDIO menu appears.
2. Press ▲ or ▼ to highlight STABLE SOUND.
3. Press ◀ or ▶ to select ON.

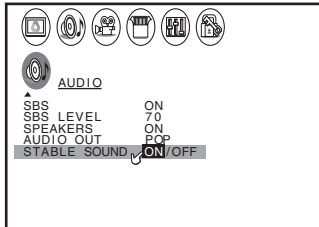

To turn off the StableSound feature:

Highlight OFF in step 3 above.

Displaying on-screen information

Press RECALL to display the following information on-screen:

- Antenna mode (when in TV mode)
- Channel number or VIDEO mode selected
- Time (if set)
- Remaining time of ON/SLEEP timers (if set)
- Channel label (if set)
- Stereo or SAP audio status
- V-CHIP rating status
- Image shape

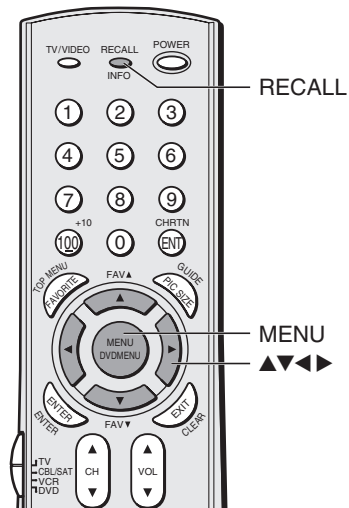
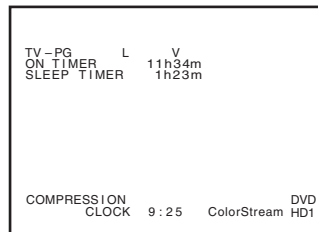
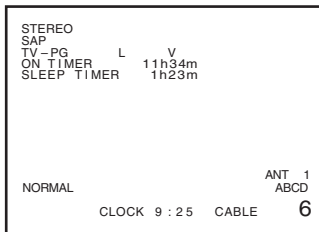

Viewing the demo mode

The demo mode automatically demonstrates several of your TV's features. This function is provided for demonstration purposes only.

To start the demo:

Press DEMO on the TV front panel.

To stop the demo:

Press DEMO, RECALL, EXIT, or POWER.

Understanding the auto power off feature

The TV will automatically turn itself off after approximately 15 minutes if it is tuned to a vacant channel or a station that completes its broadcast for the day. This feature does not work in VIDEO mode.

Understanding the last mode memory feature

If the power is cut off while you are viewing the TV, the Last Mode Memory feature turns the TV on automatically when the power is resupplied.

If the power is going to be off for a long time and you are going to be away from your TV, unplug the power cord to prevent the TV from turning on in your absence.

Appendix

Specifications

Television System

NTSC standard

Channel Coverage

VHF: 2 through 13

UHF: 14 through 69

Cable TV: Mid band (A-8 through A-1, A through I)

Super band (J through W)

Hyper band (AA through ZZ, AAA, BBB)

Ultra band (65 through 94, 100 through 125)

Power Source

120 V AC, 60 Hz

Power Consumption

32HF73: 172 W (average)

36HF73: 174 W (average)

Audio Power

10 W + 10 W

Speaker Type

Two 2-3/8 inches (60 × 120 mm)

Video/Audio Terminals

S-VIDEO INPUT

Y : 1 V(p-p), 75 ohm, negative sync.

C : 0.286 V(p-p) (burst signal), 75 ohm

VIDEO/AUDIO INPUT

VIDEO: 1 V(p-p), 75 ohm, negative sync.

AUDIO: 150 mV(rms) (30% modulation equivalent, 47 k ohm)

ColorStream® (component video) INPUT

Y : 1V(p-p), 75 ohm

PR: 0.7 V(p-p), 75 ohm

PB: 0.7 V(p-p), 75 ohm

AUDIO: 150 mV(rms), 47 k ohm

VIDEO/AUDIO OUTPUT

VIDEO: 1 V(p-p), 75 ohm, negative sync.

AUDIO: 150 mV(rms) (30% modulation equivalent, 4.7 k ohm)

VARIABLE AUDIO OUTPUT

0–300 mV(rms) (30% modulation equivalent, 4.7 k ohm)

AUDIO CENTER CHANNEL INPUT

300 mV(rms) (30% modulation equivalent, 10 k ohm)

DVI/HDCP INPUT

HDCP compliant

E-EDID* 1.3 compliant

DVI-D uncompressed, high-speed, digital single-link connection

Suggested scan rates: 1080i, 480p, 480i

Dimensions

32HF73: Width 34-1/2 inches (875 mm)

Height 26-3/8 inches (670 mm)

Depth 22-5/8 inches (575 mm)

36HF73: Width 38-1/4 inches (972 mm)

Height 29-5/8 inches (753 mm)

Depth 24-1/4 inches (615 mm)

Mass

32HF73: 151.0 lbs (67 kg)

36HF73: 203.0 lbs (97 kg)

Supplied Accessories

Remote Control with 2 size “AA” alkaline batteries

Optional Stand

32HF73: ST3263

36HF73: ST3663

Design and specifications are subject to change without notice.

* E-EDID = Enhanced-Extended Display Identification

Troubleshooting

Before calling a service technician, please check the following table for a possible cause of the problem and some solutions.

Problem	Solution
TV will not turn on	<ul style="list-style-type: none"> • Make sure the power cord is plugged in, then press POWER. • The remote control batteries may be dead. Replace the batteries.
No picture, no sound	<ul style="list-style-type: none"> • Check the antenna/cable connections.
No sound, picture OK	<ul style="list-style-type: none"> • The sound may be muted. Press VOLUME. • The station may have broadcast difficulties. Try another channel. • Check that the SPEAKERS function in AUDIO menu is set properly. • Check that the AUDIO CENTER CHANNEL switch is set properly.
Poor picture, sound OK	<ul style="list-style-type: none"> • Check the antenna connections. • The station may have broadcast difficulties. Try another channel. • Adjust the PICTURE menu.
Poor reception of broadcast channels	<ul style="list-style-type: none"> • The station may have broadcast difficulties. Try another channel. • Check the antenna connections. • If you are using a VCR, make sure the TV/VCR button is set correctly.
Cannot receive above channel 13	<ul style="list-style-type: none"> • Make sure the TV/CABLE switch is set to the mode that corresponds with the signal source type (cable company or outside antenna).
Black box appears on the screen	<ul style="list-style-type: none"> • The closed caption feature may be set to one of the Text modes (T1, T2, T3, or T4). Turn closed captioning OFF.
Unable to select a certain channel	<ul style="list-style-type: none"> • The channel may be locked out with the CH LOCK feature, or erased with the ADD/ERASE feature.
Multiple images	<ul style="list-style-type: none"> • The station may have broadcast difficulties. Try another channel. • Antenna reception may be poor. Use a highly directional outdoor antenna.
Poor color or no color	<ul style="list-style-type: none"> • The station may have broadcast difficulties. Try another channel. • Adjust the TINT and/or COLOR in the PICTURE menu.
No stereo or SAP sound from a known MTS broadcast	<ul style="list-style-type: none"> • Make sure the MTS feature is set properly.
The front panel buttons do not operate	<ul style="list-style-type: none"> • Check the FRONT PANEL LOCK feature.
The remote control does not operate	<ul style="list-style-type: none"> • Check whether the appropriate device mode is selected. • Remove all obstructions between the remote control and the remote control sensor in the TV. • The remote control batteries may be dead. Replace the batteries.
Cannot access signal input sources (Video1, Video2, Video3, ColorStream HD1/HD2, DVI/HDCP) and/or Channels 3 and 4.	<ul style="list-style-type: none"> • Check the VIDEO LOCK feature.

Limited United States Warranty

for 27" FST PURE® and All Larger Television Models

Toshiba America Consumer Products, Inc. ("TACP") and Toshiba Hawaii, Inc. ("THI") make the following limited warranties to original consumers in the United States. THESE LIMITED WARRANTIES EXTEND TO THE ORIGINAL CONSUMER PURCHASER OR ANY PERSON RECEIVING THIS TELEVISION AS A GIFT FROM THE ORIGINAL CONSUMER PURCHASER AND TO NO OTHER PURCHASER OR TRANSFEREE.

PRODUCTS PURCHASED IN THE U.S.A. AND USED IN CANADA ARE NOT COVERED BY THESE WARRANTIES.

PRODUCTS PURCHASED IN CANADA AND USED IN THE U.S.A. ARE NOT COVERED BY THESE WARRANTIES.

Limited One (1) Year Warranty on Parts and Labor*

TACP/THI warrant this television and its parts against defects in materials or workmanship for a period of one (1) year after the date of original retail purchase. DURING THIS PERIOD, TACP/THI WILL, AT TACP/THI'S OPTION, REPAIR OR REPLACE A DEFECTIVE PART WITH A NEW OR REFURBISHED PART WITHOUT CHARGE TO YOU FOR PARTS OR LABOR. TACP/THI Authorized Service Station personnel will come to your home when warranty service is required. Depending on the type of repair required, either the service will be performed in your home or the set will be taken to the TACP/THI Authorized Service Station for repair and returned to your home at no cost to you.

Limited Two (2) Year Warranty on Picture Tube*

TACP/THI further warrant the picture tube in this television against defects in materials or workmanship for a period of two (2) years after the date of original retail purchase. DURING THIS PERIOD, TACP/THI WILL, AT TACP/THI'S OPTION, REPAIR OR REPLACE A DEFECTIVE PICTURE TUBE WITH A NEW OR REFURBISHED PICTURE TUBE WITHOUT CHARGE TO YOU, EXCEPT THAT, IF A DEFECTIVE PICTURE TUBE IS REPAIRED OR REPLACED AFTER ONE (1) YEAR FROM THE DATE OF THE ORIGINAL RETAIL PURCHASE, YOU PAY LABOR CHARGES INVOLVED IN THE REPAIR OR REPLACEMENT.

Rental Units

The warranty for rental units begins with the date of first rental or thirty (30) days from the date of shipment to the rental firm, whichever comes first.

*Commercial Units

Televisions sold and used for commercial purposes have a limited ninety (90) day warranty for all parts, labor, and picture tubes.

Owner's Manual and Product Registration Card

Read this owner's manual thoroughly before operating this television. Complete and mail the enclosed product registration card within ten days after you, or the person who has given you this product as a gift, purchased this television. Returning the product registration card will enable TACP/THI to provide you with better customer service and improved product support. Failure to return the product registration card will not affect your rights under this warranty.

Your Responsibility

THE ABOVE WARRANTIES ARE SUBJECT TO THE FOLLOWING CONDITIONS:

- (1) You must provide your bill of sale or other proof of purchase.
- (2) All warranty servicing of this television must be made by an Authorized TACP/THI Service Station.
- (3) The warranties from TACP and THI are effective only if the television is purchased and operated in the U.S.A. or Puerto Rico.
- (4) Labor service charges for set installation, setup, adjustment of customer controls, and installation or repair of antenna

systems are not covered by these warranties. Reception problems caused by inadequate antenna systems are your responsibility.

- (5) Warranties extend only to defects in materials or workmanship as limited above and do not extend to any television or parts that have been lost or discarded by you or to damage to television or parts caused by misuse, accident, Acts of God (such as lightning or fluctuations in electric power), improper installation, improper maintenance, or use in violation of instructions furnished by TACP/THI; or to units that have been modified or had the serial number removed, altered, defaced, or rendered illegible.

How to Obtain Warranty Services

If, after following all of the operating instructions in this manual and checking the "Troubleshooting" section, you find that service is needed:

- (1) To find the nearest TACP/THI Authorized Service Station:
For televisions purchased in the United States, except Hawaii, visit TACP's web site at www.toshiba.com/tacp, or call toll free 1-800-631-3811.
For televisions purchased in Hawaii, contact Toshiba Hawaii, Inc., 327 Kamakee Street, Honolulu, HI 96814, (808) 591-9281.
- (2) Present your bill of sale or other proof of purchase to the Authorized Service Station. Authorized TACP/THI Service Station personnel will come to your home when warranty service is required. Depending on the type of repair required, either the service will be performed in your home or the set will be taken to the Authorized Service Station for repair and returned to your home at no cost to you.

**For additional information, visit TACP's web site:
www.toshiba.com/tacp.**

ALL WARRANTIES IMPLIED BY THE LAW OF ANY STATE OF THE U.S.A., INCLUDING THE IMPLIED WARRANTIES OF MERCHANTABILITY AND FITNESS FOR A PARTICULAR PURPOSE, ARE EXPRESSLY LIMITED TO THE DURATION OF THE LIMITED WARRANTIES SET FORTH ABOVE. WITH THE EXCEPTION OF ANY WARRANTIES IMPLIED BY THE LAW OF ANY STATE OF THE U.S.A. AS HEREBY LIMITED, THE FOREGOING WARRANTY IS EXCLUSIVE AND IN LIEU OF ALL OTHER WARRANTIES, GUARANTEES, AGREEMENTS, AND SIMILAR OBLIGATIONS OF TACP OR THI WITH RESPECT TO THE REPAIR OR REPLACEMENT OF ANY PARTS. IN NO EVENT SHALL TACP OR THI BE LIABLE FOR CONSEQUENTIAL OR INCIDENTAL DAMAGES.

No person, agent, distributor, dealer, or company is authorized to change, modify, or extend the terms of these warranties in any manner whatsoever. The time within which action must be commenced to enforce any obligation of TACP or THI arising under this warranty or under any law of the United States or of any state thereof is hereby limited to 90 days from the date you discover, or should have discovered, the defect. This limitation does not apply to implied warranties arising under the law of any state of the U.S.A.

THIS WARRANTY GIVES YOU SPECIFIC LEGAL RIGHTS, AND YOU MAY ALSO HAVE OTHER RIGHTS, WHICH MAY VARY FROM STATE TO STATE IN THE U.S.A. SOME STATES OF THE U.S.A. DO NOT ALLOW LIMITATIONS ON THE DURATION OF AN IMPLIED WARRANTY, LIMITATIONS ON THE TIME WITHIN WHICH AN ACTION MAY BE BROUGHT, OR THE EXCLUSION OR LIMITATION OF INCIDENTAL OR CONSEQUENTIAL DAMAGES; THEREFORE, THE ABOVE LIMITATIONS OR EXCLUSIONS MAY NOT APPLY TO YOU UNDER SUCH CIRCUMSTANCES.

FST PURE® is a registered trademark of Toshiba America Consumer Products, Inc.
REV. MAR02

Limited Canada Warranty

for 27" FST PURE® and All Larger Television Models

Toshiba of Canada Limited ("TCL") makes the following limited warranties to original consumers in Canada.

THESE LIMITED WARRANTIES EXTEND TO THE ORIGINAL CONSUMER PURCHASER OR ANY PERSON RECEIVING THIS TELEVISION AS A GIFT FROM THE ORIGINAL CONSUMER PURCHASER AND TO NO OTHER PURCHASER OR TRANSFEREE.

PRODUCTS PURCHASED IN THE U.S.A. AND USED IN CANADA ARE NOT COVERED BY THESE WARRANTIES.

PRODUCTS PURCHASED IN CANADA AND USED IN THE U.S.A. ARE NOT COVERED BY THESE WARRANTIES.

Limited One (1) Year Warranty on Parts and Labor*

TCL warrants this television and its parts against defects in materials or workmanship for a period of one (1) year after the date of original retail purchase. DURING THIS PERIOD, TCL WILL, AT TCL'S OPTION, REPAIR OR REPLACE A DEFECTIVE PART WITH A NEW OR REFURBISHED PART WITHOUT CHARGE TO YOU FOR PARTS OR LABOR. TCL Authorized Service Depot personnel will come to your home when warranty service is required. Depending on the type of repair required, either the service will be performed in your home or the set will be taken to the TCL Authorized Service Depot for repair and returned to your home at no cost to you. IN-HOME SERVICE ONLY APPLIES WITHIN 100 KILOMETERS OF AN AUTHORIZED TCL SERVICE DEPOT.

Limited Two (2) Year Warranty on Picture Tube*

TCL further warrants the picture tube in this television against defects in materials or workmanship for a period of two (2) years after the date of original retail purchase. DURING THIS PERIOD, TCL WILL, AT TCL'S OPTION, REPAIR OR REPLACE A DEFECTIVE PICTURE TUBE WITH A NEW OR REFURBISHED PICTURE TUBE WITHOUT CHARGE TO YOU, EXCEPT THAT, IF A DEFECTIVE PICTURE TUBE IS REPAIRED OR REPLACED AFTER ONE (1) YEAR FROM THE DATE OF THE ORIGINAL RETAIL PURCHASE, YOU PAY LABOR CHARGES INVOLVED IN THE REPAIR OR REPLACEMENT.

Rental Units

The warranty for rental units begins with the date of first rental or thirty (30) days from the date of shipment to the rental firm, whichever comes first.

*Commercial Units

Televisions sold and used for commercial purposes have a limited ninety (90) day warranty for all parts, labor, and picture tubes.

Owner's Manual

Read this owner's manual thoroughly before operating this television.

Your Responsibility

THE ABOVE WARRANTIES ARE SUBJECT TO THE FOLLOWING CONDITIONS:

- (1) You must provide your bill of sale or other proof of purchase.
- (2) All warranty servicing of this television must be made by an Authorized TCL Service Depot.
- (3) The warranties from TCL are effective only if the television is purchased in Canada from an authorized TCL dealer and operated in Canada.
- (4) Labor service charges for set installation, setup, adjustment of customer controls, and installation or repair of antenna systems are not covered by these warranties. Reception problems caused by inadequate antenna systems are your responsibility.

- (5) Warranties extend only to defects in materials or workmanship as limited above and do not extend to any television or parts that have been lost or discarded by you or to damage to television or parts caused by misuse, accident, Acts of God (such as lightning or fluctuations in electric power), improper installation, improper maintenance, or use in violation of instructions furnished by TCL; or to units that have been modified or had the serial number removed, altered, defaced, or rendered illegible.

How to Obtain Warranty Services

If, after following all of the operating instructions in this manual and checking the "Troubleshooting" section, you find that service is needed:

- (1) To find the nearest TCL Authorized Service Depot, visit TCL's web site: www.toshiba.ca.
- (2) Present your bill of sale or other proof of purchase to the Authorized Service Depot. Authorized TCL Service Depot personnel will come to your home when warranty service is required. Depending on the type of repair required, either the service will be performed in your home or the set will be taken to the Authorized Service Depot for repair and returned to your home at no cost to you. IN-HOME SERVICE ONLY APPLIES WITHIN 100 KILOMETERS OF AN AUTHORIZED TCL SERVICE DEPOT.

**For additional information, visit TCL's web site:
www.toshiba.ca**

ALL WARRANTIES IMPLIED BY THE LAW OF ANY PROVINCE OF CANADA, INCLUDING THE IMPLIED WARRANTIES OF MERCHANTABILITY AND FITNESS FOR A PARTICULAR PURPOSE, ARE EXPRESSLY LIMITED TO THE DURATION OF THE LIMITED WARRANTIES SET FORTH ABOVE. WITH THE EXCEPTION OF ANY WARRANTIES IMPLIED BY THE LAW OF ANY PROVINCE OF CANADA AS HEREBY LIMITED, THE FOREGOING WARRANTY IS EXCLUSIVE AND IN LIEU OF ALL OTHER WARRANTIES, GUARANTEES, AGREEMENTS, AND SIMILAR OBLIGATIONS OF TCL WITH RESPECT TO THE REPAIR OR REPLACEMENT OF ANY PARTS. IN NO EVENT SHALL TCL BE LIABLE FOR CONSEQUENTIAL OR INCIDENTAL DAMAGES.

No person, agent, distributor, dealer, or company is authorized to change, modify, or extend the terms of these warranties in any manner whatsoever. The time within which action must be commenced to enforce any obligation of TCL arising under this warranty or under any law of Canada or of any province thereof, is hereby limited to 90 days from the date you discover, or should have discovered, the defect. This limitation does not apply to implied warranties arising under the law of any province of Canada.

THIS WARRANTY GIVES YOU SPECIFIC LEGAL RIGHTS, AND YOU MAY ALSO HAVE OTHER RIGHTS, WHICH MAY VARY FROM PROVINCE TO PROVINCE IN CANADA. SOME PROVINCES OF CANADA DO NOT ALLOW LIMITATIONS ON THE DURATION OF AN IMPLIED WARRANTY, LIMITATIONS ON THE TIME WITHIN WHICH AN ACTION MAY BE BROUGHT, OR THE EXCLUSION OR LIMITATION OF INCIDENTAL OR CONSEQUENTIAL DAMAGES; THEREFORE, THE ABOVE LIMITATIONS OR EXCLUSIONS MAY NOT APPLY TO YOU UNDER SUCH CIRCUMSTANCES.

FST PURE® is a registered trademark of Toshiba America Consumer Products, Inc.
REV. MAR02

Index

A

A/V cables (standard)	7
A/V receiver connection	14
ANT 1/2	21
Antenna cables (coaxial)	7
AUDIO OUT sound, selecting	51
Audio system connection	14
Auto aspect	30
Auto favorite	34
Auto power off	53

B

BACKGROUND selection	47
Back of the TV	6

C

CableClear™ DNR	42
Cable converter box connection	8
Camcorder connection	12
CH ▲▼ buttons	24
CH LABELING	27
CH LOCK	38
CH RTN button	25
Channel Number buttons	24
Channel programming	
ADD/ERASE	22
Automatic programming	22
TV/CABLE selection	22
Cinema mode	30
Clock, setting	47
Closed caption	45
Color temperature	43
ColorStream (component) cables	7

D

DEMO button	53
Display format	43
Double-window (“POP”) feature	31
DTV receiver connection	11
DVD connection	9, 10
DVI cable	7
DVI/HDCP connection	13

F G

FAV ▲▼ buttons	26
FAVORITE button	34
Favorite channels, programming	25
FOCUS feature	49
Front of the TV	6
Front panel lock	40
Game timer	40

I

Image shape selection	28
-----------------------------	----

L M

Labeling channels	27
Labeling video inputs	44
Language selection	21
Last mode memory	53
Locking channels	38
Locking video inputs	39
Locks menu	35
Menu system	20
MTS feature	48
MUTE button	48

O P

ON-timer	46
Picture adjustments	
COLOR TEMPERATURE	43
FLESH TONE	42
Picture mode	41
Picture quality	41
Picture-out-picture (POP)	
CH SCAN button	33
FREEZE button	32
POP CH ▼▲ buttons	31
POP DIRECT CH button	31
SOURCE button	31
SPLIT button	31
SWAP button	32
POP (also see “Picture-out-picture”)	31

Q R

Quick connect guide	23
RECALL button	52
Remote control	
Battery installation	15
Learning about the buttons	19
Programming	16
RESET	43, 50

S

SAP sound	48
Satellite receiver connection	9
Set-top box	11
Size of Double-Window, adjusting	32
Sleep timer	46
Sound quality adjustments	49
SPEAKERS on/off	51
Specifications	54
SpeedSurf mode	24
SRS 3D surround	49
StableSound®	52
Stereo sound	48
Sub-bass system (SBS)	50
SurfLock™	25
S-video cables	7

T

Tilt correction	24
Troubleshooting	55
TruBass feature	49
TV/VIDEO button	25, 44

V

V-CHI P	
BLOCKING OPTION	37
ENABLE BLOCKING	36
MPAA RATING	37
NEW PIN CODE	40
TV RATING	36
Unlocking programs temporarily	38
VCR connection	7
VIDEO LABEL	44
VIDEO LOCK	39

W

Warranty	56, 57
WOW surround sound feature	49

TOSHIBA AMERICA CONSUMER PRODUCTS, INC.

HEAD OFFICE: 82 TOTOWA ROAD, WAYNE, NJ 07470, U.S.A.
NATIONAL SERVICE DIVISION: 1420-B TOSHIBA DRIVE, LEBANON, TN 37087, U.S.A.

TOSHIBA HAWAII, INC.

HEAD OFFICE: 327 KAMAKEE STREET, HONOLULU, HI 96814, U.S.A. – TEL: (808) 591-9281

TOSHIBA OF CANADA LTD.

HEAD OFFICE: 191 McNABB STREET, MARKHAM, ONTARIO, L3R 8H2, CANADA – TEL: (905) 470-5400

SERVICE CENTERS:

TORONTO: 191 McNABB STREET, MARKHAM, ONTARIO L3R 8H2, CANADA – TEL: (905) 470-5400

MONTREAL: 1643 NORTH SERVICE RD., TRANS-CANADA HIGHWAY, DORVAL QUEBEC, H9P 1J1, CANADA – TEL: (514) 856-4100

VANCOUVER: 22171 FRASERWOOD WAY, RICHMOND, B.C., V6W 1J5, CANADA – TEL: (604) 303-2500

MANUFACTURED BY

TOSHIBA AMERICA CONSUMER PRODUCTS, INC.

ColorStream and StableSound are registered trademarks of Toshiba America Consumer Products, Inc.
CableClear and SurfLock are trademarks of Toshiba America Consumer Products, Inc.

PRINTED IN USA
(03-06)

TOSHIBA

Free Manuals Download Website

<http://myh66.com>

<http://usermanuals.us>

<http://www.somanuals.com>

<http://www.4manuals.cc>

<http://www.manual-lib.com>

<http://www.404manual.com>

<http://www.luxmanual.com>

<http://aubethermostatmanual.com>

Golf course search by state

<http://golfingnear.com>

Email search by domain

<http://emailbydomain.com>

Auto manuals search

<http://auto.somanuals.com>

TV manuals search

<http://tv.somanuals.com>