

TOSHIBA

OWNER'S MANUAL

Color Television

16:9
WIDE

COLORSTREAM

WOW[™]
by SRS



34HDX82

Owner's Record

The model number and serial number are on the back of your TV. Record these numbers in the spaces below. Refer to these numbers whenever you communicate with your Toshiba dealer about this TV.

Model number:

Serial number:

Introduction

Connecting
your TV

Using the
Remote Control

Setting up
your TV

Using the TV's
Features

Appendix

Index

Dear Customer,

Thank you for purchasing this Toshiba TV. This manual will help you use the many exciting features of your new TV.

Before operating the TV, please read this manual completely, and keep it nearby for future reference.

Safety Precautions

WARNING

TO REDUCE THE RISK OF FIRE OR ELECTRIC SHOCK, DO NOT EXPOSE THIS APPLIANCE TO RAIN OR MOISTURE.

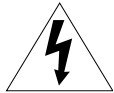

WARNING
RISK OF ELECTRIC SHOCK
DO NOT OPEN



WARNING: TO REDUCE THE RISK OF ELECTRIC SHOCK, DO NOT REMOVE COVER (OR BACK). NO USER-SERVICEABLE PARTS INSIDE. REFER SERVICING TO QUALIFIED SERVICE PERSONNEL.



The lightning symbol in the triangle tells you that the voltage inside this product may be strong enough to cause an electric shock. **DO NOT TRY TO SERVICE THIS PRODUCT YOURSELF.**



The exclamation mark in the triangle tells you that important operating and maintenance instructions follow this symbol.

NOTE TO CATV INSTALLERS IN THE USA

This is a reminder to call the CATV system installer's attention to Article 820-40 of the NEC, which provides guidelines for proper grounding and, in particular, specifies that the cable ground shall be connected to the grounding system of the building, as close to the point of cable entry as practical. For additional antenna grounding information, see items 24 and 25 on page 4.

NOTICE OF POSSIBLE TV STAND INSTABILITY



DANGER: RISK OF SERIOUS PERSONAL INJURY OR DEATH!

Use this TV with the TOSHIBA TV stand recommended in the "Specifications" section only. Use with other stands may result in instability, causing possible injury or death.

NOTICE OF POSSIBLE ADVERSE EFFECTS ON TV PICTURE TUBE

If a fixed (non-moving) pattern remains on the TV screen for long periods of time, the image can become permanently engrained in the picture tube. **This type of damage is NOT COVERED BY YOUR WARRANTY.** See item 32 on page 4.

Child Safety

It Makes A Difference Where Your TV Stands



Congratulations on your purchase! As you enjoy your new TV, keep these safety tips in mind:

The Issue

- If you are like most Americans, you have a TV in your home. Many homes, in fact, have more than one TV.
- The home theater entertainment experience is a growing trend, and larger TVs are popular purchases; however, they are not always supported on the proper TV stands.
- Sometimes TVs are improperly secured or inappropriately situated on dressers, bookcases, shelves, desks, audio speakers, chests, or carts. As a result, TVs may fall over, causing unnecessary injury.

Toshiba Cares!

- The consumer electronics industry is committed to making home entertainment enjoyable and safe.
- The Consumer Electronics Association formed the Home Entertainment Support Safety Committee, comprised of TV and consumer electronics furniture manufacturers, to advocate children's safety and educate consumers and their families about television safety.

Tune Into Safety

- One size does NOT fit all! Use appropriate furniture large enough to support the weight of your TV (and other electronic components).
- Use appropriate angle braces, straps, and anchors to secure your furniture to the wall (but never screw anything directly into the TV).
- Carefully read and understand the other enclosed instructions for proper use of this product.
- Do not allow children to climb on or play with furniture and TVs.
- Avoid placing any item on top of your TV (such as a VCR, remote control, or toy) that a curious child may reach for.
- Remember that children can become excited while watching a program and can potentially push or pull a TV over.
- Share our safety message about this hidden hazard of the home with your family and friends. Thank you!



2500 Wilson Blvd.
Arlington, VA 22201 U.S.A.
Tel. 703-907-7600 Fax 703-907-7690
www.CE.org

CEA is the Sponsor, Producer and Manager of the International CES®

05/02.2

Important Safety Instructions

- 1) **Read these instructions.**
- 2) **Keep these instructions.**
- 3) **Heed all warnings.**
- 4) **Follow all instructions.**



- 5) **Do not use this apparatus near water.**



- 6) **Clean only with a dry cloth.**

- 7) **Do not block any ventilation openings.** Install in accordance with the manufacturer's instructions.



- 8) **Do not install near any heat sources** such as radiators, heat registers, stoves, or other apparatus (including amplifiers) that produce heat.



- 9) **Do not defeat the safety purpose of the polarized or grounding type plug.** A polarized plug has two blades with one wider than the other. A grounding type plug has two blades and a third grounding prong. The wide blade or the third prong are provided for your safety. If the provided plug does not fit into your outlet, consult an electrician for replacement of the obsolete outlet.

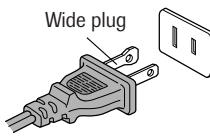

CAUTION: To reduce the risk of electric shock, do not use the polarized plug with an extension cord, receptacle, or other outlet unless the blades can be inserted completely to prevent blade exposure.

- 10) **Protect the power cord** from being walked on or pinched, particularly at plugs, convenience receptacles, and the point where it exits the apparatus.

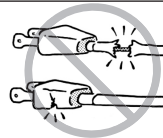

- 11) **Only use attachments/accessories specified by the manufacturer.**

- 12) **Use only with the cart, stand, tripod, bracket, or table specified by the manufacturer, or sold with the apparatus.** When a cart is used, use caution when moving the cart/apparatus combination to avoid injury from tip-over.



- 13) **Unplug this apparatus during lightning storms or when unused for long periods of time.**



- 14) **Refer all servicing to qualified service personnel.**

Servicing is required when the apparatus has been damaged in any way, such as power supply cord or plug is damaged, liquid has been spilled or objects have fallen into the apparatus, the apparatus has been exposed to rain or moisture, does not operate normally, or has been dropped.



05/02.2

Installation, Care, and Service

Installation

Follow these recommendations and precautions and heed all warnings when installing your TV:

- 15) Never modify this equipment. Changes or modifications may void: a) the warranty, and b) the user's authority to operate this equipment under the rules of the Federal Communications Commission.

- 16) **DANGER: RISK OF SERIOUS PERSONAL INJURY, DEATH, OR EQUIPMENT DAMAGE!** Never place the TV on an unstable cart, stand, or table. The TV may fall, causing serious personal injury, death, or serious damage to the TV.



- 17) Never place or store the TV in direct sunlight; hot, humid areas; areas subject to excessive dust or vibration; or locations with temperatures at or below 41°F (5°C).

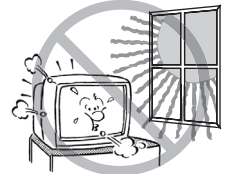

- 18) Always place the TV on the floor or a sturdy, level, stable surface that can support the weight of the unit.



- 19) Never place items such as vases, aquariums, or candles on top of the TV.



- 20) Never block or cover the slots or openings in the TV cabinet back, bottom, and sides. Never place the TV:
 - on a bed, sofa, rug, or similar surface;
 - too close to drapes, curtains, or walls; or
 - in a confined space such as a bookcase, built-in cabinet, or any other place with poor ventilation.

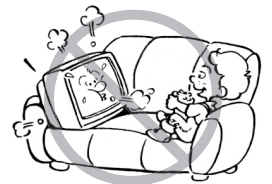

The slots and openings are provided to protect the TV from overheating and to help maintain reliable operation of the TV.



- 21) Never allow anything to rest on or roll over the power cord, and never place the TV where the power cord is subject to wear or abuse.

- 22) Never overload wall outlets and extension cords.



- 23) Always operate this equipment from a 120 VAC, 60 Hz power source only.



- 24) Always make sure the antenna system is properly grounded to provide adequate protection against voltage surges and built-up static charges (see Section 810 of the National Electric Code).

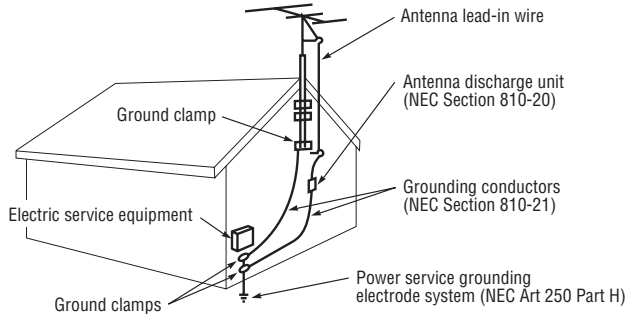

- 25) **! DANGER: RISK OF SERIOUS PERSONAL INJURY OR DEATH!**
- Use extreme care to make sure you are never in a position where your body (or any item you are in contact with, such as a ladder or screwdriver) can accidentally touch overhead power lines. Never locate the antenna near overhead power lines or other electrical circuits.
 - Never attempt to install any of the following during lightning activity:
 - a) an antenna system; or b) cables, wires, or any home theater component connected to an antenna or phone system.

Care

For better performance and safer operation of your TOSHIBA TV, follow these recommendations and precautions:

- 26) Always sit approximately 10–25 feet away from the TV and as directly in front of it as possible. The picture can appear dull if you sit too far to the left or right of the TV, or if sunlight or room lights reflect on the screen. Turn the TV off to check for reflections on the screen, and then remove the source of reflections while viewing the TV.

- 27) Always unplug the TV before cleaning. Never use liquid or aerosol cleaners.

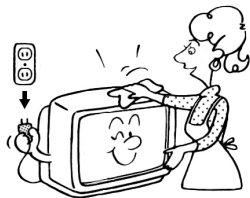

- 28) **! WARNING: RISK OF ELECTRIC SHOCK!** Never spill liquids or push objects of any kind into the TV cabinet slots.

- 29) [This item applies to projection TVs only.] If the air temperature rises suddenly (for example, when the TV is first delivered), condensation may form on the lenses. This can make the picture appear distorted or the color appear faded. If this happens, turn off the TV for 6 to 7 hours to allow the condensation to evaporate.

- 30) For added protection of your TV from lightning and power surges, always unplug the power cord and disconnect the antenna from the TV if you leave the TV unattended or unused for long periods of time.

- 31) During normal use, the TV may make occasional snapping or popping sounds. This is normal, especially when the unit is being turned on or off. If these sounds become frequent or continuous, unplug the power cord and contact a Toshiba Authorized Service Center.

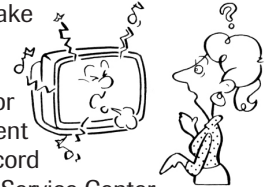

- 32) **Possible Adverse Effects on TV Picture Tube:** If a fixed (non-moving) pattern remains on the TV screen for long periods of time, the image can become permanently engrained in the picture tube and cause subtle but permanent ghost images. **This type of damage is NOT COVERED BY YOUR WARRANTY.** Never leave your TV on for long periods of time while it is displaying the following formats or images:

- **Fixed Images**, such as PIP/POP windows, stock tickers, video game patterns, TV station logos, and websites.
- **Special Formats** that do not use the entire screen. For example, viewing letterbox style (16:9) media on a normal (4:3) display (gray bars at top and bottom of screen); or viewing normal style (4:3) media on a widescreen (16:9) display (gray bars on left and right sides of screen).

Service

- 33) **! WARNING: RISK OF ELECTRIC SHOCK!** Never attempt to service the TV yourself. Opening and removing the covers may expose you to dangerous voltage or other hazards. Refer all servicing to a Toshiba Authorized Service Center.

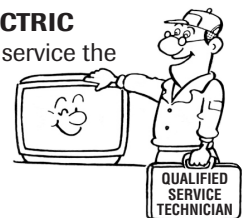

- 34) If you have the TV serviced:

- Ask the service technician to use only replacement parts specified by the manufacturer.
- Upon completion of service, ask the service technician to perform routine safety checks to determine that the TV is in safe operating condition.

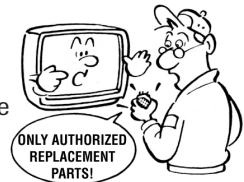

- 35) When the TV reaches the end of its useful life, ask a qualified service technician to properly dispose of the TV. Improper disposal may result in a picture tube implosion and possible personal injury.

Important safety information 2-4

Introduction 6

Welcome to Toshiba 6

Exploring your new TV 6

Note regarding Quick Connect Guide 6

Connecting your TV 7

Note regarding picture quality 7

Connecting a VCR 7

Connecting a cable converter box 8

Connecting a cable converter box and VCR 8

Connecting a DVD player or satellite receiver and a VCR 9

Connecting a DVD player with ColorStream® (component video) and a VCR 10

Connecting a DTV receiver/set-top box with ColorStream® (component video) and a VCR 11

Connecting two VCRs 12

Connecting a camcorder 12

Connecting a device to the DVI/HDCP input 13

Connecting an audio system 14

Connecting an A/V receiver 14

Using the remote control 15

Preparing the remote control for use 15

Installing the remote control batteries 15

Remote Control functional key chart 16

Programming the remote control for use with your audio/video devices 18

Device code setup 18

Searching and sampling the code of a device (8500) 18

Using the volume lock feature (8000) 19

Operational feature reset (8900) 19

Device code table 20-21

Learning about the remote control 22

Setting up your TV 23

Note regarding Quick Connect Guide 23

Learning about the menu system 23

Using the Quick Connect Guide 24

Changing the on-screen display language 25

Selecting the antenna input 25

Adding channels to the TV's memory 26

Programming channels automatically 26

Adding and erasing channels manually 27

Changing channels 27

Changing channels using SpeedSurf 27

Adjusting the tilt correction feature 28

Using the TV's features 29

Adjusting the channel settings 29

Switching between two channels using Channel Return 29

Switching between two channels using SurfLock™ 29

Programming your favorite channels 29

Labeling channels 30

Viewing the wide-screen picture formats 32

Selecting the picture size 32

Scrolling the Theater Wide picture (Theater Wide 2 and 3 only) 34

Selecting the cinema mode 34

Using the POP double-window feature 35

Switching the main and POP pictures 36

Freezing the POP picture 36

Using the favorite channel search function 36

Using the LOCKS menu 37

Entering the PIN code 37

If you cannot remember your PIN code 37

Using the V-CHIP menu 38

ENABLE BLOCKING 38

TV RATING (Independent rating system for broadcasters) 38

MPAA RATING (Independent rating system for movies) 39

BLOCKING OPTION 39

Unlocking programs temporarily 40

Locking channels 40

Locking video inputs 41

Using the front panel lock feature 42

Changing the PIN code 42

Adjusting the picture 43

Selecting the picture mode 43

Adjusting the picture quality 43

Saving your new preferences 44

Using the flesh tone feature 44

Using CableClear™ DNR (digital noise reduction) 44

Selecting the scan velocity modulation (SVM) 45

Selecting the color temperature 45

Resetting your picture quality adjustments 45

Selecting the video input source 46

Labeling the video input sources 46

Using the closed caption feature 47

Setting the sleep timer 48

Setting the clock 48

Adjusting the sound 49

Muting the sound 49

Selecting stereo/SAP broadcasts 49

Using the WOW™ surround sound feature 50

Adjusting the sound quality 50

Resetting your audio adjustments 51

Using the CYCLONE® sub-woofer system 51

Turning off the built-in speakers 52

Selecting the Audio OUT sound 52

Using the StableSound® feature 53

Selecting the background of the menu display 53

Displaying on-screen information 53

Viewing the demonstration mode 54

Understanding the auto power off feature 54

Understanding the last mode memory feature 54

Appendix 55

Specifications 55

Troubleshooting 56

Limited United States Warranty 57

Limited Canada Warranty 58

Index 59

Introduction

Welcome to Toshiba

Congratulations! You have purchased one of the finest color TVs on the market. The goal of this manual is to guide you through setting up and operating your Toshiba TV as quickly as possible.

This manual applies to model 34HDX82. The model and serial numbers are on the back of your TV. Record these numbers in the spaces provided on the front cover of this manual for your records. Refer to these numbers whenever you communicate with your Toshiba dealer about this TV.

Instructions in this manual are based on using the remote control. You also can use the controls on the TV if they have the same name as those on the remote control.

Please read all the safety and operating instructions carefully, and keep this manual for future reference.

Exploring your new TV

You can operate your TV using the buttons on the front panel or remote control. The back panel and front panel (behind the door) provide all the terminal connections you will need to connect other equipment to your TV. See "Connecting your TV" on page 7.

Note Regarding Quick Connect Guide

The **Quick Connect Guide** automatically appears on-screen the first time the TV is turned on. This feature provides on-screen instructions to guide you through the initial setup of your TV.

To stop the **Quick Connect Guide**, either press **EXIT** or turn off the TV.

See page 24 for details.

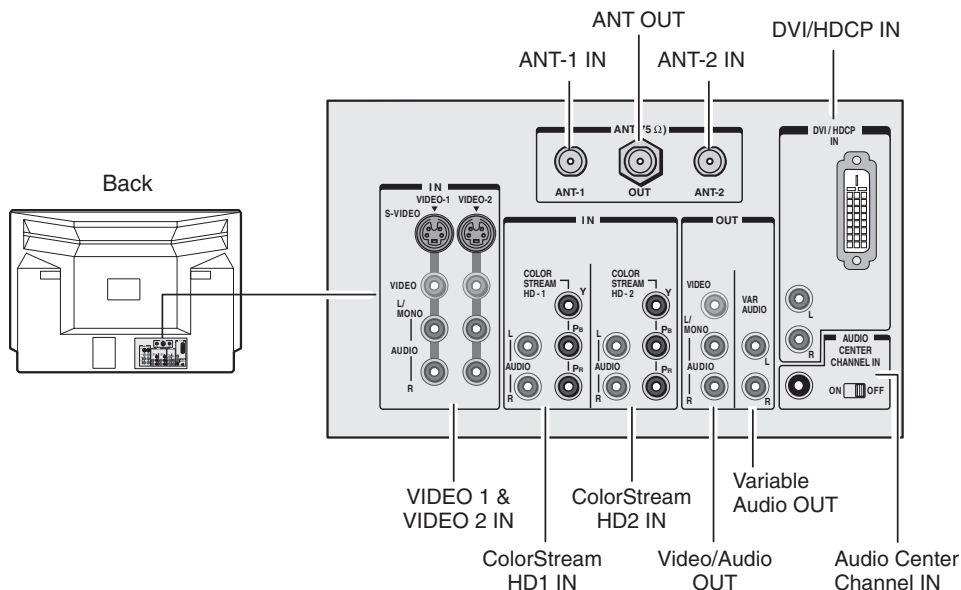
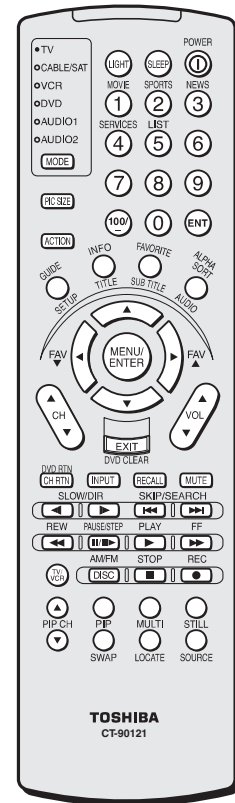
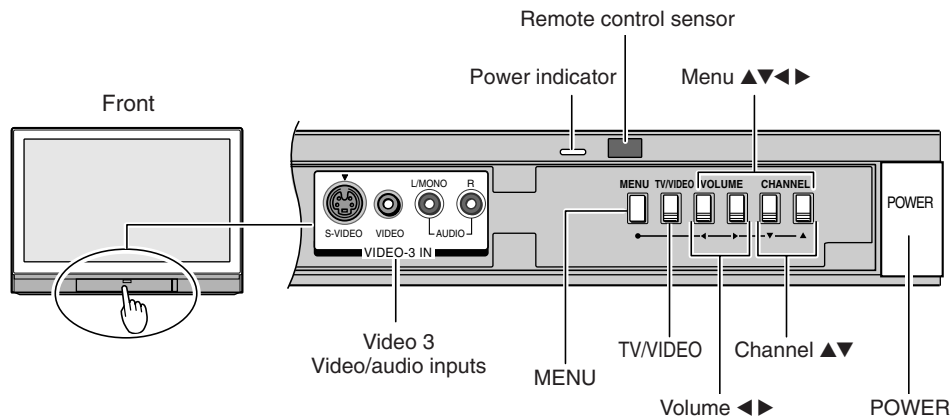

Connecting your TV

Note: Cables are not provided with your TV.

- **Coaxial cable** is the cable that comes in from your antenna, cable TV service, or cable converter box. Coaxial cable uses "F" connectors.
- **Standard stereo A/V cables** usually come in sets of three, and are typically color-coded according to use: yellow for video, red for stereo right audio, and white for stereo left (or mono) audio. Your TV's standard A/V inputs are color-coded in the same manner as the cables.
- **S-video cable** is for use with video equipment that has an S-Video connector.
- **Component video cables** come in sets of three (typically color-coded red, green, and blue), and are for use with video equipment that has component video connectors. Your TV's ColorStream® (component video) inputs are color-coded in the same manner as the cables.
- **DVI-D digital single-link cable** is for use with video equipment that has a DVI-D digital single-link connector (see page 13).

NOTE REGARDING PICTURE QUALITY

When connecting video equipment to your Toshiba TV:

- **For GOOD picture quality:** Use a **standard yellow stereo A/V video cable**.
- **For BETTER picture quality:** If your equipment has an **S-video** connector, use an S-video cable *instead of* a standard yellow video cable. (You still must connect the standard red and white audio cables for full system connection, but *do not connect a standard yellow video cable at the same time* or the picture performance will be unacceptable.)
- **For BEST picture quality:** If your equipment has **component video** connectors, use component video cables *instead of* a standard yellow video cable or S-video cable (plus the standard red and white audio cables for full system connection.) If your equipment has a **DVI-D digital single-link connector**, use a DVI-D cable (plus standard red and white audio cables connected to "DVI/HDCP IN" for full system connection).

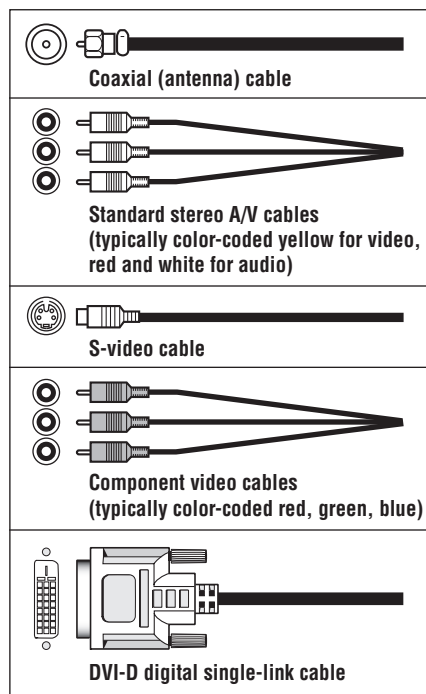

CAUTION: Do not plug in any power cords until you have finished connecting all equipment.

Connecting a VCR

This connection allows you to watch local channels and video programs, record on the VCR while watching TV, and record one channel while watching another channel.

You will need:

- two coaxial cables
- one set of standard A/V cables

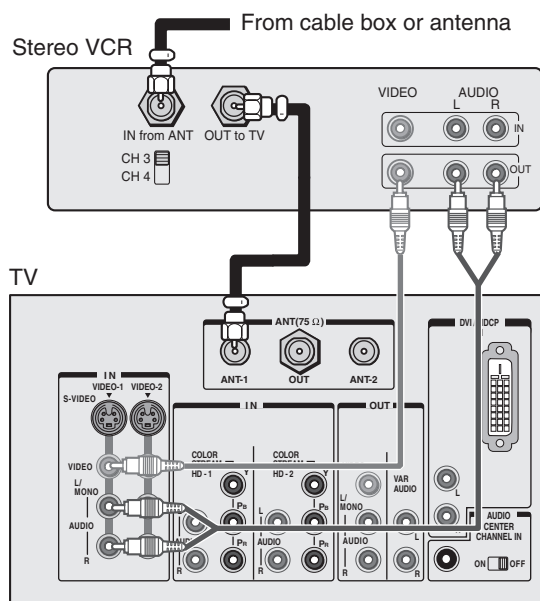

Note:

If you have a mono VCR, connect L/Mono to VCR Audio OUT using only one audio cable.

If you have an S-VHS VCR, use an S-video cable instead of a standard video cable.

Do not connect a standard video cable and an S-video cable to Video-1 (or Video-2) at the same time, or the picture performance will be unacceptable.

The unauthorized recording, use, distribution, or revision of television programs, videotapes, DVDs, and other materials is prohibited under the Copyright Laws of the United States and other countries, and may subject you to civil and criminal liability.

Connecting a cable converter box

This connection allows you to watch basic and premium cable channels.

To use the TV's features, select ANT-1. To view premium channels, select ANT-2, tune the TV to channel 3 or 4 (whichever channel is vacant in your area), and use the converter box to change channels.

You will need:

- three coaxial cables

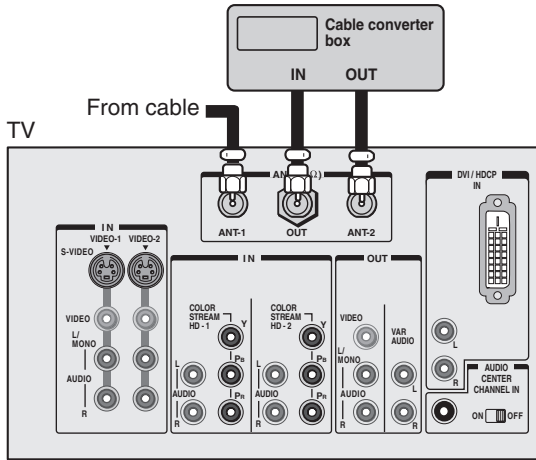

Note:

When you use a converter box with your TV, the remote control will not operate some features, such as programming your favorite channels, labeling channels, and locking channels.

Connecting a cable converter box and a VCR

This connection allows you to watch and record basic and premium cable channels, watch videotapes, and record one channel while watching another channel. To use the TV's features, select ANT-1. To view or record premium channels with the VCR, select ANT-2, tune the TV to channel 3 or 4 (whichever channel is vacant in your area), and use the converter box to change channels.

You will need:

- four coaxial cables
- one set of standard A/V cables

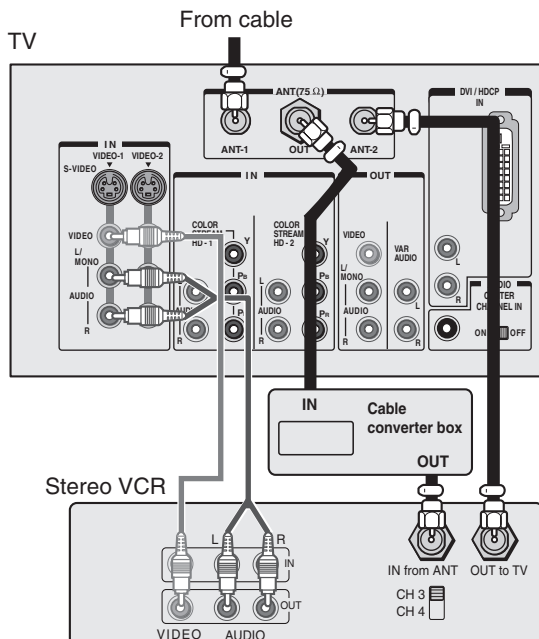

Note:

If you have a mono VCR, connect L/Mono to VCR Audio OUT using only one audio cable.

If you have an S-VHS VCR, use an S-video cable instead of a standard video cable. Do not connect a standard video cable and an S-video cable to Video-1 (or Video-2) at the same time, or the picture performance will be unacceptable.

When you use a converter box with your TV, the remote control will not operate some features, such as programming your favorite channels, labeling channels, and locking channels.

The unauthorized recording, use, distribution, or revision of television programs, videotapes, DVDs, and other materials is prohibited under the Copyright Laws of the United States and other countries, and may subject you to civil and criminal liability.

Connecting a DVD player or satellite receiver and a VCR

This connection allows you to watch DVD/satellite, VCR, and TV programs, and record one TV channel while watching another channel.

You will need:

- two (or three, if satellite receiver is used) coaxial cables
- two sets of standard A/V cables
- one pair of standard audio cables
- one S-video cable

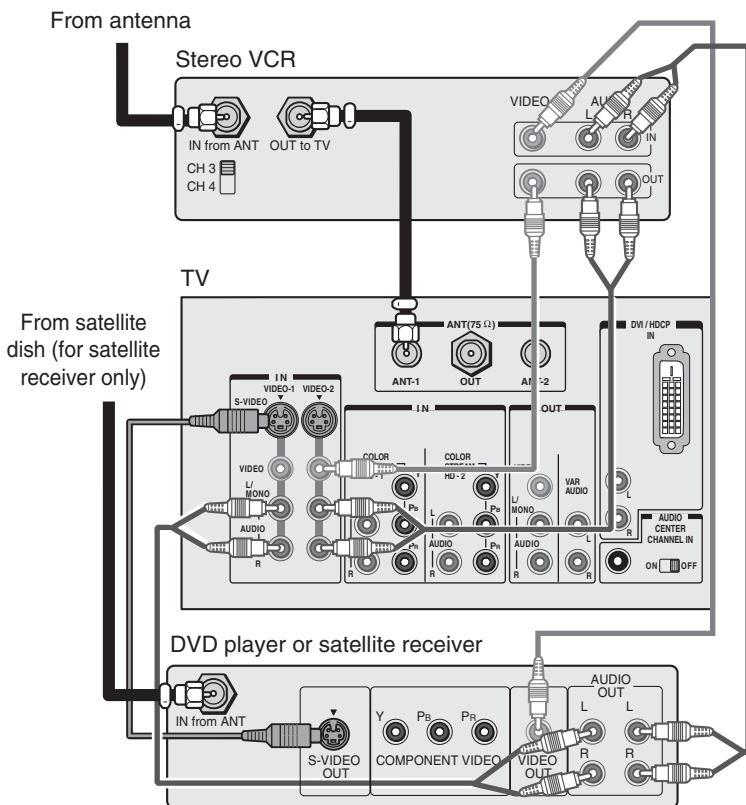

Note:

For the highest possible picture quality from a DVD player or satellite receiver without component video or DVI/HDCP, use an S-video cable. (If your DVD player has component video, see page 10. If your set-top box has component video, see page 11. If your DVD player or satellite receiver has DVI/HDCP, see page 13.)

Do not connect both an S-video cable and a standard video cable between the TV and DVD player/satellite receiver at the same time, or the picture performance will be unacceptable.

Do not connect the DVD player/satellite receiver and VCR to the same video channel on the TV. (The illustration at left shows the DVD player/satellite receiver connected to Video-1 on the TV, and the VCR connected to Video-2 on the TV.)

The unauthorized recording, use, distribution, or revision of television programs, videotapes, DVDs, and other materials is prohibited under the Copyright Laws of the United States and other countries, and may subject you to civil and criminal liability.

Connecting a DVD player with ColorStream® (component video) and a VCR

This connection allows you to watch DVD, VCR, and TV programs, and record TV programs.

Your TV has ColorStream® (component video) inputs. Connecting your TV to a DVD player with component video (such as a Toshiba DVD player with ColorStream®) can greatly enhance picture quality and realism.

To record one TV program while watching another TV program, tune the VCR to the channel to record, and tune the TV to the channel to watch.

To record a TV program while watching a DVD, tune the VCR to the channel to record, and select ColorStream HD1 on the TV (see "Selecting the antenna input" on page 25).

You will need:

- two coaxial cables
- one set of standard A/V cables
- one pair of standard audio cables
- one set of component video cables

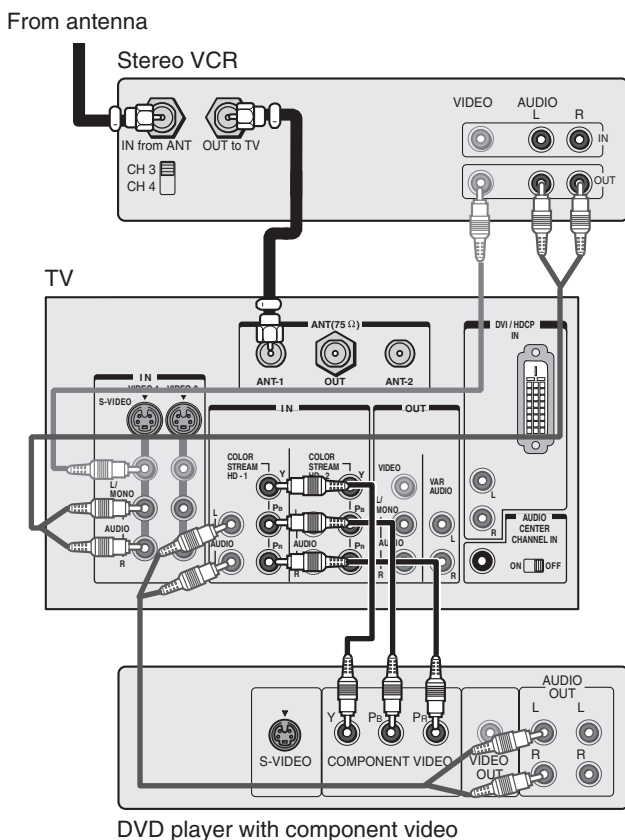

Note:

For the highest possible picture quality, use component video cables (or a DVI-D digital single-link cable) between the TV and DVD player.

You can connect component video cables to either ColorStream jack on the TV (HD1 or HD2).

For DVI/HDCP connection, see page 13.

The ColorStream HD1/HD2 and DVI/HDCP jacks can be used with Progressive (480p, 720p) and Interlaced (480i, 1080i) scan systems; however, a 1080i signal will provide the best picture performance.

If your DVD player is not compatible with component video or DVI/HDCP, use the S-video connections (plus the standard audio connections) instead (see page 9).

The unauthorized recording, use, distribution, or revision of television programs, videotapes, DVDs, and other materials is prohibited under the Copyright Laws of the United States and other countries, and may subject you to civil and criminal liability.

Connecting a DTV receiver/set-top box with ColorStream® (component video) and a VCR

This connection allows you to watch DTV (digital TV), VCR, and TV programs, and record DTV and TV programs.

Your TV has ColorStream (component video) inputs. Connecting your TV to a DTV receiver/set-top box with component video can greatly enhance picture quality and realism.

To record and watch a DTV program, select LINE IN on the VCR, and select ColorStream HD2 (or VIDEO 1 for a non-ColorStream connection) on the TV (see "Selecting the antenna input" on page 25).

To record a TV program while watching a DTV program, tune the VCR to the channel to record, and select ColorStream HD2 on the TV.

To record and watch the same TV program, tune the VCR to the channel to record, and select VIDEO 1 on the TV.

To record one TV program while watching another TV program, tune the VCR to the channel to record, and tune the TV to the channel to watch.

You will need:

- three coaxial cables
- two sets of standard A/V cables
- one pair of standard audio cables
- one set of component video cables

Note:

For the highest possible picture quality, use component video cables (or a DVI-D digital single-link cable) between the TV and DTV receiver/set-top box.

You can connect component video cables to either ColorStream jack on the TV (HD1 or HD2).

For DVI/HDCP connection, see page 13.

The ColorStream HD1/HD2 and DVI/HDCP jacks can be used with Progressive (480p, 720p) and Interlaced (480i, 1080i) scan systems; however, a 1080i signal will provide the best picture performance.

If your DTV receiver or set-top box is not compatible with component video or DVI/HDCP, use the S-video connections (plus the standard audio connections) instead (see page 9).

To monitor recording, set the TV to VIDEO 1.

The unauthorized recording, use, distribution, or revision of television programs, videotapes, DVDs, and other materials is prohibited under the Copyright Laws of the United States and other countries, and may subject you to civil and criminal liability.

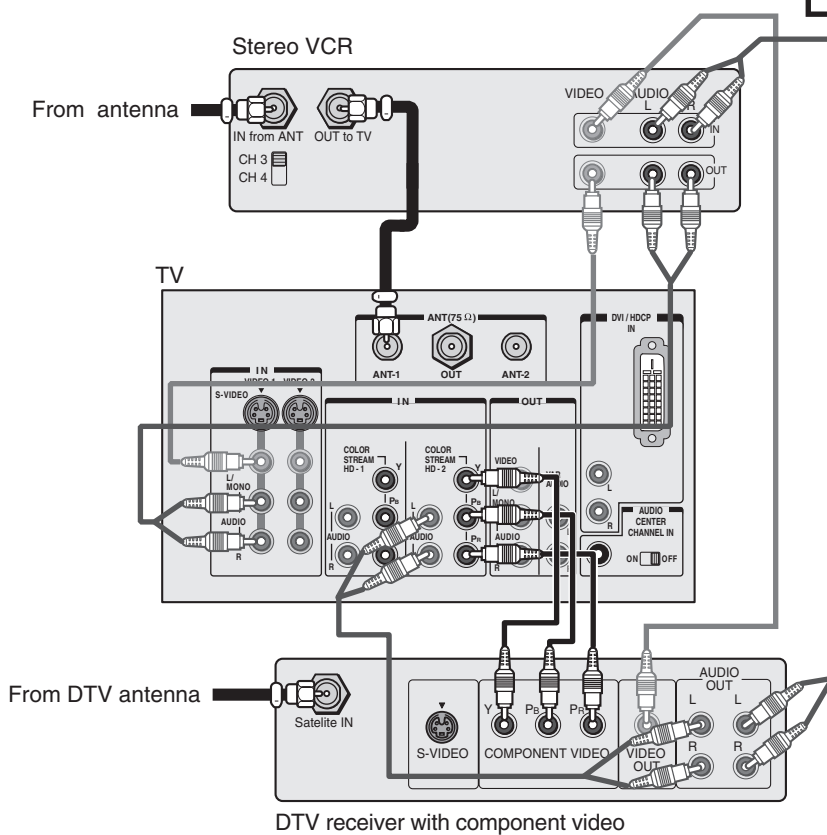

DTV receiver with component video

Connecting two VCRs

This connection allows you to record (dub/edit) from one VCR to another VCR while watching a videotape. You can also record one TV channel while watching another TV channel.

You will need:

- two coaxial cables
- two sets of standard A/V cables

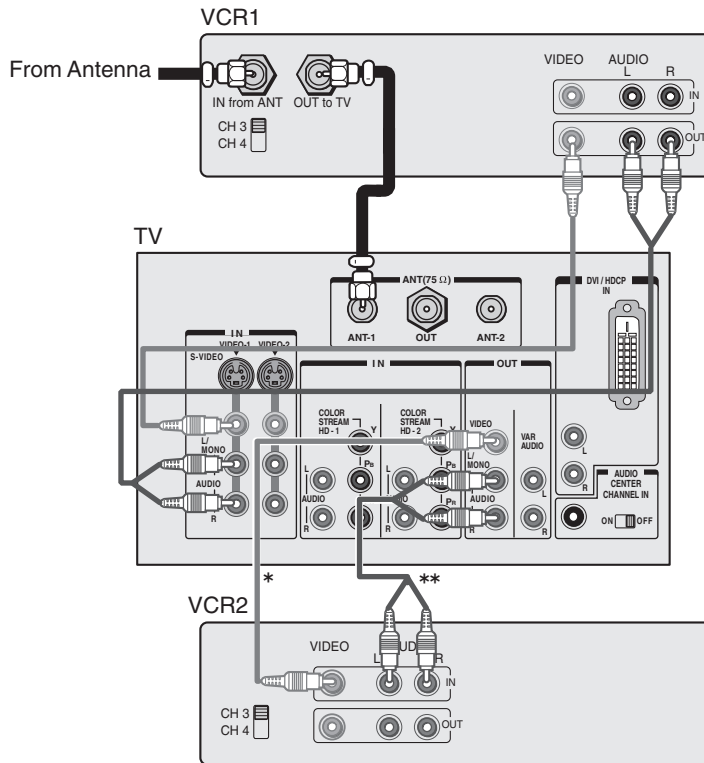

Note:

If you have S-VHS VCRs, use S-video cables instead of standard video cables for better picture performance. Do not connect both a standard video cable and an S-video cable to Video-1 (or Video-2) at the same time, or the picture performance will be unacceptable.

Do not connect the same VCR to the output and input jacks on the TV at the same time.

To dub or edit, VCR 2 must select Line IN, and the TV must select VIDEO 1 (see "Selecting the antenna input" on page 25).

* The Video OUT jack does not output the POP picture.

** The Audio OUT jacks can output the sound of either the Main or POP picture (see "Selecting the Audio OUT sound" on page 52).

The unauthorized recording, use, distribution, or revision of television programs, videotapes, DVDs, and other materials is prohibited under the Copyright Laws of the United States and other countries, and may subject you to civil and criminal liability.

Connecting a camcorder

This connection allows you to watch video materials recorded on a camcorder.

You will need:

- one set of standard A/V cables

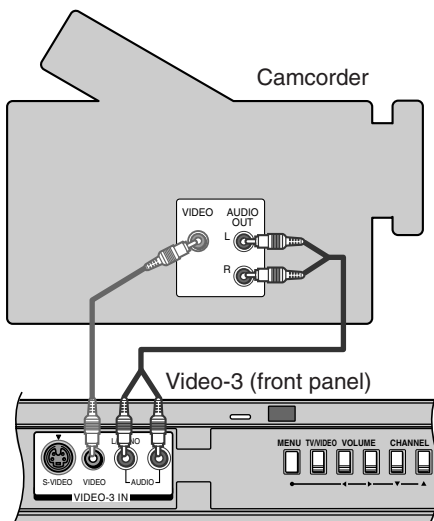

Note:

If you have an S-VHS camcorder, use an S-video cable instead of the standard video cable. Do not connect both a standard video cable and an S-video cable at the same time, or the picture performance will be unacceptable.

Connecting a device to the DVI/HDCP¹ input

The DVI/HDCP input on your TV is designed to accept HDCP program material in digital form from EIA/CEA-861-compliant² consumer electronic devices, such as a set-top box or DVD player equipped with a DVI-D digital single-link output connection.³

The DVI/HDCP input is designed for best performance with 1080i high-definition video signals. The DVI/HDCP input also will accept and display 480p, 720p, and 480i picture signals.

Note: *This TV is not intended for connection to and should not be used with a PC (personal computer).*

You will need:

- one coaxial cable
- one DVI-D digital single-link cable

Note: *For proper operation, the DVI-D cable length should not exceed 3m (9.8 ft). The recommended length is 2m (6.6 ft).*

- one pair of standard audio cables

DVI/HDCP device
(for example, set-top box or DVD player)

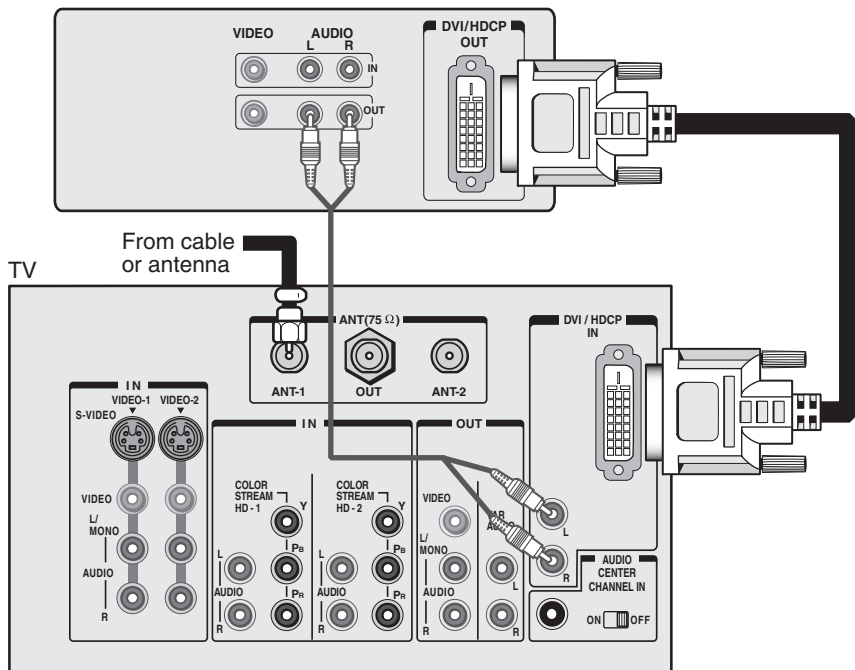

Notes

¹ DVI/HDCP = Digital Visual Interface/ High-bandwidth Digital Content Protection.

² EIA/CEA-861 compliance covers the transmission of uncompressed digital video with high-bandwidth digital content protection, which is being standardized for future reception of high-definition video signals.

³ Consult your consumer electronics dealer for availability.

Caution

To ensure that the DVI/HDCP device is reset properly, it is recommended that you follow these procedures:

- When turning on your electronic components, **turn on the TV first**, and then the DVI/HDCP device.
- When turning off your electronic components, **turn off the DVI/HDCP device first**, and then the TV.

Connecting an audio system

This connection allows you to use an audio amplifier to adjust the audio level. This also allows you to use external speakers.

To control the audio, turn on the TV and the stereo amplifier, and turn off the built-in speakers (see “Turning off the built-in speakers” on page 52).

You will need:

- one pair of audio cables

Note:

To hear sound when using an external audio amplifier, the volume of both the TV and the amplifier must be set above 0 (zero).

For example, if the volume of the TV is set to 0, you will not be able to hear any sound, even the volume of the amplifier is at its highest level.

TV

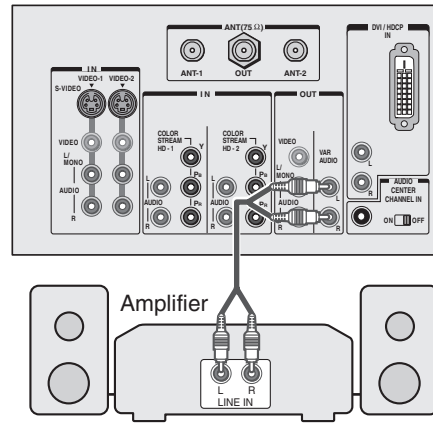

Connecting an A/V receiver

This connection allows you to use an audio/video (A/V) receiver to enhance your TV's sound.

If you have a system with Dolby Pro Logic® surround sound, you can add to the realism of the sound by using the TV's internal speakers as center channel speakers.

You will need:

- one coaxial cable
- one set of standard A/V cables
- one single audio cable for the audio center channel

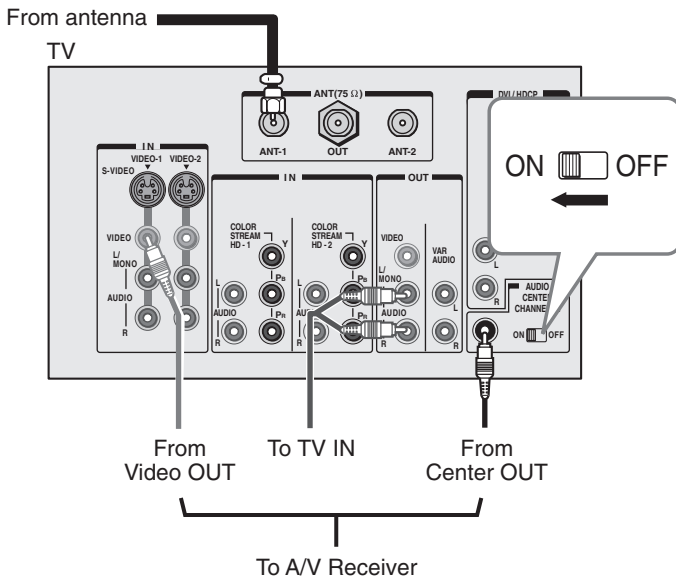

Note:

Refer to the instructions provided with your A/V receiver for details about your surround sound system.

When the Audio Center Channel ON/OFF switch is in the ON position, the TV speakers will function only as center channel speakers.

Adjust the volume for the center channel speakers using the center level control on the A/V receiver.

To use the TV speakers as normal speakers, set the Audio Center Channel ON/OFF switch to the OFF position.

Caution:

To avoid damaging the TV speakers:

- Turn off the TV before connecting or disconnecting the Audio Center Channel cable.
- Do not connect from the A/V receiver's Center Speaker OUT (amplified signal) to the TV's Audio Center Channel IN.

Dolby Pro Logic* surround sound system connection example

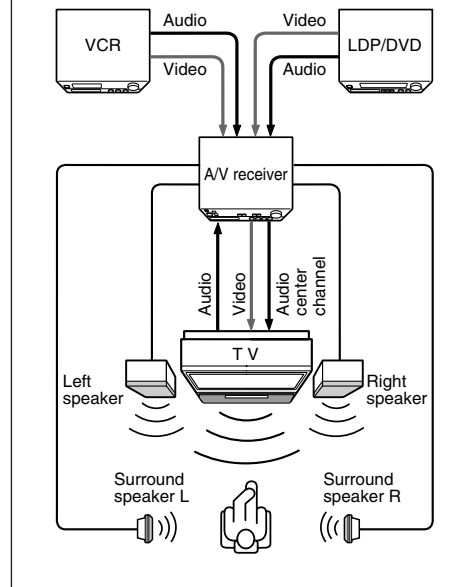

*Dolby Pro Logic is a registered trademark of Dolby Laboratories Licensing Corporation.

Using the remote control

Preparing the remote control for use

Your Toshiba TV remote control has one dedicated TV mode and five universal modes: VCR, Cable/SAT, DVD, Audio1, and Audio2. The target devices and default devices being programmed for each mode are as follows:

Target device/Mode mapping

Mode	Device
TV	Toshiba TV
CABLE/SAT	Universal Cable, Satellite
VCR	Universal VCR, DVD, LD, Cassette
DVD	Universal DVD, VCR, LD, Cassette
AUDIO1	Universal Audio: Amp., Tuner, Misc.Audio, CD/MD
AUDIO2	Universal Audio: CD/MD, Amp., Tuner, Misc.Audio

Default device codes

Mode	Default device
TV	Toshiba TV
CABLE/SAT	Toshiba Satellite receiver
VCR	Toshiba VCR
DVD	Toshiba DVD
AUDIO1	Pioneer Audio receiver
AUDIO2	Pioneer LD

Repeatedly press MODE to cycle among the modes. If you own different brands of audio/video devices, you must first program your remote control (see "Programming the remote control for use with your audio/video devices" on page 18).

Installing the remote control batteries

To install the batteries:

- Slide the battery cover off the back of the remote control.

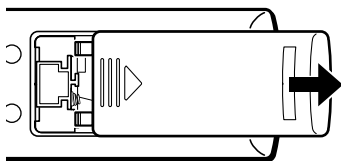

- Install two "AA" size alkaline batteries. Match the + and - signs on the batteries to the signs on the battery compartment.

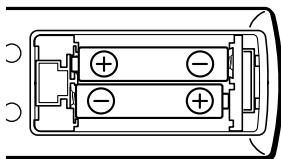

- Slide the battery cover back on to the remote control until the lock snaps.

Note:

Your TV's remote control may not operate certain features on your VCR, cable TV converter, or other electronic device.

Refer to the owner's manuals for your other devices to determine their available features. If your TV's remote control does not operate a specific feature on a device, use the remote control that came with the device.

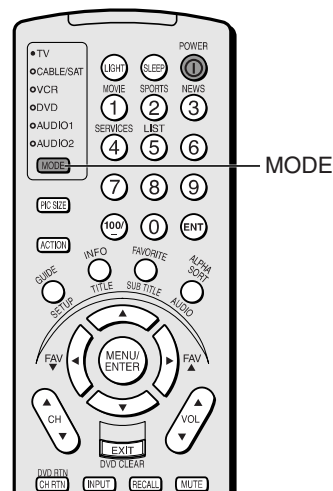

Caution:

- Dispose of batteries in a designated disposal area. Do not throw batteries into a fire.
- Do not mix battery types or combine used batteries with new ones.
- If the batteries are dead or if you will not use the remote control for a long time, remove the batteries to prevent battery acid from leaking into the battery compartment.

Note:

- Battery life expectancy is about one year with normal use.

Remote Control functional key chart

Key Label	Toshiba TV (TV)	Cable (CBL/SAT)	Satellite (CBL/SAT)	VCR	DVD/LD	Receiver (AUDIO)	CD/MD (AUDIO)	Cassette (VCR)
LIGHT	Lights the remote key, and toggles between enabled and disabled Illumination mode.							
SLEEP	Sleep timer	---	---	---	---	---	---	---
POWER	Power	Power	Power	Power	Power	Power	Power	Power
1/MOVIE	Digit 1	Digit 1	Digit 1	Digit 1	Digit 1	AV input 1	Digit 1	Digit 1
2/SPORTS	Digit 2	Digit 2	Digit 2	Digit 2	Digit 2	AV input 2	Digit 2	Digit 2
3/NEWS	Digit 3	Digit 3	Digit 3	Digit 3	Digit 3	AV input 3	Digit 3	Digit 3
4/SERVICES	Digit 4	Digit 4	Digit 4	Digit 4	Digit 4	AV input 4	Digit 4	Digit 4
5/LIST	Digit 5	Digit 5	Digit 5	Digit 5	Digit 5	CD	Digit 5	Digit 5
6	Digit 6	Digit 6	Digit 6	Digit 6	Digit 6	Tuner	Digit 6	Digit 6
MODE	Remote control device mode selection							
PIC SIZE	Selects the image shape.	← TV	← TV	← TV	← TV	← TV	← TV	← TV
7	Digit 7	Digit 7	Digit 7	Digit 7	Digit 7	Phono	Digit 7	Digit 7
8	Digit 8	Digit 8	Digit 8	Digit 8	Digit 8	Cassette	Digit 8	Digit 8
9	Digit 9	Digit 9	Digit 9	Digit 9	Digit 9	Aux	Digit 9	Digit 9
ACTION	---	---	Action, Menu	---	Menu	---	---	---
100/-	100	---	100	100	100	100	100	100
0	Digit 0	Digit 0	Digit 0	Digit 0	Digit 0	Digit 0	Digit 0	Digit 0
ENT	---	CH Enter	CH Enter	CH Enter	---	---	---	---
GUIDE/SETUP	---	---	Guide	---	DVD setup	---	---	---
INFO/TITLE	---	---	INFO	---	TITLE= Top menu	---	---	---
FAVORITE/ SUBTITLE	Favorite CH	---	Favorite CH	---	Subtitle	---	---	---
ALPHASORT/ AUDIO	---	---	Alphasort	---	Audio	---	---	---
MENU/ ENTER	Menu open/ Enter	---	Select	---	Enter	---	---	---
▲▼	Menu select	---	Menu select	---	Menu select	---	---	---
◀▶/FAV ▼▲	Menu select/ FAV ▼▲	---	Menu select	---	Menu select	---	---	---
VOL ▲▼	Volume up/down*	Volume up/down*	Volume up/down*	Volume up/down*	Volume up/down*	Volume up/down*	Volume up/down*	---
EXIT/ DVD CLEAR	Exit	Exit	Exit	Exit	DVD clear	Exit/Clear	Exit/Clear	Exit/Clear
CH ▲▼	Channel up/down	Channel up/down	Channel up/down	Channel up/down	---	Channel up/down	---	---
INPUT	TV/Video select	← TV	← TV	VCR input	← TV	Input	← TV	← TV
MUTE	Sound mute*	Sound mute*	Sound mute*	Sound mute*	Sound mute*	Sound mute*	Sound mute*	---
RECALL	On-screen display	---	On-screen display	On-screen display	On-screen display	---	---	---
CH RTN/ DVD RTN	Previous channel	Previous channel	Previous channel	Previous channel	DVD return	---	---	---
SLOW/ DIR	▶ ◀	---	---	Forward ---	Forward Reverse	---	---	---
SKIP/ SEARCH	▶ ◀	---	---	---	Forward Reverse	---	Forward Reverse	Forward Reverse
REW	VCR →	VCR →	VCR →	Rewind	Rewind	Rewind	Rewind	Rewind
PAUSE/STEP	VCR →	VCR →	VCR →	Pause	Pause	Pause	Pause	Pause
PLAY	VCR →	VCR →	VCR →	Play	Play	Play	Play	Play
FF	VCR →	VCR →	VCR →	F. Forward	F. Forward	F. Forward	F. Forward	F. Forward

Key Label	Toshiba TV (TV)	Cable (CBL/SAT)	Satellite (CBL/SAT)	VCR	DVD/LD	Receiver (AUDIO)	CD/MD (AUDIO)	Cassete (VCR)
TV/VCR	VCR →	---	TV/SAT	TV/VCR	---	---	---	Reverse
AM/FM DISC	---	---	---	---	Disc shift	AM/FM	Disc shift	Deck side A/B switch
STOP	VCR →	VCR →	VCR →	Stop	Stop	Stop	Stop	Stop
REC**	VCR →	VCR →	VCR →	Record**	---	Record**	Record**	Record**
PIP CH ▲▼	PIP channel up/down	← TV	← TV	← TV	← TV	← TV	← TV	← TV
PIP	PIP on/off	← TV	← TV	← TV	← TV	← TV	← TV	← TV
MULTI	Strobe	← TV	← TV	← TV	← TV	← TV	← TV	← TV
STILL	PIP Still	← TV	← TV	← TV	← TV	← TV	← TV	← TV
SWAP	PIP Swap	← TV	← TV	← TV	← TV	← TV	← TV	← TV
LOCATE	PIP Locate	← TV	← TV	← TV	← TV	← TV	← TV	← TV
SOURCE	PIP Source	← TV	← TV	← TV	← TV	← TV	← TV	← TV

Notes:

- “---” will send nothing.
- “← TV” will jump to TV.
- “→VCR” will jump to last active VCR or DVD. Active VCR/DVD is defined as the mode that remains for a minimum of 5 seconds, or if a key is pressed in that mode.
- * The VOLUME and MUTE will jump to “TV” by default. When the volume is unlocked, all the devices will have their own volume. The AUDIO1/2 (Receiver, CD) modes will have their own volume even if Volume Lock is on TV, CABLE/SAT, VCR, or DVD. See “Using the Volume Lock feature” on page 19.
- ** Press the REC button two times within 5 seconds to record each A/V source.

Programming the remote control for use with your audio/video devices

Device code setup

1. Refer to the Device code table on pages 20–21 to find the code for the brand of your device.
If more than one code is listed, try each one separately until you find the one that works.
2. Press MODE until the Mode indicator of the device (CABLE/SAT, VCR, DVD, AUDIO1, AUDIO2) lights up.
3. While holding down the RECALL button, press the Channel Number buttons to enter the four-digit code of your brand of device. If a valid code is entered, the mode indicator will blink twice. If an invalid code is entered, the mode indicator will blink one long blink.
4. Point the remote control at the device and press POWER to test the code.
If the device turns on, you have entered the correct code.
If the device does not respond to the remote control, you may have entered the wrong code. Repeat steps 3 and 4 using another code.
5. Press MODE to select the TV mode to control the TV.

Searching and sampling the code of a device (8500)

If you do not know the device code for a particular target unit, you can cycle the remote control through the available codes for that device mode and sample the functions to find the code that properly operates the target device. The keys available to be sampled, provided they are applicable to that mode, are POWER, 1, VOL ▲, CH ▲, and PLAY. Invalid keys will be ignored while in program mode.

To cycle through each available device code and sample its functions:

1. Press MODE to select the mode you want to set up.
2. While holding down the RECALL button, press 8 –5 –0 –0.
The remote control will enter program mode.
3. Point the remote control at the target device and press POWER (or other function buttons that are available to be sampled).
4. If the device responds to the remote control:
Press RECALL to store the device code.
The mode indicator will blink twice and the remote control will exit the program mode.
If the device does not respond to the remote control:
Press ▲, and then press POWER.
Repeat this step until the device responds to the remote control, and then press RECALL.

Note: When a search cycle is completed, the mode indicator will blink three times. The remote control will begin to cycle through the available codes again. If no key is pressed within 10 seconds while programming, the remote control will exit the program mode and return to the previous code.

Note:

- Every time you replace the batteries, you must reprogram the remote control.
- Some newer VCRs are capable of working on either of two remote codes. These VCRs have a switch labeled "VCR1/VCR2."

If your VCR has this kind of switch and does not respond to any of the codes for your VCR brand, set the switch to the other position (VCR1 or VCR2) and reprogram the remote control

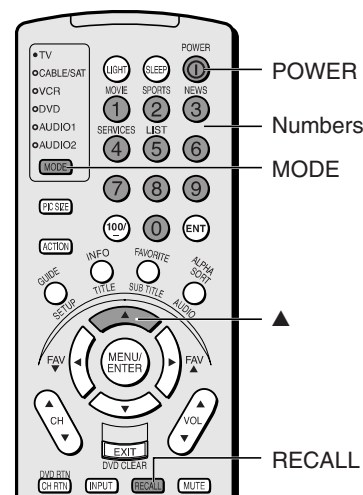

Using the volume lock feature (8000)

For the TV, CABLE/SAT, VCR, and DVD modes, the volume controls (VOL ▲▼ and MUTE) can be programmed (locked) to the selected device mode. This feature does not apply to the AUDIO1/2 modes.

For example, to lock the volume controls to always jump to the CABLE/SAT mode:

1. Repeatedly press MODE to select the CABLE/SAT mode.
 2. While holding down the RECALL button, press 8 -0 -0 -0.
 3. Press VOL ▲.
- The Mode indicator will blink two times (locked).

The following table describes in more detail the Volume Lock implementation.

Volume Locked to	TV	CBL/SAT	VCR	DVD	AUD1	AUD2
TV (default)	TV	TV	TV	TV	AUD1	AUD2
CBL/SAT	CBL/SAT	CBL/SAT	CBL/SAT	CBL/SAT	AUD1	AUD2
VCR	VCR	VCR	VCR	VCR	AUD1	AUD2
DVD	DVD	DVD	DVD	DVD	AUD1	AUD2
AUD1	AUD1	AUD1	AUD1	AUD1	AUD1	AUD1
AUD2	AUD2	AUD2	AUD2	AUD2	AUD2	AUD2

To reset the volume controls to the original device code:

1. While holding down the RECALL button, press 8 -0 -0 -0.
 2. Press VOL ▼.
- The Mode indicator will blink four times (unlocked).

Operational feature reset (8900)

This feature clears all setup features not related to “Device code set up” and resets the Volume Lock to “TV.”

To reset the features:

- While holding down the RECALL button, press 8 -9 -0 -0.
The Mode indicator will blink two times, and then pause and blink two more times.

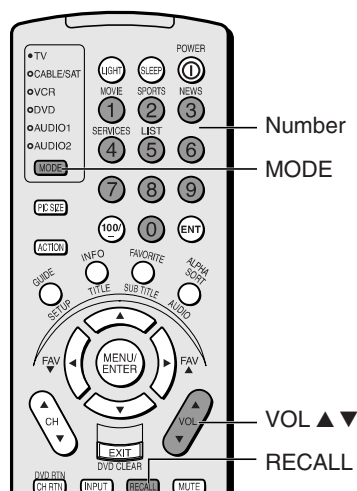

Device code table

VCR setup codes

Brand	Code
ADMIRAL	0135
AIWA	0127, 0132, 0181
AKAI	0129, 0114, 0115, 0116
AUDIO DYNAMIC	0139, 0111
BELL&HOWELL	0105, 0113
BROKSONIC	0120, 0126, 0180
CANON	0123, 0125
CCE	0143
CITIZEN	0106
CRAIG	0105, 0129, 0106
CURTIS MATHES	0145, 0124, 0127
DAEWOO	0143, 0101, 0124, 0175
DBX	0139, 0110, 0111
DIMENSIA	0145
EMERSON	0143, 0126, 0119, 0103, 0125, 0142, 0120, 0118
FISHER	0105, 0108, 0109, 0107, 0113, 0165
FUNAI	0127, 0126, 0120, 0134
GE	0133, 0145, 0124
GO VIDEO	0137, 0151, 0163, 0149, 0150, 0182
GOLDSTAR	0106
GRADIENTE	0170, 0171, 0168, 0134, 0156
HITACHI	0123, 0145, 0100, 0127, 0168
INSTANT REPLAY	0124, 0123
JENSEN	0139
JVC	0139, 0110, 0111, 0134, 0157, 0158, 0184, 0185
KENWOOD	0139, 0110, 0106, 0111
LG	0159
LXI	0127, 0106, 0100, 0107, 0108, 0105, 0109
MAGNAVOX	0131, 0123, 0124, 0173
MARANTZ	0139, 0110, 0111
MARTA	0106
MEMOREX	0124, 0109
MGA	0138, 0140, 0147, 0148, 0141, 0142
MINOLTA	0100, 0145
MITSUBISHI	0138, 0140, 0147, 0148, 0141, 0142, 0161, 0164
MULTITECH	0147, 0127, 0104
NEC	0139, 0110, 0111, 0134
OLYMPIC	0124, 0123
OPTIMUS	0128, 0121, 0135, 0106
ORION	0126, 0120, 0132
PANASONIC	0123, 0124, 0121, 0122
PENNEY	0124, 0100, 0145, 0105, 0139, 0110, 0111
PENTAX	0100, 0111, 0145

PHILCO	0131, 0124, 0127, 0123, 0126, 0120, 0143
PHILIPS	0131, 0123, 0124, 0173
PIONEER	0123
PROSCAN	0145, 0100, 0123, 0124, 0131, 0146, 0101, 0102, 0133, 0174
QUASAR	0121, 0122, 0123, 0124
RADIO SHACK	0133, 0124, 0105, 0136, 0109, 0140, 0127
RCA	0133, 0145, 0100, 0123, 0124, 0131, 0146, 0101, 0102, 0170, 0172, 0174, 0176, 0183
REALISTIC	0124, 0105, 0136, 0109, 0140, 0127
SAMSUNG	0137, 0102, 0104, 0133
SAMTRON	0163
SANSUI	0139, 0126, 0120, 0152
SANYO	0105, 0109, 0113
SCOTT	0101, 0102, 0104, 0109, 0138, 0140, 0147, 0148, 0126, 0120
SEARS	0105, 0106, 0107, 0108, 0100
SHARP	0135, 0136, 0167, 0162
SHINTOM	0117
SIGNATURE 2000	0127, 0135
SINGER	0117
SONY	0128, 0129, 0130, 0153, 0154, 0155
SV2000	0127
SYLVANIA	0131, 0123, 0124, 0127, 0178
SYMPHONIC	0127, 0168, 0177
TASHIRO	0106
TATUNG	0139, 0110, 0111
TEAC	0139, 0110, 0127, 0111
TECHNICS	0121, 0122, 0123, 0124
TEKNICA	0124, 0127, 0112
THOMSON	0179, 0183
TOSHIBA	0101, 0146, 0166, 0160
VECTOR RESEARCH	0111
WARDS	0135, 0136, 0109, 0144, 0106
YAMAHA	0105, 0139, 0110, 0111
ZENITH	0144, 0106, 0169, 0180

Cable box setup codes

Brand	Code
ABC	1124
ARCHER	1132, 1125
CABLEVIEW	1105, 1132
CITIZEN	1122, 1105
CURTIS	1112, 1113
DIAMOND	1124, 1132, 1125
EAGLE	1129
EASTERN	1134
GCBRAND	1132, 1105
GEMINI	1122, 1143
G.I./JERROLD	1119, 1124, 1125, 1126, 1127, 1120, 1121, 1122, 1111, 1123, 1152
HAMLIN	1140, 1141, 1142, 1145, 1118, 1112
HITACHI	1103, 1124
MACOM	1103, 1104, 1105, 1108
MAGNAVOX	1133
MEMOREX	1130
MOVIE TIME	1132, 1105
OAK	1139, 1137, 1102
PANASONIC	1109, 1110, 1114, 1151, 1153
PHILIPS	1128, 1129, 1130, 1106, 1107, 1150, 1131
PIONEER	1101, 1116
PULSAR	1105, 1132
PUSER	1132
RCA	1115
REALISTIC	1132
REGAL	1112, 1118, 1140, 1141, 1142, 1145, 1149
REGENCY	1134
REMBRANT	1137, 1132, 1105, 1138
SAMSUNG	1105
S.A.	1111, 1112, 1113
SLMARK	1105, 1101
SPRUCER	1105, 1110
STARGATE	1132, 1105
TELECATION	1148
TELEVIEW	1101, 1105
TEXSCAN	1144
TOCOM	1135, 1136, 1147
TOSHIBA	1104, 1146
UNIKA	1132, 1125
UNIVERSAL	1122, 1132
VIDEOWAY	1106
VIEWSTAR	1129, 1130
ZENITH	1117, 1100
ZENITH/DRAKE	
SATELLITE	1100

Device code table

CD Player setup codes

Brand	Code
ADMIRAL	6126
AIWA	6133, 6135
CARVER	6129
DENON	6142, 6151
EMERSON	6139
FISHER	6105, 6106
GARRARD	6117
HARMAN KARDON	6120, 6121, 6123, 6119
HITACHI	6107
JENSEN	6134
JVC	6140, 6141, 6145, 6148, 6151
KENWOOD	6100, 6101, 6111, 6145
LXI	6136
MAGNAVOX	6129, 6132
MARANTZ	6129
MCINTOSH	6121
NAKAMICHI	6110
ONKYO	6114, 6115
OPTIMUS	6108, 6118, 6120, 6122
PANASONIC	6124, 6125, 6127, 6150
PHILIPS	6129, 6130, 6149
PIONEER	6108
QUASAR	6125, 6127, 6124
RCA	6147, 6137, 6138, 6131, 6152
SANSUI	6110, 6146, 6113
SANYO	6105
SCOTT	6110, 6146
SHARP	6142, 6143
SHERWOOD	6120
SONY	6128
SOUNDE-SIGH	6144
TEAC	6112, 6116, 6118
TECHNICS	6127, 6124, 6125
VICTOR	6140, 6141, 6145
YAMAHA	6102, 6103, 6104

Receiver setup codes

Brand	Code
ADMIRAL	4120
AIWA	4125, 4126, 4146
DENON	4134, 4135, 4136, 4143
FISHER	4104
GARRARD	4113
HARMAN KARDON	4115, 4123, 4145
JENSEN	4129
JVC	4132, 4133, 4140, 4144
KENWOOD	4100, 4108, 4141, 4142, 4147
MAGNAVOX	4127, 4128
MARANTZ	4124
MCINTOSH	4116
MITSUBISHI	4148
NAKAMICHI	4106, 4117
ONKYO	4109, 4114
OPTIMUS	4103, 4127, 4131, 4130
PANASONIC	4119, 4118, 4121
PHILIPS	4123
PIONEER	4105, 4107, 4150

QUASAR	4119, 4118, 4121
RCA	4103, 4105, 4127, 4131, 4130, 4149
SANSUI	4103, 4111, 4139
SHARP	4134, 4137
SONY	4122
SOUNDE-SIGH	4138
TEAC	4112, 4113, 4111, 4110
TECHNICS	4121, 4118, 4119
VICTOR	4132, 4133
YAMAHA	4101, 4102

Cassette Player setup codes

Brand	Code
AIWA	7123, 7124, 7125
DENON	7131
FISHER	7103
JENSEN	7114
JVC	7129, 7130, 7132, 7133
KENWOOD	7100, 7107
MARANTZ	7102
NAKAMICHI	7105
ONKYO	7108, 7109, 7113
PANASONIC	7116, 7118
PHILIPS	7122, 7121
PIONEER	7104, 7106
RCA	7126, 7127, 7128, 7134, 7135
SANSUI	7105, 7110, 7112
SHARP	7131
SONY	7119, 7120
TEAC	7110, 7111, 7115
TECHNICS	7116, 7118, 7117
YAMAHA	7101, 7102

Laser Disc setup codes

Brand	Code
DENON	5114
HITACHI	5100
KENWOOD	5102, 5103
MAGNAVOX	5101
MARANTZ	5114
MITSUBISHI	5114, 5118, 5119
NEC	5114
PANASONIC	5104, 5105, 5106, 5115
PHILIPS	5111
PIONEER	5114
PROSCAN	5114
QUASAR	5104, 5105, 5106, 5115
RCA	5114
SAMSUNG	5112
SANYO	5114, 5117
SHARP	5113, 5116
SONY	5107, 5108, 5109, 5110
TEAC	5114
TOSHIBA	5114
YAMAHA	5101

DVD setup codes

Brand	Code
AIWA	3123
APEX	3120
DENON	3100, 3117
FERGUSON	3101
HITACHI	3111
JVC	3109
KENWOOD	3115, 3129
KONKA	3119
MITSUBISHI	3105
NORDMENDE	3101
ONKYO	3121
ORITRON	3124
PANASONIC	3100
PHILIPS	3103, 3116
PIONEER	3102
RAITE	3113
RCA	3101, 3106
SABA	3101
SAMPO	3114
SAMSUNG	3110
SHARP	3108
SILVANIA	3132, 3118
SMC	3125
SONY	3104, 3126, 3127, 3128
TECHNICS	3100
THOMSON	3101
TOSHIBA	3103
WAVE	3122
YAMAHA	3100, 3130
ZENITH	3107, 3112
VIALTA	3131
FUNAI	3132, 3118

Satellite Receiver setup codes

Brand	Code
DISH NETWORK (Echostar)	2105, 2115, 2116, 2117
ECHOSTAR	2105
EXPRESS VU	2105, 2115
G.E.	2106
G.I. (GENERAL INSTRUMENT)	2108
GRADIENTE	2114
HITACHI	2103, 2111, 2112
HNS (Hughes)	2103
MAGNAVOX	2101, 2102
PANASONIC	2104
PHILIPS	2101, 2102, 2118
PRIMESTAR	2108
PROSCAN	2106, 2109, 2110, 2113
RCA	2106, 2109, 2110, 2113
SONY	2107
STAR CHOICE	2103, 2108
TOSHIBA	2100, 2103, 2119, 2120, 2121
UNIDEN	2101, 2102

Learning about the remote control

The buttons used for operating the TV only are described here. For a complete list of the remote control's functions, see the "Remote Control functional key chart" on pages 16–17.

POWER turns the TV on and off

SLEEP allows access to the sleep timer (automatic TV shut-off) function (page 48)

LIGHT The first press of the LIGHT button lights the keypad and turns on the Illumination mode. With the Illumination mode on, pressing any other key lights the keypad for 5 seconds (10 seconds if you're in programming mode). Subsequent presses of the LIGHT button toggle between turning the Illumination mode on and off.

Channel Numbers (0-9, 100) allow direct access to channels (page 27)

MODE cycles through the six device modes: TV, CABLE/SAT, VCR, DVD, AUDIO1, and AUDIO2. The mode indicator light will remain lit for 10 seconds (page 15).

PIC SIZE cycles through the five picture sizes: Normal, Theater Wide 1, Theater Wide 2, Theater Wide 3, and Full (page 32)

FAVORITE allows access to the favorite channel search function (page 29)

MENU allows access to on-screen programming menus (page 23)

ENTER sets programming menu information (page 23)

▲▼ ◀▶ select or adjust programming menus (page 23)

(FAV) ◀▶ cycles through favorite channels (page 29)

CH ▲▼ cycles through programmed channels (page 27)

VOL ▲▼ adjusts the volume level

EXIT exits the programming menus (page 23)

INPUT selects the video input source (page 46)

MUTE mutes the sound (page 49)

RECALL displays on-screen information (page 53)

CH RTN returns to the last viewed channels (page 29)

PIP CH ▲▼ selects the POP (picture-out-picture) channel (page 35)

PIP turns the POP feature on and off (page 35)

STILL freezes the POP picture (page 36)

SWAP switches the main and POP pictures (page 36)

SOURCE selects the POP picture source (page 35)

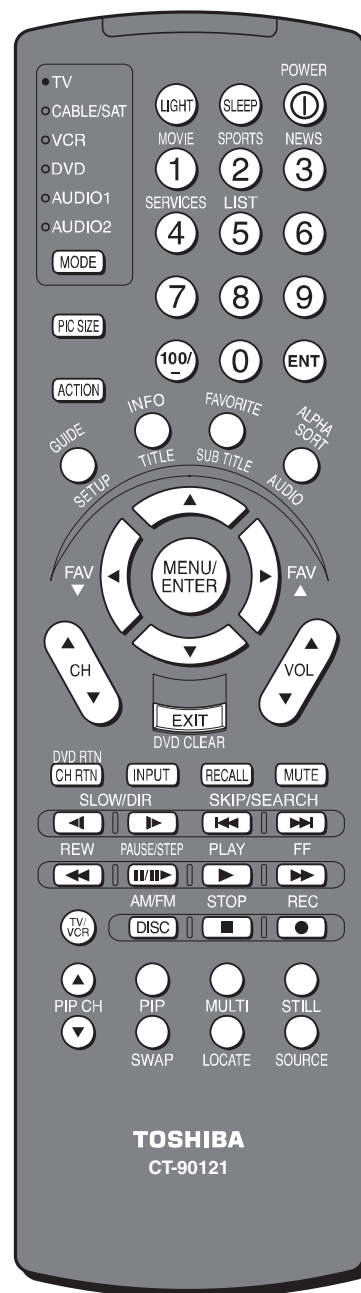

Setting up your TV

Learning about the menu system

After you have installed the batteries and programmed the remote control, you will need to set some preferences on the TV using the menu system. You can access the menu system using the buttons on the TV or remote control.

1. Press MENU to display the menu system.
2. Press ◀ or ▶ to select a menu.
3. Press ▲ or ▼ to select an item.
4. Press ◀ or ▶ to select or adjust a setting.

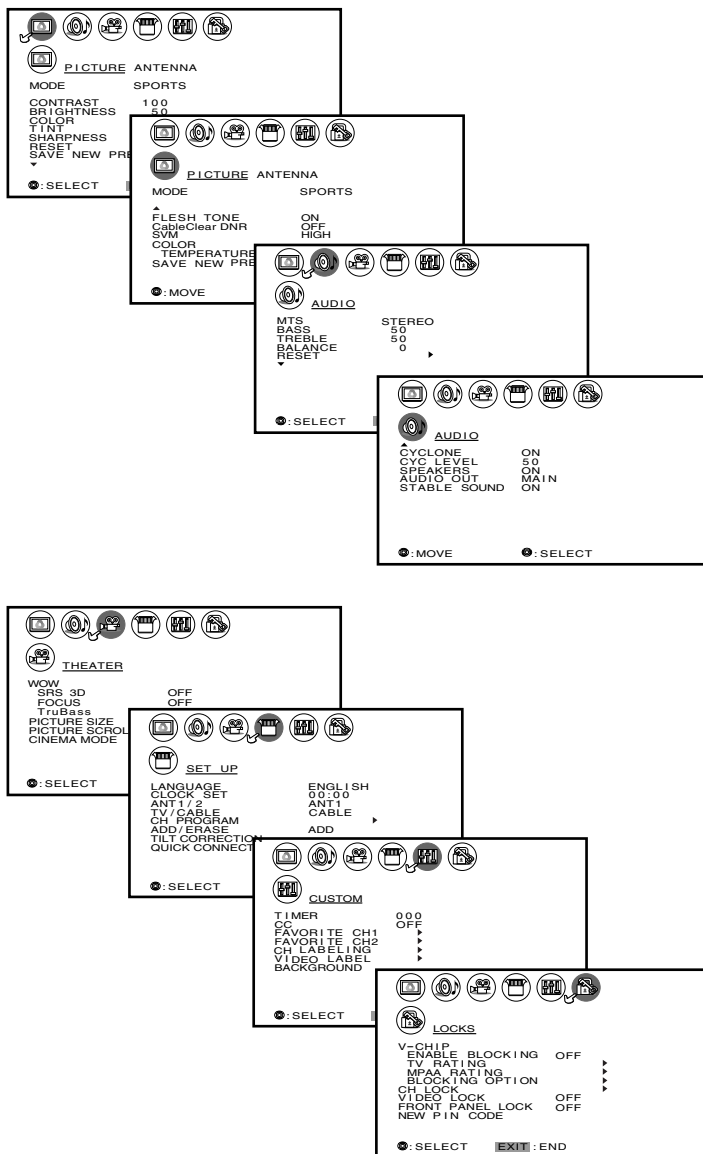

- Press ENTER to activate the function settings in the menus.
- If you do not make a selection within 15 seconds, the main menus close automatically; the other menus close automatically within 6 seconds.
- To close an on-screen menu instantly, press EXIT.

Note Regarding Quick Connect Guide

The **Quick Connect Guide** automatically appears on-screen the first time the TV is turned on. This feature provides on-screen instructions to guide you through the initial setup of your TV.

To stop the **Quick Connect Guide**, either press EXIT or turn off the TV.

See page 24 for details.

TV front panel

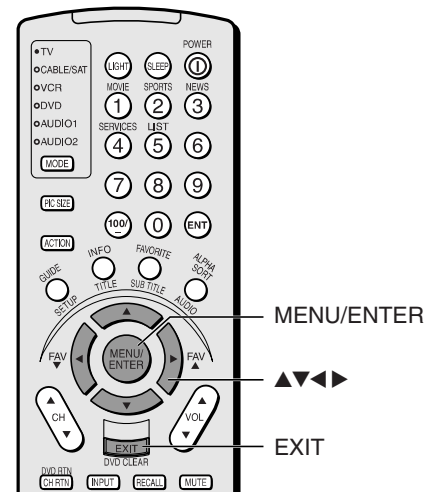
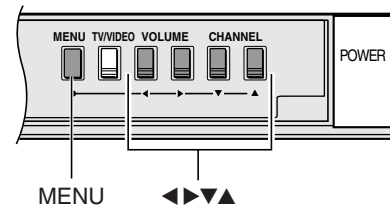

Note:

You can change the background of the menu. See page 53 for details.

Using the Quick Connect Guide

The Quick Connect Guide automatically starts the first time the TV is turned on. This feature provides on-screen instructions to guide you through initial setup of your TV.

To manually start the Quick Connect Guide and change the current settings:

1. Press MENU, and then press ◀ or ▶ until the SET UP menu appears.
2. Press ▲ or ▼ to highlight “QUICK CONNECT GUIDE.”

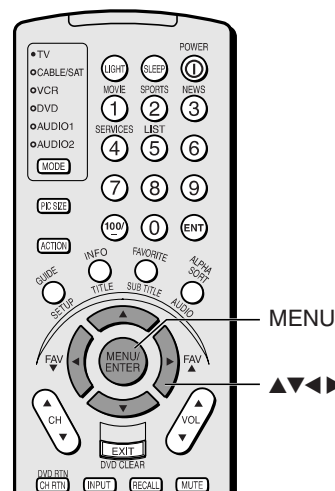
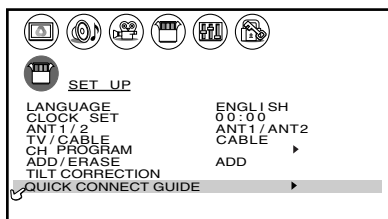

3. Press ◀ or ▶ to enter the Quick Connect Guide mode. Advance through the setup according to the guide displayed on-screen.
 - Press ◀ or ▶ to make a selection.
 - Press MENU to continue to the next screen.

The Quick Connect Guide will guide you through the following items.

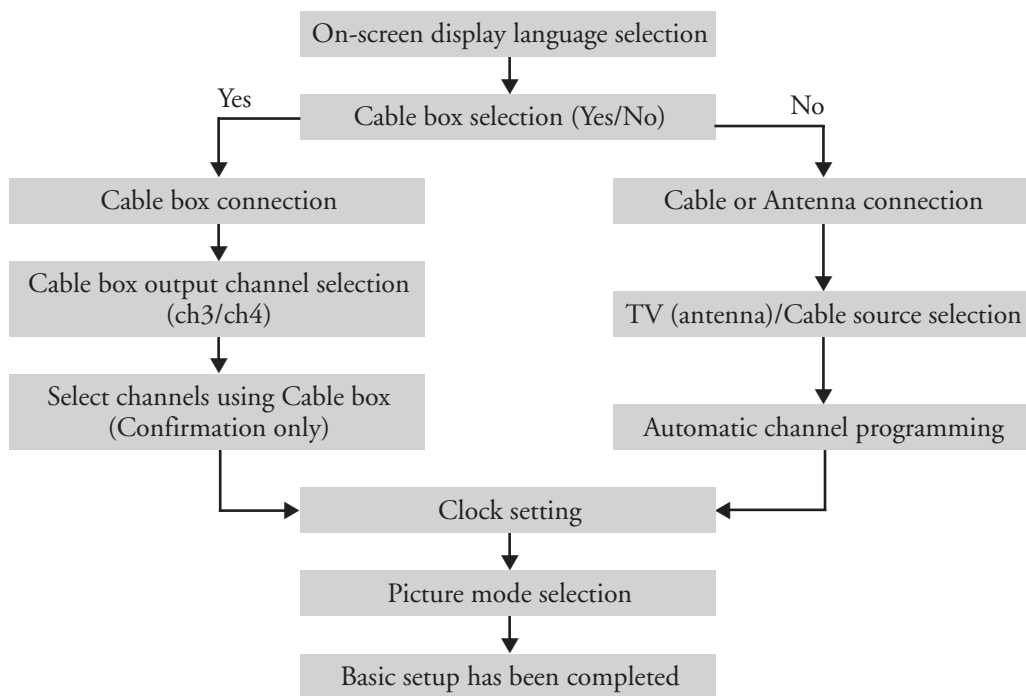

To stop the Quick Connect Guide:
Press EXIT or turn off the TV.

Changing the on-screen display language

You can choose from three different languages (English, French and Spanish) for the on-screen display of adjustment menus and messages.

To select a language:

1. Press MENU, and then press ◀ or ▶ until the SET UP menu appears.
2. Press ▲ or ▼ to highlight LANGUAGE.

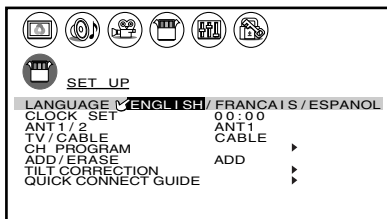

3. Press ◀ or ▶ to highlight your desired language.

Selecting the antenna input

You can connect to two different antenna input sources (ANT 1 or ANT 2).

To select the antenna input using the INPUT or TV/VIDEO button:

Press INPUT on the remote control or TV/VIDEO on the TV. See the following illustrations for details. The current signal source displays in purple.

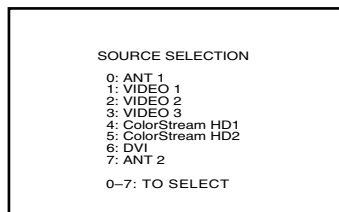

Pressing INPUT on the remote control displays the current signal source (press INPUT again or 0-7 to change)

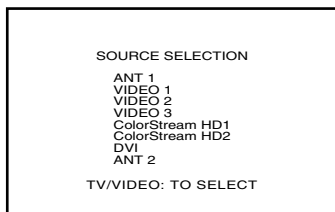

Pressing TV/VIDEO on the TV changes the current signal source

To select the antenna input using the menu system:

1. Press MENU, and then press ◀ or ▶ to highlight the SET UP menu.
2. Press ▲ or ▼ to highlight ANT 1/2.

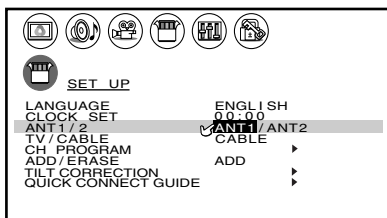

3. Press ◀ or ▶ to highlight either ANT 1 or ANT 2, depending on the antenna terminal you wish to use.

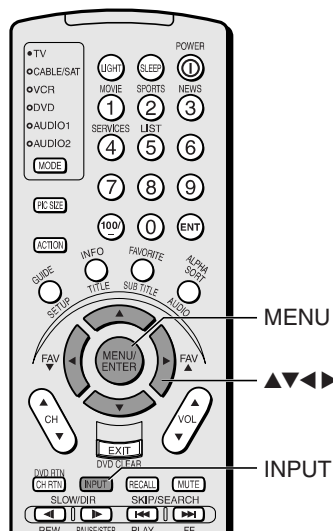

TV front panel

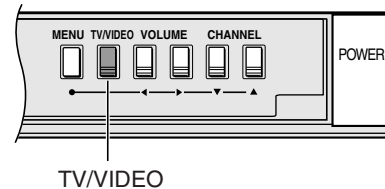

Please note the following regarding the DVI source selection:

This TV is not intended for connection to and should not be used with a PC (personal computer). See "Connecting a device to the DVI/HDCP input" on page 13 for details.

Adding channels to the TV's memory

When you press Channel ▲ or ▼, your TV will stop only on the channels stored in the TV's channel memory.

Follow the steps below and on the next page to program channels into the TV's memory.

Programming channels automatically

Your TV can automatically detect all active channels in your area and store them in its memory. After the channels are stored automatically, you can manually add or erase individual channels (see page 27).

To program channels automatically:

1. Press MENU, and then press ◀ or ▶ until the SET UP menu appears.
2. Press ▲ or ▼ until TV/CABLE is highlighted.
3. Press ◀ or ▶ to highlight either TV or CABLE, depending on which you use. If you use an antenna, highlight TV; if you use cable, highlight CABLE.

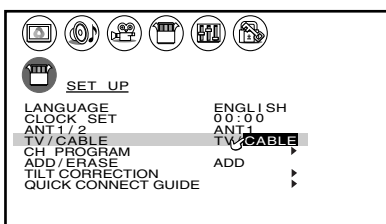

4. Press ▼ to select CH PROGRAM.

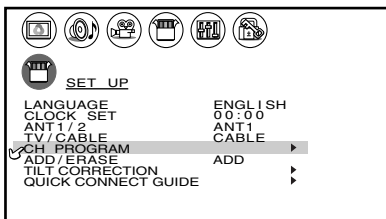

5. Press ◀ or ▶ to start channel programming. The TV will automatically cycle through all the TV or Cable channels (depending on which you selected), and store all active channels in the channel memory.

While the TV is cycling through the channels, the message "Programming Now—Please Wait" appears.

When channel programming is complete, the message "Completed" appears.

6. Press Channel ▲ or ▼ to view the programmed channels.

Note:

To tune the TV to a channel not programmed in the channel memory, you must use the Channel Number buttons on the remote control.

TV front panel

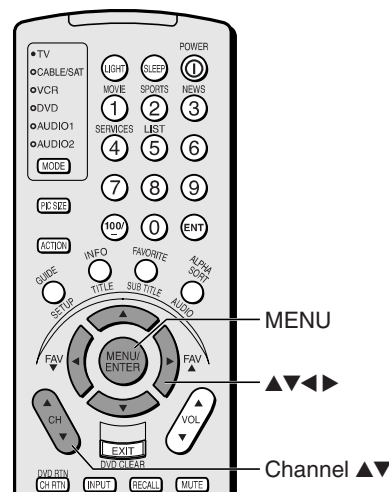
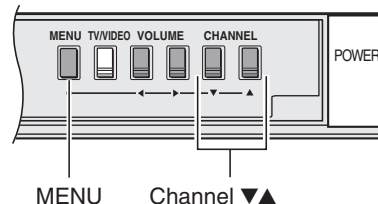

Adding and erasing channels manually

After you have automatically programmed all active channels into the TV's memory, you can manually add or erase specific channels.

To add or erase channels:

1. Select the channel you want to add or erase. If you are adding a channel, you must select the channel using the Channel Number buttons.
2. Press MENU, and then press ◀ or ▶ until the SET UP menu appears.
3. Press ▲ or ▼ to highlight ADD/ERASE.

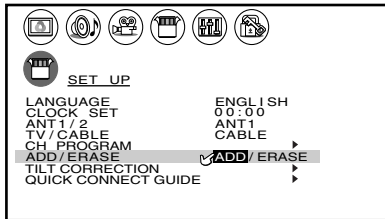

4. Press ◀ or ▶ to select ADD or ERASE, depending on the function you want to perform.
5. Repeat steps 1–4 for other channels you want to add or erase.

Changing channels

To change to the next programmed channel:

Press Channel ▲ or ▼ on the TV or remote control.

To change to a specific channel (programmed or unprogrammed):

Press the Channel Number buttons (0–9 and 100).

For channels 100 and higher, press the 100 button, and then the next two numbers. For example, to select channel 125, press 100, 2, 5.

Changing channels using SpeedSurf

To change to a specific programmed channel using SpeedSurf:

Press and hold Channel ▲ or ▼ for about one second. The TV will enter the SpeedSurf mode.

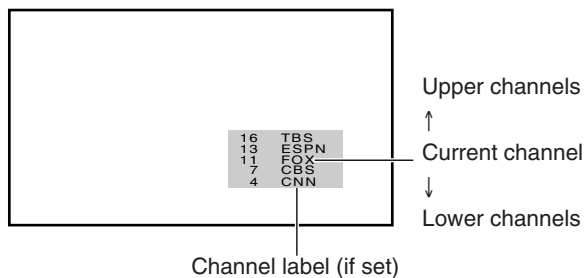

While the SpeedSurf mode is on-screen, repeatedly press or hold Channel ▲ or ▼ to scroll the channel list. Release the button to display the highlighted channel.

TV front panel

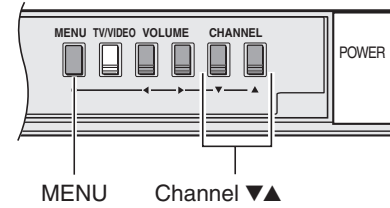

MENU Channel ▼▲

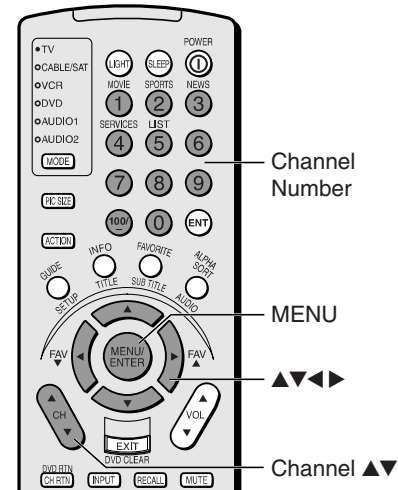

Channel Number

MENU

Channel ▼▲

Adjusting the tilt correction feature

When you install or move the TV, the picture may suffer from color shading and/or picture tilt because of terrestrial magnetism. If either condition occurs, the following adjustment should be made for the best possible picture.

To adjust the tilt correction:

1. Press MENU, and then press ◀ or ▶ until the SET UP menu appears.
2. Press ▲ or ▼ to highlight TILT CORRECTION.
3. Press ◀ or ▶ to adjust the picture tilt from +10 to -10.

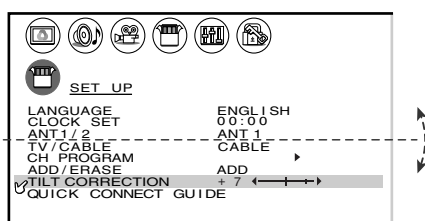

Using the TV's features

Adjusting the channel settings

Switching between two channels using Channel Return

The Channel Return feature allows you to switch between two channels without entering an actual channel number each time.

1. Select the first channel or video mode you want to view.
2. Select a second channel using the Channel Number buttons (0–9, 100).
3. Press CH RTN. The previous channel will be displayed.

Each time you press CH RTN, the TV will switch back and forth between the last two channels you selected.

Switching between two channels using SurfLock™

The SurfLock™ feature temporarily “memorizes” one channel in the CH RTN button, so you can return to that channel quickly from any other channel by pressing CH RTN.

To memorize a channel in the CH RTN button:

1. Select the channel you want to program into the CH RTN button.
2. Press and hold CH RTN for about 2 seconds until the message “Channel Memorized” appears (flashing) on-screen. The channel has been programmed into the CH RTN button.

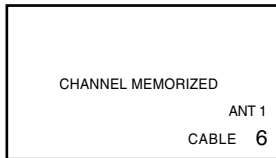

3. Continue to change channels.
4. Press CH RTN to return to the memorized channel.

The TV will return to the memorized channel one time only. Once you press CH RTN and then change channels again, the CH RTN SurfLock™ memory will be cleared and the button will function as Channel Return, by switching back and forth between the last two channels that were selected.

Programming your favorite channels

You can use the Favorite Channel Programming feature to preset up to 9 of your favorite channels each in the FAVORITE CH1 and FAVORITE CH2 modes. Because this feature scans through only your favorite channels, it allows you to skip other channels you do not normally watch.

To program your favorite channels:

1. Press MENU, and then press ◀ or ▶ until the CUSTOM menu appears.
2. Press ▲ or ▼ to highlight FAVORITE CH1 or FAVORITE CH2.

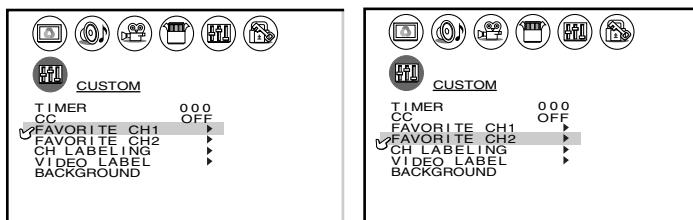

(Continued on next page)

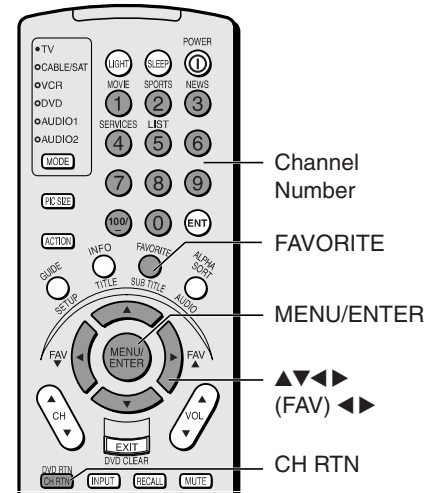

Note:

The (FAV) ◀▶ buttons operate as menu ◀▶ buttons when a menu is on-screen.

Note:

The favorite channel feature is not available in ANT2 mode.

To quickly scan through your favorite channels in a 9-picture multi-window:

Press FAVORITE (see “Using the favorite channel search function” on page 36).

(Continued from previous page)

3. Press ◀ or ▶ to display the FAVORITE CH1 menu, for example. CH INPUT will be highlighted.

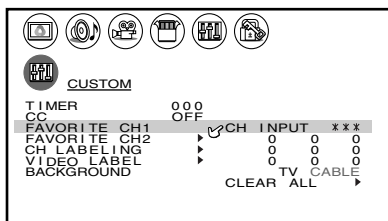

4. Press the Channel Number buttons to enter one of your favorite channels.
5. Press ENTER.
6. Repeat steps 4 and 5 for other channels.

To select your favorite channels:

Press (FAV) ▲ or ▼.

To clear a favorite channel:

1. Press MENU, and then press ◀ or ▶ until the CUSTOM menu appears.
2. Press ▲ or ▼ to highlight FAVORITE CH2, for example.
3. Press ◀ or ▶ to display the FAVORITE CH2 menu.
4. Press ▲▼◀▶ to highlight the channel you want to clear, and then press ENTER.

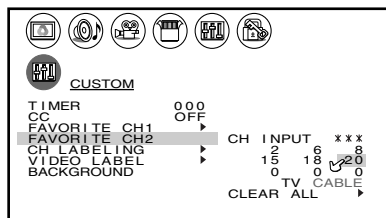
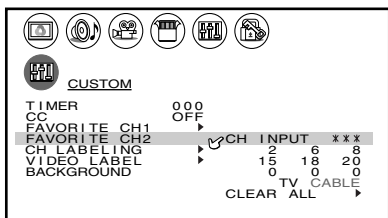

5. Repeat step 4 for other channels.

To clear all favorite channels at once:

Highlight CLEAR ALL in step 4 above, and then press ▶ or ◀.

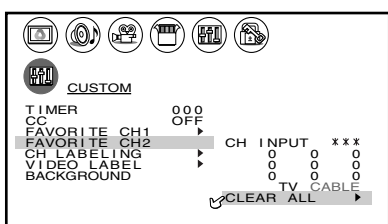

Labeling channels

Channel labels appear above the on-screen channel number display each time you turn on the TV, change the channel, or press RECALL. You can choose any four characters to identify a channel.

To create channel labels:

1. Press MENU, and then press ◀ or ▶ until the CUSTOM menu appears.
2. Press ▲ or ▼ to highlight CH LABELING.
3. Press ◀ or ▶ to display the CH LABELING menu. CH INPUT will be highlighted.

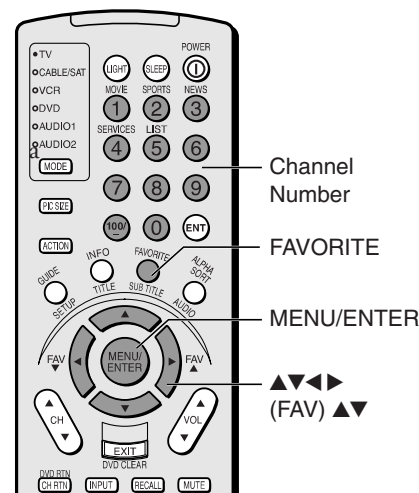
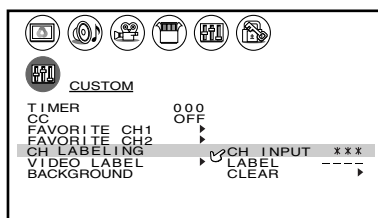

Note:

The (FAV) ▲▼ buttons operate as MENU ◀▶ buttons when a menu is on-screen.

- Press the Channel Number buttons to select a channel you want to label.

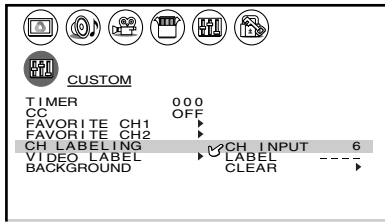

- Press ▼ to highlight LABEL.
- Press ◀ or ▶ repeatedly to select a character for the first space, and then press ENTER.

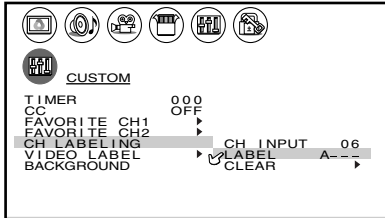

- Repeat step 6 to enter the rest of the characters.
For a blank space in the label name, choose an empty space from the list of characters; otherwise, a dash “-” will appear in the space.
You must assign a character to all four spaces or the label will not be assigned.
- Repeat steps 4–7 for other channels. You can assign labels to a maximum of 32 channels.

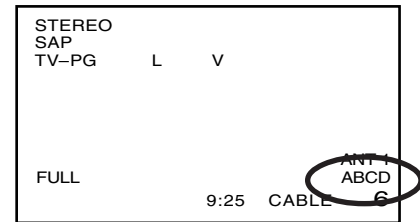
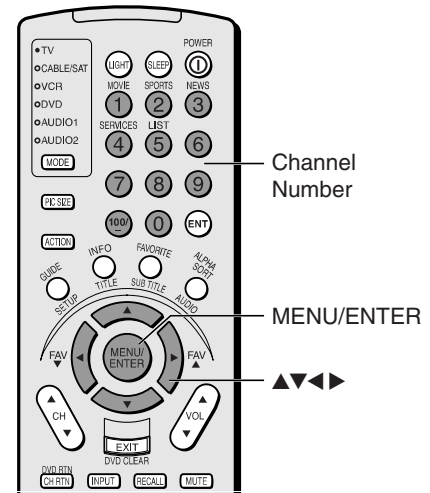

Channel label example

To erase a channel label:

- Press MENU, and then press ◀ or ▶ until the CUSTOM menu appears.
- Press ▲ or ▼ to highlight CH LABELING.
- Press ◀ or ▶ to display the CH LABELING menu.
- Press ▼ to highlight CH INPUT, and then use the Channel Number buttons to select the channel you want to clear.
- Press ▼ to highlight CLEAR.

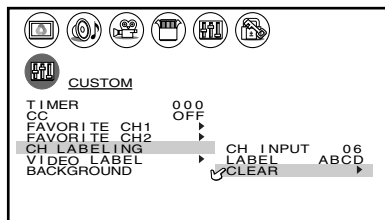

- Press ◀ or ▶ to erase the channel label.
- Repeat steps 4–6 to erase other channel labels.

Viewing the wide-screen picture formats

You can view programs in a variety of picture sizes—Natural, Theater Wide 1, Theater Wide 2, Theater Wide 3, and Full.

The way the image displays in any of the picture sizes will vary depending on the format of the program you are viewing. Select the picture size that displays the current program the way that looks best to you.

Selecting the picture size

1. Press PIC SIZE on the remote control.
2. Press the corresponding number button to select the desired picture size, as described below and on the next page.

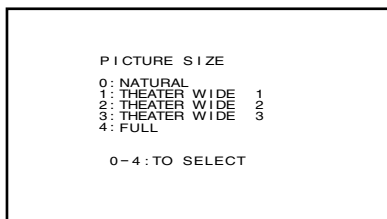

Natural picture size

- The picture is displayed close to its originally formatted proportion. Some program formats will display with side bars and/or bars at the top and bottom (see examples below).

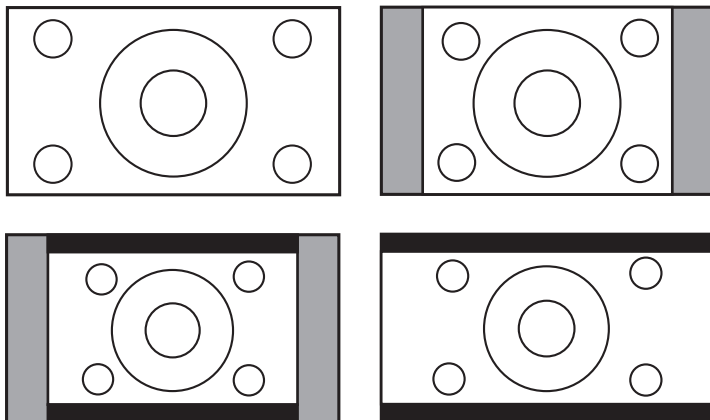

Natural picture size examples: The way the image displays will vary depending on the format of the program you are currently watching. See "Notice of possible adverse effects on TV picture tube" at right.

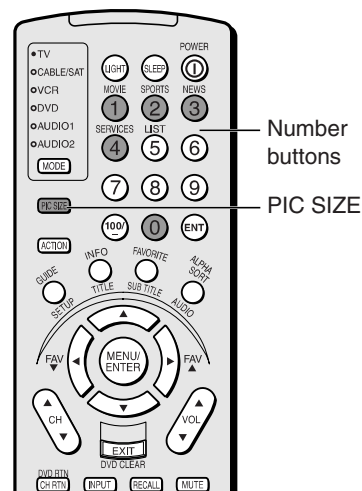

Note:

- The PICTURE SIZE feature may not be available for some program formats.
- You also can change the picture size by selecting PICTURE SIZE in the THEATER menu.

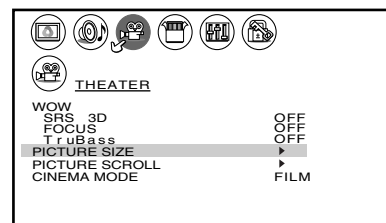

NOTICE OF POSSIBLE ADVERSE EFFECTS ON TV PICTURE TUBE

Avoid displaying stationary images on your TV screen for extended periods of time. Fixed (non-moving) images, such as side bars or top/bottom bars in widescreen picture formats, can become permanently engrained in the picture tube. **This type of damage is NOT covered by your warranty because it is the result of misuse.** See item 32 on page 4.

Theater Wide 1 picture size

- The picture is non-uniformly enlarged—the center of the picture remains close to its original proportion, but the left and right edges are stretched wider to fill the screen.
- A small part of the picture at the top and bottom is hidden; however, this mode cannot be scrolled.

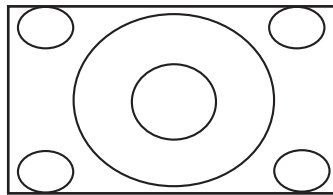

Theater Wide 1 picture size example

Theater Wide 2 picture size

- The entire picture is uniformly enlarged—it is stretched the same amount both wider and taller (retains its original proportion).
- Part of the picture at the top and bottom is hidden. To view the hidden areas, see “Scrolling the Theater Wide picture” on page 34.

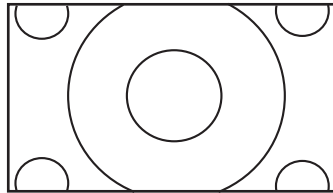

Theater Wide 2 picture size example

Theater Wide 3 picture size

- The picture is non-uniformly enlarged—it is stretched wider to fill the width of the screen, but only slightly stretched taller.
- A small part of the picture at the top and bottom is hidden. To view the hidden areas, see “Scrolling the Theater Wide picture” on page 34.

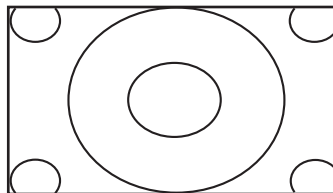

Theater Wide 3 picture size example

Full picture size

- The picture is non-uniformly enlarged—it is stretched wider to fill the width of the screen, but not stretched taller.
- None of the picture is hidden.

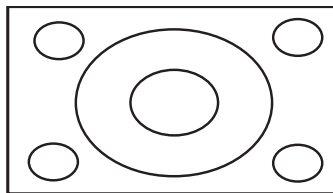

Full picture size example

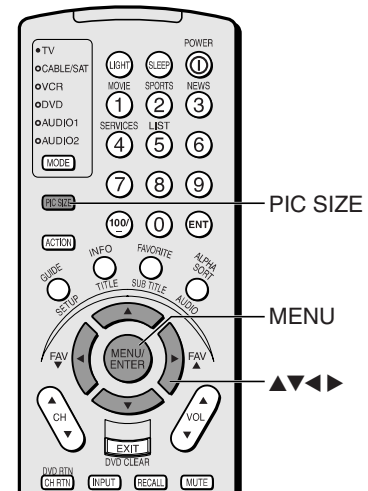

Note:

If you select Theater Wide 2 or 3, the top and bottom edges of the picture may be hidden. To see the hidden edges, either scroll the picture (see page 34) or try viewing the program in Full picture size.

Scrolling the Theater Wide picture (Theater Wide 2 and 3 picture sizes only)

1. Press PIC SIZE to select either Theater Wide 2 or 3 mode.
2. Press MENU, and then press ◀ or ▶ until the THEATER menu appears.
3. Press ▲ or ▼ to highlight PICTURE SCROLL.

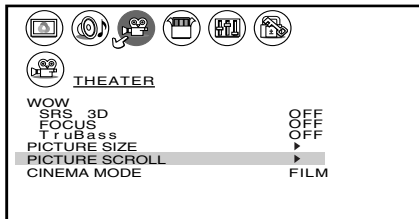

4. Press ◀ or ▶ to display the Scroll Adjustment mode.

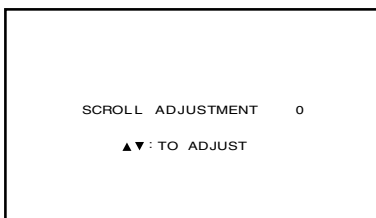

5. Press ▲ or ▼ to adjust the vertical position of the picture.
 - Normal (center) position

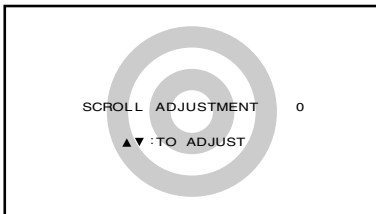

- To raise the picture, press ▲.
- To lower the picture, press ▼.

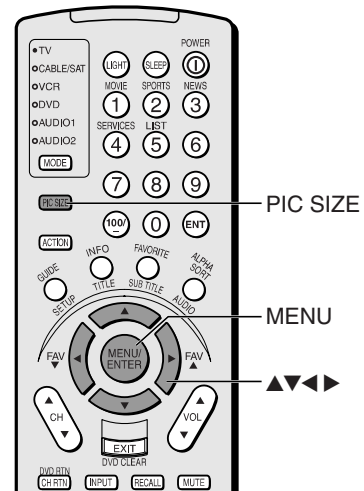
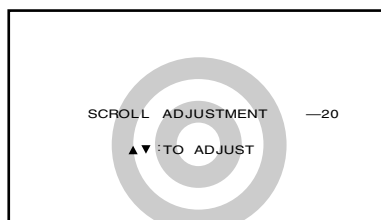
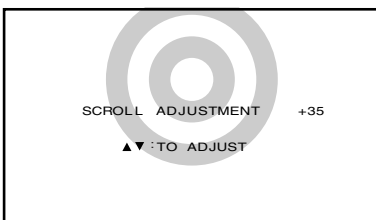

Note:

You can scroll the picture in Theater Wide 2 and Theater Wide 3 modes only. The scroll amounts are as follows:

- 480i signal source:
 - Wide 1: Not adjustable
 - Wide 2: +45 to -20
 - Wide 3: +45 to -20
- 480p signal source:
 - Wide 1: Not adjustable
 - Wide 2: +30 to -20
 - Wide 3: +30 to -20
- 1080i signal source:
 - Wide 1: Not adjustable
 - Wide 2: +30 to -20
 - Wide 3: +30 to -20
- 720p signal source:
 - Wide 1: Not available
 - Wide 2: Not available
 - Wide 3: Not available

Selecting the cinema mode

When you view a DVD movie (3:2 pulldown processed) from a DVD player connected to the ColorStream (component video) or DVI/HDCP inputs on the TV, smoother and more natural motion can be obtained by setting the CINEMA MODE to FILM.

To set the CINEMA MODE to FILM:

1. Press MENU, and then press ◀ or ▶ until the THEATER menu appears.
2. Press ▲ or ▼ to highlight CINEMA MODE.
3. Press ◀ or ▶ to select FILM.

To turn off the CINEMA MODE:
Select VIDEO in step 3 above.

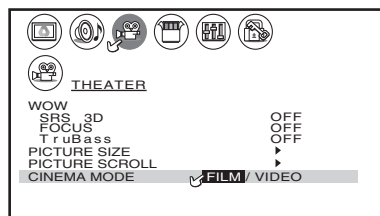

Using the POP double-window feature

The POP (picture-out-picture) feature splits the screen into a double window that allows you to watch two programs at the same time. The POP program can come from a TV broadcast or an external source, such as a VCR.

To display a TV broadcast in the POP window:

1. Press PIP to display the POP window.

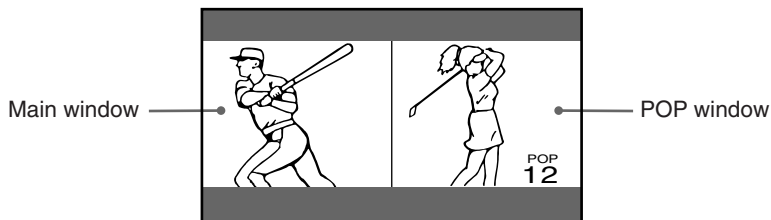

2. Press PIP CH ▲▼ to change the channel of the POP window. If the V-CHIP feature is active and you try to watch a TV program that exceeds your set rating limits, the program will be blocked (see “Using the V-CHIP menu” on page 38).

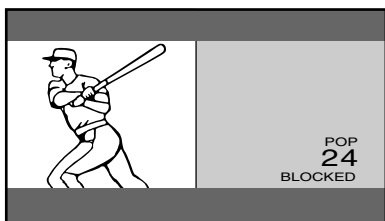

To display a picture from an external source in the POP window:

1. Connect the external source equipment (see “Connecting your TV” on page 7).
2. Select the TV program you want to watch in the main window.
3. Press PIP to display the POP window.
4. Press SOURCE to display the POP SOURCE SELECTION window. Select the desired input source by pressing the corresponding number button (0–3). The current source displays in purple.

You can view a video tape as the POP picture, or select a channel for the POP window using the VCR’s channel keys.

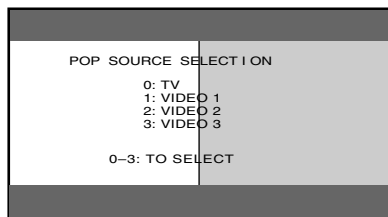

Note: You cannot view a ColorStream, DVI, or ANT 2 source in the POP window.

To close the POP window:

Press PIP again.

Note:

- The PIP buttons on the remote control operate the TV’s POP features.
- You cannot access POP features when viewing ColorStream HD1/HD2 or DVI input.
- You cannot display the ANT-2 signal source in the POP window.
- You can output the sound of either the main or POP program from the Audio OUT jacks (see “Selecting the Audio OUT sound” on page 52).

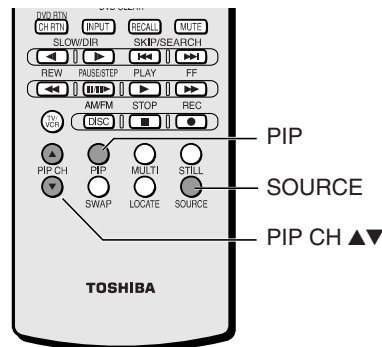

NOTICE OF POSSIBLE ADVERSE EFFECTS ON TV PICTURE TUBE

Avoid displaying stationary images on your TV screen for extended periods of time. Fixed (non-moving) images (such as still PIP/POP windows or black/gray bars in wide-screen picture or PIP/POP formats) can become permanently engrained in the picture tube. **This type of damage is NOT COVERED BY YOUR WARRANTY** because it is the result of misuse. See item 32 on page 4.

Switching the main and POP pictures

Press SWAP while you are using the POP feature to switch the main and POP pictures.

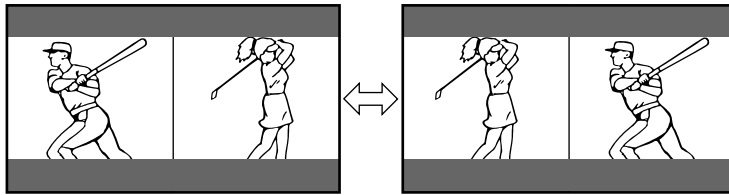

Freezing the POP picture

Press STILL while you are using the POP feature to freeze the POP picture. To return to the moving picture, press STILL again.

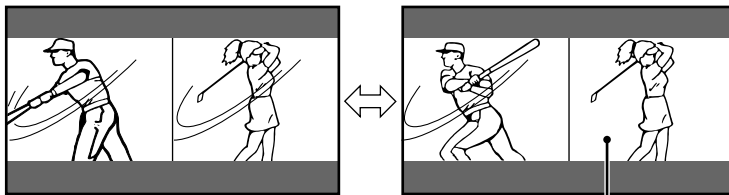

Still picture

Using the favorite channel search function

You can use the favorite channel search function to quickly scan your favorite channels (see “Programming your favorite channels” on page 29).

1. Press FAVORITE.

The TV automatically enters POP mode, and begins a nine-picture scan of your favorite channels in the POP window. The first of the nine windows will display as a moving picture.

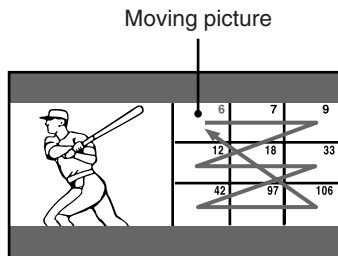

2. Press ▲▼◀▶ to select one of the nine pictures (becomes a moving picture).
3. Press ENTER to display the channel you selected in step 2 as a normal picture.

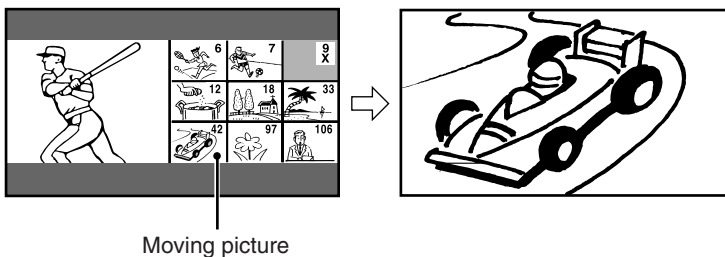

Moving picture

Each time you press FAVORITE, the POP window scans your favorite channels in the following order:

FAVORITE CH1 — FAVORITE CH2 — Off

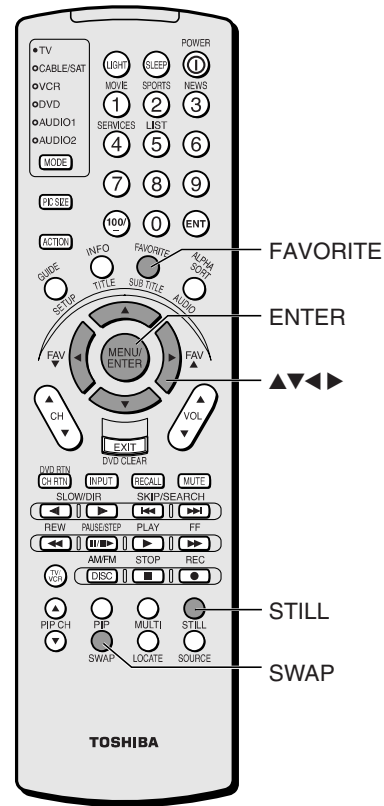

NOTICE OF POSSIBLE ADVERSE EFFECTS ON TV PICTURE TUBE

Avoid displaying stationary images on your TV screen for extended periods of time. Fixed (non-moving) images (such as still PIP/POP windows or black/gray bars in wide-screen picture or PIP/POP formats) can become permanently engrained in the picture tube. **This type of damage is NOT COVERED BY YOUR WARRANTY** because it is the result of misuse. See item 32 on page 4.

Using the LOCKS menu

The LOCKS menu includes the V-CHIP, CH LOCK, VIDEO LOCK, and NEW PIN CODE functions. You can use these functions after entering the correct PIN code.

Entering the PIN code

1. Press MENU, and then press ◀ or ▶ until the LOCKS menu appears.

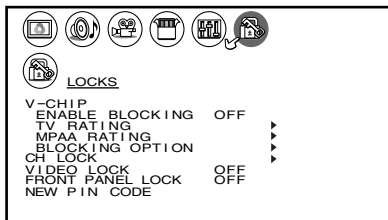

2. Press ▲ or ▼ to display the PIN code entering mode.

- **BLOCKING RESET status:**

Press the Number buttons (0–9) to enter a new 4-digit PIN code, and then press ENTER.



- **BLOCKING ACTIVE status (when the PIN code is already stored):**

Press the Number buttons (0–9) to enter your 4-digit PIN code, and then press ENTER.



If the wrong PIN code is entered, the message “Incorrect” appears. Enter the code again, and then press ENTER.

Continue to set each item following the steps on the next page.

If you cannot remember your PIN code

While in the PIN code entering mode, press RECALL four times within five seconds. The PIN code will be released (BLOCKING RESET status restored).



Note:

The V-Chip function is available for the U.S. V-Chip system only. The Canadian V-Chip system is not supported.

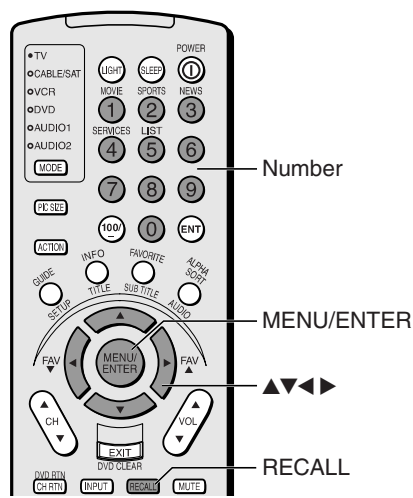

Using the V-CHIP menu

Some TV programs and movies include signals that classify the content of the program (dialog, language, sex, violence). The V-CHIP control feature in this TV detects the signals and blocks the programs according to your selections. To use this feature, perform the following setup.

ENABLE BLOCKING

1. From the LOCKS menu, select ENABLE BLOCKING.
2. Press ◀ or ▶ to select ON or OFF.

ON : To enable your settings (Lock).

OFF: To release your settings (Unlock).

Note: The CH LOCK function is not affected by the ENABLE BLOCKING setting.

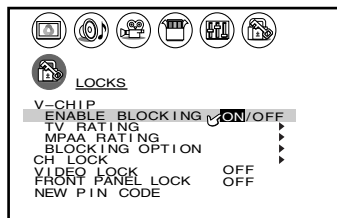

TV RATING (Independent rating system for broadcasters)

1. From the LOCKS menu, select TV RATING.
2. Press ◀ or ▶ to display the TV RATING menu.
3. Press ▼ or ▲ to select item.
4. Press ▶ to lock (displays "X"). Press ◀ to unlock (displays "✓").
5. Repeat steps 3 and 4 to set the next item.

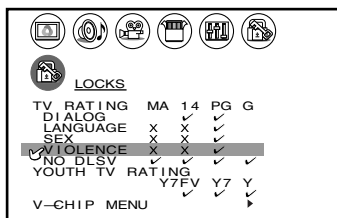

The TV age-based ratings and content themes you can lock are listed in the following table.

Ratings	Description and Content themes
MA	Mature Audience Only (This program is specifically designed to be viewed by adults and therefore may be unsuitable for children under 17.) L) Crude or indecent language S) Explicit sexual activity V) Graphic violence
14	Parents Strongly Cautioned (This program contains some material that many parents would find unsuitable for children under 14 years of age.) D) Intensely suggestive dialog L) Strong, coarse language S) Intense sexual situations V) Intense violence
PG	Parental Guidance Suggested (This program contains material that parents may find unsuitable for younger children.) D) Some suggestive dialog L) Infrequent coarse language S) Some sexual situations V) Moderate violence
G	General Audience (Most parents would find this program suitable for all ages.)
Y7, Y7FV	Directed to Older Children (This program is designed for children age 7 and above. Note: Programs rated Y7FV contain fantasy violence that may be more intense or more combative than programs rated Y7.)
Y	All Children (This program is designed to be appropriate for all children)

Note:

The V-Chip function is available for the U.S. V-Chip system only. The Canadian V-Chip system is not supported.

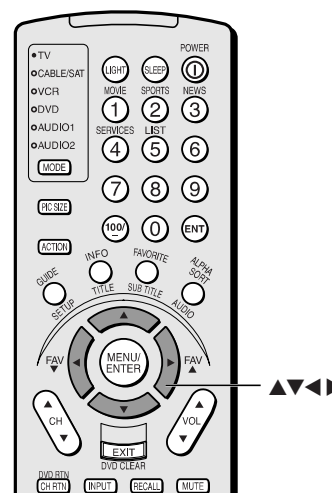

Press RECALL to display the rating of the TV program you are currently watching.

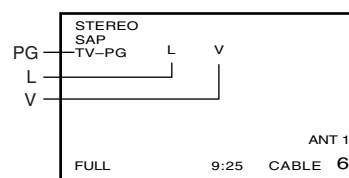

MPAA RATING (Independent rating rating system for movies)

1. From the LOCKS menu, select ENABLE BLOCKING.
2. Press ◀ or ▶ to select ON.
3. Press ▼ or ▲ to select MPAA RATING.
4. Press ◀ or ▶ to display the MPAA RATING menu.
5. Press ▶ to lock ("X") or ◀ to unlock ("✓").

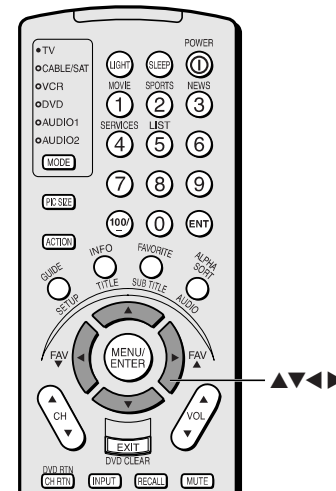
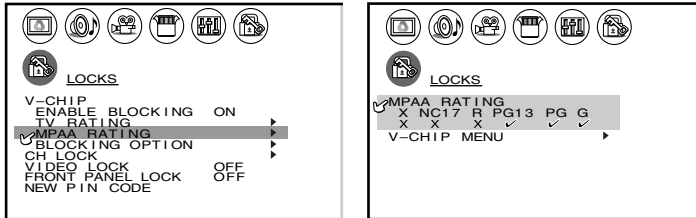

The movie ratings you can lock are described as follows:

- X : X-rated (for adults only)
- NC17: Not intended for anyone 17 and under
- R : Restricted (under 17 requires accompanying parent or adult guardian.)
- PG13 : Parents Strongly Cautioned (some material may be inappropriate for children under 13)
- PG : Parental Guidance Suggested (some material may not be suitable for children)
- G : General Audience (appropriate for all ages)

BLOCKING OPTION

1. From the LOCKS menu, select BLOCKING OPTION.
2. Press ◀ or ▶ to display the BLOCKING OPTION menu, then press ▲ or ▼ to select an item.

MPAA UNRATED:

Press ◀ or ▶ to select ON (Lock) or OFF (Unlock) for unrated programs in the MPAA rating system.

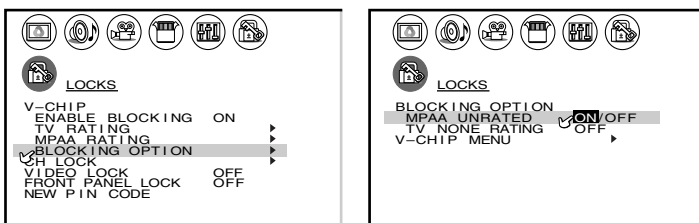

TV NONE RATING:

Press ◀ or ▶ to select ON (Lock) or OFF (Unlock) for programs rated NONE in the TV PARENTAL GUIDELINES.

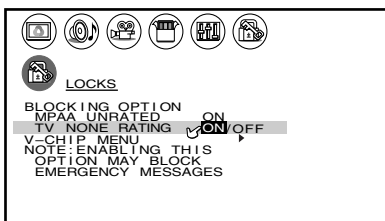

V-CHIP MENU:

Press ◀ or ▶ to return to the LOCKS menu.

Caution

Setting the TV None Rating to ON may block the broadcast of emergency information. The menu will display the note, "Enabling this option may block emergency messages" to warn you of this possibility.

Unlocking programs temporarily

1. If you try to watch a TV program that exceeds the rating limits you set, the TV enters program lock mode. After 4 seconds, the TV starts the favorite channel search function (see page 36). You can either unlock the program temporarily (see steps 2–4) or select an unlocked program to watch.

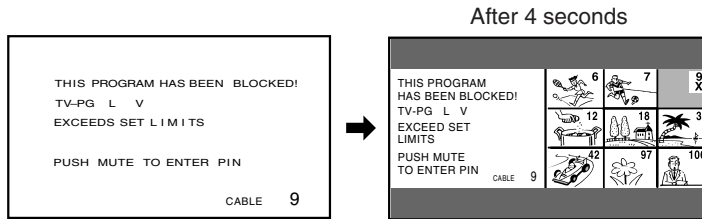

2. To temporarily unlock the program, press MUTE.

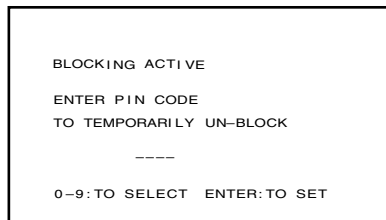

3. Press the Number buttons (0–9) to enter your 4-digit PIN code, and then press ENTER.

If the correct code is entered, the program lock mode is released and the normal picture appears.

All locking is disabled until the TV is turned off, and will be enabled when the TV is turned on again.

NOTICE OF POSSIBLE ADVERSE EFFECTS ON TV PICTURE TUBE

Avoid displaying stationary images on your TV screen for extended periods of time. Fixed (non-moving) images (such as still PIP/POP windows or black/gray bars in wide-screen picture or PIP/POP formats) can become permanently engrained in the picture tube. **This type of damage is NOT COVERED BY YOUR WARRANTY** because it is the result of misuse. See item 32 on page 4.

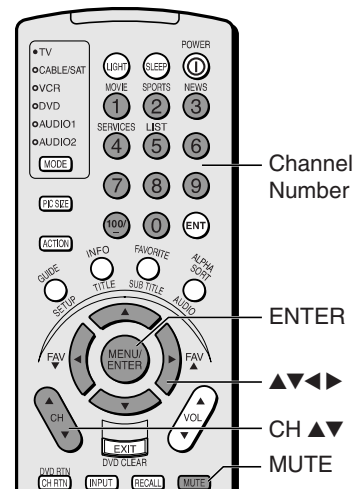

Locking channels

You can use the CH LOCK feature to lock specific channels. You will not be able to tune locked channels using the Channel ▲▼ buttons or Channel Number buttons unless you clear the setting.

You can lock a maximum of nine channels.

To lock channels:

1. From the LOCKS menu, select CH LOCK.
2. Press ◀ or ▶ to display the CH LOCK menu. CH INPUT will be highlighted.
3. Press the Channel Number buttons to enter the channel you want to lock.
4. Press ENTER.

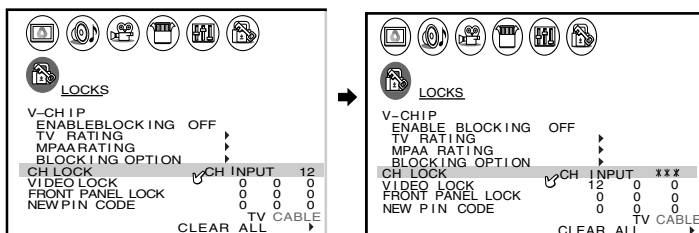
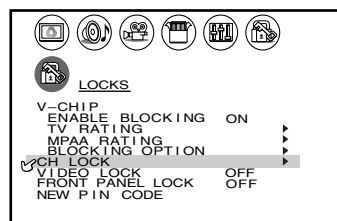

5. Repeat steps 3 and 4 to lock other channels.

To unlock individual channels:

1. From the LOCKS menu, select CH LOCK.
2. Press ◀ or ▶ to display the CH LOCK menu.
3. Press ▲▼◀▶ to highlight the channel you want to unlock, and then press ENTER.

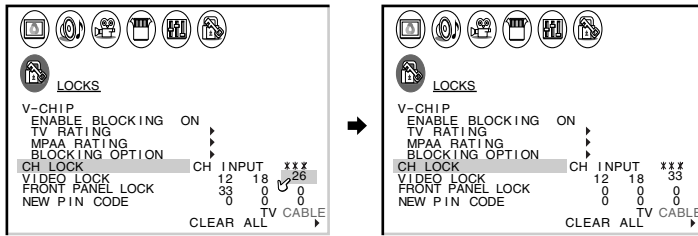

4. Repeat step 3 for other channels.

To unlock all locked channels at once:

Highlight CLEAR ALL in step 3 above, and then press ▶ or ◀.

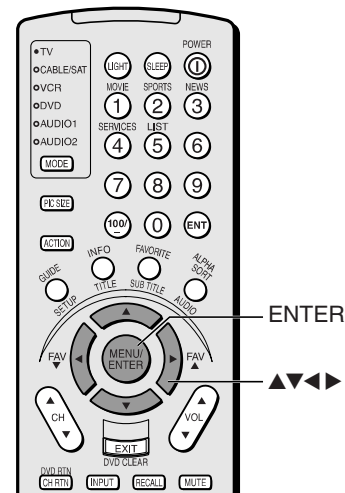
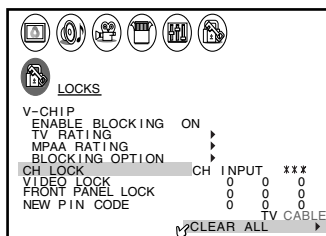

Locking video inputs

You can use the VIDEO LOCK feature to lock out the input sources (Video 1, Video 2, Video 3, ColorStream HD1, ColorStream HD2, DVI/HDCP) and channels 3 and 4.

You will not be able to select the input sources with the TV/VIDEO button or Channel buttons unless you clear the setting.

To set up the video lock:

1. From the LOCKS menu, select VIDEO LOCK.
 2. Press ◀ or ▶ to highlight the desired level of video locking (VIDEO, VIDEO+, or OFF), as follows:
 - VIDEO : Locks Video 1, Video 2, Video 3, ColorStream HD1/HD2, and DVI/HDCP.
 - VIDEO+ : Locks Video 1, Video 2, Video 3, ColorStream HD1/HD2, DVI/HDCP, and channels 3 and 4. Select VIDEO+ if you use the antenna terminal to play a video tape.

Note: Make sure the POP is not on channel 3 or 4.
- OFF : Unlocks all video input sources.

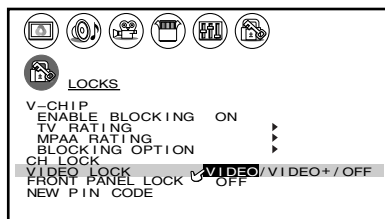

Using the front panel lock feature

Lock the front panel buttons to prevent your settings from being changed accidentally (by children, for example). When the front panel lock is ON, all control buttons on the TV front panel (except POWER) do not operate.

To lock the front panel buttons:

1. From the LOCKS menu, select FRONT PANEL LOCK.
2. Press ◀ or ▶ to highlight ON.

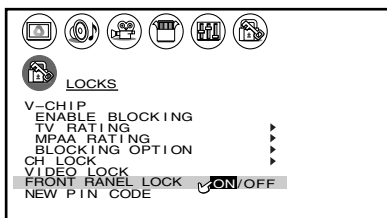

If a button on the front panel (except POWER) is pressed, the message “Not Available” appears.

To unlock the front panel buttons:

Highlight OFF in step 2 above, or press and hold the VOLUME DOWN (◀) button on the TV front panel for about 10 seconds until the message “Front Panel Lock: OFF” appears on-screen.

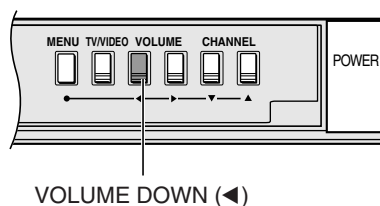
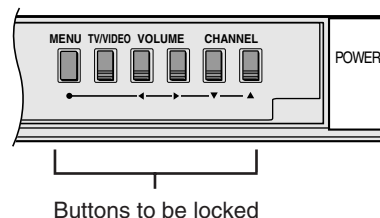

Changing the PIN code

1. From the LOCKS menu, select NEW PIN CODE.
2. Press the Number buttons (0–9) to enter a 4-digit code, and then press ENTER. The numbers you enter will replace the dashes in the display.

The new PIN code is now active.

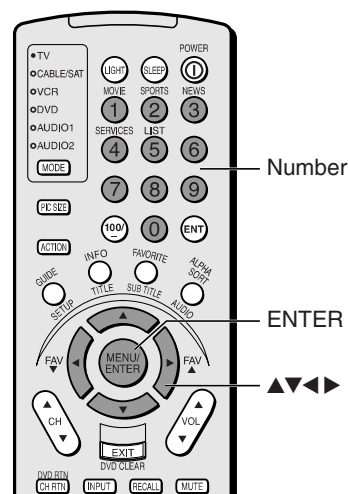
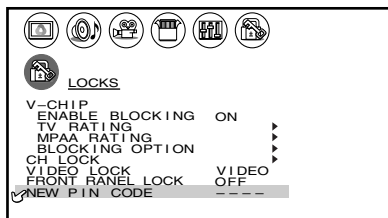

Adjusting the picture

Selecting the picture mode

You can select from four picture modes: Sports, Standard, Movie, and Preference.

Mode	Picture Quality
Sports	Bright and dynamic picture (factory setting)
Standard	Standard picture setting (factory setting)
Movie	Movie-like picture setting (factory setting)
Preference	Your personal preferences*

*(see "Saving your new preferences" on page 44.)

To select the picture mode:

1. Press MENU, and then press ◀ or ▶ until the PICTURE menu appears.
2. Press ▼ or ▲ to select MODE.
3. Press ◀ or ▶ to highlight the mode you prefer.

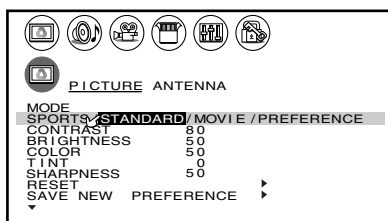

Adjusting the picture quality

You can adjust the picture quality (contrast, brightness, color, tint, and sharpness) to your personal preferences.

Selection	◀ Pressing ▶	
contrast	lower	higher
brightness	darker	lighter
color	paler	deeper
tint	reddish	greenish
sharpness	softer	sharper

To adjust the picture quality:

1. Press MENU, and then press ◀ or ▶ until the PICTURE menu appears.
2. Press ▼ or ▲ to highlight the item you want to adjust (contrast, brightness, color, tint, or sharpness).
3. Press ◀ or ▶ to adjust the level.

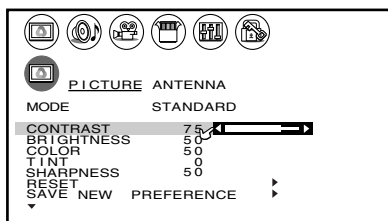

The picture quality adjustments you made can be saved in the TV's memory with the SAVE NEW PREFERENCE feature (see page 44). You can keep these settings or choose factory set options, as described under "Selecting the picture mode" above.

Note:

If you select one of the factory-set picture modes (SPORTS, STANDARD, or MOVIE) and then change a picture quality setting (for example, increase the contrast), the picture mode automatically changes to PREFERENCE in the Picture menu.

To save your new picture quality settings, you must select SAVE NEW PREFERENCE (see page 44) before closing the Picture menu or the TV will return to the previous picture mode.

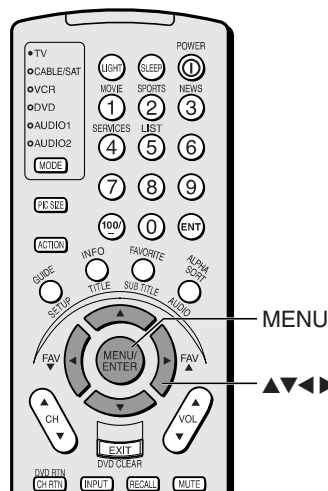

Saving your new preferences

You can save your PICTURE quality adjustments (contrast, brightness, color, tint, and sharpness) in the Picture menu PREFERENCE MODE.

To save your new preferences:

1. Press MENU, and then press ◀ or ▶ until the PICTURE menu appears.
2. Press ▲ or ▼ to highlight SAVE NEW PREFERENCE.
3. Press ◀ or ▶. The menu displays “DONE.”

The mode automatically changes to PREFERENCE.

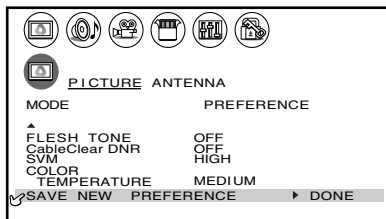

You can choose your saved preferences by selecting PREFERENCE mode in the Picture menu (see “Selecting the picture mode” on page 43).

Using the flesh tone feature

This feature automatically adjusts the tint to display more natural flesh tones.

To turn on the flesh tone feature:

1. Press MENU, and then press ◀ or ▶ until the PICTURE menu appears.
2. Press ▲ or ▼ to highlight FLESH TONE.
3. Press ◀ or ▶ to highlight ON.

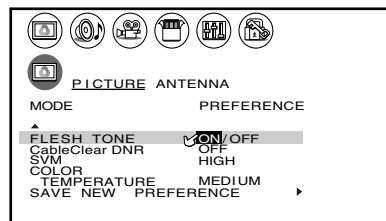

To turn off the flesh tone feature:

Highlight OFF in step 3 above.

Using CableClear™ DNR (digital noise reduction)

This feature allows you to reduce visible interference in your TV picture (for example, when receiving a broadcast with a weak signal or playing back a video cassette or disc damaged by repeated use).

To turn on CableClear™ DNR:

1. Press MENU, and then press ◀ or ▶ until the PICTURE menu appears.
2. Press ▲ or ▼ to highlight CableClear DNR (or DNR if you are in a mode other than ANT1 or ANT2).
3. Press ◀ or ▶ to highlight AUTO.

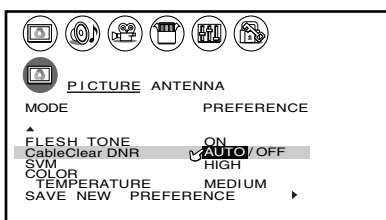

To turn off CableClear™ DNR:

Highlight OFF in step 3 above.

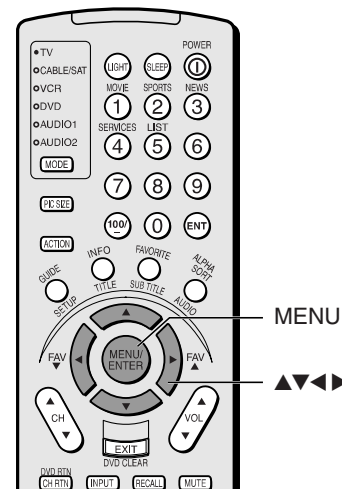

Note:

The “CableClear DNR” menu listing will change to “DNR” in video mode.

Selecting the Scan Velocity Modulation (SVM)

The SVM feature enhances picture contrast and sharpness. This feature has three modes: HIGH, LOW, and OFF.

To select the SVM feature:

1. Press MENU, and then press ◀ or ▶ until the PICTURE menu appears.
2. Press ▲ or ▼ to highlight "SVM."
3. Press ◀ or ▶ to highlight the mode you prefer (HIGH, LOW, or OFF).

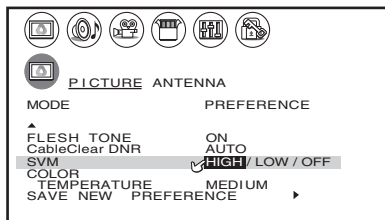

Note:

SVM is not required when viewing some high-quality video material. If you are watching high-quality video material, you may want to set SVM to OFF.

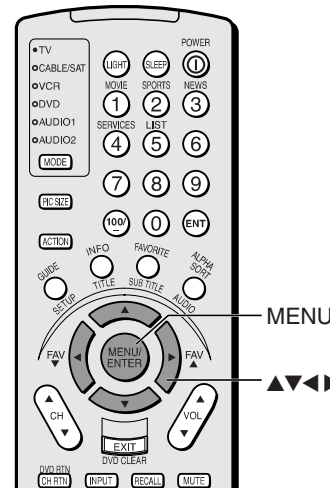

Selecting the color temperature

You can change the quality of the picture by selecting from three preset color temperatures: cool, medium, and warm.

Mode	Picture Quality
cool	blueish
medium	neutral
warm	reddish

To select the color temperature:

1. Press MENU, and then press ◀ or ▶ until the PICTURE menu appears.
2. Press ▲ or ▼ to highlight COLOR TEMPERATURE.
3. Press ◀ or ▶ to highlight the mode you prefer.

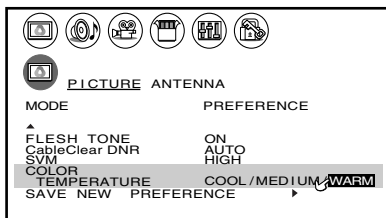

Resetting your picture quality adjustments

The RESET function returns your picture quality adjustments to the following factory settings:

Contrast	max (100)	Color temperature	Cool
Brightness	center (50)	CableClear DNR	Auto
Color	center (50)	Mode	Sports
Tint	center (0)		
Sharpness	center (50)		

To reset your picture quality adjustments:

1. Press MENU, and then press ◀ or ▶ until the PICTURE menu appears.
2. Press ▲ or ▼ to highlight RESET.
3. Press ◀ or ▶. The menu displays "DONE."

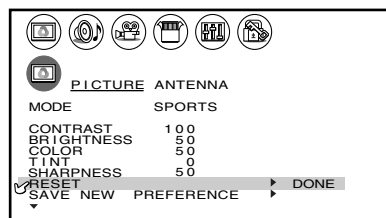

Selecting the video input source

Press INPUT on the remote control or TV/VIDEO on the TV to view a signal coming from another device connected to your TV, such as a VCR or video disc player. You can select ANT 1, VIDEO 1, VIDEO 2, VIDEO 3, ColorStream HD1, ColorStream HD2, DVI, or ANT 2, depending on which input jacks are used for connecting your devices (see “Connecting your TV” on page 7.)

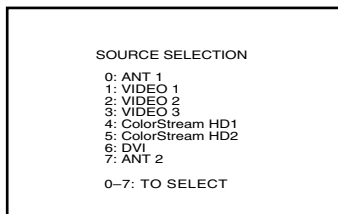

Pressing INPUT on the remote control displays the current signal source (press INPUT again or 0-7 to change)

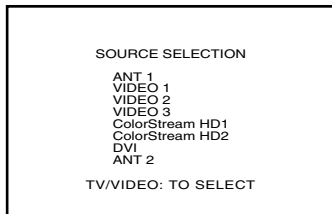

Pressing TV/VIDEO on the TV changes the current signal source

Note:

- When ColorStream HD1/HD2 or DVI is selected, the video OUT jack does not output a signal. To receive a video OUT signal, use a standard video or S-video IN connection instead of a ColorStream or DVI/HDCP connection.
- If you select ColorStream HD1/HD2 or DVI while the POP picture is active, the POP window will close.

Please note the following regarding the DVI source selection:

This TV is not intended for connection to and should not be used with a PC (personal computer). See “Connecting a device to the DVI/HDCP input” on page 13 for details.

Labeling the video input sources

The video label feature allows you to label each input source for your TV, from the following preset list of labels:

- : Uses the default label name
- VCR : Video cassette recorder
- DVD : DVD video
- DTV : Digital TV set-top box
- SAT : Satellite box
- CBL : Cable box
- HD : DVI/HDCP device (see page 13)

To label the video input sources:

- Press MENU, and then press ◀ or ▶ until the CUSTOM menu appears.
- Press ▲ or ▼ to highlight VIDEO LABEL.

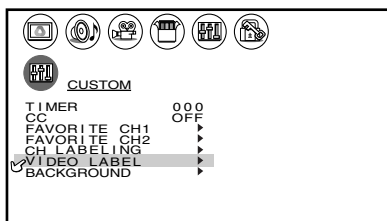

- Press ◀ or ▶ to display the VIDEO LABEL menu.
- Press ▲ or ▼ to highlight the video source you want to label.
- Press ◀ or ▶ to select the desired label for that input source.

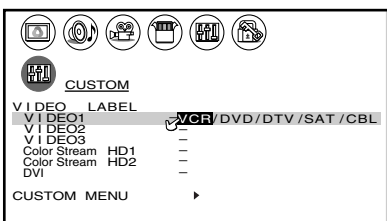

- Finish labeling the other video sources as desired. To return to the previous menu, press ▲ or ▼ to highlight CUSTOM MENU, and then press ◀ or ▶.
- To exit the menu, press EXIT.

Note:

The HD (high-definition) label is available for DVI mode only (see “Selecting the video input source” above, and “Connecting a device to the DVI/HDCP input” on page 13).

TV front panel

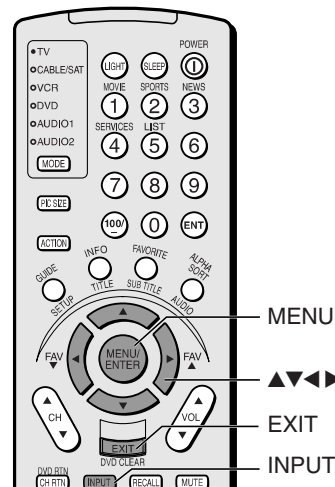
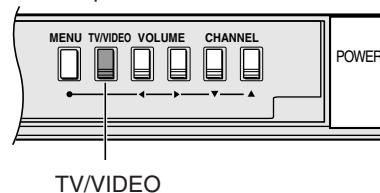

Using the closed caption feature

The closed caption feature has two options:

- Captions—An on-screen display of the dialogue, narration, and sound effects of TV programs and videos that are closed captioned (usually marked as “CC” in TV listings).
- Text—An on-screen display of information not related to the current program, such as weather or stock data (when provided by individual stations).

To view captions or text:

1. Tune the TV to the desired program.
2. Press MENU, and then press ◀ or ▶ until the CUSTOM menu appears.
3. Press ▼ or ▲ to highlight CC.

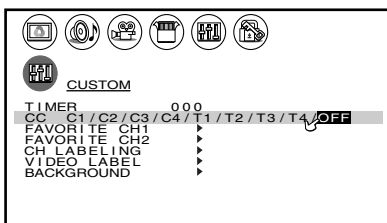

4. Press ◀ or ▶ to highlight the desired closed caption mode, as follows:
 - To view captions, highlight C1, C2, C3, or C4 (C1 displays captions in the primary language of your area).

Note: If the program or video you selected is not closed captioned, no captions will display on-screen.



- To view text, highlight T1, T2, T3, or T4.

Note: If text is not available in your area, a black rectangle may appear on-screen. If this happens, turn the Closed Caption feature OFF.

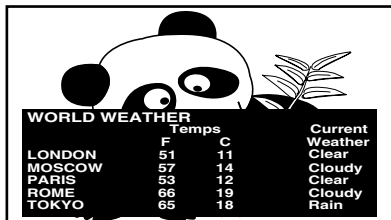

To turn off the Closed Caption feature:

Highlight OFF in step 4 above.

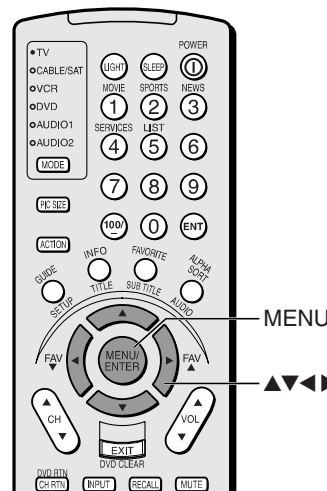

Note:

A closed caption signal may not display in the following situations:

- when a videotape has been dubbed
- when the signal reception is weak
- when the signal reception is nonstandard

Setting the sleep timer

To set the sleep timer to turn off the TV automatically:

1. Press SLEEP to set the length of time until the TV turns off.

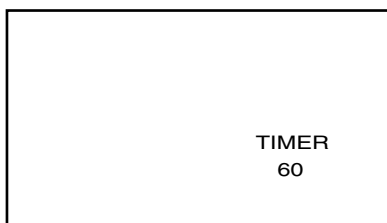

Every time you press SLEEP, the time will increase by 10 minutes, to a maximum of 180 minutes.

10 → 20 — — — → 170 → 180 → 0 → 10 MIN.

To cancel the sleep timer:

Press SLEEP until it is set to 0.

You also can set the timer using the on-screen menu:

1. Press MENU, and then press ◀ or ▶ until the CUSTOM menu appears.
2. Press ▲ or ▼ to highlight TIMER.
3. After the number position starts to blink, press the Number buttons (0–9) to enter the length of time until the TV turns off automatically.
4. Press ENTER to start the timer.

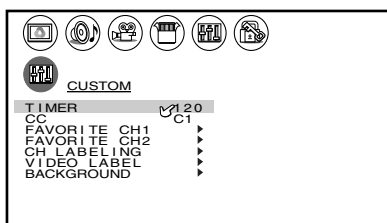

Note :

To display the amount of time left until the TV turns off automatically, press SLEEP once.

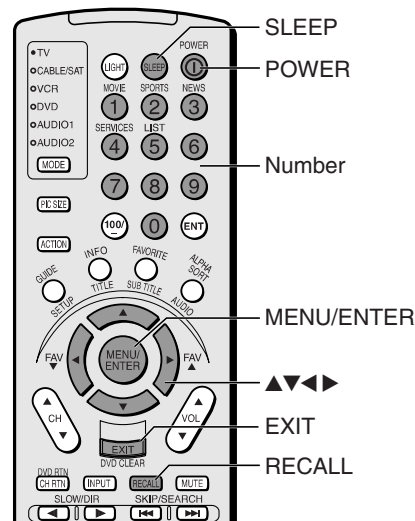

Setting the clock

To set the clock:

1. Press MENU, and then press ◀ or ▶ until the SET UP menu appears.
2. Press ▲ or ▼ to highlight CLOCK SET.
3. After the number position starts to blink, press the Number buttons (0-9) to enter the correct time. The clock operates on a 12-hour cycle.
4. Press ENTER to start the clock.

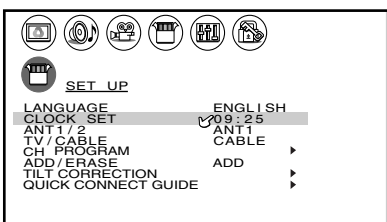

Note :

If the TV's power source is interrupted (for example, if the power cord is unplugged or a power failure occurs), the clock must be reset.

To display the time on-screen:

Press RECALL.

Adjusting the sound

Muting the sound

Press MUTE to temporarily reduce (1/2 MUTE) or turn off (MUTE) the sound. While the sound is off, the screen will display “1/2 MUTE” or “MUTE” in the lower right corner. Each time you press MUTE, the mute mode will change in the following order.

→ Normal → 1/2 MUTE → MUTE →

When you select “MUTE” mode, the closed caption feature is automatically activated. To deactivate this feature, press MUTE again. This feature works only when the closed caption mode is set to OFF. See “Using the closed caption feature” on page 47 for more information.

Selecting stereo/SAP broadcasts

The multi-channel TV sound (MTS) feature allows you to listen to high-fidelity stereo sound while watching TV. MTS can also transmit a second audio program (SAP) containing a second language, music, or other audio information (when provided by individual stations).

When the TV receives a stereo or SAP broadcast, the word “STEREO” or “SAP” appears on-screen every time the TV is turned on, the channel is changed, or the RECALL button is pressed.

The MTS feature is not available when the TV is in VIDEO mode.

To listen to stereo sound:

1. Press MENU, and then press ◀ or ▶ until the AUDIO menu appears.
2. Press ▲ or ▼ to highlight MTS.
3. Press ◀ or ▶ to highlight STEREO.

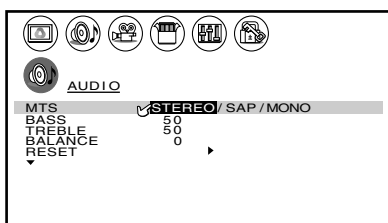

You can leave your TV in STEREO mode because it will automatically output the type of sound being broadcast (stereo or monaural). The word “STEREO” or “SAP” displays in yellow in the menu when the TV receives the signal.

If the stereo sound is noisy, select MONO to reduce the noise.

To listen to SAP (if available):

1. Press MENU, and then press ◀ or ▶ until the AUDIO menu appears.
2. Press ▲ or ▼ to highlight MTS.
3. Press ◀ or ▶ to highlight SAP. You will hear the station's second audio program (if available) from the speakers, while viewing the original picture (see note at right).

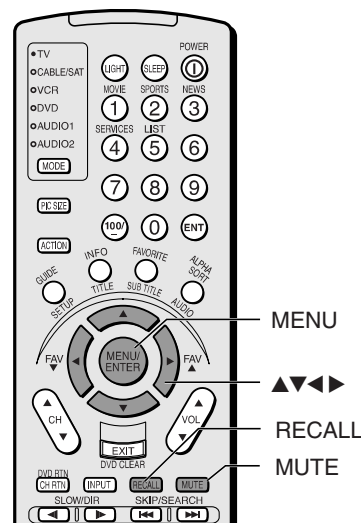

Note :

A second audio program (SAP) can be heard only on those TV stations that offer it.

For example, a station might broadcast music as a second audio program. If you have SAP on, you will see the current program on the screen but hear music instead of the program's normal audio.

However, if you have SAP on, and the station you are watching is not currently broadcasting a second audio program, you will see the picture but not hear any sound. If this happens, put the TV in STEREO mode so you can hear the station's normal audio.

Using the WOW™ surround sound feature

The WOW™ surround sound feature expands the audio listening field wider and deeper to create exceptional sound quality from the TV's speakers. WOW consists of three features—SRS 3D, FOCUS and TruBass—that use stereo signals from a TV broadcast or video input.

- SRS 3D — To turn on or off the surround sound effect.
- FOCUS — To turn on or off the vocal emphasis effect.
- TruBass — To select your desired bass expansion level (HIGH, LOW, or OFF).

To adjust the WOW feature:

1. Select STEREO mode (see “Selecting stereo/SAP broadcasts” on page 49).
2. Press MENU, and then press ◀ or ▶ until the THEATER menu appears.
3. Press ▲ or ▼ to highlight the desired WOW feature you want to adjust (SRS 3D, FOCUS, or TruBass), and then press ◀ or ▶ to adjust the item.

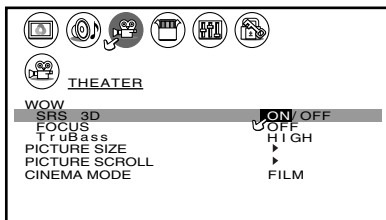

Adjusting the sound quality

You can change the quality of your TV's sound by adjusting the bass, treble, and balance.

To adjust the sound quality:

1. Press MENU, and then press ◀ or ▶ until the AUDIO menu appears.
2. Press ▲ or ▼ to highlight the item you want to adjust (BASS, TREBLE, or BALANCE).

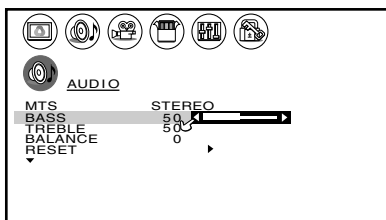

3. Press ◀ or ▶ to adjust the level.
 - ◀ makes the sound quality weaker or decreases the balance in the right channel, depending on the item selected.
 - ▶ makes the sound quality stronger or decreases the balance in the left channel, depending on the item selected.

Note:

If the broadcast is monaural, the SRS 3D effect does not work.

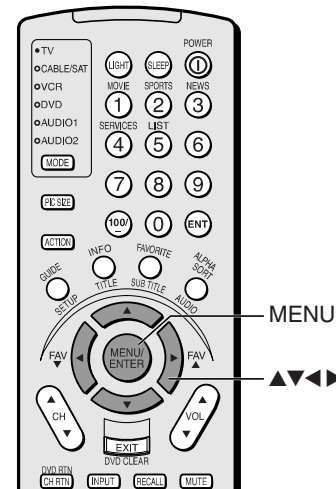

Resetting your audio adjustments

The RESET function returns your audio adjustments to the following factory settings:

- Bass center (50)
- Treble center (50)
- Balance center (0)

To reset your audio adjustments:

1. Press MENU, and then press ◀ or ▶ until the AUDIO menu appears.
2. Press ▲ or ▼ to highlight RESET.
3. Press ◀ or ▶. The menu displays "DONE."

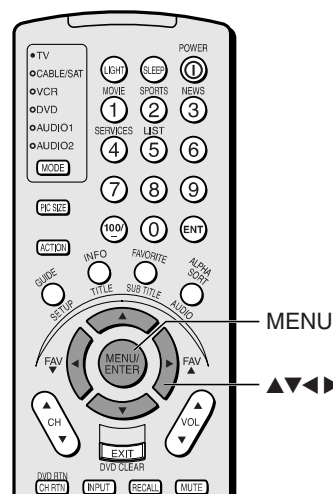
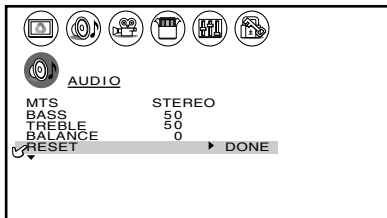

Using the CYCLONE® sub-woofer system

Toshiba's CYCLONE® ABX (Acoustic Bass eXpansion) system provides dynamic acoustic reproduction in a self-enclosed bass-reflex sub-woofer system.

To turn on the CYCLONE® sub-woofer system and adjust the CYCLONE level:

1. Press MENU, and then press ◀ or ▶ until the AUDIO menu appears.
2. Press ▲ or ▼ to highlight CYCLONE.
3. Press ◀ or ▶ to highlight ON.

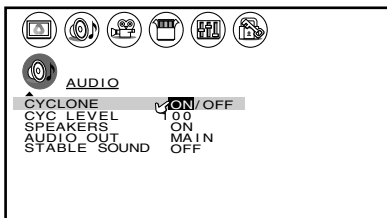

4. Press ▲ or ▼ to highlight CYC LEVEL.
5. Press ◀ or ▶ to adjust the CYCLONE level (sub-woofer volume).
Press ▶ to increase the sub-woofer volume.
Press ◀ to decrease the sub-woofer volume.

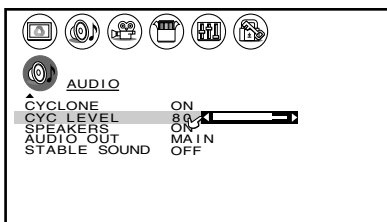

To turn off the CYCLONE® sub-woofer system:

Highlight OFF in step 3 above.

Note:

If the CYCLONE level is adjusted when the CYCLONE system is OFF, the CYCLONE system is automatically set to ON.

Turning off the built-in speakers

Use this feature to turn off the TV speakers when you connect an audio system (see “Connecting an audio system” on page 14).

To turn off the built-in speakers:

1. Press MENU, and then press ◀ or ▶ until AUDIO menu appears.
2. Press ▲ or ▼ to highlight SPEAKERS.
3. Press ◀ or ▶ to highlight OFF.

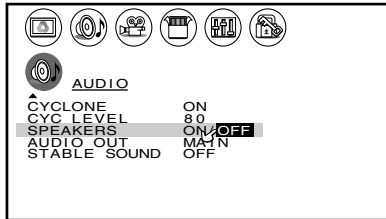

To turn on the built-in speakers:

Highlight ON in step 3 above.

Selecting the Audio OUT sound

This feature allows you to select the sound source (MAIN or POP) output from the Audio OUT jacks (see “Connecting two VCRs” on page 12).

This is useful when amplifying or recording the POP sound with external equipment while hearing the sound of the main picture through the built-in speakers.

To select the Audio OUT sound:

1. Press MENU, and then press ◀ or ▶ until the AUDIO menu appears.
2. Press ▲ or ▼ to highlight AUDIO OUT.
3. Press ◀ or ▶ to select MAIN or POP.

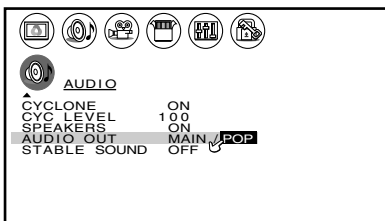

- MAIN: Outputs the sound of the main program from the Audio OUT jacks.
- POP : Outputs the sound of the POP program from the Audio OUT jacks.

Note:

Make sure the volume control of your audio amplifier is set to a moderate listening level.

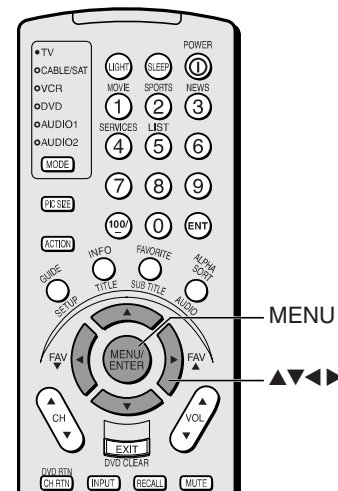

Using the StableSound® feature

When the signal source is changed, the StableSound® feature limits the highest volume level to prevent extreme changes in volume (for example, to prevent the extreme increase in volume that often happens when a TV program switches to a commercial).

To turn on the StableSound® feature:

1. Press MENU, and then press ◀ or ▶ until the AUDIO menu appears.
2. Press ▲ or ▼ to highlight STABLE SOUND.
3. Press ◀ or ▶ to select ON.

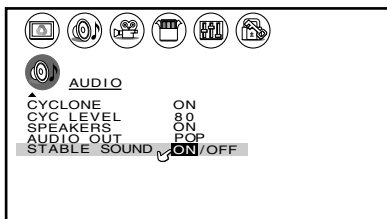

To turn off the StableSound® feature:

Highlight OFF in step 3 above.

Selecting the background of the menu display

You can change the background of the menu display by selecting from two preset types: shaded and solid (gray).

To select the background:

1. Press MENU, and then press ◀ or ▶ until the CUSTOM menu appears.
2. Press ▲ or ▼ to highlight BACKGROUND.
3. Press ◀ or ▶ to select either SHADED or SOLID.

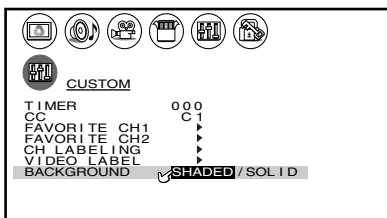

Displaying on-screen information

Press RECALL to display the following information on-screen:

- Antenna mode (when in TV mode)
- Channel number or video mode selected
- Time (if set)
- Channel label (if set)
- Stereo or SAP audio status
- V-CHIP rating status
- Picture size

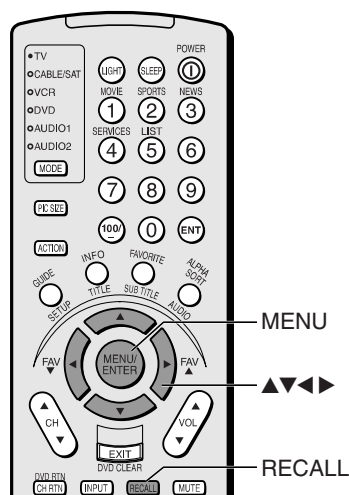
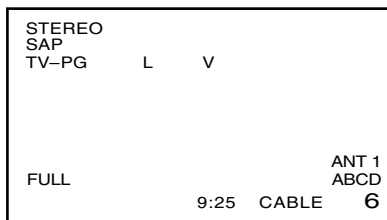

Viewing the demonstration mode

The demonstration mode demonstrates several of your TV's features.

To start the demo:

Press and hold MENU on the TV for 4 seconds.

To stop the demo:

Press RECALL, EXIT, or POWER.

Understanding the auto power off feature

The TV automatically turns itself off after approximately 15 minutes if it is tuned to a vacant channel or a station that completes its broadcast for the day. This feature does not work in VIDEO mode.

Understanding the last mode memory feature

If the power is cut off while the TV is on, the Last Mode Memory feature turns on the TV automatically when the power is resupplied.

If the power is going to be off for a long time and you are going to be away from your TV, unplug the power cord to prevent the TV from turning on in your absence.

Appendix

Specifications

Design and specifications are subject to change without notice.

Television System NTSC standard	Dimensions Width 33-3/4 inches (857.3 mm) Height 24-1/4 inches (616 mm) Depth 23-1/2 inches (596.9 mm)
Channel Coverage VHF: 2 through 13 UHF: 14 through 69 Cable TV: Mid band (A-8 through A-1, A through I) Super band (J through W) Hyper band (AA through ZZ, AAA, BBB) Ultra band (65 through 94, 100 through 125)	Weight 176 lbs (79.8 kg)
Power Source 120 V AC, 60 Hz	Supplied Accessories Remote Control with 2 size "AA" alkaline batteries
Power Consumption 156 W (average)	Optional TV Stand ST34W62
Audio Power 10 W + 10 W + 13 W sub-woofer	
Speaker Type Two 6x12 cm One 10 cm round sub-woofer	
Video/Audio Terminals S-VIDEO INPUT Y : 1 V(p-p), 75 ohm, negative sync. C : 0.286 V(p-p) (burst signal), 75 ohm VIDEO/AUDIO INPUT VIDEO: 1 V(p-p), 75 ohm, negative sync. AUDIO: 150 mV(rms) (30% modulation equivalent, 47 kohm) ColorStream® (component video) INPUT Y : 1V(p-p), 75 ohm PR: 0.7 V(p-p), 75 ohm PB: 0.7 V(p-p), 75 ohm AUDIO: 150 mV(rms), 47 kohm VIDEO/AUDIO OUTPUT VIDEO: 1 V(p-p), 75 ohm, negative sync. AUDIO: 150 mV(rms) (30% modulation equivalent, 4.7 kohm) VARIABLE AUDIO OUTPUT 0–300 mV(rms) (30% modulation equivalent, 4.7 kohm) AUDIO CENTER CHANNEL INPUT 300 mV(rms) (30% modulation equivalent, 10 kohm) DVI/HDCP INPUT HDCP compliant E-EDID* 1.3 compliant DVI-D uncompressed, high-speed, digital single-link connection Suggested scan rates: 1080i, 480p, 480i	

*E-EDID = Enhanced-Extended Display Identification

Troubleshooting

Before calling a service technician, please check the following table for a possible cause of the problem and some solutions.

Problem	Solution
TV will not turn on	<ul style="list-style-type: none">• Make sure the power cord is plugged in, then press POWER.• The remote control batteries may be dead. Replace the batteries.
No picture, no sound	<ul style="list-style-type: none">• Check the antenna/cable connections.
No sound, picture OK	<ul style="list-style-type: none">• The sound may be muted. Press VOLUME.• The station may have broadcast difficulties. Try another channel.• Check that the SPEAKERS function in AUDIO menu is set properly.
Poor picture, sound OK	<ul style="list-style-type: none">• Check the antenna connections.• The station may have broadcast difficulties. Try another channel.• Adjust the PICTURE menu.
Poor reception of broadcast channels	<ul style="list-style-type: none">• The station may have broadcast difficulties. Try another channel.• Check the antenna connections.• If you are using a VCR, make sure the TV/VCR button is set correctly.
Cannot receive above channel 13	<ul style="list-style-type: none">• Make sure the TV/CABLE switch is set to the mode that corresponds with the signal source type (cable company or outside antenna).
Black box appears on the screen	<ul style="list-style-type: none">• The closed caption feature may be set to one of the Text modes (T1, T2, T3, or T4). Turn closed captioning OFF.
Unable to select a certain channel	<ul style="list-style-type: none">• The channel may be locked out with the CH LOCK feature, or erased with the ADD/ERASE feature.
Multiple images	<ul style="list-style-type: none">• The station may have broadcast difficulties. Try another channel.• Antenna reception may be poor. Use a highly directional outdoor antenna.
Poor color or no color	<ul style="list-style-type: none">• The station may have broadcast difficulties. Try another channel.• Adjust the TINT and/or COLOR in the PICTURE menu.
No stereo or SAP sound from a known MTS broadcast	<ul style="list-style-type: none">• Make sure the MTS feature is set properly.
The front panel buttons do not operate	<ul style="list-style-type: none">• Check the FRONT PANEL LOCK feature.
The remote control does not operate	<ul style="list-style-type: none">• Check whether the appropriate device mode is selected.• Remove all obstructions between the remote control and the remote control sensor in the TV.• The remote control batteries may be dead. Replace the batteries.
Cannot access signal input sources (Video1, Video2, Video3, ColorStream HD1/HD2, DVI/HDCP) and/or Channels 3 and 4.	<ul style="list-style-type: none">• Check the VIDEO LOCK feature.

Limited United States Warranty

for 27" FST PURE® and All Larger Television Models

Toshiba America Consumer Products, Inc. ("TACP") and Toshiba Hawaii, Inc. ("THI") make the following limited warranties to original consumers in the United States. **THESE LIMITED WARRANTIES EXTEND TO THE ORIGINAL CONSUMER PURCHASER OR ANY PERSON RECEIVING THIS TELEVISION AS A GIFT FROM THE ORIGINAL CONSUMER PURCHASER AND TO NO OTHER PURCHASER OR TRANSFEREE.**

PRODUCTS PURCHASED IN THE U.S.A. AND USED IN CANADA ARE NOT COVERED BY THESE WARRANTIES.

PRODUCTS PURCHASED IN CANADA AND USED IN THE U.S.A. ARE NOT COVERED BY THESE WARRANTIES.

Limited One (1) Year Warranty on Parts and Labor*

TACP/THI warrant this television and its parts against defects in materials or workmanship for a period of one (1) year after the date of original retail purchase. **DURING THIS PERIOD, TACP/THI WILL, AT TACP/THI'S OPTION, REPAIR OR REPLACE A DEFECTIVE PART WITH A NEW OR REFURBISHED PART WITHOUT CHARGE TO YOU FOR PARTS OR LABOR.** TACP/THI Authorized Service Station personnel will come to your home when warranty service is required. Depending on the type of repair required, either the service will be performed in your home or the set will be taken to the TACP/THI Authorized Service Station for repair and returned to your home at no cost to you.

Limited Two (2) Year Warranty on Picture Tube*

TACP/THI further warrant the picture tube in this television against defects in materials or workmanship for a period of two (2) years after the date of original retail purchase. **DURING THIS PERIOD, TACP/THI WILL, AT TACP/THI'S OPTION, REPAIR OR REPLACE A DEFECTIVE PICTURE TUBE WITH A NEW OR REFURBISHED PICTURE TUBE WITHOUT CHARGE TO YOU, EXCEPT THAT, IF A DEFECTIVE PICTURE TUBE IS REPAIRED OR REPLACED AFTER ONE (1) YEAR FROM THE DATE OF THE ORIGINAL RETAIL PURCHASE, YOU PAY LABOR CHARGES INVOLVED IN THE REPAIR OR REPLACEMENT.**

Rental Units

The warranty for rental units begins with the date of first rental or thirty (30) days from the date of shipment to the rental firm, whichever comes first.

*Commercial Units

Televisions sold and used for commercial purposes have a limited ninety (90) day warranty for all parts, labor, and picture tubes.

Owner's Manual and Product Registration Card

Read this owner's manual thoroughly before operating this television. Complete and mail the enclosed product registration card within ten days after you, or the person who has given you this product as a gift, purchased this television. Returning the product registration card will enable TACP/THI to provide you with better customer service and improved product support. Failure to return the product registration card will not affect your rights under this warranty.

Your Responsibility

THE ABOVE WARRANTIES ARE SUBJECT TO THE FOLLOWING CONDITIONS:

- (1) You must provide your bill of sale or other proof of purchase.
- (2) All warranty servicing of this television must be made by an Authorized TACP/THI Service Station.
- (3) The warranties from TACP and THI are effective only if the television is purchased and operated in the U.S.A. or Puerto Rico.

- (4) Labor service charges for set installation, setup, adjustment of customer controls, and installation or repair of antenna systems are not covered by these warranties. Reception problems caused by inadequate antenna systems are your responsibility.
- (5) Warranties extend only to defects in materials or workmanship as limited above and do not extend to any television or parts that have been lost or discarded by you or to damage to television or parts caused by misuse, accident, Acts of God (such as lightning or fluctuations in electric power), improper installation, improper maintenance, or use in violation of instructions furnished by TACP/THI; or to units that have been modified or had the serial number removed, altered, defaced, or rendered illegible.

How to Obtain Warranty Services

If, after following all of the operating instructions in this manual and checking the "Troubleshooting" section, you find that service is needed:

- (1) To find the nearest TACP/THI Authorized Service Station:
For televisions purchased in the United States, except Hawaii, visit TACP's web site at www.toshiba.com/tacp, or call toll free 1-800-631-3811.
For televisions purchased in Hawaii, contact Toshiba Hawaii, Inc., 327 Kamakee Street, Honolulu, HI 96814, (808) 591-9281.
- (2) Present your bill of sale or other proof of purchase to the Authorized Service Station. Authorized TACP/THI Service Station personnel will come to your home when warranty service is required. Depending on the type of repair required, either the service will be performed in your home or the set will be taken to the Authorized Service Station for repair and returned to your home at no cost to you.

**For additional information, visit TACP's web site:
www.toshiba.com/tacp.**

ALL WARRANTIES IMPLIED BY THE LAW OF ANY STATE OF THE U.S.A., INCLUDING THE IMPLIED WARRANTIES OF MERCHANTABILITY AND FITNESS FOR A PARTICULAR PURPOSE, ARE EXPRESSLY LIMITED TO THE DURATION OF THE LIMITED WARRANTIES SET FORTH ABOVE. WITH THE EXCEPTION OF ANY WARRANTIES IMPLIED BY THE LAW OF ANY STATE OF THE U.S.A. AS HEREBY LIMITED, THE FOREGOING WARRANTY IS EXCLUSIVE AND IN LIEU OF ALL OTHER WARRANTIES, GUARANTEES, AGREEMENTS, AND SIMILAR OBLIGATIONS OF TACP OR THI WITH RESPECT TO THE REPAIR OR REPLACEMENT OF ANY PARTS. IN NO EVENT SHALL TACP OR THI BE LIABLE FOR CONSEQUENTIAL OR INCIDENTAL DAMAGES.

No person, agent, distributor, dealer, or company is authorized to change, modify, or extend the terms of these warranties in any manner whatsoever. The time within which action must be commenced to enforce any obligation of TACP or THI arising under this warranty or under any law of the United States or of any state thereof is hereby limited to 90 days from the date you discover, or should have discovered, the defect. This limitation does not apply to implied warranties arising under the law of any state of the U.S.A.

THIS WARRANTY GIVES YOU SPECIFIC LEGAL RIGHTS, AND YOU MAY ALSO HAVE OTHER RIGHTS, WHICH MAY VARY FROM STATE TO STATE IN THE U.S.A. SOME STATES OF THE U.S.A. DO NOT ALLOW LIMITATIONS ON THE DURATION OF AN IMPLIED WARRANTY, LIMITATIONS ON THE TIME WITHIN WHICH AN ACTION MAY BE BROUGHT, OR THE EXCLUSION OR LIMITATION OF INCIDENTAL OR CONSEQUENTIAL DAMAGES; THEREFORE, THE ABOVE LIMITATIONS OR EXCLUSIONS MAY NOT APPLY TO YOU UNDER SUCH CIRCUMSTANCES.

FST PURE® is a registered trademark of Toshiba America Consumer Products, Inc.
REV. MAR02

Limited Canada Warranty

for 27" FST PURE® and All Larger Television Models

Toshiba of Canada Limited ("TCL") makes the following limited warranties to original consumers in Canada.

THESE LIMITED WARRANTIES EXTEND TO THE ORIGINAL CONSUMER PURCHASER OR ANY PERSON RECEIVING THIS TELEVISION AS A GIFT FROM THE ORIGINAL CONSUMER PURCHASER AND TO NO OTHER PURCHASER OR TRANSFEREE.

PRODUCTS PURCHASED IN THE U.S.A. AND USED IN CANADA ARE NOT COVERED BY THESE WARRANTIES.

PRODUCTS PURCHASED IN CANADA AND USED IN THE U.S.A. ARE NOT COVERED BY THESE WARRANTIES.

Limited One (1) Year Warranty on Parts and Labor*

TCL warrants this television and its parts against defects in materials or workmanship for a period of one (1) year after the date of original retail purchase. DURING THIS PERIOD, TCL WILL, AT TCL'S OPTION, REPAIR OR REPLACE A DEFECTIVE PART WITH A NEW OR REFURBISHED PART WITHOUT CHARGE TO YOU FOR PARTS OR LABOR. TCL Authorized Service Depot personnel will come to your home when warranty service is required. Depending on the type of repair required, either the service will be performed in your home or the set will be taken to the TCL Authorized Service Depot for repair and returned to your home at no cost to you. IN-HOME SERVICE ONLY APPLIES WITHIN 100 KILOMETERS OF AN AUTHORIZED TCL SERVICE DEPOT.

Limited Two (2) Year Warranty on Picture Tube*

TCL further warrants the picture tube in this television against defects in materials or workmanship for a period of two (2) years after the date of original retail purchase. DURING THIS PERIOD, TCL WILL, AT TCL'S OPTION, REPAIR OR REPLACE A DEFECTIVE PICTURE TUBE WITH A NEW OR REFURBISHED PICTURE TUBE WITHOUT CHARGE TO YOU, EXCEPT THAT, IF A DEFECTIVE PICTURE TUBE IS REPAIRED OR REPLACED AFTER ONE (1) YEAR FROM THE DATE OF THE ORIGINAL RETAIL PURCHASE, YOU PAY LABOR CHARGES INVOLVED IN THE REPAIR OR REPLACEMENT.

Rental Units

The warranty for rental units begins with the date of first rental or thirty (30) days from the date of shipment to the rental firm, whichever comes first.

*Commercial Units

Televisions sold and used for commercial purposes have a limited ninety (90) day warranty for all parts, labor, and picture tubes.

Owner's Manual

Read this owner's manual thoroughly before operating this television.

Your Responsibility

THE ABOVE WARRANTIES ARE SUBJECT TO THE FOLLOWING CONDITIONS:

- (1) You must provide your bill of sale or other proof of purchase.
- (2) All warranty servicing of this television must be made by an Authorized TCL Service Depot.
- (3) The warranties from TCL are effective only if the television is purchased in Canada from an authorized TCL dealer and operated in Canada.

- (4) Labor service charges for set installation, setup, adjustment of customer controls, and installation or repair of antenna systems are not covered by these warranties. Reception problems caused by inadequate antenna systems are your responsibility.
- (5) Warranties extend only to defects in materials or workmanship as limited above and do not extend to any television or parts that have been lost or discarded by you or to damage to television or parts caused by misuse, accident, Acts of God (such as lightning or fluctuations in electric power), improper installation, improper maintenance, or use in violation of instructions furnished by TCL; or to units that have been modified or had the serial number removed, altered, defaced, or rendered illegible.

How to Obtain Warranty Services

If, after following all of the operating instructions in this manual and checking the "Troubleshooting" section, you find that service is needed:

- (1) To find the nearest TCL Authorized Service Depot, visit TCL's web site: www.toshiba.ca.
- (2) Present your bill of sale or other proof of purchase to the Authorized Service Depot. Authorized TCL Service Depot personnel will come to your home when warranty service is required. Depending on the type of repair required, either the service will be performed in your home or the set will be taken to the Authorized Service Depot for repair and returned to your home at no cost to you. IN-HOME SERVICE ONLY APPLIES WITHIN 100 KILOMETERS OF AN AUTHORIZED TCL SERVICE DEPOT.

**For additional information, visit TCL's web site:
www.toshiba.ca**

ALL WARRANTIES IMPLIED BY THE LAW OF ANY PROVINCE OF CANADA, INCLUDING THE IMPLIED WARRANTIES OF MERCHANTABILITY AND FITNESS FOR A PARTICULAR PURPOSE, ARE EXPRESSLY LIMITED TO THE DURATION OF THE LIMITED WARRANTIES SET FORTH ABOVE. WITH THE EXCEPTION OF ANY WARRANTIES IMPLIED BY THE LAW OF ANY PROVINCE OF CANADA AS HEREBY LIMITED, THE FOREGOING WARRANTY IS EXCLUSIVE AND IN LIEU OF ALL OTHER WARRANTIES, GUARANTEES, AGREEMENTS, AND SIMILAR OBLIGATIONS OF TCL WITH RESPECT TO THE REPAIR OR REPLACEMENT OF ANY PARTS. IN NO EVENT SHALL TCL BE LIABLE FOR CONSEQUENTIAL OR INCIDENTAL DAMAGES.

No person, agent, distributor, dealer, or company is authorized to change, modify, or extend the terms of these warranties in any manner whatsoever. The time within which action must be commenced to enforce any obligation of TCL arising under this warranty or under any law of Canada or of any province thereof, is hereby limited to 90 days from the date you discover, or should have discovered, the defect. This limitation does not apply to implied warranties arising under the law of any province of Canada.

THIS WARRANTY GIVES YOU SPECIFIC LEGAL RIGHTS, AND YOU MAY ALSO HAVE OTHER RIGHTS, WHICH MAY VARY FROM PROVINCE TO PROVINCE IN CANADA. SOME PROVINCES OF CANADA DO NOT ALLOW LIMITATIONS ON THE DURATION OF AN IMPLIED WARRANTY, LIMITATIONS ON THE TIME WITHIN WHICH AN ACTION MAY BE BROUGHT, OR THE EXCLUSION OR LIMITATION OF INCIDENTAL OR CONSEQUENTIAL DAMAGES; THEREFORE, THE ABOVE LIMITATIONS OR EXCLUSIONS MAY NOT APPLY TO YOU UNDER SUCH CIRCUMSTANCES.

FST PURE® is a registered trademark of Toshiba America Consumer Products, Inc.
REV. MAR02

Index

A

A/V receiver connection	14
ANT 1/2	25
Antenna cables	7
Audio cables	7
AUDIO OUT sound, selecting	52
Audio system connection	14
Auto power off	54

B

BACKGROUND selection	53
Back of the TV	6

C

CableClear™ DNR	44
Cable converter box connection	8
Camcorder connection	12
CH ▲▼ buttons	26
Channel surf mode (SpeedSurf)	27
CH LABEL	30
CH LOCK	40
CH RTN button	29
Channel Number buttons	26
Channel programming	
ADD/ERASE	27
Automatic programming	26
TV/CABLE selection	26
Cinema mode	34
Clock, setting	48
Closed caption	47
Component video cables	7
Color temperature	45
CYCLONE® sub-woofer system	51

D

Demonstration mode	54
Double-window ("POP") feature	35
DNR (Digital Noise Reduction)	44
DTV receiver connection	11
DVD connection	9, 10
DVI-D cable	7
DVI/HDCP connection	13

F I

(FAV) ◀▶ buttons	29
FAVORITE button	30
Favorite channels	29
Front of the TV	6
Front panel lock	42
FOCUS feature	50
INPUT button	25, 46

L M

Labeling channels	30
Labeling video inputs	46
Language selection	25
Last mode memory	54
Locking channels	40
Locking video inputs	41
Locks menu	37
Menu system	23
MTS feature	49
MUTE button	49

P

Picture adjustments	
COLOR TEMPERATURE	45
FLESH TONE	44
Picture mode	44
Picture quality	43
Picture-out-picture (POP)	
PIP button	35
PIP CH ▲▼ buttons	35
SOURCE button	35
STILL button	36
SWAP button	36
Picture scroll	34
Picture size selection	32

R

RECALL button	54
Remote control	
Battery installation	15
Device code table	20–21
Functional key chart	16–17
Learning about the buttons	22
Operational feature reset	19
Programming	18
Searching and sampling the code	18
Volume Lock feature	19
RESET	45, 51

S

S-video cables	7
SAP sound	49
Satellite receiver connection	9
Scrolling the Theater Wide 2 or 3 picture	34
Set-top box	11
Sleep timer	48
Sound quality adjustments	50
SPEAKERS on/off	52
Specifications	55
SpeedSurf	27
SRS 3D surround	50
StableSound®	53
Stereo sound	49
SurfLock™	29

T

Theater wide picture	34
Tilt correction	28
Troubleshooting	56
TruBass feature	50
TV/VIDEO button	25

V

V-CHIP	
BLOCKING OPTION	39
ENABLE BLOCKING	38
MPAA RATING	39
NEW PIN CODE	42
TV RATING	38
Unlocking programs temporarily	40
VCR connection	7–12
Video cables	7
VIDEO LABEL	46
VIDEO LOCK	41

W

Warranty	57, 58
WOW surround sound feature	50

TOSHIBA AMERICA CONSUMER PRODUCTS, INC.

HEAD OFFICE/82 TOTOWA ROAD, WAYNE, NEW JERSEY 07470
NATIONAL SERVICE DIVISION:1420B TOSHIBA DRIVE, LEBANON, TN. 37087

TOSHIBA HAWAII, INC.

HEAD OFFICE/327 KAMAKEE STREET, HONOLULU, HAWAII 96814, U.S.A. TEL: (808) 591-9281

TOSHIBA OF CANADA LTD.

HEAD OFFICE/191 McNABB STREET MARKHAM, ONTARIO L3R 8H2, CANADA TEL: (905) 470-5400
SERVICE CENTERS/TORONTO: 191 McNABB STREET MARKHAM, ONTARIO L3R 8H2, CANADA TEL: (905) 470- 5400
MONTREAL: 1643, NORTH SERVICE RD., TRANS-CANADA HIGHWAY, DORVAL QUEBEC, H9P 1J1, CANADA
TEL: (514) 856-4100
VANCOUVER: 22171 FRASERWOOD WAY, RICHMOND, B.C. V6W 1J5, CANADA TEL: (604) 303-2500

MANUFACTURED BY

TOSHIBA AMERICA CONSUMER PRODUCTS, INC.

CYCLONE is a registered trademark of Toshiba Corporation.
ColorStream and StableSound are registered trademarks of Toshiba America Consumer Products.
CableClear and SurfLock are trademarks of Toshiba America Consumer Products, Inc.

PRINTED IN USA
(02-10) B

TOSHIBA

Free Manuals Download Website

<http://myh66.com>

<http://usermanuals.us>

<http://www.somanuals.com>

<http://www.4manuals.cc>

<http://www.manual-lib.com>

<http://www.404manual.com>

<http://www.luxmanual.com>

<http://aubethermostatmanual.com>

Golf course search by state

<http://golfingnear.com>

Email search by domain

<http://emailbydomain.com>

Auto manuals search

<http://auto.somanuals.com>

TV manuals search

<http://tv.somanuals.com>