

TOSHIBA



Color Television

36A12

Owner's Manual
COLORSTREAM®



Welcome to
Toshiba

Connecting
your TV

Using the
Remote Control

Setting up
your TV

Using the TV's
Features

Appendix

Dear Customer,

Thank you for purchasing this Toshiba TV. This manual will help you use the many exciting features of your new TV. **Before operating the TV, please read this manual completely**, and keep it nearby for future reference.

Safety Precautions

WARNING

TO REDUCE THE RISK OF FIRE OR ELECTRIC SHOCK, DO NOT EXPOSE THIS APPLIANCE TO RAIN OR MOISTURE.

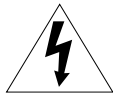

WARNING
RISK OF ELECTRIC SHOCK
DO NOT OPEN



WARNING: TO REDUCE THE RISK OF ELECTRIC SHOCK, DO NOT REMOVE COVER (OR BACK). NO USER-SERVICEABLE PARTS INSIDE. REFER SERVICING TO QUALIFIED SERVICE PERSONNEL.



The lightning symbol in the triangle tells you that the voltage inside this product may be strong enough to cause an electric shock. **DO NOT TRY TO SERVICE THIS PRODUCT YOURSELF.**



The exclamation mark in the triangle tells you that important operating and maintenance instructions follow this symbol.

NOTE TO CATV INSTALLERS IN THE USA

This is a reminder to call the CATV system installer's attention to Article 820-40 of the NEC, which provides guidelines for proper grounding and, in particular, specifies that the cable ground shall be connected to the grounding system of the building, as close to the point of cable entry as practical. For additional antenna grounding information, see items 24 and 25 on page 4.

NOTICE OF POSSIBLE TV STAND INSTABILITY



DANGER: RISK OF SERIOUS PERSONAL INJURY OR DEATH! Use this TV with

the TOSHIBA TV stand recommended in the "Specifications" section only. Use with other stands may result in instability, causing possible injury or death.

NOTICE OF POSSIBLE ADVERSE EFFECTS ON TV PICTURE TUBE

If a fixed (non-moving) pattern remains on the TV screen for long periods of time, the image can become permanently engrained in the picture tube. **This type of damage is NOT COVERED BY YOUR WARRANTY.** See item 32 on page 4.

Child Safety

It Makes A Difference Where Your TV Stands



Congratulations on your purchase! As you enjoy your new TV, keep these safety tips in mind:

The Issue

- If you are like most Americans, you have a TV in your home. Many homes, in fact, have more than one TV.
- The home theater entertainment experience is a growing trend, and larger TVs are popular purchases; however, they are not always supported on the proper TV stands.
- Sometimes TVs are improperly secured or inappropriately situated on dressers, bookcases, shelves, desks, audio speakers, chests, or carts. As a result, TVs may fall over, causing unnecessary injury.

Toshiba Cares!

- The consumer electronics industry is committed to making home entertainment enjoyable and safe.
- The Consumer Electronics Association formed the Home Entertainment Support Safety Committee, comprised of TV and consumer electronics furniture manufacturers, to advocate children's safety and educate consumers and their families about television safety.

Tune Into Safety

- One size does NOT fit all! Use appropriate furniture large enough to support the weight of your TV (and other electronic components).
- Use appropriate angle braces, straps, and anchors to secure your furniture to the wall (but never screw anything directly into the TV).
- Carefully read and understand the other enclosed instructions for proper use of this product.
- Do not allow children to climb on or play with furniture and TVs.
- Avoid placing any item on top of your TV (such as a VCR, remote control, or toy) that a curious child may reach for.
- Remember that children can become excited while watching a program and can potentially push or pull a TV over.
- Share our safety message about this hidden hazard of the home with your family and friends. Thank you!



2500 Wilson Blvd.
Arlington, VA 22201 U.S.A.
Tel. 703-907-7600 Fax 703-907-7690
www.CE.org

CEA is the Sponsor, Producer and Manager of the International CES®

Important Safety Instructions

- 1) **Read these instructions.**
- 2) **Keep these instructions.**
- 3) **Heed all warnings.**
- 4) **Follow all instructions.**



- 5) **Do not use this apparatus near water.**



- 6) **Clean only with a dry cloth.**

- 7) **Do not block any ventilation openings.** Install in accordance with the manufacturer's instructions.

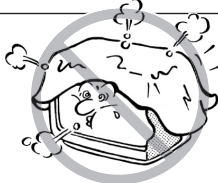

- 8) **Do not install near any heat sources** such as radiators, heat registers, stoves, or other apparatus (including amplifiers) that produce heat.

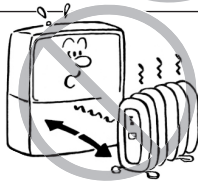

- 9) **Do not defeat the safety purpose of the polarized or grounding type plug.** A polarized plug has two blades with one wider than the other. A grounding type plug has two blades and a third grounding prong. The wide blade or the third prong are provided for your safety. If the provided plug does not fit into your outlet, consult an electrician for replacement of the obsolete outlet.

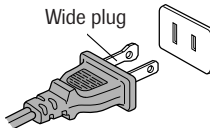

- 10) **Protect the power cord** from being walked on or pinched, particularly at plugs, convenience receptacles, and the point where it exits the apparatus.

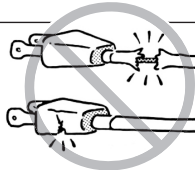

- 11) **Only use attachments/accessories specified by the manufacturer.**

- 12) **Use only with the cart, stand, tripod, bracket, or table specified by the manufacturer, or sold with the apparatus.** When a cart is used, use caution when moving the cart/apparatus combination to avoid injury from tip-over.



- 13) **Unplug this apparatus during lightning storms or when unused for long periods of time.**

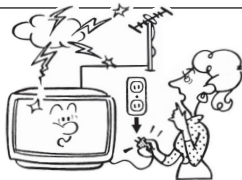

- 14) **Refer all servicing to qualified service personnel.** Servicing is required when the apparatus has been damaged in any way, such as power supply cord or plug is damaged, liquid has been spilled or objects have fallen into the apparatus, the apparatus has been exposed to rain or moisture, does not operate normally, or has been dropped.

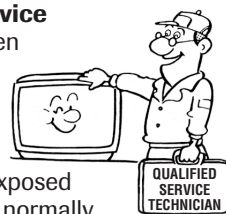

Installation, Care, and Service

Installation

Follow these recommendations and precautions and heed all warnings when installing your TV:

- 15) Never modify this equipment. Changes or modifications may void: a) the warranty, and b) the user's authority to operate this equipment under the rules of the Federal Communications Commission.

- 16) **DANGER: RISK OF SERIOUS PERSONAL INJURY, DEATH, OR EQUIPMENT DAMAGE!** Never place the TV on an unstable cart, stand, or table. The TV may fall, causing serious personal injury, death, or serious damage to the TV.



- 17) Never place or store the TV in direct sunlight; hot, humid areas; areas subject to excessive dust or vibration; or locations with temperatures at or below 41°F (5°C).

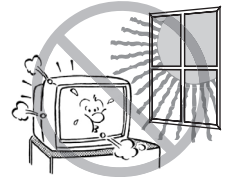

- 18) Always place the TV on the floor or a sturdy, level, stable surface that can support the weight of the unit.



- 19) Never place items such as vases, aquariums, or candles on top of the TV.



- 20) Never block or cover the slots or openings in the TV cabinet back, bottom, and sides. Never place the TV:
 - on a bed, sofa, rug, or similar surface;
 - too close to drapes, curtains, or walls; or
 - in a confined space such as a bookcase, built-in cabinet, or any other place with poor ventilation.

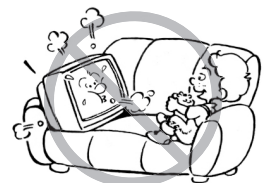

The slots and openings are provided to protect the TV from overheating and to help maintain reliable operation of the TV.

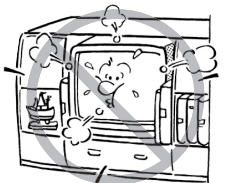

- 21) Never allow anything to rest on or roll over the power cord, and never place the TV where the power cord is subject to wear or abuse.

- 22) Never overload wall outlets and extension cords.



- 23) Always operate this equipment from a 120 VAC, 60 Hz power source only.



- 24) Always make sure the antenna system is properly grounded to provide adequate protection against voltage surges and built-up static charges (see Section 810 of the National Electric Code).

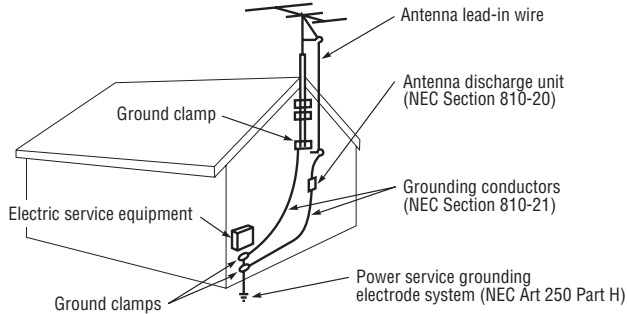

25) **DANGER: RISK OF SERIOUS PERSONAL INJURY OR DEATH!**



- Use extreme care to make sure you are never in a position where your body (or any item you are in contact with, such as a ladder or screwdriver) can accidentally touch overhead power lines. Never locate the antenna near overhead power lines or other electrical circuits.
- Never attempt to install any of the following during lightning activity:
 - a) an antenna system; or b) cables, wires, or any home theater component connected to an antenna or phone system.

Care

For better performance and safer operation of your TOSHIBA TV, follow these recommendations and precautions:

- 26) Always sit approximately 10–25 feet away from the TV and as directly in front of it as possible. The picture can appear dull if you sit too far to the left or right of the TV, or if sunlight or room lights reflect on the screen. Turn the TV off to check for reflections on the screen, and then remove the source of reflections while viewing the TV.

- 27) Always unplug the TV before cleaning. Never use liquid or aerosol cleaners.

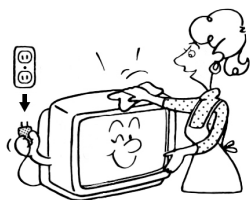

- 28) **WARNING: RISK OF ELECTRIC SHOCK!** Never spill liquids or push objects of any kind into the TV cabinet slots.



- 29) [This item applies to projection TVs only.] If the air temperature rises suddenly (for example, when the TV is first delivered), condensation may form on the lenses. This can make the picture appear distorted or the color appear faded. If this happens, turn off the TV for 6 to 7 hours to allow the condensation to evaporate.

- 30) For added protection of your TV from lightning and power surges, always unplug the power cord and disconnect the antenna from the TV if you leave the TV unattended or unused for long periods of time.

- 31) During normal use, the TV may make occasional snapping or popping sounds. This is normal, especially when the unit is being turned on or off. If these sounds become frequent or continuous, unplug the power cord and contact a Toshiba Authorized Service Center.

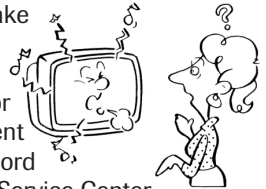

- 32) **Possible Adverse Effects on TV Picture Tube:** If a fixed (non-moving) pattern remains on the TV screen for long periods of time, the image can become permanently engrained in the picture tube and cause subtle but permanent ghost images. **This type of damage is NOT COVERED BY YOUR WARRANTY.** Never leave your TV on for long periods of time while it is displaying the following formats or images:

- **Fixed Images**, such as PIP/POP windows, stock tickers, video game patterns, TV station logos, and websites.
- **Special Formats** that do not use the entire screen. For example, viewing letterbox style (16:9) media on a normal (4:3) display (gray bars at top and bottom of screen); or viewing normal style (4:3) media on a widescreen (16:9) display (gray bars on left and right sides of screen).

Care

For better performance and safer operation of your TOSHIBA TV, follow these recommendations and precautions:

- 26) Always sit approximately 10–25 feet away from the TV and as directly in front of it as possible. The picture can appear dull if you sit too far to the left or right of the TV, or if sunlight or room lights reflect on the screen. Turn the TV off to check for reflections on the screen, and then remove the source of reflections while viewing the TV.

- 27) Always unplug the TV before cleaning. Never use liquid or aerosol cleaners.

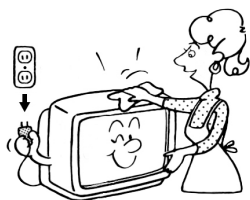

- 28) **WARNING: RISK OF ELECTRIC SHOCK!** Never spill liquids or push objects of any kind into the TV cabinet slots.



Service

- 33) **WARNING: RISK OF ELECTRIC SHOCK!** Never attempt to service the TV yourself. Opening and removing the covers may expose you to dangerous voltage or other hazards. Refer all servicing to a Toshiba Authorized Service Center.

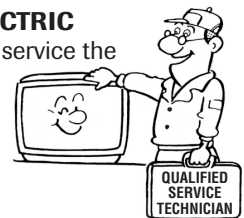

- 34) If you have the TV serviced:

- Ask the service technician to use only replacement parts specified by the manufacturer.
- Upon completion of service, ask the service technician to perform routine safety checks to determine that the TV is in safe operating condition.

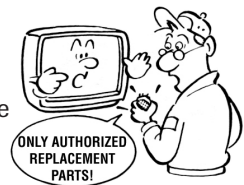

- 35) When the TV reaches the end of its useful life, ask a qualified service technician to properly dispose of the TV. Improper disposal may result in a picture tube implosion and possible personal injury.

Important Safety Information 2-4

Welcome to Toshiba 6

- Exploring your new TV 6
- Selecting a location for the TV 6

Connecting your TV 7

Note regarding picture quality 7

- Connecting a VCR 7
- Connecting a cable converter box 8
- Connecting a cable converter box and VCR 8
- Connecting a DVD player or satellite receiver and a VCR 9
- Connecting a DVD player with ColorStream® (component video) and a VCR 10
- Connecting two VCRs 10
- Connecting a camcorder 11
- Connecting an audio amplifier 11

Using the remote control 12

- Preparing the remote control for use 12
- Installing the remote control batteries 12
- Using the remote control with a VCR or cable TV converter 12
- Programming the remote control for use with a non-Toshiba VCR or cable TV converter 13
 - VCR code table 13
 - Cable TV converter code table 14
- Learning about the remote control 15

Setting up your TV 16

- Changing the on-screen display language 16
- Selecting the antenna input 16
- Selecting the signal source 17
- Programming channels into the TV's memory 17
 - Programming channels automatically 17
 - Adding and erasing channels manually 18
- Changing channels 18

Using the TV's features 19

- Adjusting the channel settings 19
- Switching between two channels 19
- Programming your favorite channels 19

Using the V-Chip Control (blocking) feature 20

- Selecting a PIN code 20
- Changing your PIN code 21
- Blocking programs by ratings 22
- Ratings definitions (MPAA, Youth TV, TV) 22
- Unblocking programs temporarily 23
- Blocking unrated movies and programs 23
- Blocking channels 24

Locking video inputs 25

Channel labels 26

Video labels 27

Watching picture-in-picture (PIP) 28

Switching the main and small pictures 28

Changing the location of the PIP window 29

Freezing the PIP display 29

Watching multi-window PIP 29

Adjusting the picture 30

Adjusting the picture quality 30

Selecting the color temperature 30

Adjusting the picture preference 31

Displaying on-screen information 31

Setting the off timer 31

Auto power off 31

Using the closed caption feature 32

Adjusting the sound 33

Muting the sound 33

Selecting stereo/SAP broadcasts 33

Adjusting the sound quality 34

Using the surround sound feature 34

Selecting variable audio OUT 35

Turning off the built-in speakers 35

Using the sub-bass system (SBS) 36

Viewing the demonstration (DEMO) mode 36

Understanding the last mode memory feature 36

Appendix 37

Troubleshooting 37

Cleaning and care 38

Specifications 38

Limited United States warranty 39

Limited Canada warranty 40

Welcome to Toshiba

Congratulations! You have purchased one of the finest color TVs on the market. The goal of this manual is to guide you through setting up and operating your Toshiba TV as quickly as possible. You may need to purchase other audio or video cables to connect your equipment. See "Connecting your TV" on page 7 for more information.

Please read all safety and operating instructions carefully before you proceed.

Exploring your new TV

You can operate your TV using the buttons on the front panel or the remote control. The front and back panels provide terminal connections for connecting other equipment to your TV.

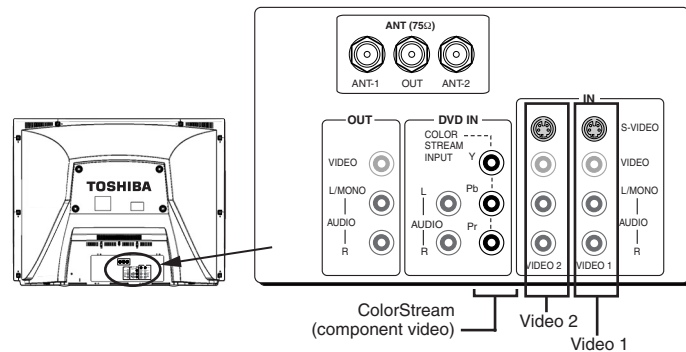
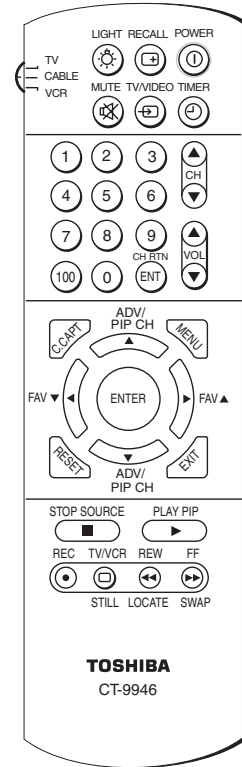
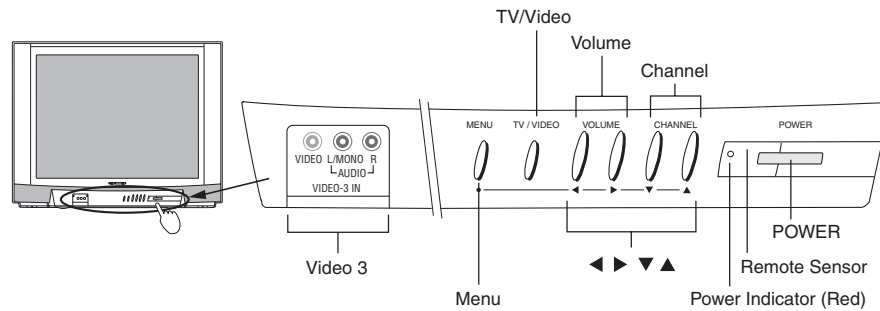

Selecting a location for the TV

- Place the TV on the floor or on the optional TV stand listed in the "Specifications" section.
- Place the TV in a location where light does not directly hit the screen.
- Place the TV far enough from the walls to allow proper ventilation. Inadequate ventilation may cause overheating, which may damage the TV.

The model and serial numbers are on the back of your TV. Record the numbers in the space below. Refer to these numbers whenever you communicate with your Toshiba dealer about this TV.

Model number: _____

Serial number: _____

Connecting your TV

Note: Cables are not supplied with your TV.

- **Coaxial cable** is the cable that comes in from your antenna, cable TV service, or cable converter box. Coaxial cable uses "F" connectors.
- **Standard stereo A/V cables** usually come in sets of three, and are typically color-coded according to use: yellow for video, red for stereo right audio, and white for stereo left (or mono) audio. Your TV's standard A/V inputs are color-coded in the same manner as the cables.
- **S-Video cable** is for use with video equipment that has S-Video connectors.
- **Component video cables** come in sets of three (typically color-coded red, green, and blue), and are for use with video equipment that has component video connectors. Your TV's ColorStream® (component video) inputs are color-coded in the same manner as the cables.

NOTE REGARDING PICTURE QUALITY

When connecting video equipment to your Toshiba TV:

- **For GOOD picture quality:** Use a standard yellow video cable.
- **For BETTER picture quality:** If your equipment has S-video connectors, use an S-video cable **instead of** a standard yellow video cable. (You still must connect the standard red and white audio cables for full system connection, but *do not connect a standard yellow video cable at the same time* or the picture performance will be unacceptable.)
- **For BEST picture quality:** If your equipment has component video connectors, use component video cables **instead of** a standard yellow video cable or S-video cable. (You still must connect the standard red and white audio cables for full system connection.)

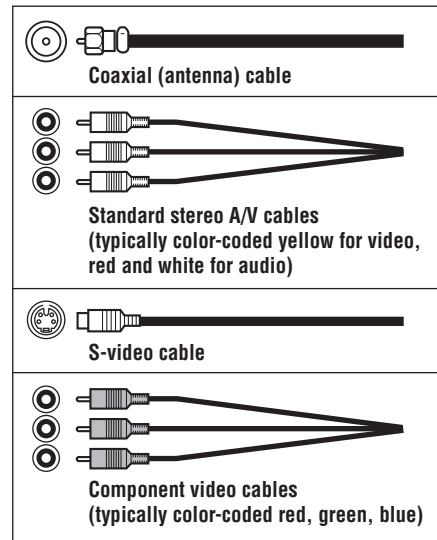

CAUTION: Do not plug in any power cords until you have finished connecting all equipment.

Connecting a VCR

This connection allows you to watch local channels and video programs, play or record on the VCR while watching TV, and record from one channel while watching another channel.

You will need:

- two coaxial cables (one or more may be supplied by the cable company)
- one pair of audio cables (one single audio cable for a mono VCR)
- one video cable

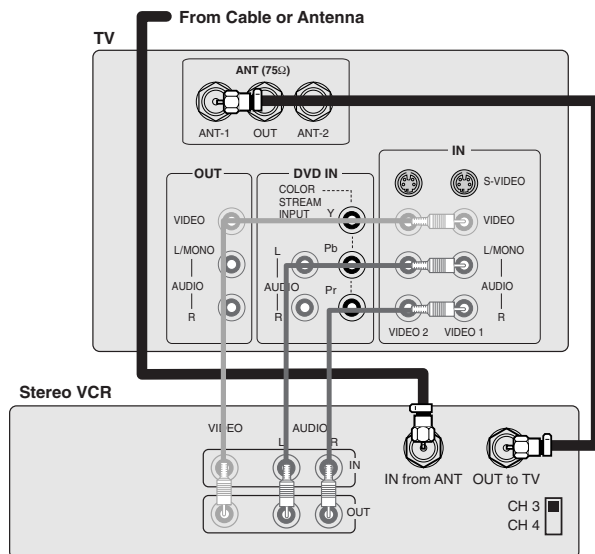

Note:

If you have a mono VCR, connect L/Mono to VCR Audio OUT using only one audio cable.

If you have an S-VHS VCR, use an S-video cable instead of a regular video cable.

Do not connect a regular video cable and an S-video cable to Video-1 (or Video-2) at the same time. Doing so will distort the picture.

The unauthorized recording, use, distribution, or revision of television programs, videotapes, DVDs, and other materials is prohibited under the Copyright Laws of the United States and other countries, and may subject you to civil and criminal liability.

Connecting a cable converter box

This connection allows you to watch basic and premium cable channels. To use the TV features (such as PIP swap, channel ▲▼, channel block, favorite channels, or channel labels), select ANT-1. To view premium channels, select ANT-2, tune the TV to channel 3 or 4 (whichever channel is vacant in your area), and use the converter box to change channels.

You will need:

- three coaxial cables (one or more may be supplied by the cable company)

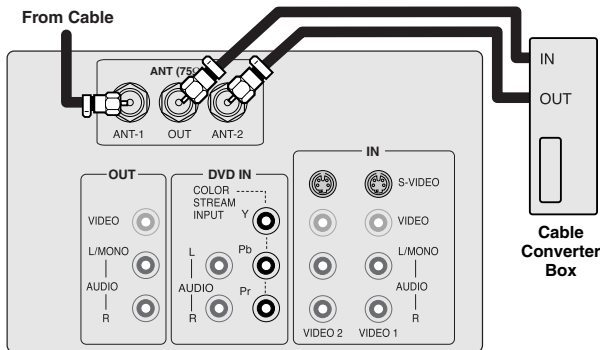

Note:

When you use a converter box with your TV, the remote control may not operate certain features, such as PIP swap, channel ▲▼, channel block, favorite channels, or channel labels.

The unauthorized recording, use, distribution, or revision of television programs, videotapes, DVDs, and other materials is prohibited under the Copyright Laws of the United States and other countries, and may subject you to civil and criminal liability.

Connecting a cable converter box and VCR

This connection allows you to watch and record basic and premium cable channels, as well as watch videotapes. Set the TV signal source to Video1 (see "Watching video input" on page 17). Tune the VCR to channel 3 or 4 (the same channel as the converter box output switch), and use the cable converter box to change channels. Set the PIP source to "TV" (see page 28).

You will need:

- five coaxial cables (one or more may be supplied by the cable company)
- one pair of audio cables (one single audio cable for a mono VCR)
- one video cable
- one cable splitter

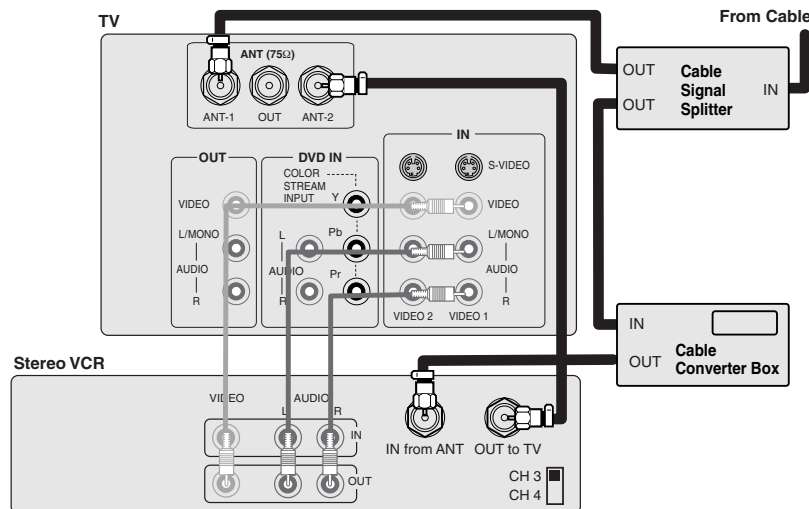

Note:

When you use a converter box with your TV, the remote control may not operate certain features, such as PIP swap, channel ▲▼, channel block, favorite channels, or channel labels.

If you have a mono VCR, connect L/Mono to VCR Audio OUT using only one audio cable.

If you have an S-VHS VCR, use an S-video cable instead of a regular video cable.

Do not connect a regular video cable and an S-video cable to Video-1 (or Video-2) at the same time.

Connecting a DVD player or satellite receiver and a VCR

This connection allows you to watch DVD/satellite, VCR, or TV programs. You can record from the DVD player/satellite receiver or TV. You can also record one TV channel while watching another channel.

Note: If your DVD player has component video connections, follow the connection instructions under "Connecting a DVD player with ColorStream™ (component video) and a VCR" on page 10.

You will need:

- three coaxial cables (one or more may be supplied by the cable company)
- three pairs of audio cables (one pair and two single audio cables for a mono VCR)
- two regular video cables
- one S-video cable

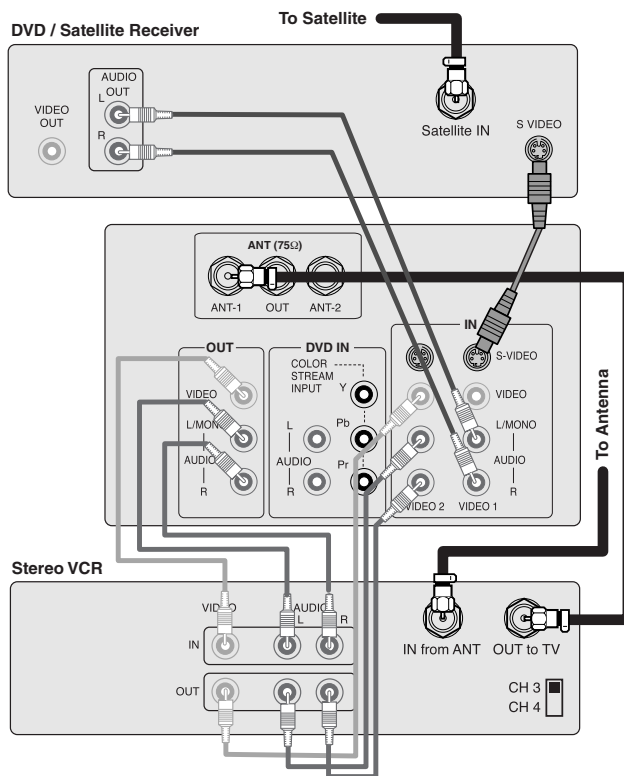

Note:

You can use a regular video cable instead of an S-video cable between the TV and DVD player/satellite receiver, but the picture quality will decrease.

The illustration at left shows one S-video cable and one pair of audio cables connected from the DVD player/satellite receiver to Video-1 on the TV.

Do not connect a regular video cable and an S-video cable to Video-1 (or Video-2) at the same time. Doing so will distort the picture.

When recording, set Audio Out to FIX (see "Selecting variable audio OUT" on page 35). With Audio Out set to FIX, the TV's volume setting during recording will not affect the sound level being recorded.

The unauthorized recording, use, distribution, or revision of television programs, videotapes, DVDs, and other materials is prohibited under the Copyright Laws of the United States and other countries, and may subject you to civil and criminal liability.

Connecting a DVD player with ColorStream® (component video) and a VCR

This connection allows you to watch DVD, VCR, or TV programs, and record DVD or TV programs (when authorized). You can record from one source while watching a program from another source.

Your TV has ColorStream (component video) connections. Connecting your TV to a component video compatible DVD player (such as a Toshiba DVD player with ColorStream®) can greatly enhance picture quality and performance.

You will need:

- two coaxial cables (one or more may be supplied by the cable company)
- three pairs of audio cables (one pair and two single audio cables for a mono VCR)
- two regular video cables
- one set of ColorStream (component) video cables

Note:

For the best picture performance, use ColorStream (component video) cables between the TV and DVD player. To record from the DVD player, the DVD player and TV must select VIDEO 1.

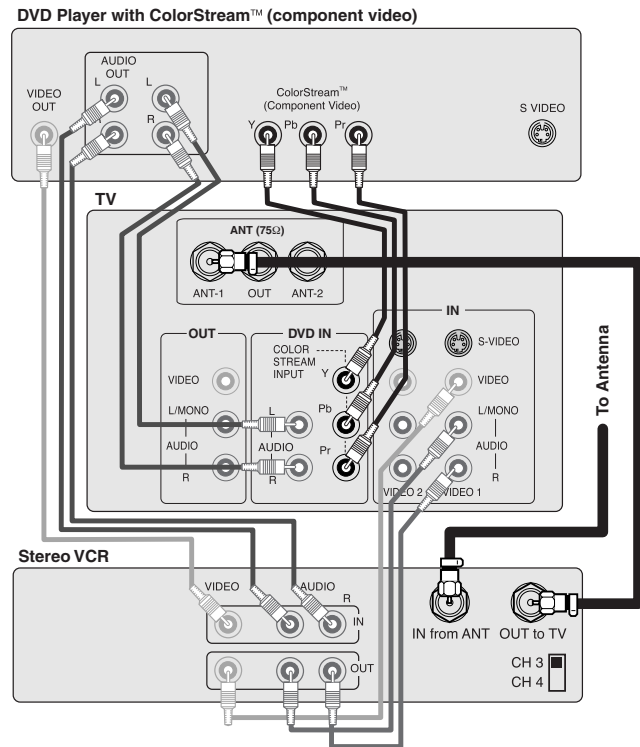

Connecting two VCRs

This connection allows you to record from one VCR to another VCR while watching a video program. You can also record from one TV channel while watching another channel.

You will need:

- two coaxial cables (one or more may be supplied by the cable company)
- two pairs of audio cables (two single audio cables for mono VCRs)
- two video cables

Stereo VCR [Playback]

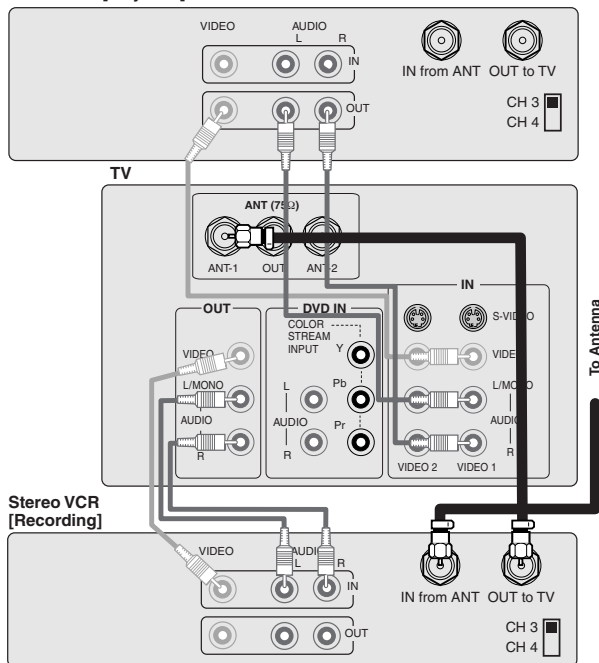

Note:

When recording, set Audio Out to FIX (see "Selecting variable audio OUT" on page 35). With Audio Out set to FIX, the TV's volume setting during recording will not affect the sound level being recorded.

The unauthorized recording, use, distribution, or revision of television programs, videotapes, DVDs, and other materials is prohibited under the Copyright Laws of the United States and other countries, and may subject you to civil and criminal liability.

Note:

If you have S-VHS VCRs, use S-video cables instead of regular video cables.

Do not connect a regular video cable and an S-video cable to Video-1 (or Video-2) at the same time.

Do not connect the same VCR to the output and input jacks on the TV at the same time.

Connecting a camcorder

This connection allows you to watch videos recorded on a camcorder.

You will need:

- one pair of audio cables
- one video cable

Note:

If your camcorder has an S-video connection, an S-video cable will provide better picture performance than a regular video cable.

Do not connect a regular video cable and an S-video cable to Video-1 (or Video-2) at the same time.

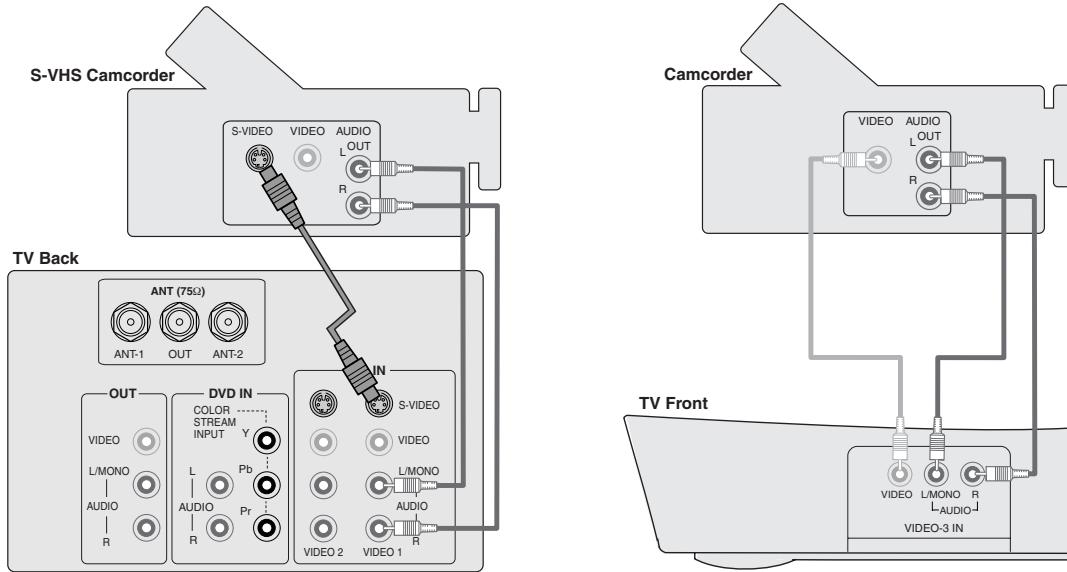

Connecting an audio amplifier

This connection allows you to use an audio amplifier to adjust the audio level. This connection also allows you to use external speakers.

You will need:

- one coaxial cable (may be supplied by the cable company)
- one pair of audio cables

Note:

To control the audio, both the TV and the amplifier must be turned on, and the volume of both must be set above 0, or you will not hear any sound. See "Selecting variable audio OUT" on page 35 for additional details.

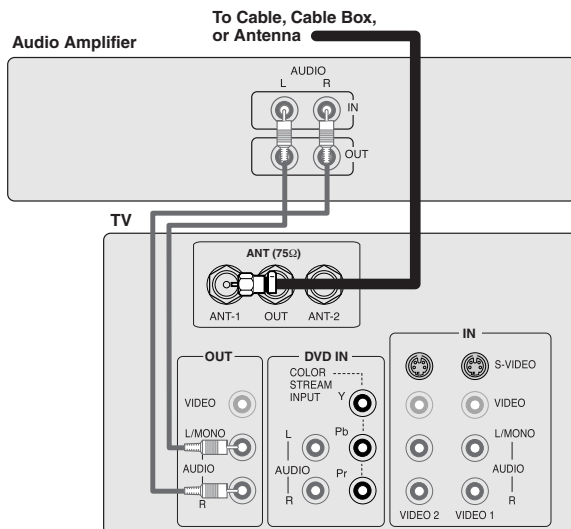

The unauthorized recording, use, distribution, or revision of television programs, videotapes, DVDs, and other materials is prohibited under the Copyright Laws of the United States and other countries, and may subject you to civil and criminal liability.

Using the remote control

Preparing the remote control for use

The remote control will operate your TV, most VCR models, and most cable TV converters together, even if they are different brands.

- If you will be using your TV with a Toshiba VCR or cable TV converter, your remote control is already programmed and ready to use. See “Using the remote control with a VCR or cable TV converter” below.
- If you own a non-Toshiba VCR or converter and want to use your TV remote control to operate it, you will need to program the remote control. See “Programming the remote control for use with a non-Toshiba VCR or cable TV converter” on page 13.

Installing the remote control batteries

To install the batteries:

1. Slide the battery cover off the back of the remote control.

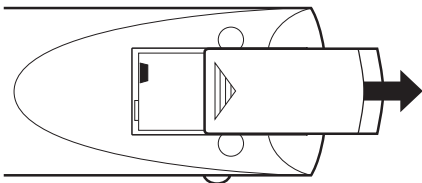

2. Install two “AA” size batteries. Match the + and – symbols on the batteries to the symbols on the battery compartment.

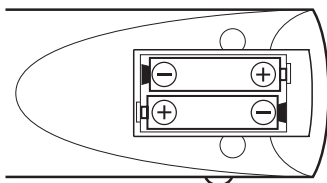

3. Slide the battery cover back onto the remote control until the lock snaps.

Using the remote control with a VCR or cable TV converter

To control a VCR:

Set the TV/CABLE/VCR switch to the VCR position. The shaded buttons in the illustration at right will then control the VCR. The unshaded buttons will operate the TV as usual.

To control a cable TV converter:

Set the TV/CABLE/VCR switch to the CABLE position. The shaded buttons in the top portion of the illustration at right will then control the cable TV converter.

Note:

The remote control provided with your TV may or may not operate certain features on your VCR, cable TV converter, or other electronic equipment. Refer to the owner's manuals provided with your other equipment to see which features are available. In addition, the other remote controls may have buttons not available on your TV's remote control. If you would like to use those features or buttons, you may need to use the original remote controls provided with your other equipment.

Caution:

- Dispose of batteries in a designated disposal area. Do not throw batteries into a fire.
- Do not mix battery types or combine used batteries with new ones.
- Remove dead batteries immediately to prevent battery acid from leaking into the battery compartment.
- If you do not intend to use the remote control for a long time, remove the batteries.

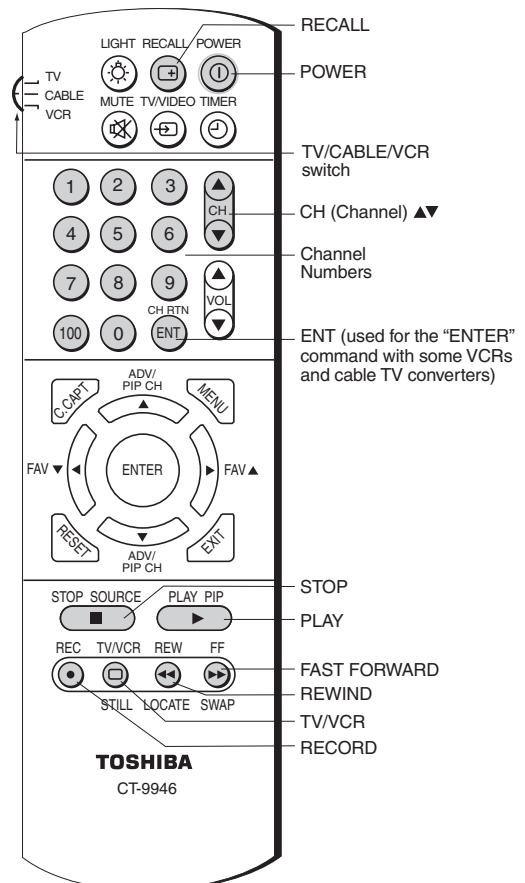

Programming the remote control for use with a non-Toshiba VCR or cable TV converter

The remote control provided with your Toshiba TV is preprogrammed to operate Toshiba VCRs and cable TV converters.

To operate a non-Toshiba VCR or converter using the remote control provided with your TV:

1. Refer to the VCR and cable TV converter code tables (below and on the next page) to find the corresponding code for your VCR or converter brand.
If more than one code is listed, try each one separately until you find the one that works.
2. If you are programming the remote control to operate your:
 - **VCR:** Set the TV/CABLE/VCR switch on the remote control to "VCR."
 - **Cable TV converter:** Set the TV/CABLE/VCR switch on the remote control to "CABLE."
3. While holding down **RECALL**, press the **CHANNEL NUMBERS** to enter the three-digit code for your VCR or cable TV converter brand.
4. Point the remote control at the VCR or converter, and press **POWER** to test the code.
 - If the VCR or converter responds, you entered the correct code.
 - If the VCR or converter does not respond, repeat steps 1–4 using another code.
5. Set the TV/CABLE/VCR switch to "TV" to control the TV.

For future reference, write down the codes you used:

VCR code: _____

Cable TV converter code: _____

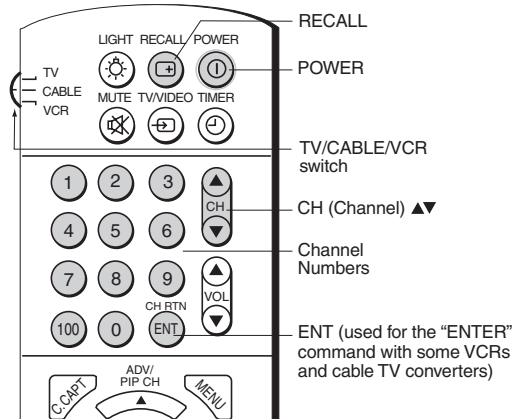

Note:

- Every time you replace the batteries, you must reprogram the remote control.
- Some newer VCRs are capable of working on either of two remote codes. These VCRs have a switch labeled "VCR1/VCR2." If your VCR has this kind of switch and does not respond to any of the codes for your VCR brand, set the switch to the other position (VCR1 or VCR2) and reprogram the remote control.

VCR code table

Brand	Code	Brand	Code	Brand	Code
Adventura	019	CCE	091, 297	Fisher	066, 073, 085, 123
Aiko	297	Citizen	056, 297	Fuji	052, 054
Aiwa	019	Colt	091	Funai	019, 344
Akai	060, 068, 080, 125, 261	Craig	056, 066, 091, 259	Garrard	019, 344
American High	054	Curtis Mathes	054, 060, 079	GE	054, 079, 084, 221
Asha	259	Cybernex	259	Go Video	251, 298
Audiovox	056	Daewoo	039, 064, 297	Goldstar	037, 056, 057
Beaumark	259	Daytron	039	Gradiente	019
Bell & Howell	123	Dynatech	019	Harley Davidson	019
Brandt	206	Electrohome	056	Harman/Kardon	057, 094
Broksonic	140, 203, 230, 314, 380	Electrohome	056	Harwood	087, 091
Calix	056	Emerex	051	Headquarter	065
Canon	054	Emerson	019, 021, 056, 062, 080, 087, 140, 203, 227, 228, 230, 231, 297, 313, 314, 380, 498	HI-Q	066
Capehart	039			Hitachi	060, 061, 084, 124, 185, 254
Carver	100			Jensen	060
				JVC	027, 060, 086
				Kenwood	057, 060, 086

VCR code table (cont.)

Brand	Code	Brand	Code	Brand	Code	
KLH	091	Sanky	058, 067	Garrard	172	
Kodak	054, 056	Sansui	060, 086	CG Electronics	075	
Lloyd	019, 227	Sanyo	065, 066, 123, 259	Gemini	034, 089	
Logik	091	Scott	062, 064, 140, 203, 229, 230, 231	General Instrument	030, 295	
LXI	056	Sears	054, 056, 061, 065, 066, 073, 085, 123, 124	Gold Star	059, 163	
Magnavox	054, 058, 100, 129, 168	Sharp	067, 081	Hamlin	028, 039, 053, 278, 292	
Magnin	259	Shintom	091	Hitachi	030	
Marantz	054, 100	Shogun	259	Hytex	026	
Marta	056	Singer	091	Jasco	172	
Matsushita	054	Sony	051, 052, 053, 054	Jerrold	022, 030, 031, 033, 034, 066, 295	
MEI	054	STS	061	Macom	052	
Memorex	019, 054, 056, 058, 065, 066, 067, 123, 259	Sylvania	019, 054, 062, 100, 129	Magnavox	046	
MGA	062, 080	Symphonic	019, 344	Memorex	019	
MGN Technology	259	Tatung	060	Movietime	175	
Minolta	061, 124	Teac	019, 060	NSC	089, 175	
Mitsubishi	062, 080, 086, 094, 192, 233, 261	Technics	054, 181	Oak	026, 038, 267	
Motorola	054, 067	Teknika	019, 054, 056, 071	Panasonic	019, 040, 126	
MTC	019, 259	Telefunken	206	Paragon	019	
Multitech	019, 091	TMK	227, 259	Philips	044, 046, 047, 048, 049, 050, 172	
NAD	077	Toshiba	062, 064, 085, 229, 231, 385	Pioneer	042, 163, 552	
NEC	057, 059, 060, 069, 086	Totevision	056, 259	Popular Mechanics	419	
Nikko	056	Unitech	259	Pulsar	019	
Noblex	259	Vector	064	RCA	040	
Olympus	054	Vector Research	057, 059	Regal	039, 278, 292	
Optimus	056, 067, 077, 123	Video Concepts	059, 064, 080	Recoton	419	
Optonica	081	Videosonic	259	Regency	021	
Orion	498	Wards	019, 054, 061, 066, 067, 081, 091, 168, 231, 259	Rembrandt	030, 089	
Panasonic	054, 096, 181, 244, 473	XR-1000	019, 054, 091	Runco	019	
Penney	054, 056, 057, 059, 061, 073, 259	Yamaha	057	Samsung	059, 163	
Pentax	061, 084, 124	Zenith	052, 053, 058	Scientific Atlanta	025, 027, 036, 296	
Philco	054	Cable TV converter code table			Signal	034, 059
Philips	054, 081, 100, 129	Brand	Code	Signature	030	
Pilot	056	ABC	020, 022, 027, 030, 032, 033, 036, 066	SL Marx	059	
Pioneer	077, 086	Antronix	041	Sprucer	040	
Portland	039	Archer	041, 058, 172	Standard	174	
Protec	091	Belcor	075	Components	174	
Pulsar	058	Cable Star	075	Starcom	022, 034, 066	
Quarter	065	Cabletenna	041	Stargate	034, 059	
Quartz	065	Cableview	041	Starquest	034	
Quasar	054, 096	Century	172	Sylvania	020	
Radio Shack	019, 056, 344	Citizen	172	Televue	059	
Radix	056	Colour Voice	044, 050	Texscan	020	
Randex	056	Comtronics	059, 079	Tocom	031, 032, 078	
RCA	061, 079, 084, 096, 124, 125, 168, 221	Contec	038	Toshiba	019	
Realistic	019, 054, 056, 065, 066, 067, 081, 085, 123, 259	Dae Ryung	027	Tusa	034	
Ricoh	053	Eastern	021	Unika	041, 172	
Runco	058	Focus	419	United Artists	026	
Samsung	064, 259			United Cable	022	
				Universal	041, 058, 075, 096, 172, 210	
				Viewstar	046, 079, 230	
				Zenith	019	
				Zentek	419	

Learning about the remote control

LIGHT illuminates the keys

RECALL displays on-screen information (pages 21, 22)

TV/CABLE/VCR switch switches among TV, Cable, and VCR inputs (page 12)

POWER turns the TV on and off

MUTE turns off the sound (page 33)

TIMER sets the TV to turn off at a specific time (page 31)

TV/VIDEO selects the signal input source (page 17)

Channel ▲▼ cycles through programmed channels (page 17)

Channel Numbers (0–9, 100) directly tune channels (page 18)

VOL ▲▼ adjusts the volume level

CH RTN (Channel Return) returns to the last viewed channel (page 19)

C.CAPT opens the Closed Caption menu (page 32)

MENU accesses on-screen menus (page 16)

▲▼ ◀▶ (Up/Down/Left/Right Arrows) select or adjust menu items when a menu is on-screen (page 17)

FAV ▼▲ (Left/Right Arrows) select channels you programmed as favorite channels (page 19)

EXIT sets menu information and closes menus (page 23)

PIP Buttons access PIP functions when the TV/Cable/VCR switch is set to TV (pages 28, 29)

PIP turns the PIP and Multi-Window feature on and off (one press for 1/9-size PIP window; two presses for 1/16-size PIP window; three presses for the Multi-Window feature)

SOURCE selects the PIP signal input source

PIP CH ▲▼ (Up/Down Arrows) select PIP channels (when PIP is on-screen)

STILL freezes the PIP display

LOCATE changes the location of the PIP window

SWAP switches the main and PIP pictures

Note: When the **TV/Cable/VCR switch** is set to "VCR," the PIP buttons function instead as VCR buttons (STOP, PLAY, REC, TV/VCR, REW, FF; see page 12).

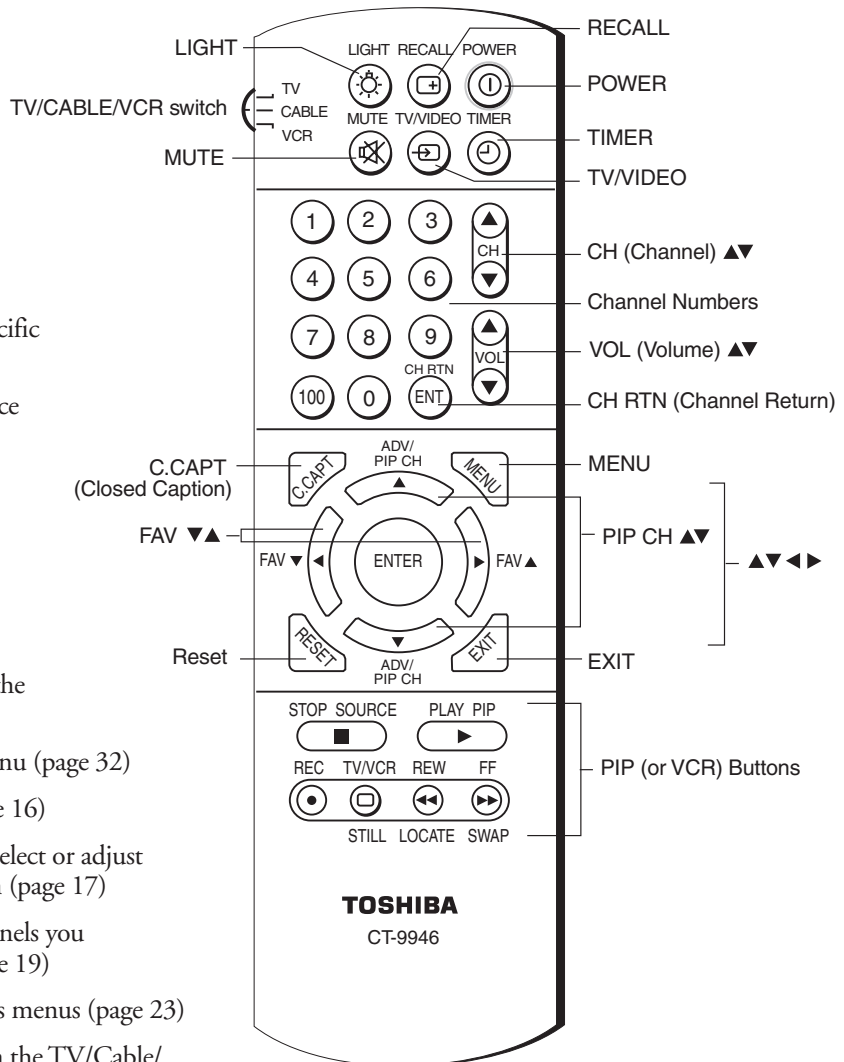

Setting up your TV

After installing the batteries and programming the remote control, you will need to set some preferences on your TV using the menu system. You can access the menus using the buttons on your TV or remote control.

- When you make a menu selection, your changes occur immediately. You do not have to press **MENU** or **EXIT** to save your changes.
Note: The TV front panel does not have an **EXIT** button.
- When you are finished programming the menus, you can press **EXIT** to clear the on-screen display, or wait 15 seconds and the on-screen display will disappear automatically. Your changes are automatically saved either way.

TV Front Panel

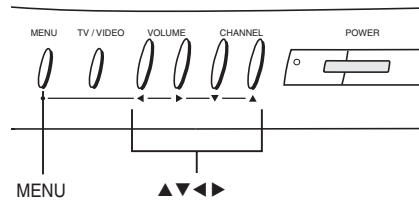

Changing the on-screen display language

You can choose from three different languages (English, French, or Spanish) for the on-screen display of menus and messages.

To select an on-screen display language:

1. Press **MENU**.
2. Press ◀ or ▶ until the SET UP menu appears.
3. Press ▲ or ▼ to highlight LANGUAGE.
4. Press ◀ or ▶ to highlight your desired language.

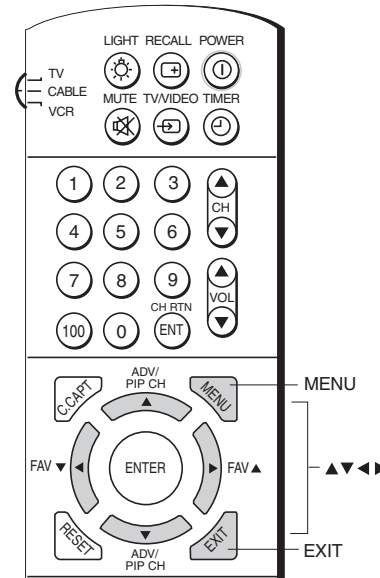
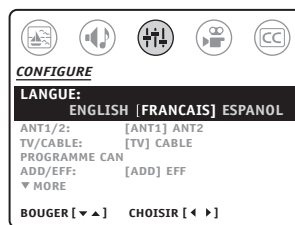
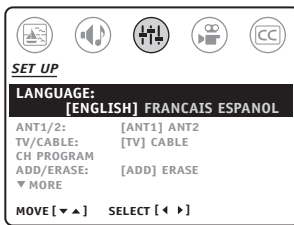

Selecting the antenna input

You can connect to one of two different antenna input sources (ANT 1 or ANT 2).

To select the antenna input:

1. Press **MENU**.
2. Press ◀ or ▶ to highlight the SET UP menu.
3. Press ▲ or ▼ to highlight ANT 1/2.
4. Press ◀ or ▶ to highlight either ANT 1 or ANT 2, depending on the antenna terminal you wish to use.

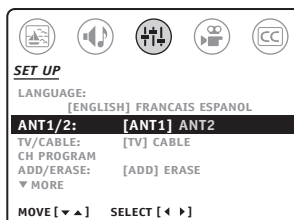

Selecting the signal source

Use the **TV/VIDEO** button on the remote control or TV to monitor or change the signal source connected to your TV.

To monitor the signal source:

Press **TV/VIDEO** once. The current signal source displays in green.

To change the signal source:

Repeatedly press **TV/VIDEO** to select either VIDEO 1, VIDEO 2, VIDEO 3, ColorStream, ANT 1, or ANT 2. The selected signal source displays in green.

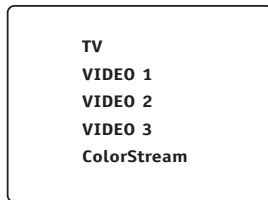

Pressing TV/VIDEO on the remote control

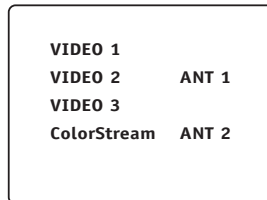

Pressing TV/VIDEO on the TV

Programming channels into the TV's memory

When you press **CHANNEL ▲▼** on the TV or remote control, the TV stops only on the channels stored in the TV's memory.

Note: To tune the TV to a channel not programmed into the memory, use the **CHANNEL NUMBERS** on the remote control.

Follow the steps below and on the next page to program channels into the TV's memory.

Programming channels automatically

Your TV can automatically detect all active channels in your area and store them in the TV's memory. After the channels are stored automatically, you can manually add or erase individual channels (see page 18). If you use both ANT-1 and ANT-2 terminals, you will need to program channels for each signal source.

To program channels automatically:

1. Press **MENU**.
2. Press **◀** or **▶** to highlight the SET UP menu.
3. Press **▲** or **▼** to highlight TV/CABLE.
4. Press **◀** or **▶** to highlight TV (if you use an antenna) or CABLE (if you use cable).
5. Press **▼** to highlight CH PROGRAM.

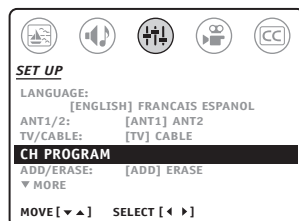
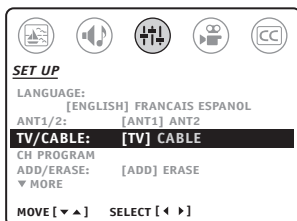

6. Press **◀** or **▶** to start automatic channel programming ("CH PROGRAM" displays on-screen). The TV automatically cycles through every TV or cable channel (depending on which you selected), and stores all active channels in the TV's memory.
7. When automatic channel programming is complete, the message "CH Programming Completed" appears.
8. Press **CHANNEL ▲▼** to view the programmed channels.

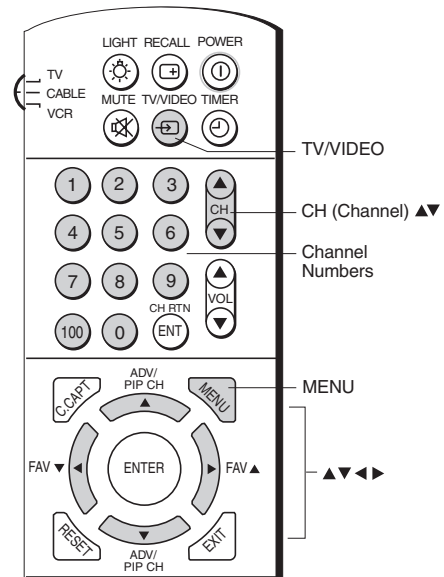
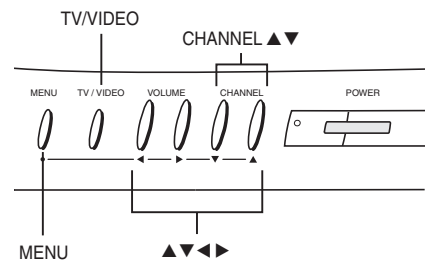

Adding and erasing channels manually

After you have automatically programmed the channels into the TV's memory, you can manually add and erase individual channels.

To add a channel to or erase a channel from the TV's memory:

1. Tune the TV to the channel you want to add or erase. If you are adding a channel, you will need to use the **CHANNEL NUMBERS** to select the channel.
2. Press **MENU**.
3. Press ◀ or ▶ to highlight the SET UP menu.
4. Press ▲ or ▼ to highlight ADD/ERASE.

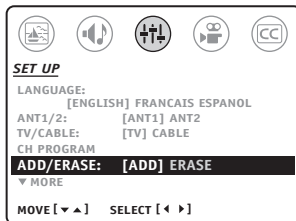

5. Press ◀ or ▶ to highlight ADD or ERASE, whichever function you want to perform.
6. Press **MENU**.
7. Repeat steps 1–6 for other channels you want to add or erase, or press **EXIT** to return to normal TV viewing.

Changing channels

To change to the next programmed channel:

Press **CHANNEL ▲▼**.

To change to a specific channel (programmed or unprogrammed):

Press the **CHANNEL NUMBERS** (0–9 and 100).

Note: For channels 100 and higher, press the 100 button, and then the next two channel numbers (for example, to select channel 100, press 100, 0, 0; to select channel 125, press 100, 2, 5).

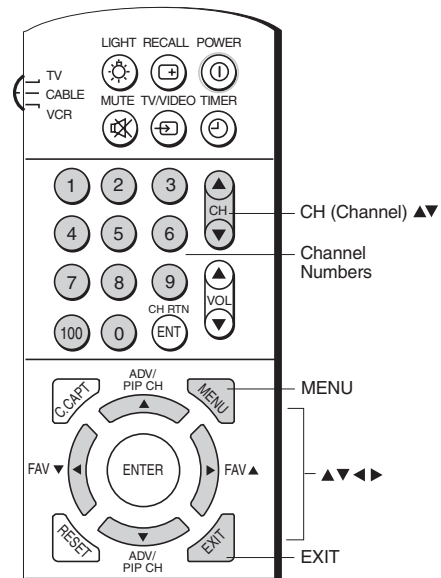
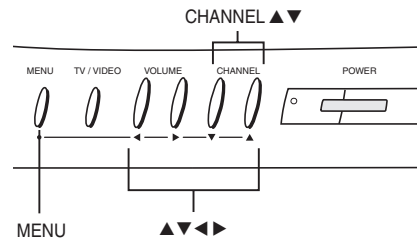

Using the TV's features

Adjusting the channel settings

Switching between two channels

You can switch between two channels without entering an actual channel number each time.

To switch between two channels:

1. Select the first channel you want to view.
2. Select a second channel using the **CHANNEL NUMBERS** (0–9 and 100).
3. Press **CH RTN** (channel return). The previous channel will display.

Every time you press **CH RTN**, the TV will switch back and forth between the last two channels you tuned the TV to.

Programming your favorite channels

The Favorite Channel feature allows you to use the **FAV** buttons on the remote control to cycle through your favorite channels, skipping over channels you do not normally watch. You can program a maximum of 12 favorite channels.

Note: You can still use **CHANNEL** to cycle through all the channels you previously programmed into the TV's memory (see "Adding channels to the TV's memory" on page 17).

To program your favorite channels:

1. Tune the TV to a channel you want to program as a favorite channel.
2. Press **MENU**.
3. Press **◀** or **▶** to highlight the SET UP menu.
4. Press **▲** or **▼** to highlight FAVORITE CH.

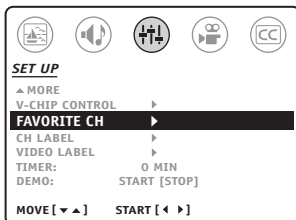

5. Press **◀** or **▶** to display the FAVORITE CH menu. SET/CLEAR will be highlighted.
6. Press **◀** or **▶** to highlight SET.
7. Press **▼** to add the current channel to the list.
8. Press **MENU**.

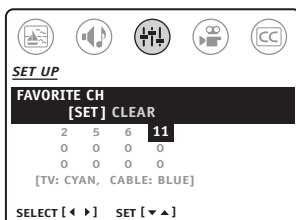

9. Repeat steps 1–8 for up to 12 channels, or press **EXIT** to close the menu.

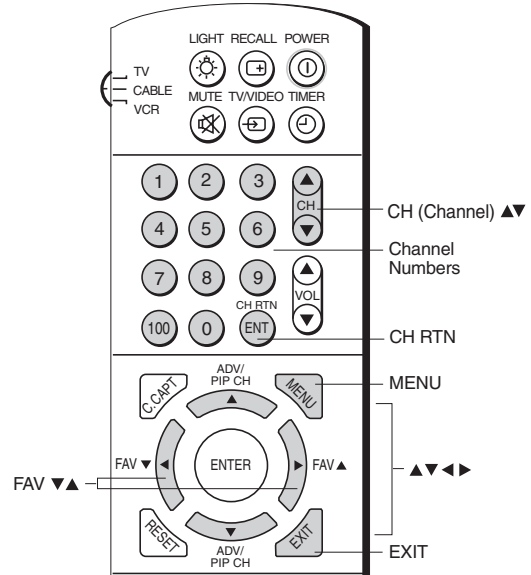

To select your favorite channels:

Press **FAV** \blacktriangledown \blacktriangle on the remote control to cycle through the favorite channels you programmed.

Note: The **FAV** \blacktriangledown \blacktriangle buttons will not work unless you program at least one favorite channel.

To clear a favorite channel:

1. Tune the TV to the channel you want to clear from your favorite channel list.
2. Press **MENU**.
3. Press \blacktriangleleft or \blacktriangleright to highlight the SET UP menu.
4. Press \blacktriangle or \blacktriangledown to highlight FAVORITE CH.
5. Press \blacktriangleleft or \blacktriangleright to display the FAVORITE CH menu. SET/CLEAR will be highlighted.
6. Press \blacktriangleleft or \blacktriangleright to highlight CLEAR.

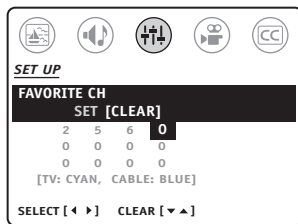

7. Press \blacktriangledown to clear the current channel number from the list.
8. Press **MENU**.
9. Repeat steps 1–8 for other channels you want to clear from your favorite channel list, or press **EXIT** to close the menu.

Using the V-Chip Control (blocking) feature

You can use the V-Chip Control feature to block certain programs or channels, to prevent others from viewing them.

Selecting a PIN code

Before you can block programs or channels, you must select a personal identification number (PIN) code. Your PIN code allows you to access the V-Chip Control menu, and prevents others from changing the rating and blocking limits you set.

To select your PIN code and access the V-Chip Control menu:

1. Press **MENU**.
2. Press \blacktriangleleft or \blacktriangleright to highlight the SET UP menu.
3. Press \blacktriangle or \blacktriangledown to highlight V-CHIP CONTROL.
4. Press \blacktriangleleft or \blacktriangleright to display the “Enter PIN Code” screen.

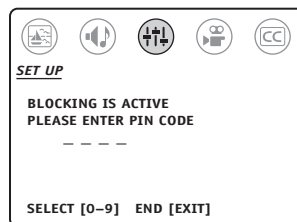
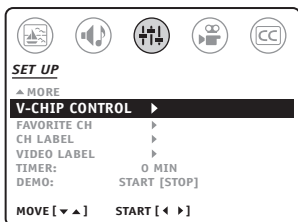

Note:

The **FAV** \blacktriangledown \blacktriangle buttons function as menu \blacktriangleleft \blacktriangleright buttons when a menu is on-screen.

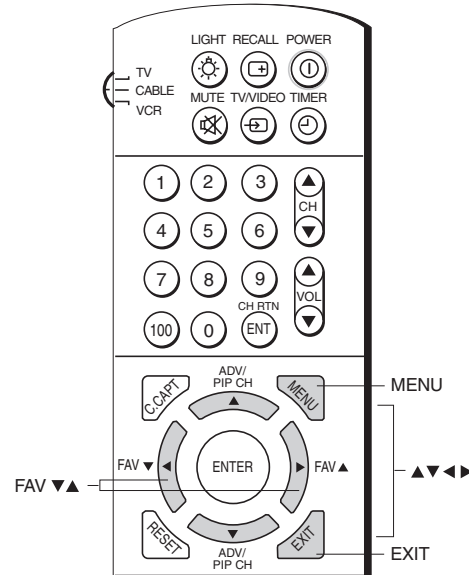

- Use the **CHANNEL NUMBERS** (0–9) to enter your four-digit PIN code. After the code is entered, the V-Chip Control menu appears.

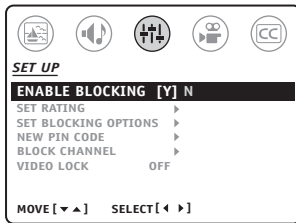

V-Chip Control (Blocking) Menu

- Press **▲** or **▼** to highlight **ENABLE BLOCKING**.
- Press **◀** or **▶** to highlight “Y,” which enables all blocking by activating the V-Chip. See “Blocking programs by ratings” on page 22, “Blocking unrated movies or programs” on page 23, and “Blocking channels” on page 24.
(**Note:** Highlight “N” to deactivate the V-Chip Control feature and disable blocking.)

Changing your PIN code

- Press **MENU**.
- Press **◀** or **▶** to highlight the **SET UP** menu.
- Press **▲** or **▼** to highlight **V-CHIP CONTROL**.
- Press **◀** or **▶** to display the Enter PIN Code screen.
- Use the Channel Number buttons (0–9) to enter your existing PIN code. After the code is entered, the V-Chip Control menu appears.
- Press **▲** or **▼** to highlight **NEW PIN CODE**.
- Press **◀** or **▶** to display the New PIN Code screen.

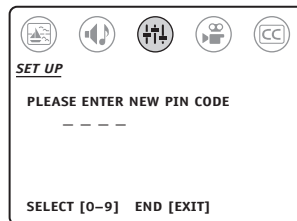
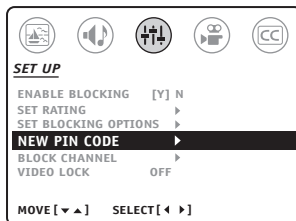

- Use the **CHANNEL NUMBERS** (0–9) to enter a new PIN code. After the new code is entered, the V-Chip Control menu appears.
- Press **EXIT** to return to normal TV viewing.

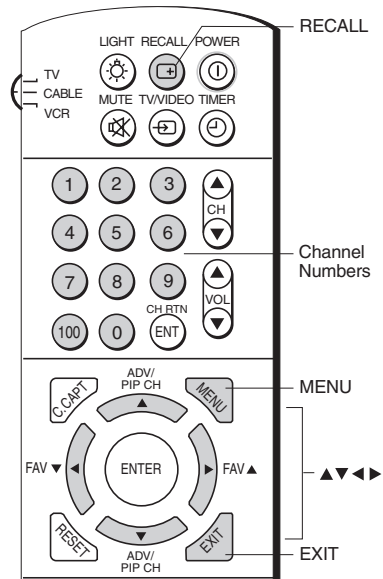

Note:

If you forget your PIN code:

- Follow steps 1–4 under “Changing your PIN code” at left.
- Then press **RECALL** four times within five seconds.

This allows you to proceed to the V-Chip Control menu and reset your PIN code.

Blocking programs by ratings

The Motion Picture Association of America (MPAA) uses a rating system to qualify motion picture content. Television broadcasters employ a similar rating system to qualify the content of television programs. The MPAA, Youth TV, and TV ratings work with the V-Chip feature to allow you to block access to programs that exceed the rating limits you set.

Note:

Press **RECALL** to see the rating of the program you are viewing. Not all programs are rated, however. To block programs or movies that are not rated, see "Blocking unrated movies and programs" on page 23.

Ratings definitions

MPAA Ratings		TV Ratings	
X	For adults only.	MA	Mature audience only. This program is specifically designed to be viewed by adults and therefore may be unsuitable for children under 17.
NC17	Not intended for anyone 17 or under.	Dialog	Intensely suggestive dialog
R	Restricted. Under 17 requires an accompanying parent or adult guardian.	Language	Crude or indecent language
PG13	Parents strongly cautioned. Some material may not be appropriate for children under 13.	Sex	Explicit sexual activity
PG	Parental guidance suggested. Some material may not be appropriate for children.	Violence	Graphic violence
G	General audience. Appropriate for all ages.	14	Parents strongly cautioned. This program contains some material that many parents would find unsuitable for children under 14 years of age.
Youth TV Ratings		Dialog	Frequent suggestive dialog
Y7 Y7FV	Directed to older children. Programs rated Y7 are designed for children 7 and above. Programs rated Y7FV contain fantasy violence that may be more intense or combative than Y7-rated programs.	Language	Frequent coarse language
Y	For all children. Programs rated Y are designed to be appropriate for all children.	Sex	Intense sexual situations
		Violence	Intense violence
		PG	Parental guidance suggested. This program contains material that parents may find unsuitable for younger children.
		Dialog	Some suggestive dialog
		Language	Occasional coarse language
		Sex	Some sexual situations
		Violence	Moderate violence
		G	General audience. Most parents would find this program suitable for all ages.
		No DLSV	Programs without any Dialog, Language, Sex, or Violence ratings.

To block programs by rating:

1. Press **MENU**.
2. Press ◀ or ▶ to highlight the SET UP menu.
3. Press ▲ or ▼ to highlight V-CHIP CONTROL.
4. Press ◀ or ▶ to display the "Enter PIN Code" screen.
5. Use the **CHANNEL NUMBERS** (0–9) to enter your four-digit PIN code. After the code is entered, the V-Chip Control menu appears.
6. Press ▲ or ▼ to highlight ENABLE BLOCKING.
7. Press ◀ or ▶ to highlight "Y," which enables all blocking by activating the V-Chip. (**Note:** Highlight "N" to deactivate the V-Chip Control feature and disable blocking.)

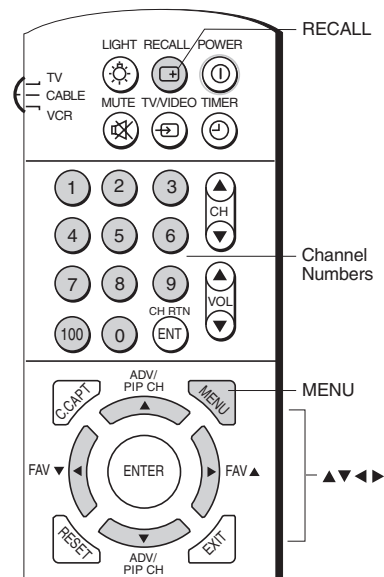
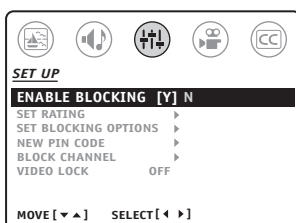

8. Press ▲ or ▼ to highlight SET RATING.
9. Press ◀ or ▶ to display the Set Rating menu.
10. Press ▲ or ▼ to highlight MPAA Rating, Youth TV Rating, or TV Rating.
11. Press ▶ to select (or ◀ to deselect) the ratings to be blocked. Blocked ratings will be marked with “X”; unblocked ratings will be marked with “✓.” All ratings higher than the ones that are selected (“X”) are blocked as well. For example, if you block the MPAA rating R, programs with the higher ratings NC17 and X will also be blocked.

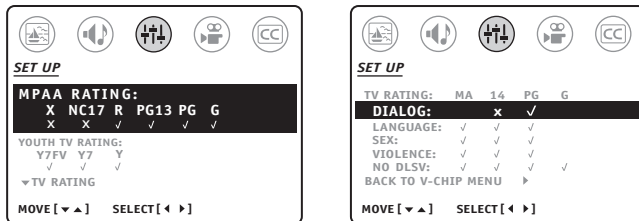

12. When you finish selecting the program ratings to be blocked:
 - To return to the V-Chip menu, press ▲ or ▼ to highlight **BACK TO V-CHIP MENU**, and then press ◀ or ▶.
 - To return to normal TV viewing, press **EXIT**.

Unblocking programs temporarily

When you try to view a program with a ratings block, a message appears stating that the program has been blocked because the program's rating exceeds the set limits. To temporarily override the block and view the program, press **MUTE** and enter your PIN code. To reset your original ratings blocks, turn the TV off and then on again.

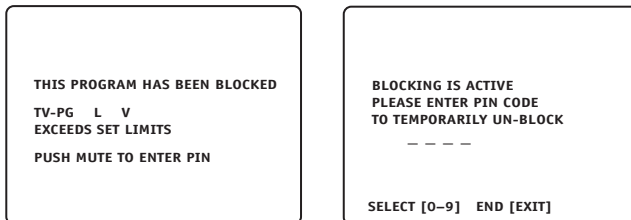

Blocking unrated movies and programs

Some movies and programs are not rated. You can use the V-Chip Control feature to block unrated movies and programs.

To block unrated movies and programs:

1. Press **MENU**.
2. Press ◀ or ▶ to highlight the SET UP menu.
3. Press ▲ or ▼ to highlight V-CHIP CONTROL.
4. Press ◀ or ▶ to display the Enter PIN Code screen.
5. Use the **CHANNEL NUMBERS** (0–9) to enter your four-digit PIN code. After entering the code, the V-Chip Control menu appears.
6. Press ▲ or ▼ to highlight **ENABLE BLOCKING**.

(Continued on next page)

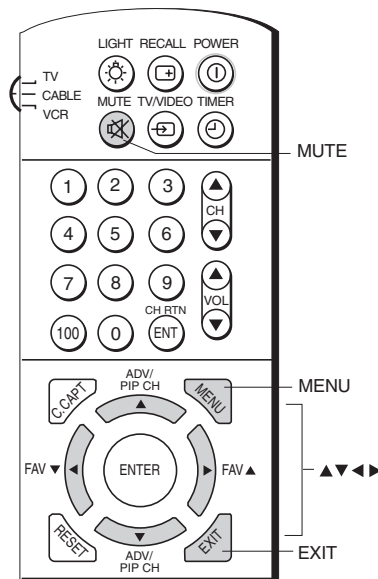

- Press ◀ or ▶ to highlight “Y,” which enables all blocking by activating the V-Chip. (**Note:** Highlight “N” to deactivate the V-Chip feature and disable blocking.)
- Press ▲ or ▼ to highlight SET BLOCKING OPTIONS.
- Press ◀ or ▶ to display the unrated movie/program blocking menu.
- Press ▲ or ▼ to highlight BLOCK TV NONE RATING.
- Press ◀ or ▶ to highlight “Y” to block movies/programs rated “TV None.” (**Note:** Highlight “N” to unblock unrated programs.)
- Press **EXIT** to return to normal TV viewing.

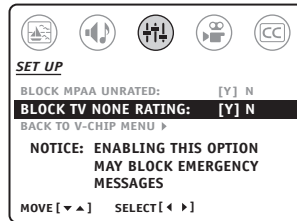
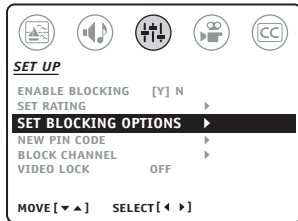

Caution:

Blocking unrated television programs (those rated “TV NONE”) may block emergency messages.

Blocking channels

You can block a maximum of four TV channels and four cable channels. Blocked channels cannot be viewed, regardless of their ratings. If you try to tune the TV to a blocked channel, the nearest unblocked channel will display.

To block a channel:

- Tune the TV to the channel you want to block.
- Press **MENU**.
- Press ◀ or ▶ to highlight the SET UP menu.
- Press ▲ or ▼ to highlight V-CHIP CONTROL.
- Press ◀ or ▶ to display the Enter PIN Code screen.
- Use the **CHANNEL NUMBERS** (0–9) to enter your four-digit PIN code. After entering the code, the V-Chip Control menu appears.
- Press ▲ or ▼ to highlight ENABLE BLOCKING.
- Press ◀ or ▶ to highlight “Y,” which enables all blocking by activating the V-Chip Control feature. (**Note:** Highlight “N” to deactivate the V-Chip feature and disable blocking.)
- Press ▲ or ▼ to highlight BLOCK CHANNEL.
- Press ◀ or ▶ to display the BLOCK CHANNEL menu. SET/CLEAR will be highlighted.
- Press ◀ or ▶ to highlight SET.
- Press ▼ to add the current channel to the list.

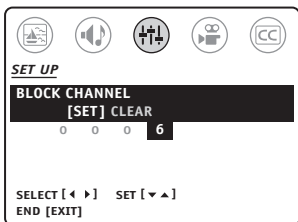

- Press **MENU**.
- Press **EXIT**.
- Repeat steps 1–14 to block additional channels.

Note:

After programming CHANNEL BLOCK, tune the TV to a channel that is not blocked before turning the TV off.

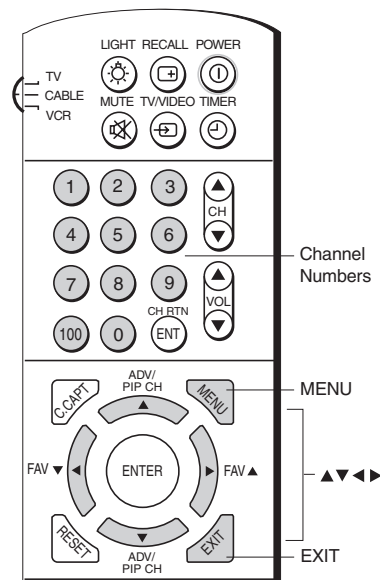

Using the TV's Features

To unblock all blocked channels:

Note: This will unblock every channel you have blocked. You cannot unblock individual channels.

1. Press **MENU**.
2. Press ◀ or ▶ to highlight the SET UP menu.
3. Press ▲ or ▼ to highlight V-CHIP CONTROL.
4. Press ◀ or ▶ to display the Enter PIN Code screen.
5. Use the **CHANNEL NUMBERS** (0–9) to enter your four-digit PIN code. After entering the code, the V-Chip Control menu appears.
6. Press ▲ or ▼ to highlight BLOCK CHANNEL.
7. Press ◀ or ▶ to display the BLOCK CHANNEL menu. SET/CLEAR will be highlighted.
8. Press ◀ or ▶ to highlight CLEAR.
9. Press ▼ to clear all blocked channels from the list.
10. Press **MENU**.
11. Press **EXIT** to return to normal TV viewing.

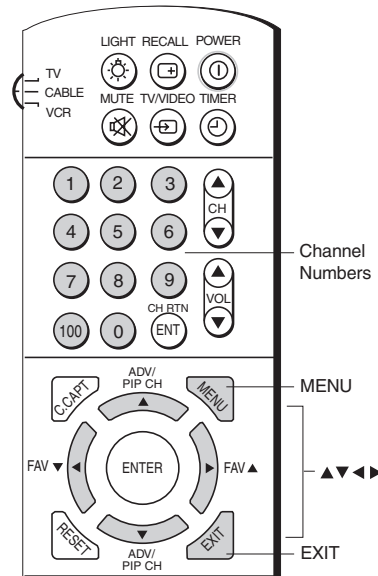

Locking video inputs

You can use the Video Lock feature to block the input sources (Video 1, Video 2, Video 3, and ColorStream) and channels 3 and 4.

Note: The Video Lock feature is independent of the Enable Blocking option of V-Chip control (page 21).

The Video Lock options are:

- Video: Blocks Video 1, Video 2, Video 3, and ColorStream.
- Video+: Blocks Video 1, Video 2, Video 3, ColorStream, and channels 3 and 4.
- Off: Disables the Video Lock feature.

To set up video lock:

1. Press **MENU**.
2. Press ◀ or ▶ to highlight the SET UP menu.
3. Press ▲ or ▼ to highlight V-CHIP CONTROL.
4. Press ◀ or ▶ to display the Enter PIN Code screen.
5. Use the **CHANNEL NUMBERS** (0–9) to enter your four-digit PIN code. After entering the code, the V-Chip Control menu appears.
6. Press ▲ or ▼ to highlight VIDEO LOCK.
7. Press ◀ or ▶ to select the desired level of video locking (Video, Video+, or Off).

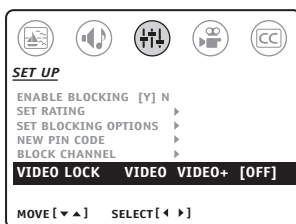

8. Press **EXIT** to return to normal TV viewing.

Note:

In normal TV viewing, if you cannot access the input sources (Video 1, Video 2, Video 3, and ColorStream) or channels 3 and 4, check the Video Lock setting and highlight OFF if necessary.

Channel labels

You can assign labels to a maximum of 32 channels. Each channel label can have a maximum of four characters.

For example, if channel 8 is your public television station, you could create the label "PBS" for that channel. The label "PBS" would then appear on-screen when you tune the TV to channel 8.

Channel labels appear on-screen above the channel number every time you turn the TV on, change the channel, or press **RECALL**.

To create a channel label:

1. Tune the TV to the channel you want to label.
2. Press **MENU**.
3. Press ◀ or ▶ to highlight the SET UP menu.
4. Press ▲ or ▼ to highlight CH LABEL.

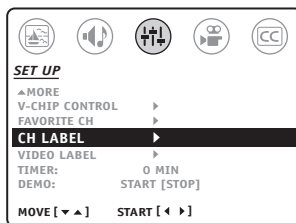

5. Press ◀ or ▶ to display the CH LABEL menu. SET/CLEAR will be highlighted.
6. Press ◀ or ▶ to highlight SET.
7. Press ▼ to highlight LABEL.

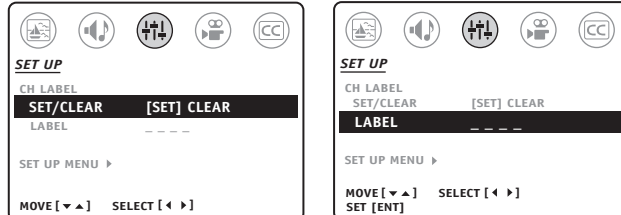

8. Press ◀ or ▶ repeatedly to scan through the list of available characters until the desired character appears in the first space.
9. Press **MENU**.
10. Repeat steps 8 and 9 to enter the rest of the characters.

Note: For a blank space in the label name, you must choose a blank space from the list of characters; otherwise, a dash will appear in the space.
11. Repeat steps 1–10 for up to 32 channels.
12. Press **EXIT** to return to normal TV viewing.

To erase a channel label:

1. Select the channel whose label you want to erase.
2. Press **MENU**.
3. Press ◀ or ▶ to highlight the SET UP menu.
4. Press ▲ or ▼ to highlight CH LABEL.
5. Press ◀ or ▶ to display the CH LABEL menu. SET/CLEAR will be highlighted.
6. Press ◀ or ▶ to highlight CLEAR.
7. Press **MENU**.
8. Repeat steps 1–7 to erase other channel labels, or press **EXIT** to return to normal TV viewing.

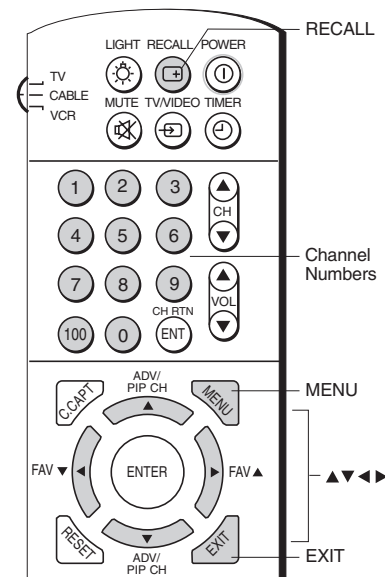

Video labels

The Video Label feature allows you to label each input source for your TV, from the following preset list of labels:

- : Uses the default label name
- VCR: Video cassette recorder
- DVD: Digital video disc or digital versatile disc
- DTV: Digital TV set-top box
- SAT: Satellite box
- CBL: Cable box

To set up video labels:

1. Press **MENU**.
2. Press ◀ or ▶ to highlight the SET UP menu.
3. Press ▲ or ▼ to highlight VIDEO LABEL.
4. Press ◀ or ▶ to display the Video Label screen.
5. Press ▲ or ▼ to highlight the input source to be labeled (VIDEO 1, VIDEO 2, VIDEO 3, or ColorStream).
6. Press ◀ or ▶ to select the desired label for that input source.

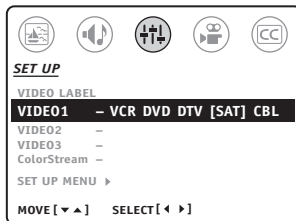

7. Repeat steps 1–6 to label the other input sources.
8. When you finish setting up video labels:
 - To return to the previous menu, press ▲ or ▼ to highlight SET UP MENU, and then press ◀ or ▶.
 - To return to normal TV viewing, press **EXIT**.

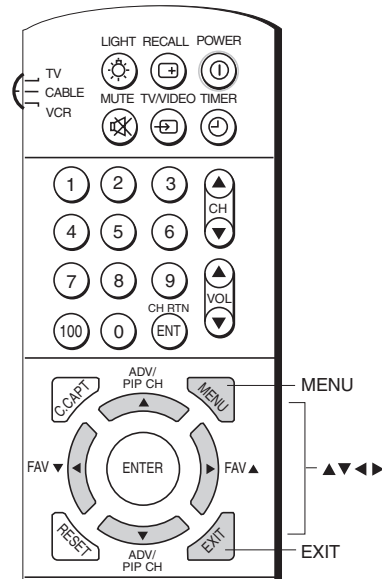

Watching picture-in-picture (PIP)

The picture-in-picture (PIP) feature allows you to watch two pictures at the same time. The small PIP window can display a signal from a TV broadcast or an external source, such as a VCR.

To display a TV broadcast in the PIP window:

1. Tune the TV to the program you want to watch in the main window.
2. Press **PIP** to display a small picture (one press displays a PIP window 1/9 the size of the screen; two presses display a 1/16-size window).

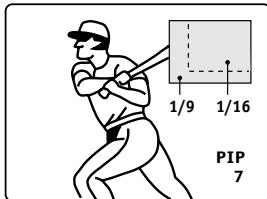

3. Press **PIP CH ▲▼** to change the PIP channel. Press **Channel ▲▼** to change the main channel.

To display an external source in the PIP window:

1. Connect the external equipment to the ANT-1 connection on the TV.

Note: An ANT-2 source will not display as a PIP. For connection information, see "Connecting your TV" on page 7.
2. Turn on the TV and select the program/source you want to watch in the main window.
3. Press **PIP** (one press to display a PIP window 1/9 the size of the screen; two presses to display a 1/16-size window).
4. Press **SOURCE** to select the PIP input source (TV, VIDEO 1, VIDEO 2, or VIDEO 3). The current source will display on-screen in green.

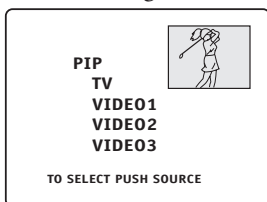

To turn PIP off:

Press **PIP** two or three times, depending on the PIP window size you selected.

Switching the main and small pictures

With the TV in PIP mode, repeatedly press **SWAP** to switch the main and small pictures back and forth.

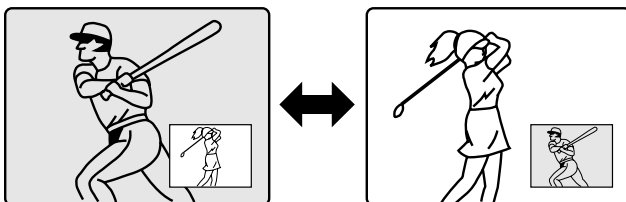

Note:

The PIP window will not open when a ColorStream (component video) source is being viewed.

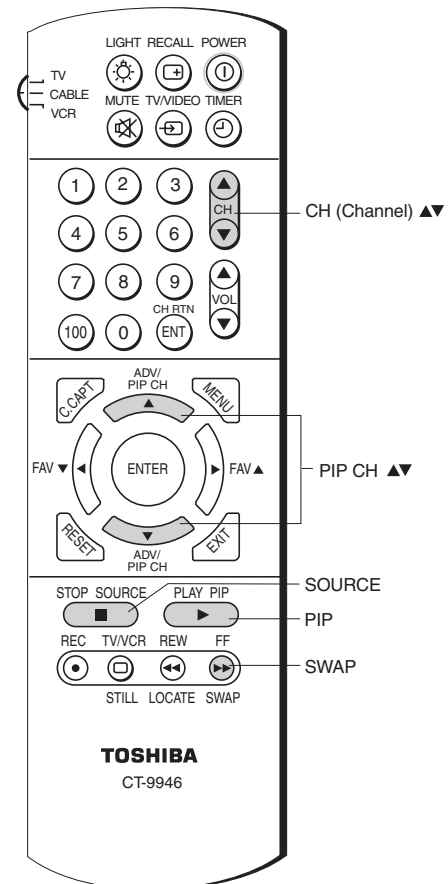

Changing the location of the PIP window

With the TV in PIP mode, press **LOCATE** to change the location of the PIP window on-screen. Every time you press **LOCATE**, the PIP window changes position counter-clockwise.

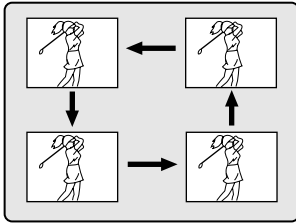

Freezing the PIP display

With the TV in PIP mode, press **STILL** to freeze the PIP display. The PIP picture becomes still, and is outlined in red on-screen. Press **STILL** again to restore the moving picture (outlined in green).

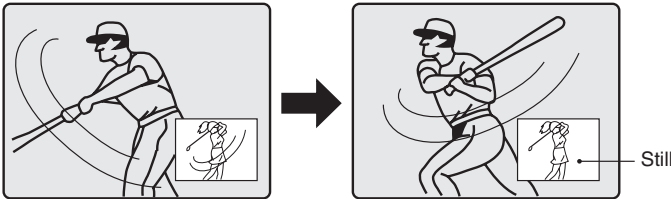

Watching multi-window PIP

Multi-window PIP appears as six small boxes across the bottom of the screen. The multi-window PIP displays only the channels you programmed into the TV's memory (see "Adding channels to the TV's memory" on page 17).

Note: The **LOCATE**, **SWAP**, **PIP CHANNEL ▲▼**, **SOURCE**, and **STILL** buttons do not function in multi-window PIP mode.

To view multi-window PIP:

Press **PIP** three times.

The TV cycles through all of the programmed channels, showing a few seconds of each channel's programming, and then freezes the image and moves on to the next channel in a continuous cycle. The channel number appears above each PIP window.

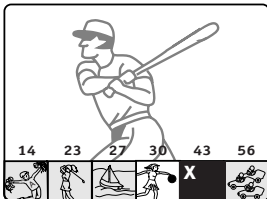

Note:

If V-Chip blocking is enabled when you view multi-window PIP, channels exceeding the rating limits will appear as a black window with a red "X."

To turn multi-window PIP off:

Press **PIP** again, or change the channel.

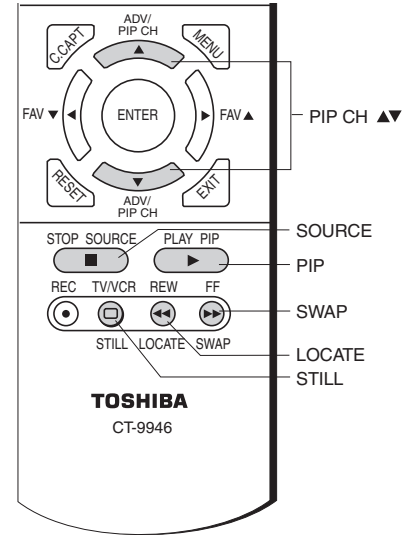

Note:

Multi-window PIP displays channels programmed for the signal source you are currently viewing (ANT-1 or Cable).

Adjusting the picture

Adjusting the picture quality

You can adjust the picture's contrast, brightness, sharpness, color, and tint. Your picture quality adjustments are stored automatically in the TV's memory. You can keep these settings or choose preset options in the PREFERENCE menu (see "Selecting the color temperature" below, and "Adjusting the picture preference" on the next page.)

To adjust the picture quality:

1. Press **MENU**.
2. Press ◀ or ▶ to highlight the PICTURE menu.
3. Press ▲ or ▼ until the quality you want to adjust is highlighted.

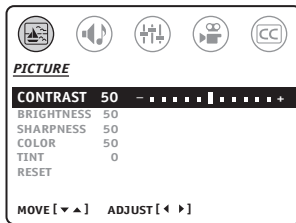

Note:

To reset the picture (and audio) adjustments to the factory settings, select **RESET** in the PICTURE menu.

4. Press ◀ or ▶ to adjust the level, as described in the following table:

Selection	◀ Pressing ▶	
Contrast	Lower	Higher
Brightness	Darker	Lighter
Sharpness	Softer	Sharper
Color	Paler	Deeper
Tint	Reddish	Greenish

Selecting the color temperature

You can change the picture quality by selecting from three preset color temperatures—cool, medium, and warm—as described in the following table:

Mode	Picture Quality
Cool	Blueish
Medium	Neutral
Warm	Reddish

To select the color temperature:

1. Press **MENU**.
2. Press ◀ or ▶ to highlight the PREFERENCE menu.
3. Press ▲ or ▼ to highlight COLOR TEMPERATURE.
4. Press ◀ or ▶ to highlight the mode you prefer.

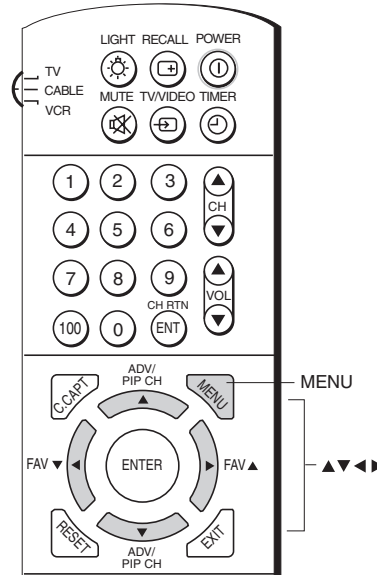
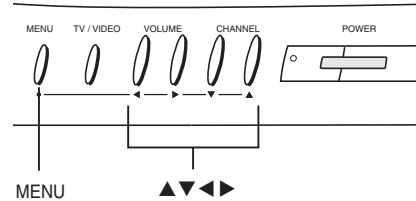
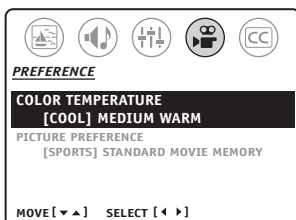

Adjusting the picture preference

You can select four picture modes—Sports, Standard, Movie, and Memory—as described in the following table:

Mode	Picture Quality
Sports	Bright and dynamic picture (factory-set)
Standard	Standard picture quality (factory-set)
Movie	Movie-like picture setting (factory-set)
Memory	Your personal preferences (set by you; see “Adjusting the picture quality” on page 30.)

To select your picture preference:

1. Press **MENU**.
2. Press ◀ or ▶ to highlight the PREFERENCE menu.
3. Press ▲ or ▼ to highlight PICTURE PREFERENCE.
4. Press ◀ or ▶ to highlight the mode you prefer.

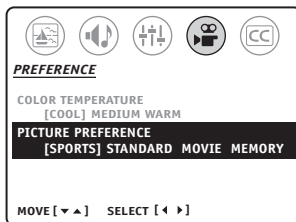

Displaying on-screen information

Press **RECALL** to display the following information on-screen:

- Antenna mode (when in TV mode)
- Channel number or video mode
- Channel label (if set)
- Audio status (stereo or SAP)
- Rating of current program (if rated)

Setting the off timer

The off timer turns the TV off automatically.

To set the off timer:

1. Press **TIMER**.
2. Press ▶ to increase (or ◀ to decrease) the amount of time until the TV turns off automatically (in 10-minute increments, to a maximum of 180).
3. Press **EXIT** to exit the menu and return to normal TV viewing.

To cancel the off timer:

Set the off timer to 0 (zero) minutes in step 2 above, or turn the TV off and then on again.

Auto power off

The TV turns itself off automatically after approximately 15 minutes if it is tuned to a vacant channel or a station that stops broadcasting for the day.

Note: The auto power off feature does not work in VIDEO mode.

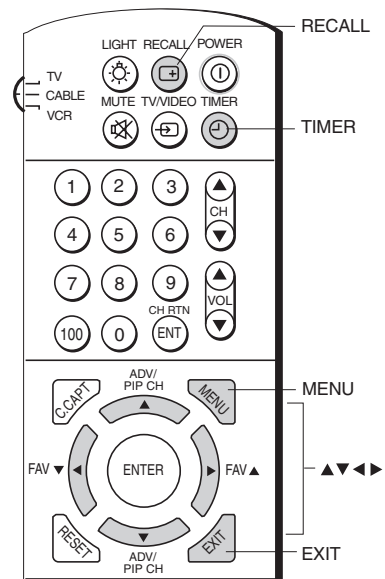
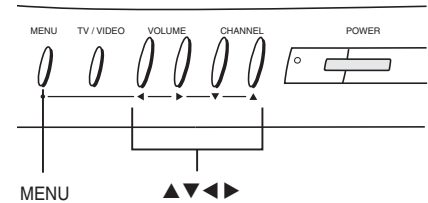

Using the closed caption feature

The Closed Caption feature has two options:

- Captions—An on-screen display of the dialogue, narration, and sound effects of programs and videos that are closed-captioned (usually identified in your local TV listing as “CC”).
- Text—An on-screen display of information not related to the program, such as weather or stock data (if available in your viewing area).

To view captions or text:

1. Tune the TV to the desired program.
2. Press **C.CAPT** (or press **MENU**, and then press ◀ or ▶ to highlight the CLOSED CAPTION menu).
3. Press ▲ or ▼ to highlight CC.

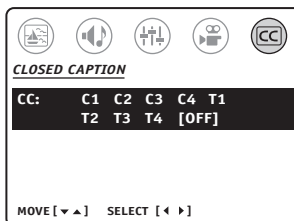

4. Press ◀ or ▶ to select the desired Closed Caption mode, as follows:
 - To view captions, select C1, C2, C3, or C4 (C1 displays translation of the primary language in your area). **Note:** If the program or video you selected is not closed-captioned, no captions will display on the screen.



- To view text, select T1, T2, T3, or T4. **Note:** If text is not available in your viewing area, a black rectangle may appear on your screen. If this occurs, turn the Closed Caption feature off.

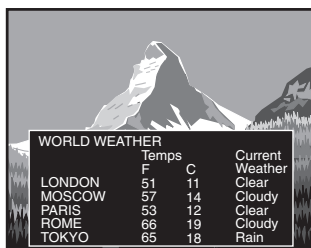

- To turn the Closed Caption feature off, highlight OFF in the Closed Caption menu.

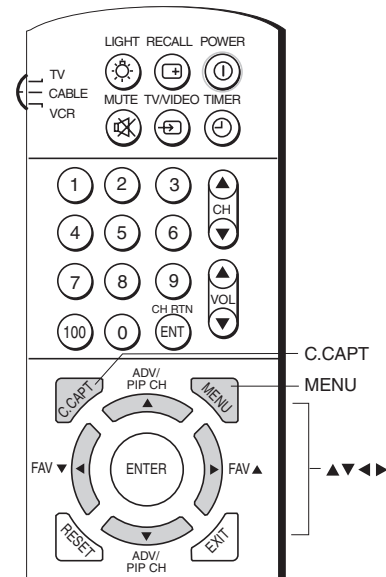

Note:

A closed caption signal may not display in the following situations:

- When a videotape has been dubbed
- When the signal reception is weak
- When the signal reception is non-standard

Adjusting the sound

Muting the sound

Press **MUTE** to temporarily turn off the sound. While the sound is off, the screen displays the word “MUTE” in the lower /right corner. To restore the sound, press **MUTE** or **VOLUME ▲▼**.

When you press **MUTE**, the Closed Caption feature is automatically activated. To deactivate captions and restore normal sound, press **MUTE** again. This feature works only when the Closed Caption mode is set to OFF. See “Using the closed captioned feature” on page 40 for more information about closed caption settings.

Selecting stereo/SAP broadcasts

The multi-channel TV sound (MTS) feature provides high-fidelity stereo sound. MTS also can transmit a second audio program (SAP) containing a second language or other audio information.

Note: The MTS feature is not available in VIDEO mode.

In general, you can leave your TV in stereo mode because the TV automatically outputs either stereo or monaural (“mono”) sound, depending on the broadcast type.

When the TV receives a stereo or SAP broadcast, the word “STEREO” or “SAP” displays on the screen every time you turn the TV on, change the channel, or press **RECALL**.

To listen to stereo sound:

1. Press **MENU**.
2. Press ◀ or ▶ to highlight the AUDIO menu.
3. Press ▲ or ▼ to highlight MTS.
4. Press ◀ or ▶ to highlight STR (stereo).

Note: If the stereo sound is noisy, select MONO to reduce the noise.

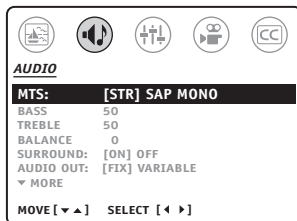

To listen to a second audio program (SAP):

1. Press **MENU**.
2. Press ◀ or ▶ to highlight the AUDIO menu.
3. Press ▲ or ▼ to highlight MTS.
4. Press ◀ or ▶ to highlight SAP. The TV speakers will output only the second audio program.

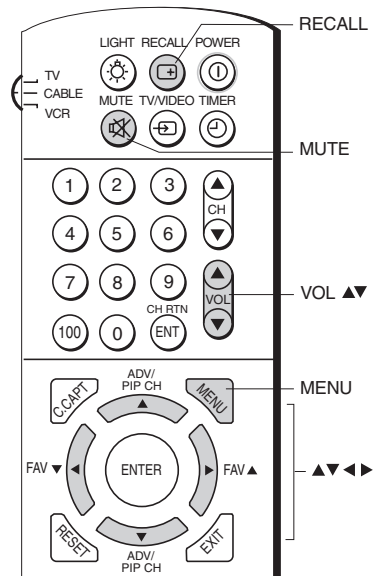

Adjusting the sound quality

You can change the sound quality of your TV by adjusting the bass, treble, and balance.

To adjust the sound quality:

1. Press **MENU**.
2. Press ◀ or ▶ to highlight the AUDIO menu.
3. Press ▲ or ▼ to highlight the quality you want to adjust.
4. Press ◀ or ▶ to adjust the level:
 - ◀ makes the sound quality weaker or decreases the balance in the right channel, depending on the item selected.
 - ▶ makes the sound quality stronger or decreases the balance in the left channel, depending on the item selected.

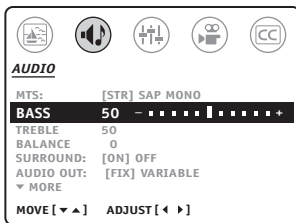

Using the surround sound feature

The surround sound feature expands the audio listening field wider and deeper to create exceptional sound quality from the TV speakers. This feature uses stereo signals from a TV broadcast or video input.

To turn the surround sound feature on:

1. Press **MENU**.
2. Press ◀ or ▶ to highlight the AUDIO menu.
3. If you have not already done so, select STEREO mode (press ▲ or ▼ to highlight MTS, and then press ◀ or ▶ to highlight STR).
4. Press ▲ or ▼ to highlight SURROUND.
5. Press ◀ or ▶ to highlight ON.

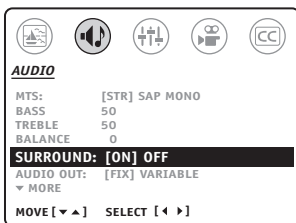

To turn the surround sound feature off:

Highlight OFF in step 5 above. **Note:** In general, you can leave the surround sound feature on because it automatically outputs surround stereo or monaural sound, depending on the broadcast or video type.

Note:

To reset the audio adjustments (bass, treble, and balance) to the factory settings, select **RESET** in the **PICTURE** menu (see page 30).

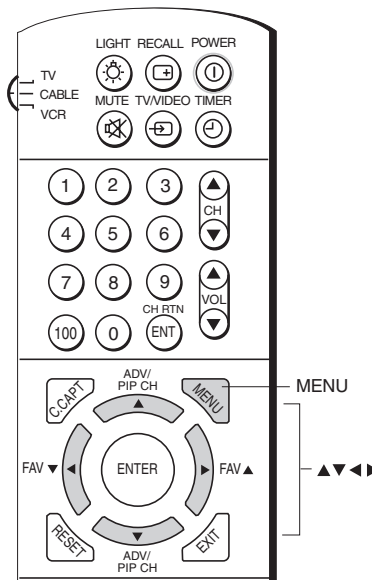
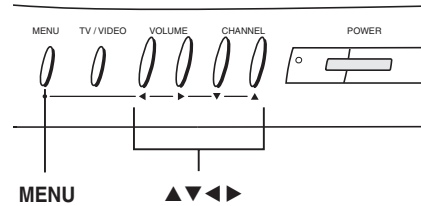

Selecting variable audio OUT

If you connect external audio equipment (such as a stereo audio amplifier or surround sound system) to the TV's Audio OUT jack, you can use the AUDIO OUT feature to select either variable or fixed audio output.

- If you set AUDIO OUT to VARIABLE, you can use the volume controls on either the TV or the audio equipment to adjust the sound level coming through the audio equipment.
- If you set AUDIO OUT to FIX, you must use the volume controls on the audio equipment to adjust the sound level coming through the audio equipment (the TV's volume setting will have no effect).

Note: Fixed audio output provides a cleaner signal than variable audio output.

See page 11 for details on connecting an audio amplifier to the TV's Audio OUT jack.

To select variable audio output:

1. Press **MENU**.
2. Press ◀ or ▶ to highlight the AUDIO menu.
3. Press ▲ or ▼ to highlight AUDIO OUT.
4. Press ◀ or ▶ to highlight VARIABLE.

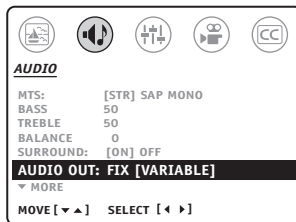

To select fixed audio output:

1. Highlight FIX in step 4 above.

Turning off the built-in speakers

Use this feature to turn off the TV's built-in speakers when you connect external speakers to your TV (see "Connecting an audio amplifier" on page 11).

To turn off the built-in speakers:

1. Press **MENU**.
2. Press ◀ or ▶ to highlight the AUDIO menu.
3. Press ▲ or ▼ to highlight SPEAKERS.
4. Press ◀ or ▶ to highlight OFF.

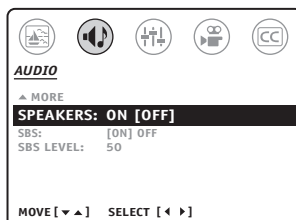

To turn on the built-in speakers:

1. Highlight ON in step 4 above.

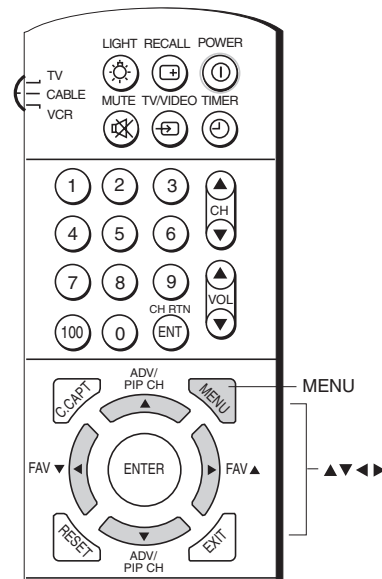
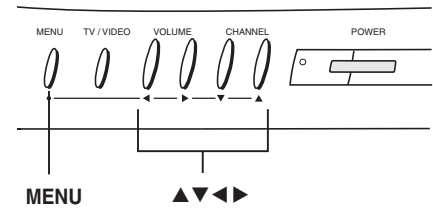

Using the sub-bass system (SBS)

The sub-bass system (SBS) allows you to enhance bass performance, even when the volume is low.

To turn the sub-bass system on (or off):

1. Press **MENU**.
2. Press ◀ or ▶ to highlight the AUDIO menu.
3. Press ▲ or ▼ to highlight SBS.
4. Press ◀ or ▶ to highlight ON (or OFF).

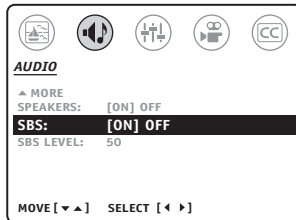

To adjust the sub-bass system:

1. Turn the sub-bass system on, as instructed above.
2. Press **MENU**.
3. Press ◀ or ▶ to highlight the AUDIO menu.
4. Press ▲ or ▼ to highlight SBS LEVEL.
5. Press ◀ or ▶ to adjust the SBS level.

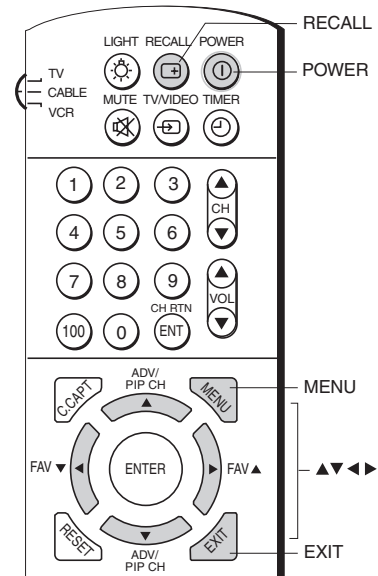
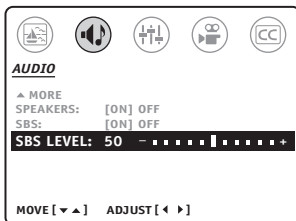

Viewing the demonstration (DEMO) mode

The demonstration (DEMO) mode is an option available on the SET UP menu that will demonstrate several features of your TV.

To start the demonstration mode:

1. Press **MENU**.
2. Press ◀ or ▶ to highlight the SET UP menu.
3. Press ▲ or ▼ to highlight DEMO.
4. Press ◀ or ▶ to highlight START.
4. Press **MENU** to start the demo.

To stop the demonstration mode:

Press **RECALL**, **EXIT**, or **POWER**.

Understanding the last mode memory feature

If the power is cut off while you are viewing the TV, the Last Mode Memory feature turns the TV on automatically when the power is resupplied.

If the power is going to be off for a long time and you are going to be away from your TV, unplug the power cord to prevent the TV from turning on in your absence.

Appendix

Troubleshooting

Before calling a service technician, please check the following table for possible causes of the problem and some solutions.

Problem	Solution
TV will not turn on	<ul style="list-style-type: none"> • Make sure the power cord is plugged in, and then press POWER. • The remote control batteries may be dead. Replace the batteries or press the POWER button on the TV.
No picture, no sound	<ul style="list-style-type: none"> • Check the antenna/cable connections.
No sound, picture OK	<ul style="list-style-type: none"> • The sound may be muted. Press MUTE or VOLUME ▲▼. • The station may have broadcast difficulties. Try another channel.
Poor sound, picture OK	<ul style="list-style-type: none"> • The station may have broadcast difficulties. Try another channel.
Poor picture, sound OK	<ul style="list-style-type: none"> • Check the antenna connections. • The station may have broadcast difficulties. Try another channel. • Adjust the PICTURE menu.
Poor reception of broadcast channels	<ul style="list-style-type: none"> • The station may have broadcast difficulties. Try another channel. • Check the antenna connections. • If you are using a VCR, make sure the TV/VCR button is set correctly.
Cannot receive above channel 13	<ul style="list-style-type: none"> • Make sure TV/CABLE is set to TV mode.
Unable to select a certain channel	<ul style="list-style-type: none"> • The channel may be locked out with the channel lock feature, or erased with the add/erase feature.
Multiple images	<ul style="list-style-type: none"> • The station may have broadcast difficulties. Try another channel. • Use a highly directional outdoor antenna.
Poor color or no color	<ul style="list-style-type: none"> • The station may have broadcast difficulties. Try another channel. • Adjust the TINT and/or COLOR in the PICTURE menu. • If you change the direction of the TV while it is turned on, the picture could suffer from color shading. If so, turn the TV off and allow it to cool down for several hours before turning it on again.
No stereo or SAP sound from a known MTS broadcast	<ul style="list-style-type: none"> • Make sure the MTS feature is set properly.
The remote control does not operate	<ul style="list-style-type: none"> • Check that the TV/CABLE/VCR switch is properly set. • There may be an obstruction between the remote control and the remote control sensor. • The remote control batteries may be dead. Replace the batteries.
The V-Chip PIN code does not work	<ul style="list-style-type: none"> • Change or reset your PIN code.

Specifications

Television system	NTSC standard
Channel coverage	VHF: 2 through 13 UHF: 14 through 69 Cable TV: Mid band (A-8 through A-1, A through 1) Super band (J through W) Hyper band (AA through ZZ, AAA, BBB) Ultra band (65 through 94, 100 through 125)
Power source	120 AC, 60 Hz
Power consumption	96 W
Audio power	5 W + 5 W
Speaker type	2-3/8 x 4-3/4 inches (60 x 120 mm)
Video/Audio terminals	ColorStream® (component video) INPUT Y: 1V (p-p), 75 ohm C _R (P _R): 0.7 V (p-p), 75 ohm C _B (P _B): 0.7 V (p-p), 75 ohm S-VIDEO INPUT Y-INPUT: 1 V (p-p), 75 ohm, negative sync. C-INPUT: 0.286 V (p-p) (burst signal), 75 ohm VIDEO/AUDIO INPUT VIDEO: 1 V (p-p), 75 ohm, negative sync. AUDIO: 150 mV (rms) (30% modulation equivalent, 47 k ohm) VIDEO/AUDIO OUTPUT VIDEO: 1 V (p-p), 75 ohm, negative sync. AUDIO: 150 mV (rms) (30% modulation equivalent, 47 k ohm)
Dimensions	Width: 38-3/16 inches (970 mm) Height: 30-1/16 inches (764 mm) Depth: 25-1/4 inches (641 mm)
Weight	154 lbs (69.9 kg)
Supplied accessories	Remote control with two size "AA" batteries
Optional TV stand	ST-3642

Design and specifications are subject to change without notice.

Limited United States Warranty

for 27" FST PURE® and All Larger Television Models

Toshiba America Consumer Products, Inc. ("TACP") and Toshiba Hawaii, Inc. ("THI") make the following limited warranties to original consumers in the United States. THESE LIMITED WARRANTIES EXTEND TO THE ORIGINAL CONSUMER PURCHASER OR ANY PERSON RECEIVING THIS TELEVISION AS A GIFT FROM THE ORIGINAL CONSUMER PURCHASER AND TO NO OTHER PURCHASER OR TRANSFEREE.

PRODUCTS PURCHASED IN THE U.S.A. AND USED IN CANADA ARE NOT COVERED BY THESE WARRANTIES.

PRODUCTS PURCHASED IN CANADA AND USED IN THE U.S.A. ARE NOT COVERED BY THESE WARRANTIES.

Limited One (1) Year Warranty on Parts and Labor*

TACP/THI warrant this television and its parts against defects in materials or workmanship for a period of one (1) year after the date of original retail purchase. DURING THIS PERIOD, TACP/THI WILL, AT TACP/THI'S OPTION, REPAIR OR REPLACE A DEFECTIVE PART WITH A NEW OR REFURBISHED PART WITHOUT CHARGE TO YOU FOR PARTS OR LABOR. TACP/THI Authorized Service Station personnel will come to your home when warranty service is required. Depending on the type of repair required, either the service will be performed in your home or the set will be taken to the TACP/THI Authorized Service Station for repair and returned to your home at no cost to you.

Limited Two (2) Year Warranty on Picture Tube*

TACP/THI further warrant the picture tube in this television against defects in materials or workmanship for a period of two (2) years after the date of original retail purchase. DURING THIS PERIOD, TACP/THI WILL, AT TACP/THI'S OPTION, REPAIR OR REPLACE A DEFECTIVE PICTURE TUBE WITH A NEW OR REFURBISHED PICTURE TUBE WITHOUT CHARGE TO YOU, EXCEPT THAT, IF A DEFECTIVE PICTURE TUBE IS REPAIRED OR REPLACED AFTER ONE (1) YEAR FROM THE DATE OF THE ORIGINAL RETAIL PURCHASE, YOU PAY LABOR CHARGES INVOLVED IN THE REPAIR OR REPLACEMENT.

Rental Units

The warranty for rental units begins with the date of first rental or thirty (30) days from the date of shipment to the rental firm, whichever comes first.

*Commercial Units

Televisions sold and used for commercial purposes have a limited ninety (90) day warranty for all parts, labor, and picture tubes.

Owner's Manual and Product Registration Card

Read this owner's manual thoroughly before operating this television. Complete and mail the enclosed product registration card within ten days after you, or the person who has given you this product as a gift, purchased this television. Returning the product registration card will enable TACP/THI to provide you with better customer service and improved product support. Failure to return the product registration card will not affect your rights under this warranty.

Your Responsibility

THE ABOVE WARRANTIES ARE SUBJECT TO THE FOLLOWING CONDITIONS:

- (1) You must provide your bill of sale or other proof of purchase.
- (2) All warranty servicing of this television must be made by an Authorized TACP/THI Service Station.
- (3) The warranties from TACP and THI are effective only if the television is purchased and operated in the U.S.A. or Puerto Rico.

- (4) Labor service charges for set installation, setup, adjustment of customer controls, and installation or repair of antenna systems are not covered by these warranties. Reception problems caused by inadequate antenna systems are your responsibility.
- (5) Warranties extend only to defects in materials or workmanship as limited above and do not extend to any television or parts that have been lost or discarded by you or to damage to television or parts caused by misuse, accident, Acts of God (such as lightning or fluctuations in electric power), improper installation, improper maintenance, or use in violation of instructions furnished by TACP/THI; or to units that have been modified or had the serial number removed, altered, defaced, or rendered illegible.

How to Obtain Warranty Services

If, after following all of the operating instructions in this manual and checking the "Troubleshooting" section, you find that service is needed:

- (1) To find the nearest TACP/THI Authorized Service Station:
For televisions purchased in the United States, except Hawaii, visit TACP's web site at www.toshiba.com/tacp, or call toll free 1-800-631-3811.
For televisions purchased in Hawaii, contact Toshiba Hawaii, Inc., 327 Kamakee Street, Honolulu, HI 96814, (808) 591-9281.
- (2) Present your bill of sale or other proof of purchase to the Authorized Service Station. Authorized TACP/THI Service Station personnel will come to your home when warranty service is required. Depending on the type of repair required, either the service will be performed in your home or the set will be taken to the Authorized Service Station for repair and returned to your home at no cost to you.

**For additional information, visit TACP's web site:
www.toshiba.com/tacp.**

ALL WARRANTIES IMPLIED BY THE LAW OF ANY STATE OF THE U.S.A., INCLUDING THE IMPLIED WARRANTIES OF MERCHANTABILITY AND FITNESS FOR A PARTICULAR PURPOSE, ARE EXPRESSLY LIMITED TO THE DURATION OF THE LIMITED WARRANTIES SET FORTH ABOVE. WITH THE EXCEPTION OF ANY WARRANTIES IMPLIED BY THE LAW OF ANY STATE OF THE U.S.A. AS HEREBY LIMITED, THE FOREGOING WARRANTY IS EXCLUSIVE AND IN LIEU OF ALL OTHER WARRANTIES, GUARANTEES, AGREEMENTS, AND SIMILAR OBLIGATIONS OF TACP OR THI WITH RESPECT TO THE REPAIR OR REPLACEMENT OF ANY PARTS. IN NO EVENT SHALL TACP OR THI BE LIABLE FOR CONSEQUENTIAL OR INCIDENTAL DAMAGES.

No person, agent, distributor, dealer, or company is authorized to change, modify, or extend the terms of these warranties in any manner whatsoever. The time within which action must be commenced to enforce any obligation of TACP or THI arising under this warranty or under any law of the United States or of any state thereof is hereby limited to 90 days from the date you discover, or should have discovered, the defect. This limitation does not apply to implied warranties arising under the law of any state of the U.S.A.

THIS WARRANTY GIVES YOU SPECIFIC LEGAL RIGHTS, AND YOU MAY ALSO HAVE OTHER RIGHTS, WHICH MAY VARY FROM STATE TO STATE IN THE U.S.A. SOME STATES OF THE U.S.A. DO NOT ALLOW LIMITATIONS ON THE DURATION OF AN IMPLIED WARRANTY, LIMITATIONS ON THE TIME WITHIN WHICH AN ACTION MAY BE BROUGHT, OR THE EXCLUSION OR LIMITATION OF INCIDENTAL OR CONSEQUENTIAL DAMAGES; THEREFORE, THE ABOVE LIMITATIONS OR EXCLUSIONS MAY NOT APPLY TO YOU UNDER SUCH CIRCUMSTANCES.

FST PURE® is a registered trademark of Toshiba America Consumer Products, Inc.
REV. MAR02

Welcome to
Toshiba

Connecting
your TV

Using the
Remote Control

Setting up
your TV

Using the TV's
Features

Appendix

Limited Canada Warranty

for 27" FST PURE® and All Larger Television Models

Toshiba of Canada Limited ("TCL") makes the following limited warranties to original consumers in Canada.

THESE LIMITED WARRANTIES EXTEND TO THE ORIGINAL CONSUMER PURCHASER OR ANY PERSON RECEIVING THIS TELEVISION AS A GIFT FROM THE ORIGINAL CONSUMER PURCHASER AND TO NO OTHER PURCHASER OR TRANSFEREE.

PRODUCTS PURCHASED IN THE U.S.A. AND USED IN CANADA ARE NOT COVERED BY THESE WARRANTIES.

PRODUCTS PURCHASED IN CANADA AND USED IN THE U.S.A. ARE NOT COVERED BY THESE WARRANTIES.

Limited One (1) Year Warranty on Parts and Labor*

TCL warrants this television and its parts against defects in materials or workmanship for a period of one (1) year after the date of original retail purchase. DURING THIS PERIOD, TCL WILL, AT TCL'S OPTION, REPAIR OR REPLACE A DEFECTIVE PART WITH A NEW OR REFURBISHED PART WITHOUT CHARGE TO YOU FOR PARTS OR LABOR. TCL Authorized Service Depot personnel will come to your home when warranty service is required. Depending on the type of repair required, either the service will be performed in your home or the set will be taken to the TCL Authorized Service Depot for repair and returned to your home at no cost to you. IN-HOME SERVICE ONLY APPLIES WITHIN 100 KILOMETERS OF AN AUTHORIZED TCL SERVICE DEPOT.

Limited Two (2) Year Warranty on Picture Tube*

TCL further warrants the picture tube in this television against defects in materials or workmanship for a period of two (2) years after the date of original retail purchase. DURING THIS PERIOD, TCL WILL, AT TCL'S OPTION, REPAIR OR REPLACE A DEFECTIVE PICTURE TUBE WITH A NEW OR REFURBISHED PICTURE TUBE WITHOUT CHARGE TO YOU, EXCEPT THAT, IF A DEFECTIVE PICTURE TUBE IS REPAIRED OR REPLACED AFTER ONE (1) YEAR FROM THE DATE OF THE ORIGINAL RETAIL PURCHASE, YOU PAY LABOR CHARGES INVOLVED IN THE REPAIR OR REPLACEMENT.

Rental Units

The warranty for rental units begins with the date of first rental or thirty (30) days from the date of shipment to the rental firm, whichever comes first.

*Commercial Units

Televisions sold and used for commercial purposes have a limited ninety (90) day warranty for all parts, labor, and picture tubes.

Owner's Manual

Read this owner's manual thoroughly before operating this television.

Your Responsibility

THE ABOVE WARRANTIES ARE SUBJECT TO THE FOLLOWING CONDITIONS:

- (1) You must provide your bill of sale or other proof of purchase.
- (2) All warranty servicing of this television must be made by an Authorized TCL Service Depot.
- (3) The warranties from TCL are effective only if the television is purchased in Canada from an authorized TCL dealer and operated in Canada.

- (4) Labor service charges for set installation, setup, adjustment of customer controls, and installation or repair of antenna systems are not covered by these warranties. Reception problems caused by inadequate antenna systems are your responsibility.
- (5) Warranties extend only to defects in materials or workmanship as limited above and do not extend to any television or parts that have been lost or discarded by you or to damage to television or parts caused by misuse, accident, Acts of God (such as lightning or fluctuations in electric power), improper installation, improper maintenance, or use in violation of instructions furnished by TCL; or to units that have been modified or had the serial number removed, altered, defaced, or rendered illegible.

How to Obtain Warranty Services

If, after following all of the operating instructions in this manual and checking the "Troubleshooting" section, you find that service is needed:

- (1) To find the nearest TCL Authorized Service Depot, visit TCL's web site: www.toshiba.ca.
- (2) Present your bill of sale or other proof of purchase to the Authorized Service Depot. Authorized TCL Service Depot personnel will come to your home when warranty service is required. Depending on the type of repair required, either the service will be performed in your home or the set will be taken to the Authorized Service Depot for repair and returned to your home at no cost to you. IN-HOME SERVICE ONLY APPLIES WITHIN 100 KILOMETERS OF AN AUTHORIZED TCL SERVICE DEPOT.

**For additional information, visit TCL's web site:
www.toshiba.ca**

ALL WARRANTIES IMPLIED BY THE LAW OF ANY PROVINCE OF CANADA, INCLUDING THE IMPLIED WARRANTIES OF MERCHANTABILITY AND FITNESS FOR A PARTICULAR PURPOSE, ARE EXPRESSLY LIMITED TO THE DURATION OF THE LIMITED WARRANTIES SET FORTH ABOVE. WITH THE EXCEPTION OF ANY WARRANTIES IMPLIED BY THE LAW OF ANY PROVINCE OF CANADA AS HEREBY LIMITED, THE FOREGOING WARRANTY IS EXCLUSIVE AND IN LIEU OF ALL OTHER WARRANTIES, GUARANTEES, AGREEMENTS, AND SIMILAR OBLIGATIONS OF TCL WITH RESPECT TO THE REPAIR OR REPLACEMENT OF ANY PARTS. IN NO EVENT SHALL TCL BE LIABLE FOR CONSEQUENTIAL OR INCIDENTAL DAMAGES.

No person, agent, distributor, dealer, or company is authorized to change, modify, or extend the terms of these warranties in any manner whatsoever. The time within which action must be commenced to enforce any obligation of TCL arising under this warranty or under any law of Canada or of any province thereof, is hereby limited to 90 days from the date you discover, or should have discovered, the defect. This limitation does not apply to implied warranties arising under the law of any province of Canada.

THIS WARRANTY GIVES YOU SPECIFIC LEGAL RIGHTS, AND YOU MAY ALSO HAVE OTHER RIGHTS, WHICH MAY VARY FROM PROVINCE TO PROVINCE IN CANADA. SOME PROVINCES OF CANADA DO NOT ALLOW LIMITATIONS ON THE DURATION OF AN IMPLIED WARRANTY, LIMITATIONS ON THE TIME WITHIN WHICH AN ACTION MAY BE BROUGHT, OR THE EXCLUSION OR LIMITATION OF INCIDENTAL OR CONSEQUENTIAL DAMAGES; THEREFORE, THE ABOVE LIMITATIONS OR EXCLUSIONS MAY NOT APPLY TO YOU UNDER SUCH CIRCUMSTANCES.

FST PURE® is a registered trademark of Toshiba America Consumer Products, Inc.
REV. MAR02

TOSHIBA AMERICA CONSUMER PRODUCTS, INC.

HEAD OFFICE: 82 TOTOWA ROAD, WAYNE, NJ 07470, U.S.A.

NATIONAL SERVICE DIVISION: 1420-B TOSHIBA DRIVE, LEBANON, TN 37087, U.S.A.

TOSHIBA HAWAII, INC.

HEAD OFFICE: 327 KAMAKEE STREET, HONOLULU, HI 96814, U.S.A. – TEL: (808) 591-9281

TOSHIBA OF CANADA LTD.

HEAD OFFICE: 191 McNABB STREET, MARKHAM, ONTARIO, L3R 8H2, CANADA – TEL: (905) 470-5400

SERVICE CENTERS:

TORONTO: 191 McNABB STREET, MARKHAM, ONTARIO, L3R 8H2, CANADA – TEL: (905) 470-5400

MONTREAL: 1643 NORTH SERVICE RD., TRANS-CANADA HIGHWAY, DORVAL QUEBEC, H9P 1J1, CANADA – TEL: (514) 856-4100

VANCOUVER: 22171 FRASERWOOD WAY, RICHMOND, B.C., V6W 1J5, CANADA – TEL: (604) 303-2500

MANUFACTURED BY

TOSHIBA AMERICA CONSUMER PRODUCTS, INC.

ColorStream is a registered trademark of Toshiba America Consumer Products, Inc.

PRINTED IN USA
(02-06)B

TOSHIBA

Free Manuals Download Website

<http://myh66.com>

<http://usermanuals.us>

<http://www.somanuals.com>

<http://www.4manuals.cc>

<http://www.manual-lib.com>

<http://www.404manual.com>

<http://www.luxmanual.com>

<http://aubethermostatmanual.com>

Golf course search by state

<http://golfingnear.com>

Email search by domain

<http://emailbydomain.com>

Auto manuals search

<http://auto.somanuals.com>

TV manuals search

<http://tv.somanuals.com>