

TOSHIBA



DVD VIDEO PLAYER **SD-2200**

OWNER'S MANUAL



Introduction **2**

Connections **16**

Basic playback **20**

Advanced playback **26**

Function setup **35**

Others **43**

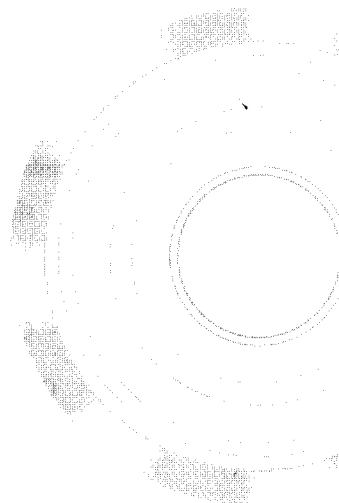
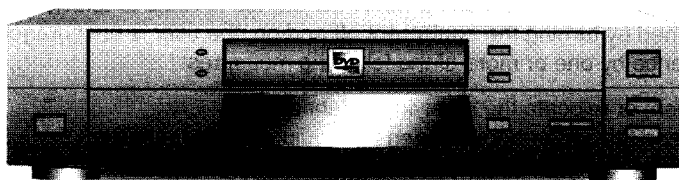

SAFETY PRECAUTIONS

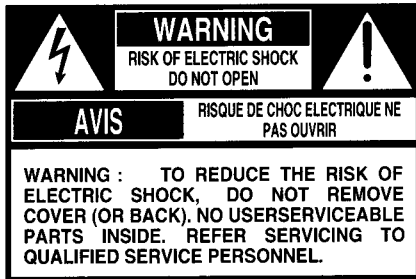

The lightning flash with arrowhead symbol, within an equilateral triangle, is intended to alert the user to the presence of uninsulated "dangerous voltage" within the product's enclosure that may be of sufficient magnitude to constitute a risk of electric shock to persons.



The exclamation point within an equilateral triangle is intended to alert the user to the presence of important operating and maintenance (servicing) instructions in the literature accompanying the appliance.

WARNING: TO REDUCE THE RISK OF FIRE OR ELECTRIC SHOCK, DO NOT EXPOSE THIS APPLIANCE TO RAIN OR MOISTURE. DANGEROUS HIGH VOLTAGES ARE PRESENT INSIDE THE ENCLOSURE. DO NOT OPEN THE CABINET. REFER SERVICING TO QUALIFIED PERSONNEL ONLY.

CAUTION: TO PREVENT ELECTRIC SHOCK, MATCH WIDE BLADE OF PLUG TO WIDE SLOT, FULLY INSERT.

ATTENTION: POUR EVITER LES CHOCES ELECTRIQUES, INTRODUIRE LA LAME LA PLUS LARGE DE LA FICHE DANS LA BORNE CORRESPONDANTE DE LA PRISE ET POUSSER JUSQU'AU FOND.

CAUTION: This Digital Video Disc Player employs a Laser System. To ensure proper use of this product, please read this owner's manual carefully and retain for future reference. Should the unit require maintenance, contact an authorized service location - see service procedure.

Use of controls or adjustments or performance of procedures other than those specified herein may result in hazardous radiation exposure.

To prevent direct exposure to laser beam, do not try to open the enclosure. Visible laser radiation when open and interlocks defeated. DO NOT STARE INTO BEAM.

FCC NOTICE: This equipment has been tested and found to comply with the limits for a Class B digital device, pursuant to part 15 of the FCC Rule. These limits are designed to provide reasonable protection against harmful interference in a residential installation.

This equipment generates, uses, and can radiate radio frequency energy and, if not installed and used in accordance with the instructions, may cause harmful interference to radio communications.

However, there is no guarantee that interference will not occur in a particular installation. If this equipment does cause harmful interference to radio or television reception, which can be determined by turning the equipment off and on, the user is encouraged to try to correct the interference by one or more of the following measures:

- Reorient or relocate the receiving antenna.
- Increase the separation between the equipment and receiver.
- Connect the equipment into an outlet on a circuit different from that to which the receiver is connected.
- Consult the dealer or an experienced radio/TV technician for help.

WARNING: Changes or modifications made to this equipment, not expressly approved by Toshiba, or parties authorized by Toshiba, could void the user's authority to operate the equipment.

In the spaces provided below, record the Model and Serial No. located on the rear panel of your DVD video player.

Model No. _____

Serial No. _____

Retain this information for future reference.

Location of the required label

PRODUCT IS CERTIFIED BY THE MANUFACTURER TO
COMPLY WITH DHHS RULE 21 CFR SUBCHAPTER J
APPLICABLE AT THE DATE OF MANUFACTURE.

MANUFACTURED

TOSHIBA CORPORATION

1-1, SHIBAURA 1-CHOME, MINATO-KU.
TOKYO 105-8001, JAPAN

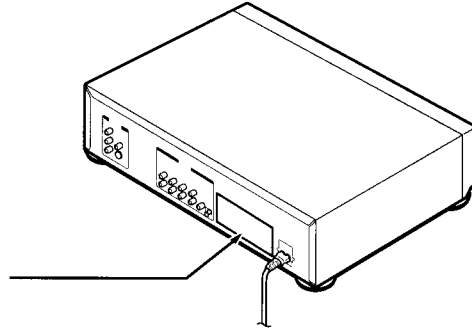

IMPORTANT SAFETY INSTRUCTIONS

CAUTION: PLEASE READ AND OBSERVE ALL WARNINGS AND INSTRUCTIONS GIVEN IN THIS OWNER'S MANUAL AND THOSE MARKED ON THE UNIT. RETAIN THIS BOOKLET FOR FUTURE REFERENCE.

This set has been designed and manufactured to assure personal safety. Improper use can result in electric shock or fire hazard. The safeguards incorporated in this unit will protect you if you observe the following procedures for installation, use and servicing. This unit is fully transistorized and does not contain any parts that can be repaired by the user.

DO NOT REMOVE THE CABINET COVER, OR YOU MAY BE EXPOSED TO DANGEROUS VOLTAGE. REFER SERVICING TO QUALIFIED SERVICE PERSONNEL ONLY.

1. Read owner's manual

After unpacking this product, read the owner's manual carefully, and follow all the operating and other instructions.

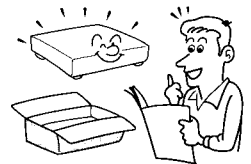

2. Power Sources

This product should be operated only from the type of power source indicated on the label. If you are not sure of the type of power supply to your home, consult your product dealer or local power company. For products intended to operate from battery power, or other sources, refer to the operating instructions.



3. Grounding or Polarization

This product may be equipped with a polarized alternating current line plug (a plug having one blade wider than the other). This plug will fit into the power outlet only one way. This is a safety feature. If you are unable to insert the plug fully into the outlet, try reversing the plug. If the plug should still fail to fit, contact your electrician to replace your obsolete outlet. Do not defeat the safety purpose of the polarized plug.

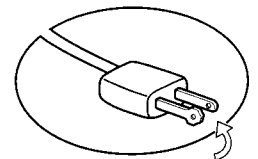

4. Ventilation

Slots and openings in the cabinet are provided for ventilation and to ensure reliable operation of the product and to protect it from overheating, and these openings must not be blocked or covered. The openings should never be blocked by placing the product on a bed, sofa, rug or other similar surface. This product should not be placed in a built-in installation such as a bookcase or rack unless proper ventilation is provided or the manufacturer's instructions have been adhered to.



5. Heat

The product should be situated away from heat sources such as radiators, heat registers, stoves, or other products (including amplifiers) that produce heat.

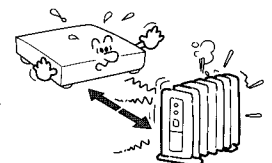

6. Water and Moisture

Do not use this product near water - for example, near a bath tub, wash bowl, kitchen sink, or laundry tub; in a wet basement; or near a swimming pool and the like.

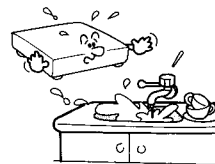

7. Cleaning

Unplug this product from the wall outlet before cleaning. Do not use liquid cleaners or aerosol cleaners. Use a damp cloth for cleaning.



8. Power-Cord Protection

Power-supply cords should be routed so that they are not likely to be walked on or pinched by items placed upon or against them, paying particular attention to cords at plugs, convenience receptacles, and the point where they exit from the product.



9. Overloading

Do not overload wall outlets; extension cords, or integral convenience receptacles as this can result in a risk of fire or electric shock.



10. Lightning

For added protection for this product during storm, or when it is left unattended and unused for long periods of time, unplug it from the wall outlet. This will prevent damage to the product due to lightning and power-line surges.



11. Object and Liquid Entry

Never push objects of any kind into this product through openings as they may touch dangerous voltage points or short-out parts that could result in a fire or electric shock. Never spill liquid of any kind on the product.



12. Attachments

Do not use attachments not recommended by the product manufacturer as they may cause hazards.

IMPORTANT SAFETY INSTRUCTIONS

13. Accessories

Do not place this product on an unstable cart, stand, tripod, bracket, or table. The product may fall, causing serious injury to a child or adult, and serious damage to the product. Use only with a cart, stand, tripod, bracket, or table recommended by the manufacturer, or sold with the product. Any mounting of the product should follow the manufacturer's instructions, and should use a mounting accessory recommended by the manufacturer.

A product and cart combination should be moved with care. Quick stops, excessive force, and uneven surfaces may cause the product and cart combination to overturn.



14. Disc Tray

Keep your fingers well clear of the disc tray as it is closing. Neglecting to do so may cause serious personal injury.

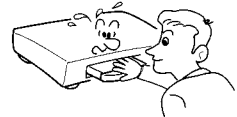

15. Burden

Do not place a heavy object on or step on the product. The object may fall, causing serious personal injury and serious damage to the product.

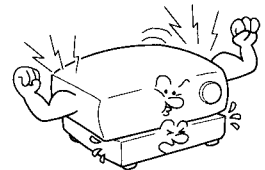

16. Headphones

When you use headphones, keep the volume at a moderate level. If you use the headphones continuously with high volume sound, it may cause hearing damage.



17. Disc

Do not use a cracked, deformed, or repaired disc. These discs are easily broken and may cause serious personal injury and product malfunction.

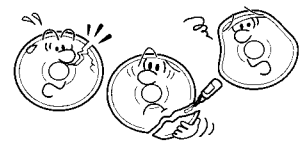

18. Damage Requiring Service

Unplug this product from the wall outlet and refer servicing to qualified service personnel under the following conditions:

- a) When the power-supply cord or plug is damaged.
- b) If liquid has been spilled, or objects have fallen into the product.
- c) If the product has been exposed to rain or water.
- d) If the product does not operate normally by following the operating instructions. Adjust only those controls that are covered by the operating instructions as an improper adjustment of other controls may result in damage and will often require extensive work by a qualified technician to restore the product to its normal operation.
- e) If the product has been dropped or damaged in any way.
- f) When the product exhibits a distinct change in performance - this indicates a need for service.

19. Servicing

Do not attempt to service this product yourself as opening or removing covers may expose you to dangerous voltage or other hazards. Refer all servicing to qualified service personnel.



20. Replacement Parts

When replacement parts are required, be sure the service technician has used replacement parts specified by the manufacturer or have the same characteristics as the original part. Unauthorized substitutions may result in fire, electric shock, or other hazards.

21. Safety Check

Upon completion of any service or repairs to this product, ask the service technician to perform safety checks to determine that the product is in proper operating condition.

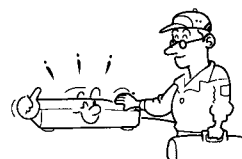

Precautions

Notes on handling

- When shipping the DVD video player, the original shipping carton and packing materials come in handy. For maximum protection, repack the unit as it was originally packed at the factory.
- Do not use volatile liquids, such as insect spray, near the DVD video player. Do not leave rubber or plastic products in contact with the DVD video player for a long time. They will leave marks on the finish.
- The top and rear panels of the DVD video player may become warm after a long period of use. This is not a malfunction.
- When the DVD video player is not in use, be sure to remove the disc and turn off the power.
- If you do not use the DVD video player for a long period, the unit may not function properly in the future. Turn on and use the DVD video player occasionally.

Notes on locating

- Place the DVD video player on a level surface. Do not use it on a shaky or unstable surface such as a wobbling table or inclined stand. The loaded disc may come off the proper position and cause damage to the DVD video player.
- When you place this DVD video player near a TV, radio, or VCR, the playback picture may become poor and the sound may be distorted. In this case, place the DVD video player away from the TV, radio, or VCR.

Notes on cleaning

Use a soft, dry cloth for cleaning.

- For stubborn dirt, soak the cloth in a weak detergent solution, wring well and wipe. Use a dry cloth to wipe it dry.
Do not use any type of solvent, such as thinner and benzene, as they may damage the surface of the DVD video player.
- If you use a chemical saturated cloth to clean the unit, follow that product's instructions.

To obtain a clear picture

The DVD video player is a high technology, precision device. If the optical pick-up lens and disc drive parts are dirty or worn down, the picture quality becomes poor. To obtain a clear picture, we recommend regular inspection and maintenance (cleaning or parts replacement) every 1,000 hours of use depending on the operating environment. For details, contact your nearest dealer.

Notes on moisture condensation

Moisture condensation damages the DVD video player. Please read the following carefully.

Moisture condensation occurs, for example, when you pour a cold drink into a glass on a warm day. Drops of water form on the outside of the glass. In the same way, moisture may condense on the optical pick-up lens inside this unit, one of the most crucial internal parts of the DVD video player.

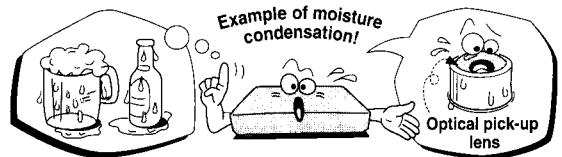

■ **Moisture condensation occurs during the following cases.**

- When you bring the DVD video player directly from a cold place to a warm place.
- When you use the DVD video player in a room where you just turned on the heater, or a place where the cold wind from the air conditioner directly hits the unit.
- In summer, when you use the DVD video player in a hot and humid place just after you move the unit from an air conditioned room.
- When you use the DVD video player in a humid place.

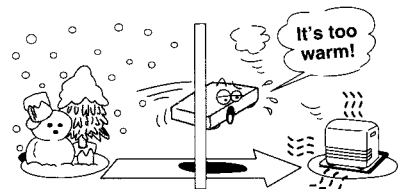

■ **Do not use the DVD video player when moisture condensation may occur.**

If you use the DVD video player in such a situation, it may damage discs and internal parts. Remove the disc, connect the power cord of the DVD video player to the wall outlet, turn on the DVD video player, and leave it for two or three hours. After two or three hours, the DVD video player will have warmed up and evaporated any moisture. Keep the DVD video player connected to the wall outlet and moisture condensation will seldom occur.

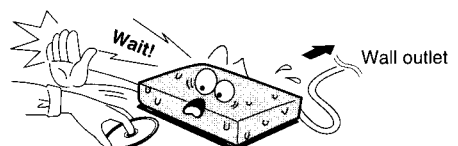

On handling discs

- Do not touch the playback side of the disc.

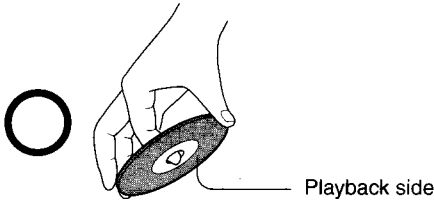

- Do not attach paper or tape to discs.



On cleaning discs

- Fingerprints and dust on the disc cause picture and sound deterioration. Wipe the disc from the center outwards with a soft cloth. Always keep the disc clean.

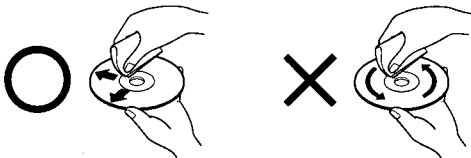

- If you cannot wipe off the dust with a soft cloth, wipe the disc lightly with a slightly moistened soft cloth and finish with a dry cloth.
- Do not use any type of solvent such as thinner, benzene, commercially available cleaners or antistatic spray for vinyl LPs. It may damage the disc.

On storing discs

- Do not store discs in a place subject to direct sunlight or near heat sources.
- Do not store discs in places subject to moisture and dust such as a bathroom or near a humidifier.
- Store discs vertically in a case. Stacking or placing objects on discs outside of their case may cause warping.

Structure of disc contents

Normally, DVD video discs are divided into titles, and the titles are sub-divided into chapters. VIDEO CDs/audio CDs are divided into tracks.

DVD video disc

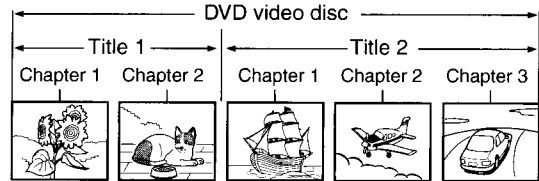

VIDEO CD/Audio CD

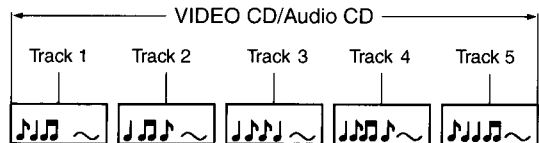

Each title, chapter or track is assigned a number, which is called "title number", "chapter number" or "track number" respectively.

There may be discs that do not have these numbers.

Notes on copyright

It is forbidden by law to copy, broadcast, show, broadcast on cable, play in public, and rent copyrighted material without permission.

DVD video discs are copy protected, and any recordings made from these discs will be distorted.

This product incorporates copyright protection technology that is protected by method claims of certain U.S. patents and other intellectual property rights owned by Macrovision Corporation and other rights owners. Use of this copyright protection technology must be authorized by Macrovision Corporation, and is intended for home and other limited viewing uses only unless otherwise authorized by Macrovision Corporation. Reverse engineering or disassembly is prohibited.



Notes on Discs (continued)

About this owner's manual

This owner's manual explains the basic instructions of this DVD video player. Some DVD video discs are produced in a manner that allows specific or limited operation during playback. As such, the DVD video player may not respond to all operating commands. This is not a defect in the DVD video player. Refer to instruction notes of discs.

"⊘" may appear on the TV screen during operation. A "⊘" means that the operation is not permitted by the DVD video player or the disc.

Notes on region numbers

The region number of this DVD video player is 1. If region numbers, which stand for their playable area, are printed on your DVD video disc and you do not find  or , disc playback will not be allowed by the player. (In this case, the DVD video player will display a message on-screen.)



On VIDEO CDs

This DVD video player supports VIDEO CDs equipped with the PBC (Version 2.0) function. (PBC is the abbreviation of Playback Control.) You can enjoy two playback variations depending on types of discs.

- **VIDEO CD not equipped with PBC function (Version 1.1)**
Sound and movie can be played on this DVD video player in the same way as an audio CD.
- **VIDEO CD equipped with PBC function (Version 2.0)**
In addition to operation of a VIDEO CD not equipped with the PBC function, you can enjoy playback of interactive software with search function by using the menu displayed on the TV screen (Menu Playback). Some of the functions described in this owner's manual may not work with some discs.

Playable discs

This DVD video player can play the following discs.

| | Disc Mark | Contents | Disc Size | Maximum playback time |
|-----------------|--|---------------------------------|------------------|---|
| DVD video discs |  | Audio + video (moving pictures) | 12 cm | Approx. 4 hours (single sided disc) |
| | | | | Approx. 8 hours (double sided disc) |
| | | | 8 cm | Approx. 80 minutes (single sided disc) |
| | | | | Approx. 160 minutes (double sided disc) |
| VIDEO CDs |  | Audio + video (moving pictures) | 12 cm | Approx. 74 minutes |
| | | | 8 cm | Approx. 20 minutes |
| Audio CDs |  | Audio | 12 cm | Approx. 74 minutes |
| | | | 8 cm (CD single) | Approx. 20 minutes |

- You cannot play discs other than those listed above.
- You cannot play discs of CD-R, CD-RW, DVD-RAM, DVD-RW, etc., even if they may be labeled marks listed above.
- This DVD video player uses the NTSC color system, and cannot play DVD video discs recorded in any other color system (PAL, SECAM, etc.).

Table of Contents

Introduction

- SAFETY PRECAUTIONS 2
- IMPORTANT SAFETY INSTRUCTIONS ... 4
- Precautions 8
- Notes on Discs 9
 - Notes on region numbers 10
- Table of Contents 11
- Identification of Controls 12
 - Front panel 12
 - Rear panel 12
 - DVD display 13
 - Remote control 14
 - Loading batteries 15
 - Operating with the remote control 15

Connections

- Connecting to a TV 16
 - Connecting to a TV 16
 - Connecting to an audio system and TV equipped with ColorStream™ (Component video) inputs 17
- Connecting to Optional Equipment 18
 - Connecting to an amplifier equipped with a Dolby Digital decoder 18
 - Connecting to an amplifier equipped with 5.1ch audio inputs 18
 - Connecting to an amplifier equipped with Dolby Pro Logic Surround 18
 - Connecting to an amplifier equipped with a DTS decoder 19
 - Connecting to an amplifier equipped with an MPEG2 audio decoder 19
 - Connecting to an amplifier equipped with a digital audio input 19

Basic playback

- Playing a Disc 20
 - Basic playback 20
 - Playing fast in reverse or forward direction 22
 - Playing frame by frame 22
 - Playing in slow-motion 23
 - Resuming playback from the same location ... 23
- Locating a Specific Title, Chapter, or Track 24
 - Locating a title using the top menu 24
 - Locating a title by entering the title number 24
 - Locating a specific chapter or track directly 25
 - Locating a specific chapter or track 25

Advanced playback

- Locating a Specific Location Directly ... 26
 - Entering the time of the desired location 26
- Playing Repeatedly 27
 - Repeating a title, chapter, or track 27
 - Repeating a specific segment 27
- Playing in a Favorite Order 28
 - Setting titles, chapters, or tracks in a favorite order 28
- Playing in Random Order 29
 - Playing titles, chapters or tracks in random order 29
- Zooming a Picture 30
 - Zooming a Picture 30
- Selecting 3-D (N-2-2) Sound Enhancement 30
 - Selecting 3-D (N-2-2) Sound Enhancement ... 30
- Selecting the Camera Angle 31
 - Changing the camera angle 31
- Selecting Subtitles 32
 - Selecting a subtitle language 32
- Selecting a Language 33
 - Selecting a playback audio setting 33
- Viewing the Operational Information and DVD/CD-Text 34
 - Checking the operational status 34
 - Checking the remaining time and setting status 34

Function setup

- Customizing the Function Settings 35
 - Setting procedure 35
 - Setting details 37

Others

- Table of Languages 43
- Before Calling Service Personnel 44
- Specifications 45
- LIMITED WARRANTY DVD VIDEO PLAYER 46

Identification of Controls

See the page in  for details.

Front panel

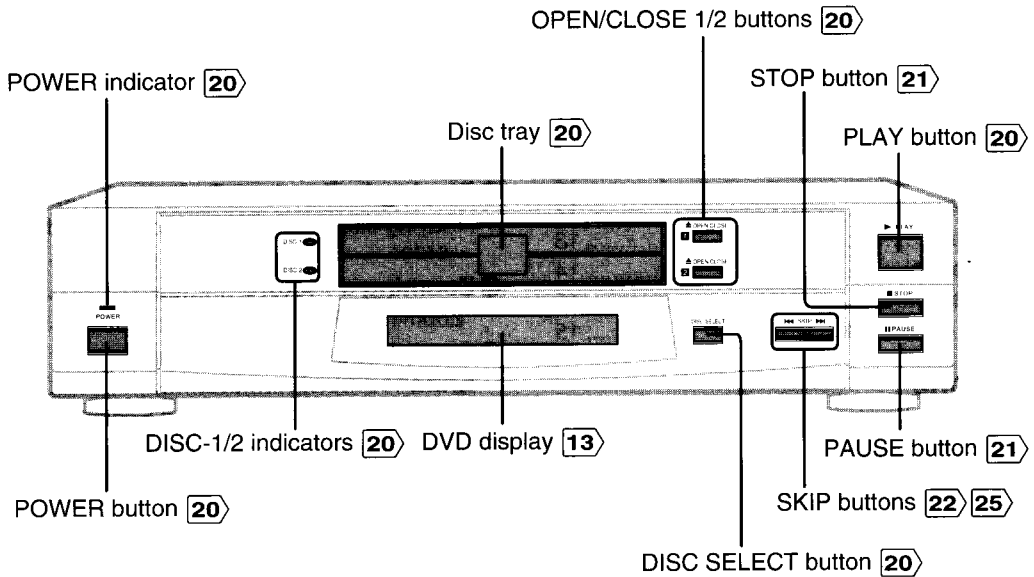

Rear panel

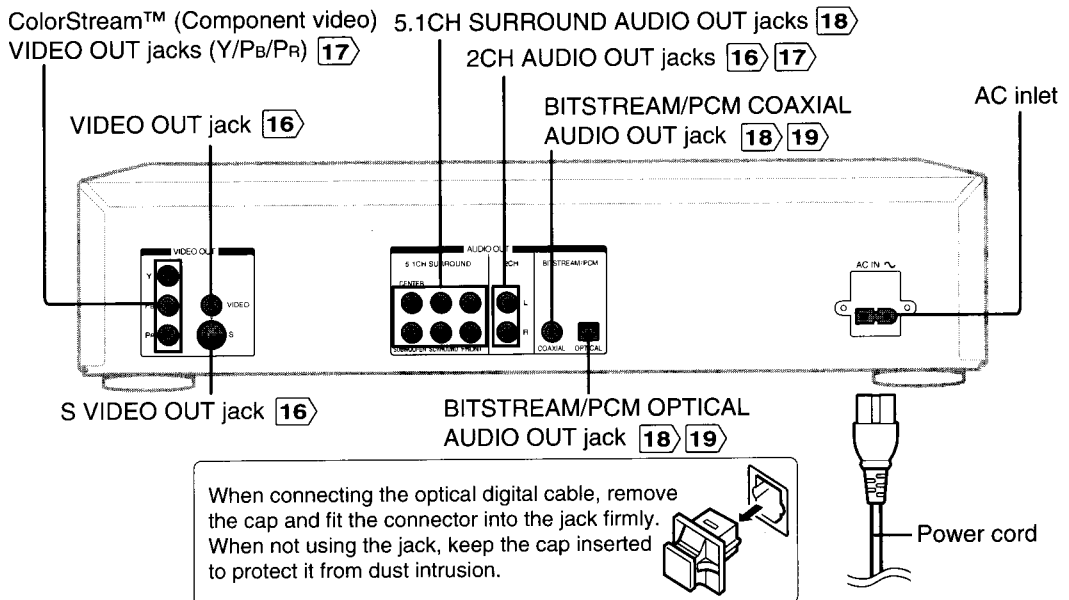

DVD display

■ Pressing of the FL DIMMER button on the remote control changes the brightness of the display.



Normal → Dimmed → Off

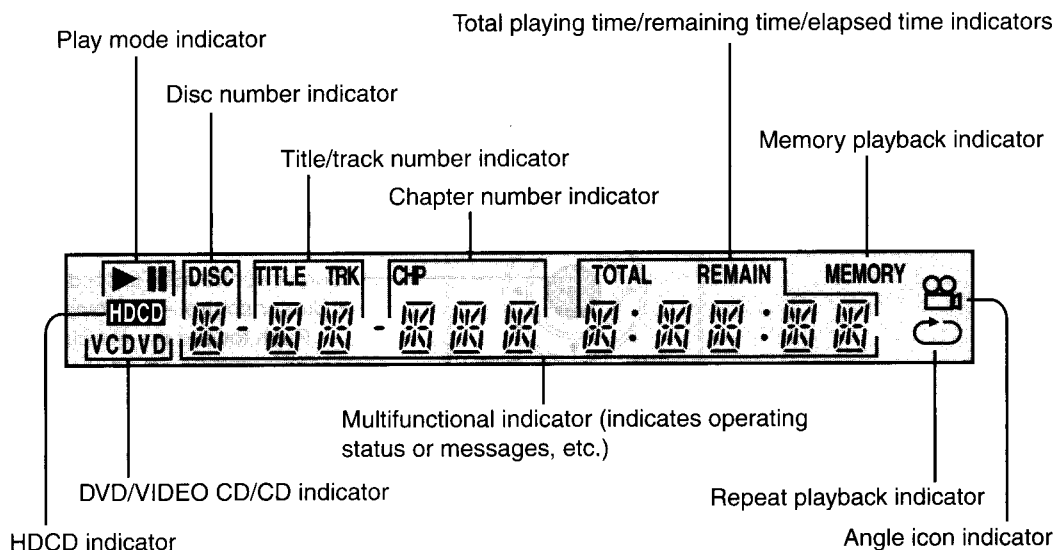

The indicators vary depending on the kinds of discs you play.

DVD video disc

- When closing the disc tray:

Example

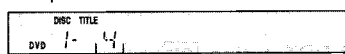

Total number of titles

- During playback:

Example

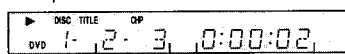

Playing chapter 3
Elapsed time of the current title

Some discs may not display chapter numbers or elapsed time.

VIDEO CD

- When closing the disc tray:

Example



Total number of tracks Total playing time of the disc

- During playback:

Example

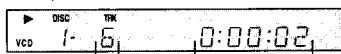

Playing track 6 Elapsed time of the current track

Some discs may not display track numbers or elapsed time.

Audio CD

- When closing the disc tray:

Example



Total number of tracks Total playing time of the disc

- During playback:

Example



Playing track 6 Elapsed time of the current track

Identification of Controls (continued)

The instructions in this manual describe the functions on the remote control. See the page in  for details.

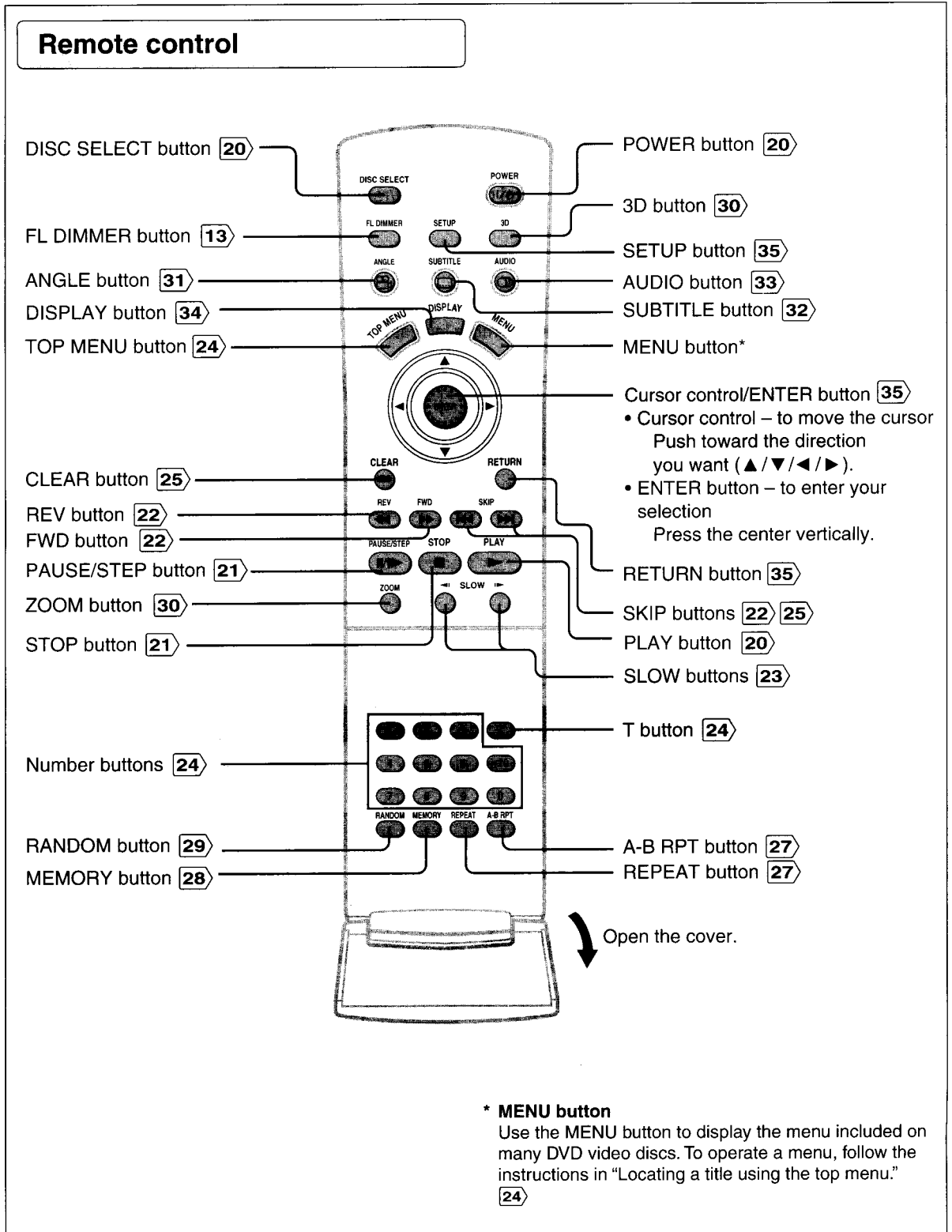

Loading batteries

1 Open the cover.

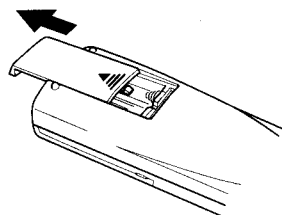

2 Insert batteries (AAA size).

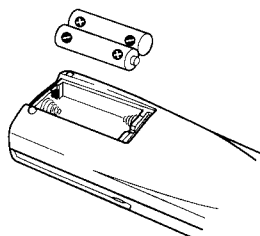

Make sure to match the + and – on the batteries to the marks inside the battery compartment.

3 Close the cover.

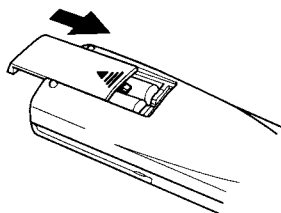

Notes on batteries

Improper use of batteries may cause battery leakage and corrosion. To operate the remote control correctly, follow the instructions below.

- Do not insert batteries into the remote control in the wrong direction.
- Do not charge, heat, open, or short-circuit the batteries. Do not throw batteries into a fire.
- Do not leave dead or exhausted batteries in the remote control.
- Do not use different types of batteries together, or mix old and new batteries.
- If you do not use the remote control for a long period of time, remove the batteries to avoid possible damage from battery corrosion.
- If the remote control does not function correctly or if the operating range becomes reduced, replace all batteries with new ones.
- If battery leakage occurs, wipe the battery liquid from the battery compartment, then insert new batteries.

Operating with the remote control

Point the remote control at the remote sensor and press the buttons.

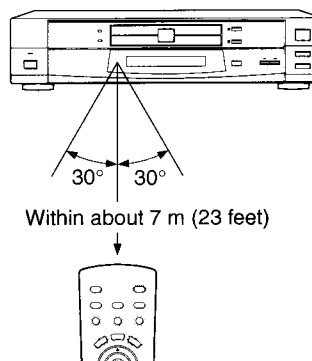

Within about 7 m (23 feet)

Distance: About 7 m (23 feet) from the front of the remote sensor

Angle: About 30° in each direction of the front of the remote sensor

* Do not expose the remote sensor of the DVD video player to a strong light source such as direct sunlight or other illumination. If you do so, you may not be able to operate the DVD video player via the remote control.

Notes on the remote control

- Direct the remote control at the remote sensor of the DVD video player.
- Do not drop or give the remote control a shock.
- Do not leave the remote control near an extremely hot or humid place.
- Do not spill water or put anything wet on the remote control.
- Do not open the remote control.

Connecting to a TV

Connect the DVD video player to your TV.

For details of output sound, see [33](#).

Connecting to a TV

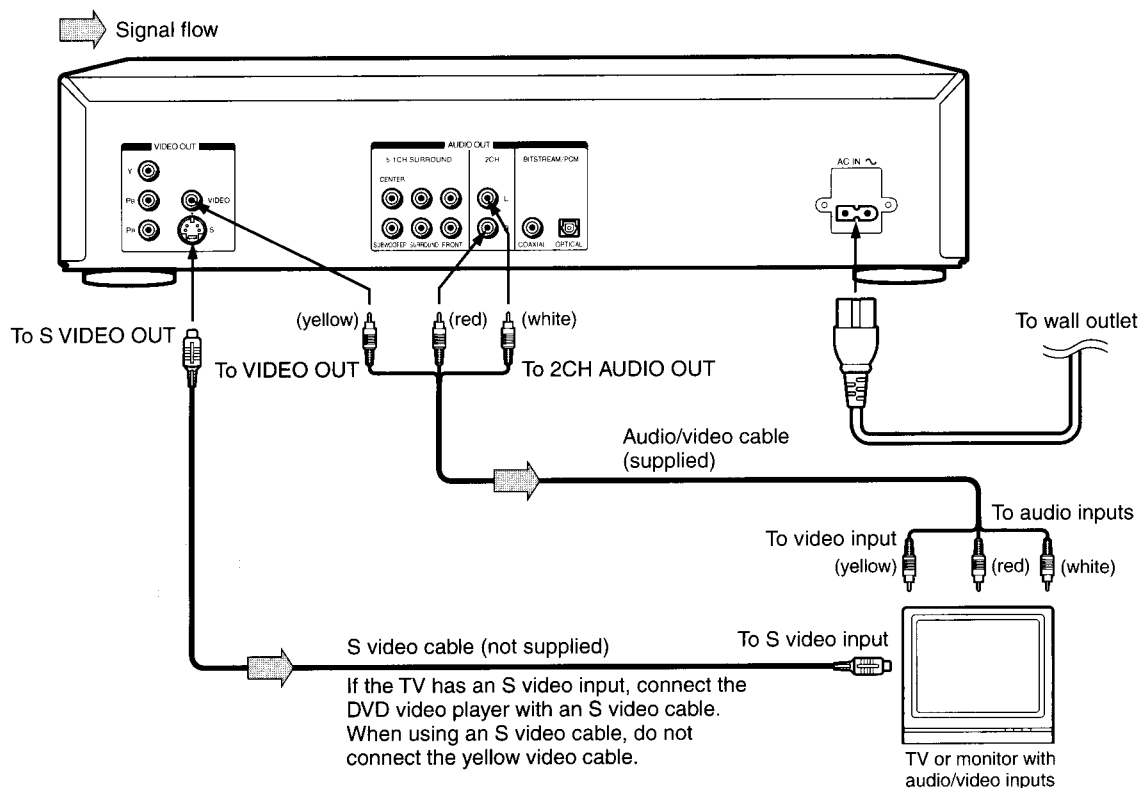

- Make the following setting.

| Setting | Select: | Page |
|--------------------|--------------|--|
| "Audio Out Select" | "Analog 2ch" | 35 39 |

Notes

- Refer to the owner's manual of the connected TV as well.
- When you connect the DVD video player to your TV, be sure to turn off the power and unplug both units from the wall outlet before making any connections.
- If your television set has one audio input, connect the DVD video player to a Y cable adapter (not supplied) and then connect to your TV.
- Connect the DVD video player directly to your TV. If you connect the DVD video player to a VCR, TV/VCR combination or video selector, the playback picture may be distorted as DVD video discs are copy protected.

Connecting to an audio system and TV equipped with ColorStream™ (Component video) inputs

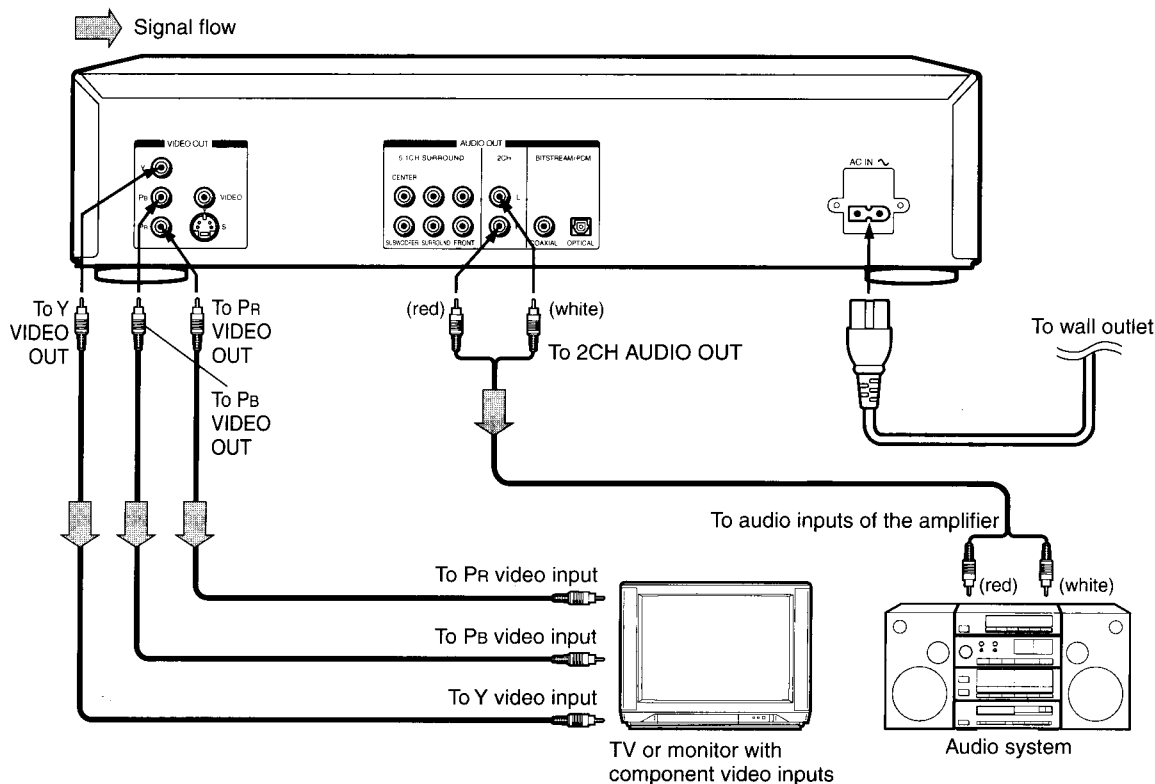

ColorStream™ (Component video) outputs/inputs

Some TVs or monitors are equipped with component video inputs. Connecting to these inputs allows you to enjoy higher quality picture playback.

Actual labels for component video inputs may vary depending on the TV manufacturer. (ex. Y, R-Y, B-Y or Y, Cb, Cr)

In some TVs or monitors, the color levels of the playback picture may be reduced slightly or the tint may change. In such a case, adjust the TV or monitor for optimum performance.

- Make the following setting.

| Setting | Select: | Page |
|--------------------|--------------|------------------------|
| "Audio Out Select" | "Analog 2ch" | 35 39 |

Notes

- Refer to the owner's manual of the connected equipment as well.
- When you connect the DVD video player to other equipment, be sure to turn off the power and unplug all of the equipment from the wall outlet before making any connections.
- If you place the DVD video player near a tuner or radio, the radio broadcast sound might be distorted. In this case, place the DVD video player away from the tuner and radio.
- The output sound of the DVD video player has a wide dynamic range. Be sure to adjust the receiver's volume to a moderate listening level. Otherwise, the speakers may be damaged by a sudden high volume sound.
- Turn off the amplifier before you connect or disconnect the DVD video player's power cord. If you leave the amplifier power on, the speakers may be damaged.

Connecting to Optional Equipment

You can enjoy high quality dynamic sounds by connecting the DVD video player to optional audio equipment.

For connection to your TV, see "Connecting to a TV" **16** **17**.
For details of output sound, see **33**.

| | | | |
|---|---------------|---|----------------|
|  | Front speaker |  | Center speaker |
|  | Rear speaker |  | Signal flow |
|  | Sub woofer | | |

Connecting to an amplifier equipped with a Dolby Digital decoder

Dolby Digital

Dolby Digital is the surround sound technology used in theaters showing the latest movies, and is now available to reproduce this realistic effect in the home. You can enjoy motion picture and live concert DVD video discs with this dynamic realistic sound by connecting the DVD video player to a 6 channel amplifier equipped with a Dolby Digital decoder or Dolby Digital processor. If you have a Dolby Pro Logic Surround decoder, you will obtain the full benefit of Pro Logic from the same DVD movies that provide full 5.1-channel Dolby Digital soundtracks, as well as from titles with the Dolby Surround mark.

Manufactured under license from Dolby Laboratories. "Dolby", "Pro Logic" and the double-D symbol are trademarks of Dolby Laboratories. Confidential unpublished works. ©1992-1997 Dolby Laboratories. All rights reserved.

- Use DVD video discs encoded via the Dolby Digital recording system.
- Make the following setting.

| Setting | Select: | Page |
|--------------------|---|-----------|
| "Audio Out Select" | "Bitstream" | 35 |
| | "Bitstream" | 39 |
| Recording system |  D | 33 |

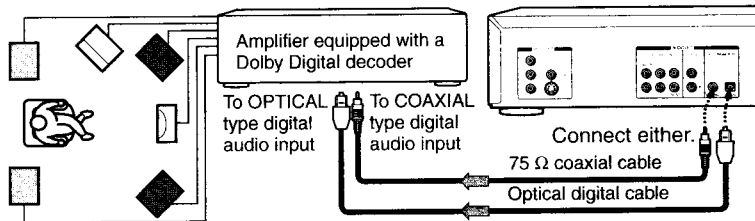

Connecting to an amplifier equipped with 5.1ch audio inputs

5.1ch surround sound

The Dolby Digital decoder equipped with this DVD video player enables you to obtain the full benefit of 5.1 channel Dolby Digital sound tracks when you connect the DVD video player to a Dolby Digital ready amplifier equipped with 5.1 channel audio inputs.

- Use DVD video discs encoded via the Dolby Digital recording system.
- Make the following setting.

| Setting | Select: | Page |
|--------------------|---|-----------|
| "Audio Out Select" | "Analog 6ch" | 35 |
| | "Analog 6ch" | 39 |
| Recording system |  D | 33 |

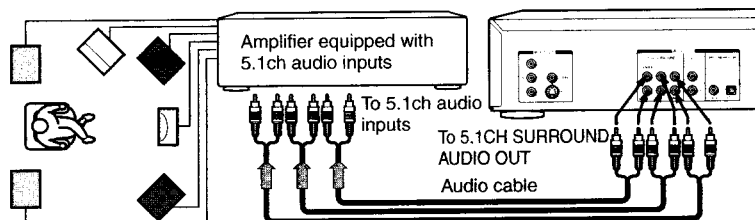

2 channel sound is output in the Dolby Pro Logic format. To obtain the original 2 channel sound, select "Analog 2ch."

Connecting to an amplifier equipped with Dolby Pro Logic Surround

Dolby Pro Logic Surround

You can enjoy the dynamic realistic sound of Dolby Pro Logic Surround by connecting an amplifier and speaker system (right and left front speakers, a center speaker, and one or two rear speakers).

- Make the following setting.

| Setting | Select: | Page |
|--------------------|--------------|-----------|
| "Audio Out Select" | "Analog 2ch" | 35 |
| | "Analog 2ch" | 39 |

Be sure to set "Audio Out Select" to "Analog 2ch" when you enjoy sounds of Dolby Pro Logic Surround using this connection.

- With an amplifier equipped with Dolby Digital
Connect the equipment the same way as described in "Connecting to an amplifier equipped with a Dolby Digital decoder." Refer to that amplifier's owner's manual and set the amplifier so you can enjoy Dolby Pro Logic Surround sound.
- With an amplifier not equipped with Dolby Digital
Connect the equipment as follows.

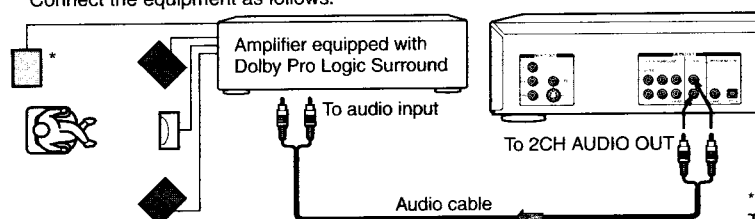

* Connect one or two rear speakers.
The output sound from the rear speakers will be monaural even if you connect two rear speakers.

Warning

- Do not set "Audio Out Select" to "Bitstream" from the on-screen displays **35** **39** unless you are connecting (via the BITSTREAM/PCM AUDIO OUT jack) an AV decoder that has the Dolby Digital, Digital Theater Systems (DTS) or MPEG2 decoding function. High volume sound may damage your hearing as well as the speakers.
- When playing DTS-encoded discs (DVD video discs and audio CDs), excessive noise may be output from the analog stereo jacks. To avoid possible damage to the audio system, you should take proper precautions when the 2CH AUDIO OUT jacks of the DVD video player are connected to an amplification system. To enjoy DTS Digital Surround™ playback, an external 5.1 channel DTS Digital Surround™ decoder system must be connected to the BITSTREAM/PCM AUDIO OUT jack of the DVD video player.

Connecting to an amplifier equipped with a DTS decoder

Digital Theater Systems (DTS)

DTS is a high quality surround technology used in theaters and now available for home use, on DVD video discs or audio CDs.

If you have a DTS decoder or processor, you can obtain the full benefit of 5.1 channel DTS encoded sound tracks on DVD video discs or audio CDs.

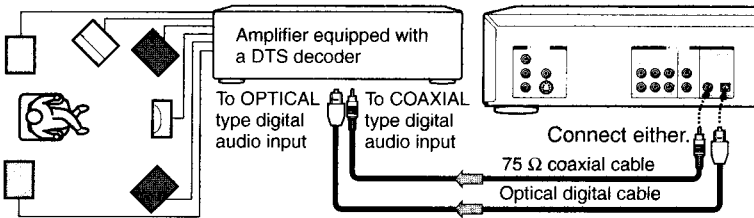

"DTS" and "DTS Digital Surround" are trademarks of Digital Theater Systems, Inc.

- Use DVD video discs or audio CDs encoded via the DTS recording system.
- Make the following setting.

| Setting | Select: | Page |
|--------------------|-------------|------------------------|
| "Audio Out Select" | "Bitstream" | 35 39 |
| Recording system | DTS | 33 |

Connecting to an amplifier equipped with an MPEG2 audio decoder

MPEG2 sound

You can enjoy motion picture and live concert DVD video discs with dynamic realistic sound by connecting an amplifier equipped with an MPEG2 audio decoder or MPEG2 audio processor.

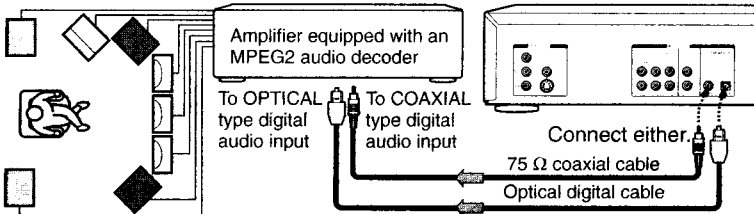

- Use DVD video discs encoded via the MPEG2 recording system.
- Make the following setting.

| Setting | Select: | Page |
|--------------------|-------------|------------------------|
| "Audio Out Select" | "Bitstream" | 35 39 |
| Recording system | MPEG | 33 |

Connecting to an amplifier equipped with a digital audio input

2 channel digital stereo

You can enjoy the dynamic sound of 2 channel digital stereo by connecting an amplifier equipped with a digital audio input and speaker system (right and left front speakers).

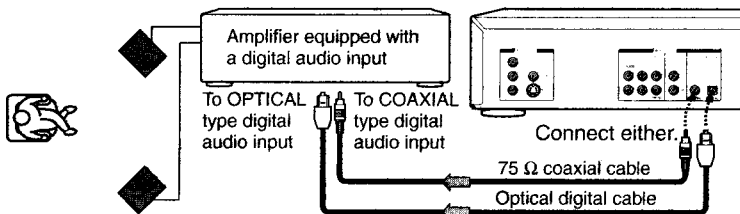

- Make the following setting.

| Setting | Select: | Page |
|--------------------|---------|------------------------|
| "Audio Out Select" | "PCM" | 35 39 |

Notes

- DO NOT connect the BITSTREAM/PCM AUDIO OUT jack of the DVD video player to the AC-3 RF input of a Dolby Digital Receiver. This input on your A/V Receiver is reserved for Laserdisc use only and is incompatible with the BITSTREAM/PCM AUDIO OUT jack of the DVD video player.
- Connect the BITSTREAM/PCM AUDIO OUT jack of the DVD video player to the "OPTICAL" or "COAXIAL" input of a Receiver or Processor.
- Refer to the owner's manual of the connected equipment as well.
- When you connect the DVD video player to other equipment, be sure to turn off the power and unplug all of the equipment from the wall outlet before making any connections.
- The output sound of the DVD video player has a wide dynamic range. Be sure to adjust the receiver's volume to a moderate listening level. Otherwise, the speakers may be damaged by a sudden high volume sound.
- Turn off the amplifier before you connect or disconnect the DVD video player's power cord. If you leave the amplifier power on, the speakers may be damaged.

Playing a Disc

This section shows you the basics on how to play a disc.

CAUTION

Keep your fingers well clear of the disc tray as it is closing. Neglecting to do so may cause serious personal injury.

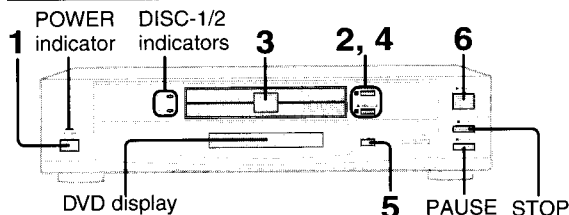

Basic playback

Preparations

- When you want to view a disc, turn on the TV and select the video input connected to the DVD video player.
- When you want to enjoy the sound of discs from the audio system, turn on the audio system and select the input connected to the DVD video player.

1 Press POWER.



The DVD video player turns on and the DVD VIDEO indicator on the player illuminates.

When the DVD video player is turned on for the first time, an initial set-up display appears. See "Initial set-up" and make the proper settings before proceeding to step 2.

2 Press OPEN/CLOSE (1/2).

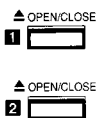

Press either button you want. The disc tray opens.

3 Place a disc on the disc tray.

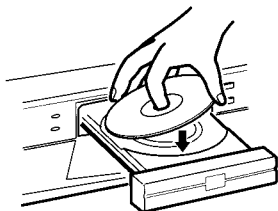

With the playback side down.

Do not place more than one disc.

- There are two different disc sizes. Place the disc in the correct guide on the disc tray. If the disc is out of the guide, it may damage the disc and cause the DVD video player to malfunction.
- Do not place anything except DVD video discs, VIDEO CDs or audio CDs on the disc tray.

4 Press OPEN/CLOSE (1/2) to close the disc tray.

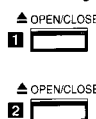

Press the button which you pressed in step 2. To set another disc, press the other button.

- Some discs may be automatically played after having been set. Even in the playback, you can select a disc to play in step 5.

5 Press DISC SELECT repeatedly to select the disc you want.



- DISC-1 (Red (lit): The disc is on standby or is being played.
- DISC-2 (Green (lit): Secondary standby. Off: Playback does not start.

6 Press PLAY.



Playback starts.

If you insert a DVD video disc that contains a title menu, a menu may appear. See "Locating a title using the top menu." **[24]**

- You may need to press the TOP MENU or MENU button to display disc menu (depending on the actual DVD video disc.)

Note

Even while playing a disc, you can set another disc. Press the OPEN/CLOSE (1/2) button for a disc which is not played.

Initial set-up

Make the following settings on the display.

On-Screen Language:

Select the appropriate on-screen language.

TV Shape: Select a picture size according to the aspect ratio of your TV. (See **[38]** for details.)

TOSHIBA
Thank you for your purchase of this TOSHIBA DVD Player.
Please make a selection for On-Screen Language and your TV shape and press ENTER button on your remote control.



- 1 Move the cursor control (▲ / ▼) to select "On-Screen Language," and press **ENTER**.
- 2 Select a language moving the cursor control (▲ / ▼), and press **ENTER**.
- 3 Move the cursor control (▼) to select "TV Shape," and press **ENTER**.
- 4 Select a picture size moving the cursor control (▲ / ▼), and press **ENTER**.
- 5 Finally press **SETUP**.

All your selections are entered and the display disappears.

To change your settings, see "Customizing the Function Settings." **[35]**

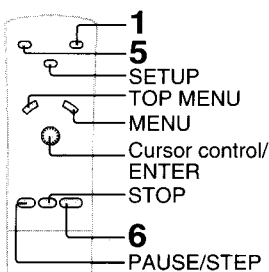

■ To obtain a higher quality picture

Occasionally, some picture noise not usually visible during a normal broadcast may appear on the TV screen while playing a DVD video disc because the high resolution pictures on these discs include a lot of information. While the amount of noise depends on the TV you use with this DVD video player, you should generally reduce the sharpness adjustment on your TV when viewing DVD video discs.

■ About

The icons on the heading bar show the playable discs for the function described under that heading.

: You can use this function with DVD video discs.

: You can use this function with VIDEO CDs.

: You can use this function with audio CDs.

■ To pause playback (still mode)

Press **PAUSE/STEP** during playback.



To resume normal playback, press the **PLAY** button.

- The sound is muted during still mode.

■ To stop playback

Press **STOP**.



■ To remove the disc

Press **OPEN/CLOSE (1/2)** for the disc you want to remove.

OPEN/CLOSE



Remove the disc after the disc tray opens completely.

OPEN/CLOSE

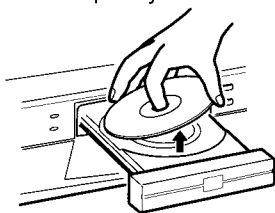

Be sure to press the **OPEN/CLOSE (1/2)** button to close the disc tray after you remove the disc.

■ About the screen saver

If you pause a picture of a DVD video disc and leave it still for a long while, the screen saver of the DVD video player automatically appears (when "Screen Saver" is set to "On"). To turn off the screen saver, press the **PLAY** button.

■ Automatic Power Off function

If the DVD video player is stopped, or the screen saver is engaged for about 20 minutes, the DVD video player will automatically turn itself off.

■ HDCD (High Definition Compatible Digital[®])

HDCD[®] (High Definition Compatible Digital[®]) is a recording system that has improved audio CD sound in dynamic range, sound field reproducibility and vocal acoustics.

This DVD video player is equipped with an HDCD decoder. The HDCD indicator illuminates when playing an HDCD-encoded audio CD.

HDCD[®], High Definition Compatible Digital[®] and Pacific Microsonics[™] are either registered trademarks or trademarks of Pacific Microsonics, Inc. in the United States and/or other countries. HDCD system manufactured under license from Pacific Microsonics, Inc. This product is covered by one or more of the following patents: United States: 5,479,168, 5,638,074, 5,640,161, 5,808,574, 5,838,274, 5,854,600, 5,872,531 and 5,864,311. Australia 669114. Other patents pending.

Notes

- Do not move the DVD video player during playback. Doing so may damage the disc.
- Use the **OPEN/CLOSE (1/2)** button to open and close the disc tray. Do not push the disc tray while it is moving. Doing so may cause the DVD video player to malfunction.
- Do not push up on the disc tray or put any objects other than discs on the disc tray. Doing so may cause the DVD video player to malfunction.
- In many instances, a menu screen will appear after playback of a movie is completed. Prolonged display of an on-screen menu may damage your television set, permanently etching that image onto its screen. To avoid this, be sure to press the **STOP** button on your remote control once the movie is completed.

Playing a Disc (continued)

You can play discs at various speeds, and resume playback from the location where you stopped playback.

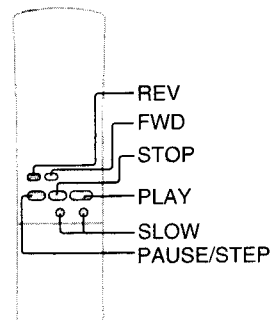

Playing fast in reverse or forward direction

Press REV or FWD during playback.

REV

FWD



REV : Fast reverse playback

FWD: Fast forward playback



Each time you press the REV or FWD button, the playback speed changes.

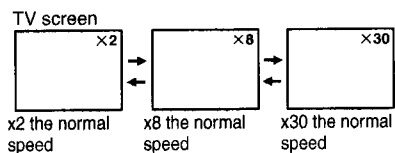

Each time you press the REV or FWD button, the two speeds alternate.

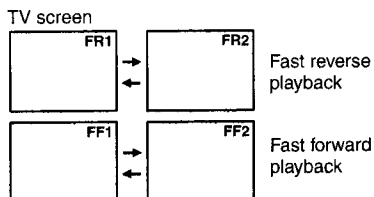

■ To resume normal playback

Press **PLAY**.

PLAY



Notes

- The DVD video player does not play sound and subtitles during reverse and forward scan of DVD video discs. However, the DVD video player plays sound during fast forward or fast reverse play of audio CDs.
- The playback speed may differ depending on the disc.



Playing frame by frame

Press PAUSE/STEP during still playback.

PAUSE/STEP



Each time you press the PAUSE/STEP button, the picture advances one frame.

■ To resume normal playback

Press **PLAY**.

PLAY





Note



The sound is muted during frame by frame playback.

DVD VCD **Playing in slow-motion**

Press SLOW during playback.

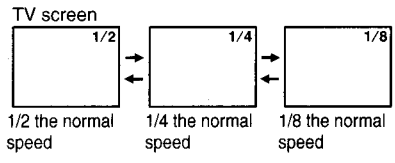
SLOW  Each time you press the SLOW  button, the slow-motion speed changes.



SLOW  If you press the SLOW  button during playback, you can view the picture in reverse slow-motion. (Only when using a DVD video disc.)

Each time you press the SLOW  button, the slow-motion speed changes.

To resume normal playback

Press **PLAY**.



Notes

- The sound is muted during slow-motion playback.
- The playback speed may differ depending on the disc.

DVD VCD CD **Resuming playback from the same location**

1 Press STOP at the location where you want to interrupt playback.



STOP  The DVD video player memorizes the location where playback is stopped.

2 Press PLAY.

PLAY  The DVD video player resumes playback from the location where you stopped playback.

2 Press PLAY.



-  Playback starts from the beginning of the current title.
-  Playback starts from the beginning of the disc.

- If you want to return to the beginning of a DVD video disc, open and close the disc tray once with the OPEN/CLOSE (1/2) button for the disc you want to play before pressing the PLAY button.

Notes

- The DVD video player's memory is also cleared when:
 - you unplug the DVD video player from the wall outlet after you stop playback.
 - you change the parental lock setting **[41]** or select a disc menu language **[37]**.
 - you open the disc tray for a disc which is played.
 - you switch the discs by pressing the DISC SELECT button.
- There may be a difference in the location where playback resumes depending on the disc.
- Settings you changed using the on-screen displays while the DVD video player keeps a location in the memory may function only after the memory is cleared.

To start playback from the beginning regardless of the location where you stopped playback

1 Press STOP twice.

STOP  The DVD video player's memory is cleared.

Locating a Specific Title, Chapter, or Track

Normally, DVD video discs are divided into titles, and the titles are sub-divided into chapters. VIDEO CDs and audio CDs are divided into tracks. You can quickly locate any specific title, chapter, or track.

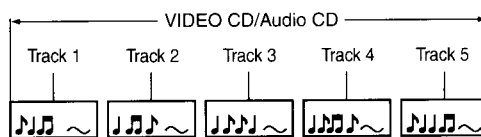
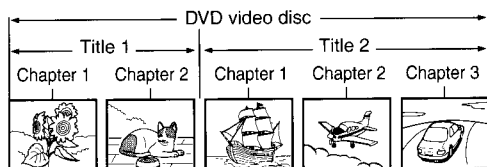

DVD Locating a title using the top menu

1 Press TOP MENU.



The top menu appears on the TV screen.

e.g.

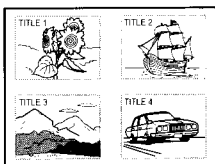

2 Select the title you want moving the cursor control (▲/▼/◀/▶).

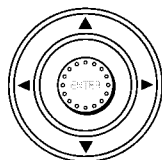

If the titles in the top menu are assigned a number, you can directly locate a specific title by pressing its designated number with the number buttons.

3 Press ENTER.



Playback starts from chapter 1 of the selected title.

Notes

- The instructions above describe basic procedures which may vary depending on the contents of the DVD video disc. If different instructions appear on the TV screen, follow those instructions.
- If you display the top menu during playback and press the TOP MENU button again without selecting any title, the DVD video player may resume playback from the point where you first pressed the TOP MENU button (depending on the actual DVD video disc.)
- This method of locating a title is available only on a disc that contains a top menu.
- Instruction notes of discs may refer to the button that displays the top menu as TITLE button.

DVD Locating a title by entering the title number

1 Press T.



Make sure that the space next to "Title" is highlighted. (You can shift the highlight moving the cursor control (▲/▼).)



2 Press the corresponding number buttons for the title you want.

e.g. To select title 2



To select title 12

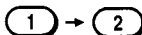

3 Press PLAY.



Playback starts from chapter 1 of the selected title.

Notes

- Pressing the CLEAR button resets the title and chapter numbers. To clear the "Title" and "Chapter" display, press the T button several times.
- This method of locating a title is available only on a disc that contains title numbers.

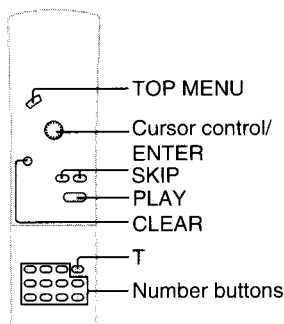

DVD VCD CD **Locating a specific chapter or track directly**

1 Press T.

Skip steps 1 and 2 if you are using a VIDEO CD/
 audio CD.



Title: **1**
 Chapter: 1

2 Move the cursor control (▼) to highlight the space next to "Chapter."

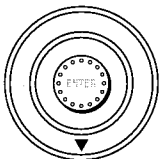

Title: 1
 Chapter: **1**

3 Press the corresponding number buttons for the chapter or track you want.

You can use the +10 button to select numbers from 10 through 99.

e.g. To select chapter or track 25

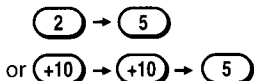

4 Press PLAY.



Playback starts from the selected
 chapter or track.

■ To select a title and chapter number at the same time

Move the cursor control (▲ / ▼) to highlight the space next to "Title", and enter the title number using the number buttons.

Note

Pressing the CLEAR button resets the title and chapter numbers. To clear the "Title" and "Chapter" display, press the T button several times.

Basic playback

DVD VCD CD **Locating a specific chapter or track**

Press SKIP ◀◀ or ▶▶ repeatedly to display the chapter or track number you want.

Playback starts from the selected chapter or track.

SKIP



To locate succeeding chapters or tracks

SKIP



Playback starts from the beginning of the current chapter or track.
 When you press twice, playback starts from the beginning of the preceding chapter or track.

Notes

- Some titles may not display chapter numbers.
- When you set "Title Stop" to "Off" (42), you can access chapters in another title. If you go back to the preceding title by pressing the SKIP ◀◀ button, the DVD video player locates the first chapter of the title. When "Title Stop" is set to "On," you can access chapters only within the current title.

Locating a Specific Location Directly

You can locate a specific location by entering its corresponding time (hours, minutes, seconds).

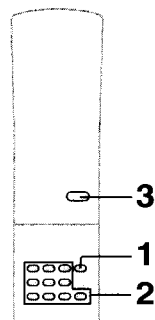

Entering the time of the desired location

1 Press T twice.



You may have to press further depending on the disc. Press the button repeatedly until the following display appears.



2 Press the number buttons to enter the time.

e.g.



Time 1:25:30

3 Press PLAY.

PLAY



Playback starts from the desired location.

Notes

- Some discs may not respond to this process.
- Some scenes may not be located precisely as you specified.
- This method for accessing specific locations is available only within the current title of the DVD video disc or within the current track of the VIDEO CD/audio CD.

Playing Repeatedly

You can play a specific title, chapter, track, or segment repeatedly.

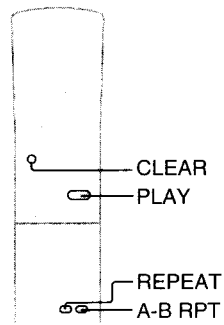
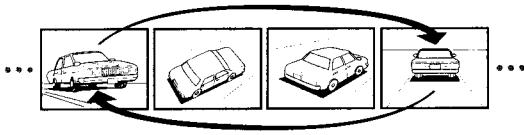

DVD VCD CD Repeating a title, chapter, or track

1 Press REPEAT.



Each time you press the REPEAT button, the repeat mode changes as follows.

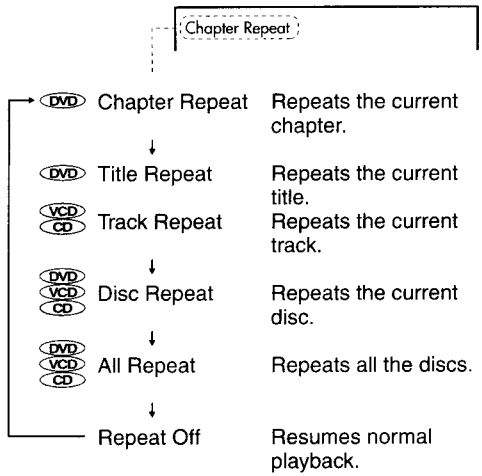

2 Press PLAY.



The DVD video player starts repeat playback. Press the PLAY button within about 5 seconds after you press the REPEAT button.

■ To resume normal playback

Press CLEAR.



Notes

- Some discs may not permit repeat operation.
- When using a DVD video disc, "All Repeat" may be canceled when the DVD video player switches the discs.

DVD VCD CD Repeating a specific segment

1 Press A-B RPT at the beginning of the segment (point A) you want to play repeatedly.

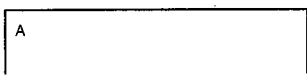

2 Press A-B RPT again at the end of the segment (point B).



The DVD video player automatically returns to point A and starts repeat playback of the selected segment (A-B).



■ To resume normal playback

Press CLEAR.



Notes

- Some discs may not permit A-B repeat operation.
- You cannot set the A-B repeat function for a segment that includes multiple camera angles [31].
- You can specify a segment only within the current title or track.
- There may be a slight difference between point A and the location where playback actually resumes depending on the disc.

Advanced playback

Playing in a Favorite Order

You can combine your favorite titles, chapters, or tracks and play them in the order you determine. You can program up to 28 selections into the memory. (Memory playback)

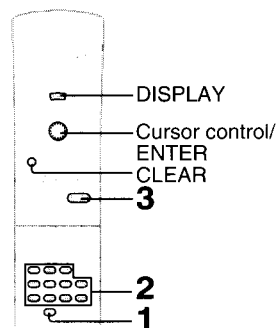
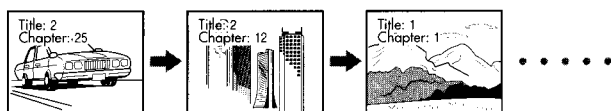

Setting titles, chapters, or tracks in a favorite order

1 Insert a disc and press MEMORY during stop.



The following display appears.

| MEMORY | | | |
|--------|----|----|-------|
| D | T | C | D T C |
| 1 | 8 | 15 | 22 |
| 2 | 9 | 16 | 23 |
| 3 | 10 | 17 | 24 |
| 4 | 11 | 18 | 25 |
| 5 | 12 | 19 | 26 |
| 6 | 13 | 20 | 27 |
| 7 | 14 | 21 | 28 |

D: Disc number
T: Title number or track number
C: Chapter number

2 Select the items in the order you want by pressing the number buttons, then ENTER for each item.

Each time you move the cursor control (◀/▶), the spaces of "D", "T" and "C" are highlighted in turn. Highlight where you want to enter, then press the corresponding number buttons.

To select tracks from a VIDEO CD/audio CD in order, press the **number buttons** for the track, then press the **ENTER** button for each selection you want.

To select another title, chapter or track in the same disc, you do not need to select the disc number.

To select another chapter in the same title, you do not need to select the title number.

3 Press PLAY while the MEMORY display appears on the TV screen.



The DVD video player starts memory playback.

■ To change the programmed selections

- 1 While the MEMORY display appears on the TV screen, move the cursor control (▲/▼) to highlight the item you want to change.
- 2 Change the selection following the instructions in step 2.

■ To cancel the programmed selections

- 1 While the MEMORY display appears on the TV screen, move the cursor control (▲/▼) to highlight the item you want to cancel.
- 2 Press **CLEAR**.

■ To resume normal playback from memory playback

Press **CLEAR**.



The memory playback indicator disappears.

■ To program during playback

If you press the **MEMORY** button during playback, a programming display appears.

If you further press the **DISPLAY** button, you can display the current MEMORY setting. Follow steps 2 and 3.

Notes

- Some discs may not permit memory playback operation.
- If you press the REPEAT button during memory playback, the DVD video player repeats the current memory playback.
- If you press the MEMORY or RETURN button while the MEMORY display appears on the TV screen, the MEMORY display disappears.
- The programmed selections will be cleared when you turn off the DVD video player.
- When using a DVD video disc, the memory playback may be canceled when the DVD video player switches the discs.

Playing in Random Order

You can play titles, chapters within a title, or tracks in random order.
(Random playback)

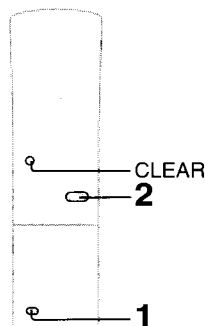
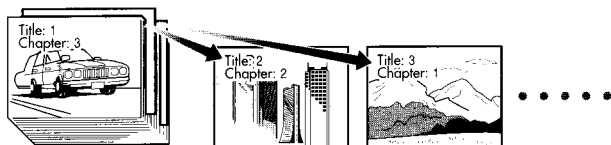

DVD VCD CD Playing titles, chapters or tracks in random order

1 Press RANDOM.

RANDOM



Each time you press the RANDOM button, the random playback mode changes as follows.

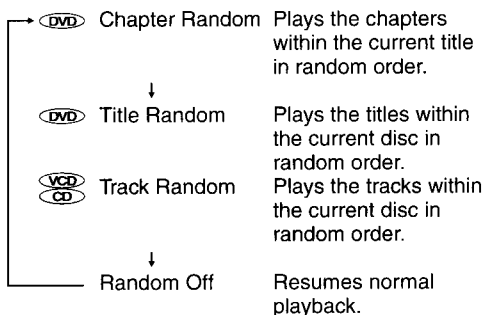

If you press the RANDOM button during playback, the DVD video player automatically starts random playback after finishing the current title, chapter or track.

■ To resume normal playback

Press CLEAR.

CLEAR



Notes

- Some discs may not permit random playback operation.
- You cannot use the random playback function in conjunction with the memory playback function.

2 Press PLAY.

PLAY



The DVD video player starts random playback.
Press the PLAY button within about 5 seconds after you press the RANDOM button.

Zooming a Picture

You can magnify areas within a picture.

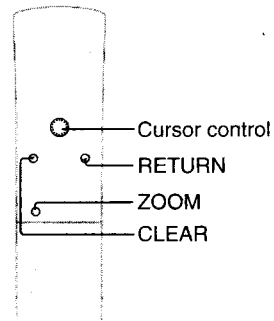
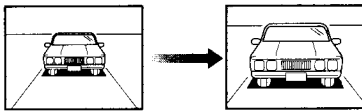

DVD Zooming a picture

Press **ZOOM** during normal, slow or still playback.

ZOOM



As you repeatedly press the ZOOM button, the magnification level increases.

RETURN



To reduce the magnification level, press the RETURN button.

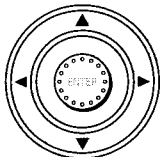

As you move the cursor control (▲/▼/◀/▶), the zoom point shifts. When the zoom point reaches an edge of the picture, the color of "Zoom" changes.

CLEAR



Pressing the CLEAR button restores the zoom point to the center of the picture.

■ To resume normal playback

Press **ZOOM** repeatedly so that "Zoom Off" appears.

ZOOM



Notes

- Some discs may not respond to zoom feature.
- During some scenes, the buttons may not work as described in the left column.
- Zooming does not work on subtitles or menus included on DVD video discs.
- During zoom playback, the cursor control (▲/▼/◀/▶) cannot work on menus included on the DVD video discs. If you want to view the menus, cancel the zoom playback.
- The magnification level varies depending on the picture size you select. **38**

Selecting 3-D (N-2-2) Sound Enhancement

You can enjoy expansive virtual surround sound effects from just two speakers.

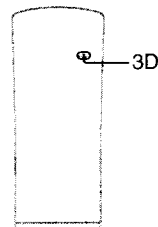

DVD VCD CD Selecting 3-D (N-2-2) sound enhancement

Press **3D** during playback.

3D



The current setting is displayed.

Each time you press the 3D button, the setting changes as follows.

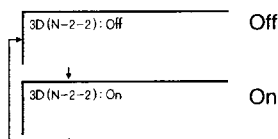

Notes

- You may sense a difference in volume between normal and 3-D (N-2-2) enhanced sound.
- 3-D (N-2-2) sound enhancement may not function (or may not be realized) depending on the sound output setting or disc recording system **33**.
- If 3-D (N-2-2) sound enhancement is on, Dolby Pro Logic Surround may not function on output sounds at all, or may function differently than usual.

Spatializer® 3-Dimensional Sound Processing provided by Desper Products, Inc.
 Certain audio features of this product manufactured under a license from Desper Products, Inc., Spatializer® and the circle-in-square device are trademarks owned by Desper Products, Inc.

Selecting the Camera Angle

If the scene was recorded from multiple angles, you can easily change the camera angle of the scene you are watching.

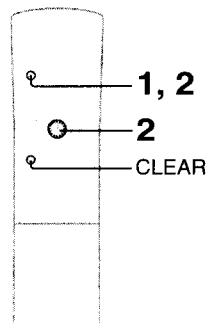
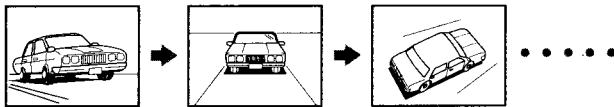

DVD Changing the camera angle

1 Press ANGLE while playing a scene recorded with multiple angles.



While playing a scene recorded with multiple angles, the angle icon (📷) appears in the DVD display and on the TV screen.

Press the ANGLE button while the angle icon is displayed.

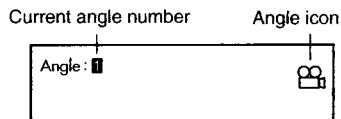

■ To turn off the angle number display

Press **CLEAR**.

CLEAR



■ To disable the angle icon display on the TV

From the on-screen displays, set "On-Screen Displays" to "Off." (41)

Monitor the DVD display when you want to change the camera angle.

Notes

- You can change the camera angle during still playback. The camera angle changes to the new setting when you resume normal playback.
- If you pause a picture immediately after changing a camera angle, the resumed playback picture may not display the new camera angle.

2 Press ANGLE or move the cursor control (▲) while the angle number is displayed on the TV screen.



Each time you press the ANGLE button or move the cursor control (▲), the camera angle changes.

e.g.

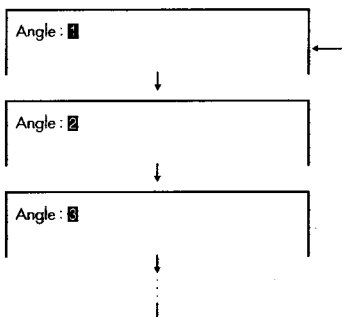
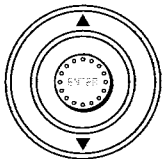

▼ : Cycles backwards

You can change the camera angle directly by pressing the number buttons corresponding to its angle number instead of moving the cursor control (▲ / ▼).

Selecting Subtitles

You can display subtitles on the TV screen and select a subtitle language from those included on the DVD video disc.

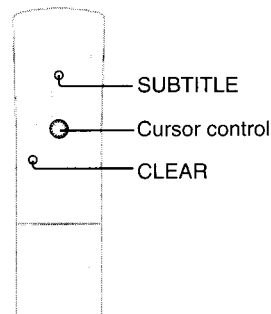
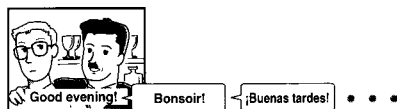

DVD Selecting a subtitle language

1 Press SUBTITLE during playback.

SUBTITLE



The current subtitle setting is displayed for about 3 seconds.

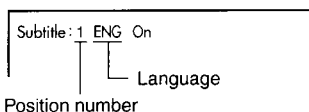

The abbreviation of the language appears instead of the language name. Refer to the list of languages and their abbreviations. [43](#)

2 Press SUBTITLE or move the cursor control (▲) while the subtitle setting is displayed on the TV screen.

SUBTITLE



Each time you press the SUBTITLE button or move the cursor control (▲), the subtitle languages included on the DVD video disc change.

e.g.

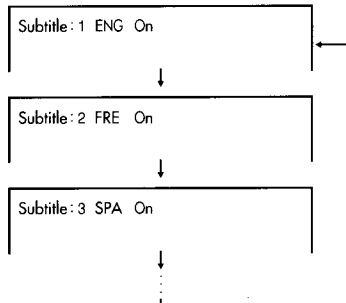
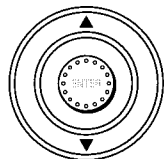

▼ : Cycles backwards

To turn off the subtitle setting display, press the CLEAR button.

■ To turn subtitles on or off

1 Press SUBTITLE during playback.

SUBTITLE



2 Move the cursor control (◀/▶) while the subtitle setting is displayed on the TV screen, to select "On" or "Off."

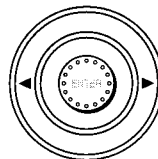

Displayed for about 3 seconds.

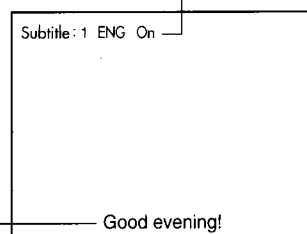

Subtitles Good evening!

Subtitles are not displayed.
Subtitle: 1 ENG Off

Notes

- Some DVD video discs are set to display subtitles automatically, and you cannot turn them off even if you set the subtitle function to off.
- During some scenes, the subtitles may not appear immediately after you select "On."
- Some DVD video discs will allow you to make subtitle selections and turn subtitles on or off only via the disc menu.

Notes

- When you turn on the DVD video player or replace a disc, the player returns to the initial default setting [37](#).
- When you select a subtitle language which is not included on the disc, the DVD video player plays a prior language programmed on the disc.
- During some scenes, the subtitles may not appear immediately after you change the subtitle language by moving the cursor control (▲/▼).

Selecting a Language

You can select a preferred language and sound recording system from those included on the DVD video disc.

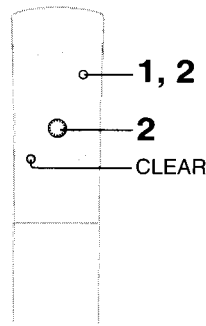
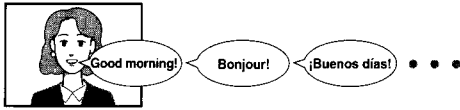

DVD Selecting a playback audio setting

1 Press AUDIO during playback.



The current audio setting is displayed for about 3 seconds.

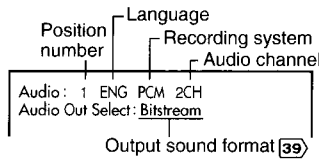

The abbreviation of the language appears instead of the language name. Refer to the list of languages and their abbreviations. [43]

2 Press AUDIO or move the cursor control (▲) while the audio setting is displayed on the TV screen.



Each time you press the AUDIO button or move the cursor control (▲), the audio settings included on the DVD video disc change.

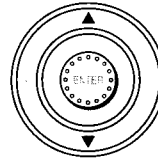

e.g. Audio: 1 ENG PCM 2CH
Audio: 2 FRE D 2CH
Audio: 3 SPA PCM 2CH

▼ : Cycles backwards

If you move the cursor control (◀/▶), you can select output sound format. [39]

To turn off the audio setting display, press the CLEAR button.

■ Selecting sound channels of VIDEO CDs

You can switch left and right channels by pressing the **AUDIO** button repeatedly during playback.

Notes

- When you turn on the DVD video player or replace a disc, player returns to the initial default setting [37]. When you select a sound track which is not included on the disc, the DVD video player plays a prior sound track programmed on the disc.
- Some discs allow you to change audio selections only via the disc menu. If this is the case, press the MENU button and choose the appropriate language from the selections on the disc menu.

■ Output sound conversion table (sampling frequency/quantization bit)

| Discs | Sound recording system | Audio selection from the menu [35] [39] and output jacks on the rear panel | | | | | | | |
|-----------------|------------------------|--|---------------------|--------------------|--------------------------------|--------------------|---------------------|--------------------|---------------------|
| | | "Bitstream" | | "Analog 6ch" | | "Analog 2ch" | | "PCM" | |
| | | BITSTREAM/PCM jack | 2CH AUDIO OUT jacks | BITSTREAM/PCM jack | 5.1CH SURROUND AUDIO OUT jacks | BITSTREAM/PCM jack | 2CH AUDIO OUT jacks | BITSTREAM/PCM jack | 2CH AUDIO OUT jacks |
| DVD video discs | Dolby Digital | Bitstream | 48 kHz/20 bit | — | 48 kHz/16 bit | Bitstream | 48 kHz/20 bit | 48 kHz/16 bit | 48 kHz/20 bit |
| | Linear PCM | 48 kHz/16 bit | 48 kHz/16 bit | 48 kHz/16 bit | — | 48 kHz/16 bit | 48 kHz/16 bit | 48 kHz/16 bit | 48 kHz/16 bit |
| | | 48 kHz/20 bit | 48 kHz/16 bit | 48 kHz/20 bit | — | 48 kHz/20 bit | 48 kHz/20 bit | 48 kHz/16 bit | 48 kHz/20 bit |
| | | 48 kHz/24 bit | 48 kHz/16 bit | 48 kHz/20 bit | — | 48 kHz/20 bit | — | 48 kHz/24 bit | 48 kHz/16 bit |
| | | 96 kHz/16 bit | 48 kHz/16 bit | 48 kHz/16 bit | — | 96 kHz/16 bit | — | 96 kHz/16 bit | 48 kHz/16 bit |
| | | 96 kHz/20 bit | 48 kHz/16 bit | 48 kHz/20 bit | — | 96 kHz/20 bit | — | 96 kHz/20 bit | 48 kHz/16 bit |
| | 96 kHz/24 bit | 48 kHz/16 bit | 48 kHz/20 bit | — | 96 kHz/20 bit | — | 96 kHz/24 bit | 48 kHz/16 bit | |
| | DTS | Bitstream | — | Bitstream | — | Bitstream | — | — | |
| | MPEG2 | Bitstream (7.1ch) | — | — | 48 kHz/16 bit | Bitstream (2ch) | 48 kHz/16 bit | 48 kHz/16 bit | |
| VIDEO CDs | MPEG1 | 44.1 kHz/16 bit | 44.1 kHz/16 bit | — | 44.1 kHz/16 bit | 44.1 kHz/16 bit | 44.1 kHz/16 bit | 44.1 kHz/16 bit | |
| Audio CDs | Linear PCM | 44.1 kHz/16 bit | 44.1 kHz/16 bit | 44.1 kHz/16 bit | 44.1 kHz/16 bit | 44.1 kHz/16 bit | 44.1 kHz/16 bit | 44.1 kHz/16 bit | |
| | HDCD | 44.1 kHz/16 bit | 44.1 kHz/20 bit | 44.1 kHz/16 bit | 44.1 kHz/16 bit | 44.1 kHz/16 bit | 44.1 kHz/20 bit | 44.1 kHz/16 bit | |
| | DTS | Bitstream | (Noise) | Bitstream | (Noise) | Bitstream | (Noise) | Bitstream | |

□ : 3-D (N-2.2) sound enhancement can function.

- HDCD sound via the 2CH AUDIO OUT jacks and the 5.1CH SURROUND AUDIO OUT jacks is output in a normal audio CD format when 3-D (N-2.2) sound enhancement is on or when "Analog 6ch" is selected.

Advanced playback

Viewing the Operational Information and DVD/CD-Text

You can view information about a disc and its operational status on the TV screen.

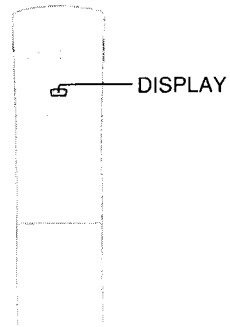

DVD VCD CD Checking the operational status

Press DISPLAY during stop.

DISPLAY



Each time you press the DISPLAY button, the on-screen display changes as follows.

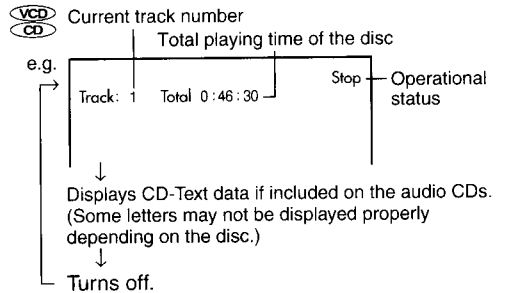
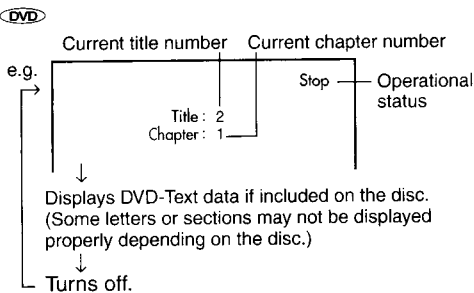

DVD VCD CD Checking the remaining time and setting status

Press DISPLAY during playback.

DISPLAY



Each time you press the DISPLAY button, the on-screen display changes as follows.

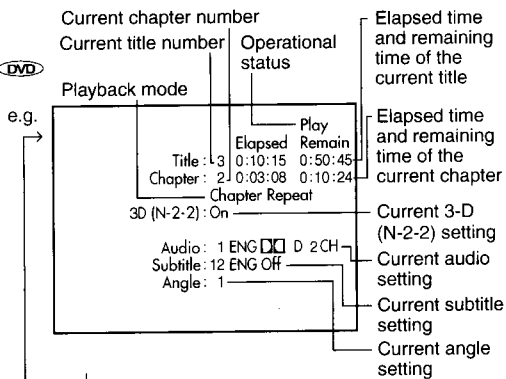

Data transfer rate (Mbit/s)
= Amount of picture, sound and subtitle data in the DVD video disc transferred per second.
The larger the value is, the more data processed, but this does not necessarily insure better picture quality.

Displays DVD-Text data if included on the disc. (Some letters or sections may not be displayed properly depending on the disc.)

Turns off.

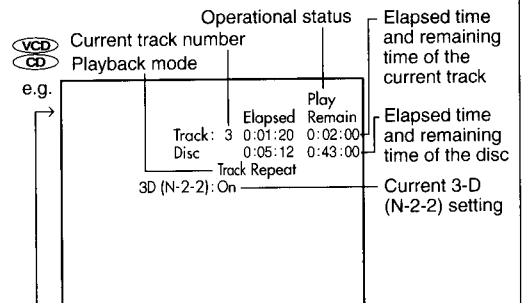

Displays CD-Text data if included on the audio CDs. (Some letters may not be displayed properly depending on the disc.)

Turns off.

Customizing the Function Settings

You can change the default settings to customize performance to your preference.

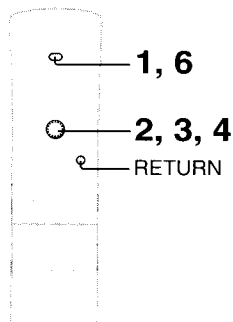

Setting procedure

1 Press **SETUP** during stop.
The following on-screen display appears.

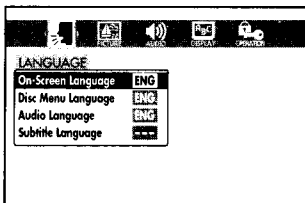

2 Move the cursor control (◀/▶) to select a symbol for the setting you want to change.

(See the next page.)

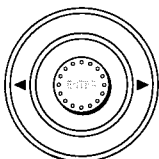

Language settings



Picture performance settings



Output sound settings



Display settings



Operational settings

3 Move the cursor control (▲/▼) to select the setting you want to change, then press **ENTER**.

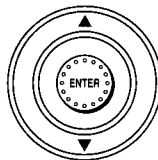

4 Change the selection by the cursor control (▲/▼) or other buttons, referring to the pages from 37, then press **ENTER**.

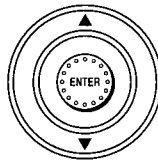

5 Repeat steps 3 and 4 to change other settings.

To select another symbol, go back to step 2.

6 Press **SETUP**.



The on-screen display disappears.

■ To return to the previous display



































Press **RETURN**.

RETURN



Notes

- The on-screen display disappears when you press the SETUP button.
- The SETUP button can function even during normal playback, however some operations may be inaccessible, and a message will appear. In this case, try again after playback is stopped.

| | Setting | Details | Page |
|--|-----------------------|---|---|
|  | On-Screen Language |    | To select a preferred language for on-screen displays. 37 |
| | Disc Menu Language |  | To select a preferred language for disc menus. 37 |
| | Audio Language |  | To select a preferred language for the sound track. 37 |
| | Subtitle Language |  | To select a preferred language for subtitles. 37 |
|  | TV Shape |  | To select a picture size according to the aspect ratio of your TV. 38 |
| | Black Level |   | To select the black level of playback pictures. 38 |
|  | Audio Out Select |    | To select an output sound format corresponding to your system connection. 39 |
| | Dynamic Range Control |  | To turn on or off a function that makes faint sounds easier to hear even if you lower the volume during late hours playback. 40 |
| | Karaoke Vocal |  | To turn on or off the vocal output during DVD KARAOKE disc playback. 40 |
| | CD Attenuation |  | To attenuate sound distortion during playback of an audio CD. 40 |
|  | On-Screen Displays |    | To turn on or off the operational status display on the TV screen. 41 |
| | OSD Background Color |    | To select the background color for on-screen displays. 41 |
| | Screen Saver |  | To turn on or off the screen saver. 41 |
|  | Pause/Still |  | To select the resolution of still pictures. (Field/Frame) 41 |
| | Parental Lock |  | To turn on or off the parental lock function. 41 |
| | Remote Confirmation |    | To turn on or off the confirmation beeper for each remote command received. 42 |
| | Title Stop |  | To turn on or off a feature that automatically stops playback after a title has been viewed. 42 |
| | PBC |  | To use the menu screen when playing a PBC-controllable VIDEO CD. 42 |

Setting details

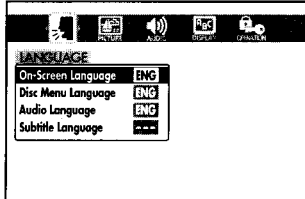

On-Screen Language (DVD VCD CD)

English: To view on-screen displays in English.
 French: To view on-screen displays in French.
 Spanish: To view on-screen displays in Spanish.

Disc Menu Language (DVD)

English: To display disc menus in English.
 French: To display disc menus in French.
 Spanish: To display disc menus in Spanish.
 Others: To make a further choice.
 After pressing the ENTER button, follow steps 1) - 4) below.

- 1) Obtain the abbreviation of the preferred language from the list **43**.
- 2) Select the first character by moving the cursor control (▲ / ▼).
- 3) Move the cursor control (◀ / ▶) to shift and select the second character by moving the cursor control (▲ / ▼).

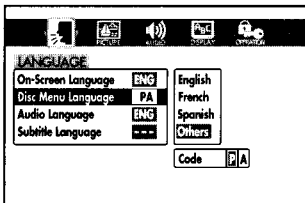

- 4) Press the ENTER button.

Note

Some DVD video discs may not include your pre-selected language. In this case, the DVD video player automatically displays disc menus consistent with the disc's initial language setting.

Audio Language (DVD)

English: To play sound tracks in English.
 French: To play sound tracks in French.
 Spanish: To play sound tracks in Spanish.
 Others: To make a further choice.
 After pressing the ENTER button, follow steps 1) - 4) below.

- 1) Obtain the abbreviation of the preferred language from the list **43**.
- 2) Select the first character by moving the cursor control (▲ / ▼).
- 3) Move the cursor control (◀ / ▶) to shift and select the second character by moving the cursor control (▲ / ▼).

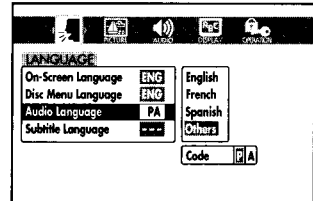

- 4) Press the ENTER button.

Note

Some DVD video discs may be played in a different language than you selected. A prior language may be programmed on the disc.

Subtitle Language (DVD)

English: To display subtitles in English.
 French: To display subtitles in French.
 Spanish: To display subtitles in Spanish.
 No Subtitle: To disable subtitles.
 Others: To make a further choice.
 After pressing the ENTER button, follow steps 1) - 4) below.

- 1) Obtain the abbreviation of the preferred language from the list **43**.
- 2) Select the first character by moving the cursor control (▲ / ▼).

(Continued)

Customizing the Function Settings (continued)

Setting details

(Continued)

- 3) Move the cursor control (◀/▶) to shift and select the second character by moving the cursor control (▲/▼).

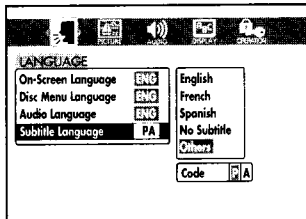

- 4) Press the ENTER button.

Notes

- Some DVD video discs may be set to display subtitles in a different language than you selected. A prior subtitle language may be programmed on the disc.
- Some DVD video discs allow you to change subtitle selections only via the disc menu. If this is the case, press the MENU button and choose the appropriate subtitle language from the selection on the disc menu.



TV Shape (DVD)

4:3 LetterBox:



Select when a standard 4:3 TV is connected. Displays theatrical images with masking bars above and below the picture.

4:3 Normal:



Select when a standard 4:3 TV is connected. Displays pictures cropped to fill your TV screen. Either or both sides of the picture are cut off.

16:9 Widescreen: Select when a 16:9 wide TV is connected.

Notes

- The displayable picture size is preset on the DVD video disc. Therefore, the playback picture of some DVD video discs may not conform to the picture size you select.
- When you play DVD video discs recorded in the 4:3 picture size only, the playback picture always appears in the 4:3 picture size regardless of the TV shape setting.
- If you select "16:9 Widescreen" and you own a 4:3 TV set, the DVD playback picture will be horizontally distorted during playback. Images will appear to be horizontally compressed. Always be sure that your TV shape conforms to the actual TV in use.

Black Level (DVD VCD)

Set to your preference and monitor's ability.

Enhanced: Expanded black level. (0 IRE)

Normal: Standard black level. (7.5 IRE)

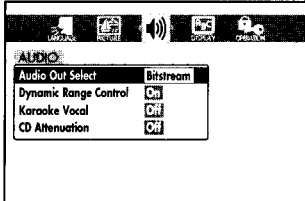

Audio Out Select DVD VCD CD

Select the output sound format corresponding to your system connection.

For details of sound recording systems, see 33.

Bitstream: Select when connected to an amplifier equipped with a Dolby Digital, DTS, MPEG1 or MPEG2 decoder. 18 19
The DVD video player outputs digital audio information in the bitstream format when you play a DVD video disc recorded on the Dolby Digital, DTS, MPEG1 or MPEG2 recording system.

Analog 6ch: Select when connected to a Dolby Digital ready amplifier equipped with 5.1ch audio inputs. 18
This DVD video player is equipped with a Dolby Digital decoder.
The next screen will appear for the detailed setting.

Analog 2ch: Select when connected to a TV, or Dolby Pro Logic or stereo system via the analog audio jacks. 16 18

PCM: Select when connected to a 2 channel digital stereo amplifier. 19
The DVD video player outputs sounds in the PCM 2ch format when you play a DVD video disc recorded on the Dolby Digital, MPEG1 or MPEG2 recording system.

When you select "Analog 6Ch":

Make the following settings for the built-in 5.1ch surround decoder.

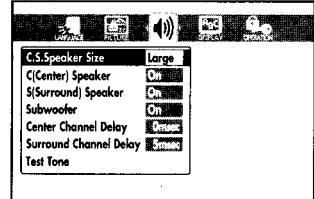

- 1) Select an item by moving the cursor control (▲/▼), and press the ENTER button.
- 2) Make the settings (see below) by moving the cursor control (▲/▼/◀/▶), and press the ENTER button.

C.S. Speaker Size

Small: When the center speakers or surround speakers cannot reproduce low frequency signals below 120 Hz.

Large: When the center speakers and surround speakers can reproduce low frequency signals below 120 Hz.

C(Center) Speaker

Off: When center speakers are not connected.

On: When you connect center speakers.

S(Surround) Speaker

Off: When surround speakers are not connected.

On: When you connect surround speakers.

Subwoofer

Off: When a sub woofer is not connected.

On: When you connect a sub woofer.

(Continued)

Customizing the Function Settings (continued)

Setting details

(Continued)

Adjusting the delay time:

When enjoying 5.1ch surround playback, it is ideal to choose a listening position that is the same distance from each speaker. By adjusting the delay time of the center/surround speakers, you can virtually create an ideal listening environment (as if the center/surround speakers were at their ideal locations respectively as below.)

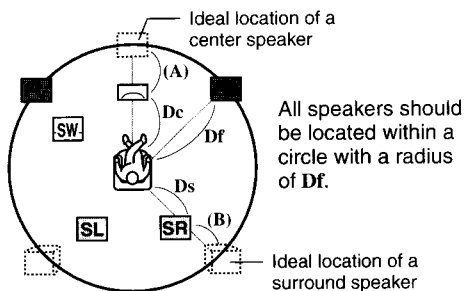

Center Channel Delay

0msec: When D_f equals D_c .

1msec: When (A) is approx. 34 cm (13 inch)

2msec: When (A) is approx. 68 cm (27 inch)

3msec: When (A) is approx. 102 cm (40 inch) . . .

$$*(A) = D_f - D_c$$

Get your optimum value (0, 1, 2 . . . 5) dividing (A) by 34.

Surround Channel Delay

0msec: When D_f equals D_s .

1msec: When (B) is approx. 34 cm (13 inch)

2msec: When (B) is approx. 68 cm (27 inch)

3msec: When (B) is approx. 102 cm (40 inch) . . .

$$*(B) = D_f - D_s$$

Get your optimum value (0, 1, 2 . . . 15) dividing (B) by 34.

- 3) Select "Test Tone" and press the ENTER button.

The DVD video player outputs a test signal to each speaker when it is in stop mode. When playing a DVD video disc, it substitutes the current sound for the test signal.

Move the cursor control (◀/▶) to switch the receiving speakers, and adjust the volume of each speaker at the same level by moving the cursor control (▲/▼).

If all the volume levels cannot be equalized, adjust them on the amplifier.

Note

Depending on the disc, 6 channel sounds may not be output via the 5.1 CH SURROUND AUDIO OUT jacks.

Dynamic Range Control

Off: Full dynamic range is maintained.

On: Dynamic range is reduced.

Notes

- This function works only during playback of Dolby Digital recorded discs.
- The level of Dynamic Range Reduction may differ depending on the DVD video disc.

Karaoke Vocal

Off: The primary vocal is not output.

On: The primary vocal is output when it is recorded on the disc.

Notes

- The vocal output feature is used during playback of Dolby Digital (multi-channel) recorded DVD KARAOKE discs. This feature allows you to turn off vocal audio tracks, or restore them for background accompaniment.
- When playing KARAOKE, connect appropriate audio equipment such as an amplifier to the DVD video player.

CD Attenuation

HDCD enhances the output sound level of audio CD by approximately 6 dB. As such, distortion may occur in some connected products that are unable to compensate for a wide range of input signal levels. (e.g. TV, stereo receivers)

Off: For normal use.

On: Select when an audio CD sound is distorted. Sound volume of an audio CD is lessened.

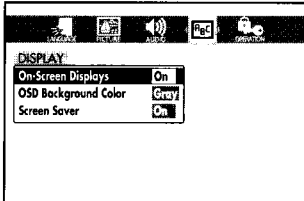

On-Screen Displays (DVD VCD CD)

Off: Operational modes (e.g. "Play", "⏸") are not displayed.

On: Operational modes (e.g. "Play", "⏸") are displayed on-screen.

OSD Background Color (DVD VCD CD)

Blue: Blue background.

Gray: Gray background.

Screen Saver (DVD)

Off: The screen saver does not work.

On: The screen saver works.

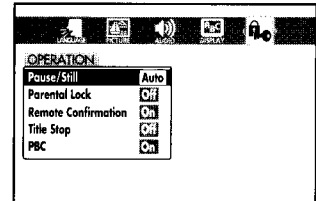

Pause/Still (DVD)

Auto: For normal use. Still and fast motion images can be paused.

Frame: The resolution of still pictures is improved, so that you can make a motionless picture more clearer when you pause it.

Parental Lock (DVD)

DVD video discs equipped with the parental lock function are rated according to their content. The contents allowed by a parental lock level and the way a DVD video disc can be controlled may vary from disc to disc. For example, if the disc allowed you could edit out violent scenes unsuitable for children and replace them with more suitable scenes, or lock out playback of the disc altogether.

- DVD video discs may or may not respond to the parental lock settings. This is not a defect in the DVD video player. Make sure this function works with your DVD video discs.

Off: The parental lock feature does not function. After pressing the ENTER button, follow step 1) below.

On: To activate the parental lock feature or change the settings.

After pressing the ENTER button, follow steps 1) - 3) below.

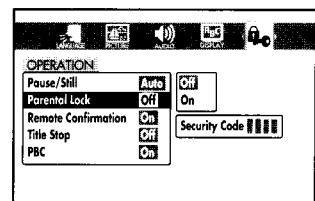

(Continued)

Customizing the Function Settings (continued)

Setting details

(Continued)

- 1) Press the number buttons to create a personal 4-digit security code, then press the ENTER button.

If you make a mistake before pressing the ENTER button, press the CLEAR button and enter your 4-digit security code again.

- 2) Move the cursor control (◀/▶) to select the country whose standards were used to rate the DVD video disc.

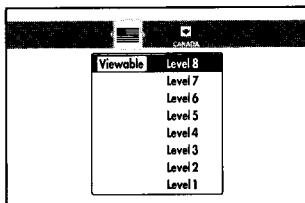

- 3) Move the cursor control (▲/▼) to select the parental lock level, then press the ENTER button.

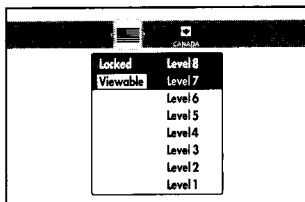

You cannot play DVD video discs rated higher than the level you selected unless you cancel the parental lock function.

For example, when you select level 7, discs rated higher than level 7 are locked out and cannot be played.

The parental lock level is equivalent to the following USA movie ratings.

- Level 7: NC-17
- Level 6: R
- Level 4: PG 13
- Level 3: PG
- Level 1: G

The parental lock levels for "CANADA" are included for future use. Check the appropriate parental lock level when you buy a DVD video disc equipped with the parental lock feature in the future.

■ To change the parental lock level

Follow steps 1) - 3).

■ To change your 4-digit security code

- 1) After selecting "On" or "Off," press the STOP button four times, then press the ENTER button.

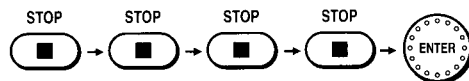

The 4-digit security code is cleared.

- 2) Press the number buttons to create a new 4-digit security code.
- 3) Press the ENTER button.

Remote Confirmation

Off: The beeper does not sound.

On: The beeper sounds with each remote operation.

Title Stop

Off: The DVD video player continues after playback of a title is completed.

On: The DVD video player stops after playback of a title is completed.

PBC

Off: When playing a VIDEO CD without using the menu.

On: To use the menu when playing a PBC-featured VIDEO CD.

Table of Languages

Table of languages and their abbreviations

| Abbreviation | Language | Abbreviation | Language | Abbreviation | Language |
|--------------|-----------------------|--------------|------------------|--------------|----------------|
| --- | No alternate language | GN | Guarani | PT | Portuguese |
| CHI (ZH) | Chinese | GU | Gujarati | QU | Quechua |
| DUT (NL) | Dutch | HA | Hausa | RM | Rhaeto-Romance |
| ENG (EN) | English | HI | Hindi | RN | Kirundi |
| FRE (FR) | French | HR | Croatian | RO | Rumanian |
| GER (DE) | German | HU | Hungarian | RU | Russian |
| ITA (IT) | Italian | HY | Armenian | RW | Kinyarwanda |
| JPN (JA) | Japanese | IA | Interlingua | SA | Sanskrit |
| KOR (KO) | Korean | IE | Interlingue | SD | Sindhi |
| MAY (MS) | Malay | IK | Inupiak | SG | Sango |
| SPA (ES) | Spanish | IN | Indonesian | SH | Serbo-Croatian |
| AA | Afar | IS | Icelandic | SI | Singhalese |
| AB | Abkhazian | IW | Hebrew | SK | Slovak |
| AF | Afrikaans | JI | Yiddish | SL | Slovenian |
| AM | Amharic | JW | Javanese | SM | Samoan |
| AR | Arabic | KA | Georgian | SN | Shona |
| AS | Assamese | KK | Kazakh | SO | Somali |
| AY | Aymara | KL | Greenlandic | SQ | Albanian |
| AZ | Azerbaijani | KM | Cambodian | SR | Serbian |
| BA | Bashkir | KN | Kannada | SS | Siswati |
| BE | Belorussian | KS | Kashmiri | ST | Sesotho |
| BG | Bulgarian | KU | Kurdish | SU | Sundanese |
| BH | Bihari | KY | Kirghiz | SV | Swedish |
| BI | Bislama | LA | Latin | SW | Swahili |
| BN | Bengali, Bangla | LN | Lingala | TA | Tamil |
| BO | Tibetan | LO | Laotian | TE | Telugu |
| BR | Breton | LT | Lithuanian | TG | Tajik |
| CA | Catalan | LV | Latvian, Lettish | TH | Thai |
| CO | Corsican | MG | Malagasy | TI | Tigrinya |
| CS | Czech | MI | Maori | TK | Turkmen |
| CY | Welsh | MK | Macedonian | TL | Tagalog |
| DA | Danish | ML | Malayalam | TN | Setswana |
| DZ | Bhutani | MN | Mongolian | TO | Tongan |
| EL | Greek | MO | Moldavian | TR | Turkish |
| EO | Esperanto | MR | Marathi | TS | Tsonga |
| ET | Estonian | MT | Maltese | TT | Tatar |
| EU | Basque | MY | Burmese | TW | Twi |
| FA | Persian | NA | Nauru | UK | Ukrainian |
| FI | Finnish | NE | Nepali | UR | Urdu |
| FJ | Fiji | NO | Norwegian | UZ | Uzbek |
| FO | Faroese | OC | Occitan | VI | Vietnamese |
| FY | Frisian | OM | (Afan) Oromo | VO | Volapük |
| GA | Irish | OR | Oriya | WO | Wolof |
| GD | Scottish Gaelic | PA | Panjabi | XH | Xhosa |
| GL | Galician | PL | Polish | YO | Yoruba |
| | | PS | Pashto, Pushto | ZU | Zulu |

 Others

Before Calling Service Personnel

Check the following guide for the possible cause of a problem before contacting service.

Symptoms and correction

| Symptom | Cause | Correction | Page |
|--|---|--|------------------|
| No power. | <ul style="list-style-type: none"> The power plug is disconnected. | <ul style="list-style-type: none"> Connect the power plug securely into the wall outlet. | 16 |
| The DVD video player turned off by itself. | <ul style="list-style-type: none"> The automatic power off function turned the unit off. | <ul style="list-style-type: none"> Press the PLAY button. | 21 |
| No picture. | <ul style="list-style-type: none"> The TV is not set to receive DVD signal output. | <ul style="list-style-type: none"> Select the appropriate video input mode on the TV so the picture from the DVD video player appears on the TV screen. | 20 |
| | <ul style="list-style-type: none"> The video cable is not connected securely. | <ul style="list-style-type: none"> Connect the video cable securely into the appropriate jacks. | 16, 17 |
| No sound. | <ul style="list-style-type: none"> The equipment connected with the audio cable is not set to receive DVD signal output. | <ul style="list-style-type: none"> Select the correct input mode of the audio receiver so you can listen to the sound from the DVD video player. | 20 |
| | <ul style="list-style-type: none"> The audio cable is not connected securely. | <ul style="list-style-type: none"> Connect the audio cable securely into the appropriate jacks. | 16, 17 18, 19 |
| | <ul style="list-style-type: none"> The audio receiver or TV is turned off. | <ul style="list-style-type: none"> Turn on the equipment connected with the audio cable. | 20 |
| | <ul style="list-style-type: none"> The setting of output sound format is incorrect. | <ul style="list-style-type: none"> Select the proper audio setting. | 33, 35 39 |
| The playback picture has occasional distortion. | <ul style="list-style-type: none"> The disc is dirty. | <ul style="list-style-type: none"> Eject the disc and clean it. | 9 |
| | <ul style="list-style-type: none"> It is in fast forward or fast reverse playback. | <ul style="list-style-type: none"> Sometimes a small amount of picture distortion may appear. This is not a malfunction. | – |
| Brightness is unstable or noises are present in the playback pictures. | <ul style="list-style-type: none"> The effect of copy protection. | <ul style="list-style-type: none"> Connect the DVD video player directly to the TV. Avoid connecting the DVD video player to a VCR or TV/VCR combination. | 16 |
| The DVD video player does not start playback. | <ul style="list-style-type: none"> No disc is inserted. | <ul style="list-style-type: none"> Insert a disc. | 20 |
| | <ul style="list-style-type: none"> An unplayable disc is inserted. | <ul style="list-style-type: none"> Insert a playable disc. (Check the disc type and color system.) | 10 |
| | <ul style="list-style-type: none"> The disc is placed upside down. | <ul style="list-style-type: none"> Place the disc with the playback side down. | 20 |
| | <ul style="list-style-type: none"> The disc is not placed within the guide. | <ul style="list-style-type: none"> Place the disc correctly inside the guide on the disc tray. | 20 |
| | <ul style="list-style-type: none"> The disc is dirty. | <ul style="list-style-type: none"> Clean the disc. | 9 |
| | <ul style="list-style-type: none"> The parental lock function is set. | <ul style="list-style-type: none"> Cancel the parental lock function or change the parental lock level. | 35, 41 |
| Playback does not follow the course of the disc's program. | <ul style="list-style-type: none"> It is in the mode of repeat playback, memory playback, etc. | <ul style="list-style-type: none"> These operations may prevent a proper progress of the contents. | – |
| Buttons do not work. | <ul style="list-style-type: none"> Power supply fluctuations or other abnormalities such as static electricity may interrupt correct operations. | <ul style="list-style-type: none"> Turn the power on or off with the POWER button. Or disconnect the power plug and insert it into the wall outlet again. | – |
| The remote control does not work properly. | <ul style="list-style-type: none"> The remote control is not pointed at the remote sensor of the DVD video player. | <ul style="list-style-type: none"> Point the remote control at the remote sensor of the DVD video player. | 15 |
| | <ul style="list-style-type: none"> The remote control is too far from the DVD video player. | <ul style="list-style-type: none"> Operate the remote control within about 7 m. | 15 |
| | <ul style="list-style-type: none"> The batteries in the remote control are exhausted. | <ul style="list-style-type: none"> Replace the batteries with new ones. | 15 |

DVD video player / outputs / supplied accessories

DVD Video Player

| | |
|-----------------------|---|
| Power supply | 120 V AC, 60 Hz |
| Power consumption | 16 W |
| Mass | 3.5 kg |
| External dimensions | 430 × 102 × 313 mm (W/H/D) |
| Signal system | Standard NTSC |
| Laser | Semiconductor laser, wavelength 650 nm |
| Frequency range | DVD linear sound : 48 kHz sampling 4 Hz to 22 kHz 96 kHz sampling 4 Hz to 44 kHz |
| Signal-to-noise ratio | More than 112 dB |
| Audio dynamic range | More than 106 dB |
| Harmonic distortion | Less than 0.001 % |
| Wow and flutter | Below measurable level (less than ±0.001 % (W.PEAK)) |
| Operating conditions | Temperature: 5 °C to 35 °C, Operation status: Horizontal |

Outputs

| | |
|--------------------------------------|--|
| Video output | 1.0 V (p-p), 75 Ω, negative sync., pin jack × 1 |
| S video output | (Y) 1.0 V (p-p), 75 Ω, negative sync., Mini DIN 4-pin × 1 (C) 0.286 V (p-p), 75 Ω |
| Component video output | (Y) 1.0 V (p-p), 75 Ω, negative sync., pin jack × 1 (P _B)/(P _R) 0.7 V (p-p), 75 Ω, pin jack × 2 |
| Audio output (BITSTREAM/PCM OPTICAL) | Optical connector × 1 |
| Audio output (BITSTREAM/PCM COAXIAL) | 0.5 V (p-p), 75 Ω, pin jack × 1 |
| Audio output (2CH AUDIO) | 2.0 V (rms), 220 Ω, pin jacks (L, R) × 1 |
| Audio output (5.1CH SURROUND) | 2.0 V (rms), 220 Ω, pin jacks × 6 |

Supplied Accessories

| | |
|---------------------------------|---|
| Audio/video cable | 1 |
| Remote control (SE-R0031) | 1 |
| Batteries (AAA) | 2 |
| Power cord | 1 |

- Designs and specifications are subject to change without notice.

LIMITED WARRANTY DVD VIDEO PLAYER

Toshiba America Consumer Products, Inc. ("TACP"), Toshiba Hawaii ("THI") and Toshiba Canada Limited ("TCL") make the following limited warranties. These limited warranties extend to original purchaser or any person receiving this set as a gift from the original purchaser and to no other purchaser or transferee.

Limited Ninety (90) Day Warranty

TACP/THI warrant this product against defects in materials or workmanship for a period of ninety (90) days after the date of original retail purchase. During this period, TACP/THI will repair or replace a defective product or part, at their option, with a new or refurbished product or part without charge to you. You must deliver the entire product to a TACP/THI Authorized Service Station. You are responsible for all transportation and insurance charges for the unit to and from the Authorized Service Station. If you live in the U.S.A. you may, at your option, return your DVD Unit to:

Toshiba America Consumer Products Inc.
Returns Center
1420C Toshiba Dr.
Lebanon, TN 37087

Upon receipt we will, at our option, exchange the DVD Unit with a new or refurbished unit. **Canadian consumers are requested to contact TCL. In Hawaii consumers are requested to contact THI.**

Limited One (1) Year Warranty

TACP/THI further warrant the parts in this product against defects in materials or workmanship for a period of one (1) year after the date of original retail purchase. During this period, TACP/THI will repair or replace a defective product or part, at their option, with a new or refurbished product or part without charge to you, except that if a defective part is replaced after ninety (90) days from the date of the original retail purchase you pay labor charges involved in the replacement. You must also deliver the entire product to a TACP/THI Authorized Service Station. You are responsible for all transportation and insurance charges for the unit to and from the Authorized Service Station. If you live in the U.S.A. you may, at your option, return your DVD Unit to:

Toshiba America Consumer Products Inc.
Returns Center
1420C Toshiba Dr.
Lebanon, TN 37087

Upon receipt we will, at our option, exchange the DVD Unit with a new or refurbished unit. **Canadian Consumers are requested to contact TCL. In Hawaii consumers are requested to contact THI.**

Rental Units

The warranty for rental units begin with the first rental or thirty (30) days from the date of shipment to the rental firm, whichever comes first.

Commercial Units

Products sold and used for commercial use have a limited ninety (90) day warranty for all parts and labor.

Owner's Manual

You should read the owner's manual thoroughly before operating this product. You should complete and mail the enclosed Demographic card within ten (10) days after you, or the person who has given you this product as a gift, purchased this product. This is one way to enable TACP to provide you with better customer service and improved products. Failure to return the card will not affect your rights under this warranty.

Your Responsibility

The above warranties are subject to the following conditions:

- (1) You must retain your bill of sale or provide other proof of purchase.
- (2) You must notify a TACP/THI/TCL /Authorized Service Station within thirty (30) days after you discover a defective product or part.
- (3) All warranty servicing of this product must be made by a TACP/THI/TCL Authorized Service Station.
- (4) U.S.A. warranties are effective only if the product is purchased and operated in the Continental U.S.A. or Puerto Rico.
- (5) Labor service charges for set installation. Set up, adjustment of customer controls and installation or repair of antenna systems are not covered by this warranty. Reception problems caused by inadequate antenna systems are your responsibility.
- (6) Warranties extend only to defects in materials or workmanship as limited above and do not extend to any product or parts which have been lost or discarded by you or to damage to products or parts caused by misuse, accident, damage caused by Acts of God, such as lighting or fluctuations in electric power, improper installation, improper maintenance or use in violation of instructions furnished by us; or to units which have been altered or modified without authorization of TACP/THI/TCL or to damage to products or part thereof which have had the serial number removed, altered, defaced or rendered illegible.
- (7) Should you elect to return your DVD Unit to TACP after the ninety (90) days and within one (1) year, or after the warranty period has expired: Call (800)-631-3811 to receive information concerning an exchange price. Payment must be enclosed with product in the form of a certified check or money order including reason for return.
- (8) Physically damaged DVD Units are not acceptable for repair or exchange whether in or out of warranty and will be returned as received.

How to Obtain Warranty Service

- (1) Refer to the troubleshooting guide in your owner's manual. This check list may solve your problem.
- (2) In the U.S.A., only call the TACP toll free number 800-631-3811, or if in Hawaii or Canada see listing below within (30) days after you find a defective product or part.
- (3) Arrange for the delivery of the product to the TACP/THI/TCL Authorized Service Station or TACP Return Center. Products shipped to the Service Station must be insured and safely and securely packed, preferably in the original shipping carton, and a letter explaining the defect and also a copy of the bill of sale or other proof of purchase must be enclosed.

In the Continental United States contact:



In Hawaii contact:

Toshiba Hawaii Inc.
327 Kamakee Street
Honolulu, HA 96814
(808)-521-5377

In Canada contact:

Consumer Electronics Group
191 McNabb Street
Markham, Ontario L3R 8H2
(905)-470-5400

Consumer Electronics Group
22171 Fraserwood Way
Richmond, B.C. V6W 1J5
(604)-303-2500

Consumer Electronics Group
1643 North Service Road
Droval, QC H9P 1J1
(514)-856-4100

All warranties implied by state law, including the implied warranties of merchantability and fitness for a particular purpose, are expressly limited to the duration of the limited warranties set forth above. With the exception of any warranties implied by state law as hereby limited, the foregoing warranty is exclusive and in lieu of all other warranties, guarantees, agreements and similar obligations of manufacturer or seller with respect to the repair or replacement of any parts. In no event shall TACP/THI be liable for consequential or incidental damages.

No person, agent, distributor, dealer or company is authorized to change, modify or extend the terms of these warranties in any manner whatsoever. The time within which an action must be commenced to enforce any obligation of TACP/THI arising under the warranty or under any statute, or law of the United States or any state thereof, is hereby limited to ninety (90) days from the date you discover or should have discovered, the defect. This limitation does not apply to implied warranties arising under state law.

This warranty gives you specific legal rights and you may also have other rights which may vary from state to state. Some states do not allow limitation on how long an implied warranty lasts, when an action may be brought, or the exclusion or limitation of incidental or consequential damages, so the above provisions may not apply to you.

ATTENTION CANADIAN CONSUMERS:

Canadian consumers are requested to complete the special Canadian "Warranty Registration Form" enclosed, and forward this completed form with a copy of bill of sale to TOSHIBA OF CANADA to "Register and Validate" their warranty. Product must be purchased from an Authorized Canadian Dealer. Products purchased in the U.S.A. and used in Canada are not covered by these warranties.

IMPORTANT: PACKING AND SHIPPING INSTRUCTION

When you send the product to a Service Station, you must use the original carton box and packing material, then insert the original carton box containing the unit into another carton using more packing material.

Others

TOSHIBA

Printed in Japan

Free Manuals Download Website

<http://myh66.com>

<http://usermanuals.us>

<http://www.somanuals.com>

<http://www.4manuals.cc>

<http://www.manual-lib.com>

<http://www.404manual.com>

<http://www.luxmanual.com>

<http://aubethermostatmanual.com>

Golf course search by state

<http://golfingnear.com>

Email search by domain

<http://emailbydomain.com>

Auto manuals search

<http://auto.somanuals.com>

TV manuals search

<http://tv.somanuals.com>