

# User's Manual

## P200 Series

## Copyright

© 2007 by TOSHIBA Corporation. All rights reserved. Under copyright law, this manual cannot be reproduced in any form without the prior written permission of TOSHIBA. No patent liability is assumed, with respect to the use of the information contained herein.

*TOSHIBA P200 Series Portable Personal Computer User's Manual*

First edition June 2007

Ownership and copyright of music, video computer programs, databases, etc. are protected by the copyright laws. These copyrighted materials may be copied for private use at home only. If, beyond the limitation above, you copy (including to transform data formats) or modify these materials, transfer them or distribute them via the Internet without approval of copyright owners, you may be subject to claims for compensation for damage and/or criminal penalties due to infringements of copyrights or personal rights. Please remember to observe the copyright laws when you use this product to copy the copyrighted works or perform other actions. Please note that you may infringe the owner's rights protected by the copyright laws if you use the screen mode switching functions (e.g. Wide mode, Wide Zoom mode, etc.) of this product to display enlarged images/video at coffee shops or hotels for the purposes of profits or providing these to the public.

## Disclaimer

This manual has been validated and reviewed for accuracy. The instructions and descriptions it contains are accurate for the P200 Series Portable Personal Computers at the time of this manual's production. However, succeeding computers and manuals are subject to change without notice. TOSHIBA assumes no liability for damages incurred directly or indirectly from errors, omissions or discrepancies between the computer and the manual.

## Trademarks

IBM is a registered trademark and IBM PC, OS/2, and PS/2 are trademarks of International Business Machines Corporation.

Celeron, Intel, Intel SpeedStep, Pentium, Intel Core and Centrino are trademarks or registered trademarks of Intel Corporation or its subsidiaries in the United States and other countries.

MS-DOS, Microsoft, Windows and DirectX are registered trademarks and Windows Vista is a Trademark of Microsoft Corporation.

Centronics is a registered trademark of Centronics Data Computer Corporation.

Photo CD is a trademark of Eastman Kodak.

DVD MovieFactory is a registered trademarks of Ulead Systems, Inc.

Manufactured under license from Dolby Laboratories. "Dolby" and the double-D symbol are trademarks of Dolby Laboratories. Confidential unpublished works. Copyright 1992-1997 Dolby Laboratories. All rights reserved.

Manufactured under license from Digital Theater Systems, Inc. U.S. Pat. No's. 5,451,942; 5,956,674; 5,974,380; 5,978,762; 6,226,616; 6,487,535 and other U.S. and world-wide patents issued and pending. "DTS" and "DTS Digital Surround" are registered trademarks of Digital Theater Systems, Inc. Copyright 1996, 2003 Digital Theater Systems, Inc. All Rights Reserved.

Bluetooth is a registered trademark owned by its proprietor and used by TOSHIBA under license.

iLINK is a trademark of Sony Corporation.

Other trademarks and registered trademarks not listed above may be used in this manual.

## Macrovision License of Notice

This product incorporates copyright protection technology that is protected by U.S. patents and other intellectual property rights. Use of this copyright protection technology must be authorized by Macrovision, and is intended for home and other limited viewing uses only unless otherwise authorized by Macrovision. Reverse engineering or disassembly is prohibited.

## Safety Instructions

Use the following safety guidelines to help protect yourself and your computer.

### When Using Your Computer

Do not operate your portable computer for an extended period of time with the base resting directly on your body. With extended operation, heat can potentially build up in the base. Allowing sustained contact with the skin could cause discomfort or, eventually, a burn.

- Do not attempt to service the computer yourself. Always follow installation instructions closely.
- Do not carry a battery in your pocket, purse, or other container where metal objects (such as car keys) could short-circuit the battery terminals. The resulting excessive current flow can cause extremely high temperatures and may result in damage from burns.
- Be sure that nothing rests on your AC adapter's power cable and that the cable is not located where it can be tripped over or stepped on.
- Place the AC adapter in a ventilated area, such as a desk top or on the floor, when you use it to run the computer or to charge the battery. Do not cover the AC adapter with papers or other items that will reduce cooling; also, do not use the AC adapter while it is inside a carrying case.

- Use only the AC adapter and batteries that are approved for use with this computer. Use of another type of battery or AC adapter may risk fire or explosion.
- Before you connect the computer to a power source, ensure that the voltage rating of the AC adapter matches that of the available power source.
  - 115V/60 Hz in most of North and South America and some Far Eastern countries such as Taiwan.
  - 100 V/50 Hz in eastern Japan and 100 V/60 Hz in western Japan.
  - 230 V/50 Hz in most of Europe, the Middle East, and the Far East.
- If you use an extension cable with your AC adapter, ensure that the total ampere rating of the products that are plugged into it do not exceed the ampere rating of the extension cable itself.
- To help avoid the potential hazard of electric shock, do not connect or disconnect any cables or perform maintenance or reconfiguration of this product during an electrical storm.
- When setting up the computer for work, place it on a level surface.
- Do not dispose of batteries in a fire. They may explode. Check with local authorities for disposal instructions.
- When travelling, do not check the computer as baggage. You can put your computer through an X-ray security machine, but never put your computer through a metal detector. If you have the computer checked by hand, be sure to have a charged battery available in case you are asked to turn on the computer.
- When travelling with the hard drive removed from the computer, wrap the drive in a non-conducting material, such as cloth or paper. If you have the drive checked by hand, be ready to install the drive in the computer. You can put the hard drive through an X-ray security machine, but never put it through a metal detector.
- When travelling, do not place the computer in overhead storage compartments where it could slide around. Do not drop your computer or subject it to other mechanical shocks.
- Protect your computer, battery, and hard drive from environmental hazards such as dirt, dust, food, liquids, temperature extremes, and overexposure to sunlight.
- When you move your computer between environments with very different temperature and/or humidity ranges, condensation may form on or within the computer. To avoid damaging the computer, allow sufficient time for the moisture to evaporate before using the computer.
- When you disconnect a cable, pull on its connector or on its strain relief loop, not on the cable itself. As you pull out the connector, keep it evenly aligned to avoid bending any connector pins. Also, before you connect a cable make sure both connectors are correctly oriented and aligned.

- Before you clean your computer, turn it off, unplug it from its power source, and remove the battery.
- Handle components with care. Hold a component such as a memory module by its edges, not its pins.



*When using telephone equipment in conjunction with your computer, basic safety precautions should always be followed to reduce the risk of fire, electric shock and injury to persons, including the following:*

- Do not use this product near water, for example, near a bathtub, washing bowl, kitchen sink or laundry tub, in a wet basement or near a swimming pool.
- Avoid using a telephone (other than a cordless type) during an electrical storm. There may be a remote risk of electric shock from lightning.
- Do not use the telephone to report a gas leak in the vicinity of the leak.
- Use only the power cord indicated in this manual.
- Replace only with the same or equivalent type battery recommended by the manufacturer.
- Dispose of used batteries according to the manufacturer's instructions.
- To reduce the risk of fire, use only No. 26 AWG or larger telecommunication line cord.



*Use only the battery pack that came with the computer or an optional battery pack. Use of the wrong battery could damage your computer.*

TOSHIBA assumes no liability for any damage in such case.

## EU Declaration of Conformity



This product is carrying the CE-Mark in accordance with the related European Directives. The party responsible for CE-Marking is TOSHIBA Europe GmbH, Hammfelddamm 8, 41460 Neuss, Germany.

The complete and official EU Declaration of Conformity can be found on TOSHIBA's web site <http://epps.toshiba-teg.com> on the Internet.

## GOST

П о р т а т и в н ы й    К о м п ь ю т е р

Изготовитель: Toshiba Europe GmbH  
Regensburg Operations Center  
Адрес: Leibnizstrasse 2, Regensburg, 93055  
Germany

Сделано в Китае



## Following information is only for EU-member states:

The symbol indicates that this product may not be treated as household waste. Please ensure this product is properly disposed of as inappropriate waste handling of this product may cause potential hazards to the environment and human health. For more detailed information about recycling of this product, please contact your local city office, your household waste disposal service or the shop where you purchased the product.



*This symbol may not stick depending on the country and region where you purchased.*

## Optical Disc Drive Safety Instruction



■ *Be sure to check the international precautions at the end of this section.*

The optical drive that is used in this computer is equipped with a laser device. A classification label with the following sentence is affixed to the surface of the drive.

CLASS 1 LASER PRODUCT  
 LASER KLASSE 1  
 LUOKAN 1 LASERLAITE  
 APPAREIL A LASER DE CLASSE 1  
 KLASS 1 LASER APPARAT

The drive with the above label is certified by the manufacturer that the drive complies with the requirement for laser product on the date of manufacturing pursuant to article 21 of Code of Federal Regulations by the United States of America, Department of Health & Human Services, Food and Drug Administration.

In other countries, the drive is certified to comply with the requirement pursuant to IEC 825 and EN60825 on class 1 laser product.

This computer is equipped with one of the optical drive in the following list according to the model.

## Pioneer

### DVD Super Multi DVR-K17



- *The DVD Super Multi drive employs a laser system. To ensure proper use of this product, please read this instruction manual carefully and retain for future reference. Should the unit ever require maintenance, contact an authorized service location.*
- *Use of controls, adjustments or the performance of procedures other than those specified may result in hazardous radiation exposure.*
- *To prevent direct exposure to the laser beam, do not try to open the enclosure.*

### Location of the required label

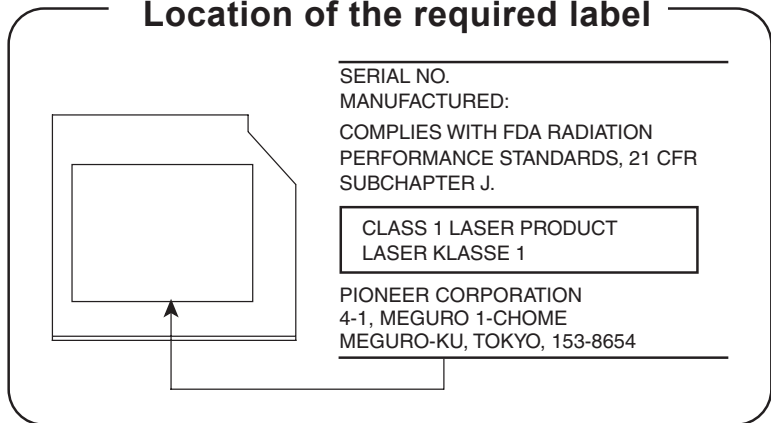

## TOSHIBA Samsung Storage Technology

### TS-L632D



- *The drive employs a laser system. To ensure proper use of this product, please read this instruction manual carefully and retain for future reference. Should the unit ever require maintenance, contact an authorized service location.*
- *Use of controls, adjustments or the performance of procedures other than those specified may result in hazardous radiation exposure.*
- *To prevent direct exposure to the laser beam, do not try to open the enclosure.*

### Location of the required label

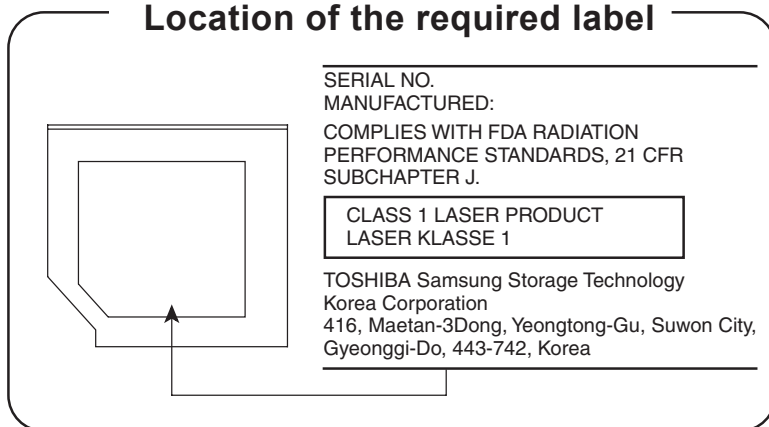



## Hitachi-LG Data Storage

### DVD Super Multi GSA-T20N



- *The DVD Super Multi drive employs a laser system. To ensure proper use of this product, please read this instruction manual carefully and retain for future reference. Should the unit ever require maintenance, contact an authorized service location.*
- *Use of controls, adjustments or the performance of procedures other than those specified may result in hazardous radiation exposure.*
- *To prevent direct exposure to the laser beam, do not try to open the enclosure.*

### Location of the required label

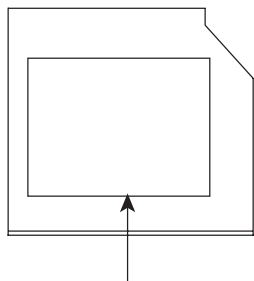

SERIAL NO.  
MANUFACTURED:  
COMPLIES WITH FDA RADIATION  
PERFORMANCE STANDARDS, 21 CFR  
SUBCHAPTER J.

CLASS 1 LASER PRODUCT  
LASER KLASSE 1

Hitachi-LG Data Storage, Inc.  
22-23, Kaigan 3-chome, Minato-ku,  
Yokyo, 108-0022 Japan

## Panasonic

### DVD Super Multi UJ-850U



- *The DVD Super Multi drive employs a laser system. To ensure proper use of this product, please read this instruction manual carefully and retain for future reference. Should the unit ever require maintenance, contact an authorized service location.*
- *Use of controls, adjustments or the performance of procedures other than those specified may result in hazardous radiation exposure.*
- *To prevent direct exposure to the laser beam, do not try to open the enclosure.*

### Location of the required label

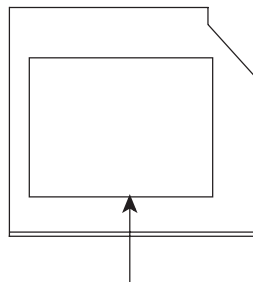

SERIAL NO.  
MANUFACTURED:  
COMPLIES WITH FDA RADIATION  
PERFORMANCE STANDARDS, 21 CFR  
SUBCHAPTER J.

CLASS 1 LASER PRODUCT  
LASER KLASSE 1

Panasonic Communications Co., Ltd.  
1-62, 4-Chome Minoshima, Hakata-Ku  
Fukuoka, Japan

## TEAC

### DV-W28EC



- *The drive employs a laser system. To ensure proper use of this product, please read this instruction manual carefully and retain for future reference. Should the unit ever require maintenance, contact an authorized service location.*
- *Use of controls, adjustments or the performance of procedures other than those specified may result in hazardous radiation exposure.*
- *To prevent direct exposure to the laser beam, do not try to open the enclosure.*

### Location of the required label

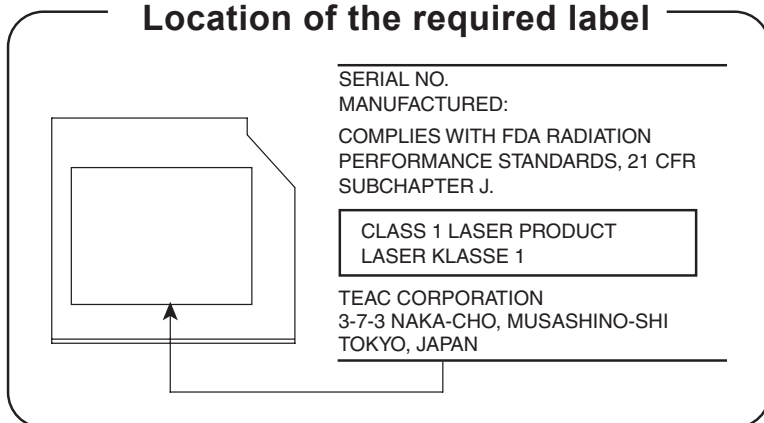

**TOSHIBA****HD DVD-ROM TS-L802A**

- *The HD DVD-ROM drive employs a laser system. To ensure proper use of this product, please read this instruction manual carefully and retain for future reference. Should the unit ever require maintenance, contact an authorized service location.*
- *Use of controls, adjustments or the performance of procedures other than those specified may result in hazardous radiation exposure.*
- *To prevent direct exposure to the laser beam, do not try to open the enclosure.*

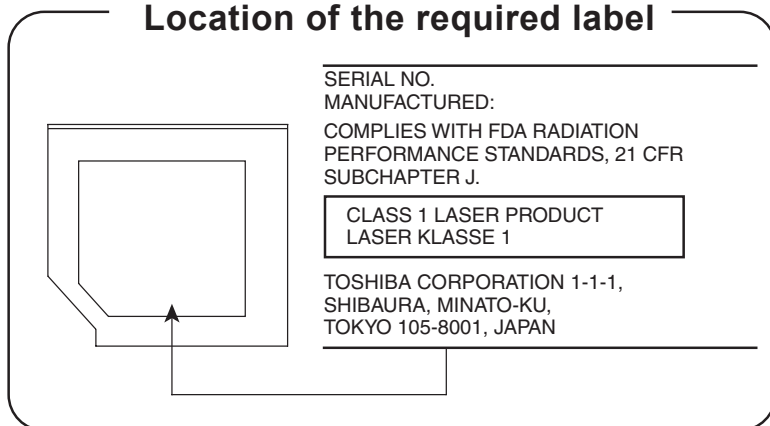
**Location of the required label**

## International Precautions

CLASS 1 LASER PRODUCT  
LASER KLASSE 1 PRODUKT  
TO EN 60825-1  
クラス1レーザ製品

**CAUTION:** This appliance contains a laser system and is classified as a "CLASS 1 LASER PRODUCT." To use this model properly, read the instruction manual carefully and keep this manual for your future reference. In case of any trouble with this model, please contact your nearest "AUTHORIZED service station." To prevent direct exposure to the laser beam, do not try to open the enclosure.

**CAUTION:** USE OF CONTROLS OR ADJUSTMENTS OR PERFORMANCE OF PROCEDURES OTHER THAN THOSE SPECIFIED IN THE OWNER'S MANUAL MAY RESULT IN HAZARDOUS RADIATION EXPOSURE.

## Modem warning notice

### Conformity Statement

The equipment has been approved to [Commission Decision "CTR21"] for pan-European single terminal connection to the Public Switched Telephone Network (PSTN).

However, due to differences between the individual PSTNs provided in different countries/regions the approval does not, of itself, give an unconditional assurance of successful operation on every PSTN network termination point.

In the event of problems, you should contact your equipment supplier in the first instance.

## Network Compatibility Statement

This product is designed to work with, and is compatible with the following networks. It has been tested to and found to conform with the additional requirements conditional in EG 201 121.

Germany	ATAAB AN005, AN006, AN007, AN009, AN010 and DE03, 04, 05, 08, 09, 12, 14, 17
Greece	ATAAB AN005, AN006 and GR01, 02, 03, 04
Portugal	ATAAB AN001, 005, 006, 007, 011 and P03, 04, 08, 10
Spain	ATAAB AN005, 007, 012, and ES01
Switzerland	ATAAB AN002
Norway	ATAAB AN002, 005, 007 and NO 01, 02
All other countries/ regions	ATAAB AN003, 004

Specific switch settings or software setup are required for each network, please refer to the relevant sections of the user guide for more details.

The hookflash (timed break register recall) function is subject to separate national type approvals. It has not been tested for conformity to national type regulations, and no guarantee of successful operation of that specific function on specific national networks can be given.

## Important Notice

Copyrighted works including, but not limited to music, video, computer program, databases are protected by copyright laws. Unless specifically permitted under applicable copyright laws, you cannot copy, modify, assign, transmit or otherwise dispose of any copyrighted work with the consent of the owner of the copyright.

Please take notice that unauthorized copying, modification, assignment, transmission and disposition may be subject to claims for damages and penalties.

## General Precautions

TOSHIBA computers are designed to optimize safety, minimize strain and withstand the rigors of portability. However, certain precautions should be observed to further reduce the risk of personal injury or damage to the computer.

Be certain to read the general precautions below and to note the cautions included in the text of the manual.

## Creating a computer-friendly environment

Place the computer on a flat surface that is large enough for the computer and any other items you are using, such as a printer.

Leave enough space around the computer and other equipment to provide adequate ventilation. Otherwise, they may overheat.

To keep your computer in prime operating condition, protect your work area from:

- Dust, moisture, and direct sunlight.
- Equipment that generates a strong electromagnetic field, such as stereo speakers (other than speakers that are connected to the computer) or speakerphones.
- Rapid changes in temperature or humidity and sources of temperature change such as air conditioner vents or heaters.
- Extreme heat, cold, or humidity.
- Liquids and corrosive chemicals.

## Stress injury

Carefully read the Instruction Manual for Safety and Comfort. It contains information on the prevention of stress injuries to your hands and wrists that can be caused by extensive keyboard use. Chapter 3, *Getting Started*, also includes information on work space design, posture and lighting that can help reduce physical stress.

## Heat injury

- Avoid prolonged physical contact with the computer. If the computer is used for long periods, its surface can become very warm. While the temperature will not feel hot to the touch, if you maintain physical contact with the computer for a long time, for example if you rest the computer on your lap or if you keep your hands on the palm rest, your skin might suffer a low-heat injury.
- If the computer has been used for a long time, avoid direct contact with the metal plate supporting the various interface ports as this can become hot.
- The surface of the AC adaptor can become hot when in use but this condition does not indicate a malfunction. If you need to transport the AC adaptor, you should disconnect it and let it cool before moving it.
- Do not lay the AC adaptor on a material that is sensitive to heat as the material could become damaged.

## Pressure or impact damage

Do not apply heavy pressure to the computer or subject it to any form of strong impact as this can damage the computer's components or otherwise cause it to malfunction.

## **PC Card overheating**

Some PC Cards can become hot during prolonged use which may result in errors or instability in the operation of the device in question. In addition, you should also be careful when you remove a PC Card that has been used for a long time.

## **Mobile phones**

Please be aware that the use of mobile phones can interfere with the audio system. The operation of the computer will not be impaired in any way, but it is recommended that a minimum distance of 30 cm is maintained between the computer and a mobile phone that is in use.

## **Instruction Manual for Safety and Comfort**

All important information on the safe and proper use of this computer is described in the enclosed Instruction Manual for Safety and Comfort. Be sure to read it before using the computer.



# Table of Contents

## *Chapter 1* **P200 Series Features**

Features . . . . .	1-1
Special features . . . . .	1-8
TOSHIBA Value Added Package . . . . .	1-9
Utilities and Applications . . . . .	1-10
Options . . . . .	1-12

## *Chapter 2* **The Grand Tour**

Front with the display closed . . . . .	2-1
Right side . . . . .	2-3
Left side . . . . .	2-4
Back side . . . . .	2-5
Underside . . . . .	2-6
Front with the display open . . . . .	2-7
Keyboard Indicators . . . . .	2-9
Optical Disc drive . . . . .	2-10

## *Chapter 3* **Getting Started**

Connecting the AC adapter . . . . .	3-1
Opening the display . . . . .	3-3
Turning on the power . . . . .	3-3
Starting up for the first time . . . . .	3-4
Turning off the power . . . . .	3-4
Restarting the computer . . . . .	3-8
System Recovery Options . . . . .	3-8
Restoring the pre-installed software from the Product Recovery disc . . . . .	3-9

**Chapter 4 Operating Basics**

Using the TouchPad .....	4-1
Using the Web Camera .....	4-2
Using the internal modem .....	4-4
LAN .....	4-7
Wireless LAN .....	4-8
Using optical disc drives .....	4-11
TOSHIBA Disc Creator .....	4-15
Media Care .....	4-16
Discs .....	4-17
TV-Out & HDMI .....	4-17
Setting up more than one display .....	4-17
Cleaning the computer .....	4-18
Moving the computer .....	4-19

**Chapter 5 About the HD DVD**

Summary .....	5-1
Using TOSHIBA HD DVD PLAYER to enjoy HD DVDs .....	5-3
Using TOSHIBA HD DVD PLAYER .....	5-7
Operating TOSHIBA HD DVD PLAYER .....	5-8
Using the Computer in place of an HD DVD Player .....	5-12
HD DVD-R Disc writing Software (depending on the model you purchased) .....	5-13
Writing CDs/DVDs on a DVD Super Multi drive or HD DVD-ROM drive supporting double layer disc recording .....	5-14
Writing CDs/DVDs/HD DVDs on a HD DVD-R drive (depending on the model you purchased) .....	5-18
When Using Ulead DVD MovieFactory® for TOSHIBA .....	5-22

**Chapter 6 The Keyboard**

Typewriter keys .....	6-1
F1 ... F12 function keys .....	6-2
Soft keys: Fn key combinations .....	6-2
Hotkeys .....	6-3
Windows special keys .....	6-4
Number Pad .....	6-4
Generating ASCII characters .....	6-4

<i>Chapter 7</i>	<b>Power and Power-Up Modes</b>	
	Power conditions . . . . .	7-1
	Power indicators . . . . .	7-2
	Battery types . . . . .	7-3
	Care and use of the battery pack . . . . .	7-4
	Replacing the battery pack . . . . .	7-10
	TOSHIBA Password Utility . . . . .	7-12
	Power-up modes . . . . .	7-13
	Panel power off/on . . . . .	7-14
	System automatic Sleep/Hibernation . . . . .	7-14
<i>Chapter 8</i>	<b>HW Setup</b>	
	Accessing HW Setup . . . . .	8-1
	HW Setup Window . . . . .	8-1
<i>Chapter 9</i>	<b>Optional Devices</b>	
	Express Card . . . . .	9-1
	SD/SDHC/MMC/MS/MS Pro/xD Memory cards . . . . .	9-3
	Memory expansion . . . . .	9-5
	Additional battery pack . . . . .	9-9
	Additional AC adapter . . . . .	9-9
	External monitor . . . . .	9-9
	Television . . . . .	9-10
	HDMI . . . . .	9-11
	Remote Controller . . . . .	9-14
	Using the Remote Controller . . . . .	9-16
	Installing/Removing batteries . . . . .	9-18
	i.LINK (IEEE1394a) . . . . .	9-21
	Security lock . . . . .	9-22
<i>Chapter 10</i>	<b>Troubleshooting</b>	
	Problem solving process . . . . .	10-1
	Hardware and system checklist . . . . .	10-3
	TOSHIBA support . . . . .	10-17

**Chapter 11 Disclaimers**

<b>CPU</b> .....	<b>11-1</b>
<b>Memory (Main System)</b> .....	<b>11-2</b>
<b>Battery Life</b> .....	<b>11-2</b>
<b>HDD Drive Capacity</b> .....	<b>11-3</b>
<b>LCD</b> .....	<b>11-3</b>
<b>Graphics Processor Unit ("GPU")</b> .....	<b>11-3</b>
<b>Wireless LAN</b> .....	<b>11-3</b>
<b>Non-applicable Icons</b> .....	<b>11-3</b>
<b>Copy Protection</b> .....	<b>11-4</b>
<b>Images</b> .....	<b>11-4</b>
<b>LCD Brightness and Eye Strain</b> .....	<b>11-4</b>

**Appendix A Specifications****Appendix B Display Modes****Appendix C AC Power Cord and Connectors****Appendix D If your computer is stolen****Glossary**

# Preface

Congratulations on your purchase of the P200 Series computer. This powerful notebook computer provides excellent expansion capability, including multimedia devices, and it is designed to provide years of reliable, high-performance computing.

This manual tells how to set up and begin using your P200 Series computer. It also provides detailed information on configuring your computer, basic operations and care, using optional devices and troubleshooting.

If you are a new user of computers or if you're new to portable computing, first read over the *P200 Series Features* and *The Grand Tour* chapters to familiarize yourself with the computer's features, components and accessory devices. Then read *Getting Started* for step-by-step instructions on setting up your computer.

If you are an experienced computer user, please continue reading the preface to learn how this manual is organized, then become acquainted with this manual by browsing through its pages. Be sure to look over the *Special features* section of the *P200 Series Features*, to learn about features that are unique to the computer.

## Manual contents

This manual has eleven chapters, four appendixes and a glossary.

Chapter 1, *P200 Series Features*, is an overview of the computer's special features, utilities, and options.

Chapter 2, *The Grand Tour*, identifies the components of the computer and briefly explains how they function.

Chapter 3, *Getting Started*, provides a quick overview of how to begin operating your computer and gives tips on safety and designing your work area. Be sure to read the sections on setting up the operating system and on restoring the pre-installed software.

Chapter 4, *Operating Basics*, includes instructions on using the following devices: TouchPad/Dual Mode Pad, the optical disc drives, the internal modem, LAN and wireless LAN. It also provides tips on care of the computer, disks and DVD/CD-ROMs.

Chapter 5, *About the HD DVD*, describes the features, use of HD DVD and HD DVD Media.

Chapter 6, *The Keyboard*, describes special keyboard functions including hotkeys.

Chapter 7, *Power and Power-Up Modes*, gives details on the computer's power resources.

Chapter 8, *HW Setup*, introduces you to the TOSHIBA Hardware Setup program.

Chapter 9, *Optional Devices*, describes the optional hardware available.

Chapter 10, *Troubleshooting*, provides helpful information on how to perform some diagnostic tests, and suggests courses of action if the computer doesn't seem to be working properly.

Chapter 11, *Disclaimers*, provides disclaimer information related to your computer.

The *Appendices* provide technical information about your computer.

The *Glossary* defines general computer terminology and includes a list of acronyms used in the text.

## Conventions

This manual uses the following formats to describe, identify, and highlight terms and operating procedures.

### Abbreviations

On first appearance, and whenever necessary for clarity, abbreviations are enclosed in parentheses following their definition. For example: Read Only Memory (ROM). Acronyms are also defined in the *Glossary*.

### Icons

Icons identify ports, dials, and other parts of your computer. The indicator panel also uses icons to identify the components it is providing information on.

### Keys

The keyboard keys are used in the text to describe many computer operations. A distinctive typeface identifies the key top symbols as they appear on the keyboard. For example, **Enter** identifies the Enter key.

### Key operation

Some operations require you to simultaneously use two or more keys. We identify such operations by the key top symbols separated by a plus sign (+). For example, **Ctrl + C** means you must hold down **Ctrl** and at the same time press **C**. If three keys are used, hold down the first two and at the same time press the third.

**DISKCOPY A: B:** When procedures require an action such as clicking an icon or entering text, the icon's name or the text you are to type in is represented in the type face you see to the left.

## Display



Names of windows or icons or text generated by the computer that appears on its display screen is presented in the type face you see to the left.

## Messages

Messages are used in this manual to bring important information to your attention. Each type of message is identified as shown below.



*Pay attention! A caution informs you that improper use of equipment or failure to follow instructions may cause data loss or damage your equipment.*



*Please read. A note is a hint or advice that helps you make best use of your equipment.*

## Terminology

This term is defined in this document as follows:

### **Start**

The word "Start" refers to the  button in Microsoft® Windows Vista™.

## Equipment checklist

Carefully unpack your computer. Save the box and packing materials for future use. Check to make sure you have all the following items:

### Hardware

- P200 Series Portable Personal Computer
- Universal AC Adapter and Power Cord
- USB Floppy Disk Drive (provided with some models)
- Modular cable for modem (provided with some models)

## Software

Microsoft® Windows Vista™ Home Basic/Home Premium/Business Edition/  
Ultimate Edition

- The following software which is pre-installed on your hard disk:
  - Microsoft® Windows Vista™ Home Basic/Home Premium/Business Edition/Ultimate Edition
  - DVD Video Player
  - TOSHIBA Disc Creator
  - TOSHIBA ConfigFree
  - TOSHIBA Assist
  - TOSHIBA SD Memory Card Format\*
  - TOSHIBA HW Setup
  - TOSHIBA Value Added Package Utility
  - TOSHIBA Supervisor Password Utility
  - Ulead DVD MovieFactory®
  - Online Manual
- Product Recovery disc (provided with some models)

\* The availability of this software is dependent on the model you purchased.



*The system may not function properly if you use drivers that are not pre-installed or distributed by TOSHIBA.*



*SD Memory Card Format Utility and other SD functions are packaged into TOSHIBA SD Memory Utilities. When uninstalling the SD utilities, click **Start → Control Panel → Programs**, and select TOSHIBA SD Memory Utilities.*

## Documentation

- Your computer's documentation:
  - P200 Series Personal Computer User's Manual
  - P200 Series Quickstart
  - Microsoft® Windows Vista™ Quick Start Guide
  - Warranty Information
  - Instruction Manual for Safety and Comfort



*If any of the items are missing or damaged, contact your dealer immediately.*



# Chapter 1

## P200 Series Features

This chapter identifies the computer's special features, options and accessories.



*Some of the features described in this manual may not function properly if you use an operating system that was not pre-installed by TOSHIBA.*

### Features

Please visit your region's web site for the configuration details of the model that you have purchased.

#### **Processor**

---

Intel® Core™ 2 Duo Processor

---

#### **Disclaimer (CPU)**

For more information on the Disclaimer regarding CPU, please refer to the [Disclaimers](#) section in Chapter 11.

#### **Chipset**

- 
- Mobile Intel® PM965 Express Chipset
  - TEXAS INSTRUMENTS CardReader & 1394a Controller PCI8402
  - Realtek High Definition Audio Codec ALC268
  - Realtek 10M/100M/1Gbps LAN Controller RTL8111B, 10M/100M LAN Controller RTL8101E
  - (Depending on the model you purchased)
-

## Memory



The graphics system in your computer may use part of the main system memory for graphics performance and therefore reduce the amount of system memory available for other computing activities. The amount of system memory allocated to support graphics may vary depending on the graphics system, applications utilized, system memory size and other factors.

<b>Slot</b>	Two DDRII SO-DIMM, up to 4 GB with Mobile Intel® PM965 Express Chipset; can be upgraded through the memory expansion slot. You need to remove existing SO-DIMM if SO-DIMM is Maximum upgradable system memory size is depending on the system you purchased.
<b>L2 Cache</b>	Depending on the model you purchased. ■ 4 MB, 2 MB, or 1 MB L2 Cache
<b>Video RAM</b>	Depending on the model you purchased: ■ ATI Mobility. Radeon™ HD2400, up to 256 MB VRAM (GDDR2) ■ ATI Mobility. Radeon™ HD2600, up to 512 MB VRAM (GDDR2)

## BIOS

- 1 MB Flash ROM for system BIOS
- Suspend to memory or hard disk drive
- Various Hotkey functions for system control
- Complete ACPI 1.0b functionality

## Power

<b>Battery Pack</b>	6-cell Lithium Ion smart battery pack with 10.8 V*4000 mAh. Approximately 12 hours or longer charging time to 100% battery capacity with system switched on. Approximately 4 hours charge time to 100% battery capacity with system switched off. Approximately 1.5 days discharging time in Sleep Mode for the 9-cell battery, 1 day for the 6-cell battery. Discharge time in shutdown mode is approximately 1 month. * The availability of this battery is dependent on the model you purchased.
---------------------	--

### **Disclaimer (Battery Life)**

For more information on the Disclaimer regarding Battery Life, please refer to the [Disclaimers](#) section in Chapter 11.

<b>RTC Battery</b>	The computer has an internal battery to back up its Real Time Clock (RTC), calendar and setup information. This battery will last for an average of one month with no external power source.
<b>AC adapter</b>	The universal AC adapter provides power to the system and recharges the batteries when they are low. It comes with a detachable power cord.

### **Floppy Disk Drive devices**

External USB Floppy Disk Drive (depends on the model purchased).

### **TouchPad**

The TouchPad control buttons in the palm rest enable control of the on-screen pointer.



*The volume control on the right side of the TouchPad and print button may not function with some applications.*

### **Display**

17" TFT screen with a resolution of 1440 horizontal × 900 vertical pixels.

### **Disclaimer (LCD)**

For more information on the Disclaimer regarding LCD, please refer to the [Disclaimers](#) section in Chapter 11.

<b>Graphics controller</b>	ATI Mobility. Radeon™ HD2400/HD2600 (Graphics controller chipset depends on the model purchased)  The graphics controller maximizes display performance. Refer to <a href="#">Display Modes</a> section in Appendix B for more information.
----------------------------	---

### **Disclaimer (Graphics Processor Unit ("GPU"))**

For more information on the Disclaimer regarding Graphic Processor Unit ("GPU"), please refer to the [Disclaimers](#) section in Chapter 11.

## Disks

---

<b>Fixed hard disk</b>	9.5 mm 2.5" hard disk drive (60/80/100/120/160/200 GB)
	12.5 mm 2.5" hard disk drive (160/200/250/300 GB)
	Serial ATA 2.5 Gb/s

---

### Disclaimer (HDD Drive Capacity)

For more information on the Disclaimer regarding HDD Drive Capacity, please refer to the [Disclaimers](#) section in Chapter 11.

---

<b>DVD Super Multi drive supporting R Double Layer</b>	Some models are equipped with a full-size DVD Super Multi drive supporting $\pm$ R Double Layer module with dual layer support that lets you record data to rewritable CD/DVDs as well as run either 12 cm (4.72") or 8 cm (3.15") CD/DVDs without using an adapter. It reads DVD-ROMs at maximum 8x speed and CD-ROMs at maximum 24x speed. It writes CD-Rs at up to 24x speed, CD-RWs at up to 16x speed, DVD-Rs at maximum 8x speed, DVD-RWs at maximum 6x speed, DVD+RWs at maximum 8x speed, DVD+Rs at maximum 8x speed, DVD+R (double layer) at maximum 4x speed, DVD-R (dual layer) at maximum 4x speed and DVD-RAM at maximum 5x speed. This drive supports the following:
--	--

- |                                   |                        |
|-----------------------------------|------------------------|
| ■ DVD-ROM                         | ■ DVD-Video            |
| ■ DVD-R                           | ■ DVD-RW               |
| ■ DVD+R                           | ■ DVD+RW               |
| ■ DVD-RAM                         | ■ DVD+R (double layer) |
| ■ CD-R                            | ■ CD-RW                |
| ■ CD-DA                           | ■ CD-Text              |
| ■ DVD-R (dual layer)              |                        |
| ■ Photo CD (single/multi-session) |                        |
| ■ CD-ROM Mode1, Mode2             |                        |
| ■ CD-ROM XA Mode2 (Form1, Form2)  |                        |
| ■ Enhanced CD (CD-EXTRA)          |                        |
-

**HD DVD-ROM drive**

HD DVD-ROM reads HD DVD-ROMs at maximum 1x speed DVD-ROMs at maximum 8x speed and CD-ROMs at maximum 24x speed. It writes CD-Rs at up to 16x speed, CD-RWs at up to 10x speed, DVD-Rs at maximum 4x speed, DVD-RWs at maximum 6x speed, DVD+RWs at maximum 4x speed, DVD+Rs at maximum 4x speed, DVD+R (double layer) at maximum 2.4x speed, DVD-R (dual layer) at maximum 2x speed and DVD-RAM at maximum 3x speed. This drive supports the following:

- HD DVD-ROM
- DVD-ROM
- DVD-R
- DVD-RW
- DVD+R
- DVD+RW
- DVD-RAM
- DVD-Video
- CD-R
- CD-RW
- CD-DA
- CD-Text
- DVD-R (dual layer)
- DVD+R (double layer)
- Photo CD (single/multi-session)
- CD-ROM Mode1, Mode2
- CD-ROM XA Mode2 (Form1, Form2)
- Enhanced CD (CD-EXTRA)



*Computers in this series can be configured with multiple types of optical disc drive. For more information on the optical disc drives available, talk to your dealer. More information on using the optical disc drive can be found in Chapter 4, [Operating Basics](#).*

### **Slots (depending on configuration)**

#### **Multiple Digital Media Card (SD/SDHC/MMC/MS/MS Pro/xD)**

This slot lets you easily transfer data from devices, such as digital cameras and Personal Digital Assistants, that use flash-memory.

You can use a memory module in this slot.

#### **Express Card**

The Express Card expansion slot that can accommodate two standard module formats; an Express Card/34 module and an Express Card/54 module. An Express Card module is a small add-in card technology based on the PCI Express and Universal Serial Bus (USB) interfaces.

### **Ports (depending on configuration)**

<b>External monitor</b>	15-pin analog VGA port supports VESA DDC2B compatible functions.
<b>Universal Serial Bus</b>	The computer has Six Universal Serial Bus (USB) ports that comply with the USB 2.0 standard, which enables data transfer speeds more than 40 times faster than USB 1.1 (which this computer also supports).
<b>i.LINK (IEEE1394a)</b>	This port enables high-speed data transfer directly from external devices such as digital video cameras.
<b>TV Out</b>	The 4-pin S-Video port is compatible with PAL or NTSC TV standard, supporting Macrovision 7.02 copy protection.
<b>HDMI</b>	High Definition Multimedia Interface allows the connection of other High Definition Devices such as Televisions and DVD Players.

### **Multimedia**

<b>Sound system</b>	The integrated Windows® compatible sound system provides support for internal speakers as well as jacks for an external microphone and headphones.
<b>Line In Jack</b>	Insert standard 3.5 mm jack to listen to audio.
<b>S/PDIF Jack</b>	Insert standard 3.5 mm jack to listen to audio onspeakers or other external devices.
<b>Headphone jack</b>	A standard 3.5 mm stereo jack is provided for the connection of external headphones or speakers.
<b>Microphone jack</b>	A standard 3.5 mm mini microphone jack enables connection of monaural microphone input.
<b>Web Camera</b>	Record/Send still or video images with this integrated Web Camera.

---

## **Communications (depending on configuration)**

---

<b>Modem</b>	An internal modem provides capability for data and fax communication. It supports the V.90 or V.92 standards depending on the region and provides a modem jack for connection to a telephone line. The speed of data and fax transfer depends on the analog telephone line conditions.
<b>LAN</b>	The computer has built-in support for Ethernet LAN (10 Mbps, 10BASE-T) and Fast Ethernet LAN (100 Mbps 100BASE-TX).
<b>Wireless LAN</b>	The computer has a built-in wireless LAN mini-PCI card that is compatible with other LAN systems that support the following: 802.11a/b/g/n wireless LAN module/ 802.11a/b/g wireless LAN module/ 802.11b/g wireless LAN module. It has a Frequency Channel Selection (2.4 or 5 GHz) and allows roaming over multiple channels.
<b>Bluetooth</b>	Bluetooth is a short-range wireless technology used to create PANs (Personal Area Networks) among your devices, and with other nearby devices like mobile computers, mobile phones, and digital cameras.

---

## **Security**

---

Power-on password protection.  
Two level password architecture.

---

## **Security Lock Slot**

---

Receives an optional security lock in order to anchor the computer to a desk or other large, heavy object.

---

## Special features

The following features are either unique to TOSHIBA computers or are advanced features, which make the computer more convenient to use.

<b>Hotkeys</b>	Key combinations that let you quickly modify the system configuration directly from the keyboard without running a system configuration program.
<b>Display Automatic Power off</b>	This feature automatically cuts off power to the internal display when there is no input from the keyboard or pointing device for a specified time period. Power is restored when any key is pressed or when there is input from a pointing device. You can specify the time period in the TOSHIBA Power Saver utility.
<b>Hard Disk Drive Automatic Power Off</b>	This feature automatically cuts off power to the hard disk drive when it is not accessed for a specified time period. Power is restored when the hard disk is accessed. You can specify the time period in the TOSHIBA Power Saver utility.
<b>System Automatic Sleep/Hibernation</b>	This feature automatically places the system into either Sleep Mode or Hibernation Mode when there is no input or hardware access for a specified time period. You can specify the time period and select either System Sleep or System Hibernate in the TOSHIBA Power Saver utility.
<b>Power-on Password</b>	Two levels of password security are available, Supervisor and User, which can prevent unauthorized access to your computer.
<b>Battery Save Mode</b>	This feature lets you save battery power. You can specify the level of system power management in the TOSHIBA Power Saver utility.
<b>Instant Security</b>	A Hotkey function which blanks the screen and activates password security to provide quick and easy data security.
<b>Panel Power Off/On</b>	This feature turns power to the computer off when the display panel is closed and turns it back on when the panel is opened. You can specify the setting in the TOSHIBA Power Saver utility.
<b>Low Battery Automatic Hibernation</b>	When battery power is exhausted to the point that computer operation cannot be continued, the system automatically enters Hibernation Mode and shuts itself down. You can specify the setting in the TOSHIBA Power Saver utility.



<b>Hibernation</b>	This feature lets you turn off the power without exiting from your software. The contents of main memory are saved to the hard disk. When you turn on the power again, you can continue working right where you left off. Refer to the <a href="#">Turning off the power</a> section in Chapter 3, <a href="#">Getting Started</a> , for details.
<b>Sleep</b>	In Sleep Mode, power to the system remains on, but the processor and all other devices are effectively in 'sleep mode'. When the computer is in Sleep Mode, the Power LED flashes amber. The computer enters Sleep Mode regardless of the Hibernate Mode setting. Refer to the <a href="#">Turning off the power</a> section in Chapter 3, <a href="#">Getting Started</a> , for details.



- *Before entering Sleep mode, be sure to save your data.*
- *Do not install or remove a memory module while the computer is in Sleep mode. The computer or the module could be damaged.*
- *Do not remove the battery pack while the computer is in Sleep mode. Data in memory will be lost.*

## TOSHIBA Value Added Package

This section describes the TOSHIBA Component features pre-installed on the computer.

<b>TOSHIBA Power Saver</b>	TOSHIBA Power Saver provides you with the features of more various power supply managements.
<b>TOSHIBA Button Support</b>	This utility controls the button operation of the computer. The starting application from the button can be changed.
<b>TOSHIBA PC Diagnostic Tool</b>	The TOSHIBA PC Diagnostic Tool will display basic system configuration information and allow the functionality of some of the computer's builtin hardware devices to be tested.
<b>TOSHIBA Flash Cards</b>	The TOSHIBA Flash Cards provide a quick way to modify selected system functions and to launch applications. <ul style="list-style-type: none"> <li>■ Hot key function</li> <li>■ TOSHIBA utility launcher function</li> </ul>



*When you start or resume your computer, the TOSHIBA Flash Cards may take a moment to become available and may display several times before completely activating. The hot key functions will be available once the TOSHIBA Cards are completely active.*

*If your system is busy and you see a "Not Responding" message, allow TOSHIBA Cards to completely activate before you continue to use the utility and hot keys.*

<b>TOSHIBA Components Common Driver</b>	TOSHIBA Components Common Driver contains the module required for the utility which TOSHIBA offers.
<b>TOSHIBA Accessibility</b>	The TOSHIBA Accessibility utility provides support to movement impaired users when they need to use the TOSHIBA Hot-key functions. In use, the utility allows you to make the <b>Fn</b> key 'sticky', that is you can press it once, release it, and they press one of the " <b>F</b> " keys in order to access its specific function. When set, the <b>Fn</b> key will remain active until another key is pressed.
<b>TOSHIBA Zooming Utility</b>	This utility allows you to enlarge or reduce the icon size on Windows Desktop or the zoom factor associated with specific supported applications.

## Utilities and Applications

This section describes preinstalled utilities and tells how to start them. For details on operations, refer to each utility's online manual, help files or readme.txt files.

<b>TOSHIBA Assist</b>	TOSHIBA Assist is a graphical user interface that provides easy access to help and services.
<b>DVD Video Player</b>	The DVD player is used to play DVD Video media through an on-screen interface and functions.



*Frame dropping, audio skipping or out of synch audio and video may occur during playback of some DVD Video titles. Make sure to connect the computer's AC adaptor when playing a DVD Video. Power-saving features may interfere with smooth playback.*

<b>TOSHIBA ConfigFree</b>	<p>ConfigFree is a suite of utilities to allow easy control of communication devices and network connections. ConfigFree also allows you to find communication problems and create profiles for easy switching between location and communication networks.</p> <p>To start ConfigFree, click <b>Start</b> → <b>All Programs</b> → <b>TOSHIBA Networking</b> → <b>ConfigFree</b>.</p>
<b>TOSHIBA Disc Creator</b>	<p>You can create discs in several formats including audio CDs that can be played on a standard stereo CD player and data discs to store the files and folders on your hard disk drive. This software can be used on a model with a CD-RW/ DVD-ROM drive, DVD Super Multi drive, or HD DVD drive.</p>
<b>TOSHIBA Hardware Setup</b>	<p>This program lets you customize your hardware settings according to the way you work with your computer and the peripherals you use. To access this utility, click <b>Start Button</b> → <b>All Programs</b> → <b>TOSHIBA</b> → <b>Utilities</b> → <b>HWsetup</b>.</p>
<b>CD/DVD Drive Acoustic Silencer</b>	<p>This utility allows you to configure the read speed of CD drive. You can either configure Normal Mode, which operates the drive at its maximum speed for quick data access, or Quiet Mode, which runs at single speed for CD audio and which can lessen operational noise. It is ineffective in DVD.</p>
<b>Ulead DVD MovieFactory® for TOSHIBA</b>	<p>You can edit digital video and make a DVD-Video and support Labelflash™ function.</p>



*The availability of Labelflash™ function depends on the model you purchased.*

<b>Windows Mobility Center</b>	<p>Mobility Center is a utility for accessing several mobile PC settings quickly in one window. A default maximum of eight tiles are provided by the operating system, and the additional two titles are added to your Mobility Center</p> <ul style="list-style-type: none"> <li>■ <b>Lock Computer:</b> This can be used to lock your computer without turning it off. This has the same function as the <b>Lock</b> button at the bottom of the right pane in the start menu.</li> <li>■ <b>TOSHIBA Assist:</b> This can be used to open <b>TOSHIBA Assist</b> if it is already installed in your computer.</li> </ul>
--------------------------------	---

## Options

You can add a number of options to make your computer even more powerful and convenient to use. The following options are available:

<b>Memory Modules</b>	Two memory module can be installed in this computer.
-----------------------	--



*Use only PC5300\* compatible DDRII memory modules. See your TOSHIBA dealer for details.*

*\* The availability of DDRII is dependent on the model you purchased.*

<b>Battery Pack</b>	An additional battery pack can be purchased from your TOSHIBA dealer. Use it as a spare to increase your computer operating time.
<b>High capacity battery pack</b>	An additional battery pack can be purchased from your TOSHIBA dealer. Use it as a spare to increase your computer operating time.
<b>AC adapter</b>	If you use your computer at more than one site frequently, it may be convenient to purchase an additional AC adapter for each site so you will not have to carry the adapter with you.
<b>USB Floppy Disk Drive</b>	Lets you attach a floppy disk drive to your computer by means of a USB cable.

# Chapter 2

## The Grand Tour

This chapter identifies the various components of your computer. Become familiar with each component before you operate the computer.



*Certain types of notebook chassis are designed to accommodate all possible configurations for an entire product series. Your selected model may not have all the features and specifications corresponding to all of the icons or switches shown on the notebook chassis, unless you have selected all those features.*

### Front with the display closed



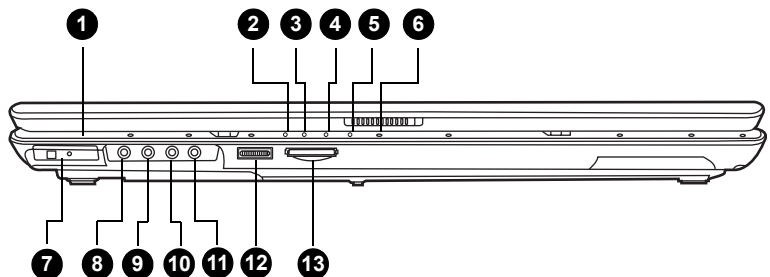





The following figure shows the computer front with its display panel in the closed position.



- |   |                                       |
|---|---------------------------------------|
| 1. Front Edge Logo*                             | 8. Line In Jack                       |
| 2. DC IN LED                                    | 9. Microphone Jack                    |
| 3. Power LED                                    | 10. S/PDIF Jack                       |
| 4. Battery LED                                  | 11. Headphone Jack                    |
| 5. Hard Disk Drive LED                          | 12. Volume Control                    |
| 6. Multiple Digital Media Card Slot Access LED* | 13. Multiple Digital Media Card Slot* |
| 7. Wireless Communication Switch and LED*       |                                       |

\* The availability of this feature is dependent on the model you purchased.

*Front of the computer with display closed*

	<b>Front Edge Logo*</b>	Front Edge Logo indicates the computer series you bought. (The availability of this function is dependent on the model you purchased.)
	<b>DC IN LED</b>	The DC IN LED indicates the computer is connected to the AC adapter and it is plugged into an AC power source.
	<b>Power LED</b>	In normal operating mode, the Power LED is blue (depending on the model you purchased). If the system is in Sleep/Sleep Mode the LED will flash amber, while the LED will be off when the computer is turned off or is in Hibernation Mode.
	<b>Battery LED</b>	The Battery LED indicates the battery's current charge/discharge status. It lights blue (depending on the model you purchased) when the battery is fully charged. It lights amber while the battery is being charged from the AC adapter. It flashes amber when the battery capacity is low.
	<b>Hard Disk Drive LED</b>	The Hard Disk Drive LED indicates that the hard disk drive is being accessed. Every time your computer runs a program, opens a file, or performs some other function in which it must access the hard disk drive, this light will go on.
	<b>Multiple Digital Media Card Slot Access LED*</b>	The Multiple Digital Media Card Slot Access LED lights up when the Multiple Digital Media Card is accessed. (The availability of this function is dependent on the model you purchased.)
	<b>Wireless Communication Switch and LED*</b>	The wireless communication switch turns on the wireless networking transceiver. The Wireless Communication LED beside it indicates that wireless networking is turned on. Indicates whether the Wireless devices is active or not. (The availability of this function is dependent on the model you purchased.)
	<b>Line In Jack</b>	Insert standard 3.5 mm jack to listen to audio.
	<b>Microphone Jack</b>	The standard 3.5 mm mini microphone jack enables connection of a three conductive type mini-jack for a monaural microphone.
	<b>S/PDIF Jack</b>	Insert standard 3.5 mm jack to listen to audio on speakers or other external devices.



### Headphone Jack

The headphone jack lets you connect stereo headphones or other audio-output devices such as external speakers. Connecting headphones or other devices to this jack automatically disables the internal speakers.



### Volume Control

Use this dial to adjust the volume of the stereo speakers or headphones.



### Multiple Digital Media Card Slot\*

The Multiple Digital Media Card Slot allows you to use media cards from digital still cameras and various forms of portable information equipment. (The availability of this function depends on the model you purchased.)

## Right side

The following figure shows the computer's right side.

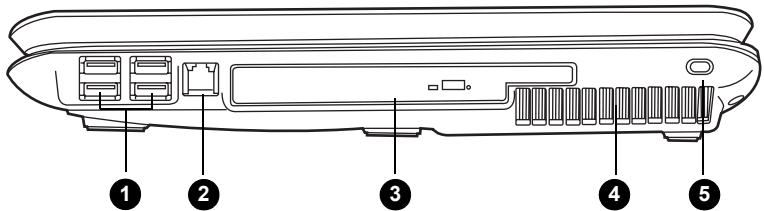

- |                                    |                  |
|------------------------------------|------------------|
| 1. Universal Serial Bus (USB) Port | 4. Fan Vents*    |
| 2. Modem Jack                      | 5. Security Lock |
| 3. Optical Disc Drive and LED      |                  |

\* The availability of this feature is dependent on the model you purchased.

### *The right side of the computer*



### Universal Serial Bus (USB) Port

The Universal Serial Bus (USB 2.0 and 1.1 compatible) port enables USB-equipped devices such as keyboards, mice, hard drives, scanners, and printers to be connected to the computer.



### Modem Jack

In regions where an internal modem is installed as standard equipment, this jack lets you use a modular cable to connect the modem directly to a telephone line.

**Optical Disc Drive and LED** The computer is configured with a full-size optical disc drive module that lets you run either 12 cm (4.72") or 8 cm (3.15") discs without using an adapter. See the Drives section in this chapter for technical specifications on each drive and Chapter 4, *Operating Basics*, for information on using the drive and caring for discs. The LED lets you know when the Optical Disc Drive is being accessed.

**Fan Vents\*** The fan vents help prevent the GPU from overheating.  
(The availability of this function is dependent on the model you purchased.)



*To prevent possible over heating of the GPU, never block the fan vents.*



**Security Lock** An optional security cable attaches to this port in order to anchor your computer to a desk or other large object to deter theft.

## Left side

The following figure shows the computer's left side.

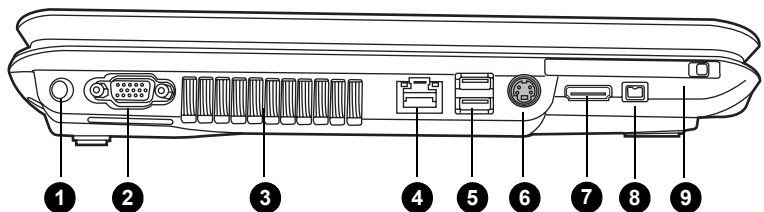

- |                                    |                             |
|------------------------------------|-----------------------------|
| 1. DC IN 19V Jack                  | 6. TV Out Port              |
| 2. RGB Monitor Port                | 7. HDMI Port                |
| 3. Fan Vents                       | 8. i.LINK (IEEE1394a) Port* |
| 4. Lan Jack                        | 9. Express Card Slot        |
| 5. Universal Serial Bus (USB) Port |                             |

\* The availability of this feature is dependent on the model you purchased.

*The left side of the computer*



**DC IN 19V Jack** The DC IN jack is where you plug in the AC adapter.



**RGB Monitor Port** This 15-pin port lets you connect an external video display to the computer.

**Fan Vents** The fan vents help prevent the CPU from overheating.





To prevent possible over heating of the CPU, never block the fan vents.



### LAN Jack

This jack lets you connect to a LAN. The adapter has built-in support for Ethernet LAN (10 megabits per second, 10BASE-T), Fast Ethernet LAN (100 megabits per second, 100BASE-TX) and Gigabit Ethernet LAN (1000 megabits per second, 1000BASE-T). Two indicators built into the jack let you see the LAN status.



### Universal Serial Bus (USB) Port

The Universal Serial Bus (USB 2.0 and 1.1 compatible) port enables USB-equipped devices such as keyboards, mice, hard drives, scanners, and printers to be connected to the computer.



### TV Out Port

Connect a 4-pin S- video cable into this connector in order to output either an NTSC or PAL television signal.



### HDMI Port

This port allows you to connect an HDMI device such as a Television.



### i.LINK (IEEE1394a) Port

This port allows you to connect an external device, such as a digital video camera, for high-speed data transfer.



### Express Card Slot

This slot allows you to insert an Express Card. An Express Card module is a small, modular add-in card technology based on PCI Express and Universal Serial Bus (USB) interface. The max. transmission rate at 2.5 Gbps. Both 34 mm type and 54 mm type are supported.

## Back side

The following figure shows the computer's back side.

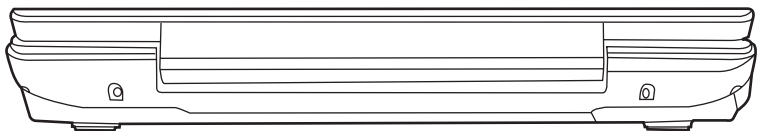

*The back side of the computer*

## Underside

The following figure shows the underside of the computer. Make sure the display is closed before turning over your computer.

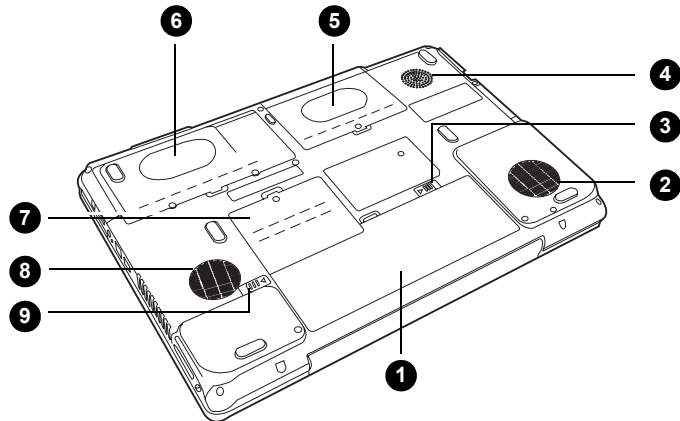

- |                      |                            |
|----------------------|----------------------------|
| 1. Battery Pack      | 6. HDD2*                   |
| 2. Fan Vent          | 7. Expansion Memory Socket |
| 3. Battery Pack Lock | 8. Fan Vent                |
| 4. Subwoofer         | 9. Battery Pack Latch      |
| 5. HDD1              |                            |

\* The availability of this feature is dependent on the model you purchased.

### *The bottom of the computer*

<b>Battery Pack</b>	The battery pack powers the computer when the AC adapter is not connected. For detailed information on the battery pack, refer to Chapter 7, <i>Power and Power-Up Modes</i> .
<b>Fan Vents</b>	The fan vents help prevent the CPU from overheating.
①  <b>Battery Pack Lock</b>	When you slide this into its locked position, the battery pack cannot be released even if you attempt to slide the battery pack latch into its open position.
<b>Subwoofer</b>	A subwoofer dedicate to the reproduction of bass frequencies.
<b>HDD1</b>	Hard Disk Drives store data, files and programs.
<b>HDD2*</b>	Hard Disk Drives store data, files and programs. (The availability of this function depends on the model you purchased.)



### Expansion Memory Socket

Use this socket to install a memory module to increase your computer's memory. Refer to the *Memory expansion* section in Chapter 9, *Optional Devices*.



To prevent possible overheating of the CPU, never block the fan vents.



### Battery Pack Latch

With the Battery Pack Lock in its unlocked position, you can slide this latch in order to remove the battery pack.

## Front with the display open

The following figure shows the front of the computer with the display open. To open the display, slide the latch on the front of the display and lift it up. Position the display at a comfortable viewing angle.

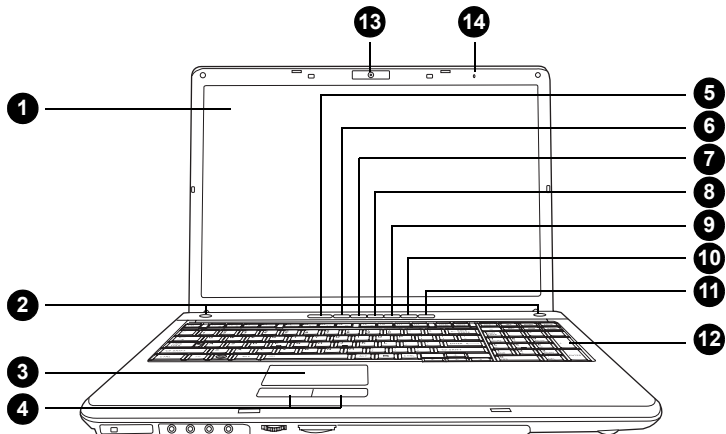

- |                             |                      |
|-----------------------------|----------------------|
| 1. Display Screen           | 9. Stop*             |
| 2. Left and Right Speakers  | 10. Previous Button* |
| 3. TouchPad                 | 11. Next Button*     |
| 4. TouchPad Control Buttons | 12. Number Pad       |
| 5. Power Button             | 13. Web Camera*      |
| 6. Internet Button*         | 14. Microphone*      |
| 7. CD/DVD Button*           |                      |
| 8. Play/Pause Button*       |                      |

\* The availability of this feature is dependent on the model you purchased.

*The front with the display open*

<b>Display Screen</b>	The LCD displays high-contrast text and graphics at a resolution up to 1440 × 900 pixels. Refer to Appendix B - <i>Display Modes</i> for further information. When the computer operates from the AC adapter, the display screen's image will be somewhat brighter than when it operates on battery power - this is normal and is designed to conserve battery power.
-----------------------	---



*To prolong the life of your display screen, use a screen saver when you're not using the computer and it is idle.*

<b>Left and Right Speakers</b>	The computer provides two speakers for stereo sound reproduction.
--------------------------------	---

<b>TouchPad</b>	The TouchPad pointing device is located in the centre of the palm rest and is used to control the on-screen pointer.
-----------------	--

<b>TouchPad Control Buttons</b>	Control buttons below the TouchPad let you select menu items or manipulate text and graphics designated by the on-screen pointer.
---------------------------------	---



<b>Power Button</b>	Press the power button to turn the computer's power on and off. There is an LED inside the power button which shines in blue (depending on the model you purchased) when the system is on.
---------------------	--



<b>Internet Button*</b>	Press this button to launch an Internet browser. If the computer's power is off, you can press this button to turn on the computer's power and launch the browser automatically in one step. (The availability of this function depends on the model you purchased.)
-------------------------	--



<b>CD/DVD Button*</b>	Pressing this button will launch an application program that allows for watching CD/DVD. An application that is launched differs by a model: Windows Media Player/DVD Video Player. (The availability of this function depends on the model you purchased.)
-----------------------	---



<b>Play/Pause Button*</b>	Press this button to begin playing an audio CD, a DVD movie or digital audio files. This button also acts as a Pause button. (The availability of this function depends on the model you purchased.)
---------------------------	--



<b>Stop*</b>	Stops playing the CD, DVD or digital audio. (The availability of this function depends on the model you purchased.)
--------------	---

**Previous Button\***

Skips backwards to the previous track, chapter or digital file. Refer to Chapter 4, *Operating Basics*, for details.

(The availability of this function depends on the model you purchased.)

**Next Button\***

Skips forward to the next track, chapter or digital file. Refer to Chapter 4, *Operating Basics*, for details.

(The availability of this function depends on the model you purchased.)



*If Random or Shuffle is selected in Windows® Media Player, selecting Next or Previous advances to a random selection.*

**Number Pad**

Press the Number Lock button to activate the number pad. Use the number pad instead of the number buttons on the keyboard to enter numbers and ASCII codes.

**Web Camera\***

Take your picture or send your image to web contacts.

(The availability of this function depends on the model you purchased.)

**Microphone\***

The Microphone is used with the Web Camera to talk to other Web Camera users and to record messages on windows media.

(The availability of this function depends on the model you purchased.)

## Keyboard Indicators



Numeric  
Mode



Caps Lock

**Numeric Mode**

You can use the numeric pad for numeric input when the Numeric mode icon lights green. Refer to the *Number Pad* section in Chapter 6, *The Keyboard*.

**Caps Lock**

The Caps Lock LED lights when you press the Caps Lock key. When this light is on, pressing a letter key on the keyboard produces an uppercase (capital) letter.

## Optical Disc drive

The computer will have a single layer or dual layer DVD Super Multi drive or HD DVD drive supporting  $\pm R$  Double Layer depending on its configuration. An ATAPI interface controller is used for the operation of these optical drives. When the computer is accessing a disc, an indicator on the drive glows.

### Region codes for DVD drives and media

The disc drive and its media are manufactured according to the specifications of six marketing regions. When you purchase DVD-Video, make sure it matches your drive, otherwise it will not play properly.

Code	Code
1	Canada, United States
2	Japan, Europe, South Africa, Middle East
3	Southeast Asia, East Asia
4	Australia, New Zealand, Pacific Islands, Central America, South America, Caribbean
5	Russia, Indian Subcontinent, Africa, North Korea, Mongolia
6	China

### Writable discs

This section describes the types of writable discs. Check the specifications for your drive to for the type of discs it can write. Use TOSHIBA Disc Creator to write compact discs. Refer to Chapter 4, *Operating Basics*.

#### CDs

- CD-R discs can be written only once. The recorded data cannot be erased or changed.
- CD-RW discs can be recorded more than once. Use either 1x, 2x, or 4x multi-speed CD-RW discs or high-speed 4x to 10x discs. The write speed of ultra-speed CD-RW discs is a maximum of 24x speed.

#### DVDs

- DVD-R and DVD+R discs can be written only once. The recorded data cannot be erased or changed.
- DVD-RW, DVD+RW and DVD-RAM discs can be recorded more than once.

## DVD Super Multi drive supporting $\pm$ R Double Layer

The full-size DVD Super Multi drive supporting  $\pm$ R Double Layer module lets you record data to rewritable discs as well as run either 12 cm (4.72") or 8 cm (3.15") discs without using an adapter.



*The read speed is slower at the centre of a disc and faster at the outer edge.*

<b>DVD read</b>	8 speed (maximum)
<b>DVD-R write</b>	8 speed (maximum)
<b>DVD-RW write</b>	6 speed (maximum)
<b>DVD+R write</b>	8 speed (maximum)
<b>DVD+RW write</b>	8 speed (maximum)
<b>DVD-RAM write</b>	5 speed (maximum)
<b>CD read</b>	24 speed (maximum)
<b>CD-R write</b>	24 speed (maximum)
<b>CD-RW write</b>	16 speed (maximum, Ultra-speed media)
<b>DVD+R (DL) write</b>	4 speed (maximum)
<b>DVD-R (DL) write</b>	4 speed (maximum)

This drive cannot use discs that allow writing faster than 8x speed or faster (DVD-R and DVD+R with Single Layer), 6x speed or faster (DVD-RW), 8x speed or faster (DVD+RW), 5x speed (DVD-RAM) or ultra-speed or faster (CD-RW).

## HD DVD-ROM drive

The HD DVD-ROM supporting  $\pm$ R Double Layer module lets you record data to rewritable discs as well as run either 12 cm (4.72") or 8 cm (3.15") discs without using an adapter.



*The read speed is slower at the centre of a disc and faster at the outer edge.*

<b>HD DVD read</b>	1 speed (maximum)
<b>DVD read</b>	8 speed (maximum)
<b>DVD-R write</b>	4 speed (maximum)
<b>DVD-RW write</b>	4 speed (maximum)
<b>DVD+R write</b>	4 speed (maximum)
<b>DVD+RW write</b>	4 speed (maximum)
<b>DVD-RAM write</b>	3 speed (maximum)
<b>CD read</b>	24 speed (maximum)
<b>CD-R write</b>	16 speed (maximum, Ultra-speed media)

<b>CD-RW write</b>	<i>10 speed (maximum)</i>
<b>DVD+R (DL) write</b>	<i>2.4 speed (maximum)</i>
<b>DVD-R (DL) write</b>	<i>2 speed (maximum)</i>

This drive cannot use discs that allow writing faster than 4x speed or faster (DVD-R and DVD+R with Single Layer), 4x speed or faster (DVD-RW and DVD+RW), 3x speed (DVD-RAM) or ultra-speed or faster (CD-RW).

## AC adapter

The AC adapter converts AC power to DC power and reduces the voltage supplied to the computer. It can automatically adjust to any voltage from 100 to 240 volts and to a frequency of either 50 or 60 hertz, enabling you to use the computer in almost any country/region.

To recharge the battery, simply connect the AC adapter to a power source and the computer. See Chapter 7, *Power and Power-Up Modes*, for details.

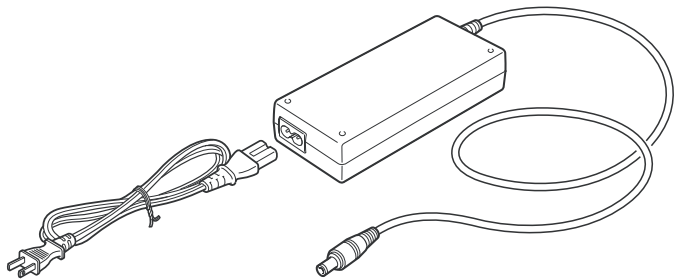

*The AC adapter*



*Use of the wrong adapter could damage your computer. TOSHIBA assumes no liability for any damage in such case. The output rating for the computer is 19 volts DC.*



*Please use only the AC Adapter supplied with the computer or an AC adapter certified by TOSHIBA.*



# Chapter 3

## Getting Started

This chapter provides basic information to get you started using your computer. It covers the following topics:



*Be sure also to read Instruction Manual for Safety & Comfort. This guide, which is included with the computer, explains product liability.*

- Connecting the AC adapter
- Opening the display
- Turning on the power
- Starting up for the first time
- Turning off the power
- Restarting the computer
- Restoring the pre-installed software from the Product Recovery media.



*All users should be sure to carefully read the section Starting up for the first time, which describes the actions to take when you turn on the power for the first time.*

## Connecting the AC adapter

Attach the AC adapter when you need to charge the battery or you want to operate from AC power. It is also the fastest way to get started, because the battery pack will need to be charged before you can operate from battery power. The AC adapter can be connected to any power source supplying from 100 to 240 volts and 50 or 60 hertz. For details on using the AC adapter to charge the battery pack, refer to Chapter 7, [Power and Power-Up Modes](#).



*Use of the wrong adapter could damage your computer. TOSHIBA assumes no liability for any damage in such case. The output rating for the computer is 19 volts DC.*

1. Connect the power cord to the AC adapter.

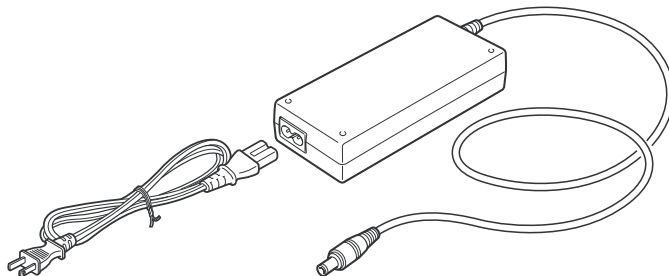

*Connecting the power cord to the AC adapter*

2. Connect the DC output plug on the AC adapter to the **DC IN** input port on the back of the computer.

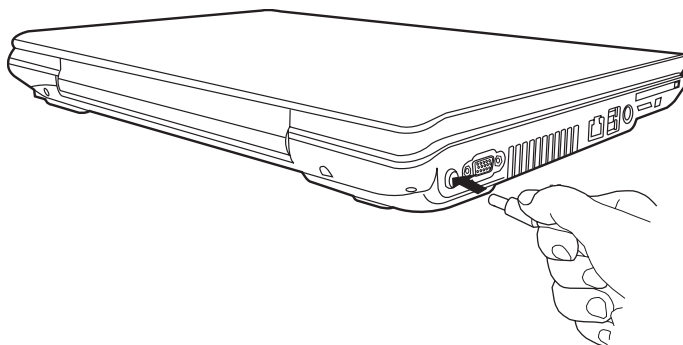

*Connecting the adapter to the computer*

3. Plug the power cord into a live wall outlet. The **Battery** and **DC IN** indicators on the front of the computer should glow.



*To disconnect AC adaptor, you can follow the reversed procedure of Connecting AC adaptor. Please hold the DC output plug portion by your fingers and then plug it out when you disconnect the DC output plug.*

## Opening the display

The display panel can be rotated in a wide range of angles for optimal viewing.

1. Slide the display latch on the front of the computer.

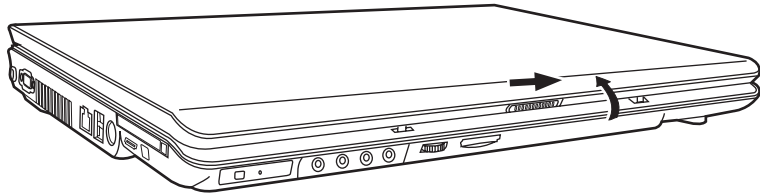

### Opening the display

2. Lift the panel up and adjust it to the best viewing angle for you.



*Use reasonable care when opening and closing the display panel. Opening it vigorously or slamming it shut could damage the computer.*

## Turning on the power

This section describes how to turn on the power.



*After you turn on the power for the first time, do not turn it off until you have set up the operating system. Refer to the section [Starting up for the first time](#) in this chapter.*

1. If a USB floppy disk drive is connected, make sure the drive is empty - if a disk is in the drive, press the eject button to remove it.
2. Open the display panel.
3. Press the computer's power button and then release it.

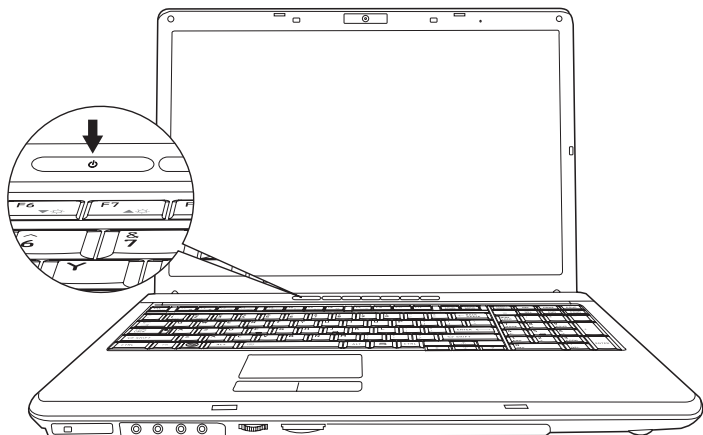

### Turning on the power

## Starting up for the first time

When you first turn on the power, the computer's initial screen is the Windows® Vista Startup Screen Logo. Follow the on-screen directions for each screen. During setup, you can click the **Back** button to return to the previous screen.

Be sure to read the **Windows® Operating System End User License Agreement** carefully.

## Turning off the power

The power can be turned off in one of three modes, either Shutdown (Boot Mode), Hibernation Mode or Sleep Mode.

### Shut Down mode (Boot mode)

When you turn off the power in Shut Down mode no data will be saved and the computer will boot to the operating system's main screen the next time it is turned on.

1. If you have entered data, either save it to the hard disk, drive or to other storage media.
2. Make sure all disk/disks activity has stopped before removing the CD/DVD or floppy diskette.



- *Make sure the **Hard Disk Drive** indicators is off. If you turn off the power while a disk (disks) is being accessed, you can lose data or damage the disk.*
- *Never turn off the power while an application is running. Doing so could cause loss data.*
- *Never turn off the power, disconnect an external storage device or remove storage media during data read/write. Doing so can cause data loss.*

3. Click **Start** then click the arrow button (  ) located in the power management buttons (  ) and select Shut Down from the menu.
4. Turn off any peripheral devices connected to your computer.



*Do not turn the computer or peripheral devices back on immediately - wait a short period to avoid and peripheral damage.*

### Sleep Mode

If you do have to interrupt your work, you are able to turn off the power without exiting from your software by placing the computer into Sleep Mode. In this mode data is maintained in the computer's main memory so that, when you turn on the power again, you can continue working right where you left off



- When the AC adaptor is connected, the computer will go into Sleep Mode according to the settings in the Power Options.
- To restore the operation from the computer from Sleep Mode, press the power button or press any key. Please be aware that this latter action only works on the internal keyboard if the. Wake-up on Keyboard option is enabled within the HW Setup utility.
- If the computer enters Sleep Mode while a network application is active, the application might not be restored when the computer is next turned on and the system returns from Sleep Mode.
- To prevent the computer from automatically entering Sleep Mode, disable Sleep Mode within the Power Options. However, please be aware that this configuration will nullify the computer's Energy Star compliance.



- Before entering Sleep Mode, be sure to save your data.
- Do not install or remove a memory module while the computer is in Sleep Mode. The Computer or the module could be damaged.
- Do not remove the battery pack while the computer is in Sleep Mode (unless the computer is connected to an AC power source). Data in memory will be lost.

### Benefits of Sleep Mode

The Sleep Mode feature provides the following benefits:



- Restore the previous working environment more rapidly than does the Hibernation Mode feature.
- Saves power by shutting down the system when the computer receives no input or hardware access for the time period set by the System Sleep Mode feature.
- Allows the use of the panel power off feature.

### Executing Sleep Mode



You can enter also Sleep Mode by pressing **Fn + F3** - please refer to Chapter 6, *The Keyboard*, for further details.

You can enter Sleep Mode in one of three ways:

1. Click **Start** then click the sleep button (  ) located in the power management buttons (  ), or click the arrow button (  ) and select Sleep from the menu.
2. Close the computer's LCD display panel. Please note that this feature must be enabled - please refer to the Power Options (to access it, click **Start → Control Panel → System and Maintenance → Power Options**).

3. Press the power button. Please note that this feature must be enabled - please refer to the Power Options (to access it, click **Start** → **Control Panel** → **System and Maintenance** → **Power Options** → **Choose what the power button do**).

When you turn the power back on, you can continue where you left when you shutdown the computer.



- *When the computer is in Sleep Mode, the power indicator will blink orange.*
- *If you are operating the computer on battery power, you can lengthen the overall operating time by turning it off into Hibernation Mode - Sleep Mode will consume more power while the computer is off.*

### **Sleep Mode limitations**

Sleep Mode will not function under the following conditions:

- Power is turned back on immediately after shutting down.
- Memory circuits are exposed to static electricity or electrical noise.

### **Hibernation mode**

The Hibernation Mode feature saves the contents of memory to the hard disk drive when the computer is turned off so that, the next time it is turned on, the previous state is restored. Please note that the Hibernation Mode feature does not save the status of any peripheral devices connected to the computer.



- *Save your data. While entering Hibernation Mode, the computer saves the contents of memory to the hard disk drive. However, for safety sake, it is best to save your data manually.*
- *Data will be lost if you remove the battery or disconnect the AC adaptor before the save is completed. Wait for the **Hard Disk Drive** indicator to go out.*
- *Do not install or remove a memory module while the computer is in Hibernation Mode. Data will be lost.*

### **Benefits of Hibernation Mode**



The Hibernation Mode feature provides the following benefits:

- Saves Data to the hard disk drive when the computer automatically shutdown because of a low battery condition.
- You can return to your previous working environment immediately when you turn on the computer.
- Saves power by shutting down the system when the computer receives no input or hardware access for the time period set by the System Hibernate feature.
- Allows the use of the panel power off feature.

## Starting Hibernation Mode

You can also enable Hibernation Mode by pressing **Fn + F4** - please refer to Chapter 6, *The Keyboard*, for further details.

To enter Hibernation Mode, follow the steps below.

1. Click **Start**.
2. Click the arrow button (  ) in the power management buttons (  ).
3. Select Hibernate from the menu.

## Automatic Hibernation Mode

The computer can be configured to enter Hibernate Mode automatically when you press the power button or close the lid. In order to define these settings, you can follow the steps as described below:

1. Click **Start** and click the **Control Panel**.
2. Click **System and Maintenance** and click **Power Options**.
3. Click **Choose what the Power Button do or Choose what closing the lid does**.
4. Enable the desired Hibernation Mode settings for **When I press the power button** or **When I close the lid**.
5. Click the **Save Changes** button.

## Data save in Hibernation Mode

When you turn off the power in Hibernation Mode, the computer takes a moment to save the current data in memory to the hard disk drive. During this time, the **Hard Disk Drive** indicator will glow.

After you turn off the computer, and the content of memory has been saved to the hard disk drive, turn off the power to any peripheral devices.





*Do not turn the computer or devices back on immediately. Wait a moment to let all capacitors fully discharge.*

## Restarting the computer

Certain conditions require that you reset the computer, for example if:

- You change certain computer settings.
- An errors and the computer does not respond you your keyboard commands.

If you need to restart the computer, there are three ways this can be achieved:

1. Click **Start** then click the arrow button (  ) in the power management buttons (  ) and select Restart from the menu.
2. Press **Ctrl + Alt + Del** to display the menu window, then select Restart from the Shutdown options.
3. Press the power button and hold it down for five seconds. Once the computer has turned itself off, wait between ten and fifteen seconds before turning the power on again by pressing the power button.

## System Recovery Options

About 1.5 GB hidden partition is allocated on the hard disk drive for the System Recovery Options. This partition stores files which can be used to repair the system in the event of a problem.



*The System Recovery Options feature will be unusable if this partition is deleted.*

### System Recovery Options

The System Recovery Options feature is installed on the hard disk when shipped from the factory. In the event that an error occurs between the time power is turned ON and login, and the error is repairable, the Windows Recovery Enviroment will automatically repair the error.

The Window Recovery Environment can also be run manually to repair errors.

The procedure is as follows. Follow the instructions shown on the on-screen menu.

1. Turn off the computer.
2. While holding the **F8** key, turn the computer again.
3. The **Advanced Boot Options** menu will be displayed.  
Use the arrow keys to select **Repair Your Computer** and press **Enter**.
4. Follow the on-screen instructions.



*The Windows Vista™ Complete PC Backup feature can be used on Windows Vista™ Business Edition and Ultimate Edition.*



## Restoring the pre-installed software from the Product Recovery disc

If preinstalled files are damaged, use the Product Recovery disc to restore them. To restore the operating system and all preinstalled software, follow the steps below.



*When you reinstall the Windows operating system, the hard disk will be reformatted and all data will be lost. You can not use System Recovery Options if restoring the pre-installed software without System Recovery options.*

1. Load the Product Recovery disc in the drive and turn off the computer's power.
2. Switch on the computer and, when the **In Touch with Tomorrow TOSHIBA** prompt appears, press the **F12** key to display the Boot Menu. For 2HDD Model, If HDD1 is first, go to step 3. If HDD1 is not first, do as follows:
  - Select <Enter Setup>
  - Press the **F9** key to set to default settings, and select the [Yes].
  - When the "In Touch with Tomorrow TOSHIBA "prompt appears, press the **F12** key to display the Boot menu. Continue with step 3.
3. Use the up or down cursor key to select the CD-ROM/DVD drive in the display menu.
4. Follow the on-screen instructions.
5. If your computer came with additional software installed, this software can not be recovered from the Product Recovery disk. Re-install these applications (e.g. Works Suite, DVD Player, Games, etc.) separately from other media.

# Chapter 4

## Operating Basics

This chapter gives information on basic operations including using the TouchPad, optical disc drives, the internal modem, LAN and wireless LAN. It also provides tips on caring for your computer and on heat dispersal.

### Using the TouchPad

To use the TouchPad, simply move your finger tip across it in the direction you want the on-screen pointer to go.

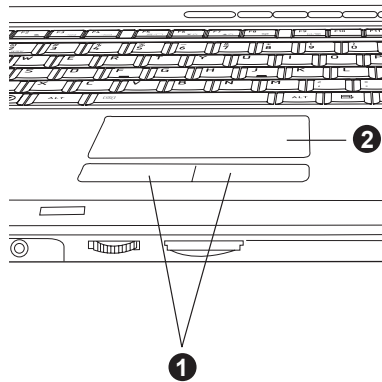

1. TouchPad control buttons
2. TouchPad/Dual Mode Pad

#### *TouchPad and control buttons*

The two buttons below the TouchPad are used like the buttons on a standard mouse.

Press the left button to select a menu item or to manipulate text or graphics designated by the pointer. Press the right button to display a menu or other function depending on the software you are using.



*Do not press on the TouchPad too hard or press a sharp object such as a ball point pen against it. The TouchPad could be damaged.*

The TouchPad has similar functions to a two-button mouse with a scroll wheel. For some functions, you can tap it instead of pressing a button.



You can customize pointing device actions in Mouse Properties. Open the Control Panel, select the Mouse icon and press Enter to open the Mouse Properties window.

**Click:** Click the left control button or tap the TouchPad once.

**Double-click:** Click the left control button twice or tap the TouchPad twice.

**Scroll** **Vertical:** Move your finger up or down the right edge of the TouchPad.

**Horizontal:** Move your finger left or right along the bottom edge of the TouchPad.

## Using the Web Camera

This section describes the bundled Web Camera utility, which can Snapshot and video images. The Web Camera will auto-run when Windows starts.

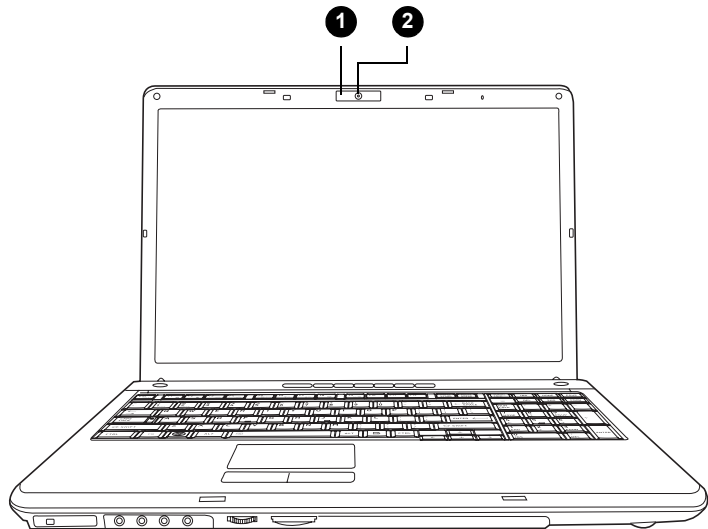

1. Web Camera Led

2. Web Camera Lens

## Using the software

The Web Camera software is pre-configured to start when you turn on Windows Vista; if you need to restart it go to **Start → Programs → Camera Assistant Software → Camera Assistant Software**.

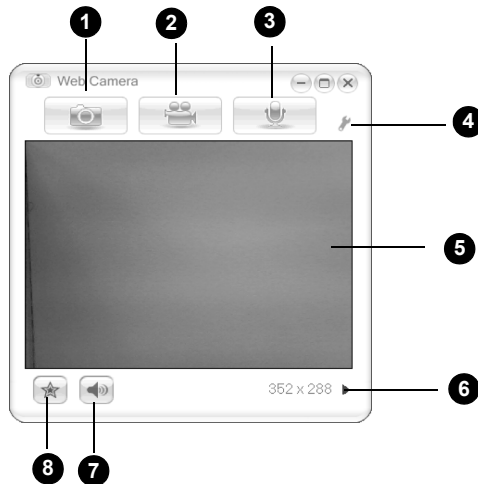

- |                         |                      |
|-------------------------|----------------------|
| 1. Capture still images | 5. Display Window    |
| 2. Video Recording      | 6. Camera Resolution |
| 3. Audio Recording      | 7. Mute              |
| 4. Function             | 8. Effects           |

<b>Snapshot</b>	Click to see a preview of the Snapshot image; you can also e-mail the image.
<b>Video Recording</b>	Click to start recording, click again to stop recording and see a preview of the video.
<b>Audio Recording</b>	Click to start recording, click again to stop and listen to a preview of the audio.
<b>Functions</b>	Access additional functions: About, Player, Effects, Properties, Settings and Help.
<b>About</b>	Displays software manufacturer details.
<b>Player</b>	Play video files.
<b>Effects</b>	Choose images to be displayed on the capture screen.
<b>Properties</b>	Choose from the Options tab to flip, zoom, flicker rate, night mode and backlight compensation; in the Image tab change the colour settings; in the profile tab change the lighting conditions.

<b>Settings</b>	Choose from the: <b>Options</b> tab to change the tool position; the <b>Picture</b> tab to select picture output options such as size, export file and saving location; the <b>Video</b> tab to choose output settings such as Frame Rate, Size, Compression and the file save path; the <b>Audio</b> tab to change the Audio Device, Compression, Volume and file save path.
<b>Help</b>	Displays the help files for the software.

## Using the internal modem

This section describes how to setup the modem and use it to connect to other computer systems. Refer to the computer's online help files and the online help files for your modem software, for more information.



*The internal modem does not support the voice functions described in the help files. All data and fax functions are supported.*



- *In case of a lightning storm, unplug the modem cable from the telephone jack.*
- *Do not connect the modem to a digital telephone line. A digital line will damage the modem.*

## IMPORTANT SAFETY INSTRUCTIONS



*When using your telephone equipment, basic safety precautions should always be followed to reduce the risk of fire, electric shock and injury to persons, including the following:*

- 1. Do not use this product near water, for example, near a bathtub, wash bowl, kitchen sink or laundry tub, in a wet basement or near a swimming pool.*
- 2. Avoid using a telephone (other than a cordless type) during an electrical storm. There may be a remote risk of electric shock from lightning.*
- 3. Do not use the telephone to report a gas leak in the vicinity of the leak.*
- 4. Use only the power cord indicated in this manual.*

## Region selection

Telecommunication regulations vary from one country/region to another, so you will need to make sure the internal modem's settings are correct for the country/region in which it will be used.

1. Open the Modem Region Select application. It is located on the Programs menu at **TOSHIBA → Networking → Modem Region Select**.



*Do not use the Country/Region Select function in the Modem setup utility in the Control Panel if the function is available. If you change the Country/Region in the Control Panel, the change may not take effect.*

2. The Region Selection icon appears on the Windows Task Bar.



*The Region Selection icon*

3. Click the icon with the primary mouse button to display a list of regions that the modem supports. A sub menu for telephony location information will also be displayed. A check will appear next to the currently selected region and telephony location.
4. Select a region from the region menu or a telephony location from the submenu.
  - When you click a region it becomes the modem's region selection, and the New Location for telephony will be set automatically.
  - When you select a telephony location, the corresponding region is automatically selected and it becomes the modem's current region setting.

## Properties menu

Click the icon with the secondary mouse button to display the following menu.

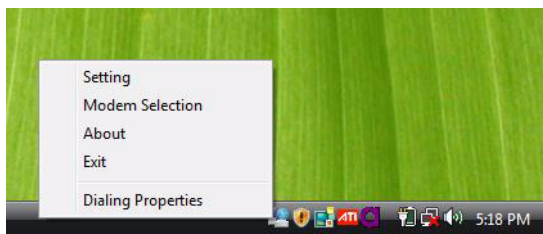

*The properties menu*

## Settings

You can enable or disable the following settings:

### **AutoRun Mode**

Region Select Utility starts automatically when you start up the operating system.

### **Open the Dialling Properties dialogue box after selecting region**

The dialling properties dialogue box will be displayed automatically after you select the region.

### **Location list for region selection**

A submenu appears displaying location information for telephony.

### **Open dialogue box, if the modem and Telephony Current Location region code do not match**

A warning dialogue box is displayed if current settings for region code and telephony location are incorrect.

## Modem Selection

If the computer cannot recognize the internal modem, a dialogue box is displayed. Select the COM port for your modem to use.

## Dialling Properties

Select this item to display the dialling properties.



*If you are using the computer in Japan, technical regulations described in the Telecommunications Business Law require that you select Japan region mode. It is illegal to use the modem in Japan with any other selection.*

## Connecting

To connect the internal modem cable, follow the steps below.



- *In case of a lightning storm, unplug the modem cable from the telephone jack.*
- *Do not connect the modem to a digital telephone line. A digital line will damage the modem.*

1. Plug one end of the modular cable into the modem jack.
2. Plug the other end of the modular cable into a telephone jack

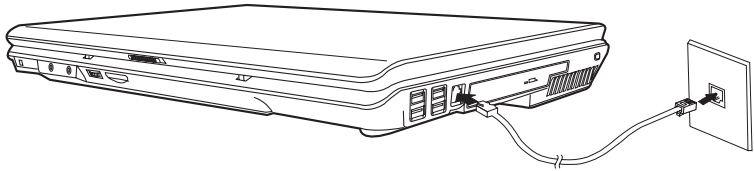

*Connecting the internal modem*



*Do not pull on the cable or move the computer while the cable is connected.*



*If you find that the modem speed is low or communication is interrupted when you are using the modem, please set the CPU speed to Maximum within the TOSHIBA Power Saver utility.*

## Disconnecting

To disconnect the internal modem cable, follow the steps below.

1. Pinch the lever on the connector in the telephone jack and pull out the connector.
2. Disconnect the cable from the computer in the same manner.

## LAN

The computer is equipped with networking hardware that supports Ethernet LAN (10 megabits per second, 10BASE-T) or Fast Ethernet LAN (100 megabits per second, 100BASE-T).



*Do not install or remove an optional memory module while the Wake-up on LAN feature is enabled.*



*The Wake-up on LAN feature does not work on battery power. In Hibernate/Power off mode you should always leave the computer connected to the AC adapter if you are using this feature.*

## Connecting the LAN cable



*The computer must be configured properly before connecting to a LAN. Logging onto a LAN using the computer's default settings could cause a malfunction in LAN operation. Check with your LAN administrator regarding set-up procedures.*

If you are using Ethernet LAN (10 megabits per second, 10BASE-T), you can connect using either a CAT5 or a CAT3 cable.

If you are using 100BASE-TX Fast Ethernet you must connect using a CAT5 cable.



To connect the LAN cable, follow the steps below.

1. Turn off the power to the computer and to all external devices connected to the computer.
2. Plug one end of the cable into the LAN jack. Press gently until you hear the latch click into place.

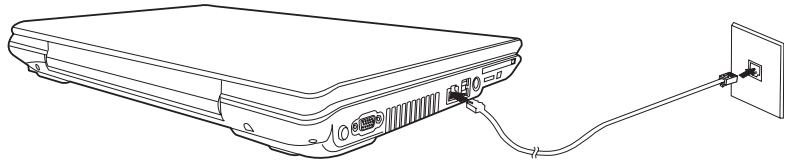

*Connecting the LAN cable*

3. Plug the other end of the cable into a LAN hub connector. Check with your LAN administrator before connecting to a hub.

## Disconnecting the LAN cable

To disconnect the LAN cable, follow the steps below.

1. Pinch the lever on the connector in the computer's LAN jack and pull out the connector.
2. Disconnect the cable from the LAN hub in the same manner. Check with your LAN administrator before disconnecting from the hub.

## Wireless LAN

The wireless LAN is compatible with other LAN systems that comply with the IEEE802.11a, 11b, 11g and Draft 11n wireless LAN standards.

It supports the following:

- Automatic Transmit Rate Select mechanism in the transmit range of 54, 48, 36, 24, 18, 9, 6 Mbps for 802.11a/b/g and 802.11b/g wireless LAN module.
- Advanced Encryption Standard (AES) data encryption, based on 256 bit encryption algorithm.



*Wake-up on Wireless LAN is supported on certain Wireless LAN model from Sleep/Hibernate mode in AC adaptor mode.  
(depending on the model you purchased.)*

- Frequency Channel Selection (5 GHz and 2.4 GHz)
- Roaming over multiple channels
- Card Power Management
- Wi-Fi Protected Access (WPA) data encryption



11a, 11b, 11g and 11n wireless are based on IEEE 802.11a, 802.11b, 802.11g and 802.11n respectively. The IEEE 802.11n specification has not been finalized and is currently in draft release. The TOSHIBA 11a/b/g/n Wireless LAN Adapters are based on the Draft Release, Version 1.0, of the IEEE 802.11n specification. An Adapter with 11a/b, 11a/b/g or 11a/b/g/n can communicate on any of its supported formats; the actual connection will be based on the access point to which it connects.

Connection compatibility with the wireless equipment in Draft 11n mode is not guaranteed.

The Draft 11n function cannot be used with WEP/TKIP. Draft 11n mode can be used only with WPA-PSK (AES) mode or no security mode.

## Security

1. TOSHIBA strongly recommends that you enable the WPA encryption function otherwise your computer could be left open to illicit access via the wireless LAN connection which may result in an intrusion that can lead to the theft or loss of stored data among other things. In addition, the owner of an Internet connection is responsible for all browsing, downloading, and uploading activities on that connection. Therefore, an unsecured wireless network connected directly to the Internet is an open invitation for outsiders to abuse your ISP account and privileges.
2. TOSHIBA is not liable for the eavesdropping on your data due to the use of the wireless LAN connection and any damage that may occur thereof.

## Bluetooth wireless technology

Bluetooth<sup>®</sup> wireless technology eliminates the need for cables between electronic devices such as desktop computers, printers and mobile phones. Bluetooth wireless technology has the following features:

### Worldwide operation

The Bluetooth radio transmitter and receiver operate in the 2.4 GHz band, which is license-free and compatible with radio systems in most countries in the world.

### Radio links

You can easily establish links between two or more devices. The link is maintained even if the devices are not within line of sight.

### Security

Two advanced security mechanisms ensure a high level of security:

- Authentication prevents access to critical data and makes it impossible to falsify the origin of a message.
- Encryption prevents eavesdropping and maintains link privacy.

## Bluetooth® Stack for Windows® by TOSHIBA

Please note that this software is specifically designed for the following operating systems:

- Microsoft® Windows Vista™

Detailed information regarding the use with these operating systems is listed below. Please refer also to the electronic information which is included with each software.



*This Bluetooth® Stack is based on Bluetooth® Version 1.1/1.2/2.0+EDR specification. TOSHIBA cannot confirm compatibility between any PC products and/or other electronic devices that use Bluetooth™ other than TOSHIBA mobile PCs.*

### Release Notes related to the Bluetooth® Stack for Windows® by TOSHIBA

1. Fax application software:

Regarding FAX application software, there are some software that you cannot use on this Bluetooth® Stack.

2. Multi User:

On Windows Vista, the use of Bluetooth is not supported in a multi-user environment. This means that, when you use Bluetooth, other users logged onto the same computer will not be able to use its Bluetooth functionality.

### Product Support:

The latest information regarding Operating System support, Language Support or available upgrades can be found on our web site <http://www.toshiba-europe.com/computers/tnt/bluetooth.htm> in Europe.

## Wireless communications



*It may not be possible to make a network connection to a specified network name using the ad hoc network function. If this occurs, the new network(\*) will have to be configured for all computers connected to the same network in order to re-enable network connections.*

*\* Please be sure to use new network name.*

## Wireless communication switch

You can enable or disable the Wireless devices function with the on/off switch. No transmissions are sent or received when the switch is off. Slide the switch forward to turn it on and backward to turn it off.



*Turn the switch off in airplanes and hospitals. Check the LED, it stops glowing when the wireless communication function is off.*

## Wireless communication LED

The LED indicates the status of the wireless communication functions.

LED status	Indication
LED off	Wireless communication switch is set to off.
LED glows	Wireless communication switch is on.

## Using optical disc drives

The illustrations in this section might differ slightly from your drive, but operation is the same for all optical disc drives. The full-size drive provides high-performance execution of disc-based programs. You can run either 12 cm (4.72") or 8 cm (3.15") discs without an adapter. An ATAPI interface controller is used for disc drive operation. When the computer is accessing a disc, an indicator on the drive illuminates.



*Use the DVD Video Player to view DVD-Video discs.*

If you have a DVD Super Multi drive or HD DVD drive, refer also to the Writing CD/DVDs on DVD Super Multi drive section or HD DVD section for precautions on writing to CDs.

## Loading optical disc media

To load a disc, follow the steps below.

1. Turn on the power.
2. a. Press the eject button to open the drawer slightly.

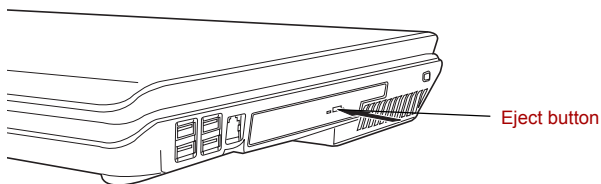

### *Pressing the eject button*

- b. Pressing the eject button will not open the drawer when the computer's power is off. If the power is off, you can open the drawer by inserting a slender object (about 15 mm) such as a straightened paper clip into the eject hole just to the right of the eject button.

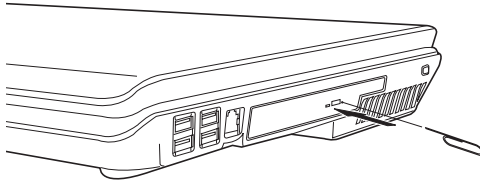

*Manual release with the eject hole*

3. Grasp the drawer gently and pull until it is fully open.

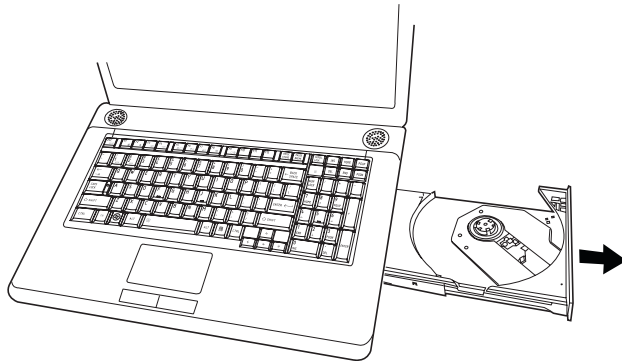

*Pulling the drawer open*

4. Lay the disc, label side up, in the drawer.

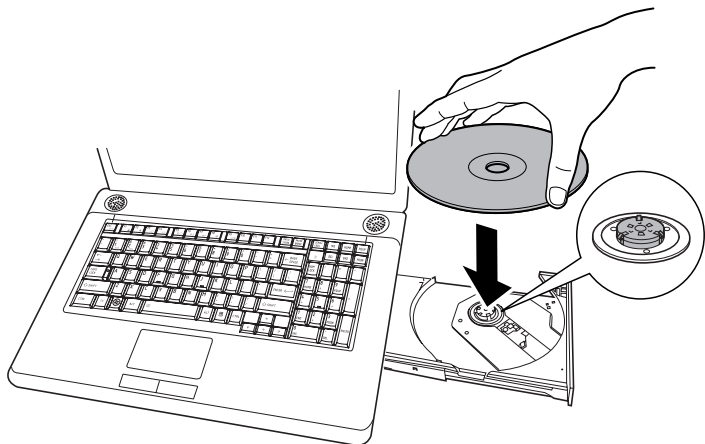

*Inserting a disc*



*Be careful not to touch the lens or the area around it. Doing so could cause the drive to malfunction.*

5. Press gently at the centre of the disc until you feel it click into place. The disc should lie below the top of the spindle, flush with its base.
6. Push the centre of the drawer to close it. Press gently until it locks in place.



*If the disc is not seated properly when the drawer is closed, it might be damaged. Also, the drawer might not open fully when you press the eject button.*

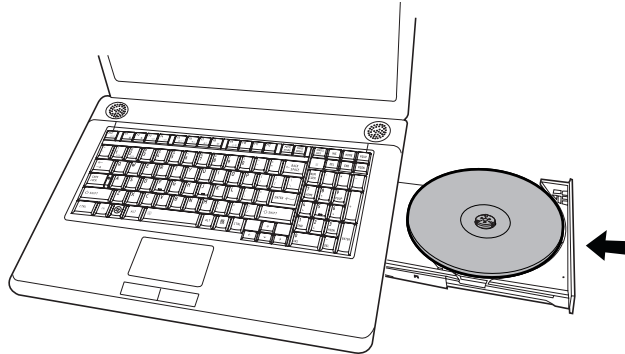

*Closing the drive drawer*

## Removing optical disc media

To remove the disc, follow the steps below.



*Do not press the eject button while the computer is accessing the disc drive. Wait for the **optical disc** indicator to go out before you open the drawer. Also, if the disc is spinning when you open it, wait for it to stop before you remove it.*

1. To pop the drawer partially open, press the eject button. Gently pull the drawer out until it is fully opened.



- *When the drawer pops open slightly, wait a moment to make sure the disc has stopped spinning before pulling the drawer fully open.*
- *Turn off the power before you use the eject hole. If the disc is spinning when you open the drawer, it could fly off the spindle and cause injury.*

2. The disc extends slightly over the sides of the drawer so you can grasp it. Hold it gently and lift it out.

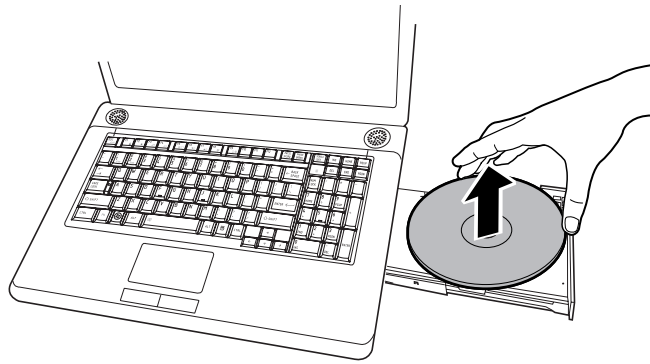

*Removing a disc*

3. Push the centre of the drawer to close it. Press gently until it locks into place.

## Buttons

The Internet button and the CD/DVD button can be assigned functions and applications in the TOSHIBA Controls Properties.

1. Move mouse cursor and reach the top of desktop screen. The back cards and white cards appear. Click "Button support" white card.
2. "Button Support" white card fully appears. After double click this card, the dialog for changing button function is displayed.
3. Change function of Buttons. Or you can go to:
  1. **Start → All programs → TOSHIBA → Utilities → Toshiba Assist.**
  2. Choose optimize from left panel then select **TOSHIBA Button Controls**.

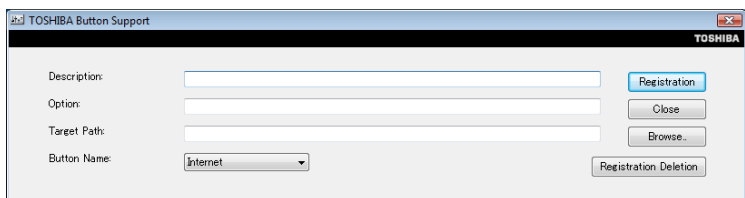

*TOSHIBA Button Support*

## CD/DVD play control buttons

In addition to the power button, the following four buttons control functions relating to the playback of optical media and digital audio data:

<b>Play/Pause</b>	Starts or pauses play
<b>Stop</b>	Stops play
<b>Next</b>	Advances to the next track, chapter or data
<b>Previous</b>	Returns to the previous track, chapter or data



*If Random or Shuffle is selected in Windows Media Player, selecting Next or Previous advances to a random selection.*

## TOSHIBA Disc Creator

Note the following limitations when you use TOSHIBA Disc Creator:

- DVD-Video cannot be created using TOSHIBA Disc Creator.
- DVD-Audio cannot be created using TOSHIBA Disc Creator.
- You cannot use the TOSHIBA Disc Creator "Audio CD" function to record music to the DVD-R/-RW or DVD+R/+RW media.
- Do not use the "Disc Backup" function of TOSHIBA Disc Creator to copy DVD-Video and DVD-ROM with copyright protection.
- DVD-RAM media cannot be backed up with the "Disc Backup" function of TOSHIBA Disc Creator.
- You cannot back up a CD-ROM or CD-R/RW to DVD-R/-RW or DVD+R/+RW using the "Disc Backup" function of TOSHIBA Disc Creator.
- You cannot back up DVD-ROM, DVD-Video or DVD-R/-RW or DVD+R/+RW to CD-R/RW using TOSHIBA Disc Creator.
- TOSHIBA Disc Creator cannot record in packet format.
- You might not be able to use the "Disc Backup" function of TOSHIBA Disc Creator to backup a DVD-R/-RW or DVD+R/+RW disc that was made with other software on a different DVD-R/-RW or DVD+R/+RW recorder.
- If you add data to a DVD-R and DVD+R disc that you have already recorded to, you might not be able to read the added data under some circumstances. It cannot be read in 16-bit operating systems, such as Windows 98SE and Windows ME, in Windows NT4 you will need Service Pack 6 or later to read the data, and in Windows 2000 you will need Service Pack 2 or later to read it. Some optical media drives cannot read added data regardless of the operating system.
- TOSHIBA Disc Creator does not support recording to DVD-RAM discs. To record to a DVD-RAM, use Explorer or other similar utility.
- When you back up a DVD disc, be sure the source drive supports recording to DVD-R/-RW or DVD+R/+RW discs. If the source drive does not support recording to DVD-R/-RW or DVD+R/+RW discs, it might not be backed up correctly.



- When you back up a DVD-R, DVD-RW, DVD+R or DVD+RW, be sure to use the same type of disc.
- You cannot partially delete any data written to a CD-RW, DVD-RW or DVD+RW disc.

## Data Verification

To verify that data is written or rewritten correctly, follow the steps below before you write or rewrite a Data CD/DVD.

1. Display the setting dialog box by one of the following two steps:
  - Click the setting button (  ) for writing on the main toolbar in the **Data CD/DVD** mode.
  - Select **Setting for writing** → **Data CD/DVD** in the **Setting** menu.
2. Mark the **Verify written data** check box.
3. Select **File Open** or **Full Compare** mode.
4. Click the **OK** button.

## Media Care

This section provides tips on protecting data stored on your discs and disks.

Handle your media with care. The following simple precautions will increase the lifetime of your media and protect the data stored on it:

1. Store your discs in the container they came in to protect them and keep them clean.
2. Do not bend the disc.
3. Do not write on, apply a sticker to, or otherwise mar the surface of the disc that contains data.
4. Hold the disc by its outside edge or the edge on the center hole. Fingerprints on the surface can prevent the drive from properly reading data.
5. Do not expose to direct sunlight, or extreme heat or cold, and do not place heavy objects on your discs.
6. If your discs become dusty or dirty, wipe them with a clean dry cloth. Wipe from the center out, do not wipe in a circular direction around the disc. If necessary, use a cloth dampened in water or a neutral cleaner. Do not use benzine, thinner or similar cleaner.

## Discs

1. Store your disks in the container they came in to protect them and keep them clean. If a disk is dirty, do not use cleaning fluid. Clean it with a soft damp cloth.
2. Do not slide back the disk's protective metal covering or touch the disk's magnetic surface. Fingerprints may prevent the disk drive from reading data from the disk.
3. Data may be lost if the disk is twisted, bent, or exposed to direct sunlight, or extreme heat or cold.
4. Do not place heavy objects on your disks.
5. Do not eat, smoke, or use erasers near your disks. Foreign particles inside the disk's jacket can damage the magnetic surface.
6. Magnetic energy can destroy data on disks. Keep your disks away from speakers, radios, television sets and other sources of magnetic fields.

## TV-Out & HDMI

Use the TV-Out port to connect to a television. Be sure to use a 4 pin type S-video cable. Use the HDMI port to connect to an HDTV. For more details, see Appendix B.

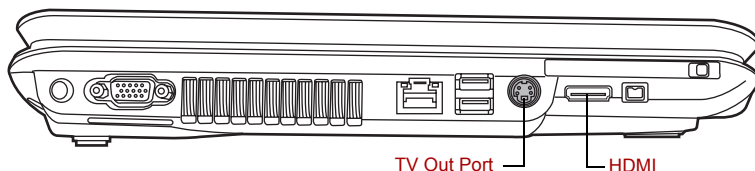

## Setting up more than one display

You can set up your computer to utilize more than one display, effectively spreading a single desktop screen across two monitors.

The Display settings window allows you to adjust more precisely the relative positioning of the two displays when they are configured as an extended desktop. On the Display Settings window, the two displays can be positioned horizontally, vertically or in any diagonal configuration you wish, as shown below.

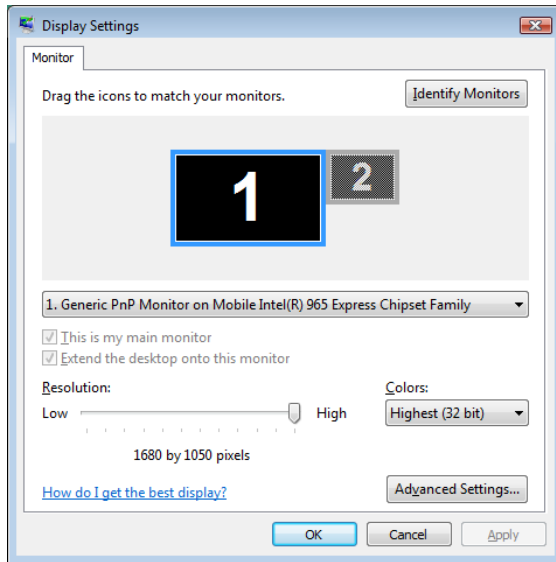

*If an external display will not be connected next time you use your computer, you should cancel any extended desktop or clone display settings before shutting down your computer.*

*Clone display settings are those where more than one device has been selected and is simultaneously applicable.*

## Cleaning the computer

To help ensure long, trouble-free operation, keep the computer free of dust and use care with liquids around the computer.

- Be careful not to spill liquids into the computer. If the computer does get wet, turn the power off immediately and let the computer dry completely before you turn it on again.
- Clean the computer using a slightly damp (with water) cloth. You can use glass cleaner on the display. Spray a small amount of cleaner on a soft, clean cloth and wipe the screen gently with the cloth.



*Never spray cleaner directly onto the computer or let liquid run into any part of it. Never use harsh or caustic chemical products to clean the computer.*

## Moving the computer

The computer is designed for rugged durability. However, a few simple precautions taken when moving the computer will help ensure trouble-free operation.

- Make sure all disk activity has ended before moving the computer. Check the **Built-in Hard Disk Drive** and **optical disc drive** indicators on the computer.
- If a disk is in the disk drive, remove it.
- If a disc is in the optical disc drive, remove it. Also make sure the optical disc drive drawer is securely closed.
- Turn off the power to the computer.
- Disconnect all peripherals before moving the computer.
- Close the display. Do not pick up the computer by its display panel or back (where the interface ports are located).
- Disconnect the AC adapter if it is connected.
- Use the carrying case when transporting the computer.

# Chapter 5

## About the HD DVD

This chapter describes the features, use of HD DVD and HD DVD Media. HD DVD is provided with some models.

### Summary

HD DVD allows users to enjoy video, concerts and other packaged content by taking advantage of its large amount of storage space and high-quality audio and video. HD DVD also allows for the storage of long video when combined with the latest video compression technologies.

The storage capacity and data transfer rate of HD DVD is superior to standard DVD, with two types of playback-only discs in single-sided single-layer 15 GB and single-sided dual-layer 30 GB (Gigabyte) formats.



1. *Unfinalized DVDs created on home DVD recorders may not be playable on the computer.*
2. *When inserting an unfinalized DVD-R DL disc into the computer, Windows Vista™ may automatically finalize the disc and prevent further writing.*

### Important information on use

- Because HD DVD is a new format there is a possibility of new features being added at a later date. As such, it is important that the purchaser understands that software and other updates may be necessary after purchase. Please be sure to complete user registration in order to receive timely product updates.
- This product can play existing DVD and CD formats, however, playback may not be possible with some software. This product cannot play Blu-ray DISC™ format software.

- HD DVD is a new standard which makes use of new technologies. As such, there is a possibility of problems occurring related to connection, compatibility or operation with some discs and other digital devices. The HD DVD-ROM logo signifies that this drive complies with the HD DVD physical standard, and does not signify compliance with the HD DVD Video standard. This device does not support advanced features of the HD DVD Video standard as defined by the DVD Forum, including picture-in-picture and network download features. Screen movement may not be smooth, and performance may be lowered with some HD DVD content.
- Playback of high bit rate content may cause frame dropping, audio skipping or decrease in computer performance.
- Viewing of HD DVD content on an external display requires an HDCP capable HDMI™ or DVI input on the external display.
- Make sure to connect the computer's AC adaptor when playing an HD DVD.
- CPU power is concentrated on HD DVD playback when playing an HD DVD, so make sure to exit all other applications.
- Dolby Digital audio enhancements are only supported by Microsoft® Windows operating system. Content with high sample rates of 48 kHz or more are downsampled when output through either the built-in speakers or headphone jack.
- This device supports AACS (Advanced Access Content System) next-generation copy protection technology. Renewal of the AACS key integrated into this device is required for uninterrupted enjoyment of HD DVD. An Internet connection is required when renewing the key.
- For more information on AACS keys, visit the AACS website (<http://www.aacsla.com/home>).

## HD DVD Media

- Like CD and DVD, HD DVD is divided into the read-only and recordable formats listed below.
- Some media cannot be used with this product. Be sure to thoroughly read section *DVD Super Multi drive supporting ±R Double Layer, HD DVD-ROM drive* or HD DVD-R drive of chapter 2 before using this product.
- HD DVD-Video: For video playback. Used to store movies and other video.
- HD DVD-ROM: Read-only media.
- HD DVD-R: A recordable media which can be written to only once.
- HD DVD (Twin format disc): Has both HD DVD and DVD recordable layers.

## Media Structures and Capacity

HD DVD		
Recordable Surface	Recordable Layer Structure	Capacity
Single-sided Single-Layer	HD DVD Recordable Layer Only	15 GB
Single-sided Dual-Layer	HD DVD Recordable Layer Only	30 GB
Double-sided Single-Layer	HD DVD Recordable Layer Only	30 GB
Double-sided Dual-Layer	HD DVD Recordable Layer Only	60 GB
HD DVD (Twin format disc)		
Recordable Surface	Recordable Layer Structure	Capacity
Single-sided Dual-Layer	HD DVD Recordable Layer	15 GB
	DVD Recordable Layer	4.7 GB

## Using TOSHIBA HD DVD PLAYER to enjoy HD DVDs

### HD DVD Playback Restrictions

HD DVD-ROM drive and HD DVD-R drive allow users to enjoy the strong visuals of HD DVD-Video.

"TOSHIBA HD DVD PLAYER" software is provided for playback of HD DVD-Video.

### Important information on use

#### HD DVD Playback

- HD DVD is a new standard which makes use of new technologies. As such, there is a possibility of problems occurring related to connection, compatibility or operation with some discs and other digital devices. The HD DVD-ROM logo signifies that this drive complies with the HD DVD physical standard, and does not signify compliance with the HD DVD Video standard. This device might not support advanced features of the HD DVD Video standard as defined by the DVD Forum, including picture-in-picture and network download features. Screen movement may not be smooth, and performance may be lowered with some HD DVD content.
- This device supports AACS (Advanced Access Content System) next-generation copy protection technology. Renewal of the AACS key integrated into this device is required for uninterrupted enjoyment of HD DVD. An Internet connection is required when renewing the key.

- Because HD DVD playback operates according to programs built-into the content, operation methods, operation screens, sound effects, icons and other features may vary from disc to disc. For more information on these items refer to instructions included with content or contact the content manufacturers directly.

## Important information on playing HD DVD Video discs

### *HD DVD Video discs*

- Please use "TOSHIBA HD DVD PLAYER" for HD DVD Video playback. "Windows Media Player" and other commercially available software cannot be used for HD DVD Video playback.
- HD DVD Video playback may take several moments to begin.
- When playing an HD DVD (Twin format disc), run it from the "TOSHIBA HD DVD Launcher Menu".

### *When Using*

- Frame dropping, audio skipping or out of synch audio and video may occur during playback of some HD DVD Video titles.
- Close all other applications when using the "TOSHIBA HD DVD PLAYER". Do not open any other applications or carry out any other operations during HD DVD Video playback. Playback may stop or not function properly in some situations.
- If windows or icons of memory-resident programs flicker during playback, maximize the "TOSHIBA HD DVD PLAYER" window.
- Do not playback HD DVD discs Video while watching or recording television programs using other applications. Doing so may cause HD DVD Video playback or television program recording errors. In addition, if pre-scheduled recording starts during HD DVD Video playback it may cause HD DVD Video playback or television program recording errors. Please view HD DVD Video during times when there is no recording pre-scheduled.
- The resume function cannot be used with some discs on the "TOSHIBA HD DVD PLAYER".
- Make sure to connect the computer's AC adaptor when using the "TOSHIBA HD DVD PLAYER". Power-saving features may interfere with smooth playback.
- Set the "Power option" profile to "High Performance" when using the "TOSHIBA HD DVD PLAYER".
- Screen savers will not display while playing a movie in the "TOSHIBA HD DVD PLAYER". The computer will also not go into Sleep Mode, Hibernation Mode or shutdown while using "TOSHIBA HD DVD PLAYER".



- Do not configure the Display automatic power off function to run while the "TOSHIBA HD DVD PLAYER" is running.
- The Windows Aero function is disabled while the "TOSHIBA HD DVD PLAYER" is running.

### **Display Devices & Audio**

- "TOSHIBA HD DVD PLAYER" will only run when "Colors" is set to "Highest (32 bit)". The "Colors" setting can be adjusted on the "Monitor" tab in the "Display Settings". To open the Display Settings, click **Start → Control Panel → Appearance and Personalization → Personalization → Display Settings**.
- If the HD DVD Video image is not displayed on an external display or television, stop the "TOSHIBA HD DVD PLAYER", and change the screen resolution in "Resolution" on the "Monitor" tab in the "Display Settings". However, video cannot be output to some external displays and televisions due to output or playback conditions.
- An HDCP compatible HDMI input is required on external displays or televisions to view video being played in the "TOSHIBA HD DVD PLAYER" on an external display or television.
- When viewing on an external display or television, use an HDMI cable to connect the external device to the HDMI out port and change the display device before playing. The display device cannot be changed during playback.
- HD DVD Video can only be displayed on the computer's display panel or televisions connected to the computer's HDMI out port. HD DVD Video cannot be displayed on televisions connected to the S-Video output connector or external displays connected to the RGB connector. In addition, HD DVD Video cannot be displayed simultaneously (in clone or Dualview modes) on the computer's display panel and an external display or television.
- Do not change the screen resolution while running the "TOSHIBA HD DVD PLAYER".
- Audio output through the S/PDIF cannot be recorded when playing an HD DVD in the "TOSHIBA HD DVD PLAYER".
- Audio data of more than 48 kHz/16 bit will be down sampled to 48 kHz/16 bit.

### **TOSHIBA HD DVD PLAYER**

- "TOSHIBA HD DVD PLAYER" software is supported for playback of HD DVD Video, DVD-Video and DVD-VR.
- The "TOSHIBA HD DVD PLAYER" does not have a parental control function.
- In order to protect copyrights, the Windows Print Screen function is disabled when "TOSHIBA HD DVD PLAYER" is running.



*Print Screen functions are disabled even when running other applications besides "TOSHIBA HD DVD PLAYER" and when "TOSHIBA HD DVD PLAYER" is minimized.*

*Please close the "TOSHIBA HD DVD PLAYER" to use the Print Screen function.*

- Carry out the installation/uninstallation of the "TOSHIBA HD DVD PLAYER" under a user account with administrator rights.
- Do not change Windows Users while "TOSHIBA HD DVD PLAYER" is running.
- Some HD DVD Video disc titles may return to the title before the playback time (playback position) displayed in the control window reaches the end time.
- For some HD DVD Video discs, using the control window to change the audio track will also change the subtitle track.
- Periodic updates will be necessary to continue using the "TOSHIBA HD DVD PLAYER".

## Using TOSHIBA HD DVD PLAYER

### Starting TOSHIBA HD DVD PLAYER

Use the following procedure to start "TOSHIBA HD DVD PLAYER".

1. Insert an HD DVD-Video in the HD DVD drive while Windows Vista™ is running.

When an HD DVD-Video disc and an HD DVD (Twin format disc) are set in the HD DVD drive, the following application selection screen may appear.

If this occurs, select **Play HD DVD movie** or **Run the HD DVD Launcher**, then click **OK** to launch the **TOSHIBA HD DVD PLAYER**.



*Application selection screen*

2. Touch the CD/DVD panel on the Front operation panel. Or select **Start → All Programs → TOSHIBA HD DVD PLAYER** to start "TOSHIBA HD DVD PLAYER".



*The TOSHIBA DVD PLAYER can also be started from the Media Center top menu.*

## Operating TOSHIBA HD DVD PLAYER

### Important information on using "TOSHIBA HD DVD PLAYER".

- The HD DVD standard defines A, B, C and D buttons, and some software may display "Press the A button" or similar messages. If a message of this type appears, use the following corresponding keyboard keys.
  - A button: keyboard A key
  - B button: keyboard B key
  - C button: keyboard C key
  - D button: keyboard D key
- Screen display and available features may vary amongst HD DVD-Videos and scenes.
- Only operation buttons (including remote controller and Front operation panels) which correspond to currently available and active features will be useable during HD DVD playback.
- If the menu is opened in the Display Area using the Control window's Top Menu or Menu buttons, touch pad and mouse menu operations may not be able to be used.

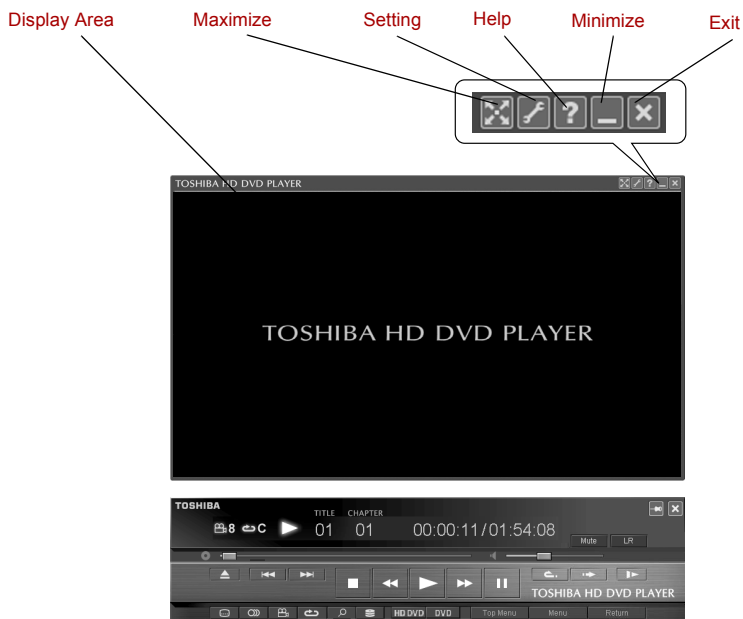

TOSHIBA HD DVD PLAYER Control Window

### TOSHIBA HD DVD PLAYER windows

<b>Display Area</b>	Displays video. Double click on the Display Area to toggle full screen display mode on and off. Click the Display Area to display the Control window when it isn't displayed.
<b>Maximize</b>	Maximizes the window of TOSHIBA HD DVD PLAYER.
<b>Settings</b>	Displays the "Settings" screen.
<b>Help</b>	Opens help.
<b>Minimize</b>	Minimizes the window of TOSHIBA HD DVD PLAYER.
<b>Exit</b>	Closes TOSHIBA HD DVD PLAYER.
<b>TOSHIBA HD DVD PLAYER Control window</b>	The buttons on the panel are used to control playback of HD DVD-Video discs. Click the Display Area to display the Control window when it is hidden. Please refer to the following "TOSHIBA HD DVD PLAYER Control window" section for more information.

## Open TOSHIBA HD DVD PLAYER HELP

TOSHIBA HD DVD PLAYER features and instructions are also explained in detail in "TOSHIBA HD DVD PLAYER Help".

Use the following procedure to open "TOSHIBA HD DVD PLAYER Help".

1. Click the "Help" button (  ) in the Display Area.

## TOSHIBA HD DVD PLAYER Control window

The following are the main buttons used when playing HD DVD-Video. Please refer to Help for details on each button.



*Buttons may not be able to be used on some titles, even if the button is displayed.*

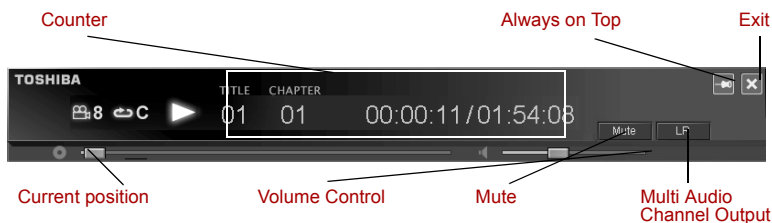

*TOSHIBA HD DVD PLAYER Control window (1)*

<b>Counter</b>	Displays play time, title number and chapter number during disc playback.
<b>Always on top</b>	Sets the control window as always on top, so that it is not hidden by other windows or full screen display.
<b>Exit</b>	Closes TOSHIBA HD DVD PLAYER.
<b>Current position</b>	Displays the current position within the title on the bar icon.
<b>Volume control</b>	Adjusts the volume to the level selected by dragging the slider bar.
<b>Mute</b>	Mutes the sound when clicked. Clicking when the sound is muted returns the volume to the previous level.
<b>Multi Audio Channel Output</b>	Switches between available multi audio channel, during playback of a DVD-VR. This function can be used during playback of a DVD-VR only.

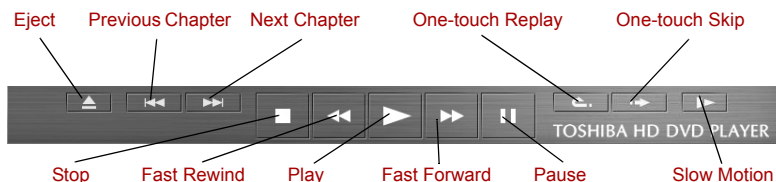

*TOSHIBA HD DVD PLAYER Control window (2)*

<b>Eject</b>	Opens the disc tray.
<b>Previous Chapter</b>	Jumps to the previous chapter.
<b>Next Chapter</b>	Jumps to the next chapter.
<b>One-touch Replay</b>	Rewinds by a specified amount of time and continues playback from that position.
<b>One-touch Skip</b>	Jumps forward by a specified amount of time and continues playback from that position.
<b>Stop</b>	Stops a HD DVD currently being run.
<b>Fast Rewind</b>	Fast Rewind a HD DVD currently being run.
<b>Play</b>	Plays an HD DVD.
<b>Fast Forward</b>	Fast forwards a HD DVD currently being run.
<b>Pause</b>	Temporarily stops a HD DVD currently being run.
<b>Slow Motion</b>	Performs slow motion playback.

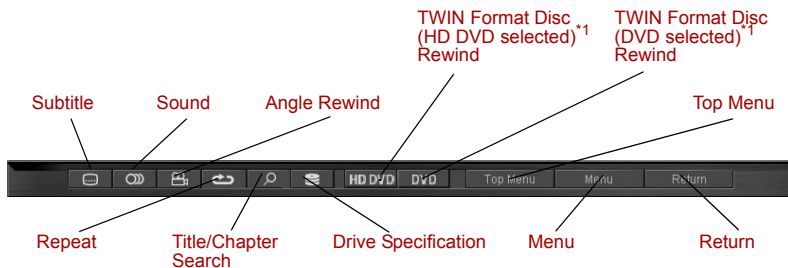

*TOSHIBA HD DVD PLAYER Control window (3)*

<b>Subtitle</b>	Switches between available subtitles.
<b>Sound</b>	Switches between audio tracks for titles which have more than 1 audio track.
<b>Angle</b>	Switches between angles for multi-angle compatible titles.
<b>Repeat</b>	Switches between repeat chapter, repeat title and normal playback modes.
<b>Title/Chapter Search</b>	Searches for chapters or titles.
<b>Drive Specification</b>	Specifies which drive to use when an external HD DVD drive is connected.
<b>Top Menu</b>	Displays the HD DVD Top Menu.
<b>Menu</b>	Displays the HD DVD Menu.
<b>Return</b>	Displays the HD DVD title selection screen.
<b>TWIN Format Disc (HD DVD selected) *1</b>	Reads the HD DVD layer of the HD DVD (Twin format disc). Click <b>DVD</b> button to switch to the DVD layer.
<b>TWIN Format Disc (DVD selected) *1</b>	Reads the DVD layer of the HD DVD (Twin format disc). Click <b>HD DVD</b> button to switch to the HD DVD layer.

\*1: Displayed when an HD DVD (Twin format disc) is placed in the optical disc drive.

## Using the Computer in place of an HD DVD Player

Videos played using "TOSHIBA HD DVD PLAYER" included with the computer can be displayed on a television equipped with an HDMI input port.



*HD DVD-Video can only be displayed on the computer's display panel or on a television connected to the HDMI out port. HD DVD-Video cannot be displayed on televisions connected to the S-Video out port or external displays connected to the RGB connector.*

### Before Connecting

Please refer to the television's user manual as well as this chapter when connecting the computer to a television.

#### ■ Televisions Which Can Be Connected to the Computer.

Televisions which are equipped with an HDMI input port can be connected to the computer.

Please use a commercially available HDMI cable to connect the television and computer.

Not all televisions equipped with an HDMI input port have been tested for compatibility with this product. As such, Toshiba cannot guarantee that HD DVD-Video content can be displayed on all televisions equipped with an HDMI input port. HD DVD-Video content may not display properly on some televisions.

### Connecting to the Computer

Turn off the television and computer before connecting.

1. Insert the HDMI cable plug into the HDMI out port on the computer.

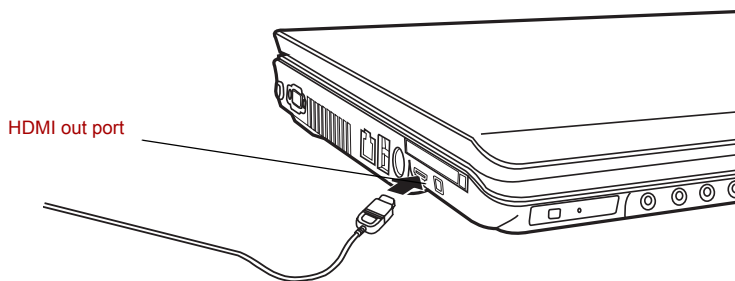

*Connecting the HDMI out port*

2. Insert the remaining HDMI cable plug into the HDMI input port on the television.
3. Turn on the television first, and then the computer. Audio will be output from both the television and the computer. The volume dial or **Fn + ESC** keys can be used to mute the computer audio. The volume level for both the television and computer can be adjusted using the WAVE item in "Volume Control".



## Switching between Computer and Television Display

The following method can be used to display HD DVD-Video. The display method can be changed by changing the display device setting.



*Configure the following settings to display HD DVD-Video on the television. If the following settings are not configured, HD DVD-Video will not be displayed on the television.*

### Notes on Operation

- Change the display device setting before playing HD DVD-Video. Do not change the display device while playing HD DVD-Video.
- Do not change the display device at the following times.
  - When reading or writing data
  - When carrying out communications operations
- HD DVD-Video cannot be played when using Clone or Dualview (extended desktop) displays modes. Set either the computer's display panel or the television as the sole display device.

The display device setting can be changed using the **Fn + F5** keys.

When you press these hot keys, a dialog box appears. Only selectable devices will be displayed. Hold down **Fn** and press **F5** again to change the device. When you release **Fn** and **F5**, the selected device will change. If you hold down these hot keys for five seconds the selection will return to the computer's display panel.

## HD DVD-R Disc writing Software (depending on the model you purchased)

Ulead DVD MovieFactory® for TOSHIBA and TOSHIBA Disc Creator are included with this computer for writing HD DVD-R discs.

Ulead DVD MovieFactory can be used to write files in video format.

TOSHIBA Disc Creator can be used to write data. Refer to the manuals or help files included with the software for detailed usage instructions.

Methods for accessing the manuals and help files for the software are as follows.

- Opening the Ulead DVD MovieFactory Software **Start → All Programs → DVD MovieFactory for TOSHIBA → Ulead DVD MovieFactory for TOSHIBA Launcher**
- Opening the Ulead DVD MovieFactory Manual **Start → All Programs → DVD MovieFactory for TOSHIBA → User Manual → DVD MovieFactory User Manual**
- Opening the TOSHIBA Disc Creator Software **Start → All Programs → CD&DVD Applications → Disc Creator**
- Opening the TOSHIBA Disc Creator Manual **Start → All Programs → CD&DVD Applications → Disc Creator Help**

## Display Compatibility

Only the computer's display panel supports display with high definition processing. When displaying on a television connected to the computer the display on the television will only be ordinary display and not display with high definition processing. The following is an HD DVD-Video display compatibility list.

- **O**: The display of TOSHIBA HD DVD PLAYER is possible.
- **X**: The display of TOSHIBA HD DVD PLAYER is impossible.

	When using TOSHIBA HD DVD PLAYER
Computer's Display Panel	O
Television*	O
External Display*	O
Simultaneous Display	X

\* Can only display on devices equipped with an HDMI port.

## Writing CDs/DVDs on a DVD Super Multi drive or HD DVD-ROM drive supporting double layer disc recording

You can use the DVD Super Multi drive or HD DVD drive to write data to either CD-R/RW or DVD-R/-RW/+R/+RW/-RAM discs. The following applications for writing are preinstalled: TOSHIBA Disc Creator or Ulead DVD MovieFactory® for TOSHIBA, which is a product of Ulead Systems, Inc.

### Important message

Before you write or rewrite to CD-R/RW or DVD-R/-RW/+R/+RW/-RAM media, read and follow all set-up and operating instructions in this section. If you fail to do so, the DVD Super Multi drive or HD DVD drive may not function properly, and you may fail to write or rewrite, lose data or incur other damage.

### Disclaimer

TOSHIBA does not bear responsibility for the following:

- Damage to any CD-R/RW or DVD-R/-RW/+R/+RW/-RAM disc that may be caused by writing or rewriting with this product.
- Any change or loss of the recorded contents of CD-R/RW or DVD-R/-RW/+R/+RW /-RAM media that may be caused by writing or rewriting with this product, or for any business profit loss or business interruption that may be caused by the change or loss of the recorded contents.

- Damage that may be caused by using third party equipment or software.

Given the technological limitations of current optical disc writing drives, you may experience unexpected writing or rewriting errors due to disc quality or problems with hardware devices. Also, it is a good idea to make two or more copies of important data, in case of undesired change or loss of the recorded contents.

## Before writing or rewriting

Please observe the following points when you write or rewrite data.

- Based on TOSHIBA's limited compatibility testing, we suggest the following manufacturers of CD-R/RW and DVD-R/+R/-RW/+RW/-RAM media. However, in no event does TOSHIBA guarantee the operation, quality or performance of any disc. Disc quality can affect write or rewrite success rates.

<b>CD-R:</b>	TAIYOYUDEN CO., LTD. MITSUBISHI KAGAKU MEDIA CO., LTD. RICOH Co., Ltd. Hitachi Maxell Ltd.
<b>CD-RW:</b>	MITSUBISHI KAGAKU MEDIA CO., LTD. RICOH Co., Ltd.
<b>DVD-R:</b>	<b>DVD Specifications for Recordable Disc for General Version 2.0</b> TAIYOYUDEN CO., LTD. Matsushita Electric Industrial Co., Ltd.
<b>DVD-RW:</b>	<b>DVD Specifications for Re-recordable Disc for Version 1.1 or Version 1.2</b> VICTOR COMPANY OF JAPAN, LIMITED. MITSUBISHI KAGAKU MEDIA CO., LTD.
<b>DVD+R:</b>	MITSUBISHI KAGAKU MEDIA CO., LTD. RICOH Co., Ltd.
<b>DVD+RW:</b>	MITSUBISHI KAGAKU MEDIA CO., LTD. RICOH Co., Ltd.
<b>*DVD-RAM</b>	<b>DVD Specifications for DVD-RAM Disc for Version 2.0, Version 2.1 or Version 2.2</b> Matsushita Electric Industrial Co., Ltd. Hitachi Maxell Ltd. * DVD Multi drive, DVD Super Multi, and HD DVD drive can use DVD-RAM.
<b>DVD+R (Double Layer)</b>	MITSUBISHI KAGAKU MEDIA CO., LTD.

<b>DVD-R (Dual Layer)</b>	MITSUBISHI KAGAKU MEDIA CO., LTD.
<b>DVD-R Labelflash™</b>	FUJIFILM Corporation.
<b>DVD+R Labelflash™</b>	FUJIFILM Corporation.

- If the disc is poor in quality, dirty or damaged, writing or rewriting errors may occur. Be careful to check the disc for dirt or damage before you use it.
- The actual number of rewrites to CD-RW or DVD-RW/+RW/-RAM is affected by the quality of the disc and the way it is used.
- There are two types of DVD-R: authoring and general use discs. Do not use authoring discs. Only general use discs can be written to by a computer drive.
- We can support only Format 1 of DVD-R DL. Therefore you can not do the additional writing. If your data is under DVD-R (SL) capacity, we suggest to use DVD-R (SL) media.
- You can use DVD-RAM discs that can be removed from a cartridge and DVD-RAM discs designed without a cartridge. You cannot use a disc with a 2.6 GB single-sided capacity or 5.2 GB double-sided capacity.
- Other DVD-ROM drives for computers or other DVD players may not be able to read DVD-R/+R/-RW/+RW/-RAM discs.
- Data written to a CD-R/DVD-R/+R disc cannot be deleted either in whole or in part.
- Data deleted (erased) from a CD-RW and DVD-RW/+RW/-RAM disc cannot be recovered. Check the content of the disc carefully before you delete it. If multiple drives that can write data to discs are connected, be careful not to delete data from the wrong drive.
- In writing to a DVD-R/+R/-RW/+RW disc, some disc space is required for file management, so you may not be able to write the full capacity of the disc.
- Since the disc is based on the DVD-R/-RW standard, it will be filled with dummy data if the written data is less than about 1 GB. Even if you write only a small amount of data, it might take time to fill in the dummy data.
- Two types of DVD-R/+R/-RW/+RW/-RAM discs are on the market: data and video. Use a video disc to store video data. You can use video discs on a DVD recorder as well as on your computer's DVD-ROM drive. You cannot use data discs on a DVD recorder.
- DVD-RAM formatted by FAT32 cannot be read in Windows 2000 without DVD-RAM Driver Software.
- When multiple drives that can write data to discs are connected, be careful not to write to the wrong drive.
- Be sure to connect the universal AC adapter before you write or rewrite.
- Before you enter Sleep/Hibernation Mode, be sure to finish DVD-RAM writing. Writing is finished if you can eject DVD-RAM media.

- Be sure to close all other software programs except the writing software.
- Do not run software such as a screen saver, which can put a heavy load on the CPU.
- Operate the computer at full power. Do not use power-saving features.
- Do not write while virus check software is running. Wait for it to finish, then disable virus detection programs including any software that checks files automatically in the background.
- Do not use hard disk utilities, including those intended to enhance hard disk access speed, as they may cause unstable operation and damage data.
- Write from the computer's hard disk drive to the CD. Do not try to write from shared devices such as a LAN server or any other network device.
- Writing with software other than TOSHIBA Disc Creator or Ulead DVD MovieFactory<sup>®</sup> for TOSHIBA has not been confirmed. Therefore, operation with other software cannot be guaranteed.

### When writing or rewriting

Please observe/consider the following when you write or rewrite to a CD-R/RW, DVD-R/-RW/-RAM or DVD+R/+RW disc.

- Do not perform any of the following actions when writing or rewriting:
  - Change users in the Windows Vista™ operating system.
  - Operate the computer for any other function, including using a mouse or TouchPad/Dual Mode Pad or closing/opening the LCD panel.
  - Start a communication application such as a modem.
  - Apply impact or vibration to the computer.
  - Install, remove or connect external devices such as USB devices, an external display, i.Link devices or optical digital devices.
  - Use the audio/video control button to reproduce music or voice.
  - Open the drive.
- Do not use shut down/log off and Sleep/Hibernation while writing or rewriting.
- Make sure writing or rewriting is completed before going into Sleep/hibernation. Writing is completed if you can open the drive tray.
- Set the computer on a level surface and avoid places subject to vibration such as airplanes, trains or cars. Do not use an unstable surface such as a stand.
- Keep mobile phones and other wireless communication devices away from the computer.
- Always copy data from the hard disk drive to the CD. Do not use cut-and-paste as the original data will be lost if there is a write error.

## How to make a Labelflash™ DVD

Simplified steps for making a Labelflash™ DVD:

1. Insert a Labelflash™ disc in DVD drive.



*Set printable surface for underside.*

2. Click **Start** → **All Programs** → **DVD MovieFactory for TOSHIBA** → **Ulead DVD MovieFactory for TOSHIBA Launcher** to launch DVD MovieFactory.
3. Click **Print Disc Label** → **Label Printing**. Ulead Label@Once is started.
4. Click the **General** tab.
5. Choose **DVD Drive** for Printer. e.g. <E:> PIONEER DVD...
6. Add and customize the look of your images and text.
7. Click **Labelflash™ setting** and choose **Draw Quality**.
8. Click **Print**.



*The availability of Labelflash™ function depends on the model you purchased.*

## Writing CDs/DVDs/HD DVDs on a HD DVD-R drive (depending on the model you purchased)

You can use the HD DVD-R drive to write data to either CD-R/RW or DVD-R/-RW/+R/+RW/-RAM or HD DVD-R discs. The following applications for writing are preinstalled:  
TOSHIBA Disc Creator or Ulead DVD MovieFactory® for TOSHIBA, which is a product of Ulead Systems, Inc.

### Important message

Before you write or rewrite to CD-R/RW or DVD-R/-RW/+R/+RW/-RAM or HD DVD-R media, read and follow all set-up and operating instructions in this section. If you fail to do so, the HD DVD-R drive may not function properly, and you may fail to write or rewrite, lose data or incur other damage.

### Disclaimer

TOSHIBA does not bear responsibility for the following:

- Damage to any CD-R/RW or DVD-R/-RW/+R/+RW/-RAM or HD DVD-R disc that may be caused by writing or rewriting with this product.
- Any change or loss of the recorded contents of CD-R/RW or DVD-R/-RW/+R/+RW /-RAM or HD DVD-R media that may be caused by writing or rewriting with this product, or for any business profit loss or business interruption that may be caused by the change or loss of the recorded contents.

- Damage that may be caused by using third party equipment or software.

Given the technological limitations of current optical disc writing drives, you may experience unexpected writing or rewriting errors due to disc quality or problems with hardware devices. Also, it is a good idea to make two or more copies of important data, in case of undesired change or loss of the recorded contents.

## Before writing or rewriting

Please observe the following points when you write or rewrite data.

- Based on TOSHIBA's limited compatibility testing, we suggest the following manufacturers of CD-R/RW, DVD-R/+R/-RW/+RW/-RAM and HD DVD-R media. However, in no event does TOSHIBA guarantee the operation, quality or performance of any disc. Disc quality can affect write or rewrite success rates.

<b>CD-R:</b>	TAIYOYUDEN CO., LTD. MITSUBISHI KAGAKU MEDIA CO., LTD. RICOH Co., Ltd. Hitachi Maxell Ltd.
<b>CD-RW:</b>	MITSUBISHI KAGAKU MEDIA CO., LTD. RICOH Co., Ltd.
<b>DVD-R:</b>	<b>DVD Specifications for Recordable Disc for General Version 2.0</b> TAIYOYUDEN CO., LTD. Matsushita Electric Industrial Co., Ltd.
<b>DVD-RW:</b>	<b>DVD Specifications for Re-recordable Disc for Version 1.1 or Version 1.2</b> VICTOR COMPANY OF JAPAN, LIMITED. MITSUBISHI KAGAKU MEDIA CO., LTD.
<b>DVD+R:</b>	MITSUBISHI KAGAKU MEDIA CO., LTD. RICOH Co., Ltd.
<b>DVD+RW:</b>	MITSUBISHI KAGAKU MEDIA CO., LTD. RICOH Co., Ltd.
<b>*DVD-RAM</b>	<b>DVD Specifications for DVD-RAM Disc for Version 2.0, Version 2.1 or Version 2.2</b> Matsushita Electric Industrial Co., Ltd. Hitachi Maxell Ltd. *DVD Multi drive and DVD Super Multi can use DVD-RAM.
<b>DVD+R (Double Layer)</b>	MITSUBISHI KAGAKU MEDIA CO., LTD.

<b>DVD-R (Dual Layer)</b>	MITSUBISHI KAGAKU MEDIA CO., LTD.
<b>HD DVD-R (Single Layer)</b>	Hitachi Maxell Ltd. MITSUBISHI KAGAKU MEDIA CO., LTD.
<b>HD DVD-R (Dual Layer)</b>	MITSUBISHI KAGAKU MEDIA CO., LTD.

- If the disc is poor in quality, dirty or damaged, writing or rewriting errors may occur. Be careful to check the disc for dirt or damage before you use it.
- The actual number of rewrites to CD-RW or DVD-RW/+RW/-RAM or HD DVD-R is affected by the quality of the disc and the way it is used.
- There are two types of DVD-R: authoring and general use discs. Do not use authoring discs. Only general use discs can be written to by a computer drive.
- We can support only Format 1 of DVD-R DL. Therefore you can not do the additional writing. If your data is under DVD-R (SL) capacity, we suggest to use DVD-R (SL) media.
- You can use DVD-RAM discs that can be removed from a cartridge and DVD-RAM discs designed without a cartridge. You cannot use a disc with a 2.6 GB single-sided capacity or 5.2 GB double-sided capacity.
- Other DVD-ROM drives for computers or other DVD players may not be able to read DVD-R/+R/-RW/+RW/-RAM discs.
- Data written to a CD-R/DVD-R/+R disc cannot be deleted either in whole or in part.
- Data deleted (erased) from a CD-RW and DVD-RW/+RW/-RAM disc cannot be recovered. Check the content of the disc carefully before you delete it. If multiple drives that can write data to discs are connected, be careful not to delete data from the wrong drive.
- In writing to a DVD-R/+R/-RW/+RW disc, some disc space is required for file management, so you may not be able to write the full capacity of the disc.
- Since the disc is based on the DVD-R/-RW standard, it will be filled with dummy data if the written data is less than about 1 GB. Even if you write only a small amount of data, it might take time to fill in the dummy data.
- Two types of DVD-R/+R/-RW/+RW/-RAM discs are on the market: data and video. Use a video disc to store video data. You can use video discs on a DVD recorder as well as on your computer's DVD-ROM drive. You cannot use data discs on a DVD recorder.
- DVD-RAM formatted by FAT32 cannot be read in Windows 2000 without DVD-RAM Driver Software.
- When multiple drives that can write data to discs are connected, be careful not to write to the wrong drive.
- Be sure to connect the universal AC adapter before you write or rewrite.
- Before you enter Sleep/Hibernation Mode, be sure to finish DVD-RAM writing. Writing is finished if you can eject DVD-RAM media.



- Be sure to close all other software programs except the writing software.
- Do not run software such as a screen saver, which can put a heavy load on the CPU.
- Operate the computer at full power. Do not use power-saving features.
- Do not write while virus check software is running. Wait for it to finish, then disable virus detection programs including any software that checks files automatically in the background.
- Do not use hard disk utilities, including those intended to enhance hard disk access speed, as they may cause unstable operation and damage data.
- Write from the computer's hard disk drive to the CD. Do not try to write from shared devices such as a LAN server or any other network device.
- Writing with software other than TOSHIBA Disc Creator or Ulead DVD MovieFactory<sup>®</sup> for TOSHIBA has not been confirmed. Therefore, operation with other software cannot be guaranteed.

### When writing or rewriting

Please observe/consider the following when you write or rewrite to a CD-R/RW, DVD-R/-RW/-RAM or DVD+R/+RW or HD DVD-R disc.

- Do not perform any of the following actions when writing or rewriting:
  - Change users in the Windows Vista™ operating system.
  - Operate the computer for any other function, including using a mouse or TouchPad/Dual Mode Pad or closing/opening the LCD panel.
  - Start a communication application such as a modem.
  - Apply impact or vibration to the computer.
  - Install, remove or connect external devices such as USB devices, an external display, i.Link devices or optical digital devices.
  - Use the audio/video control button to reproduce music or voice.
  - Open the drive.
- Do not use shut down/log off and Sleep/Hibernation while writing or rewriting.
- Make sure writing or rewriting is completed before going into Sleep/hibernation. Writing is completed if you can open the drive tray.
- Set the computer on a level surface and avoid places subject to vibration such as airplanes, trains or cars. Do not use an unstable surface such as a stand.
- Keep mobile phones and other wireless communication devices away from the computer.
- Always copy data from the hard disk drive to the CD. Do not use cut-and-paste as the original data will be lost if there is a write error.

## When Using Ulead DVD MovieFactory® for TOSHIBA

### How to make a DVD-Video

Simplified steps for making a DVD-Video from video data captured from a DV-Camcorder:

1. Click **Start** → **All Programs** → **DVD MovieFactory for TOSHIBA** → **Ulead DVD MovieFactory for TOSHIBA Launcher** to launch DVD MovieFactory.
2. Insert a DVD-RW or DVD+RW disc in Burner.
3. Click **Video Disc** → **Burn Video to Disc** to launch **Direct Recording** dialog box, choose **DVD-Video/+VR** to invoke **Straight Capture to Disc** Page.
4. Choose **DVD-Video** format.
5. Confirm the capture source is DV.
6. Press **Capture** button.

Simplified steps for making a DVD-Video from adding a video source:

1. Click **Start** → **All Programs** → **DVD MovieFactory for TOSHIBA** → **Ulead DVD MovieFactory for TOSHIBA Launcher** to launch DVD MovieFactory.
2. Click **Video Disc** → **New Project** to invoke 2<sup>nd</sup> Launcher, choose your project type, then invoke DVD MovieFactory.
3. Add source from HD Disk by click Add Video files button to invoke browser dialog box.
4. Choose the source video then go to the Next page to apply Menu.
5. After choose the menu template, press **Next** button to go to **Burning Page**.
6. Choose the output type then press **Burn** button.

### How to learn more about Ulead DVD MovieFactory®

Please refer to the Help and Manul file for additional Ulead DVD MovieFactory information.

### Important information for use

Note the following limitations when you write video DVD:

1. Editing digital video
  - Log in with Administrator rights to use DVD MovieFactory.
  - Make sure that your computer is running on AC power when using DVD MovieFactory.
  - Operate the computer at Full Power. Do not use power-saving features.
  - While you are editing DVD, you can display previews. However, if another application is running, the preview might not display properly.
  - DVD MovieFactory cannot edit or play copy protected content.

- Do not enter Sleep/Hibernation Mode while using DVD MovieFactory.
  - Do not operate DVD MovieFactory immediately after turning on the computer. Please wait until all Disc Drive activity has stopped.
  - When recording to a DV-Camcorder, to ensure you capture all of your data, let the camcorder record for a few seconds before you begin recording your actual data.
  - CD recorder, JPEG functions, DVD-Audio, mini DVD and Video CD functions are not supported in this version.
  - While recording video to DVD or tape, please close all other programs.
  - Do not run software like a screen saver because it can put a heavy load on the CPU.
  - Do not support MP3 decode and encode.
2. Before recording the video to DVD
- When you record to DVD disc, please use only discs recommended by the Drive manufacturer.
  - Do not set the working drive to a slow device like a USB 1.1 hard disk drive or it will fail to write DVD.
  - Do not perform any of the following actions:
    - Operate the computer for any other function, including using a mouse or TouchPad/Dual Mode Pad or closing/opening the LCD panel.
    - Bump or cause vibration to the computer.
    - Use the Mode control button and Audio/Video control button to reproduce music or voice.
    - Open the DVD drive.
    - Install, remove or connect external devices, including the following: SD card, USB devices, external display, i.LINK. devices, optical digital devices.
  - Please verify your disc after recording important data.
  - DVD-R/+R/-RW disc cannot be written in VR format.
  - Not support to output VCD or SVCD format.
3. About Straight to Disc
- Not support to record on DVD-R/+R disc.
  - Not support to record DVD+VR format by HDV.
  - HDV support to burn DVD-Video only.
  - DVD-VR format not support to add Menu.
4. About recorded DVDs
- Some DVD-ROM drives for personal computers or other DVD players may not be able to read DVD-R/+R/-RW/-RAM discs.
  - When playing your recorded disc on your computer, please use the DVD Video Player.
  - If you use an over-used rewritable disc, the full formatting might be locked. Please use a brand new disc.

# Chapter 6

## The Keyboard

The computer's keyboard layouts are compatible with a 104/105-key enhanced keyboard. By pressing some keys in combination, all the 104/105-key keyboard functions can be executed on the computer.

The number of keys on your keyboard depends on which country/region's keyboard layout your computer is configured with. Keyboards for numerous languages are available.

There are five types of keys: typewriter keys, numeric keys, function keys, soft keys and cursor control keys.

### Typewriter keys

The typewriter keys, produce the upper- and lower-case letters, numbers, punctuation marks, and special symbols that appear on the screen.

There are some differences, however, between using a typewriter and using a computer keyboard:

- Letters and numbers produced in computer text vary in width. Spaces, which are created by a space character may also vary depending on line justification and other factors.
- The lowercase l (el) and the number 1 (one) are not interchangeable on computers as they are on a typewriter.
- The uppercase O (oh) and the 0 (zero) are not interchangeable.
- The **Caps Lock** function key locks only the alphabetic characters in uppercase while the shift lock on a typewriter places all keys in the shifted position.
- The **Shift** keys, the **Tab** key, and the **Back Space** key perform the same function as their typewriter counterparts but also have special computer functions.

## F1 ... F12 function keys

The function keys, not to be confused with **Fn**, are the 12 keys at the top of your keyboard. These keys are dark gray, but function differently from the other dark gray keys.



**F1** through **F12** are called function keys because they execute programmed functions when pressed. Used in combination with the **Fn** key, keys marked with icons execute specific functions on the computer. See the section, [Soft keys: Fn key combinations](#), in this chapter. The function executed by individual keys depends on the software you are using.

## Soft keys: Fn key combinations

The **Fn** (function) is unique to TOSHIBA computers and is used in combination with other keys to form soft keys. Soft keys are key combinations that enable, disable or configure specific features.



*Some software may disable or interfere with soft-key operations. Soft-key settings are not restored by the Sleep feature.*

### Emulation keys

Your software may require you to use keys that the keyboard does not have. Pressing the **Fn** key and one of the following keys simulates the enhanced keyboard's functions.

















Press **Fn** + **Enter** to simulate **Enter** on the enhanced keyboard's numeric keypad.



Press **Fn** + **Ctrl** to simulate the enhanced keyboard's right **Ctrl** key.

## Hotkeys

	<b>Fn + ESC</b>	<b>Volume Mute</b> – Turns the volume on and off.
	<b>Fn + F1</b>	<b>Instant Security</b> – Enters screen saver mode and blanks the screen. To restore your desktop, press any key or use the TouchPad/Dual Mode Pad.
	<b>Fn + F2</b>	<b>Power Save Modes</b> – Displays the power save modes and lets you change the power settings
	<b>Fn + F3</b>	<b>Sleep</b> – This hot key switches the system to Sleep mode.
	<b>Fn + F4</b>	<b>Hibernate</b> – This hot key switches the system to Hibernate mode.
	<b>Fn + F5</b>	<b>Display Selection</b> – Changes displays.
	<i>Default resolution for simultaneous mode is set to WXGA+ (1440 × 900). If you connect an RGB (Monitor) that is not WXGA+, change it in "Control Panel/Personalization/Display settings".</i>	
	<b>Fn + F6</b>	<b>Brightness Down</b>
	<b>Fn + F7</b>	<b>Brightness Up</b>
	<b>Fn + F8</b>	<b>Wireless Device Controls</b> – Pressing this hot key allows you to switch between active wireless devices if the wireless communication switch is switched on.
	<b>Fn + F9</b>	<b>TouchPad/Dual Mode Pad On/Off</b>
	<b>Fn + Space</b>	<b>Change Resolution</b> – Cycles sequentially from the current resolution to 800 × 600 to 1024 × 768 and back again to the original resolution.
	<b>Fn + 1</b>	<b>Zoom Out</b> – To reduce the icon size on the desktop or the application window, press the 1 key while holding down the <b>Fn</b> key.
	<b>Fn + 2</b>	<b>Zoom In</b> – To enlarge the icon size on the desktop or the application window, press the 2 key while holding down the <b>Fn</b> key.
	<i>Before using <b>Fn + 1</b> and <b>Fn + 2</b>, you must install the TOSHIBA Zooming Utility. Please be aware that this 'zooming' function is only available within Microsoft Internet Explorer, Microsoft Office, Windows Media Player and Adobe Reader, and for the icons on the desktop.</i>	

## Windows special keys

The keyboard provides two keys that have special functions in Windows Vista. One activates the Start menu and the other has the same function as the secondary mouse button.



This key activates the Windows Vista™ Start menu



This key has the same function as the Right mouse button.

## Number Pad

The number pad is activated by pressing the Num Lock key, the LED will appear when active. Use the keypad to type numbers and generate ASCII characters.

## Generating ASCII characters

Not all ASCII characters can be generated using normal keyboard operation. But, you can generate these characters using their ASCII codes.

With the Num lock on:

1. Hold down **Alt**.
2. Using the number pad keys, type the ASCII code.
3. Release **Alt**, and the ASCII character appears on the display screen.

With the Num Lock off:

1. Hold **Alt + Fn**.
2. Using the number pad keys, type the ASCII code.
3. Release **Alt + Fn**, and the ASCII character appears on the display screen.

# Chapter 7

## Power and Power-Up Modes

The computer's power resources include the AC adapter and internal batteries. This chapter gives details on making the most effective use of these resources including charging and changing batteries, tips for saving battery power, and power up modes.

### Power conditions

The computer's operating capability and battery charge status are affected by the power conditions: whether an AC adapter is connected, whether a battery is installed and what the charge level is for the battery.

		Power on	Power off (no operation)
AC adapter connected	Battery fully charged	<ul style="list-style-type: none"> <li>Operates</li> <li>No charge</li> <li>LED: <b>Battery</b> blue <b>DC IN</b> blue</li> </ul>	<ul style="list-style-type: none"> <li>No charge</li> <li>LED: <b>Battery</b> blue <b>DC IN</b> blue</li> </ul>
	Battery partially charged	<ul style="list-style-type: none"> <li>Operates</li> <li>Charge</li> <li>LED: <b>Battery</b> Amber <b>DC IN</b> blue</li> </ul>	<ul style="list-style-type: none"> <li>Charge</li> <li>LED: <b>Battery</b> Amber <b>DC IN</b> blue</li> </ul>
	No battery installed or no charge	<ul style="list-style-type: none"> <li>Operates</li> <li>No charge</li> <li>LED: <b>Battery</b> off <b>DC IN</b> blue</li> </ul>	<ul style="list-style-type: none"> <li>No charge</li> <li>LED: <b>Battery</b> off <b>DC IN</b> blue</li> </ul>



		Power on	Power off (no operation)
AC adapter not connected	Battery capacity is above low battery trigger point	<ul style="list-style-type: none"> <li>Operates</li> <li>LED: <b>Battery</b> off <b>DC IN</b> off</li> </ul>	
	Battery capacity is below low battery trigger point	<ul style="list-style-type: none"> <li>Operates</li> <li>Alarm sounds (this function depends on how the computer is configured)</li> <li>LED: <b>Battery</b> flashes Amber <b>DC IN</b> off</li> </ul>	
	Battery capacity exhausted	Computer goes into Hibernation or shuts down (depending on the TOSHIBA Power Saver setting)	
	No battery installed	<ul style="list-style-type: none"> <li>No operation</li> <li>LED: <b>Battery</b> off <b>DC IN</b> off</li> </ul>	



\* The LED is dependent on the model you purchased.

## Power indicators

As shown in the above table, the **Battery**, **DC IN** and **Power** indicators alert you to the computer's operating capability and battery charge status

### Battery indicator

Check the **Battery** indicator to determine the status of the battery. The following indicator lights indicate the battery status.

<b>Flashing Amber</b>	The battery charge is low. The AC adapter must be connected to recharge the battery
<b>Amber</b>	Indicates the AC adapter is connected and is charging the battery.
<b>Blue</b>	Indicates the AC adapter is connected and the battery is fully charged.
<b>No light</b>	Under any other conditions, the indicator does not light.

## DC IN indicator

Check the **DC IN** indicator to determine the power status with the AC adapter connected:

<b>Blue</b>	Indicates the AC adapter is connected and is correctly supplying power to the computer.
<b>No light</b>	Indicates the AC adapter is not connected.

## Power indicator

Check the **Power** indicator to determine the power status with the AC adapter connected:

<b>Blue</b>	Indicates power is being supplied and the computer is turned on. Power indicator is located inside of the Power Button (depending the model you purchased) and in the front of the computer.
<b>Blinking Amber</b>	Indicates power is being supplied to the computer while the computer is in Sleep mode.
<b>No light</b>	Under any other conditions, the indicator does not light.

## Battery types

The computer has two types of batteries:

- Battery pack
- Real Time Clock (RTC) battery

### Battery pack

When the AC adapter is not connected, the computer's main power source is a removable lithium ion battery pack, also referred to in this manual as the battery.

You can purchase additional battery packs for extended use of the computer away from an AC power source.

The battery is a disposable item. When its operation becomes short even when fully charged, replace it with a new one.



- *The battery pack is a lithium ion battery, which can explode if not properly replaced, used, handled or disposed of. Dispose of the battery as required by local ordinances or regulations. Use only batteries recommended by TOSHIBA as replacements.*
  - *Do not remove the battery pack while the computer is in Sleep Mode. In this mode data is stored in memory, so if the computer loses power, it will be lost.*
  - *Battery type: 6 cell-PA3536U-1BRS,PA3536U-1BAS*
- \* *The availability of this battery is dependent on the model you purchased.*

## Real Time Clock battery

The Real Time Clock (RTC) battery provides power for the internal real time clock and calendar. It also maintains the system configuration.

If the RTC battery becomes completely discharged, the system loses this data and the real time clock and calendar stop working. The following message appears when you turn on the power:



```
ERROR 0271:Check date and time settings.
WARNING 0251:System CMOS checksum bad - Default
configuration used.
Press <F1> to resume, <F2> to Setup.
```



*The computer's RTC battery is a lithium battery and should be replaced only by your dealer or by a TOSHIBA service representative. The battery can explode if not properly replaced, used, handled or disposed of. Dispose of the battery as required by local ordinances or regulations.*

When this error appears, the following action is recommended.

1. Connect the AC adapter and let the battery charge for 24-hours.
2. Press **F2** to enter BIOS setup menu.
3. Set correct time and date.



*If you still see the error message after performing the above actions, please contact your TOSHIBA service representative.*

## Care and use of the battery pack

The battery pack is a vital component of portable computing. Taking proper care of it will help ensure longer operating time on battery power as well as a longer life for your battery pack. Follow the instructions in this section carefully to ensure safe operation and maximum performance.

## Safety precautions

Mishandling of batteries can cause death, serious injury or property damage.

Carefully observe the following advice:

**Danger:** Indicates an imminently hazardous situation, which could result in death or serious injury, if you do not follow instructions.

**Warning:** Indicates a potentially hazardous situation, which could result in death or serious injury, if you do not follow instructions.

**Caution:** Indicates a potentially hazardous situation, which if not avoided, may result in moderate or minor injury or property damage.

**Note:** Provides important information.

### *Danger*

1. Never try to dispose of the battery pack by burning or expose it to a heating device such as a microwave oven. The battery pack could explode and cause bodily injury.
2. Never try to disassemble, repair or otherwise tamper with a battery pack. The battery pack will overheat and ignite. Leakage of caustic alkaline solution or other electrolytic substances will cause fire or injury, possibly resulting in death or serious injury.
3. Never short-circuit the battery pack by contacting the terminals with a metal object. A short-circuit can cause fire or otherwise damage the battery pack and possibly cause injury. To avoid accidental short-circuit, always wrap the battery pack in plastic and cover the terminals with electrical tape when storing or disposing of the battery pack.
4. Never puncture the battery pack with a nail or other sharp object. Never strike it with a hammer or other object. Never step on it.
5. Never try to charge the battery pack in any manner other than that described in the user's manual. Never connect the battery pack to a plug socket or to an automobile's cigarette lighter socket. It may rupture or ignite.
6. Use only the battery pack supplied with the computer or other device or an battery pack approved by the computer or device's manufacturer. Battery packs have different voltages and terminal polarities. Use of an improper battery could cause smoke, fire or rupture of the battery pack.
7. Never subject a battery pack to heat, such as storage near a heat source. Exposure to heat can cause the battery pack to ignite, explode or leak caustic liquid and cause death or serious injury. It could also fail or malfunction causing data loss.
8. Never expose the battery pack to abnormal shock, vibration or pressure. The battery pack's internal protective device will fail, causing it to overheat, explode, ignite or leak caustic liquids possibly resulting in death or serious injury.
9. Never let a battery pack become wet. A wet battery pack will overheat, ignite or rupture possibly resulting in death or serious injury.

### **Warning**

1. Never allow caustic electrolyte fluid leaked from a battery pack to contact your eyes, skin or clothing. If caustic electrolyte fluid should contact your eyes, immediately wash your eyes with large amounts of running water and seek medical attention, to help prevent eye damage. If electrolyte fluid should contact your skin, immediately wash it under running water to prevent rash. If it contacts your clothes, promptly remove them to prevent the fluid from contacting your skin or eyes.
2. Immediately turn off the power, disconnect the AC adapter and remove the battery if any of the following events are observed in the battery pack: offensive or unusual odor, excessive heat, discoloration or deformation. Never use the computer again until it has been checked by a TOSHIBA service provider. It might generate smoke or fire, or the battery pack might rupture.
3. Make sure the battery is securely installed in the computer before attempting to charge the battery pack. Improper installation could generate smoke or fire, or cause the battery pack to rupture.
4. Keep the battery pack out of reach of infants and children. It can cause injury.

### **Caution**

1. Never continue to use a battery pack after its recharging capacity has become impaired, or after the display of a warning message indicating that the battery pack's power is exhausted. Continued use of an exhausted or impaired battery pack could cause the loss of data.
2. Never dispose of battery packs with normal trash. Bring them to your TOSHIBA dealer or to another recycling centre to save resources and prevent environmental damage. Cover the terminals with electrical tape to prevent short-circuits, which could cause the battery pack to ignite or rupture.
3. Use only battery packs recommended by TOSHIBA as replacements.
4. Always make sure the battery pack is installed correctly and securely. Otherwise, a battery pack could fall out and possibly cause injury.
5. Charge the battery pack only in an ambient temperature between 5 and 30 degrees Celsius. Otherwise, the electrolyte solution might leak, battery pack performance might deteriorate and the battery life might be shortened.
6. Be sure to monitor the remaining battery power. If the battery pack or real time clock battery discharge completely, Sleep Mode will not function, and data in memory will be lost, and the computer might register an incorrect time and date. In this case, connect the AC adapter to recharge the batteries.
7. Never install or remove the battery pack without first turning off the power and disconnecting the AC adapter. Never remove the battery pack while the computer is in Sleep Mode as data will be lost.

## Note

1. Never remove the battery pack while the Wake-up on LAN function is enabled. Data will be lost. Before you remove a battery pack, disable the Wake-up on LAN function.
2. To ensure the battery pack maintains maximum capacity, operate the computer on battery power once a week until the battery pack is fully discharged. Refer to the section *Extending battery life* in this chapter for procedures. If the computer is continuously operated on AC power for an extended period, more than a week, the battery might fail to retain a charge. It might not function efficiently over the expected life of the battery pack and the Battery indicator might not indicate a low-battery condition.
3. After the battery pack is charged, avoid leaving the AC adapter connected and the computer turned off for more than a few hours at a time. Continuing to charge a fully charged battery pack can damage the battery.

## Charging the batteries

When the power in the battery pack becomes low, the **Battery** indicator flashes amber indicating that only a few minutes of battery power remain. If you continue to use the computer while the **Battery** indicator flashes, the computer enables Hibernation mode (so you don't lose data) and automatically turns off.

You must recharge a battery pack when it becomes discharged.

## Procedures

To recharge a battery pack while it is installed in the computer, connect the AC adapter to the **DC IN** socket and plug the other end into a working outlet.

The **Battery** indicator glows amber when the battery is being charged.



*Use only the computer connected to an AC power source to charge the battery pack. Do not attempt to charge the battery pack with any other charger.*

## Time

The following table shows the time required to fully charge a discharged battery.

### Charging time (hours)

Battery type	Power on	Power off
Battery pack	about 12 or longer	about 4 or longer
RTC battery	about 24	about 24 with AC or Battery pack



*The charging time when the computer is on is affected by ambient temperature, the temperature of the computer and how you use the computer.*

*If you make heavy use of external devices the battery might scarcely charge at all during operation. Refer also to the section Maximizing battery operating time.*

### **Battery charging notice**

The battery may not charge right away under the following conditions:

- The battery is extremely hot or cold. To make sure the battery charges to its full capacity, charge the battery at room temperature of 10°C to 30°C (50°F to 86°F).
- The battery is nearly completely discharged. Leave the AC adapter connected for a few minutes and the battery should begin charging.



*Once a battery pack is fully charged, it is recommended that you operate the computer only on battery power until the battery pack completely discharges. Doing so extends battery life and helps ensure accurate monitoring of battery capacity.*

The **Battery** indicator may show a rapid decrease in battery operating time when you try to charge a battery under the following conditions:

- The battery has not been used for a long time.
- The battery has completely discharged and been left in the computer for a long time.
- A cool battery is installed in a warm computer.

In such case, follow the steps below.

1. Fully discharge the battery by leaving it in the computer with the power on until the power automatically shuts off.
2. Plug in the AC adapter.
3. Charge the battery until the Battery indicator glows blue (depending the model you purchased).

Repeat these steps two or three times until the battery recovers normal capacity.



*Leaving the AC adapter connected will shorten battery life. At least once a week, run the computer on battery power until the battery is fully discharged, then recharge the battery.*

## Monitoring battery capacity

Remaining battery power can be monitored using the following methods.

- Clicking the battery icon on the task bar
- Via the Battery Stats in the Windows Mobility Center Window



■ *You should wait at least 16 seconds after turning on the computer before trying to monitor the remaining operating time. This is because the computer needs this time to check the battery's remaining capacity and then calculate the remaining operating time, based on this together with the current power consumption.*

■ *Please be aware that the actual remaining operation time may differ slightly from the calculated time.*

*With repeated discharges and recharges, the battery's capacity will gradually decrease. In view of this it will be noted that an often used, older battery will not operate for as long as a new battery even when both are fully charged.*

## Maximizing battery operating time

A battery's usefulness depends on how long it can supply power on a single charge.

How long the charge lasts in a battery depends on:

- How you configure the computer (for example, whether you enable battery power saving options). The computer provides a battery save mode to conserve battery power. This mode has the following options:
  - Display auto off
  - Hard Disk Drive auto off
  - System auto off
  - LCD brightness.
- How often and how long you use the hard disk, optical media drive and the disk drive (if one is connected).
- How much charge the battery contained to begin with.
- Enabling Sleep Mode or Hibernation Mode conserves battery power if you are frequently turning the computer off and on.
- Where you store your programs and data.
- Closing the display when you are not using the keyboard saves power.
- Operating time decreases at low temperatures.
- The condition of the battery terminals. Make sure the battery terminals stay clean by wiping them with a clean dry cloth before installing the battery pack.



## Retaining data with power off (sleep mode)

When you turn off your computer with fully charged batteries, the batteries retain data/charge for the following approximate time periods:

<b>Battery</b>	Approximately 1 days (Sleep mode,6-cell) Approximately 1 month (Shut down mode, all type of battery packs)
<b>RTC battery</b>	Approximately 1 month

\* The availability of this battery is dependent on the model you purchased.

## Extending battery life

To maximize the life of your battery pack:

- If you have extra battery packs, rotate their use.
- If you will not be using the system for an extended period, remove the battery pack.
- Store spare battery packs in a cool dry place out of direct sunlight.

## Replacing the battery pack

When the battery pack reaches the end of its operating life you will need to install a new one. If the **Battery** indicator flashes amber shortly after the battery has been fully recharged, the battery pack needs to be replaced.

You might also replace a discharged battery pack with a charged spare when you are operating your computer away from an AC power source. This section explains how to remove and install the battery pack.

## Removing the battery pack

To replace a discharged battery pack, follow the steps below.



- *When handling battery packs, be careful not to short circuit the terminals. Also do not drop, hit or otherwise apply impact; do not scratch or break the casing and do not twist or bend the battery pack.*
- *Do not remove the battery pack while the computer is in Sleep Mode as data in memory will be lost.*

1. Save your work.
2. Turn the computer's power off. Make sure the Power indicator is off.
3. Remove all cables connected to the computer.
4. Turn the computer upside down.

5. Unlock the Battery Pack Lock.

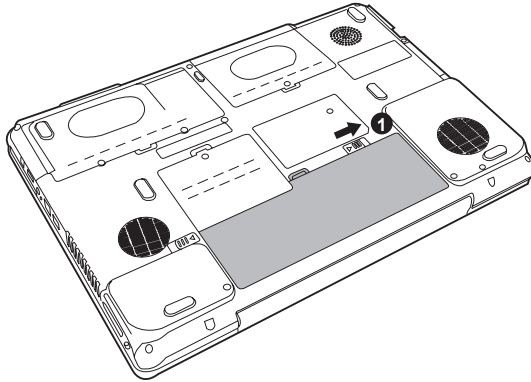

*Removing the battery pack-1*

6. Slide the battery pack latch to the left, then pull the battery out of the battery bay.

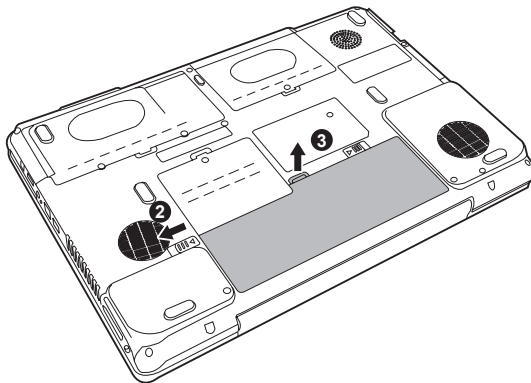

*Removing the battery pack-2*

## Installing the battery pack

To install a battery pack, follow the steps below.



*The battery pack is a lithium ion battery, which can explode if not properly replaced, used, handled or disposed of. Dispose of the battery as required by local ordinances or regulations. Use only batteries recommended by TOSHIBA as replacements.*

1. Turn the computer's power off.
2. Disconnect all cables connected to the computer.
3. Hold the battery pack so that the label faces down and the connectors on the battery face the connectors on the computer.

4. Gently slide the battery into the battery bay until the latch clicks into place.

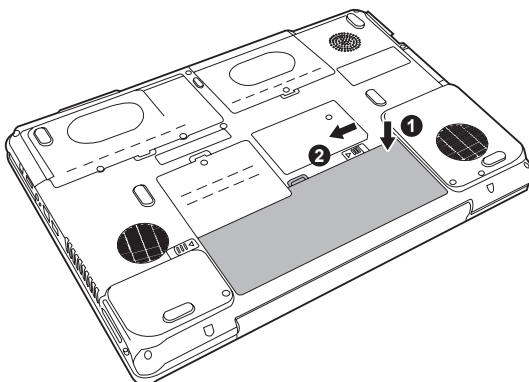

*Installing the battery pack*

## TOSHIBA Password Utility

The TOSHIBA Supervisor Password Utility provides two levels of password security: User and Supervisor.



*Passwords set in TOSHIBA Supervisor Password Utility are different from the Windows<sup>®</sup> login password.*

### User Password

To start the utility, point to or click the following items:

Launch **TOSHIBA Assist** → **SECURE** → **User Password**

#### ■ Registered

Click to register a password of up to 8 characters. After a password is set, you will be prompted to enter it when you start the computer.

#### ■ Not Registered

Click to delete a registered password. Before you can delete a password, you must first enter the current password correctly.

#### ■ Owner String (text box)

You can use this box to associate text with the password. After you enter text, click **Apply** or **OK**, then, each time the computer is switched on, this text will be displayed along with the prompt for the password.

## Supervisor password

If you set a supervisor password, some functions will be restricted when a user logs on with the user password. To set a supervisor password:

**TOSHIBA Assist** → **SECURE** → **Supervisor password**

This utility lets you do the following:

- Register or delete the supervisor password.
- Specify restrictions for general users.

## Starting the computer by password

If you have already registered a password, there is one way to start the computer:

- Enter the password manually.



*The password is necessary only if the computer was shut down in boot mode, not in Hibernation or Sleep mode.*

To enter a password manually, follow these steps:

1. Turn on the power as described in Chapter 3, [Getting Started](#). The following message will appear in the LCD:

**Enter Password [xxxxxxx]**



*At this point, the hotkeys **Fn + F1 to F9** do not work. They will function after you enter the password.*

2. Enter the Password.
3. Press **Enter**.



*If you enter the password incorrectly three consecutive times, the computer shuts down. You must turn on the computer again and re-enter the password.*

## Power-up modes

The computer has three power-up modes:

- Hibernation (saves data in memory to the hard disk)
- Sleep (power remains on, maintaining the data in memory, but the CPU and all other devices effectively enter a 'sleep' mode)
- Boot (does not save data in memory)



*Refer also to the section [Turning on the power](#) in Chapter 3, [Getting Started](#).*

## Panel power off/on

This feature makes the computer to enter Hibernation when the display panel is closed and turns it back on when the display panel is opened.



*If the panel power off function is enabled and you use Shut down Windows, do not close the display until the shut down function is completed.*

## System automatic Sleep/Hibernation

This feature automatically turns off the system in Sleep or Hibernation mode if the computer is not used for a set duration.

Refer to [Special features](#), in Chapter 1, [P200 Series Features](#) for an explanation of how to set the duration.

# Chapter 8

## HW Setup

This chapter explains how to use the TOSHIBA HW Setup utility to configure your computer. TOSHIBA HW Setup lets you configure settings for various hardware devices through a number of tabs titled General, Password, Display, Boot Priority, Keyboard, CPU, LAN, and USB.

### Accessing HW Setup

**Start → All Programs → TOSHIBA → Utilities → HWSetup.**

### HW Setup Window

The HW Setup window contains the following tabs: General, Password, Display, Boot Priority, Keyboard, LAN, and USB.

There are also these three buttons:

<b>OK</b>	Accepts your changes and closes the HW Setup window.
<b>Cancel</b>	Closes the window without accepting your changes.
<b>Apply</b>	Accepts all your changes without closing the HW Setup window.

#### **General**

This window displays the BIOS version and contains two buttons:

<b>Default</b>	Return all HW Setup values to the factory settings.
<b>About</b>	Display the HW Setup version.

#### **Setup**

This field displays BIOS Version and date.



*When finish BIOS update, please restart your computer and press F2 into BIOS setup manual and load BIOS default one time.*

## Password

This tab allows you to set or reset the user password for power on.

## Display

This tab lets you customize your computer's display settings for either the internal LCD screen or for an external monitor.

### Power On Display

This option allows you to select the display to be used when the computer is switched on.

<b>Auto-Selected</b>	Selects an external monitor if one is connected. Otherwise, it selects the internal LCD (Default).
<b>LCD + Analog RGB</b>	Selects both the internal LCD and external monitor for simultaneous display.

## CPU

This function lets you set the CPU operating mode.



*This option is displayed only for Core Duo/Solo processor based model.*

### Dynamic CPU Frequency Mode

This option lets you choose from the following settings:

<b>Dynamically Switchable</b>	CPU power consumption and clock speed automatic switching function is enabled. When the computer is in use, CPU operation is automatically switched when necessary (Default).
<b>Always Low</b>	CPU power consumption and clock speed automatic switching function is disabled. The CPU always runs at low power consumption and low speed.

## Boot Priority

### Boot Priority Options

This option sets the priority for booting the computer.

Select the boot priority from the drop down list.

You can override the settings and manually select a boot device by pressing one of the following keys while the computer is booting:

<b>U</b>	Selects the USB floppy disk drive.
<b>N</b>	Selects the Network.
<b>C</b>	Selects optical device.

To select the boot drive you want, follow the steps below.

1. Boot-up your computer and press **F12** to enter the boot menu.
2. The boot select screen will be displayed: HDD1, HDD2, CD/DVD, and LAN.
3. Use the upper/lower cursor keys to highlight the boot device you want and press **Enter**.

## Keyboard

### Wake-up on Keyboard

When this feature is enabled and the computer is in Sleep mode, you can turn on the computer by pressing any key. It is effective only for the internal keyboard and only when the computer is in Sleep mode.

<b>Enabled</b>	Enables the Wake-up on Keyboard feature.
<b>Disabled</b>	Disables the Wake-up on Keyboard function (Default).

## USB

### Legacy USB Support

Use this option to enable or disable legacy USB support. If your operating system does not support USB, you can still use a USB mouse, keyboard, and floppy disk drive by setting the Legacy USB Support option to enable.

<b>Enabled</b>	Enables Legacy USB Support.
<b>Disabled</b>	Disables Legacy USB Support.



## LAN

### Wake-up on LAN

This feature lets the computer's power be turned on when it receives a wake-up signal from the LAN.

<b>Enabled</b>	Enables Wake-up on LAN.
<b>Disabled</b>	Disables Wake-up on LAN (Default).



*The Wake-up LAN function is not supported on battery power in Hibernate/Power off mode, before you plan to use this function please make sure your AC power source is properly connected to the system.*



*Do not install or remove an optional memory module while Wake-up on LAN is enabled.*

### Built-in LAN

This feature enables or disables the Built-in LAN.

<b>Enabled</b>	Enables Built-in LAN function (Default).
<b>Disabled</b>	Disables Built-in LAN function.

# Chapter 9

## Optional Devices

Optional devices can expand the computer's capabilities and its versatility. This chapter describes connection or installation of the following types of devices, which are available from your TOSHIBA dealer:

### ***Cards/Memory***

- Express Card
- SD (Secure Digital) / SDHC(Secure Digital High Capacity) / MMC (Multi Media Card) / MS (Memory Stick) /MS Pro (Memory Stick Pro) / xD (xD-Picture Card) cards
- Memory modules

### ***Power devices***

- Battery pack
- AC adapter

### ***Peripheral devices***

- External monitor
- Television
- i.LINK (IEEE1394a)
- Security lock
- HDMI V1.2

## Express Card

The computer (depending on the model) is equipped with an Express Card expansion slot that can accommodate two standard module formats; an Express Card/34 module and an Express Card/54 module. An Express Card module is a small, modular add-in card technology based on PCI Express and Universal Serial Bus (USB) interfaces.

## Installing an Express Card

One Express Card connector is located on the right side of the computer. The computer's hot-install feature lets you install Express Card while the computer's power is on.

To install an Express Card, follow the steps below.

1. Insert the Express Card.
2. Press gently to ensure a firm connection.

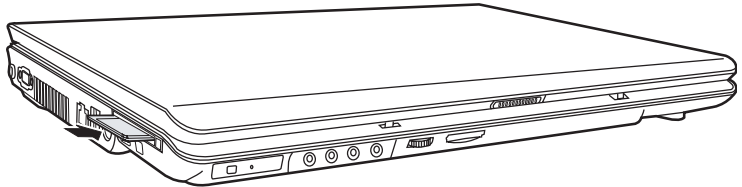

*Installing an Express Card*

After installing the card, refer to the card's documentation and check the configuration in Windows to make sure it is appropriate for your card.

## Removing an Express Card

1. Click the **Safety Remove Hardware** icon on the Task Bar.
2. Click the Express Card you want to remove.
3. Press the Express Card once to extend it.
4. Grasp the extended Express Card, and remove it.

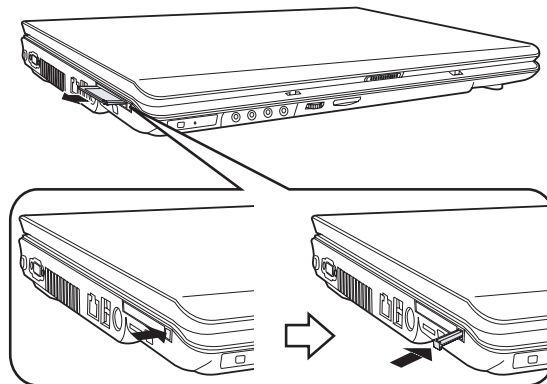

*Removing an Express Card*

## SD/SDHC/MMC/MS/MS Pro/xD Memory cards

The computer is equipped with a multiple digital media card slot that can accommodate SD/SDHC/MMC/MS/MS Pro/xD memory cards. These memory cards let you easily transfer data from devices, such as digital cameras and Personal Digital Assistants, which use flash-memory.

Card Type	Capacities
SD	up to 2 GB
SDHC	4 GB
MMC	up to 1 GB
MS	up to 128 MB, 256 MB (128 MB × 2, selectable)
MS Pro	up to 2 GB
xD	up to 2 GB



*Keep foreign objects out of the memory card slot. A pin or similar object can damage the computer's circuitry.*



*Do not format a memory card with Windows® as it might result in that card not being able to be used with some peripheral devices.*



*The Logo of SD memory card is .*



*The Logo of SDHC memory card is .*



*The card is designed so that it can be inserted only one way. Do not try to force the card into the slot.*



*Memory Stick Duo/PRO Duo and the Memory Stick adaptor are not compatible with the Multiple Digital Media Card slot. Do not insert Memory Stick Duo/PRO Duo into the slot. Data may be lost or damaged if you use any card other than those supported.*



*For more details on using memory cards, see manuals accompanying the cards.*

## Installing a memory card

To install a memory card:

1. Insert the memory card.
2. Press gently to ensure a firm connection.

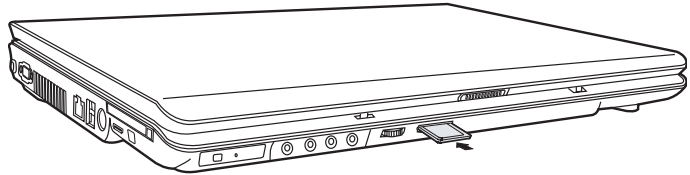

*Inserting a memory card*



*Make sure the memory card is oriented properly before you insert it. If Windows® fails to read the card, remove it then re-insert it.*



*The multiple digital media card slot only accepts one type of card at a time. Do not attempt to install more than one card as you risk damaging either the cards themselves or the computer.*

## Removing a memory card

To remove a memory card, follow the steps below:

1. Click the **Safely Remove Hardware** icon on the Taskbar.
2. Select a device, then click the **Stop** button. A confirmation dialog may appear, depending on how the device is registered with the system; if so, confirm that you want to remove the device.
3. Gently press the memory card inside the socket to eject it.
4. Grasp the card and remove it.

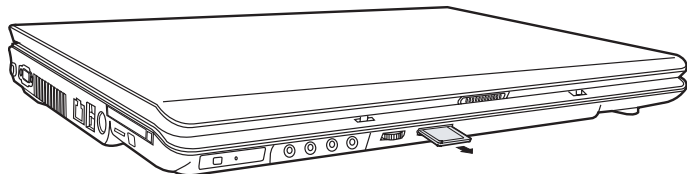

*Removing a memory card*



- *Make sure the memory card indicator is out before you remove the card or turn off the computer's power. If you remove the card or turn off the power while the computer is accessing the card you may lose data or damage the card.*
- *Do not remove the card while the computer is in Sleep or Hibernation mode. The computer could become unstable or data in the memory card could be lost.*
- *Do not turn off or place the computer into either Sleep Mode or Hibernation Mode while data is being transferred to or from the memory card. The system may become unstable or data in the memory card may be lost.*

## Memory card care



*Set the write-protect switch to the lock position, if you do not want to record data.*

1. Do not write to a memory card if the battery power is low. Low power could affect writing accuracy.
2. Do not remove a memory card while read/write is in progress.
3. The memory card is designed so that it can be inserted only one way. Do not try to force the card into the slot.
4. Do not leave a memory card partially inserted in the slot. Press the memory card until you hear it click into place.
5. Do not twist or bend memory cards.
6. Do not expose memory cards to liquids or store in humid areas or lay media close to containers of liquid.
7. After using a memory card, return it to its case.
8. Do not touch the metal part or expose it to liquids or let it get dirty.

## Memory expansion

You can install additional memory in the computer's memory module socket to increase the amount of RAM. This section describes how to install and remove a memory module.



- *Before you install or remove a memory module, turn off the computer with the Shut Down option in the Windows Start menu. If you install or remove a memory module while the computer is in Sleep or Hibernation mode, data will be lost.*
- *Some memory modules can be physically installed but are not compatible with the computer. In this case the computer will issue a warning.*

**CAUTION:** *If you want to upgrade system memory, you should only use certified modules. Ask your vendor or check the TOSHIBA web site for a list of approved memory products.*



*Insert the two memory modules of the same specifications and capacity into Slot A (Upper) and Slot B (Bottom) respectively. The computer will operate in dual channel mode.*

*You can access the inserted memory modules efficiently in dual channel.*

### Point to note about Memory Module Error

If you install a memory module that is not compatible with the computer, the Power indicator will flashes (on for 0.5 seconds, off for 0.5 seconds) in the following ways:

- If there is only an error in Slot A: repeatedly flashes orange twice, then blue.
- If there is only an error in Slot B: repeatedly flashes orange, then blue twice.
- If there is an error in Slot A and in Slot B: repeatedly flashes orange twice, then blue twice.

In all instances you should shut down the computer and remove the incompatible module(s).

### Installing Memory on Bottom Side



*If you use the computer for a long time, the memory modules will become hot. In this case, let the memory modules cool to room temperature before you replace them.*

Follow these steps to install a memory module:

1. Set the computer to boot mode and turn off the power.



*Do not try to install a memory module under the following conditions. You can damage the computer and the module.*

- a. The computer is turned on.
  - b. The computer was shut down using the Stand by mode.
  - c. Power to the optical disc drive has been turned on by the CD Power switch.
2. Remove all cables connected to the computer.
  3. Turn the computer upside down and remove the battery, refer to Chapter 7, [Power and Power-Up Modes](#).
  4. Loosen the one screw securing the memory module socket cover.

- Slide your fingernail or a thin object under the cover and lift it off.

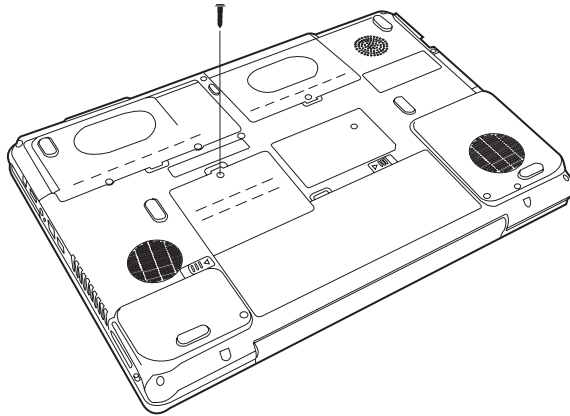

*Removing the memory module socket cover*

- Fit the module's connectors into the computer's connectors at about a 45 degree angle and press the module carefully to ensure a firm connection.



*Do not touch the connectors on the memory module or on the computer. Debris on the connectors may cause memory access problems.*

- Push the module down so it lies flat. Latches on either side will click into place to secure the module.

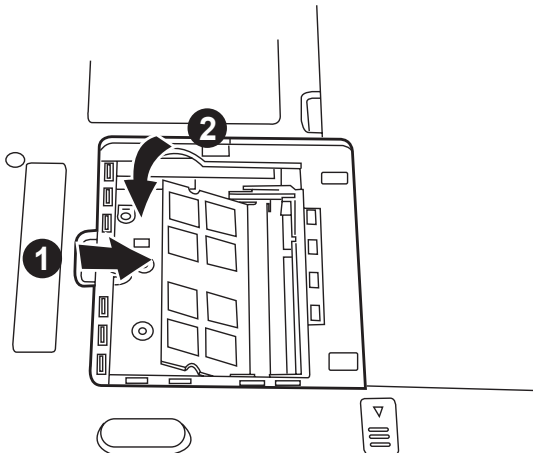

*Installing a module*

- Seat the cover and secure it with the screw.



9. Replace the battery pack as described in Chapter 7, *Power and Power-Up Modes*.
10. Turn the power on and make sure the added memory is recognized.

## Removing Memory on Bottom Side



*The Slot A is reserved for main memory, the upper slot. Use the slot B for expanded memory, the bottom slot. If only one card is installed, use the slot A.*

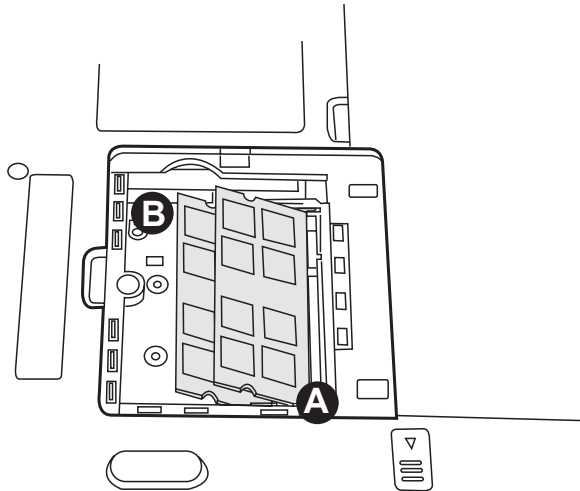

*If you use the computer for a long time, the memory modules will become hot. In this case, let the memory modules cool to room temperature before you replace them.*

To remove the memory module, make sure the computer is in boot mode then:

1. Be sure the power is off and all cables are disconnected from the computer.



*Do not try to remove a memory module with the computer turned on. You can damage the computer and the module.*

2. Turn the computer upside down and remove the battery and loosen the screw securing the memory module socket cover.
3. Slide your fingernail or a thin object under the cover and lift it off.
4. Push the latches to the outside to release the module. A spring will force one end of the module up.
5. Grasp the module and pull it out.



*Do not touch the connectors on the memory module or on the computer. Debris on the connectors may cause memory access problems.*

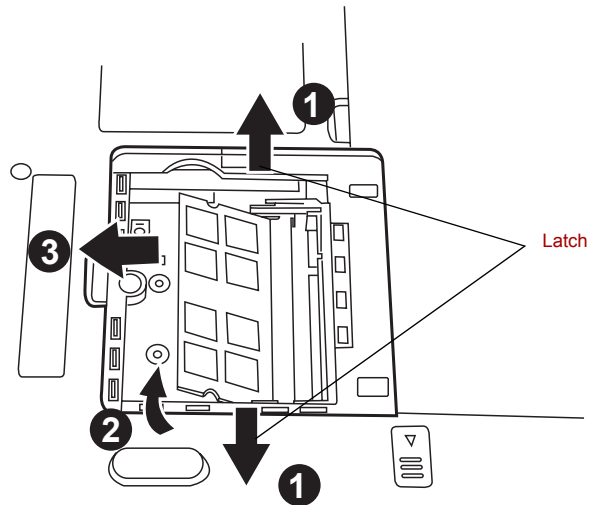

*Removing the memory module*

6. Seat the cover and secure its screw.
7. Replace the battery.

## Additional battery pack

You can increase the portability of the computer with additional battery packs. If you're away from an AC power source and your battery runs low, you can replace it with a freshly charged battery. See Chapter 7, *Power and Power-Up Modes*.

## Additional AC adapter

If you frequently carry the computer to different sites such as your home and office, having an AC adapter at each location reduces the weight and bulk of your load.

## External monitor

An external analog monitor can be connected to the external monitor port on the computer.

To connect a monitor, follow the steps below.

1. Turn the computer off.
2. Connect the monitor to the external monitor port.
3. Turn the monitor's power on.
4. Turn the computer on.

When you turn on the power, the computer automatically recognizes the monitor.

To change the display settings, press **Fn + F5**. If you disconnect the monitor before you turn the computer off, be sure to press **Fn + F5** to switch to the internal display. Refer to Chapter 6, *The Keyboard*, for details on using hot keys to change the display settings.

## Television

A television can be connected to the video out port on the computer.

To connect a television, follow the steps below.

1. Turn the computer off.
2. Use a video cable (not supplied) to connect the television to the video out port.
3. Turn the television on.
4. Turn the computer on.

You can use the hotkeys **Fn + F5** or use the **TV-Out** button to change the display device. Refer to Chapter 6, *The Keyboard*.

If a television is connected to the computer, set the TV type in Display Properties. Follow the steps below, based on the configuration of your computer:

### For ATI Mobility Radeon™ HD2400/HD2600\*

1. Click **Start → Control Panel → Personalization**.
2. Choose **Display Settings to change resolution and colors**.

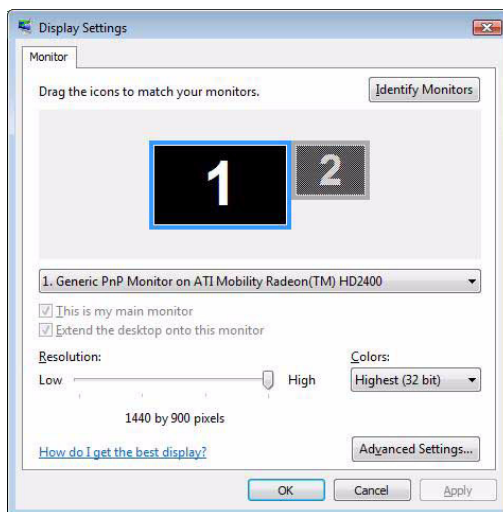

3. Click **Start and All Programs**.
4. Click **Catalyst Control Center**

5. Select **CCC**.
6. In **Catalyst Control Center** window, setup your television or CRT and Notebook displays.

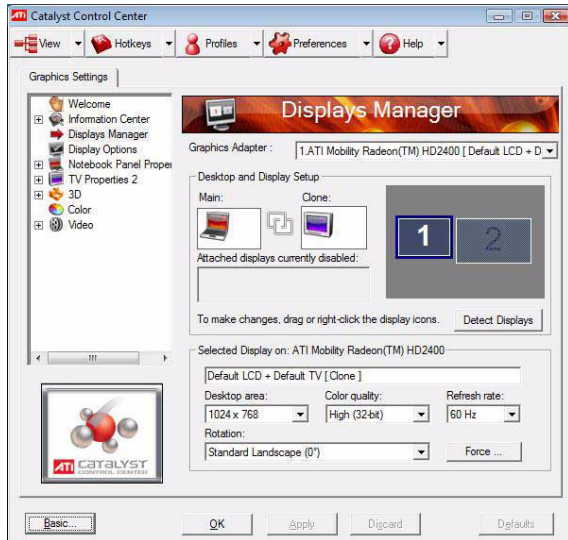

\* The availability of this feature is dependent on the model you purchased.

## HDMI

A HDMI monitor can be connected to the HDMI out put on the computer. To connect monitor, follow the steps as detailed below:



*As the port operation of all HDMI (High-Definition Multimedia Interface) monitors has not be confirmed, some HDMI monitors may not function properly.*

1. Click **Start** and click **All Programs**.
2. Click **Catalyst Control Center**.
3. Select **CCC**.
4. If you find Catalyst Control Center - Basic View, select **Advanced** then click **Next**.
5. At Catalyst Control Center windows, select **Displays Manager** from left select panel.

- Click **Desktop Area and Refresh Rate** to select the one of below format which is supported on this platform.

Country/Region	Signal Format*
Any	1080i HDTV
Any	720p HDTV
Any	576p EDTV
Any	480p EDTV

\* Lists the actual Signal Formats supported by the HDMI monitor you are using.

- Click **Apply** button.



Above operation is the way to select Desktop Area and Refresh Rate format directly. The resolution also can be selected on Display Manager Tab.

## Connecting the HDMI out port

- Plug one end of the HDMI out cable into the HDMI out port of the HDMI device.
- Plug one end of the HDMI out cable into the HDMI out port on your computer.

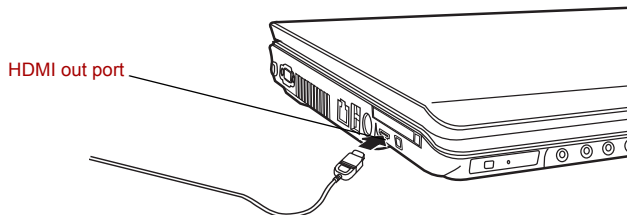

Connecting the HDMI out port

## Settings for display video on HDMI

To view video on the HDMI device, be sure to configure the following settings otherwise you may find that nothing is displayed.



End user refer page 8-9 and Appendix B-6, for more detail, to out put HDMI device.



- Be sure to use the **Fn + F5** HotKey to select the display device before starting to play video. Do not change the display device while playing video.
- Do not change the display device under the following conditions.
  - While data is being read or written.
  - While communication is being carried out.

## Settings for audio on HDMI

To set the audio device to use the HDMI, follow the steps below.

1. Go to **Start** then select **Control Panel**.
2. Click **Hardware and Sound** then select **Sound**. If you are in control panel classic view, select **Sound** directly.
3. In Sound window, select **Digital Output Device (HDMI)** then click **Set Default** once.

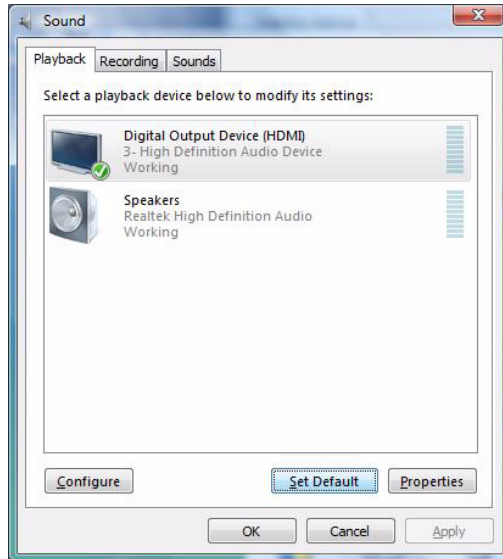

*Selecting Audio HDMI output*



*Please follow above steps to change back to speakers after you plug out HDMI connector.*

## Remote Controller

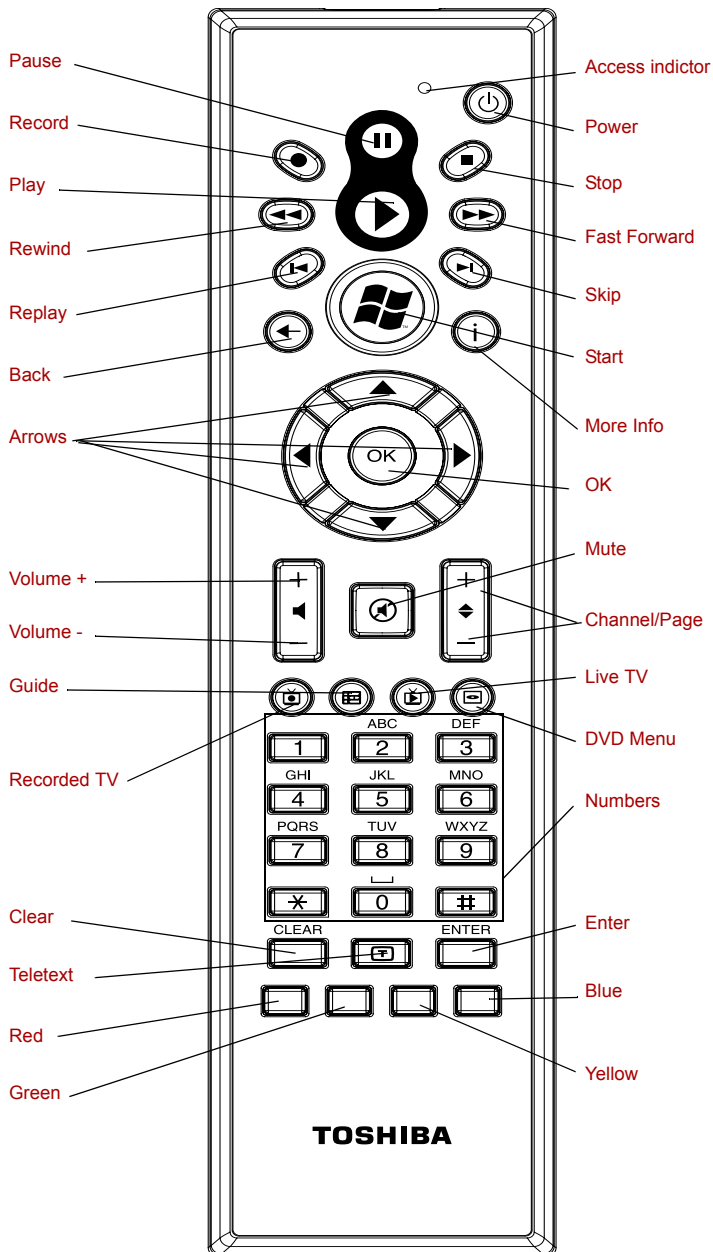

*Remote Controller*



**Power** Starts or terminates the operating system. This button functions like the Power button of your computer. By default, the Sleep Mode is equivalent to the Power Off state of your computer. To change the setting, click **Start → Control Panel → System and Maintenance → Power Options**. The following 4 options are available: Do nothing, Sleep, Hibernation, and Shut down.

**Access indicator** This indicator will glow while the Remote Controller is sending signals to the computer. Please note that this indicator will not light after the battery has been completely discharged.



**Record** Records the selected television program and store it on your hard disk drive.



**Stop** Stops the media currently playing.



**Pause** Pauses an audio or video track, and live or recorded TV programs.



**Play** Plays the selected media.



**REW (Rewind)** Moves the media (video, DVD, music, and so on) backwards.



**FWD (Fast Forward)** Moves the media (video, DVD, music, and so on) forwards.



**Replay** Moves the media backwards (seven seconds for videos and live TV, one music track or one DVD chapter at a time).



**Skip** Moves the media forwards (30 seconds for videos and live TV, one music track or one DVD chapter).



**Back** Displays the previous window.



**More Info** The button provides more details on a TV program than is listed in the Guide.







**Arrows** Moves the cursor to navigate within Media Center windows.



**OK** Selects the desired action or window option. It acts like the **ENTER** Key. If watching TV in full screen mode, pressing **OK** switches back to the previous viewed channel. Press again to toggle back. It acts the same way as a Jump button on some TV remote controls.

**Volume +** Increases the volume while watching TV, viewing DVD's or replaying CD's.



	<b>Volume -</b>	Decreases the volume while watching TV, viewing DVD's or replaying CD's.
	<b>Start</b>	Opens Media Center to the main window.
	<b>Channel/Page up (+) and down (-)</b>	Changes the TV channel or moves a page up and down, depending on the available options.
	<b>Mute</b>	Turns your computer sound off.
	<b>Recorded TV</b>	Allows you to start recording of TV programs. The Recorded TV feature of Media Center will be activated.
	<b>Guide</b>	Opens the Television Program Guide to display available TV channels and programs to watch and record.
	<b>Live TV</b>	A shortcut to the full screen view. It also takes you to the current point in a live TV program after pausing live TV.
	<b>DVD Menu</b>	Opens the main menu on a DVD movies, if available.
	<b>Numbers</b>	<p>Allows you to select a channel or chapter number while watching TV, or CD/DVD replay.</p> <p>Numbers, letters or symbols can be entered.</p> <p>To select a channel or chapter number of two or more digits, press the number sequentially. For example, press the "1" button and then the "0" button to select the number 10.</p>
	<b>Clear</b>	Deletes entered numbers, letters or symbols.
	<b>Enter</b>	The OK button on the Remote Controller has the same functions.
	<b>Red, Green, Yellow and Blue buttons</b>	<p>It jumps to a registration link.</p> <p>These buttons are not provided with some models.</p>
	<b>Teletext</b>	<p>Starts or terminates the Teletext mode.</p> <p>This button is not provided with some models.</p>

## Using the Remote Controller

This computer includes a remote control unit, which allows you to control some of your computers from distant location.



- *The Remote Controller is designed specially for this computer.*
- *Some application programs may not support remote control functions.*

## Operational range of the Remote Controller

Point the Remote controller at your computer and press a button. The operational angle and distance are described below.

<b>Distance</b>	Within 5 m from the infrared receiver window.
<b>Angle</b>	Within a 30 degree horizontal and 15 degree vertical range of the infrared receiver window.

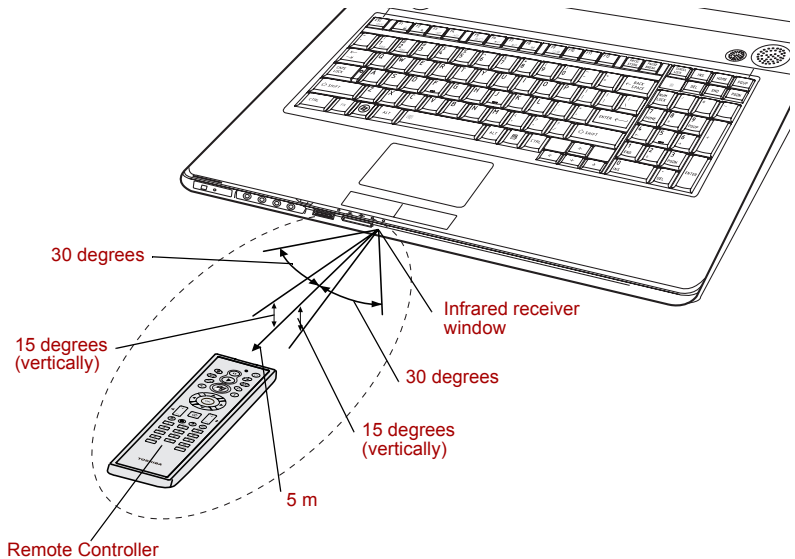

\* The appearance of the provided Remote Controller may vary from model to model.

### *Operation range of the remote control*



Even if within the effective scope as described above, the remote control may malfunction or not work correctly in the following cases.

- When an obstacle stands between the infrared receiver window or your computer and the Remote Controller.
- When direct sunlight or strong fluorescent light strikes the infrared receiver window.
- When the infrared receiver window or the infrared emission part of the Remote Controller is dirty.
- When other computers which use an infrared remote controller are used near to your computer.
- When a low battery condition is present.

## Installing/Removing batteries

Be sure to install the dry batteries provided with this product using the Remote Controller.

The procedures for installing and removing the batteries vary depending on the type of the Remote Controller. Check the type and then install or remove the batteries as instructed.



*Store the battery for the remote control beyond the reach of children. If a child swallows a battery, this might result in choking. If it happens, contact a doctor immediately.*



*Observe the following precautions when using the battery of the Remote Controller.*

- *Do not use batteries other than those specified.*
- *Ensure that you insert the batteries with their polarities correctly aligned (+ or -).*
- *Do not recharge, heat, disassemble or shot the battery, or put it into a fire or flame.*
- *Do not use a battery whose 'recommended expiration date' has been reached, or is completely discharged.*
- *Do not use different type of battery or old and new batteries at the same time.*
- *Do not carry the battery together with metal necklaces, hairpins or other metal accessories.*
- *When storing or disposing of used batteries, make sure to put some insulation tape on their terminal (+ and -) to avoid short-circuits.*

*If these precautions are not followed, heating, fluid leakage or explosion may occur. This may cause burns or personal injury. If battery fluid gets on your skin or clothes, wash immediately with clean water. If battery fluid gets in your eyes, rinse your eyes with clean water immediately and see a doctor. Do not touch the battery fluid on instruments or devices with bare hands. Wipe off with a cloth or paper towel.*

## Type of battery that can be used for the Remote Controller

When batteries shipped with the Remote Controller are discharged, replace them with commercially available AA manganese batteries or AA alkaline batteries. Other types of battery should not be used.

### *Installing the batteries*

1. open the battery cover on the back of the Remote Controller. Slide the Cover in the direction of the arrow to remove the cover.

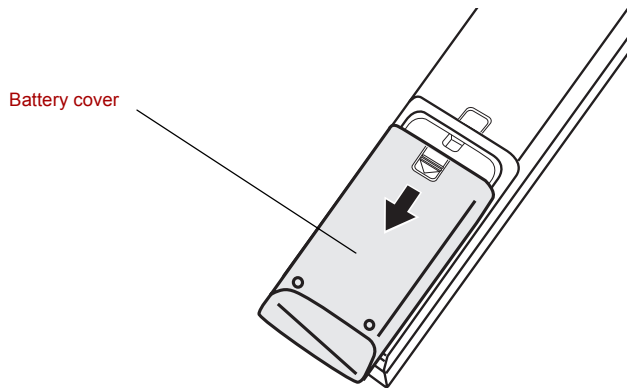

### *Opening the battery cover*

2. Insert the batteries in place. Be sure to place the batteries with their polarities (+ and -) in the correct position.

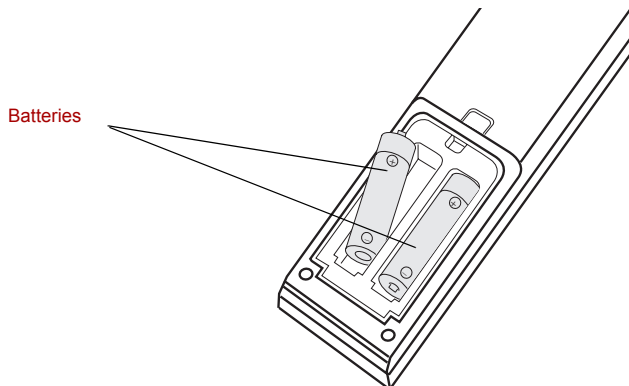

### *Inserting the batteries*

3. Close the battery cover. Close the cover securely until it clicks.

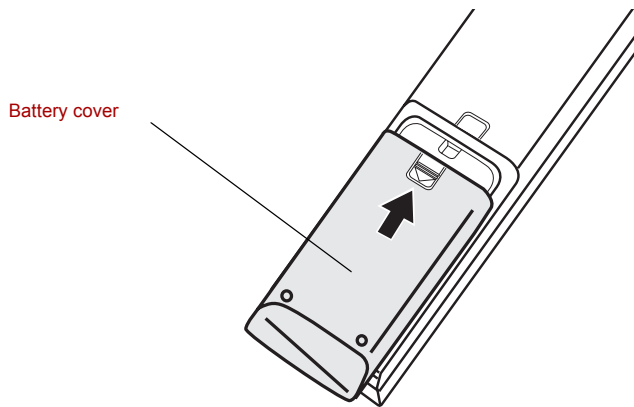

*Closing the battery cover*

### **Replacing the batteries**

When the batteries in their Remote Controller reach the end of their life, the Remote Controller may not operate correctly or work only within a short distance from your computer. In this instance, you should purchase new batteries and replace the discharged ones.

1. Open the battery cover on the back of the Remote Controller.
2. Replace the batteries. Be sure to place the batteries with their polarities (+ and -) in the correct position.

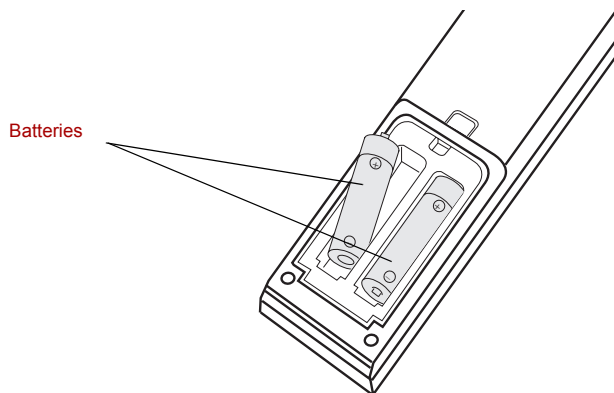

*Removing the batteries*

3. Close the battery cover. Close the cover securely until it clicks.

## i.LINK (IEEE1394a)

i.LINK (IEEE1394a) is used for high-speed data transfer for a range of compatible devices such as:

- Digital video cameras
- Hard disk drives
- MO drives
- Optical disc drives



*i.LINK uses a four-pin connector, which does not carry electric current. External devices will need their own power supply.*

### Precautions

- Make a back-up of your data before transferring it to the computer. There is a possibility that the original data will be damaged. There is a particular risk that some frames will be deleted in the case of digital video transfer.
- Do not transfer data in areas where static electricity is easily generated or in areas subjected to electronic noise. Data can be destroyed.
- If you are transferring data through an IEEE1394a hub, do not connect or disconnect other devices from the hub during data transfer. There is a likelihood that data will be damaged. Connect all devices to the hub before you turn on the computer's power.

### Connecting

1. Make sure the connectors are properly aligned and plug the i.LINK (IEEE1394a) cable into the computer.
2. Plug the other end of the cable into the device.

Note the following when you use i.LINK:

- You may need to install drivers for your i.LINK devices.
- Not all i.LINK devices have been tested. Therefore, compatibility with all i.LINK devices cannot be guaranteed.
- Use S100, S200 or S400 cables no longer than three meters.
- Some devices might not support Sleep or automatic off functions.
- Do not connect or disconnect an i.LINK device while it is using an application or when the computer is automatically shutting it down to save power. Data might be destroyed.

## Disconnecting

1. Click the **Safely Remove Hardware** icon on the Task Bar.
2. Point to **i.LINK (IEEE1394a) device** and click.
3. Disconnect the cable from the computer then from the i.LINK device.



*Refer also to the documentation that came with your i.LINK device.*

## Security lock

A security lock enables you to anchor your computer to a desk or other heavy object to help prevent unauthorized removal of the computer.

Attach one end of a cable to the desk and the other end to the security lock slot on the right side of the computer.

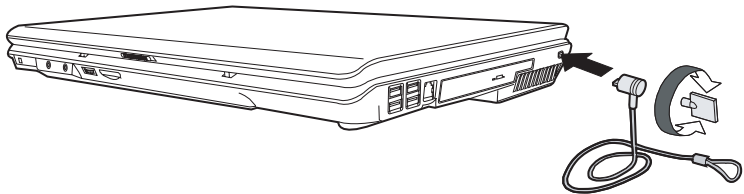

*Security lock*

# Chapter 10

## Troubleshooting

TOSHIBA designed the computer for durability. However, should problems occur, following the procedures in this chapter can help to determine the cause.

All readers should become familiar with this chapter. Knowing what might go wrong can help prevent problems from occurring.

### Problem solving process

Resolving problems will be much easier if you observe the following guidelines:

- Stop immediately when you recognize a problem exists. Further action may result in data loss or damage. You may destroy valuable problem-related information that can help solve the problem.
- Observe what is happening. Write down what the system is doing and what actions you performed immediately before the problem occurred. If you have a printer attached, print a copy of the screen using **PRTS**.
- Isolate the problem. Using the tools available to you, such as the troubleshooting tips in this chapter, try to discover the specific actions that caused the problem.

The questions and procedures offered in this chapter are meant as a guide, they are not definitive problem solving techniques. Many problems can be solved simply, but a few may require help from your dealer. If you find you need to consult your dealer or others, be prepared to describe the problem in as much detail as possible.



## Preliminary checklist

Consider the simplest solution first. The items in this checklist are easy to fix and yet can cause what appears to be a serious problem.

- Make sure you turn on all peripheral devices before you turn on the computer. This includes your printer and any other external device you are using.
- Before you attach an external device, turn the computer off. When you turn the computer back on it recognizes the new device.
- Make sure all options are set properly in the setup program.
- Check all cables. Are they correctly and firmly attached? Loose cables can cause signal errors.
- Inspect all connecting cables for loose wires and all connectors for loose pins.
- Check that the optical disc drive is correctly inserted.

Make notes of your observations and keep them in a permanent error log. This will help you describe your problems to your dealer. If a problem recurs, the log will help you identify the problem faster.

## Analyzing the problem

Sometimes the system gives clues that can help you identify why it is malfunctioning. Keep the following questions in mind:

- Which part of the system is not operating properly: keyboard, disk drives, hard disk drive, printer, display. Each device produces different symptoms.
- Is the operating system configuration set properly? Check the configuration options.
- What appears on the display screen? Does it display any messages or random characters? Print a copy of the screen if you have a printer attached. Look up the messages in the software and operating system documentation. Check that all connecting cables are correctly and firmly attached. Loose cables can cause erroneous or intermittent signals.
- Do any indicators light? Which ones? What color are they? Do they stay on or blink? Write down what you see.
- Do you hear any beeps? How many? Are they long or short? Are they high pitched or low? Is the computer making any unusual noises? Write down what you hear.

Record your observations so you can describe them to your dealer.

<p><b>Software</b></p>	<p>The problems may be caused by your software. If you cannot load a software package, the media may be damaged or the program might be corrupted. Try loading another copy of the software.</p> <p>If an error message appears while you are using a software package, check the software documentation. These documents usually include a problem solving section or a summary of error messages.</p> <p>Next, check any error messages in the operating system documentation.</p>
<p><b>Hardware</b></p>	<p>If you cannot find a software problem, check your hardware. First run through the items in the preliminary checklist above. If you still cannot correct the problem, try to identify the source. The next section provides checklists for individual components and peripherals.</p>

## Hardware and system checklist

This section discusses problems caused by your computer's hardware or attached peripherals. Basic problems may occur in the following areas:

- System start-up
- Self test
- Power
- Battery
- Keyboard
- LCD panel
- Hard disk drive
- Password
- i.LINK (IEEE1394)
- Wireless LAN
- Monitor
- Sound system
- Pointing Device
- USB
- TV output signal
- LAN
- Sleep/Hibernation
- Memory expansion
- Modem
- DVD Super Multi drive supporting double layer disc recording
- HD DVD drive supporting disc recording
- Disk drive
- Real Time Clock
- HDMI
- Web Camera
-

## System start-up

When the computer does not start properly, check the following items:

- Self Test
- Power Sources
- Power-on Password

## Self test

When the computer starts up, the self test will be run automatically, and the following will be displayed:

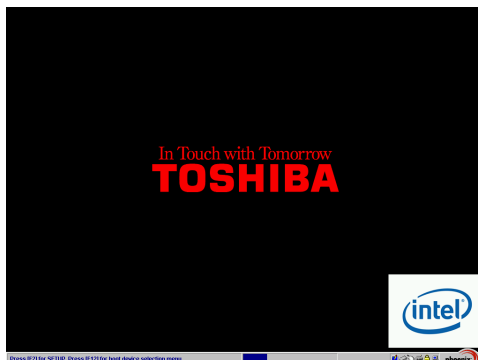

(This screen image is one of the examples. You may see the different screen image depending on the model you purchased.)

This message remains on the screen for a few seconds.

If the self test is successful, the computer tries to load the operating system based around how the Boot Priority option is set within the computer's BIOS setup.

If any of the following conditions are present, the self test failed:

- The computer stops and does not proceed to display information or messages except the TOSHIBA logo.
- Random characters appear on the screen, and the system does not function normally.
- The screen displays an error message.

Turn off the computer and check all cable connections as well as memory module connections. If the test fails again, contact your dealer.

## Power

When the computer is not plugged into an AC outlet, the battery pack is the primary power source. However, your computer has a number of other power resources, including an intelligent power supply and Real Time Clock battery. These resources are interrelated and any one could affect apparent power problems. This section provides check lists for AC power and the battery. If you cannot resolve a problem after following them, the cause could lie with another power resource. In such cases you should contact your dealer.

### *Overheating power down*

If the computer's internal temperature becomes too high, the computer will automatically shut down

### *AC power*

If you have trouble turning on the computer with the AC adapter connected, check the **DC IN** indicator. Refer to Chapter7, *Power and Power-Up Modes*, for more information.

Problem	Procedure
AC adapter doesn't power the computer ( <b>DC IN</b> indicator does not glow blue).	<p>Check the connections. Make sure the cord is firmly connected to the computer and a power outlet.</p> <p>Check the condition of the cord and terminals. If the cord is frayed or damaged, replace it. If the terminals are soiled, wipe them with cotton or a clean cloth.</p> <p>If the AC adapter still does not power the computer, contact your dealer.</p>

## Battery

If you suspect a problem with the battery, check the **DC IN** indicator as well as the indicators for the battery. For information on indicators and battery operation see Chapter 7, *Power and Power-Up Modes*.

Problem	Procedure
Battery doesn't power the computer.	The battery may be discharged. Connect the AC power cord to charge the battery.
Battery doesn't charge when the AC power cord is attached. ( <b>Battery</b> indicator does not glow amber.)	<p>If the battery is completely discharged, it will not begin charging at once. Wait a few minutes.</p> <p>If the battery still does not charge, make sure the outlet is supplying power. Plug in an appliance and see if it works. If it doesn't, try another power source.</p> <p>Check whether the battery is hot or cold. If the battery is too hot or too cold, it will not charge properly. Let it reach room temperature.</p> <p>Unplug the AC adapter and remove the battery to make sure the terminals are clean. If necessary wipe them with a soft dry cloth dipped in alcohol.</p> <p>Connect the AC adapter and replace the battery.</p> <p>Check the <b>Battery</b> indicator. If it does not glow, let the computer charge the battery for at least 20 minutes. If the <b>Battery</b> indicator glows after 20 minutes, let the battery continue to charge for at least another 20 minutes before turning on the computer.</p> <p>If the indicator still does not glow, the battery may be at the end of its operating life. Replace it.</p> <p>If you do not think the battery is at the end of its operating life, see your dealer.</p>
Battery doesn't power the computer as long as expected.	Check the power consumption settings in the Power Options. Consider using a power saving mode.

## Keyboard

Keyboard problems can be caused by your setup configuration. For more information refer to Chapter 6, *The Keyboard*.

Problem	Procedure
Output to screen is garbled.	Make sure the software you are using is not remapping the keyboard. Remapping involves reassigning the meaning of each key. See your software's documentation. If you are still unable to use the keyboard, consult your dealer.

## LCD panel

Problem	Procedure
Lines appear broken.	Check if you are in DOS mode. In DOS, lines may appear broken, because of the LCD screen's higher resolution. The Windows display should appear normal.
No display.	Press the Hotkey <b>Fn + F5</b> to change the display priority and ensure it is not set for an external monitor. Make sure instant security was not activated. Try entering your password, if you have one registered. Or, turn the power off and back on to clear instant security.
Problems above remain unresolved or other problems occur.	Refer to your software's documentation to determine if the software is causing the difficulty. Contact your dealer if the problems continue.

## Hard disk drive

Problem	Procedure
Computer does not boot from hard drive.	Insert a system disk and reboot. There may be a problem with your operating system files. Refer to your operating system documentation.
Slow performance	Your files may be fragmented. Run SCANDISK and defragmenter to check the condition of your files and disk. Refer to your operating system documentation or online HELP for information on running SCANDISK and the defragmenter. Contact your dealer if the problems continue.

## Password

Problem	Procedure
Cannot enter password	Refer to Chapter 7, <i>Power and Power-Up Modes</i> .

## i.LINK (IEEE1394)

Problem	Procedure
i.LINK device does not function	<p>Make sure the cable is securely connected to the computer and to the device.</p> <p>Make sure the device's power is turned on.</p> <p>Reinstall the drivers. Open the Windows Control Panel and double-click the <b>Add New Hardware</b> icon. Follow the on-screen directions.</p> <p>Restart Windows.</p> <p>If problems persist, contact your dealer.</p>

## Wireless LAN

If the following procedures do not restore LAN access, consult your LAN administrator. For more information on wireless communication, refer to Chapter 4, *Operating Basics*.

Problem	Procedure
Cannot access Wireless LAN	<p>Make sure the computer's wireless communication switch is set to on.</p> <p>Use the ConfigFree program that comes pre-installed in your computer to see LAN status.</p> <p>If problems persist, consult your LAN administrator.</p>

## Monitor

Refer also to Chapter 9, *Optional Devices*, and to your monitor's documentation.

Problem	Procedure
Monitor does not turn on	<p>Make sure that the external monitor's power switch is on. Confirm that the external monitor's power cable is plugged into a working power outlet.</p>

Problem	Procedure
No display	<p>Try adjusting the contrast and brightness controls on the external monitor.</p> <p>Press hotkeys <b>Fn + F5</b> to change the display priority and make sure it is not set for the internal display.</p>
Display error occurs	<p>Check that the cable connecting the external monitor to the computer is attached firmly.</p> <p>If problems persist, contact your dealer.</p>
Monitor goes into panning mode	<p>Check your monitor specification. It might not support the selected resolution and refresh rate. The resolution on the monitor might go into panning mode when wide screen resolution is selected. Refer to Appendix B, <i>Display Modes</i>.</p>

## Sound system

Problem	Procedure
No sound is heard	<p>Adjust the volume control dial.</p> <p>Check the software volume settings.</p> <p>If appropriate, make sure the headphone connection is secure. Check Windows Device Manager and ensure the sound function is enabled and that settings for I/O address, interrupt level and DMA are correct for your software and do not conflict with other hardware devices that you have connected to the computer.</p> <p>If problems persist, contact your dealer.</p>

## Pointing device

If you are using a USB mouse, also refer to the [USB](#) section in this chapter and to your mouse documentation.

### *TouchPad*

Problem	Procedure
On-screen pointer does not respond to Pad operation	<p>The system might be busy. If the pointer is shaped as an hourglass, wait for it to resume its normal shape and try again to move it. You may also press <b>Fn + F9</b> to enable the TouchPad and then try again to move it.</p>



Problem	Procedure
Double-tapping does not work	<p>Try changing the double-click speed setting in the mouse control utility.</p> <ol style="list-style-type: none"> <li>1. Open the <b>Control Panel</b>, select the <b>Mouse</b> icon and press <b>Enter</b>.</li> <li>2. Click the <b>Buttons</b> tab.</li> <li>3. Set the double-click speed as instructed and click <b>OK</b>.</li> </ol>
The mouse pointer moves too fast or too slow	<p>Try changing the speed setting in the mouse control utility.</p> <ol style="list-style-type: none"> <li>1. Open the <b>Control Panel</b>, select the <b>Mouse</b> icon and press <b>Enter</b>.</li> <li>2. Click the <b>Pointer Options</b> tab.</li> <li>3. Set the speed as instructed and click <b>OK</b>.</li> </ol> <p>If problems persist, contact your dealer.</p>

### USB mouse

Problem	Procedure
On-screen pointer does not respond to mouse movement	<p>The system might be busy. If the pointer is shaped as an hourglass, wait for it to resume its normal shape and try again to move it.</p> <p>Make sure the mouse is properly connected to the USB port.</p>
Double-clicking does not work	<p>Try changing the double-click speed setting in the mouse control utility.</p> <ol style="list-style-type: none"> <li>1. Open the <b>Control Panel</b>, select the <b>Mouse</b> icon and press <b>Enter</b>.</li> <li>2. Click the <b>Buttons</b> tab.</li> <li>3. Set the double-click speed as instructed and click <b>OK</b>.</li> </ol>
The mouse pointer moves too fast or too slow	<p>Try changing the speed setting in the mouse control utility.</p> <ol style="list-style-type: none"> <li>1. Open the <b>Control Panel</b>, select the <b>Mouse</b> icon and press <b>Enter</b>.</li> <li>2. Click the <b>Pointer Options</b> tab.</li> <li>3. Set the speed as instructed and click <b>OK</b>.</li> </ol>
The mouse pointer moves erratically	<p>The mouse might be dirty. Refer to your mouse documentations for instructions on cleaning.</p> <p>If problems persist, contact your dealer.</p>

## USB

Refer also to your USB device's documentation.

Problem	Procedure
USB device does not work	<p>Check for a firm cable connection between the USB ports on the computer and the USB device.</p> <p>Make sure the USB device drivers are properly installed. Refer to your Windows documentation for information on checking the drivers.</p> <p>If problems persist, contact your dealer.</p>

## TV output signal

Problem	Procedure
Display on TV is poor	<p>Make sure the TV type is correct for your area: NTSC (US) or PAL (Europe).</p>
No display	<p>Try adjusting the contrast and brightness controls on the external monitor.</p> <p>Press hotkeys <b>Fn + F5</b> to change the display. Refer to Chapter 6, <i>The Keyboard</i>.</p> <p>If problems persist, contact your dealer.</p>



*If you turn the computer off in Sleep Mode while the display is on a TV, the computer will select either the internal LCD or an external computer CRT as the display device the next time it is switched on.*

## LAN

Problem	Procedure
Cannot access LAN or the Wake up on LAN feature does not work	<p>Check for a firm cable connection between the LAN hub.</p> <p>Make sure the AC adapter is connected. You cannot access a LAN using the computer's battery power.</p> <p>If problems persist, consult your LAN administrator.</p>

## Sleep/Hibernation

Problem	Procedure
The system will not enter Sleep/Hibernation	<p>Is Windows Media Player open? The system might not enter Sleep/Hibernation, if Windows Media Player is either playing a selection or finished playing a selection. Close Windows Media Player before you select Sleep/Hibernation.</p> <p>If problems persist, contact your dealer.</p>

## Memory expansion

Refer also to Chapter 9, *Optional Devices*, for information on installing memory modules.

Problem	Procedure
The computer hangs up and issues beep sounds. (A long beep, three short beeps, three short beeps, and then a long beep.)	<p>Make sure the memory module installed in the expansion slot is compatible with the computer.</p> <p>If an incompatible module has been installed, follow the steps below.</p> <ol style="list-style-type: none"> <li>1. Turn off the power.</li> <li>2. Disconnect the AC adapter and all peripheral devices.</li> <li>3. Remove the battery pack.</li> <li>4. Remove the memory module.</li> <li>5. Replace the battery pack and/or connect the AC adapter.</li> <li>6. Turn on the power.</li> </ol> <p>If problems persist, contact your dealer.</p>

## Modem

Problem	Procedure
Communication software can't initialize the modem	Make sure the computer's internal modem settings are correct. Refer to Phone and Modem Options Properties in the Control Panel.
You can hear a dial tone but can't make a call	If the call is going through a PBX machine, make sure the communication application's tone dial detection feature is disabled.
You place a call, but a connection can't be made	Make sure the settings are correct in your communications application.

Problem	Procedure
After making a call you can't hear a ring	Make sure the tone or pulse selection in your communications application is set correctly.
Communication is cut off unexpectedly	The computer will automatically cut off communication when connection with the carrier is not successful for a set time interval. Try lengthening this time interval.
A <b>CONNECT</b> display is quickly replaced by <b>NO CARRIER</b>	Check the error control setting in your communications application.
Character display becomes garbled during a communication	In data transmission, make sure the parity bit and stop bit settings correspond with those of the remote computer.  Check the flow control and communication protocol.
You cannot receive an incoming call	Check the "rings before auto answer" setting in your communications application.  If problems persist, contact your dealer.

## DVD Super Multi drive supporting double layer disc recording

For more information, refer to Chapter 5, *About the HD DVD*.

Problem	Procedure
You cannot access a disc in the drive	Make sure the drive's drawer is securely closed. Press gently until it clicks into place.  Open the drawer and make sure the disc is properly seated. It should lie flat with the label facing up.  A foreign object in the drawer could block laser light from reading the disc. Make sure there is no obstruction. Remove any foreign object.  Check whether the disc is dirty. If it is, wipe it with a clean cloth dipped in water or a neutral cleaner. See the <i>Media Care</i> section in Chapter 4 for details on cleaning.

Problem	Procedure
Some discs run correctly, but others do not	<p>The software or hardware configuration may be causing a problem. Make sure the hardware configuration matches your software's needs. Check the disc's documentation.</p> <p>Check the type of disc you are using. The drive supports:</p> <p>DVD: DVD-ROM, DVD-Video, DVD-R, DVD-RW, DVD+R, DVD+RW, DVD-RAM, DVD+R (Double Layer), DVD-R (dual Layer)</p> <p>CD: CD-DA, CD-Text, Photo CD (single/multi-session), CD-ROM Mode 1, Mode 2, CD-ROM XA Mode 2 (Form1, Form2), Enhanced CD (CD-EXTRA), CD-G (Audio CD only)</p> <p>Check the region code on the DVD. It must match that on the DVD Super Multi drive.</p>
Cannot write correctly	<p>If you have trouble writing, make sure you are observing the following precautions:</p> <ul style="list-style-type: none"><li>■ Use only media recommended by TOSHIBA.</li><li>■ Do not use the mouse or keyboard during writing.</li><li>■ Use only the software supplied with the computer for recording.</li><li>■ Do not run or start other software during writing.</li><li>■ Do not jar the computer during writing.</li><li>■ Do not connect/ disconnect external devices or install/remove internal cards during writing.</li></ul> <p>If problems persist, contact your dealer.</p>

## HD DVD-R or HD DVD-ROM drive supporting disc recording

For more information, refer to Chapter 5, *About the HD DVD*.

Problem	Procedure
You cannot access a CD/DVD/HD DVD in the drive	<p>Make sure the drive's drawer is securely closed. Press gently until it clicks into place.</p> <p>Open the drawer and make sure the disc is properly seated. It should lie flat with the label facing up.</p> <p>A foreign object in the drawer could block laser light from reading the disc. Make sure there is no obstruction. Remove any foreign object.</p> <p>Check whether the CD, DVD, or HD DVD is dirty. If it is, wipe it with a clean cloth dipped in water or a neutral cleaner. See the <i>Media Care</i> section in Chapter 4 for details on cleaning.</p>
Some CD/DVD/HD DVDs run correctly, but others do not	<p>The computer's software or hardware configuration may be causing a problem - ensure that these configurations match the requirements of the CD/DVD/HD DVD media (refer to the CD's, DVD's, or HD DVD's documentation if available).</p> <p>HD DVD: HD DVD-ROM (Single-sided Single-Layer), HD DVD-ROM (Single-sided Dual-Layer), HD DVD-R (Single-sided Single-Layer), HD DVD-R (Single-sided Dual-Layer), HD DVD-Video, HD DVD (Twin format disc)</p> <p>DVD: DVD-ROM, DVD-Video, DVD-R/-R (Dual Layer), DVD+R/+R (Double Layer), DVD-RW, DVD+RW, DVD-RAM</p> <p>CD: CD-DA, CD-Text, Photo CD. (single/multi-session), CD-ROM Mode 1, Mode 2, CD-ROM XA Mode 2 (Form1, Form2), Enhanced CD (CD-EXTRA), Addressing Method 2</p> <p>For DVD Videos, you should check the region coding on the DVD to ensure that it matches that on the HD DVD-ROM drive. For reference, region codes are listed in the Optical disc drives section in Chapter 2, <i>The Grand Tour</i> in the Online manual.</p>

Problem	Procedure
Cannot write correctly	<p>If you have trouble writing, make sure you are observing the following precautions:</p> <ul style="list-style-type: none"> <li>■ Use only media recommended by TOSHIBA.</li> <li>■ Do not use the mouse or keyboard during writing.</li> <li>■ Use only the software supplied with the computer for recording.</li> <li>■ Do not run or start other software during writing.</li> <li>■ Do not jar the computer during writing.</li> <li>■ Do not connect/ disconnect external devices or install/remove internal cards during writing.</li> </ul> <p>If problems persist, contact your dealer.</p>

### Disk drive

For information on disk care refer to Chapter 4, *Operating Basics*.

Problem	Procedure
Some programs run correctly, but others do not	The software or hardware configuration may be causing a problem. Make sure the hardware configuration match's your software's needs.
You cannot access the disk drive	Try another disk. If you can access this disk, the original disk (not the disk drive) is problem. If problems persist, contact your dealer.

### Real Time Clock

Problem	Procedure
The following message is displayed on the LCD: <b>RTC battery is low or CMOS checksum is inconsistent. Press [F2] key to set Date/Time.</b>	<p>The RTC battery charge has become exhausted, you should set the date and time in within the BIOS setup screen through the following steps:</p> <ol style="list-style-type: none"> <li>1. Press <b>[F1]</b> key. BIOS setup will boot up.</li> <li>2. Press <b>[F2]</b> to set the date in [System Date].</li> <li>3. Press <b>[F2]</b> to set the time in [System Time].</li> </ol>

## Web Camera

Problem	Procedure
Cannot use the Web Camera	Refer to Chapter 4, <i>Using the Web Camera</i> .

## TOSHIBA support

If you require any additional help using your computer or if you are having problems operating the computer, you may need to contact TOSHIBA for additional technical assistance.

### Before you call

Some problems you experience may be related to software or the operating system, it is important to investigate other sources of assistance first. Before contacting TOSHIBA, try the following:

- Review troubleshooting sections in the documentation for software and peripheral devices.
- If a problem occurs when you are running software applications, consult the software documentation for troubleshooting suggestions. Call the software company's technical support for assistance.
- Consult the dealer you purchased your computer and/or software from. They are your best sources for current information and support.

### Where to write

If you are still unable to solve the problem and suspect that it is hardware related, write to TOSHIBA at the location listed in the accompanying warranty booklet or visit <http://www.toshiba-europe.com> on the Internet.



# Chapter 11

## Disclaimers

This chapter states the Disclaimer(s) information applicable to TOSHIBA computers.

### CPU

Central Processing Unit ("CPU") Performance Disclaimer.

CPU performance in your computer product may vary from specifications under the following conditions:

- use of certain external peripheral products
- use of battery power instead of AC power
- use of certain multimedia, computer generated graphics or video applications
- use of standard telephone lines or low speed network connections
- use of complex modeling software, such as high end computer aided design applications
- use of several applications or functionalities simultaneously
- use of computer in areas with low air pressure (high altitude >1,000 meters or >3,280 feet above sea level)
- use of computer at temperatures outside the range of 5°C to 30°C (41°F to 86°F) or >25°C (77°F) at high altitude (all temperature references are approximate and may vary depending on the specific computer model - please refer to your PC documentation or visit the Toshiba website at <http://www.pcsupport.toshiba.com> for details).

CPU performance may also vary from specifications due to design configuration.

Under some conditions, your computer product may automatically shutdown. This is a normal protective feature designed to reduce the risk of lost data or damage to the product when used outside recommended conditions. To avoid risk of lost data, always make back-up copies of data by periodically storing it on an external storage medium. For optimum performance, use your computer product only under recommended conditions. Read additional restrictions in your product documentation. Contact Toshiba technical service and support, refer to *TOSHIBA support* section in Chapter 10 *Troubleshooting* for more information.

## 64-Bit Computing.

64-bit processors are designed to take advantage of 32 and 64 bit computing.

64-bit computing requires that the following hardware and software requirements are met:

- 64-bit Operating System
- 64-bit CPU, Chipset and BIOS (Basic Input/Output System)
- 64-bit Device drivers
- 64-bit applications

Certain device drivers and/or applications may not be compatible with a 64-bit CPU and therefore may not function properly. A 32-bit version of the operating system is preinstalled on your computer unless explicitly stated that the operating system is 64-bit.

## Memory (Main System)

Part of the main system memory may be used by the graphics system for graphics performance and therefore reduce the amount of main system memory available for other computing activities. The amount of main system memory allocated to support graphics may vary depending on the graphics system, applications utilized, system memory size and other factors. For PC's configured with 4 GB of system memory, the full system memory space for computing activities will be considerably less and will vary by bay model and system configuration.

## Battery Life

Battery life may vary considerably depending on product model, configuration, applications, power management settings and features utilized, as well as the natural performance variations produced by the design of individual components. Published battery life numbers are achieved on select models and configurations tested by Toshiba at the time of publication. Recharge time varies depending on usage. Battery may not charge while computer is consuming full power.

After going through many charge and discharge cycles, the battery will lose its ability to perform at maximum capacity and will need to be replaced. This is a normal phenomenon for all batteries. To purchase a new battery pack, see the accessories information that is shipped with your computer.

## HDD Drive Capacity

1 Gigabyte (GB) means  $10^9 = 1,000,000,000$  bytes using powers of 10. The computer operating system, however, reports storage capacity using powers of 2 for the definition of 1 GB =  $2^{30} = 1,073,741,824$  bytes, and therefore shows less storage capacity. Available storage capacity will also be less if the product includes one or more pre-installed operating systems, such as Microsoft Operating System and/or pre-installed software applications, or media content. Actual formatted capacity may vary.

## LCD

Over a period of time, and depending on the usage of the computer, the brightness of the LCD screen will deteriorate. This is an intrinsic characteristic of LCD technology.

Maximum brightness is only available when operating in AC power mode. The screen will dim when the computer is operated on battery power and you will not be able to increase the brightness of the screen.

## Graphics Processor Unit ("GPU")

Graphics processor unit ("GPU") performance may vary depending on product model, design configuration, applications, power management settings and features utilized. GPU performance is only optimized when operating in AC power mode and may decrease considerably when operating in battery power mode.

## Wireless LAN

The transmission speed over the wireless LAN and the distance over which wireless LAN can reach may vary depending on surrounding electromagnetic environment, obstacles, access point design and configuration, and client design and software/hardware configurations.

[54 Mbps is the theoretical maximum speed under the IEEE802.11 (a/b/g) standard.] The actual transmission speed will be lower than the theoretical maximum speed.

## Non-applicable Icons

Certain notebook chassis are designed to accommodate all possible configurations for an entire product series. Therefore, please be aware that your selected model may not have all the features and specifications corresponding to all of the icons or switches shown on the notebook chassis.

## Copy Protection

Copy protection technology included in certain media may prevent or limit recording or viewing of the media.

## Images

All images are simulated for purposes of illustration.

## LCD Brightness and Eye Strain

Your LCD display has a brightness approaching that of a TV device. We recommend that you adjust the brightness of your LCD to a comfortable level to prevent possible strain on your eyes.

# Appendix A

## Specifications

This appendix summarizes the computer's technical specifications.

### Dimensions

399 mm (W) × 288 mm (D) × 46.5 mm (H. Max.)

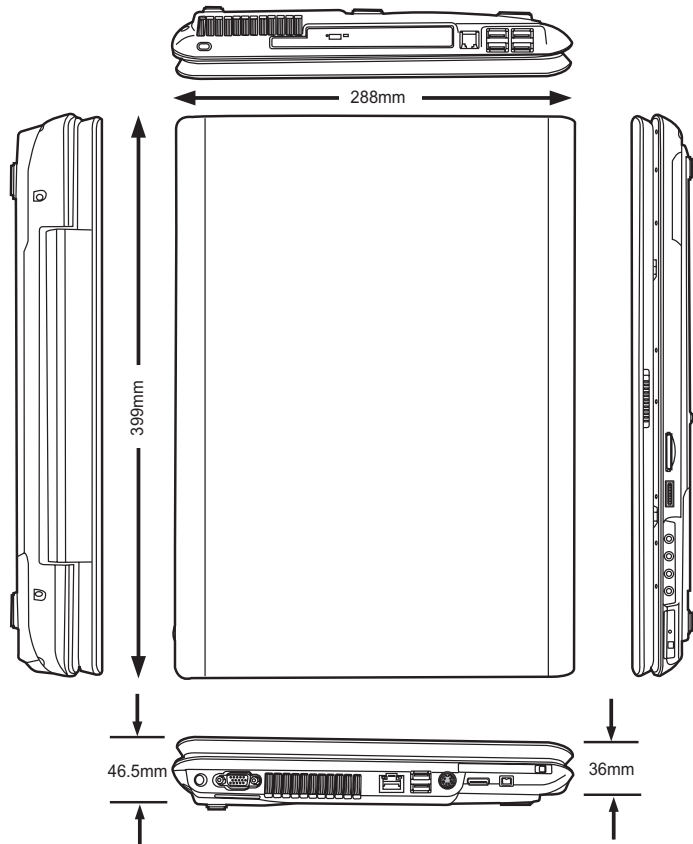

## Weight

Starting at 7.2 lbs / 3.27 kg

\* Weight may vary depending on product configuration, vendor components, manufacturing variability and options selected.

## Environmental Requirements

Conditions	Ambient temperature	Relative humidity
<b>Operating</b>	5°C to 35°C	20% to 80%
<b>Non-operating</b>	-20°C to 65°C	
Conditions	Altitude (from sea level)	
<b>Operating</b>	-30 to 10,000 feet	
<b>Non-operating</b>	-30 to 40,000 feet	

## Built-in Modem

Network control unit (NCU)		
<b>Type of NCU</b>	AA	
<b>Type of line</b>	Telephone line (analog only)	
<b>Type of dialling</b>	Pulse Tone	
<b>Control command</b>	AT commands EIA-578 commands	
<b>Monitor function</b>	Computer's speaker	
Communication specifications		
<b>Communication System</b>	Data:	Full duplex
	Fax:	Half duplex
<b>Communication Protocol</b>	Data:	
	ITU-T-Rec (Former CCITT)	V.21/V.22/V.22bis/V.32/ V.32bis/V.34/V.90/ V.92 (only for USA and Canada)
	Bell	103/212A
	Fax:	
	ITU-T-Rec (Former CCITT)	V.17/V.29/V.27ter / V.21 ch2

---

<b>Communication Speed</b>	Data transmission and reception 300/1200/2400/4800/7200/9600/12000/14400/ 16800/19200/21600/24000/26400/28800/31200/ 33600 bps Data reception only with V.90/V.92 28000/29333/30666/32000/33333/34666/36000/ 37333/38666/40000/41333/42666/44000/45333/ 46666/48000/49333/50666/52000/53333/54666/ 56000 bps Fax: 2400/4800/7200/9600/12000/14400 bps
<b>Error correcting</b>	MNP class 4 and ITU-T V.42
<b>Data compression</b>	MNP class 5 and ITU-T V.42bis

---

# Appendix B

## Display Modes

This appendix contains a table listing all the display modes when the display is set to an external monitor.



*If you are running some applications (for example a 3D application or video playback and so on), you may see some disturbance, flickering or frame dropping on your screen. If that occurs, adjust the resolution of display, lowering it until the screen is displayed properly. You could also disable Windows Aero™, to help correct this situation.*

CRT Display Resolution	Color Depth (bit)	Refresh Rate (Hz)
800 × 600	16 bit	60, 75, 85, 100
	32 bit	60, 75, 85, 100
1024 × 768	16 bit	60, 75, 85, 100
	32 bit	60, 75, 85, 100
1280 × 800	16 bit	60
	32 bit	60
1280 × 1024	16 bit	60, 75, 85, 100
	32 bit	60, 75, 85, 100
1440 × 900	16 bit	60
	32 bit	60
1600 × 1200	16 bit	60, 75, 85, 100
	32 bit	60, 75, 85, 100
1920 × 1440	16 bit	60, 75
	32 bit	60, 75
2048 × 1536	16 bit	60
	32 bit	60





*Some of display mode might not be supported depending on the external monitor which you use.*

## Displaying movies on a TV or CRT

This section describes how to set up your system to display movies simultaneously on your computer's LCD and on an external TV or CRT monitor.

To connect a television, follow the steps below.

1. Turn the computer off.
2. Use a video cable (not supplied) to connect the television to the video out port.
3. Turn the television on.
4. Turn the computer on.

You can use the hotkeys **Fn + F5** or use the **TV-Out** button to change the display device. Refer to Chapter 6, *The Keyboard*.

If a television is connected to the computer, set the TV type in Display Properties. Follow the steps below, based on the configuration of your computer:

### For ATI Mobility Radeon™ HD2400/HD2600\*

1. Click **Start** → **Control Panel** → **Personalization**.
2. Choose **Display Settings** to change resolution and colors.

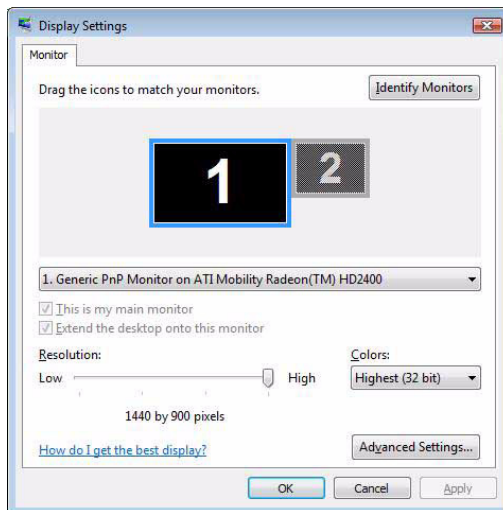

3. Click **Start** and **All Programs**.
4. Click **Catalyst Control Center**
5. Select **CCC**.

- In **Catalyst Control Center** window, setup your television or CRT and Notebook displays.

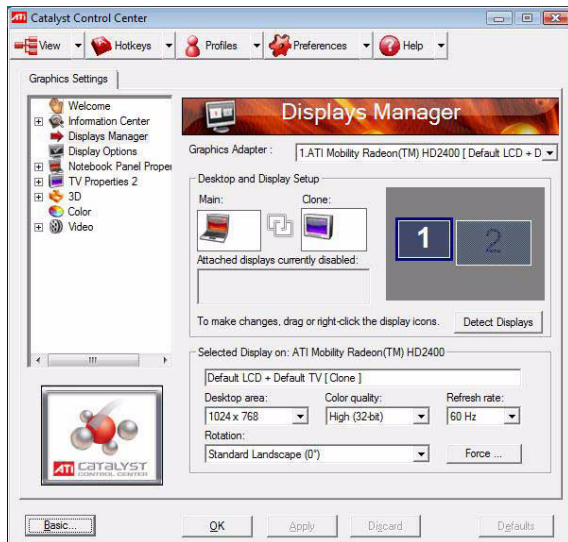

- \* The availability of this feature is dependent on the model you purchased.

## Displaying movies on a HDMI Monitor

This section describes how to set up your system to display movies a HDMI monitor.

To connect a HDMI monitor, follow the steps below.

- Turn the computer off.
- Use a HDMI cable (not supplied) to connect the HDMI monitor to the HDMI out port on your computer.
- Turn the HDMI monitor on.
- Turn the computer on.

If a HDMI monitor is connected to the computer, follow the steps below, based on the configuration of your computer:

- Click **Start** and **All Programs**.
- Click **Catalyst Control Center**.
- Select **CCC**.
- In **Catalyst Control Center** window, select **Display manager** from left select panel.
- You can see a HDMI monitor that connected in the list (If not, you can click **Detect Monitor** once)
- Drag HDMI monitor icon to **"Main:"** then select **Swap Devices**.

- After system applying the display mode to HDMI, click **Force** then select **Desktop area** to select the HDMI mode.

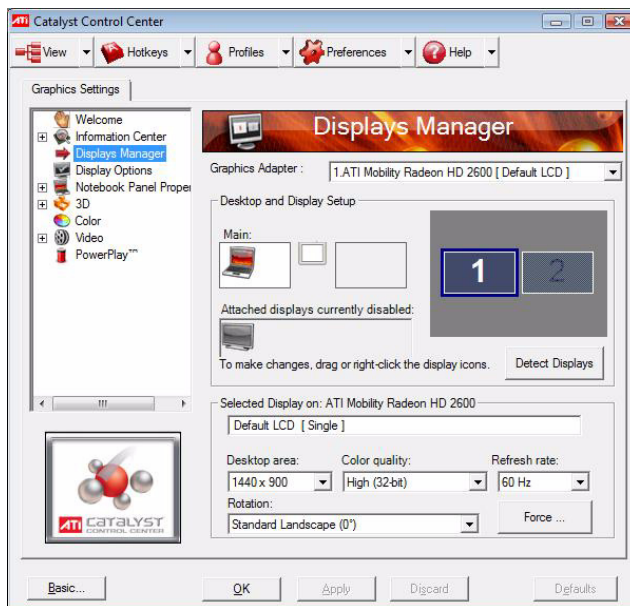

- \* The availability of this feature is dependent on the model you purchased.

# Appendix C

## AC Power Cord and Connectors

The power cord's AC input plug must be compatible with the various international AC power outlets and the cord must meet the standards for the country/region in which it is used. All cords must meet the following specifications:

<b>Length:</b>	Minimum 1.7 meters
<b>Wire size:</b>	Minimum 0.75 mm <sup>2</sup>
<b>Current rating:</b>	Minimum 2.5 amperes
<b>Voltage rating:</b>	125 or 250 VAC (depending on country/region's power standards)

### Certification agencies

<b>U.S. and Canada:</b>	UL listed and CSA certified No. 18 AWG, Type SVT or SPT-2		
<b>Australia:</b>	AS		
<b>Europe:</b>			
<b>Austria:</b>	OVE	<b>Italy:</b>	IMQ
<b>Belgium:</b>	CEBEC	<b>The Netherlands:</b>	KEMA
<b>Denmark:</b>	DEMKO	<b>Norway:</b>	NEMKO
<b>Finland:</b>	FIMKO	<b>Sweden:</b>	SEMKO
<b>France:</b>	LCIE	<b>Switzerland:</b>	SEV
<b>Germany:</b>	VDE	<b>United Kingdom:</b>	BSI

In Europe, two conductors power cord must be VDE type, H05VVH2-F or H03VVH2-F and for three conductors power cord must be VDE type, H05VV-F.

For the United States and Canada, two pin plug configuration must be a 2-15P (250V) or 1-15P (125 V) and three pin plug configuration must be 6-15P (250V) or 5-15P (125V) as designated in the U. S. National Electrical code handbook and the Canadian Electrical Code Part II.

The following illustrations show the plug shapes for the U. S. A. and Canada, the United Kingdom, Australia and Europe.

USA

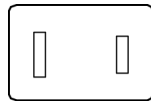
*UL approved*

United Kingdom

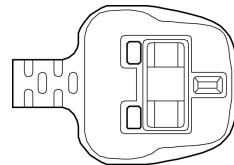
*BS approved*

Australia

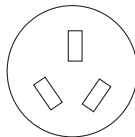
*AS approved*

Europe

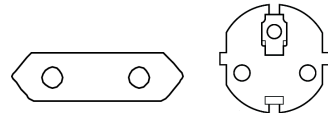
*Approved by the appropriate agency*

Canada

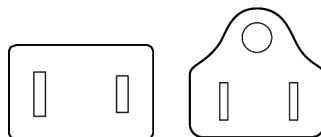
*CSA approved*

China

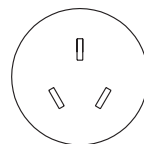
*CCC approved*

# Appendix D

## If your computer is stolen



*Always take care of your computer and try to prevent it from being stolen. You are the owner of a valuable technical device, which may be highly attractive to thieves, so please do not leave it unattended in a public place. To further help protect against theft, security cables can be bought for use with your notebook when it is being used at home or in the office.*

*Make a note of your computer's machine type, model number, and serial number, and put it in a safe place. You will find this information on the underside of your notebook. Please also keep the receipt of the computer you purchased.*

**Should your computer be stolen**, however, we'll help you try to find it. Before contacting TOSHIBA, please prepare the following information which is necessary to uniquely identify your computer:

- In which country was your computer stolen?
- What type of machine do you have?
- What was the model number (PA number)?
- What was the serial number (8 digits)?
- When was it stolen, i.e. date?
- What is your address, phone, and fax number?

**To register the theft on paper, please follow these procedures:**

- Fill in the TOSHIBA Theft Registration form (or a copy of it) below.
- Attach a copy of your receipt showing where your computer was purchased.
- Either fax or send the receipt and registration form to the address below.

**To register the theft online, please follow these procedures:**

- Visit <http://www.toshiba-europe.com> on the Internet. In the product area, choose **Computer Systems**.
- In the Computer Systems page, open the **Support & Downloads** menu and choose the **Stolen Units Database** option.

Your entries are used to track your computer at our service points.

**TOSHIBA Theft Registration**

Send to: TOSHIBA Europe GmbH  
 Technical Service and Support  
 Leibnizstr. 2  
 93055 Regensburg  
 Germany

Fax number: +49 (0) 941 7807 921

Country stolen:

Machine type:  
 (e.g. P200 Series)

Model number:  
 (e.g. PSA50 YXT)

--	--	--	--	--	--	--	--	--	--	--	--	--	--	--	--	--	--	--	--

Serial number:  
 (e.g. 12345678G)

--	--	--	--	--	--	--	--	--	--

Date stolen:

Year

Month

Day

--	--	--	--

--	--

--	--

**Owner's details**

Last name, first name:

Company:

Street:

Postal Code/City:

Country:

Phone:

Fax:

# Glossary

The terms in this glossary cover topics related to this manual. Alternate naming is included for reference.

## **Abbreviations**

**AC:** alternating current

**AGP:** accelerated graphics port

**BIOS:** basic input output system

**CD-ROM:** Compact Disc-Read Only Memory

**CD-RW:** Compact Disc-Read/Write

**CMOS:** complementary metal-oxide semiconductor

**CPU:** central processing unit

**CRT:** cathode ray tube

**DC:** direct current

**DDC:** display data channel

**DMA:** direct memory access

**DOS:** disk operating system

**DVD:** digital versatile disc

**ECP:** extended capabilities port

**FDD:** floppy disk drive

**HDD:** hard disk drive

**IDE:** integrated drive electronics

**I/O:** input/output

**IRQ:** interrupt request

**KB:** kilobyte

**LCD:** liquid crystal display

**LED:** light emitting diode

**LSI:** large scale integration

**MS-DOS:** Microsoft Disk Operating System

**PCI:** peripheral component interconnect

**RAM:** random access memory

**ROM:** read only memory

**RTC:** real time clock



**SCSI:** small computer system interface

**TFT:** thin-film transistor

**USB:** Universal Serial Bus

**VESA:** Video Electronic Standards Association

**VGA:** video graphics array

**WXGA+:** wide extended graphics array

## A

**adaptor:** A device that provides an interface between two dissimilar electronic devices. For example, the AC adaptor modifies the power from a wall outlet for use by the computer. This term also refers to the add-in circuit cards that control external devices, such as video monitors and magnetic tape devices.

**application:** A group of programs that together are used for a specific task such as accounting, financial planning, spreadsheets, word processing and games.

## B

**BIOS:** Basic Input Output System. The firmware that controls data flow within the computer. *See also* firmware.

**bit:** Derived from "binary digit," the basic unit of information used by the computer. It is either zero or one. Eight bits is one byte. *See also* byte.

**boot:** Short for bootstrap. A program that starts or restarts the computer. The program reads instructions from a storage device into the computer's memory.

**bps:** Bits per second. Typically used to describe the data transmission speed of a modem.

**buffer:** The portion of the computer's memory where data is temporarily stored. Buffers often compensate for differences in the rate of flow from one device to another.

**bus:** An interface for transmission of signals, data or electric power.

**byte:** The representation of a single character. A sequence of eight bits treated as a single unit; also the smallest addressable unit within the system.

## C

**cache memory:** High speed memory which stores data that increases processor speed and data transfer rate. When the CPU reads data from main memory, it stores a copy of this data in cache memory. The next time the CPU needs that same data, it looks for it in the cache memory rather than the main memory, which saves time. The computer has two cache levels. Level one is incorporated into the processor and level two resides in external memory.

- capacity:** The amount of data that can be stored on a magnetic storage device such as a floppy disk or hard disk. It is usually described in terms of kilobytes (KB), where one KB = 1024 bytes and megabytes (MB), where one MB = 1024 KB.
- CD-ROM:** A Compact Disc-Read Only Memory is a high capacity disc that can be read from but not written to. The CD-ROM drive uses a laser, rather than magnetic heads, to read data from the disc.
- CD-R:** A Compact Disc-Recordable disc can be written once and read many times. *See also* CD-ROM.
- CD-RW:** A Compact Disc-Read/Write disc can be rewritten many times. *See also* CD-ROM.
- character:** Any letter, number, punctuation mark, or symbol used by the computer. Also synonymous with byte.
- chip:** A small semiconductor containing computer logic and circuitry for processing, memory, input/output functions and controlling other chips.
- CMOS:** Complementary Metal-Oxide Semiconductor. An electronic circuit fabricated on a silicon wafer that requires very little power. Integrated circuits implemented in CMOS technology can be tightly packaged and are highly reliable.
- compatibility:** 1) The ability of one computer to accept and process data in the same manner as another computer without modifying the data or the media upon which it is being transferred.  
2) the ability of one device to connect to or communicate with another system or component.
- components:** Elements or parts (of a system) which make up the whole (system).
- configuration:** The specific components in your system (such as the terminal, printer, and disk drives) and the settings that define how your system works. You use the HW Setup program to control your system configuration.
- control keys:** A key or sequence of keys you enter from the keyboard to initiate a particular function within a program.
- controller:** Built-in hardware and software that controls the functions of a specific internal or peripheral device (e.g. keyboard controller).
- CPU:** Central Processing Unit. The portion of the computer that interprets and executes instructions.
- CRT:** Cathode Ray Tube. A vacuum tube in which beams projected on a fluorescent screen-producing luminous spots. An example is the television set.
- cursor:** A small, blinking rectangle or line that indicates the current position on the display screen.

## D

**DC:** Direct Current. Electric current that flows in one direction. This type of power is usually supplied by batteries.

**default:** The parameter value automatically selected by the system when you or the program do not provide instructions. Also called a preset value.

**device driver:** A program that controls communication between a specific peripheral device and the computer. The CONFIG.SYS file contains device drivers that MS-DOS loads when you turn the computer on.

**dialog box:** A window that accepts user input to make system settings or record other information.

**disk drive:** The device that randomly accesses information on a disk and copies it to the computer's memory. It also writes data from memory to the disk. To accomplish these tasks, the unit physically rotates the disk at high speed past a read-write head.

**display:** A CRT, LCD, or other image producing device used to view computer output.

**DOS:** Disk Operating System. See operating system.

**driver:** A software program, generally part of the operating system, that controls a specific piece of hardware (frequently a peripheral device such as a printer or mouse).

**DVD-RAM:** A Digital Versatile Disc Random Access Memory is a high-capacity, high performance disc that lets you store large volumes of data. The DVD-ROM drive uses a laser to read data from the disc.

**DVD-ROM:** A Digital Versatile Disc Read Only Memory is a high capacity, high performance disc suitable for play back of video and other high-density files. The DVD-ROM drive uses a laser to read data from the disc.

## E

**execute:** To interpret and execute an instruction.

## F

**floppy disk:** A removable disk that stores magnetically encoded data.

**floppy disk drive (FDD):** An electromechanical device that reads and writes to floppy disks.

**folder:** An icon in Windows used to store documents or other folders.

**format:** The process of readying a blank disk for its first use. Formatting establishes the structure of the disk that the operating system expects before it writes files or programs onto the disk.

**function keys:** The keys labeled **F1** through **F12** that tell the computer to perform certain functions.

## G

**gigabyte (GB):** A unit of data storage equal to 1024 megabytes. *See also* megabyte.

**graphics:** Drawings, pictures, or other images, such as charts or graphs, to present information.

## H

**hard disk:** A non-removable disk usually referred to as drive C. The factory installs this disk and only a trained engineer can remove it for servicing. Also called fixed disk.

**hard disk drive (HDD):** An electromechanical device that reads and writes a hard disk. *See also* hard disk.

**hertz:** A unit of wave frequency that equals one cycle per second.

**hot key:** The computer's feature in which certain keys in combination with the extended function key, **Fn**, can be used to set system parameters, such as speaker volume.

## I

**input:** The data or instructions you provide to a computer, communication device or other peripheral device from the keyboard or external or internal storage devices. The data sent (or output) by the sending computer is input for the receiving computer.

**I/O:** Input/output. Refers to acceptance and transfer of data to and from a computer.

**I/O devices:** Equipment used to communicate with the computer and transfer data to and from it.

## J

**jumper:** A small clip or wire that allows you to change the hardware characteristics by electrically connecting two points of a circuit.

## K

**K:** Taken from the Greek word kilo, meaning 1000; often used as equivalent to 1024, or 2 raised to the 10<sup>th</sup> power. *See also* byte and kilobyte.

**KB:** *See* kilobyte.

## L

**Light Emitting Diode (LED):** A semiconductor device that emits light when a current is applied.

**Liquid Crystal Display (LCD):** Liquid crystal sealed between two sheets of glass coated with transparent conducting material. The viewing-side coating is etched into character forming segments with leads that extend to the edge of the glass. Applying a voltage between the glass sheets alters the brightness of the liquid crystal.

**LSI:** Large Scale Integration.

- 1) A technology that allows the inclusion of up to 100,000 simple logic gates on a single chip.
- 2) An integrated circuit that uses large scale integration.

## M

**megabyte (MB):** A unit of data storage equal to 1024 kilobytes. *See also* kilobyte.

**mode:** A method of operation, for example, the boot mode, Sleep mode or the hibernation mode.

**modem:** Derived from modulator/demodulator, a device that converts (modulates) digital data for transmission over telephone lines and then converts modulated data (demodulates) to digital format where received.

**monitor:** A device that uses rows and columns of pixels to display alphanumeric characters or graphic images. *See also* CRT.

**MP3:** An audio compression standard that enables high-quality transmission and real-time playback of sound files.

## N

**numeric pad:** A feature that allows you to perform numeric entry, or to control cursor and page movement.

## O

**operating system:** A group of programs that controls the basic operation of a computer. Operating system functions include interpreting programs, creating data files, and controlling the transmission and receipt (input/output) of data to and from memory and peripheral devices.

**output:** The results of a computer operation. Output commonly indicates data.

- 1) printed on paper, 2) displayed at a terminal, 3) sent through the serial port of internal modem, or 4) stored on some magnetic media.

## P

- parity:** 1) The symmetrical relationship between two parameter values (integers) both of which are either on or off; odd or even; 0 or 1.  
2) In serial communications, an error detection bit that is added to a group of data bits making the sum of the bits even or odd. Parity can be set to none, odd, or even.
- peripheral device:** An I/O device that is external to the central processor and/or main memory such as a printer or a mouse.
- pixel:** A picture element. The smallest dot that can be made on a display or printer. Also called a pel.
- plug and play:** A capability with Windows that enables the system to automatically recognize connections of external devices and make the necessary configurations in the computer.
- port:** The electrical connection through which the computer sends and receives data to and from devices or other computers.
- prompt:** A message the computer provides indicating it is ready for or requires information or an action from you.

## R

- Random Access Memory (RAM):** High speed memory within the computer circuitry that can be read or written to.
- restart:** Resetting a computer without turning it off (also called "warm boot" or "soft reset"). *See also* boot.
- RJ11:** A modular telephone jack.
- RJ45:** A modular LAN jack.
- ROM:** Read Only Memory: A nonvolatile memory chip manufactured to contain information that controls the computer's basic operation. You cannot access or change information stored in ROM.

## S

- SCSI:** Small Computer System Interface is an industry standard interface for connection of a variety of peripheral devices.
- soft key:** Key combinations that emulate keys on the IBM keyboard, change some configuration options, stop program execution, and access the numeric pad.
- stop bit:** One or more bits of a byte that follow the transmitted character or group codes in asynchronous serial communications.
- system disk:** A disk that has been formatted with an operating system. For MS-DOS the operating system is contained in two hidden files and the COMMAND.COM file. You can boot a computer using a system disk. Also called an operating system disk.

## T

**terminal:** A typewriter-like keyboard and CRT display screen connected to the computer for data input/output.

**TFT display:** A liquid crystal display (LCD) made from an array of liquid crystal cells using active-matrix technology with thin film transistor (TFT) to drive each cell.

**TouchPad/Dual Mode Pad:** A pointing device integrated into the TOSHIBA computer palm rest.

## U

**Universal Serial Bus:** This serial interface lets you communicate with several devices connected in a chain to a single port on the computer.

## V

**VGA:** Video Graphics Array is an industry standard video adaptor that lets you run any popular software.

## W

**warm start:** Restarting or resetting a computer without turning it off.

**write protection:** A method for protecting a floppy disk from accidental erasure.

## Free Manuals Download Website

<http://myh66.com>

<http://usermanuals.us>

<http://www.somanuals.com>

<http://www.4manuals.cc>

<http://www.manual-lib.com>

<http://www.404manual.com>

<http://www.luxmanual.com>

<http://aubethermostatmanual.com>

Golf course search by state

<http://golfingnear.com>

Email search by domain

<http://emailbydomain.com>

Auto manuals search

<http://auto.somanuals.com>

TV manuals search

<http://tv.somanuals.com>