

# TOSHIBA

## OWNER'S MANUAL



# DVD VIDEO PLAYER

# ***SD-4205***

Aug., 2000 ©

# SAFETY PRECAUTIONS

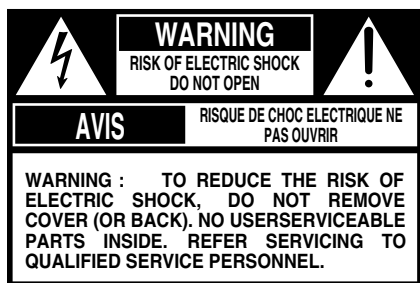

The lightning flash with arrowhead symbol, within an equilateral triangle, is intended to alert the user to the presence of uninsulated "dangerous voltage" within the product's enclosure that may be of sufficient magnitude to constitute a risk of electric shock to persons.



The exclamation point within an equilateral triangle is intended to alert the user to the presence of important operating and maintenance (servicing) instructions in the literature accompanying the appliance.

**WARNING:** TO REDUCE THE RISK OF FIRE OR ELECTRIC SHOCK, DO NOT EXPOSE THIS APPLIANCE TO RAIN OR MOISTURE. DANGEROUS HIGH VOLTAGES ARE PRESENT INSIDE THE ENCLOSURE. DO NOT OPEN THE CABINET. REFER SERVICING TO QUALIFIED PERSONNEL ONLY.

**CAUTION:** TO PREVENT ELECTRIC SHOCK, MATCH WIDE BLADE OF PLUG TO WIDE SLOT, FULLY INSERT.

**ATTENTION:** POUR EVITER LES CHOCs ELECTRIQUES, INTRODUIRE LA LAME LA PLUS LARGE DE LA FICHE DANS LA BORNE CORRESPONDANTE DE LA PRISE ET POUSSER JUSQU'AU FOND.

**CAUTION:** This Digital Video Disc Player employs a Laser System. To ensure proper use of this product, please read this owner's manual carefully and retain for future reference. Should the unit require maintenance, contact an authorized service location - see service procedure.

Use of controls or adjustments or performance of procedures other than those specified herein may result in hazardous radiation exposure.

To prevent direct exposure to laser beam, do not try to open the enclosure. Visible and invisible laser radiation when open and interlocks defeated. DO NOT STARE INTO BEAM.

**FCC NOTICE:** This equipment has been tested and found to comply with the limits for a Class B digital device, pursuant to part 15 of the FCC Rule. These limits are designed to provide reasonable protection against harmful interference in a residential installation.

This equipment generates, uses, and can radiate radio frequency energy and, if not installed and used in accordance with the instructions, may cause harmful interference to radio communications.

However, there is no guarantee that interference will not occur in a particular installation.

If this equipment does cause harmful interference to radio or television reception, which can be determined by turning the equipment off and on, the user is encouraged to try to correct the interference by one or more of the following measures:

- Reorient or relocate the receiving antenna.
- Increase the separation between the equipment and receiver.
- Connect the equipment into an outlet on a circuit different from that to which the receiver is connected.
- Consult the dealer or an experienced radio/TV technician for help.

**WARNING:** Changes or modifications made to this equipment, not expressly approved by Toshiba, or parties authorized by Toshiba, could void the user's authority to operate the equipment.

In the spaces provided below, record the Model and Serial No. located on the rear panel of your DVD video player.

Model No. \_\_\_\_\_

Serial No. \_\_\_\_\_

Retain this information for future reference.

### Location of the required label

THIS DEVICE COMPLIES WITH PART 15 OF THE FCC RULES. OPERATION IS SUBJECT TO THE FOLLOWING TWO CONDITIONS: (1) THIS DEVICE MAY NOT CAUSE HARMFUL INTERFERENCE, AND (2) THIS DEVICE MUST ACCEPT ANY INTERFERENCE RECEIVED, INCLUDING INTERFERENCE THAT MAY CAUSE UNDESIRE OPERATION.

MANUFACTURED:

**TOSHIBA CORPORATION**

1-1, SHIBAURA 1-CHOME, MINATO-KU, TOKYO 105-01, JAPAN

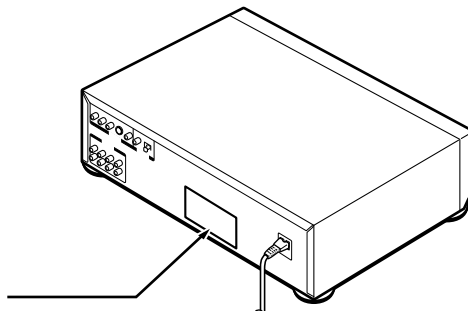

# IMPORTANT SAFETY INSTRUCTIONS

**CAUTION: PLEASE READ AND OBSERVE ALL WARNINGS AND INSTRUCTIONS GIVEN IN THIS OWNER'S MANUAL AND THOSE MARKED ON THE UNIT. RETAIN THIS BOOKLET FOR FUTURE REFERENCE.**

This set has been designed and manufactured to assure personal safety. Improper use can result in electric shock or fire hazard. The safeguards incorporated in this unit will protect you if you observe the following procedures for installation, use and servicing. This unit is fully transistorized and does not contain any parts that can be repaired by the user.

**DO NOT REMOVE THE CABINET COVER, OR YOU MAY BE EXPOSED TO DANGEROUS VOLTAGE. REFER SERVICING TO QUALIFIED SERVICE PERSONNEL ONLY.**

## 1. Read owner's manual

After unpacking this product, read the owner's manual carefully, and follow all the operating and other instructions.

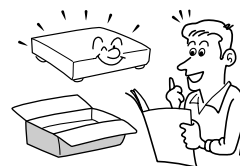

## 2. Power Sources

This product should be operated only from the type of power source indicated on the label. If you are not sure of the type of power supply to your home, consult your product dealer or local power company. For products intended to operate from battery power, or other sources, refer to the operating instructions.



## 3. Grounding or Polarization

This product may be equipped with a polarized alternating current line plug (a plug having one blade wider than the other). This plug will fit into the power outlet only one way. This is a safety feature. If you are unable to insert the plug fully into the outlet, try reversing the plug. If the plug should still fail to fit, contact your electrician to replace your obsolete outlet. Do not defeat the safety purpose of the polarized plug.

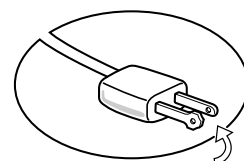

## 4. Ventilation

Slots and openings in the cabinet are provided for ventilation and to ensure reliable operation of the product and to protect it from overheating, and these openings must not be blocked or covered. The openings should never be blocked by placing the product on a bed, sofa, rug or other similar surface. This product should not be placed in a built-in installation such as a bookcase or rack unless proper ventilation is provided or the manufacturer's instructions have been adhered to.

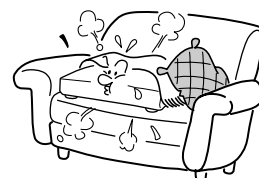

## 5. Heat

The product should be situated away from heat sources such as radiators, heat registers, stoves, or other products (including amplifiers) that produce heat.

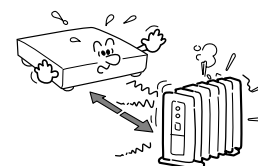

#### 6. Water and Moisture

Do not use this product near water - for example, near a bath tub, wash bowl, kitchen sink, or laundry tub; in a wet basement; or near a swimming pool and the like.

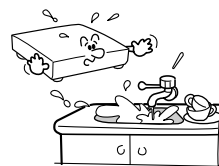

#### 7. Cleaning

Unplug this product from the wall outlet before cleaning. Do not use liquid cleaners or aerosol cleaners. Use a damp cloth for cleaning.



#### 8. Power-Cord Protection

Power-supply cords should be routed so that they are not likely to be walked on or pinched by items placed upon or against them, paying particular attention to cords at plugs, convenience receptacles, and the point where they exit from the product.



#### 9. Overloading

Do not overload wall outlets; extension cords, or integral convenience receptacles as this can result in a risk of fire or electric shock.



#### 10. Lightning

For added protection for this product during storm, or when it is left unattended and unused for long periods of time, unplug it from the wall outlet. This will prevent damage to the product due to lightning and power-line surges.

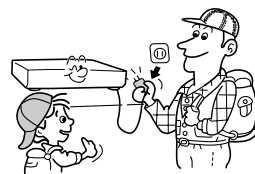

#### 11. Object and Liquid Entry

Never insert objects of any kind into this product through openings as they may touch dangerous voltage points or short-out parts that could result in a fire or electric shock. Never spill liquid of any kind on the product.



#### 12. Attachments

Do not use attachments not recommended by the product manufacturer as they may cause hazards.

# IMPORTANT SAFETY INSTRUCTIONS

## 13. Accessories

Do not place this product on an unstable cart, stand, tripod, bracket, or table. The product may fall, causing serious injury to a child or adult, and serious damage to the product. Use only with a cart, stand, tripod, bracket, or table recommended by the manufacturer, or sold with the product. Any mounting of the product should follow the manufacturer's instructions, and should use a mounting accessory recommended by the manufacturer.

A product and cart combination should be moved with care. Quick stops, excessive force, and uneven surfaces may cause the product and cart combination to overturn.



## 14. Disc Tray

Keep your fingers well clear of the disc tray as it is closing. Neglecting to do so may cause serious personal injury.

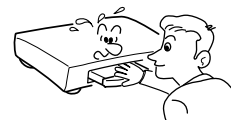

## 15. Burden

Do not place a heavy object on or step on the product. The object may fall, causing serious personal injury and serious damage to the product.

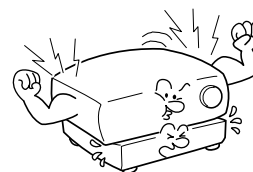

## 16. Headphones

When you use headphones, keep the volume at a moderate level. If you use the headphones continuously with high volume sound, it may cause hearing damage.



## 17. Disc

Do not use a cracked, deformed, or repaired disc. These discs are easily broken and may cause serious personal injury and product malfunction.

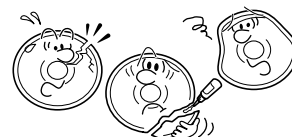

## 18. Damage Requiring Service

Unplug this product from the wall outlet and refer servicing to qualified service personnel under the following conditions:

- When the power-supply cord or plug is damaged.
- If liquid has been spilled, or objects have fallen into the product.
- If the product has been exposed to rain or water.
- If the product does not operate normally by following the operating instructions. Adjust only those controls that are covered by the operating instructions as an improper adjustment of other controls may result in damage and will often require extensive work by a qualified technician to restore the product to its normal operation.
- If the product has been dropped or damaged in any way.
- When the product exhibits a distinct change in performance - this indicates a need for service.

### 19. Servicing

Do not attempt to service this product yourself as opening or removing covers may expose you to dangerous voltage or other hazards. Refer all servicing to qualified service personnel.



### 20. Replacement Parts

When replacement parts are required, be sure the service technician has used replacement parts specified by the manufacturer or have the same characteristics as the original part. Unauthorized substitutions may result in fire, electric shock, or other hazards.

### 21. Safety Check

Upon completion of any service or repairs to this product, ask the service technician to perform safety checks to determine that the product is in proper operating condition.

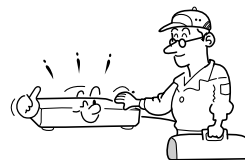

## Precautions

### Notes on handling

- When shipping the DVD video player, the original shipping carton and packing materials come in handy. For maximum protection, repack the unit as it was originally packed at the factory.
- Do not use volatile liquids, such as insect spray, near the DVD video player. Do not leave rubber or plastic products in contact with the DVD video player for a long time. They will leave marks on the finish.
- The top and rear panels of the DVD video player may become warm after a long period of use. This is not a malfunction.
- When the DVD video player is not in use, be sure to remove the disc and turn off the power.
- If you do not use the DVD video player for a long period, the unit may not function properly in the future. Turn on and use the DVD video player occasionally.

### Notes on locating

- Place the DVD video player on a level surface. Do not use it on a shaky or unstable surface such as a wobbling table or inclined stand. The loaded disc may come off the proper position and cause damage to the DVD video player.
- When you place this DVD video player near a TV, radio, or VCR, the playback picture may become poor and the sound may be distorted. In this case, place the DVD video player away from the TV, radio, or VCR.

### Notes on cleaning

Use a soft, dry cloth for cleaning.

- For stubborn dirt, soak the cloth in a weak detergent solution, wring well and wipe. Use a dry cloth to wipe it dry.  
Do not use any type of solvent, such as thinner and benzine, as they may damage the surface of the DVD video player.
- If you use a chemical saturated cloth to clean the unit, follow that product's instructions.

### To obtain a clear picture

The DVD video player is a high technology, precision device. If the optical pick-up lens and disc drive parts are dirty or worn down, the picture quality becomes poor. To obtain a clear picture, we recommend regular inspection and maintenance (cleaning or parts replacement) every 1,000 hours of use depending on the operating environment. For details, contact your nearest dealer.

### Notes on moisture condensation

**Moisture condensation damages the DVD video player. Please read the following carefully.**

Moisture condensation occurs, for example, when you pour a cold drink into a glass on a warm day. Drops of water form on the outside of the glass. In the same way, moisture may condense on the optical pick-up lens inside this unit, one of the most crucial internal parts of the DVD video player.

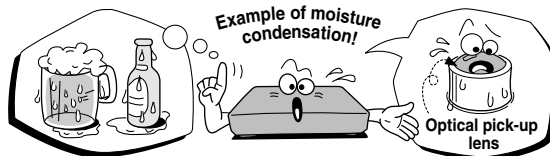

■ **Moisture condensation occurs during the following cases.**

- When you bring the DVD video player directly from a cold place to a warm place.
- When you use the DVD video player in a room where you just turned on the heater, or a place where the cold wind from the air conditioner directly hits the unit.
- In summer, when you use the DVD video player in a hot and humid place just after you move the unit from an air conditioned room.
- When you use the DVD video player in a humid place.

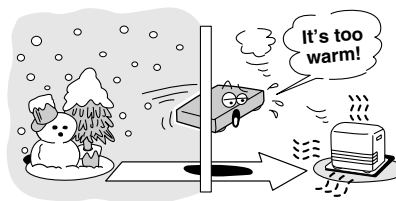

■ **Do not use the DVD video player when moisture condensation may occur.**

If you use the DVD video player in such a situation, it may damage discs and internal parts. Remove the disc, connect the power cord of the DVD video player to the wall outlet, turn on the DVD video player, and leave it for two or three hours. After two or three hours, the DVD video player will have warmed up and evaporated any moisture. Keep the DVD video player connected to the wall outlet and moisture condensation will seldom occur.

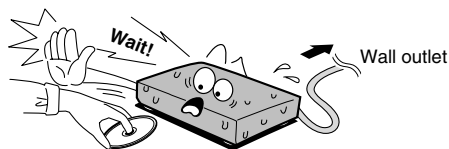



## On handling discs

- Do not touch the playback side of the disc.

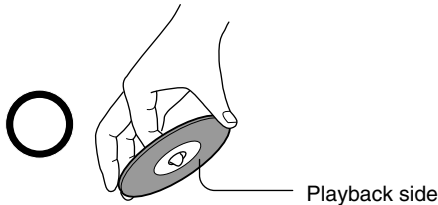

- Do not attach paper or tape to discs.



## On cleaning discs

- Fingerprints and dust on the disc cause picture and sound deterioration. Wipe the disc from the center outwards with a soft cloth. Always keep the disc clean.

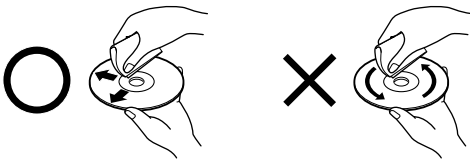

- If you cannot wipe off the dust with a soft cloth, wipe the disc lightly with a slightly moistened soft cloth and finish with a dry cloth.
- Do not use any type of solvent such as thinner, benzene, commercially available cleaners or antistatic spray for vinyl LPs. It may damage the disc.

## On storing discs

- Do not store discs in a place subject to direct sunlight or near heat sources.
- Do not store discs in places subject to moisture and dust such as a bathroom or near a humidifier.
- Store discs vertically in a case. Stacking or placing objects on discs outside of their case may cause warping.

## Structure of disc contents

Normally, DVD video discs are divided into titles, and the titles are sub-divided into chapters. VIDEO CDs/ audio CDs are divided into tracks.

DVD video disc

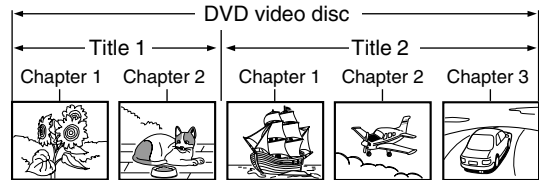

VIDEO CD/Audio CD

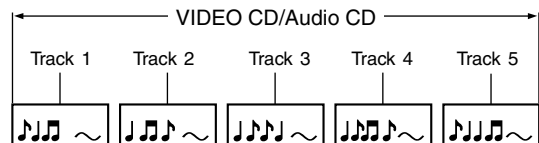

Each title, chapter or track is assigned a number, which is called "title number", "chapter number" or "track number" respectively.

There may be discs that do not have these numbers.

## Notes on copyright

It is forbidden by law to copy, broadcast, show, broadcast on cable, play in public, and rent copyrighted material without permission.

DVD video discs are copy protected, and any recordings made from these discs will be distorted.

This product incorporates copyright protection technology that is protected by method claims of certain U.S. patents and other intellectual property rights owned by Macrovision Corporation and other rights owners. Use of this copyright protection technology must be authorized by Macrovision Corporation, and is intended for home and other limited viewing uses only unless otherwise authorized by Macrovision Corporation. Reverse engineering or disassembly is prohibited.



## Notes on Discs (continued)

### About this owner's manual

This owner's manual explains the basic instructions of this DVD video player. Some DVD video discs are produced in a manner that allows specific or limited operation during playback. As such, the DVD video player may not respond to all operating commands. This is not a defect in the DVD video player. Refer to instruction notes of discs.

"Ⓢ" may appear on the TV screen during operation. A "Ⓢ" means that the operation is not permitted by the DVD video player or the disc.

### Notes on region numbers

The region number of this DVD video player is 1. If region numbers, which stand for their playable area, are printed on your DVD video disc and you do not find  or , disc playback will not be allowed by the player. (In this case, the DVD video player will display a message on-screen.)

### On VIDEO CDs

This DVD video player supports VIDEO CDs equipped with the PBC (Version 2.0) function. (PBC is the abbreviation of Playback Control.) You can enjoy two playback variations depending on types of discs.

- **VIDEO CD not equipped with PBC function (Version 1.1)**

Sound and movie can be played on this DVD video player in the same way as an audio CD.

- **VIDEO CD equipped with PBC function (Version 2.0)**

In addition to operation of a VIDEO CD not equipped with the PBC function, you can enjoy playback of interactive software with search function by using the menu displayed on the TV screen (Menu Playback). Some of the functions described in this owner's manual may not work with some discs.

### Playable discs

This DVD video player can play the following discs.

	Disc Mark	Contents	Disc Size	Maximum playback time
DVD video discs		Audio + video (moving pictures)	12 cm	Approx. 4 hours (single sided disc)
				Approx. 8 hours (double sided disc)
			8 cm	Approx. 80 minutes (single sided disc)
				Approx. 160 minutes (double sided disc)
VIDEO CDs		Audio + video (moving pictures)	12 cm	Approx. 74 minutes
			8 cm	Approx. 20 minutes
Audio CDs		Audio	12 cm	Approx. 74 minutes
			8 cm (CD single)	Approx. 20 minutes
<p>The following discs are also available.</p> <ul style="list-style-type: none"> <li>● CD-R</li> <li>● CD-RW</li> </ul> <p>CD-R/RW discs recorded by CD-DA method can be played. Some CD-R/RW discs may be incompatible.</p>				

- You cannot play discs other than those listed above.
- You cannot play discs of DVD-RAM, DVD-RW, etc., even if they may be labeled marks listed above.
- This DVD video player uses the NTSC color system, and cannot play DVD video discs recorded in any other color system (PAL, SECAM, etc.).

# Table of Contents

## Introduction

● SAFETY PRECAUTIONS .....	2
● IMPORTANT SAFETY INSTRUCTIONS ...	4
● Precautions .....	8
● Notes on Discs .....	9
Notes on region numbers .....	10
● Table of Contents .....	11
● Identification of Controls .....	12
Front panel .....	12
Rear panel .....	12
DVD display .....	13
Remote control .....	14
Loading batteries .....	15
Operating with the remote control .....	15

## Connections

● Connecting to a TV .....	18
Connecting to a TV .....	18
Connecting to an audio system and TV equipped with ColorStream® (Component video) inputs .....	19
● Connecting to Optional Equipment .....	20
Connecting to an amplifier equipped with a Dolby Digital decoder .....	21
Connecting to an amplifier equipped with Dolby Pro Logic Surround .....	21
Connecting to an amplifier equipped with a DTS decoder .....	22
Connecting to an amplifier equipped with an MPEG2 audio decoder .....	22
Connecting to an amplifier equipped with 5.1ch audio inputs .....	23
Connecting to an amplifier equipped with a digital audio input .....	23

## Basic playback

● Playing a Disc .....	26
Basic playback .....	26
Playing in fast reverse or fast forward directions .....	28
Playing frame by frame .....	28
Playing in slow-motion .....	29
Resuming playback from the same location ...	29
● Locating a Specific Title, Chapter, or Track .....	30
Locating a title using the top menu .....	30
Locating a title by entering the title number ....	30
Locating a specific chapter or track directly ...	31
Locating a specific chapter or track .....	31

## Advanced playback

● Accessing a Specific Location Directly ..	34
Entering the time of the desired location .....	34
● Playing Repeatedly .....	35
Repeating a title, chapter, or track .....	35
Repeating a specific segment .....	35
● Playing in a Favorite Order .....	36
Setting titles, chapters, or tracks in a favorite order .....	36
● Playing in Random Order .....	37
Playing titles, chapters or tracks in random order .....	37
● Zooming a Picture .....	38
Zooming a picture .....	38
● Selecting DNR Picture Enhancement ...	39
Selecting DNR picture enhancement .....	39
● Selecting 3-D (N-2-2) Sound Enhancement ..	39
Selecting 3-D (N-2-2) sound enhancement ....	39
● Selecting the Camera Angle .....	40
Changing the camera angle .....	40
● Selecting Subtitles .....	41
Selecting a subtitle language .....	41
● Selecting a Language .....	42
Selecting a playback audio setting .....	42

## Quick control

● Using the Graphic Remote Control	
- V-REMOTE - .....	46
● Selecting the Playback Function	
- QUICK - .....	47
● Accessing Features	
- NAVI - .....	48

## Function setup

● Customizing the Function Settings .....	54
Setting procedure .....	54
Setting details .....	56
● Table of Languages .....	64
● Operating a TV with the Remote Control .....	65

## Others

● Before Calling Service Personnel .....	68
● Specifications .....	69
● LIMITED WARRANTY DVD VIDEO PLAYER .....	70

# Identification of Controls

See the page in   for details.

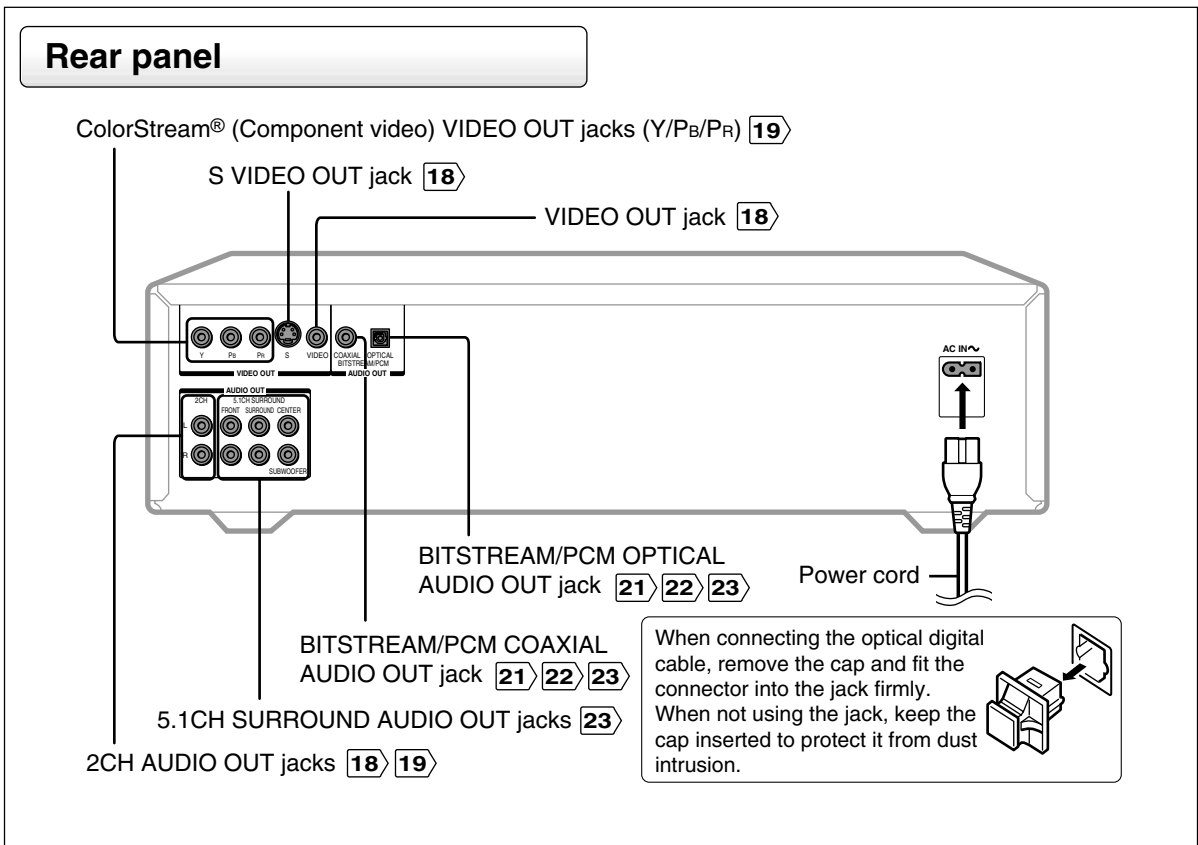
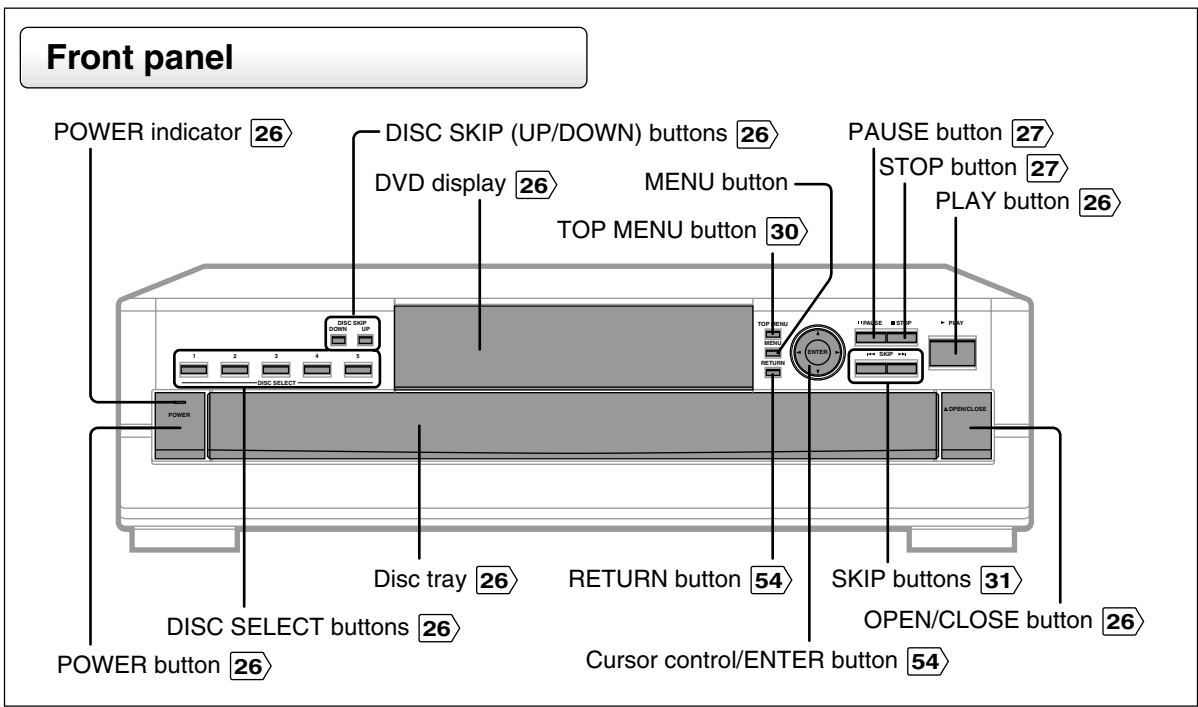

## DVD display

■ Repeated pressing of the FL DIMMER button on the remote control changes the brightness of the display.

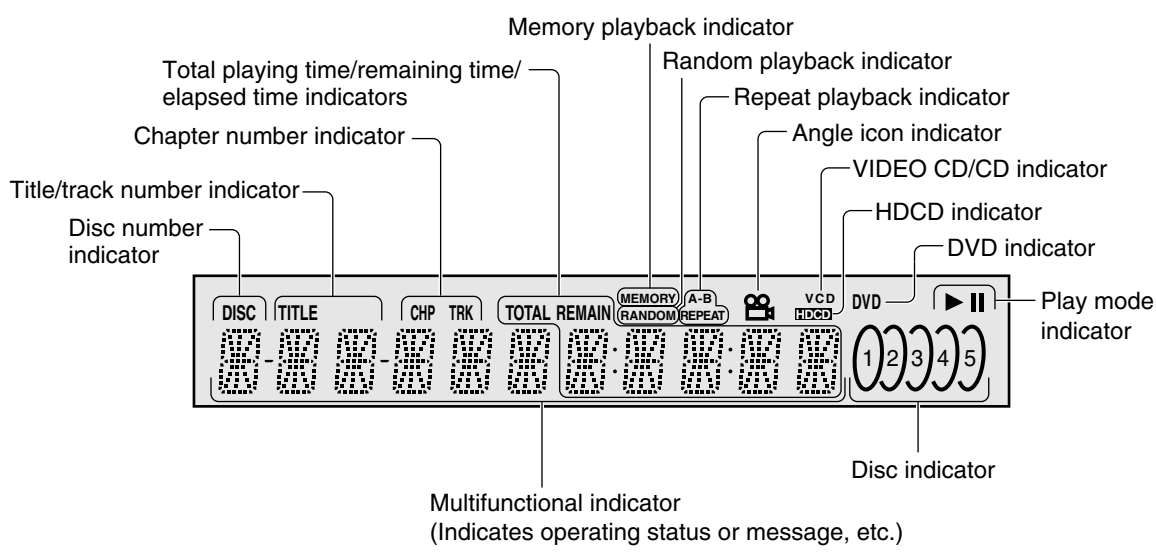
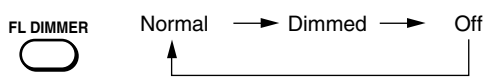

The indicators vary depending on the kinds of discs you play.

### DVD video disc

- During playback:

Example

Playing chapter 3 Elapsed time of of title 2

- Some discs may not display chapter numbers.
- A time indication not accompanied with a chapter number shows elapsed time of a segment within the current title.

### VIDEO CD

- During playback:

Example

Playing track 6 Elapsed time of the current track

Some discs may not display track numbers or elapsed time.

### Audio CD

- During playback:

Example

Playing track 6 Elapsed time of the current track

# Identification of Controls (continued)

The instructions in this manual describe the functions on the remote control. See the page in   for details.

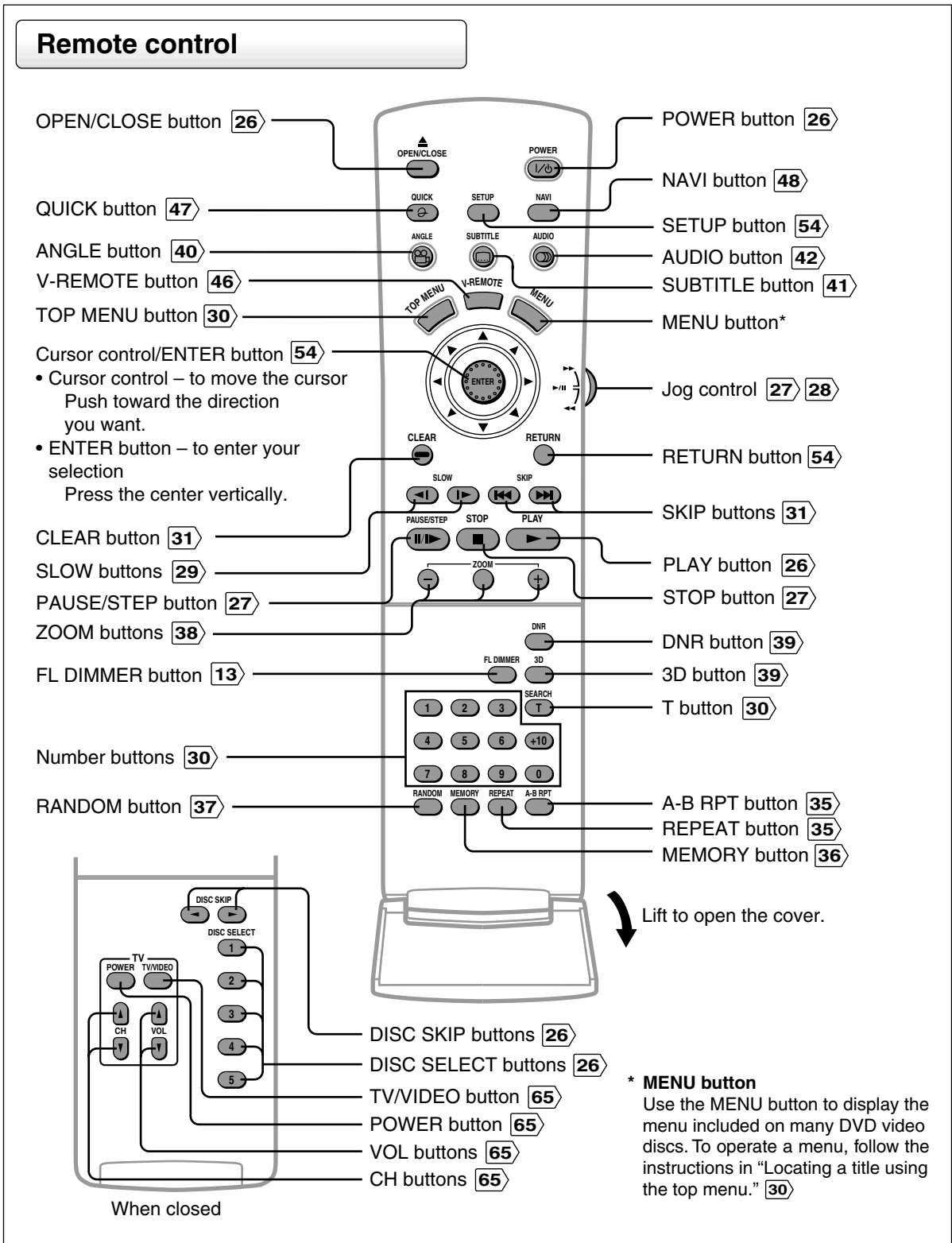

## Loading batteries

### 1 Open the cover.

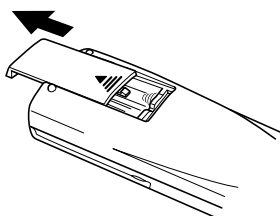

### 2 Insert batteries (AAA size).

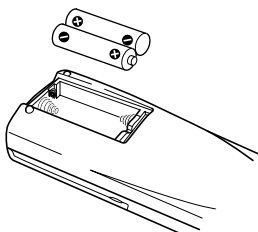

Make sure to match the + and – on the batteries to the marks inside the battery compartment.

### 3 Close the cover.

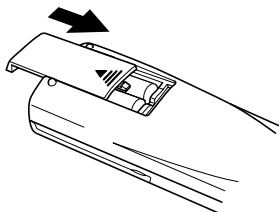

#### Notes on batteries

Improper use of batteries may cause battery leakage and corrosion. To operate the remote control correctly, follow the instructions below.

- Do not insert batteries into the remote control in the wrong direction.
- Do not charge, heat, open, or short-circuit the batteries. Do not throw batteries into a fire.
- Do not leave dead or exhausted batteries in the remote control.
- Do not use different types of batteries together, or mix old and new batteries.
- If you do not use the remote control for a long period of time, remove the batteries to avoid possible damage from battery corrosion.
- If the remote control does not function correctly or if the operating range becomes reduced, replace all batteries with new ones.
- If battery leakage occurs, wipe the battery liquid from the battery compartment, then insert new batteries.

## Operating with the remote control

Point the remote control at the remote sensor and press the buttons.

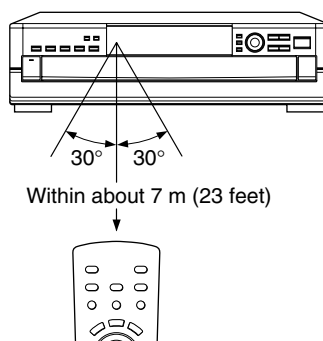

Distance: About 7 m (23 feet) from the front of the remote sensor

Angle: About 30° in each direction of the front of the remote sensor

\* Do not expose the remote sensor of the DVD video player to a strong light source such as direct sunlight or other illumination. If you do so, you may not be able to operate the DVD video player via the remote control.

#### Notes on the remote control

- Direct the remote control at the remote sensor of the DVD video player.
- Do not drop or give the remote control a shock.
- Do not leave the remote control near an extremely hot or humid place.
- Do not spill water or put anything wet on the remote control.
- Do not open the remote control.

# Connections

Read this chapter first to make all necessary preparations.

- **Connecting to a TV**
- **Connecting to an audio system and TV equipped with component video inputs**
- **Connecting to an amplifier equipped with a Dolby Digital decoder**
- **Connecting to an amplifier equipped with Dolby Pro Logic Surround**
- **Connecting to an amplifier equipped with a DTS decoder**
- **Connecting to an amplifier equipped with an MPEG2 audio decoder**
- **Connecting to an amplifier equipped with 5.1ch audio inputs**
- **Connecting to an amplifier equipped with a digital audio input**



# Connecting to a TV

Connect the DVD video player to your TV.  
 For details of output sound, see [43](#).

## Connecting to a TV

➔ Signal flow

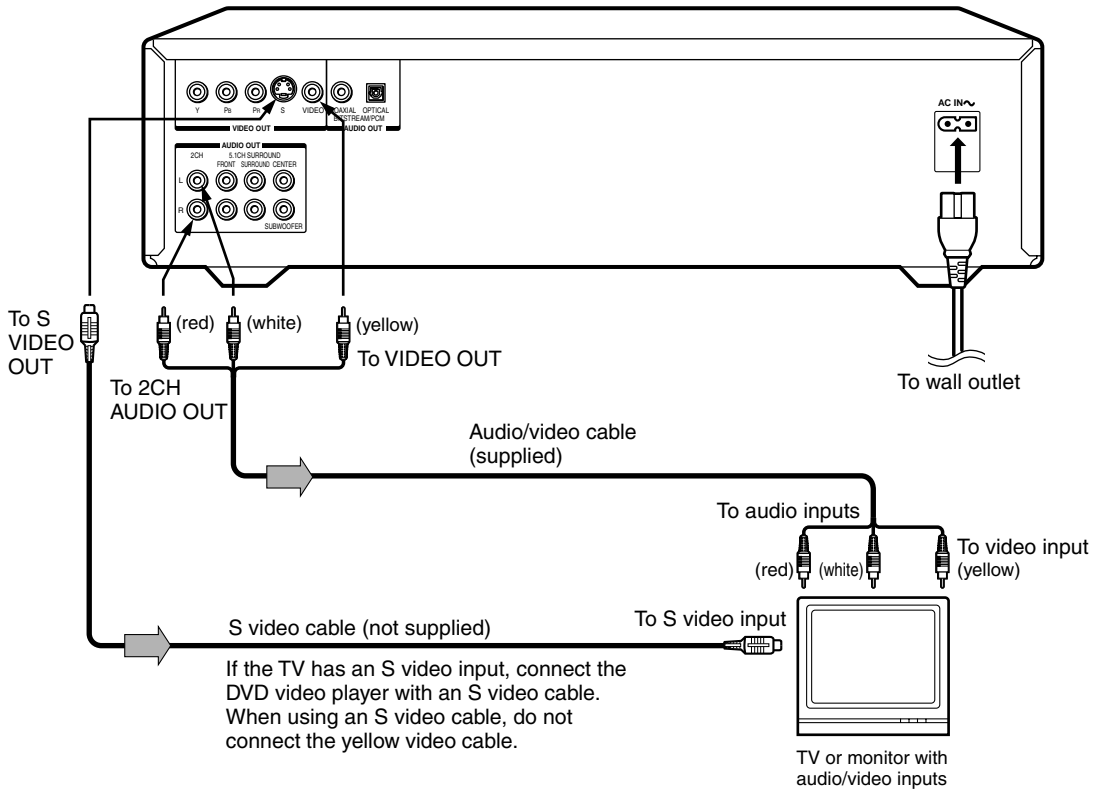

• Make the following setting.

On-screen display	Select:	Page
"Audio Out Select"	"Analog 2ch"	<a href="#">54</a>
		<a href="#">57</a>

**Notes**

- Refer to the owner's manual of the connected TV as well.
- When you connect the DVD video player to your TV, be sure to turn off the power and unplug both units from the wall outlet before making any connections.
- If your television set has one audio input, connect the DVD video player to a Y cable adapter (not supplied) and then connect to your TV.
- Connect the DVD video player directly to your TV. If you connect the DVD video player to a VCR, TV/VCR combination or video selector, the playback picture may be distorted as DVD video discs are copy protected.

## Connecting to an audio system and TV equipped with ColorStream® (Component video) inputs

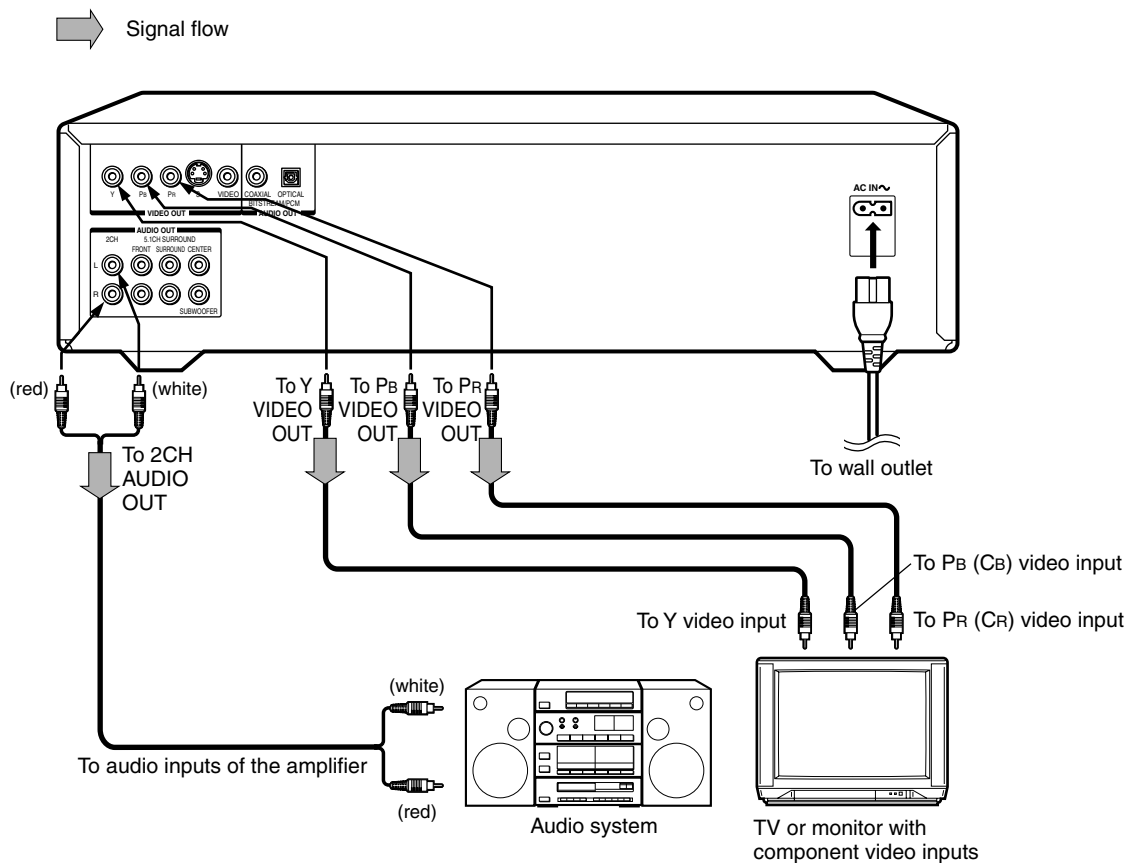

### ColorStream® (Component video) outputs/inputs

Some TVs or monitors are equipped with component video inputs. Connecting to these inputs allows you to enjoy higher quality picture playback.

Actual labels for component video inputs may vary depending on the TV manufacturer. (ex. Y, R-Y, B-Y or Y, CB, CR)

In some TVs or monitors, the color levels of the playback picture may be reduced slightly or the tint may change. In such a case, adjust the TV or monitor for optimum performance.

### Notes

- Refer to the owner's manual of the connected equipment as well.
- When you connect the DVD video player to other equipment, be sure to turn off the power and unplug all of the equipment from the wall outlet before making any connections.
- If you place the DVD video player near a tuner or radio, the radio broadcast sound might be distorted. In this case, place the DVD video player away from the tuner and radio.
- The output sound of the DVD video player has a wide dynamic range. Be sure to adjust the receiver's volume to a moderate listening level. Otherwise, the speakers may be damaged by a sudden high volume sound.
- Turn off the amplifier before you connect or disconnect the DVD video player's power cord. If you leave the amplifier power on, the speakers may be damaged.

- Make the following setting.

On-screen display	Select:	Page
"Audio Out Select"	"Analog 2ch"	54
		57

## Connecting to Optional Equipment

You can enjoy high quality dynamic sounds by connecting the DVD video player to optional audio equipment.

- For connection to your TV, see “Connecting to a TV” [18](#) [19](#).
- For details of output sound, see [43](#).
- This section uses the following reference marks.

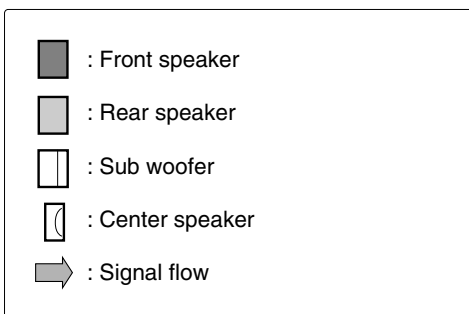

### Notes

- DO NOT connect the BITSTREAM/PCM AUDIO OUT jack of the DVD video player to the AC-3 RF input of a Dolby Digital Receiver. This input on your A/V Receiver is reserved for Laserdisc use only and is incompatible with the BITSTREAM/PCM AUDIO OUT jack of the DVD video player.
- Connect the BITSTREAM/PCM AUDIO OUT jack of the DVD video player to the “OPTICAL” or “COAXIAL” input of a Receiver or Processor.
- Refer to the owner’s manual of the connected equipment as well.
- When you connect the DVD video player to other equipment, be sure to turn off the power and unplug all of the equipment from the wall outlet before making any connections.
- The output sound of the DVD video player has a wide dynamic range. Be sure to adjust the receiver’s volume to a moderate listening level. Otherwise, the speakers may be damaged by a sudden high volume sound.
- Turn off the amplifier before you connect or disconnect the DVD video player’s power cord. If you leave the amplifier power on, the speakers may be damaged.

### Warning

- When you are connecting (via the BITSTREAM/PCM AUDIO OUT jack) an AV decoder that does not have Dolby Digital, Digital Theater Systems (DTS) or MPEG2 decoding function, be sure to set “Audio Out Select” to “PCM” from the on-screen displays [54](#) [57](#). Otherwise, high volume sound may damage your hearing as well as the speakers.
- When playing DTS-encoded discs (DVD video discs and audio CDs), excessive noise may be output from the analog stereo jacks. To avoid possible damage to the audio system, you should take proper precautions when the 2CH AUDIO OUT jacks of the DVD video player are connected to an amplification system. To enjoy DTS Digital Surround™ playback, an external 5.1 channel DTS Digital Surround™ decoder system must be connected to the BITSTREAM/PCM AUDIO OUT jack of the DVD video player.

## Connecting to an amplifier equipped with a Dolby Digital decoder

### Dolby Digital

Dolby Digital is the surround sound technology used in theaters showing the latest movies, and is now available to reproduce this realistic effect in the home. You can enjoy motion picture and live concert DVD video discs with this dynamic realistic sound by connecting the DVD video player to a 6 channel amplifier equipped with a Dolby Digital decoder or Dolby Digital processor. If you have a Dolby Pro Logic Surround decoder, you will obtain the full benefit of Pro Logic from the same DVD movies that provide full 5.1-channel Dolby Digital soundtracks, as well as from titles with the Dolby Surround mark.

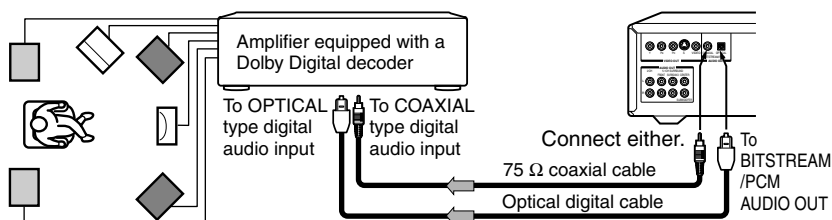

Manufactured under license from Dolby Laboratories. "Dolby", "Pro Logic" and the double-D symbol are trademarks of Dolby Laboratories. Confidential unpublished works. ©1992-1997 Dolby Laboratories. All rights reserved.

- Use DVD video discs encoded via the Dolby Digital recording system.
- Make the following setting.

On-screen display	Select:	Page
"Audio Out Select"	"Bitstream"	54
		57
Recording system		42

## Connecting to an amplifier equipped with Dolby Pro Logic Surround

### Dolby Pro Logic Surround

You can enjoy the dynamic realistic sound of Dolby Pro Logic Surround by connecting an amplifier and speaker system (right and left front speakers, a center speaker, and one or two rear speakers).

- With an amplifier equipped with Dolby Digital  
Connect the equipment the same way as described in "Connecting to an amplifier equipped with a Dolby Digital decoder." Refer to that amplifier's owner's manual and set the amplifier so you can enjoy Dolby Pro Logic Surround sound.
- With an amplifier not equipped with Dolby Digital  
Connect the equipment as follows.

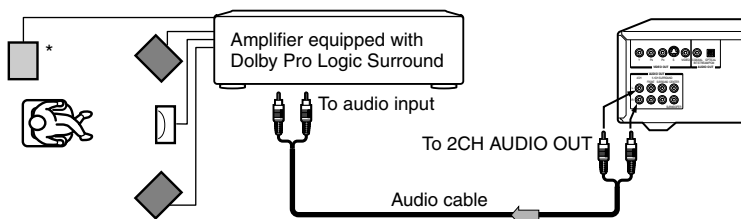

- Make the following setting.

On-screen display	Select:	Page
"Audio Out Select"	"Analog 2ch"	54
		57

**Be sure to set "Audio Out Select" to "Analog 2ch" when you enjoy sounds of Dolby Pro Logic Surround using this connection.**

\* Connect one or two rear speakers. The output sound from the rear speakers will be monaural even if you connect two rear speakers.

# Connecting to Optional Equipment (Continued)

## Connecting to an amplifier equipped with a DTS decoder

### Digital Theater Systems (DTS)

DTS is a high quality surround technology used in theaters and now available for home use, on DVD video discs or audio CDs.

If you have a DTS decoder or processor, you can obtain the full benefit of 5.1 channel DTS encoded sound tracks on DVD video discs or audio CDs.

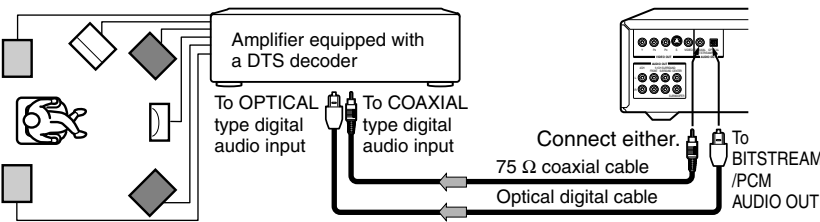

"DTS" and "DTS Digital Surround" are trademarks of Digital Theater Systems, Inc.

- Use DVD video discs or audio CDs encoded via the DTS recording system.
- Make the following setting.

On-screen display	Select:	Page
"Audio Out Select"	"Bitstream"	54
	"Bitstream"	57
Recording system	DTS	42

## Connecting to an amplifier equipped with an MPEG2 audio decoder

### MPEG2 sound

You can enjoy motion picture and live concert DVD video discs with dynamic realistic sound by connecting an amplifier equipped with an MPEG2 audio decoder or MPEG2 audio processor.

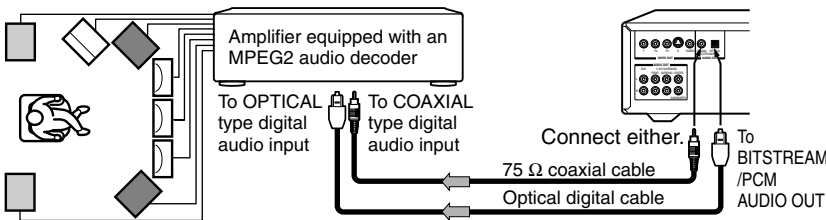

- Use DVD video discs encoded via the MPEG2 recording system.
- Make the following setting.

On-screen display	Select:	Page
"Audio Out Select"	"Bitstream"	54
	"Bitstream"	57
Recording system	MPEG	42

## Connecting to an amplifier equipped with 5.1ch audio inputs

### 5.1ch surround sound

The Dolby Digital and DTS decoder equipped with this DVD video player enables you to obtain the full benefit of 5.1 channel sound tracks when you connect the DVD video player to an amplifier equipped with 5.1 channel audio inputs.

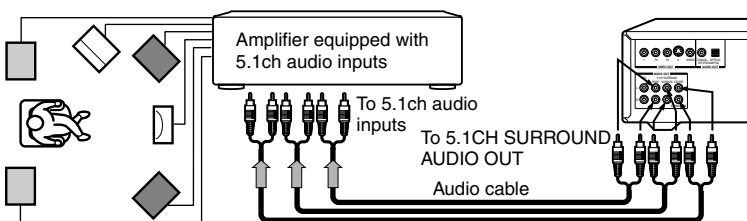

- Use DVD video discs encoded via the Dolby Digital or DTS recording system.
- Make the following setting.

On-screen display	Select:	Page
"Audio Out Select"	"Analog 6ch"	54
Recording system	<input type="checkbox"/> D <input type="checkbox"/> DTS <input type="checkbox"/> MPEG	42

2 channel sound (except DTS) is output in the Dolby Pro Logic format. To obtain the original 2 channel sound, select "Analog 2ch."

## Connecting to an amplifier equipped with a digital audio input

### 2 channel digital stereo

You can enjoy the dynamic sound of 2 channel digital stereo by connecting an amplifier equipped with a digital audio input and speaker system (right and left front speakers).

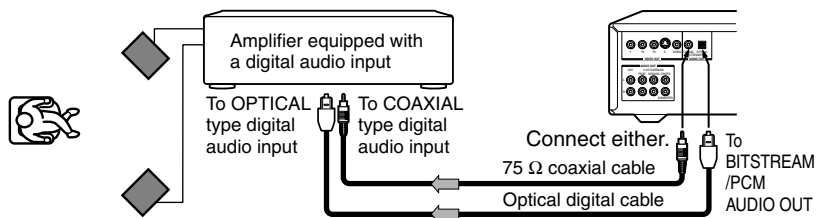

- Make the following setting.

On-screen display	Select:	Page
"Audio Out Select"	"PCM"	54
		57

# Basic playback

Begin your operation.

- **Playing a Disc**
- **Locating a Specific Title, Chapter, or Track**

# Playing a Disc

This section shows you the basics on how to play a disc.

## CAUTION

Keep your fingers well clear of the disc tray as it is closing. Neglecting to do so may cause serious personal injury.

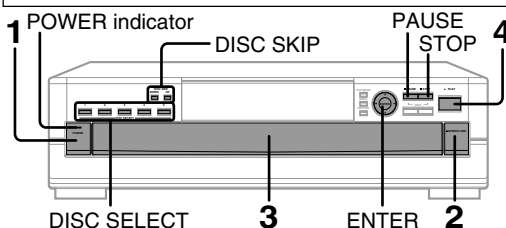

## Basic playback

### Preparations

- When you want to view a disc, turn on the TV and select the video input connected to the DVD video player.
- When you want to enjoy the sound of discs from the audio system, turn on the audio system and select the input connected to the DVD video player.

### 1 Press POWER.

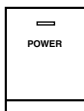

The DVD video player turns on and the POWER indicator on the player illuminates.

When the DVD video player is turned on for the first time, a message appears. Press **ENTER**, and make the proper settings before proceeding to step 2. [63](#)

### 2 Press OPEN/CLOSE.

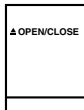

The disc tray opens.

### 3 Place a disc in the front disc holder. (DISC 1)

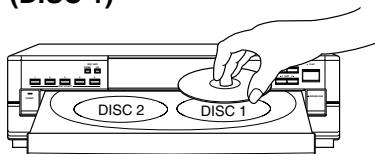

With the playback side down.

- There are two different disc sizes. Place the disc in the correct guide on the disc tray. If the disc is out of the guide, it may damage the disc and cause the DVD video player to malfunction.
- Do not place a disc which is unplayable in this DVD video player.

#### ■ Placing discs in the remaining disc holders

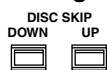

Repeatedly press the DISC SKIP button on the DVD video player to rotate the disc tray, and place a disc in each desired holder (1 – 5).

- After inserting a disc, you can start playback of the disc in the front holder simply by pressing the PLAY button. In that case, the tray closes automatically.

### 4 Press PLAY.



Playback starts.

If you insert a DVD video disc that contains a top menu, a menu may appear. See "Locating a title using the top menu." [30](#)  
You may need to press the TOP MENU or MENU button to display disc menu (depending on the actual DVD video disc.)

#### ■ Selecting the desired disc for playback

Press one of the **DISC SELECT 1 – 5** buttons. The DVD video player starts playing the first title of the selected disc. There is no need to press the PLAY button.



#### Notes

- If you select the desired disc using one of the DISC SELECT 1 – 5 buttons while the DVD video player is playing back a title of another disc, playback starts with the first title of the newly selected disc.
- You can also press the DISC SKIP button to jump to the disc in the next holder (or from holder #5 to holder #1 if the disc in holder #5 is currently being played back). In that case playback will start with the first title of the disc in the newly selected holder.



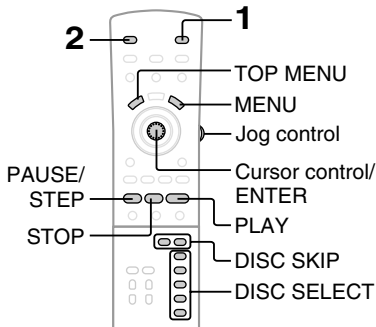

### ■ To obtain a higher quality picture

Occasionally, some picture noise not usually visible during a normal broadcast may appear on the TV screen while playing a DVD video disc because the high resolution pictures on these discs include a lot of information. While the amount of noise depends on the TV you use with this DVD video player, you should generally reduce the sharpness adjustment on your TV when viewing DVD video discs.

### ■ About

The icons on the heading bar show the playable discs for the function described under that heading.

: You can use this function with DVD video discs.

: You can use this function with VIDEO CDs.

: You can use this function with audio CDs.

### ■ To pause playback (still mode)

Press **PAUSE/STEP** during playback.



To resume normal playback, press the **PLAY** button.

Alternatively press the **jog control** during normal playback.

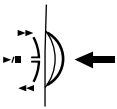

To resume normal playback, press the jog control again.

- Sound is muted during still mode.

### ■ To stop playback

Press **STOP**.



### ■ About the screen saver

If you pause a picture of a DVD video disc and leave it still for a long while, the screen saver of the DVD video player automatically appears (when "Screen Saver" is set to "On" ). To turn off the screen saver, press the **PLAY** button.

### ■ Automatic Power Off function

If the DVD video player is stopped, or the screen saver is engaged for approximately 20 minutes, the DVD video player will automatically turn itself off.

### ■ HDCD (High Definition Compatible Digital®)

HDCD® (High Definition Compatible Digital®) is a recording system that has improved audio CD sound in dynamic range, sound field reproducibility and vocal acoustics.

This DVD video player is equipped with an HDCD decoder. The HDCD indicator illuminates when playing an HDCD-encoded audio CD.

®, HDCD®, High Definition Compatible Digital® and Pacific Microsonics™ are either registered trademarks or trademarks of Pacific Microsonics, Inc. in the United States and/or other countries. HDCD system manufactured under license from Pacific Microsonics, Inc. This product is covered by one or more of the following patents: United States: 5,479,168, 5,638,074, 5,640,161, 5,808,574, 5,838,274, 5,854,600, 5,872,531 and 5,864,311. Australia 669114. Other patents pending.

### Notes

- Do not press against the tray when it is opening. This can cause damage to the player's transport and disc holder.
- For your safety, if the disc holder is restrained during opening or closing, the tray operation will stop automatically. Do not push on the disc tray to close it. Always use the OPEN/CLOSE button.
- Do not move the DVD video player when discs are loaded in the player. Damage may occur to the discs as well as the player's transport and disc holder.
- In many instances, a menu screen will appear after playback of a movie is completed. Prolonged display of an on-screen menu may damage your television set, permanently etching that image onto its screen. To avoid this, be sure to press the STOP button on your remote control once the movie is completed.

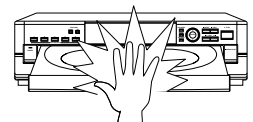

## Playing a Disc (continued)

You can play discs at various speeds, and resume playback from the location where you stopped playback.

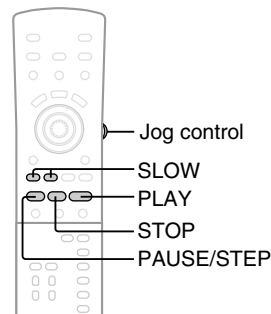

### DVD VCD CD Playing in fast reverse or fast forward directions

During normal playback, move the jog control toward ►► or ◀◀.



◀◀ : Fast reverse playback  
►► : Fast forward playback

Each time you move the jog control up or down, the playback speed changes.

#### ■ To resume normal playback

Press **PLAY** or press the **jog control**.

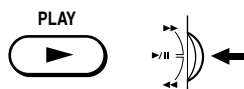

#### Notes

- The DVD video player mutes sound and omits subtitles during reverse and forward scan of DVD video discs. However, the DVD video player plays sound during fast forward or fast reverse play of audio CDs.
- The playback speed may differ depending on the disc.

### DVD VCD Playing frame by frame

Press **PAUSE/STEP** during still playback.



Each time you press the **PAUSE/STEP** button, the picture advances one frame.

#### ■ To resume normal playback

Press **PLAY**.







#### Note

The sound is muted during frame by frame playback.

## Playing in slow-motion

### Press SLOW during playback.

**SLOW**  Each time you press the SLOW  button, the slow-motion speed changes.

**SLOW**   If you press the SLOW  button during playback, you can view the picture in reverse slow-motion. (Only when using a DVD video disc.)

Each time you press the SLOW  button, the slow-motion speed changes.

### ■ To resume normal playback

Press **PLAY**.



#### Notes

- The sound is muted during slow-motion playback.
- The playback speed may differ depending on the disc.

## Resuming playback from the same location

### 1 Press **STOP** at the location where you want to interrupt playback.

**STOP**  The DVD video player memorizes the location where playback is stopped.

### 2 Press **PLAY**.

**PLAY**  The DVD video player resumes playback from the location where you stopped playback.

### 2 Press **PLAY**.





 Playback starts from the beginning of the current title.

 Playback starts from the beginning of the disc.

- If you want to return to the beginning of a DVD video disc, open and close the disc tray once with the OPEN/CLOSE button before pressing the PLAY button.

#### Notes

- The DVD video player's memory is also cleared when:
  - you unplug the DVD video player from the wall outlet after you stop playback.
  - you change the parental lock setting  or select a disc menu language .
  - you open the disc tray.
  - you switch the discs by pressing the DISC SELECT 1 – 5 button.
- There may be a difference in the location where playback resumes depending on the disc.
- Settings you changed using the on-screen displays while the DVD video player keeps a location in the memory may function only after the memory is cleared.

### ■ To start playback from the beginning regardless of the location where you stopped playback

#### 1 Press **STOP** twice.

**STOP**  The DVD video player's memory is cleared.

## Locating a Specific Title, Chapter, or Track

Normally, DVD video discs are divided into titles, and the titles are sub-divided into chapters. VIDEO CDs and audio CDs are divided into tracks. You can quickly locate any specific title, chapter, or track.

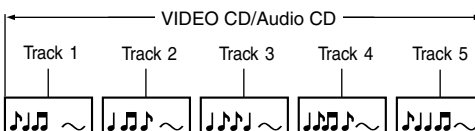
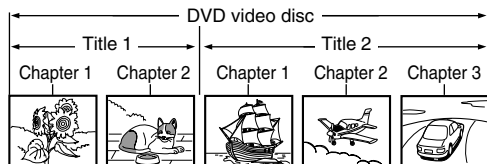

### DVD Locating a title using the top menu

#### 1 Press TOP MENU.



The top menu appears on the TV screen.

e.g.

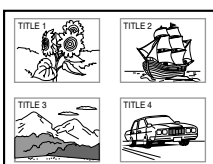

#### 2 Select the title you want moving the cursor control.

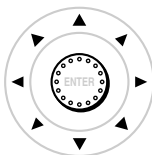

If the titles in the top menu are assigned a number, you can directly locate a specific title by pressing its designated number with the number buttons.

#### 3 Press ENTER.



Playback starts from chapter 1 of the selected title.

#### Notes

- The instructions above describe basic procedures which may vary depending on the contents of the DVD video disc. If different instructions appear on the TV screen, follow those instructions.
- If you display the top menu during playback and press the TOP MENU button again without selecting any title, the DVD video player may resume playback from the point where you first pressed the TOP MENU button (depending on the actual DVD video disc.)
- This method of locating a title is available only on a disc that contains a top menu.
- Instruction notes of discs may refer to the button that displays the top menu as TITLE button.

### DVD Locating a title by entering the title number

#### 1 Press T.



Make sure that the space next to "Title" is highlighted. (You can shift the highlight moving the cursor control (▲ / ▼).)

Title: **1**  
Chapter: 1

#### 2 Press the corresponding number buttons for the title you want.

e.g. To select title 2 **2**

To select title 12 **1** → **2**

#### 3 Press PLAY.



Playback starts from chapter 1 of the selected title.

#### Notes

- Pressing the CLEAR button resets the title and chapter numbers. To clear the "Title" and "Chapter" display, press the T button several times.
- This method of locating a title is available only on a disc that contains title numbers.

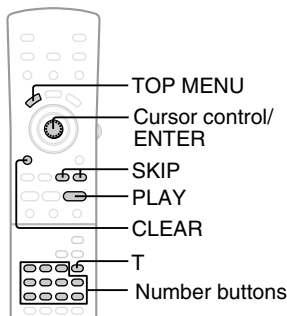

**DVD VCD CD** **Locating a specific chapter or track directly**

**1 Press T.**  
Skip steps 1 and 2 if you are using a VIDEO CD/ audio CD.

SEARCH  
T

Title: 1  
Chapter: 1

**2 Move the cursor control (▼) to highlight the space next to "Chapter."**

Title: 1  
Chapter: 1

**3 Press the corresponding number buttons for the chapter or track you want.**

You can use the +10 button to select numbers from 10 through 99.

e.g. To select chapter or track 25

2 → 5  
or +10 → +10 → 5

**4 Press PLAY.**

PLAY

Playback starts from the selected chapter or track.

■ **To select a title and chapter number at the same time**  
Perform step 1, and enter a title number you want in the space next to "Title" using the number buttons, then perform steps 2 to 4.

**Note**  
Pressing the CLEAR button resets the title and chapter numbers. To clear the "Title" and "Chapter" display, press the T button several times.

**DVD VCD CD** **Locating a specific chapter or track**

**Press SKIP ◀◀ or ▶▶ repeatedly to display the chapter or track number you want.**  
Playback starts from the selected chapter or track.

SKIP  
◀◀ ▶▶ To locate succeeding chapters or tracks

SKIP  
◀▶ ▶▶ Playback starts from the beginning of the current chapter or track. When you press twice, playback starts from the beginning of the preceding chapter or track.

**Notes**

- Some titles may not display chapter numbers.
- When you set "Title Stop" to "Off" [62], you can access chapters in another title. If you go back to the preceding title by pressing the SKIP ◀◀ button, the DVD video player locates the first chapter of the title. When "Title Stop" is set to "On," you can access chapters only within the current title.
- If you press and hold the SKIP ◀◀ or ▶▶ button on the front panel during playback, the DVD video player performs fast reverse or fast forward playback. You can vary the speed by pressing the button further. To locate chapters or tracks during fast reverse or fast forward playback, first press the PLAY button to resume normal playback, then use the SKIP ◀◀ or ▶▶ button.

# **Advanced playback**

Customizing the performance of your DVD video player.

- **Accessing a Specific Location Directly**
- **Playing Repeatedly**
- **Playing in a Favorite Order**
- **Playing in Random Order**
- **Zooming a Picture**
- **Selecting DNR Picture Enhancement**
- **Selecting 3-D (N-2-2) Sound Enhancement**
- **Selecting the Camera Angle**
- **Selecting Subtitles**
- **Selecting a Language**

## Accessing a Specific Location Directly

You can access a specific location by entering its corresponding time (hours, minutes, seconds).

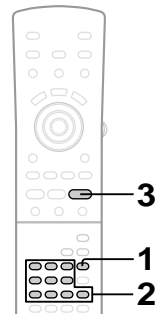

### Entering the time of the desired location

#### 1 Press T twice.



You may have to press further depending on the disc. Press the button repeatedly until the following display appears.



#### 2 Press the number buttons to enter the time.

e.g.



Time 1:25:30

#### 3 Press PLAY.



Playback starts from the desired location.

#### Notes

- Some discs may not respond to this process.
- Some scenes may not be located precisely as you specified.
- This method for accessing specific locations is available only within the current title of the DVD video disc or within the current track of the VIDEO CD/audio CD.

# Playing Repeatedly

You can play a specific title, chapter, track, or segment repeatedly.

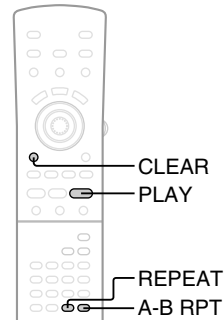
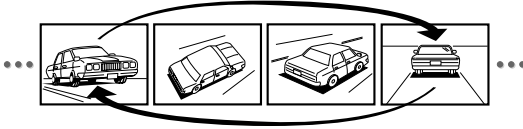

## Repeating a title, chapter, or track

### 1 Press REPEAT.



Each time you press the REPEAT button, the repeat mode changes as follows.

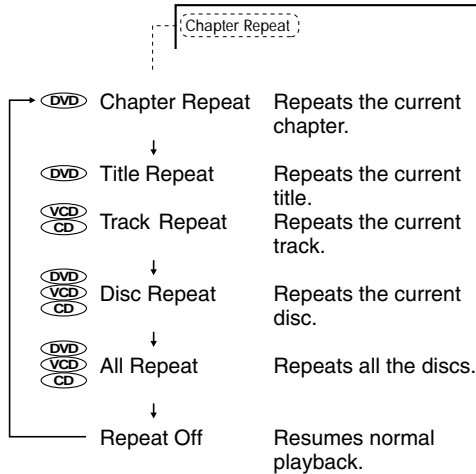

### 2 Press PLAY.



The DVD video player starts repeat playback. Press the PLAY button within about 5 seconds after you press the REPEAT button.

#### ■ To resume normal playback

Press CLEAR.



#### Notes

- Some discs may not permit repeat operation.
- When using a DVD video disc, "All Repeat" may be canceled when the DVD video player switches the discs.



## Repeating a specific segment

### 1 Press A-B RPT at the beginning of the segment (point A) you want to play repeatedly.

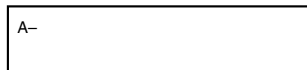

### 2 Press A-B RPT again at the end of the segment (point B).



The DVD video player automatically returns to point A and starts repeat playback of the selected segment (A-B).

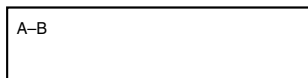

#### ■ To resume normal playback

Press CLEAR.



#### Notes

- Some discs may not permit A-B repeat operation.
- You cannot set the A-B repeat function for a segment that includes multiple camera angles (40).
- You can specify a segment only within the current title or track.
- There may be a slight difference between point A and the location where playback actually resumes depending on the disc.



# Playing in a Favorite Order

You can combine your favorite titles, chapters, or tracks and play them in the order you determine. You can program up to 30 selections into the memory. (Memory playback)

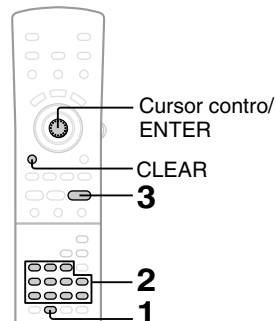

## DVD VCD CD Setting titles, chapters, or tracks in a favorite order

### 1 Insert a disc and press MEMORY during stop.



The following display appears.

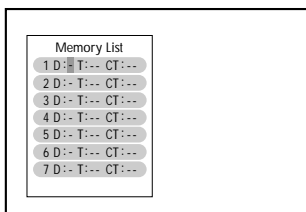

D: Disc number  
T: Title number  
CT: Chapter number or track number

### 2 Select the items in the order you want by pressing the number buttons, then ENTER for each item.

Each time you move the cursor control (◀/▶), the spaces of "D", "T" and "CT" are highlighted in turn. Highlight where you want to enter, then press the corresponding number buttons.

To select tracks from a VIDEO CD/audio CD in order, press the **number buttons** for the track, then press the **ENTER** button for each selection you want.

To select another title, chapter or track in the same disc, you do not need to select the disc number.

To select another chapter in the same title, you do not need to select the title number.

### 3 Press PLAY while the "Memory List" display appears on the TV screen.



The DVD video player starts memory playback.

#### ■ To change the programmed selections

- 1 While the "Memory List" display appears on the TV screen, move the cursor control (▲/▼) to highlight the item you want to change.
- 2 Change the selection following the instructions in step 2.

#### ■ To cancel the programmed selections

- 1 While the "Memory List" display appears on the TV screen, move the cursor control (▲/▼) to highlight the item you want to cancel.
- 2 Press **CLEAR**.

#### ■ To resume normal playback from memory playback

Press **CLEAR**.



The memory playback indicator disappears.

#### ■ To program during playback

If you press the **MEMORY** button during playback, a programming display appears. Follow steps 2 and 3.

#### Notes

- Some discs may not permit memory playback operation.
- If you press the REPEAT button during memory playback, the DVD video player repeats the current memory playback.
- If you press the MEMORY or RETURN button while the "Memory List" display appears on the TV screen, the "Memory List" display disappears.
- The programmed selections will be cleared when you turn off the DVD video player.
- When using a DVD video disc, the memory playback may be canceled when the DVD video player switches discs.

# Playing in Random Order

You can play titles, chapters within a title, or tracks in random order. (Random playback)

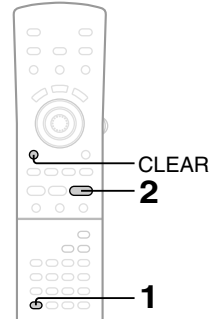
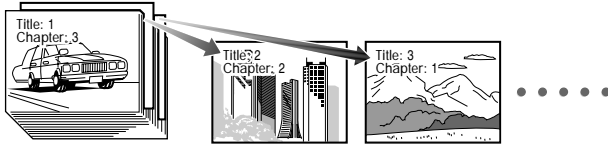

## Playing titles, chapters or tracks in random order

### 1 Press RANDOM.



Each time you press the RANDOM button, the random playback mode changes as follows.

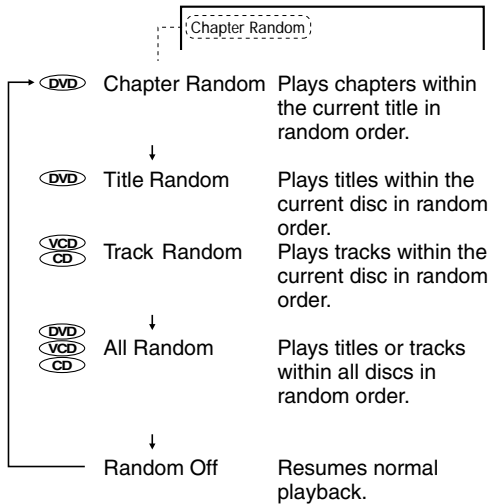

If you press the RANDOM button during playback, the DVD video player automatically starts random playback after finishing the current title, chapter or track.

### 2 Press PLAY.



The DVD video player starts random playback. Press the PLAY button within about 5 seconds after you press the RANDOM button.

### ■ To resume normal playback

Press CLEAR.



### Notes

- Some discs may not permit random playback operation.
- You cannot use the random playback function in conjunction with the memory playback function.

# Zooming a Picture

You can magnify areas within a picture.

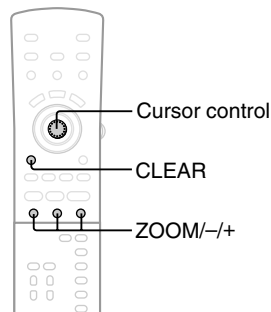
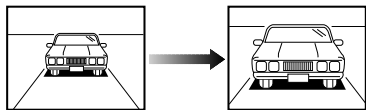

## DVD Zooming a picture

### 1 Press ZOOM during normal, slow or still playback.

**ZOOM** Zoom playback starts.



### 2 Select the zoom point and magnification level.

**+** To increase the magnification level.

**-** To reduce the magnification level.

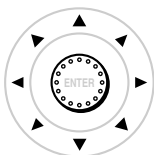

As you move the cursor control, the zoom point shifts.

**CLEAR** Pressing the CLEAR button restores the zoom point to the center of the picture.



### ■ To resume normal playback

Press **ZOOM** repeatedly so that "Zoom Off" appears.



#### Notes

- Some discs may not respond to zoom feature.
- During some scenes, the buttons may not work as described.
- Zooming does not work on subtitles or menus included on DVD video discs.
- During zoom playback, the cursor control cannot work on menus included on DVD video discs. If you want to view the menus, cancel the zoom playback.
- The magnification level varies depending on the picture size you select. **56**

## Selecting DNR Picture Enhancement

You can view a picture with less video noise.

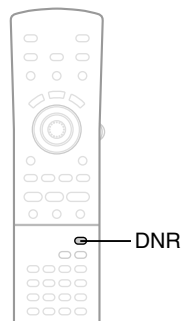

### DVD VCD Selecting DNR picture enhancement

#### Press DNR during playback.



The current setting is displayed.

Each time you press the DNR button, the setting changes as follows.

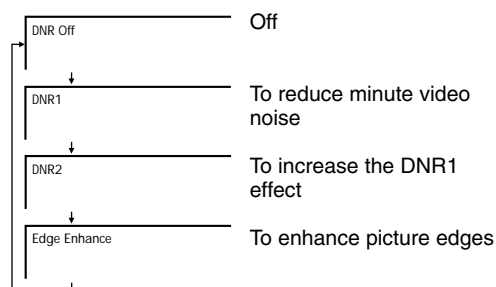

DNR: Digital Noise Reduction

#### Notes

- Actual picture enhancement may vary depending on the quality of the disc.
- While the DNR2 level can provide additional improvement in the reduction of noise in the video signal, it may produce undesirable picture artifacts on some discs. Should this occur, select a more appropriate DNR level (DNR1 or off).
- Depending on the disc, some kinds of picture details may be lost by the picture enhancement.

## Selecting 3-D (N-2-2) Sound Enhancement

You can enjoy expansive virtual surround sound effects from just two speakers.

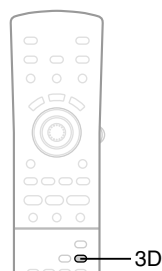

### DVD VCD CD Selecting 3-D (N-2-2) sound enhancement

#### Press 3D during playback.



The current setting is displayed.

Each time you press the 3D button, the setting changes as follows.

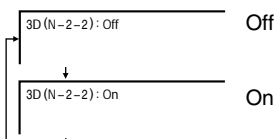

#### Notes

- You may sense a difference in volume between normal and 3-D (N-2-2) enhanced sound.
- 3-D (N-2-2) sound enhancement may not function (or may not be realized) depending on the sound output setting or disc recording system [43](#).
- If 3-D (N-2-2) sound enhancement is on, Dolby Pro Logic Surround may not function on output sounds at all, or may function differently than usual.

Spatializer® 3-Dimensional Sound Processing provided by Desper Products, Inc.  
Certain audio features of this product manufactured under a license from Desper Products, Inc., Spatializer® and the circle-in-square device are trademarks owned by Desper Products, Inc.

# Selecting the Camera Angle

If the scene was recorded from multiple angles, you can easily change the camera angle of the scene you are watching.

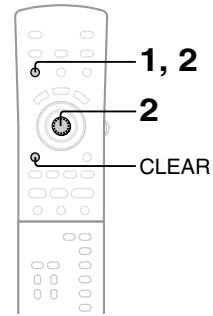
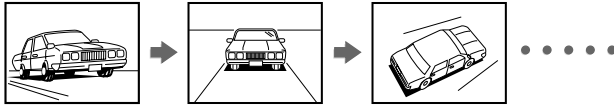

## DVD Changing the camera angle

### 1 Press ANGLE while playing a scene recorded with multiple angles.



While playing a scene recorded with multiple angles, the angle icon (📷) appears in the DVD display and on the TV screen. Press the ANGLE button while the angle icon is displayed.

e.g.

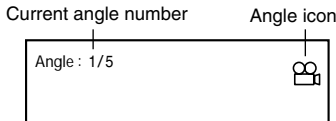

### ■ To turn off the angle number display

Press CLEAR.



### ■ To disable the angle icon display on the TV

From the on-screen displays, set "On-Screen Displays" to "Off." (60) Monitor the DVD display when you want to change the camera angle.

### Notes

- You can change the camera angle during still playback. The camera angle changes to the new setting when you resume normal playback.
- If you pause a picture immediately after changing a camera angle, the resumed playback picture may not display the new camera angle.

### 2 Press ANGLE or move the cursor control (▲) while the angle number is displayed on the TV screen.



Each time you press the ANGLE button or move the cursor control (▲), the camera angle changes.

e.g.

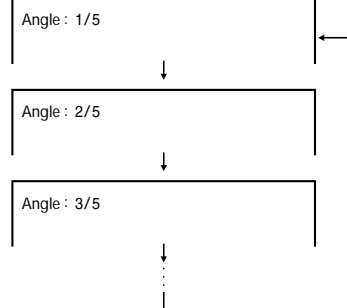
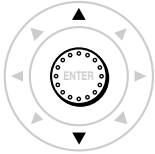

▼ : Cycles backwards

You can change the camera angle directly by pressing the number buttons corresponding to its angle number instead of moving the cursor control (▲ / ▼).

# Selecting Subtitles

You can display subtitles on the TV screen and select a subtitle language from those included on the DVD video disc.

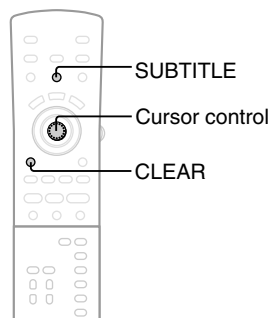
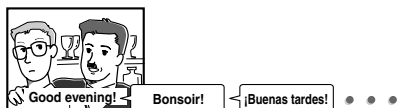

## DVD Selecting a subtitle language

### 1 Press SUBTITLE during playback.

SUBTITLE



The current subtitle setting is displayed for about 3 seconds.

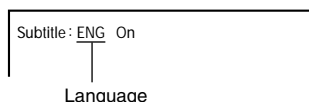

The abbreviation of the language appears instead of the language name. Refer to the list of languages and their abbreviations. **64**

### 2 Press SUBTITLE or move the cursor control (▲) while the subtitle setting is displayed on the TV screen.

SUBTITLE



Each time you press the SUBTITLE button or move the cursor control (▲), the subtitle languages included on the DVD video disc change.

e.g.

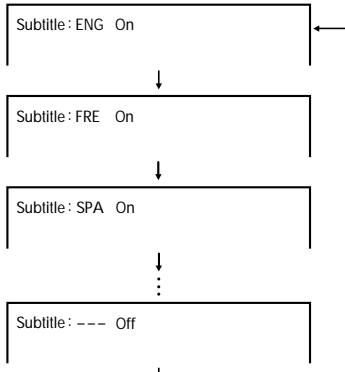
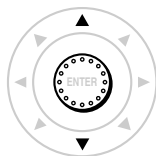

▼ : Cycles backwards

To turn off the subtitle setting display, press the CLEAR button.

### ■ To turn subtitles on or off

1 Press SUBTITLE during playback.

SUBTITLE



2 Move the cursor control (◀/▶) while the subtitle setting is displayed on the TV screen, to select "On" or "Off."

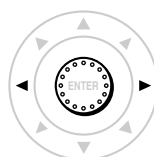

Displayed for about 3 seconds.

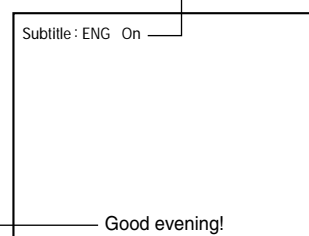

Subtitles — Good evening!

Subtitles are not displayed.

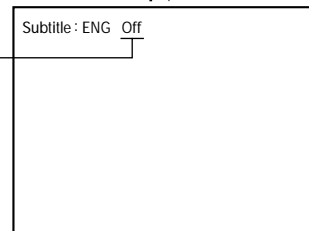

### Notes

- Some DVD video discs are set to display subtitles automatically, and you cannot turn them off even if you set the subtitle function to off.
- During some scenes, the subtitles may not appear immediately after you select "On."
- Some DVD video discs will allow you to make subtitle selections and turn subtitles on or off only via the disc menu.

### Notes

- When you turn on the DVD video player or replace a disc, the player returns to the initial default setting **59**. When you select a subtitle language which is not included on the disc, the DVD video player plays a prior language programmed on the disc.
- During some scenes, the subtitles may not appear immediately after you change the subtitle language by moving the cursor control (▲/▼).

## Selecting a Language

You can select a preferred language and sound recording system from those included on the DVD video disc.

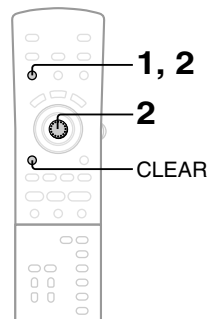
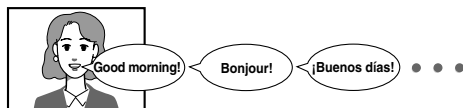

### DVD Selecting a playback audio setting

#### 1 Press AUDIO during playback.



The current audio setting is displayed for about 3 seconds.

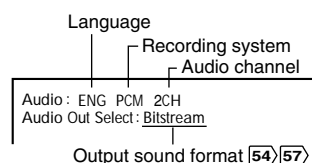

The abbreviation of the language appears instead of the language name. Refer to the list of languages and their abbreviations. [64]

#### 2 Press AUDIO or move the cursor control (▲) while the audio setting is displayed on the TV screen.



Each time you press the AUDIO button or move the cursor control (▲), the audio settings included on the DVD video disc change.

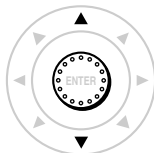

e.g. 

Audio: ENG	PCM	2CH
Audio: FRE	D	2CH
Audio: SPA	PCM	2CH

▼ : Cycles backwards

If you move the cursor control (◀/▶), you can select output sound format. [57]

To turn off the audio setting display, press the CLEAR button.

#### ■ Selecting sound channels of VIDEO CDs

You can switch left and right channels by pressing the **AUDIO** button repeatedly during playback.



#### Notes

- When you turn on the DVD video player or replace a disc, player returns to the initial default setting [59]. If you select a sound track which is not included on the disc, the DVD video player plays a prior sound track programmed on the disc.
- Some discs allow you to change audio selections only via the disc menu. If this is the case, press the MENU button and choose the appropriate language from the selections on the disc menu.

### ■ Output sound conversion table (sampling frequency/quantization bit)

Discs	Sound recording system	Audio selection from the menu <b>54</b> <b>57</b> and output jacks on the rear panel								
		Bitstream		Analog 6ch		Analog 2ch		PCM		
		BITSTREAM/PCM jack	2CH AUDIO OUT jacks	BITSTREAM/PCM jack	5.1CH SURROUND AUDIO OUT jacks	BITSTREAM/PCM jack	2CH AUDIO OUT jacks	BITSTREAM/PCM jack	2CH AUDIO OUT jacks	
DVD video discs	Dolby Digital	Bitstream	48 kHz/20 bit	—	48 kHz/20 bit	Bitstream	48 kHz/20 bit	48 kHz/16 bit	48 kHz/20 bit	
	Linear PCM	48 kHz/16 bit	48 kHz/16 bit	48 kHz/16 bit	48 kHz/16 bit	48 kHz/16 bit	48 kHz/16 bit	48 kHz/16 bit	48 kHz/16 bit	48 kHz/16 bit
		48 kHz/20 bit	48 kHz/16 bit	48 kHz/20 bit	48 kHz/16 bit	48 kHz/20 bit	48 kHz/16 bit	48 kHz/20 bit	48 kHz/16 bit	48 kHz/20 bit
		48 kHz/24 bit	48 kHz/16 bit	48 kHz/24 bit	48 kHz/16 bit	48 kHz/20 bit	48 kHz/16 bit	48 kHz/24 bit	48 kHz/16 bit	48 kHz/24 bit
		96 kHz/16 bit	48 kHz/16 bit	48 kHz/16 bit	48 kHz/16 bit	48 kHz/16 bit	—	96 kHz/16 bit	48 kHz/16 bit	48 kHz/16 bit
		96 kHz/20 bit	48 kHz/16 bit	48 kHz/20 bit	48 kHz/16 bit	48 kHz/20 bit	—	96 kHz/20 bit	48 kHz/16 bit	48 kHz/20 bit
	96 kHz/24 bit	48 kHz/16 bit	48 kHz/24 bit	48 kHz/16 bit	48 kHz/20 bit	—	96 kHz/24 bit	48 kHz/16 bit	48 kHz/24 bit	
DTS	Bitstream	—	—	48 kHz/20 bit	48 kHz/16 bit	48 kHz/20 bit	48 kHz/16 bit	48 kHz/20 bit		
MPEG2	Bitstream	48 kHz/16 bit	—	48 kHz/16 bit	Bitstream	48 kHz/16 bit	48 kHz/16 bit	48 kHz/16 bit		
VIDEO CDs	MPEG1	44.1 kHz/16 bit	44.1 kHz/16 bit	—	44.1 kHz/16 bit	44.1 kHz/16 bit	44.1 kHz/16 bit	44.1 kHz/16 bit	44.1 kHz/16 bit	
Audio CDs	Linear PCM 44.1 kHz/16 bit	44.1 kHz/16 bit	44.1 kHz/16 bit	44.1 kHz/16 bit	44.1 kHz/16 bit	44.1 kHz/16 bit	44.1 kHz/16 bit	44.1 kHz/16 bit	44.1 kHz/16 bit	
	HDCD	44.1 kHz/16 bit	44.1 kHz/20 bit	44.1 kHz/16 bit	44.1 kHz/16 bit	44.1 kHz/16 bit	44.1 kHz/20 bit	44.1 kHz/16 bit	44.1 kHz/20 bit	
	DTS	Bitstream	—	—	44.1 kHz/20 bit	44.1 kHz/16 bit	44.1 kHz/20 bit	44.1 kHz/16 bit	44.1 kHz/20 bit	

 : 3-D (N-2-2) sound enhancement can function.

- HDCD sound via the 2CH AUDIO OUT jacks and the 5.1CH SURROUND AUDIO OUT jacks is output in a normal audio CD format when 3-D (N-2-2) sound enhancement is on or when "Analog 6ch" is selected.



# Quick control

Simple use of a single button and the cursor control enables you to direct your playback, without manipulating many actual buttons.

- **Using the Graphic Remote Control - V-REMOTE -**
- **Selecting the Playback Function - QUICK -**
- **Accessing Features - NAVI -**

# Using the Graphic Remote Control

## - V-REMOTE -

Pressing one button can display a graphics based on-screen remote control that allows you to control playback as if you were doing it from the actual remote control.

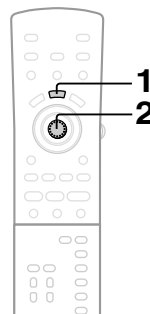

### DVD VCD CD Using the graphic remote control

#### 1 During playback, press V-REMOTE.



The graphic remote control (Virtual Remote) appears.



Speed control  
Proceed to 2-A.

Stream selection  
Proceed to 2-B.

#### 2 Proceed to A or B.

**A:** Move the cursor control to select the speed control, and press **ENTER**.

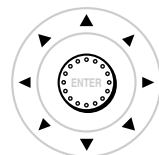

- ⏸ : Pause [27] / Frame by frame [28]
- ▶ : Normal playback [26]
- ⏪ : Slow [29]
- ⏩ : Forward skip [31]
- ⏭ : Fast forward [28]
- ⏮ : Reverse slow [29]
- ⏪ : Reverse skip [31]
- ⏮ : Fast reverse [28]
- Navi : Accesses the Navi menu [48]

**B:** Move the cursor control (▲ / ▼) to select "Audio," "Subtitle," or "Angle," and press **ENTER**.

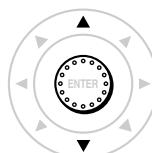

**Audio:** Move the cursor control (▲ / ▼) to select a desired audio language, and press **ENTER**.

For details, see page [42].

Selecting the output sound format is not possible here.

**Subtitle:** Move the cursor control (▲ / ▼) to select a desired subtitle language, and press **ENTER**.

For details, see page [41].

**Angle:** Move the cursor control (▲ / ▼) to select a desired camera angle, and press **ENTER**.

For details, see page [40].

#### ■ To turn off the Virtual Remote

Press **V-REMOTE**.



#### Note

Some discs may not permit this operation.

# Selecting the Playback Function - QUICK -

Pressing one button can display a list of playback functions which are relevant to your current playback mode. You can check and modify them from the list.

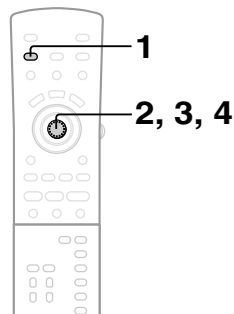

## Selecting the playback function

### 1 During playback, press QUICK.



The following on-screen display appears. (The actual display will vary depending on the playback status.)

e.g.

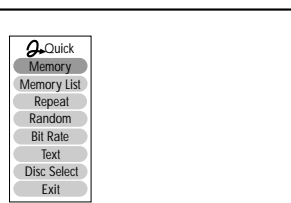

### 4 Press ENTER.



The on-screen display disappears and playback will resume according to your selection.

#### Quick menu

For details, see the respective pages.

- Memory : To program memory playback. [36](#)
- Memory List : To list memory settings. [36](#)
- Repeat : To select the repeat playback mode. [35](#)
- Random : To select the random playback mode. [37](#)
- Bitrate : To activate/disable the bitrate display. [48](#)
- Text : To activate/disable the Text display. [48](#)
- Text display: Displays DVD-Text data or CD-Text data if included on the disc. (Some content on the disc may not be displayed properly depending on the disc.)
- Disc Select : To change disc selection for playback.
- Exit : To quit the on-screen display.

#### Note

Pressing the QUICK button again also exits the on-screen display.

### 2 Move the cursor control (▲ / ▼) to select a desired item, and press ENTER.

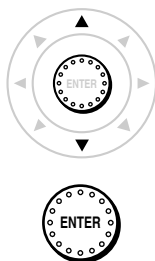

e.g. To change the repeat mode:

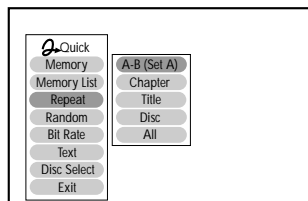

### 3 Move the cursor control (▲ / ▼) to change the setting.

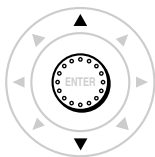

e.g. To select the chapter repeat mode:

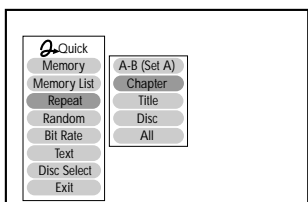

# Accessing Features - NAVI -

The NAVI menu provides an icon based display from which you can easily access key playback function.

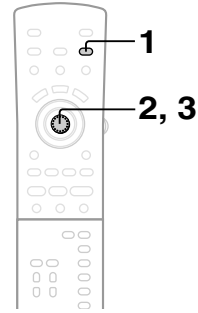

**DVD**  
**VCD**  
**CD**

## NAVI menu items

### 1 Press NAVI.



The NAVI menu appears.

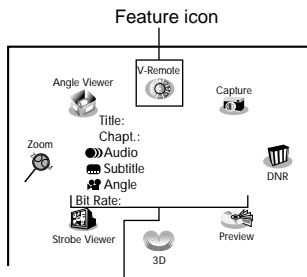

Each time you press the NAVI button, the display changes.

- Title/Chapt.: Elapsed time and remaining time of the current title/chapter.
- Audio: Current audio setting
- Subtitle: Current subtitle setting
- Angle: Current angle setting
- Bit Rate: Data transfer rate (Mbit/s)  
Amount of picture, sound and subtitle data in the DVD video disc transferred per second.  
The larger the value, the more data processed, but this does not necessarily insure better picture quality.
- Status display (playback mode, current DNR setting, current zoom status, etc.)

### 2 Move the cursor control to select a desired feature icon.

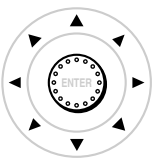

For details on each feature, refer to the list on the next page.

### 3 Press ENTER.



Selection details appears.

### 4 Refer to the list on the next page and follow the instructions detailed on subsequent pages.

**Notes**

- The NAVI menu will disappear by pressing the NAVI button several times.
- The number of feature icons on the display will vary depending on the disc.

## Navi menu selections

### V-Remote



You can control key playback functions using the graphics based on-screen remote control.

46

### Angle Viewer



You can display all camera angles simultaneously and select your preferred one from them.

50

### Zoom



You can magnify areas within a picture.

38



### Strobe Viewer

You can divide a desired scene into stop action frames for careful analysis.

50



### 3D

You can enjoy expansive virtual surround sound effects from just two speakers.

51



### Preview

You can display thumbnail views of the first scenes of titles or chapters and select a preferred one.

51



### DNR

You can view a picture with less video noise.

52

### Capture



You can sample a scene from a playback picture and transform it into a background picture.

52

# Accessing Features - NAVI - (continued)

## NAVI menu items

### Angle Viewer



You can display all camera angles simultaneously and select your preferred one from them.

After selecting this icon and pressing ENTER, the following on-screen display appears:

e.g.

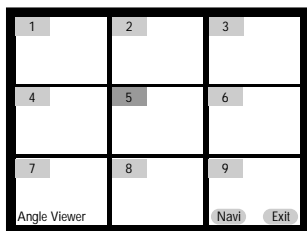

When the scene contains 9 camera angles:

- 1 Move the cursor control to select.

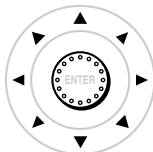

1-9 : To select the camera angle.  
 Navi: To return to the NAVI menu.  
 Exit : To quit the on-screen display.

- 2 Press ENTER.



**Note**

Some discs or scenes may not permit this operation.



You can divide a desired scene into stop action frames for careful analysis.

### Strobe Viewer

After selecting this icon and pressing ENTER, the following on-screen display appears:

e.g.

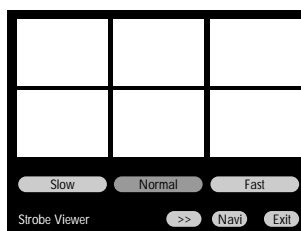

- 1 Move the cursor control to select.

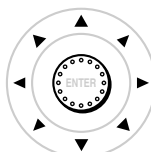

Slow: Still pictures at shorter intervals.  
 Normal: Still pictures at normal intervals.  
 Fast: Still pictures at longer intervals.  
 >>: To view the next series of 6 pictures.  
 Navi: To return to the NAVI menu.  
 Exit : To quit the on-screen display.

- 2 Press ENTER.



**Note**

Some discs or scenes may not permit this operation.



## 3D

You can enjoy expansive virtual surround effects from just two speakers.

After selecting this icon and pressing ENTER, the following on-screen display appears:

e.g.

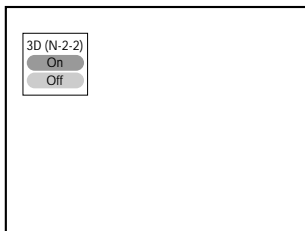

- 1 Move the cursor control to select.

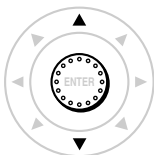

On: This function works.

Off: This function does not work.

- 2 Press ENTER.



### Note

For details and notes on 3-D (N-2-2), see page [39](#).



## Preview

You can display thumbnail views of the first scenes of titles or chapters and select a preferred one.

After selecting this icon and pressing ENTER, the following on-screen display appears:

e.g.

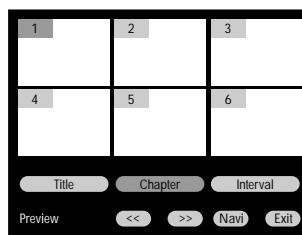

- 1 Move the cursor control to select.

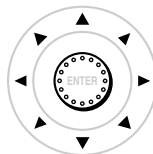

1 - 6: To locate the scene.

Title: To display the first scenes of titles (1 to 6).

Chapter: To display the first scenes of chapters (1 to 6).

Interval: To display scenes at intervals of about 10 minutes apart.

<< : To go to the previous page.

>> : To go to the next page.

Navi: To return to the NAVI menu.

Exit : To quit the on-screen display.

- 2 Press ENTER.



### Notes

- Some discs or scenes may not permit this operation.
- Some items may not be selected depending on the disc or scene.
- Some of the first scenes may not be picked up depending on the disc.

# Accessing Features - NAVI - (continued)

## NAVI menu items



### DNR

You can view a picture with less video noise.

After selecting this icon and pressing ENTER, the following on-screen display appears:

e.g.

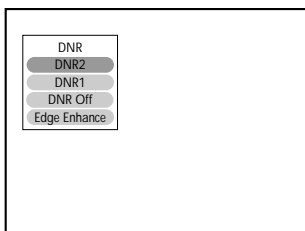

- 1 Move the cursor control to select.

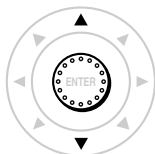

DNR2: To increase the DNR1 effect.  
 DNR1: To reduce minute video noise.  
 DNR Off: Off.  
 Edge Enhance : To sharpen picture edges.

- 2 Press **ENTER**.



#### Note

For details and notes on the DNR picture enhancement, see page [39](#).

### Capture



You can sample a scene from a playback picture and transform it into a background picture.

After selecting this icon and pressing ENTER, the following on-screen display appears:

e.g.

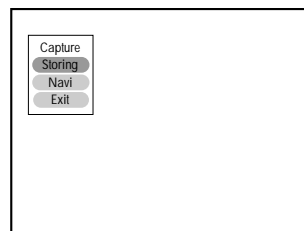

- 1 Pause playback at a scene you want to capture.
- 2 Move the cursor control to select.

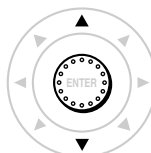

Storing: To sample and store the current picture in the player memory.  
 Navi: To return to the NAVI menu.  
 Exit : To quit the on-screen display.

- 3 Press **ENTER**.



The stored picture will be displayed as a background picture when the player is in the stop mode. It is necessary to confirm this process via the setup menu [61](#).

#### Notes

- You can store only one picture. Storing a new picture will erase the old one.
- No operations are permitted in process of sampling and storage of background picture.



# Function Setup

You can change the default settings to customize performance to your preference.

- **Customizing the Function Settings**
- **Table of Languages**
- **Operating a TV with the remote control**

# Customizing the Function Settings

You can change the default settings to customize performance to your preference.

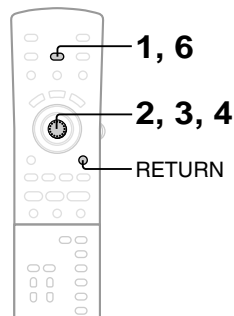

**DVD**  
**VCD**  
**CD**

## Setting procedure

**1** Press **SETUP** during stop.  
The following on-screen display appears.

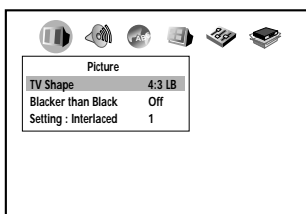

**2** Move the cursor control (◀/▶) to select a symbol for the setting you want to change.

(See the next page.)

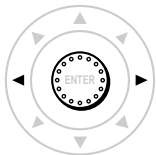

Picture performance settings



Output sound settings



Language settings



Display settings



Operational settings



Initial settings

**3** Move the cursor control (▲/▼) to select the setting you want to change, then press **ENTER**.

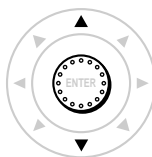

**4** Change the selection by the cursor control (▲/▼) or other buttons, by referring to the corresponding pages [56], then press **ENTER**.

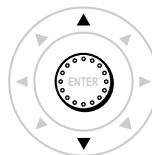

**5** Repeat steps 3 and 4 to change other settings.

To select another operation, go back to step 2.

**6** Press **SETUP**.  
The on-screen display disappears.











































■ To return to the previous display  
Press **RETURN**.



**Notes**

- The on-screen display disappears when you press the SETUP button.
- The SETUP button can function even during normal playback, however some operations may be inaccessible, and a message will appear. In this case, try again after playback is stopped.

Setting		Details	Page	
	TV Shape		To select a picture size according to the aspect ratio of your TV.	56
	Blacker than Black	 	To make an adjustment of the black level on your TV using a commercially available test disc that contains adjustment signals.	56
	Setting: Interlaced	 	To adjust the picture quality.	56
	Audio Out Select	  	To select an output sound format corresponding to your system connection.	57
	Dynamic Range Control		To turn on or off a function that makes faint sounds easier to hear even if you lower the volume during late hours playback.	58
	Karaoke Vocal		To turn on or off the vocal output during DVD KARAOKE disc playback.	58
	CD Attenuation		To attenuate sound distortion incurred during playback of an audio CD.	58
	On-Screen Language	  	To select a preferred language for on-screen displays.	59
	Disc Menu Language		To select a preferred language for disc menus.	59
	Audio Language		To select a preferred language for the sound track.	59
	Subtitle Language		To select a preferred language for subtitles.	59
	On-Screen Displays	  	To turn on or de-activate the operational status display on the TV screen.	60
	Background	  	To select the background color or background picture.	60
	Screen Saver		To turn the screen saver on or off.	60
	Pause/Still		To select the resolution of still pictures. (Field/Frame)	61
	Parental Lock		To turn the parental lock function on or off.	61
	Remote Confirmation	  	To turn on or off the confirmation beeper announcing when each remote command received.	62
	Title Stop		To turn on or off a feature that automatically stops playback after a title has been viewed.	62
	PBC		To use the menu screen when playing a PBC-controllable VIDEO CD.	62
	On-screen Language TV Shape Audio Out Select	  	To install the initial system setting.	63

# Customizing the Function Settings (continued)

## Setting details

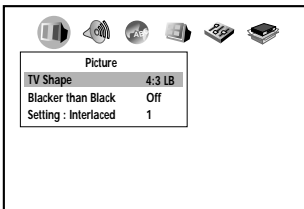

### TV Shape DVD

**4:3 Letterbox:** Select when a standard 4:3 TV is connected. Displays theatrical images with masking bars above and below the picture.



**4:3 Normal:** Select when a standard 4:3 TV is connected. Displays pictures cropped to fill your TV screen. Either or both sides of the picture are cut off.



**16:9 Widescreen:** Select when a 16:9 wide TV is connected.

#### Notes

- The displayable picture size is preset on the DVD video disc. Therefore, the playback picture of some DVD video discs may not conform to the picture size you select.
- When you play DVD video discs recorded in the 4:3 picture size only, the playback picture always appears in the 4:3 picture size regardless of the TV shape setting.
- If you select "16:9 Widescreen" and you own a 4:3 TV set, the DVD playback picture will be horizontally distorted during playback. Images will appear to be horizontally compressed. Always be sure that your TV shape conforms to the actual TV in use.

### Blacker than Black DVD VCD

- Off: For normal use.
- On: Select when you adjust the black level of your TV using a commercially available test disc that contains adjustment signals.

### Setting : Interlaced DVD VCD

You can fine adjust picture quality and store up to 3 custom picture settings in the memory of the DVD video player.

To select a preset memory setting:

- 1) Move the cursor control (▲ / ▼) to select a memory number (1 to 3), and press the ENTER button.

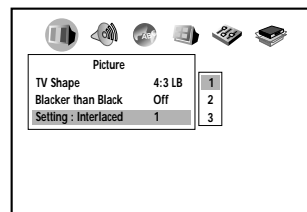

- 2) Move the cursor control (▲ / ▼) to select the element, and press the ENTER button.

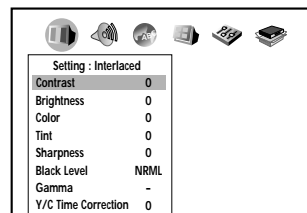

- 3) Move the cursor control (◀ / ▶) to adjust the value, and press the ENTER button.

(-7) Lower	Contrast	Higher (+7)
(-7) Darker	Brightness	Brighter (+7)
(-7) Duller	Color	Brighter (+7)
(-7) Redder	Tint	Greener (+7)
(-7) Softer	Sharpness	Sharper (+7)
Normal	Black Level	Enhanced
(-)	Gamma*1	(+)
(-3)	Y/C Time Correction*2	(+3)

\*1: Adjust when playback pictures are too dark or too whitish.

\*2: Adjust horizontal color deviations. Pictures may shift horizontally during the adjustment.

#### Notes

- These adjustments are not available when connecting to a PROGRESSIVE TV.
- The Tint adjustment is not available when connecting to a TV via the component video jacks (Y, P<sub>B</sub>, P<sub>R</sub>).

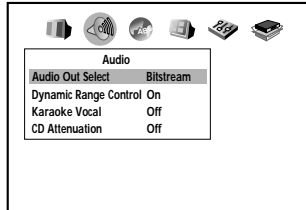

### Audio Out Select DVD VCD CD

Select the output sound format corresponding to your system connection.

For details of sound recording systems, see [43](#).

**Bitstream:** Select when connected to an amplifier equipped with a Dolby Digital, DTS, MPEG1 or MPEG2 decoder. [21](#) [22](#)  
The DVD video player outputs digital audio information in the bitstream format when you play a DVD video disc recorded on the Dolby Digital, DTS, MPEG1 or MPEG2 recording system.

**Analog 6ch:** Select when connected to an AV amplifier equipped with 5.1ch audio inputs. [23](#)  
This DVD video player is equipped with a Dolby Digital and MPEG decoder. The next screen will detail the appropriate settings.

**Analog 2ch:** Select when connected to a TV, or Dolby Pro Logic or stereo system via the analog audio jacks. [18](#) [19](#) [21](#)

**PCM:** Select when connected to a 2 channel digital stereo amplifier. [23](#)  
The DVD video player outputs sounds in the PCM 2ch format when you play a DVD video disc recorded on the Dolby Digital, MPEG1 or MPEG2 recording system.

### When you select "Analog 6ch":

Make the following settings for the built-in 5.1ch surround decoder.

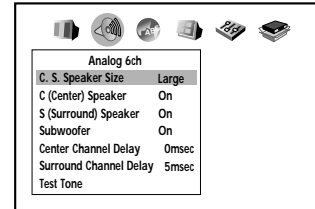

- 1) Select an item by moving the cursor control (**▲** / **▼**), and press the ENTER button.
- 2) Make the settings (see below) by moving the cursor control (**▲** / **▼** / **◀** / **▶**), and press the ENTER button.

#### C.S. Speaker Size

**Small:** When the center speaker or surround speakers cannot reproduce low frequency signals below 120 Hz.

**Large:** When the center speaker and surround speakers can reproduce low frequency signals below 120 Hz.

#### C(Center) Speaker

**Off:** When center speaker is not connected.

**On:** When you connect center speaker.

#### S(Surround) Speaker

**Off:** When surround speakers are not connected.

**On:** When you connect surround speakers.

#### Subwoofer

**Off:** When a sub woofer is not connected.

**On:** When you connect a sub woofer.

(Continued)

# Customizing the Function Settings (continued)

## Setting details

(Continued)

### Adjusting the delay time:

When enjoying 5.1ch surround playback, it is ideal to choose a listening position that is the same distance from each speaker. By adjusting the delay time of the center/surround speakers, you can virtually create an ideal listening environment (as if the center/surround speakers were at their ideal locations respectively as below.)

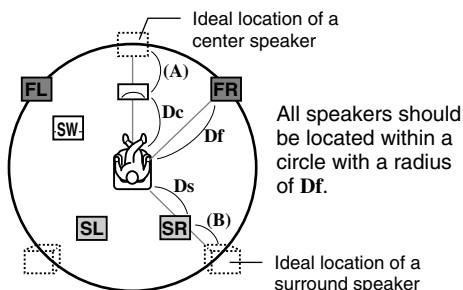

### Center Channel Delay

0msec: When  $Df$  equals  $Dc$ .  
 1msec: When (A) is approx. 34 cm (13 inch)  
 2msec: When (A) is approx. 68 cm (27 inch)  
 3msec: When (A) is approx. 102 cm (40 inch) . . .  
 $*(A) = Df - Dc$   
 Get your optimum value (0, 1, 2 . . . 5) dividing (A) by 34.

### Surround Channel Delay

0msec: When  $Df$  equals  $Ds$ .  
 1msec: When (B) is approx. 34 cm (13 inch)  
 2msec: When (B) is approx. 68 cm (27 inch)  
 3msec: When (B) is approx. 102 cm (40 inch) . . .  
 $*(B) = Df - Ds$   
 Get your optimum value (0, 1, 2 . . . 15) dividing (B) by 34.

- 3) Select "Test Tone" and press the ENTER button.

The DVD video player outputs a test signal to each speaker when it is in stop mode. When playing a DVD video disc, it substitutes the current sound for the test signal.

Move the cursor control (◀/▶) to select the receiving speakers, and adjust the volume of each speaker at the same level by moving the cursor control (▲/▼).

If all the volume levels cannot be equalized, adjust them on the amplifier.

### Note

Depending on the disc, 6 channel sounds may not be output via the 5.1 CH SURROUND AUDIO OUT jacks.

### Dynamic Range Control (DVD)

Off: Full dynamic range is maintained.  
 On: Dynamic range is reduced.

### Notes

- This function works only during playback of Dolby Digital recorded discs.
- The level of Dynamic Range Reduction may differ depending on the DVD video disc.

### Karaoke Vocal (DVD)

Off: The primary vocal is not output.  
 On: The primary vocal is output when it is recorded on the disc.

### Notes

- The vocal output feature is used during playback of Dolby Digital (multi-channel) recorded DVD KARAOKE discs. This feature allows you to turn off vocal audio tracks, or restore them for background accompaniment.
- When playing KARAOKE, connect appropriate audio equipment such as an amplifier to the DVD video player.

### CD Attenuation (CD)

HDCC enhances the output sound level of audio CD by approximately 6 dB. As such, distortion may occur in some connected products that are unable to compensate for a wide range of input signal levels. (e.g. TV, stereo receivers)

Off: For normal use.  
 On: Select when an audio CD sound is distorted. Sound volume of an audio CD is lessened.

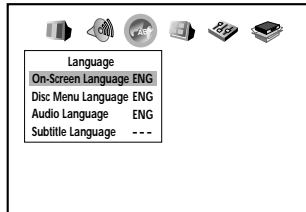

### On-Screen Language (DVD VCD CD)

English: To view on-screen displays in English.  
 Français: To view on-screen displays in French.  
 Español: To view on-screen displays in Spanish.

### Disc Menu Language (DVD)

English: To display disc menus in English.  
 French: To display disc menus in French.  
 Spanish: To display disc menus in Spanish.  
 Others: To make a further choice.  
 After pressing the ENTER button, follow steps 1) - 4) below.

- 1) Obtain the abbreviation of the preferred language from the list **[64]**.
- 2) Select the first character by moving the cursor control (**▲ / ▼**).
- 3) Move the cursor control (**◀ / ▶**) to shift and select the second character by moving the cursor control (**▲ / ▼**).

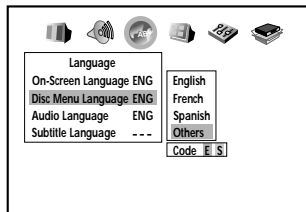

- 4) Press the ENTER button.

#### Note

Some DVD video discs may not include your pre-selected language. In this case, the DVD video player automatically displays disc menus consistent with the disc's initial language setting.

### Audio Language (DVD)

English: To play sound tracks in English.  
 French: To play sound tracks in French.  
 Spanish: To play sound tracks in Spanish.  
 Others: To make a further choice.  
 After pressing the ENTER button, follow steps 1) - 4) below.

- 1) Obtain the abbreviation of the preferred language from the list **[64]**.
- 2) Select the first character by moving the cursor control (**▲ / ▼**).
- 3) Move the cursor control (**◀ / ▶**) to shift and select the second character by moving the cursor control (**▲ / ▼**).

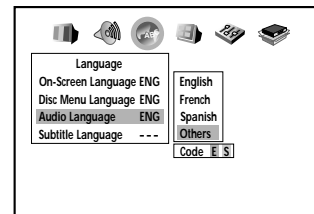

- 4) Press the ENTER button.

#### Note

Some DVD video discs may be played in a different language than you selected. A prior language may be programmed on the disc.

### Subtitle Language (DVD)

English: To display subtitles in English.  
 French: To display subtitles in French.  
 Spanish: To display subtitles in Spanish.  
 No Subtitle: To disable subtitles.  
 Others: To make a further choice.  
 After pressing the ENTER button, follow steps 1) - 4) below.

- 1) Obtain the abbreviation of the preferred language from the list **[64]**.
- 2) Select the first character by moving the cursor control (**▲ / ▼**).

(Continued)

# Customizing the Function Settings (continued)

## Setting details

(Continued)

- 3) Move the cursor control (◀/▶) to shift and select the second character by moving the cursor control (▲/▼).

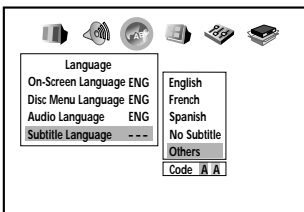

- 4) Press the ENTER button.

**Notes**

- Some DVD video discs may be set to display subtitles in a different language than you selected. A prior subtitle language may be programmed on the disc.
- Some DVD video discs allow you to change subtitle selections only via the disc menu. If this is the case, press the MENU button and choose the appropriate subtitle language from the selection on the disc menu.

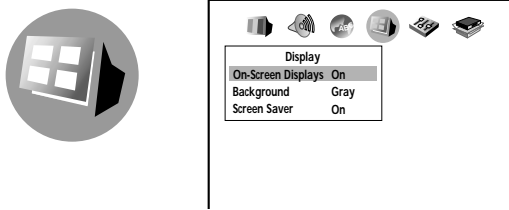

### On-Screen Displays DVD VCD CD

- Off: Operational modes (e.g. "Play", "⏮") are not displayed.
- On: Operational modes (e.g. "Play", "⏮") are displayed on-screen.

### Background DVD VCD CD

- Blue: Blue background.
- Gray: Gray background.
- Capture: To use a picture you sampled and stored in the memory using the Capture feature 52 as a background.
- Jacket: To use the jacket picture included on some discs as a background. If it is not included, a gray background will be substituted.

### Screen Saver DVD

- Off: The screen saver is disengaged.
- On: The screen saver operates.



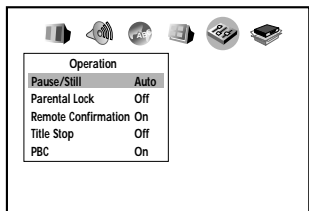

### Pause/Still (DVD)

**Auto:** For normal use. Still and fast motion images can be paused.

**Frame:** The resolution of still pictures is improved, so that you can make a motionless picture more clearer when you pause it.

### Parental Lock (DVD)

DVD video discs equipped with the parental lock function are rated according to their content. The contents allowed by a parental lock level and the way a DVD video disc can be controlled may vary from disc to disc. For example, if the disc allowed you could edit out violent scenes unsuitable for children and replace them with more suitable scenes, or lock out playback of the disc altogether.

- DVD video discs may or may not respond to the parental lock settings. This is not a defect in the DVD video player. Make sure this function works with your DVD video discs.

**Off:** The parental lock feature does not function. After pressing the ENTER button, follow step 1) below.

**On:** To activate the parental lock feature or change the settings. After pressing the ENTER button, follow steps 1) - 3) below.

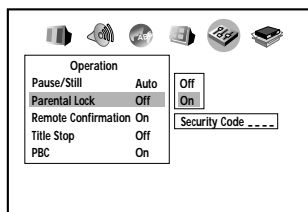

- 1) Press the number buttons to create a personal 4-digit security code, then press the ENTER button.

If you make a mistake before pressing the ENTER button, press the CLEAR button and enter your 4-digit security code again.

- 2) Enter the code of a country/area whose standards were used to rate the DVD video disc, referring to the list below.

Country/Area	Code
AUSTRALIA	AU
BELGIUM	BE
CANADA	CA
CHINA	CN
CHINA HONG KONG	HK
DENMARK	DK
FINLAND	FI
FRANCE	FR
GERMANY	DE
INDONESIA	ID
ITALY	IT
JAPAN	JP
MALAYSIA	MY
NETHERLANDS	NL
NORWAY	NO
PHILIPPINES	PH
RUSSIAN FEDERATION	RU
SINGAPORE	SG
SPAIN	ES
SWEDEN	SE
SWITZERLAND	CH
TAIWAN	TW
THAILAND	TH
UNITED KINGDOM	GB
UNITED STATES	US

- a) Select the first character by moving the cursor control (▲ / ▼).
- b) Move the cursor control (◀ / ▶) to shift and select the second character by moving the cursor control (▲ / ▼).
- c) Press the ENTER button.

(Continued)

# Customizing the Function Settings (continued)

## Setting details

(Continued)

- 3) Move the cursor control (▲ / ▼) to select the parental lock level, then press the ENTER button.

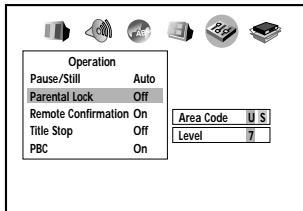

You cannot play DVD video discs rated higher than the level you selected unless you cancel the parental lock function.

For example, when you select level 7, discs rated higher than level 7 are locked out and cannot be played.

The parental lock level is equivalent to the following USA movie ratings.

- Level 7: NC-17
- Level 6: R
- Level 4: PG 13
- Level 3: PG
- Level 1: G

The parental lock levels for other countries/areas than U.S. are included for future use. Check the appropriate parental lock level when you buy a DVD video disc equipped with the parental lock feature in the future.

### ■ To change the parental lock level

Follow steps 1) - 3).

### ■ To change your 4-digit security code

- 1) After selecting "On" or "Off," press the STOP button four times, then press the ENTER button.

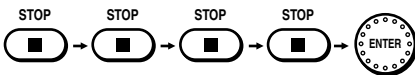

The 4-digit security code is cleared.

- 2) Press the number buttons to create a new 4-digit security code.
- 3) Press the ENTER button.

### Remote Confirmation DVD VCD CD

- Off: The beeper does not sound.
- On: The beeper sounds with each remote operation.

### Title Stop DVD

- Off: The DVD video player continues after playback of a title is completed.
- On: The DVD video player stops after playback of a title is completed.

### PBC VCD

- Off: When playing a VIDEO CD without using the menu.
- On: To use the menu when playing a PBC-featured VIDEO CD.

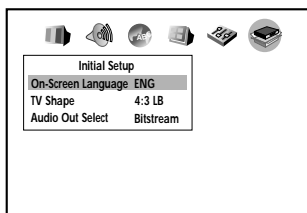
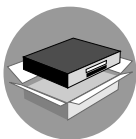

### Initial Setup DVD VCD CD

- 1) Move the cursor control (▲ / ▼) to select "On-Screen Language," and press the **ENTER** button.

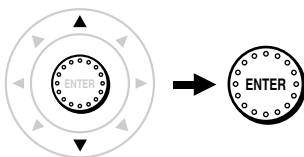

- 2) Select a language moving the cursor control (▲ / ▼), and press the **ENTER** button.

See page [59](#), "On-screen Language."

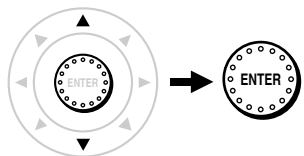

- 3) Make your selection in the same manner as step 1) then step 2).

See page [56](#), "TV Shape."

See page [57](#), "Audio Out Select."

# Table of Languages

## Table of languages and their abbreviations

Abbreviation	Language	Abbreviation	Language	Abbreviation	Language
---	No alternate language	GN	Guarani	PT	Portuguese
CHI (ZH)	Chinese	GU	Gujarati	QU	Quechua
DUT (NL)	Dutch	HA	Hausa	RM	Rhaeto-Romance
ENG (EN)	English	HI	Hindi	RN	Kirundi
FRE (FR)	French	HR	Croatian	RO	Rumanian
GER (DE)	German	HU	Hungarian	RU	Russian
ITA (IT)	Italian	HY	Armenian	RW	Kinyarwanda
JPN (JA)	Japanese	IA	Interlingua	SA	Sanskrit
KOR (KO)	Korean	IE	Interlingue	SD	Sindhi
MAY (MS)	Malay	IK	Inupiak	SG	Sango
SPA (ES)	Spanish	IN	Indonesian	SH	Serbo-Croatian
AA	Afar	IS	Icelandic	SI	Singhalese
AB	Abkhazian	IW	Hebrew	SK	Slovak
AF	Afrikaans	JI	Yiddish	SL	Slovenian
AM	Amharic	JW	Javanese	SM	Samoan
AR	Arabic	KA	Georgian	SN	Shona
AS	Assamese	KK	Kazakh	SO	Somali
AY	Aymara	KL	Greenlandic	SQ	Albanian
AZ	Azerbaijani	KM	Cambodian	SR	Serbian
BA	Bashkir	KN	Kannada	SS	Siswati
BE	Belorussian	KS	Kashmiri	ST	Sesotho
BG	Bulgarian	KU	Kurdish	SU	Sundanese
BH	Bihari	KY	Kirghiz	SV	Swedish
BI	Bislama	LA	Latin	SW	Swahili
BN	Bengali, Bangla	LN	Lingala	TA	Tamil
BO	Tibetan	LO	Laotian	TE	Telugu
BR	Breton	LT	Lithuanian	TG	Tajik
CA	Catalan	LV	Latvian, Lettish	TH	Thai
CO	Corsican	MG	Malagasy	TI	Tigrinya
CS	Czech	MI	Maori	TK	Turkmen
CY	Welsh	MK	Macedonian	TL	Tagalog
DA	Danish	ML	Malayalam	TN	Setswana
DZ	Bhutani	MN	Mongolian	TO	Tongan
EL	Greek	MO	Moldavian	TR	Turkish
EO	Esperanto	MR	Marathi	TS	Tsonga
ET	Estonian	MT	Maltese	TT	Tatar
EU	Basque	MY	Burmese	TW	Twi
FA	Persian	NA	Nauru	UK	Ukrainian
FI	Finnish	NE	Nepali	UR	Urdu
FJ	Fiji	NO	Norwegian	UZ	Uzbek
FO	Faroese	OC	Occitan	VI	Vietnamese
FY	Frisian	OM	(Afan) Oromo	VO	Volapük
GA	Irish	OR	Oriya	WO	Wolof
GD	Scottish Gaelic	PA	Panjabi	XH	Xhosa
GL	Galician	PL	Polish	YO	Yoruba
		PS	Pashto, Pushto	ZU	Zulu

# Operating a TV with the remote control

You can operate the basic functions of selected TVs using the supplied remote control.

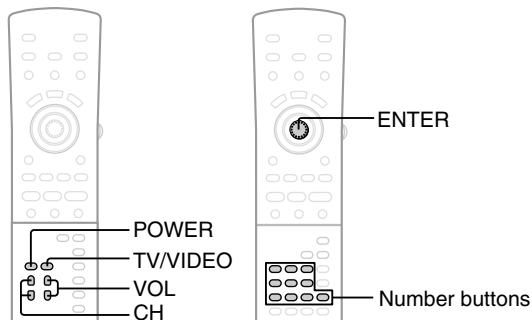

## Operating a TV with the remote control

### Preparation

Follow the instruction of "To program the remote control" to set the brand code.

### Point the remote control at your TV, and use buttons as follows.

POWER	To turn the power on and off.
TV/VIDEO	To select a video input.
VOL ▲/▼	To adjust the volume.
CH ▲/▼	To select a channel.

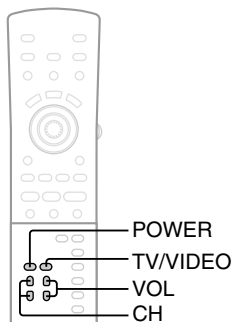

Close the cover to use these buttons.

### To program the remote control

- 1 While holding down **ENTER**, press the **number buttons** that correspond to your TV's brand code referring to the list on the next page.

e.g. To Program brand code 0071.

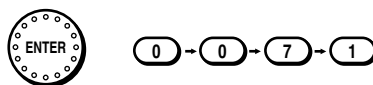

Hold down.

- 2 Release **ENTER**.  
The DVD remote control memorizes the selected brand code.

### Notes

- The remote control is programmed at the factory to operate TOSHIBA TVs.
- A single brand may use different codes depending on the particular model. Enter the correct number referring to the brand code table.
- For some brands, several brand codes are provided. Try each of them until the remote control operates your TV.
- Some TVs may not respond to all of the functions in the table above, or may not be operated at all with this remote control. In this case, operate that TV with its own remote control.
- If you replace the remote control's batteries, remember to reprogram the brand codes for TV.

### ■ Brand code table

Brand name	Brand code					Brand name	Brand code				
TOSHIBA	0001	0071	0211	0571		RCA	0971	1071	1081	1091	0201
BELL & HOWELL	0471	0651	0071	0281	0441		1041	0501			
CARVER	0201	0251	0281	0411	0501	REALISTIC	0631	1001	1011	1021	1031
CITIZEN	0201	0251					0851	0201	0501	0481	0321
CURTIS MATHES	0471	0651	0071	0281	0441		0331	0501	0651	0771	
	0311	0431	0521	0571		RUNCO	0071	0091	0281	0291	0341
EMERSON	0201	0231	0471	0481	0571		0471	0651			
	0581	0651				SAMSUNG	0171	0181	0251	0281	0411
FISHER	0041	0121	0181	0201	0281		0491	0501	0631	0661	0791
	0471	0571	0651			SANYO	0021	0041	0081	0121	0171
GE	0941	0951	0961	0971	0981		0181	0201	0231	0241	0451
	0991	1041					0571	0651	0671	0701	0711
GOLDSTAR	0201	0251	0281	0411	0501		0721				
HALLMARK	0001	0511	0201	0231	0471	SEARS	0001	0191	0491	0201	0501
	0481	0571	0581	0651			0071	0211	0571	0041	0121
HITACHI	0021	0221	0251	0351	0371		0181	0201	0281	0471	0651
	0381	0431	0571	0641	0751	SHARP	0851	0511	0571	0201	0501
INFINITY	0501					SONY	0441	0451	0571	0681	
JBL	0501					SOUNDESIGN	0201	0481			
JVC	0311	0431	0521	0571		SYLVANIA	0501	0071	0191	0221	0461
LXI	0001	0511	0851				0471	0591	0611	0651	0371
MAGNAVOX	0501	0071	0191	0221	0461		0511	0531	0841		
	0471	0591	0611	0651		TANDY	0171	0511	0851	0571	0201
MARANTZ	0201	0501					0501				
MEMOREX	0411					TECHNICS	0371	0501	0511	0531	0761
MGA	0201						0841	0911			
MINISUBISHI	0201	0321	0331	0451	0501	TEKNIKA	0201	0251	0481	0501	
	0511	0571	0651	0771		TMK	0201	0251			
MTC	0201	0251				VIDTECH	0201	0501	0401	0411	0851
NAD	0001	0511					0511				
OPTONICA	0511	0851	0571	0201	0501	WARDS	0201	0501	0001	0191	0481
PANASONIC	0371	0501	0511	0531	0761		0491	0851	0511	0571	0071
	0841	0911	1061				0281	0441			
PHILCO	0071	0111	0181	0201	0271	ZENITH	0931				
	0301	0461	0501	0651							
PHILIPS	0071	0191	0221	0461	0471						
	0501	0591	0611	0651							
PROTON	0201										
PULSAR	0931	0071	0091	0281	0291						
	0341	0471	0651								
QUASAR	0371	0501	0511	0531	0761						
	0841	0911									
RADIO SHACK	0631	1001	1011	1021	1031						
	0851	0201	0501	0481	0321						
	0331	0501	0651	0771							

# Others

- **Before Calling Service Personnel**
- **Specifications**
- **LIMITED WARRANTY DVD VIDEO PLAYER**

## Before Calling Service Personnel

Check the following guide for the possible cause of a problem before contacting service.

### Symptoms and correction

Symptom	Cause	Correction	Page
No power.	<ul style="list-style-type: none"> <li>The power plug is disconnected.</li> </ul>	<ul style="list-style-type: none"> <li>Connect the power plug securely into the wall outlet.</li> </ul>	<b>18</b>
The DVD video player turned off by itself.	<ul style="list-style-type: none"> <li>The automatic power off function turned the unit off.</li> </ul>	<ul style="list-style-type: none"> <li>Press the PLAY button.</li> </ul>	<b>27</b>
No picture.	<ul style="list-style-type: none"> <li>The TV is not set to receive DVD signal output.</li> </ul>	<ul style="list-style-type: none"> <li>Select the appropriate video input mode on the TV so the picture from the DVD video player appears on the TV screen.</li> </ul>	<b>26</b>
	<ul style="list-style-type: none"> <li>The video cable is not connected securely.</li> </ul>	<ul style="list-style-type: none"> <li>Connect the video cable securely into the appropriate jacks.</li> </ul>	<b>18, 19</b>
No sound.	<ul style="list-style-type: none"> <li>The equipment connected with the audio cable is not set to receive DVD signal output.</li> </ul>	<ul style="list-style-type: none"> <li>Select the correct input mode of the audio receiver so you can listen to the sound from the DVD video player.</li> </ul>	<b>26</b>
	<ul style="list-style-type: none"> <li>The audio cable is not connected securely.</li> </ul>	<ul style="list-style-type: none"> <li>Connect the audio cable securely into the appropriate jacks.</li> </ul>	<b>18-23</b>
	<ul style="list-style-type: none"> <li>The audio receiver or TV is turned off.</li> </ul>	<ul style="list-style-type: none"> <li>Turn on the equipment connected with the audio cable.</li> </ul>	<b>26</b>
	<ul style="list-style-type: none"> <li>The setting of output sound format is incorrect.</li> </ul>	<ul style="list-style-type: none"> <li>Select the proper audio setting.</li> </ul>	<b>42, 54 57</b>
The playback picture has occasional distortion.	<ul style="list-style-type: none"> <li>The disc is dirty.</li> </ul>	<ul style="list-style-type: none"> <li>Eject the disc and clean it.</li> </ul>	<b>9</b>
	<ul style="list-style-type: none"> <li>It is in fast forward or fast reverse playback.</li> </ul>	<ul style="list-style-type: none"> <li>Sometimes a small amount of picture distortion may appear. This is not a malfunction.</li> </ul>	—
Brightness is unstable or noises are present in the playback pictures.	<ul style="list-style-type: none"> <li>The effect of copy protection.</li> </ul>	<ul style="list-style-type: none"> <li>Connect the DVD video player directly to the TV. Avoid connecting the DVD video player to a VCR or TV/VCR combination.</li> </ul>	<b>18</b>
The DVD video player does not start playback.	<ul style="list-style-type: none"> <li>No disc is inserted.</li> </ul>	<ul style="list-style-type: none"> <li>Insert a disc.</li> </ul>	<b>26</b>
	<ul style="list-style-type: none"> <li>An unplayable disc is inserted.</li> </ul>	<ul style="list-style-type: none"> <li>Insert a playable disc. (Check the disc type and color system.)</li> </ul>	<b>10</b>
	<ul style="list-style-type: none"> <li>The disc is placed upside down.</li> </ul>	<ul style="list-style-type: none"> <li>Place the disc with the playback side down.</li> </ul>	<b>26</b>
	<ul style="list-style-type: none"> <li>The disc is not placed within the guide.</li> </ul>	<ul style="list-style-type: none"> <li>Place the disc correctly inside the guide on the disc tray.</li> </ul>	<b>26</b>
	<ul style="list-style-type: none"> <li>The disc is dirty.</li> </ul>	<ul style="list-style-type: none"> <li>Clean the disc.</li> </ul>	<b>9</b>
	<ul style="list-style-type: none"> <li>The parental lock function is set.</li> </ul>	<ul style="list-style-type: none"> <li>Cancel the parental lock function or change the parental lock level.</li> </ul>	<b>54, 61</b>
Playback does not follow the course of the disc's program.	<ul style="list-style-type: none"> <li>It is in the mode of repeat playback, memory playback, etc.</li> </ul>	<ul style="list-style-type: none"> <li>These operations may prevent a proper progress of the contents.</li> </ul>	—
Buttons do not work.	<ul style="list-style-type: none"> <li>Power supply fluctuations or other abnormalities such as static electricity may interrupt correct operations.</li> </ul>	<ul style="list-style-type: none"> <li>Turn the power on or off with the POWER button. Or disconnect the power plug and insert it into the wall outlet again.</li> </ul>	—
The remote control does not work properly.	<ul style="list-style-type: none"> <li>The remote control is not pointed at the remote sensor of the DVD video player.</li> </ul>	<ul style="list-style-type: none"> <li>Point the remote control at the remote sensor of the DVD video player.</li> </ul>	<b>15</b>
	<ul style="list-style-type: none"> <li>The remote control is too far from the DVD video player.</li> </ul>	<ul style="list-style-type: none"> <li>Operate the remote control within about 7 m.</li> </ul>	<b>15</b>
	<ul style="list-style-type: none"> <li>The batteries in the remote control are exhausted.</li> </ul>	<ul style="list-style-type: none"> <li>Replace the batteries with new ones.</li> </ul>	<b>15</b>



## DVD video player / outputs / supplied accessories

### DVD Video Player

Power supply	120 V AC, 60 Hz
Power consumption	19 W
Mass	6.5 kg
External dimensions	435 × 120 × 400 mm (W/H/D)
Signal system	Standard NTSC
Laser	Semiconductor laser, wavelength 650 nm / 780 nm
Frequency range	DVD linear sound : 48 kHz sampling 4 Hz to 22 kHz 96 kHz sampling 4 Hz to 44 kHz
Signal-to-noise ratio	More than 112 dB
Audio dynamic range	More than 106 dB
Harmonic distortion	Less than 0.001 %
Wow and flutter	Below measurable level (less than ±0.001 % (W.PEAK))
Operating conditions	Temperature: 5 °C to 35 °C, Operation status: Horizontal

### Outputs

Video output	1.0 V (p-p), 75 Ω, negative sync., pin jack × 1
S video output	(Y) 1.0 V (p-p), 75 Ω, negative sync., Mini DIN 4-pin × 1 (C) 0.286 V (p-p), 75 Ω
Component video output	(Y) 1.0 V (p-p), 75 Ω, negative sync., pin jack × 1 (P <sub>B</sub> )/(P <sub>R</sub> ) 0.7 V (p-p), 75 Ω, pin jack × 2
Audio output (BITSTREAM/PCM OPTICAL)	Optical connector × 1
Audio output (BITSTREAM/PCM COAXIAL)	0.5 V (p-p), 75 Ω, pin jack × 1
Audio output (2CH AUDIO)	2.0 V (rms), 220 Ω, pin jacks (L, R) × 1
Audio output (5.1CH SURROUND)	2.0 V (rms), 220 Ω, pin jacks × 6

### Supplied Accessories

Audio/video cable .....	1
Remote control (SE-R0033) .....	1
Batteries (AAA) .....	2
Power cord .....	1

- Designs and specifications are subject to change without notice.

## LIMITED WARRANTY DVD VIDEO PLAYER

Toshiba America Consumer Products, Inc. ("TACP"), Toshiba Hawaii ("THI") and Toshiba Canada Limited ("TCL") make the following limited warranties. These limited warranties extend to original purchaser or any person receiving this set as a gift from the original purchaser and to no other purchaser or transferee.

### Limited Ninety (90) Day Warranty

TACP/THI warrant this product against defects in materials or workmanship for a period of ninety (90) days after the date of original retail purchase. During this period, TACP/THI will repair or replace a defective product or part, at their option, with a new or refurbished product or part without charge to you. You must deliver the entire product to a TACP/THI Authorized Service Station. You are responsible for all transportation and insurance charges for the unit to and from the Authorized Service Station. If you live in the U.S.A. you may, at your option, return your DVD Unit to:

Toshiba America Consumer Products Inc.  
Returns Center  
1420C Toshiba Dr.  
Lebanon, TN 37087

Upon receipt we will, at our option, exchange the DVD Unit with a new or refurbished unit. **Canadian consumers are requested to contact TCL. In Hawaii consumers are requested to contact THI.**

### Limited One (1) Year Warranty

TACP/THI further warrant the parts in this product against defects in materials or workmanship for a period of one (1) year after the date of original retail purchase. During this period, TACP/THI will repair or replace a defective product or part, at their option, with a new or refurbished product or part without charge to you, except that if a defective part is replaced after ninety (90) days from the date of the original retail purchase you pay labor charges involved in the replacement. You must also deliver the entire product to a TACP/THI Authorized Service Station. You are responsible for all transportation and insurance charges for the unit to and from the Authorized Service Station. If you live in the U.S.A. you may, at your option, return your DVD Unit to:

Toshiba America Consumer Products Inc.  
Returns Center  
1420C Toshiba Dr.  
Lebanon, TN 37087

Upon receipt we will, at our option, exchange the DVD Unit with a new or refurbished unit. **Canadian Consumers are requested to contact TCL. In Hawaii consumers are requested to contact THI.**

### Rental Units

The warranty for rental units begin with the first rental or thirty (30) days from the date of shipment to the rental firm, whichever comes first.

### Commercial Units

Products sold and used for commercial use have a limited ninety (90) day warranty for all parts and labor.

### Owner's Manual

You should read the owner's manual thoroughly before operating this product. You should complete and mail the enclosed Demographic card within ten (10) days after you, or the person who has given you this product as a gift, purchased this product. This is one way to enable TACP to provide you with better customer service and improved products. Failure to return the card will not affect your rights under this warranty.

### Your Responsibility

The above warranties are subject to the following conditions:

- (1) You must retain your bill of sale or provide other proof of purchase.
- (2) You must notify a TACP/THI/TCL /Authorized Service Station within thirty (30) days after you discover a defective product or part.
- (3) All warranty servicing of this product must be made by a TACP/THI/TCL Authorized Service Station.
- (4) U.S.A. warranties are effective only if the product is purchased and operated in the Continental U.S.A. or Puerto Rico.
- (5) Labor service charges for set installation. Set up, adjustment of customer controls and installation or repair of antenna systems are not covered by this warranty. Reception problems caused by inadequate antenna systems are your responsibility.
- (6) Warranties extend only to defects in materials or workmanship as limited above and do not extend to any product or parts which have been lost or discarded by you or to damage to products or parts caused by misuse, accident, damage caused by Acts of God, such as lighting or fluctuations in electric power, improper installation, improper maintenance or use in violation of instructions furnished by us; or to units which have been altered or modified without authorization of TACP/THI/TCL or to damage to products or part thereof which have had the serial number removed, altered, defaced or rendered illegible.
- (7) Should you elect to return your DVD Unit to TACP after the ninety (90) days and within one (1) year, or after the warranty period has expired: Call (800)-631-3811 to receive information concerning an exchange price. Payment must be enclosed with product in the form of a certified check or money order including reason for return.
- (8) Physically damaged DVD Units are not acceptable for repair or exchange whether in or out of warranty and will be returned as received.

## How to Obtain Warranty Service

- (1) Refer to the troubleshooting guide in your owner's manual. This check list may solve your problem.
- (2) In the U.S.A., only call the TACP toll free number 800-631-3811, or if in Hawaii or Canada see listing below within (30) days after you find a defective product or part.
- (3) Arrange for the delivery of the product to the TACP/THI/TCL Authorized Service Station or TACP Return Center. Products shipped to the Service Station must be insured and safely and securely packed, preferably in the original shipping carton, and a letter explaining the defect and also a copy of the bill of sale or other proof of purchase must be enclosed.

### In the Continental United States contact:



### In Hawaii contact:

Toshiba Hawaii Inc.  
327 Kamakee Street  
Honolulu, HA 96814  
(808)-521-5377

### In Canada contact:

Consumer Electronics Group  
191 McNabb Street  
Markham, Ontario L3R 8H2  
(905)-470-5400

Consumer Electronics Group  
22171 Fraserwood Way  
Richmond, B.C. V6W 1J5  
(604)-303-2500

Consumer Electronics Group  
1643 North Service Road  
Droval, QC H9P 1J1  
(514)-856-4100

All warranties implied by state law, including the implied warranties of merchantability and fitness for a particular purpose, are expressly limited to the duration of the limited warranties set forth above. With the exception of any warranties implied by state law as hereby limited, the foregoing warranty is exclusive and in lieu of all other warranties, guarantees, agreements and similar obligations of manufacturer or seller with respect to the repair or replacement of any parts. In no event shall TACP/THI be liable for consequential or incidental damages.

No person, agent, distributor, dealer or company is authorized to change, modify or extend the terms of these warranties in any manner whatsoever. The time within which an action must be commenced to enforce any obligation of TACP/THI arising under the warranty or under any statute, or law of the United States or any state thereof, is hereby limited to ninety (90) days from the date you discover or should have discovered, the defect. This limitation does not apply to implied warranties arising under state law.

This warranty gives you specific legal rights and you may also have other rights which may vary from state to state. Some states do not allow limitation on how long an implied warranty lasts, when an action may be brought, or the exclusion or limitation of incidental or consequential damages, so the above provisions may not apply to you.

### ATTENTION CANADIAN CONSUMERS:

Canadian consumers are requested to complete the special Canadian "Warranty Registration Form" enclosed, and forward this completed form with a copy of bill of sale to TOSHIBA OF CANADA to "Register and Validate" their warranty. Product must be purchased from an Authorized Canadian Dealer. Products purchased in the U.S.A. and used in Canada are not covered by these warranties.

### IMPORTANT: PACKING AND SHIPPING INSTRUCTION

When you send the product to a Service Station, you must use the original carton box and packing material, then insert the original carton box containing the unit into another carton using more packing material.

**TOSHIBA**

Printed in Malaysia

## 2. LOCATION OF MAIN PARTS AND MECHANISM PARTS

### 2-1. Location of Main Parts

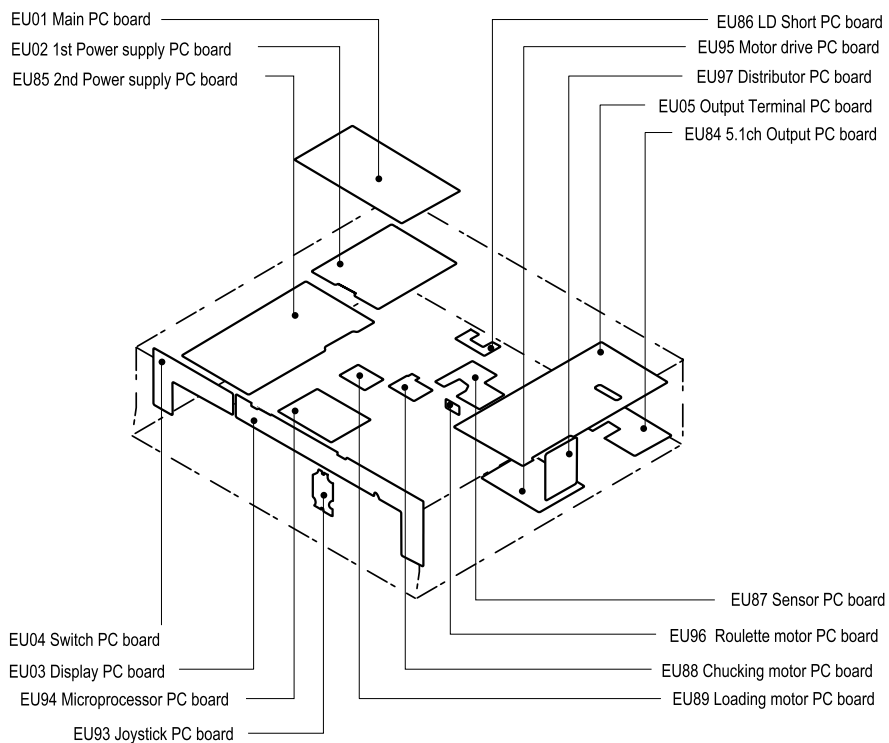

Fig. 1-2-1

## Free Manuals Download Website

<http://myh66.com>

<http://usermanuals.us>

<http://www.somanuals.com>

<http://www.4manuals.cc>

<http://www.manual-lib.com>

<http://www.404manual.com>

<http://www.luxmanual.com>

<http://aubethermostatmanual.com>

Golf course search by state

<http://golfingnear.com>

Email search by domain

<http://emailbydomain.com>

Auto manuals search

<http://auto.somanuals.com>

TV manuals search

<http://tv.somanuals.com>