

# TOSHIBA

FILE NO. 810-200327

## SERVICE MANUAL



# DVD VIDEO PLAYER

# SD-4900



# SECTION 1

## SUMMARY

### CONTENTS

<b>OWNER'S MANUAL(SD-4900)</b> .....	<b>1-2</b>
<b>PRODUCT SAFETY SERVICING GUIDELINES FOR VIDEO PRODUCTS</b> .....	<b>1-36</b>
<b>SERVICING PRECAUTIONS</b> .....	<b>1-37</b>
• General Servicing Precautions	
• Insulation Checking Prodedure	
• Electrostatically Sensitive Devices	

# TOSHIBA

## DVD PLAYER OWNER'S MANUAL

MODEL : SD-4900



MP3



3D Surround  
Sound



Before connecting, operating or adjusting this product,  
please read this instruction booklet carefully and completely.

## Safety Precautions



**CAUTION**  
RISK OF ELECTRIC SHOCK  
DO NOT OPEN



**CAUTION:** TO REDUCE THE RISK OF ELECTRIC SHOCK DO NOT REMOVE COVER (OR BACK) NO USER-SERVICEABLE PARTS INSIDE REFER SERVICING TO QUALIFIED SERVICE PERSONNEL.



This lightning flash with arrowhead symbol within an equilateral triangle is intended to alert the user to the presence of uninsulated dangerous voltage within the product's enclosure that may be of sufficient magnitude to constitute a risk of electric shock to persons.



The exclamation point within an equilateral triangle is intended to alert the user to the presence of important operating and maintenance (servicing) instructions in the literature accompanying the appliance.

**WARNING:** TO REDUCE THE RISK OF FIRE OR ELECTRIC SHOCK, DO NOT EXPOSE THIS PRODUCT TO RAIN OR MOISTURE.

**CAUTION:** TO PREVENT ELECTRIC SHOCK, MATCH WIDE BLADE OF PLUG TO WIDE SLOT, FULLY INSERT.

**ATTENTION:** POUR ÉVITER LES CHOC ÉLECTRIQUES, INTRODUIRE LA LAME LA PLUS LARGE DE LA FICHE DANS LA BORNE CORRESPONDANTE DE LA PRISE ET POUSSER JUSQU'AU FOND.

**WARNING:** Do not install this equipment in a confined space such as a bookcase or similar unit.

CLASS 1 LASER PRODUCT  
KLASSE 1 LASER PRODUKT  
LUOKAN 1 LASER LAITE  
KLASS 1 LASER APPARAT  
CLASSE 1 PRODUIT LASER

### CAUTION:

This Digital Video Disc Player employs a Laser System.

To ensure proper use of this product, please read this owner's manual carefully and retain for future reference, should the unit require maintenance, contact an authorized service location-see service procedure.

Use of controls, adjustments or the performance of procedures other than those specified herein may result in hazardous radiation exposure.

To prevent direct exposure to laser beam, do not try to open the enclosure. Visible laser radiation when open. DO NOT STARE INTO BEAM.

**CAUTION:** The apparatus shall not be exposed to water, dripping or splashing and that no objects filled with liquids, such as vases, shall be placed on the apparatus.

**FCC WARNING:** This equipment may generate or use radio frequency energy. Changes or modifications to this equipment may cause harmful interference unless the modifications are expressly approved in the instruction manual. The user could lose the authority to operate this equipment if an unauthorized change or modification is made.

### REGULATORY INFORMATION: FCC Part 15

This product has been tested and found to comply with the limits for a Class B digital device, pursuant to Part 15 of the FCC Rules. These limits are designed to provide reasonable protection against harmful interference when the product is operated in a residential installation. This product generates, uses and can radiate radio frequency energy and, if not installed and used in accordance with the instruction manual, may cause harmful interference to radio communications. However, there is no guarantee that interference will not occur in a particular installation. If this product does cause harmful interference to radio or television reception, which can be determined by turning the product off and on, the user is encouraged to try to correct the interference by one or more of the following measures:

- Reorient or relocate the receiving antenna.
- Increase the separation between the product and receiver.
- Connect the product into an outlet on a circuit different from that to which the receiver is connected.
- Consult the dealer or an experienced radio/TV technician for help.



### Notes on copyrights:

It is forbidden by law to copy, broadcast, show, broadcast via cable, play in public, or rent copyright material without permission.

This product is equipped with copy protection measures developed by Macrovision. Copy protection signals are recorded on some discs. When recording these discs on a VCR, picture noise will appear during playback.

This product incorporates copyright protection technology that is protected by certain U.S. patent claims and other intellectual property rights owned by Macrovision Corporation and other rights owners. Use of this copyright protection technology must be authorized by Macrovision Corporation, and is intended for home and other limited viewing uses only unless otherwise authorized by Macrovision Corporation. Reverse engineering or disassembly is prohibited.

**SERIAL NUMBER:** The serial number is found on the back of this unit. This number is unique to this unit and not available to others. You should record requested information here and retain this guide as a permanent record of your purchase.

Model No. \_\_\_\_\_

Serial No. \_\_\_\_\_

# IMPORTANT SAFETY INSTRUCTIONS

**CAUTION: PLEASE READ AND OBSERVE ALL WARNINGS AND INSTRUCTIONS IN THIS OWNER'S MANUAL AND THOSE MARKED ON THE UNIT. RETAIN THIS BOOKLET FOR FUTURE REFERENCE.**

This set has been designed and manufactured to assure personal safety. Improper use can result in electric shock or fire hazard. The safeguards incorporated in this unit will protect you if you observe the following procedures for installation, use, and servicing.

This unit does not contain any parts that can be repaired by the user.

**DO NOT REMOVE THE CABINET COVER, OR YOU MAY BE EXPOSED TO DANGEROUS VOLTAGE. REFER SERVICING TO QUALIFIED SERVICE PERSONNEL ONLY.**

## 1. Read These Instructions

All safety and operating instructions should be read before the product is operated.

## 2. Follow All Instructions

All operating and use instructions should be followed.

## 3. Keep These Instructions

The safety and operating instructions should be retained for future reference.

## 4. Heed All Warnings

All warnings on the product and in the operating instructions should be adhered to.

## 5. Power Sources

This product should be operated only from the type of power source indicated on the marking label. If you are not sure of the type of power supply in your home, consult your product dealer or local power company. For products intended to operate from battery power, or other sources, refer to the operating instructions.

## 6. Grounding or Polarization

Do not defeat the safety purpose of the polarized plug has two blades with one wider than the other. A grounding-type plug has two blades and a third grounding prong. The wide blade or the prong are provided for your safety. If the provided plug does not fit into your outlet, consult an electrician for replacement of the obsolete outlet.

## 7. Ventilation

Slots and openings in the cabinet are provided for ventilation and to ensure reliable operation of the product and to protect it from overheating. These openings must not be blocked or covered. The openings should never be blocked by placing the product on a bed, sofa, rug or other similar surface. This product should not be placed in a built-in installation such as a bookcase or rack unless proper ventilation is provided or the manufacturer's instructions have been adhered to.

## 8. Heat

Do not install near any heat sources such as radiators, heat registers, stoves, or other apparatus (including amplifiers) that produce heat.

## 9. Water and Moisture

Do not use this apparatus near water. For example: near a bath tub, wash bowl, kitchen sink, Laundry tub, in a wet basement; or near a swimming pool.

## 10. Cleaning

Unplug this product from the wall outlet before cleaning. Do not use liquid cleaners or aerosol cleaners. Clean only with dry cloth.

## 11. Power-Cord Protection

Protect the power cord from being walked on or pinched particularly at plugs, convenience receptacles, and the point where they exit from the apparatus.

## 12. Overloading

Do not overload wall outlets, extension cords, or integral convenience receptacles, this can result in a risk of fire or electric shock.

## 13. Lightning

Unplug this apparatus during lightning storms or when unused for long periods of time. This will prevent damage to the product due to lightning and power-line surges.

## 14. Object and Liquid Entry

Never push objects of any kind into this product through openings as they may touch dangerous voltage points or short-out parts that could result in a fire or electric shock. Never spill liquid of any kind on the product.

## 15. Attachments

Only use attachments/accessories specified by the manufacturer.

## 16. Accessories

Use only with the cart, stand, tripod, bracket, or table specified by the manufacturer or sold with the apparatus. When a cart is used, use caution when moving the cart/apparatus combination to avoid injury from tip-over.



PORTABLE CART  
WARNING

## 17. Disc Tray

Keep your fingers well clear of the disc tray as it is closing. It can cause personal injury.

## 18. Burden

Do not place a heavy object on or step on the product. The object may fall, causing serious personal injury and serious damage to the product.

## 19. Connecting

When you connect the product to other equipment, turn off the power and unplug all of the equipment from the wall outlet. Failure to do so may cause an electric shock and serious personal injury. Read the owner's manual of the other equipment carefully and follow the instructions when making any connections.

## 20. Sound Volume

Reduce the volume to the minimum level before you turn on the product. Otherwise, sudden high volume sound may cause hearing or speaker damage.

## 21. Sound Distortion

Do not allow the product to output distorted sound for a long time. It may cause speaker overheating and fire.

## 22. Earphone

When you use the earphone, keep the volume at a moderate level. If you use the earphone continuously with high volume sound, it may cause hearing damage.

## 23. Laser Beam

Do not look into the opening of the disc tray or ventilation opening of the product to see the source of the laser beam. It may cause sight damage.

## 24. Disc

Do not use a cracked, deformed, or repaired disc. These discs are easily broken and may cause serious personal injury and product malfunction.

## 25. Damage Requiring Service

Refer all servicing to qualified service personnel. Servicing is required when the apparatus has been damaged in any way, such as power-supply cord or plug is damaged, liquid has been spilled or objects have fallen into the apparatus, the apparatus has been exposed to rain or moisture, does not operate normal, or has been dropped.

## 26. Servicing

Do not attempt to service this product yourself as opening or removing the cover may expose you to dangerous voltage or other hazards. Refer all servicing to qualified service personnel.

## 27. Replacement parts

When replacement parts are required, be sure the service technician has used replacement parts specified by the manufacturer or have the same characteristics as the original part. Unauthorized substitutions may result in fire, electric shock, or other hazards.

## 28. Safety Check

Upon completion of any service or repairs to this product, ask the service technician to perform safety checks to determine that the product is in proper operating condition.

# Table of Contents

## Introduction

Safety Precautions .....	2
<b>IMPORTANT SAFETY INSTRUCTIONS .....</b>	<b>3</b>
<b>Table of Contents .....</b>	<b>4</b>
<b>Before Use .....</b>	<b>5-6</b>
Playable Discs .....	5
Precautions .....	6
Notes on Discs .....	6
About Symbols .....	6
<b>Front Panel and Display Window .....</b>	<b>7</b>
<b>Remote Control .....</b>	<b>8</b>
<b>Rear Panel .....</b>	<b>9</b>

## Preparation

<b>Connections .....</b>	<b>10-11</b>
Connecting to a TV .....	10
Connecting to Optional Equipment .....	11
<b>Before Operation .....</b>	<b>12-16</b>
General Explanation .....	12
On-Screen Display .....	12-13
Initial Settings .....	14-16
• <i>Initial Settings General Operation.</i> .....	14
• <i>Language</i> .....	14
• <i>Picture</i> .....	14
• <i>Sound</i> .....	15
• <i>Others</i> .....	16
• <i>Parental Control.</i> .....	17

## Operation

<b>Operation with DVD and Video CD .....</b>	<b>18-21</b>
Playing a DVD and Video CD .....	18
General Features .....	18
• <i>Moving to another TITLE/GROUP</i> .....	18
• <i>Moving to another CHAPTER/TRACK</i> .....	18
• <i>Search</i> .....	18
• <i>Pause</i> .....	18
• <i>Still Picture and Frame-by-Frame Playback</i> .....	19
• <i>Slow Motion</i> .....	19
• <i>Random</i> .....	19
• <i>Repeat A-B</i> .....	19
• <i>Repeat</i> .....	19
• <i>Time Search</i> .....	19
• <i>Selecting the sound enhancement</i> .....	20
• <i>Zoom</i> .....	20
• <i>Marker Search</i> .....	20
Special DVD Features .....	20
• <i>Title Menu</i> .....	20
• <i>Disc Menu</i> .....	20
• <i>Camera Angle</i> .....	20
• <i>Changing the Audio Language</i> .....	20
• <i>Changing the Audio Channel</i> .....	20
• <i>Subtitles</i> .....	20
DVD Audio Discs .....	21
• <i>Moving to another GROUP</i> .....	21
• <i>Viewing another PAGE</i> .....	21

## Operation with Audio CD and MP3/WMA Disc .. 22-23

Playing an Audio CD and MP3/WMA Disc .....	22
Notes on MP3/WMA Recordings .....	22
• <i>Pause</i> .....	23
• <i>Moving to another Track</i> .....	23
• <i>Repeat Track/ All/ Off.</i> .....	23
• <i>Search</i> .....	23
• <i>Random</i> .....	23
• <i>Repeat A-B</i> .....	23
• <i>Selecting the sound enhancement</i> .....	23
• <i>Changing the Audio Channel</i> .....	23

## Operation with JPEG Disc .. 24

Viewing a JPEG disc .....	24
• <i>Moving to another File</i> .....	24
• <i>Still Picture</i> .....	24
• <i>To flip the picture</i> .....	24
• <i>To rotate picture</i> .....	24
• <i>Notes on JPEG Recordings</i> .....	24

## Programmed Playback .. 25

Programmed Playback with Audio CD and MP3/WMA Disc .....	25
Programmed Playback with Video CD .....	25
• <i>Repeat Programmed Tracks</i> .....	25
• <i>Erasing a Track from Program List</i> .....	25
• <i>Erasing the Complete Program List</i> .....	25

## Additional Information .. 26-27

Screen Saver .....	26
Dimmer Function .....	26
Video Mode Setting .....	26
Speaker Settings .....	27



## Reference

<b>Troubleshooting .....</b>	<b>28</b>
<b>Language Code List .....</b>	<b>29</b>
<b>Area Code List .....</b>	<b>30</b>
<b>Specifications .....</b>	<b>31</b>

## Others

### LIMITED WARRANTY DVD VIDEO PLAYER .. 32-33

### About the symbols for instructions

-  Indicates hazards likely to cause harm to the unit itself or other material damage.
-  Indicates special operating features of this unit.
-  Indicates tips and hints for making the task easier.

## Before Use

### Playable Discs

	DVD video discs (8 cm / 12 cm disc)
	DVD audio discs (8 cm / 12 cm disc)
	Video CD (VCD) (8 cm / 12 cm disc)
	Audio CD (8 cm / 12 cm disc)

In addition, this unit can play a DVD-R, and CD-R or CD-RW that contains audio titles, MP3, WMA or JPEG files.

#### Notes

- Depending on the conditions of the recording equipment or the CD-R/RW disc itself, some CD-R/RW discs cannot be played on the unit.
- Do not attach any seal or label to either side (the labeled side or the recorded side) of a disc.
- Do not use irregularly shaped CDs (e.g., heart-shaped or octagonal). It may result in malfunctions.
- Because of problems and errors that can occur during the creation of DVD software and/or the manufacture of DVD discs, Toshiba America Consumer Products, Inc., Toshiba Hawaii, Inc. and Toshiba of Canada, Ltd. cannot guarantee that this player will play every feature of every DVD bearing the DVD logo. As one of the creators of DVD technology, Toshiba DVD players are manufactured to the highest standards of quality and, as a result, such incompatibilities are very rare. If you happen to experience and difficulty playing a DVD on a Toshiba DVD player, please feel free to call our Contact listed in “How to Obtain Warranty Services” on page 32.

#### Notes on DVDs and Video CDs

Some playback operations of DVDs and Video CDs may be intentionally fixed by software manufacturers. As this unit plays DVDs and Video CDs according to disc content designed by the software manufacturer, some playback features of the unit may not be available or other functions may be added.

Refer also to the instructions supplied with the DVDs and Video CDs. Some DVDs made for business purposes may not be played on the unit.

#### Regional code of the DVD player and DVDs

This DVD player is designed and manufactured for playback of region “1” encoded DVD software. The region code on the labels of some DVD discs indicates which type of player can play those discs. This unit can play only DVD discs labeled “1” or “ALL”. If you try to play any other discs, the message “Check Regional Code” will appear on the TV screen. Some DVD discs may not have a region code label even though their playback is prohibited by area limits.



#### Disc-related terms

##### Title (DVD video discs only)

The main film content or accompanying feature content or additional feature content, or music album. Each title is assigned a title reference number enabling you to locate it easily.

##### Group (DVD audio discs only)

The main audio content or accompanying feature content or additional feature content, or music album. Each group is assigned a group reference number enabling you to locate it easily.

##### Chapter (DVD video discs only)

Sections of a picture or a musical piece that are smaller than titles. A title is composed of one or several chapters. Each chapter is assigned a chapter number, enabling you to locate the chapter you want. Depending on the disc, chapters may not be recorded.

##### Track (DVD audio discs, Video CD and audio CD only)

Sections of a picture or a musical piece on a video CD or an audio CD. Each track is assigned a track number, enabling you to locate the track you want.

##### Scene

On a video CD with PBC (Playback control) functions, moving pictures and still pictures are divided into sections called “Scenes”. Each scene is displayed in the menu screen and assigned a scene number, enabling you to locate the scene you want.

A scene is composed of one or several tracks.

#### Types of video CDs

There are two types of video CDs:

##### Video CDs equipped with PBC (Version 2.0)

PBC (Playback control) functions allow you to interact with the system via menus, search functions, or other typical computer-like operations. Moreover, still pictures of high resolution can be played if they are included in the disc.

##### Video CDs not equipped with PBC (Version 1.1)

Operated in the same way as audio CDs, these discs allow playback of video pictures as well as sound, but they are not equipped with PBC.

## Before Use (Continued)

### Precautions

#### Handling the unit

##### When shipping the unit

The original shipping carton and packing materials come in handy. For maximum protection, re-pack the unit as it was originally packed at the factory.

##### When setting up the unit

The picture and sound of a nearby TV, VCR, or radio may be distorted during playback. In this case, position the unit away from the TV, VCR, or radio, or turn off the unit after removing the disc.

##### To keep the exterior surfaces clean

Do not use volatile liquids, such as insecticide spray, near the unit. Do not leave rubber or plastic products in contact with the unit for a long period of time. They will leave marks on the surface.

#### Cleaning the unit

##### To clean the cabinet

Use a soft, dry cloth. If the surfaces are extremely dirty, use a soft cloth lightly moistened with a mild detergent solution. Do not use strong solvents such as alcohol, benzene, or thinner, as these might damage the surface of the unit.

##### To obtain a clear picture

The DVD player is a high-tech, precision device. If the optical pick-up lens and disc drive parts are dirty or worn, the picture quality will be poor. Regular inspection and maintenance are recommended after every 1,000 hours of use. (This depends on the operating environment.) For details, please contact your nearest dealer.

### Notes on Discs

#### Handling discs

Do not touch the playback side of the disc. Hold the disc by the edges so that fingerprints will not get on the surface. Do not stick paper or tape on the disc.

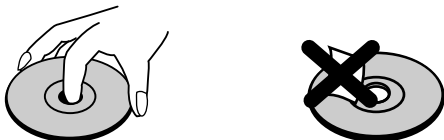

#### Storing discs

After playing, store the disc in its case. Do not expose the disc to direct sunlight or sources of heat, or leave it in a parked car exposed to direct sunlight, as there may be a considerable temperature increase inside the car.

#### Cleaning discs

Fingerprints and dust on the disc can cause poor picture quality and sound distortion. Before playing, clean the disc with a clean cloth. Wipe the disc from the center out.

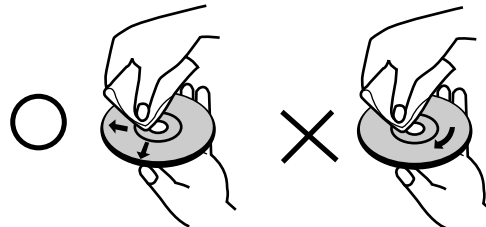

Do not use strong solvents such as alcohol, benzene, thinner, commercially available cleaners, or anti-static spray intended for older vinyl records.









### About Symbols

#### About the symbol display

“” may appear on the TV screen during operation. This icon means the function explained in this owner's manual is not available on that specific DVD video disc.

#### About the disc symbols for instructions

A section whose title has one of the following symbol is applicable only to the disc represented by the symbol.

	DVD Video discs
	DVD Audio discs
	Video CDs with the PBC (playback control) function.
	Video CDs without the PBC (playback control) function.
	Audio CDs.
	MP3 disc.
	WMA disc.
	JPEG disc.



# Front Panel and Display Window

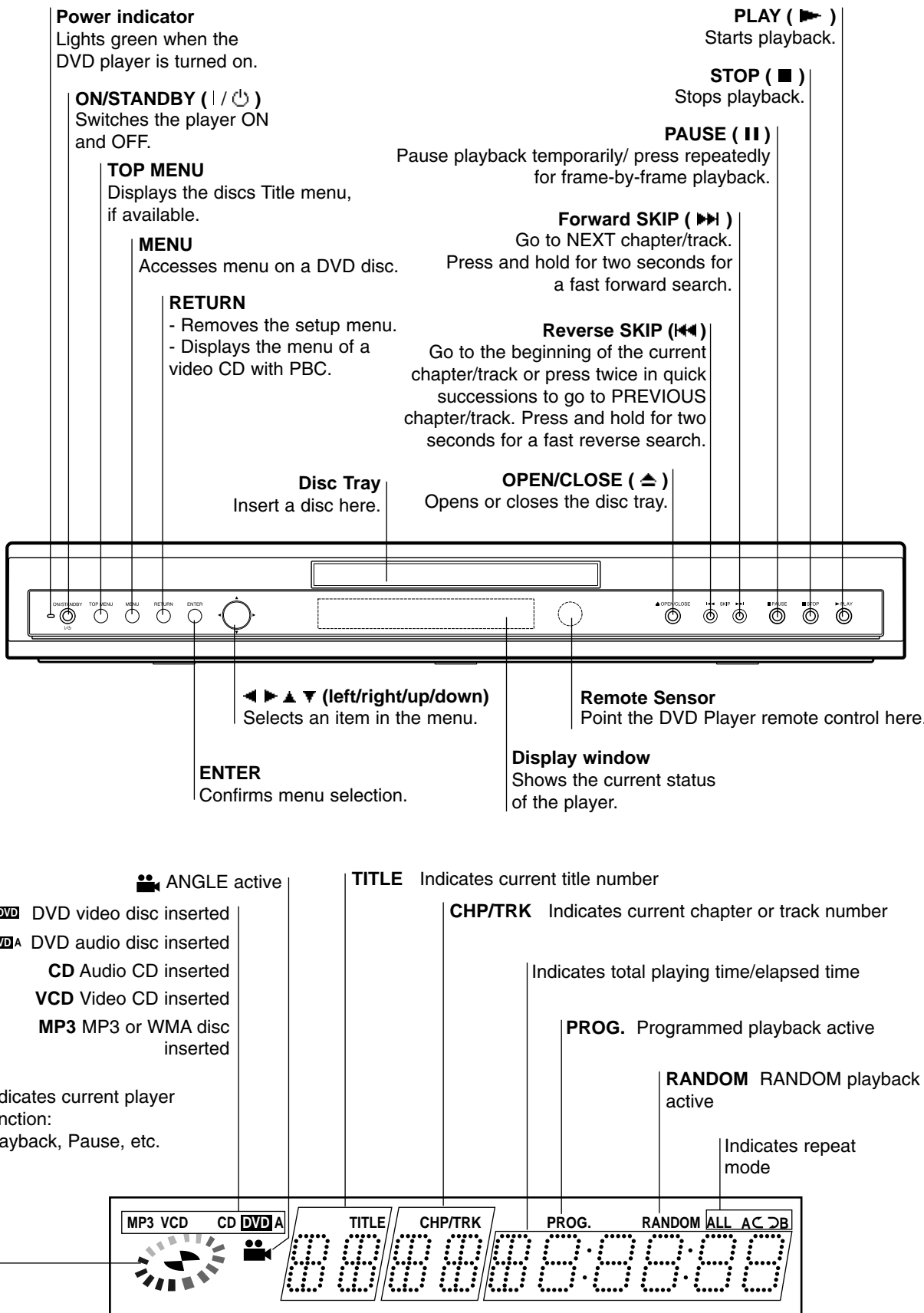

# Remote Control

**SETUP**  
Accesses or removes setup menu.

**OPEN/CLOSE**  
Opens and closes the disc tray.

**0-9 number buttons**  
Selects numbered items in a menu.

**FL DIM**  
Controls the Display Window's light.

**TOP MENU •**  
Displays the discs Title menu, if available.

**MENU •**  
Accesses menu on a DVD disc.

**RETURN •**  
- Removes the setup menu.  
- Displays the menu of a video CD with PBC.

**ZOOM •**  
Enlarges video image.

**PLAY (▶) •**  
Starts playback.

**REV (Reverse) (◀◀) •**  
Search backward.

**FWD (Forward) (▶▶) •**  
Search forward.

**Reverse SLOW (◀|) •**  
Reverse slow playback.

**Forward SLOW (|▶) •**  
Forward slow playback.

**STOP (■) •**  
Stops playback.

**Forward SKIP (▶▶▶) •**  
Advances to next chapter or track.

**Reverse SKIP (◀◀◀) •**  
Returns to beginning of current chapter or track or press twice in quick successions to go to previous chapter or track.

**ON/STANDBY**  
Switches DVD Player ON and OFF.

**E.A.M.**  
Selects sound mode during disc playback.

**PROGRAM**  
Enters to the program edit mode or exits from that.

**CLEAR**  
Removes a track number on the program list or a mark on the MARKER SEARCH menu.

**MARKER**  
Marks any point during playback.

**DISPLAY**  
Accesses On-Screen display.

- ANGLE**  
Selects a DVD camera angle if available
- SUBTITLE**  
Selects a subtitle language.
- AUDIO**  
Selects an audio language (DVD) or an audio channel (CD).
- RANDOM**  
Plays tracks in random order.
- PAUSE/STEP (||/||▶) •**  
Pauses playback temporarily/ press repeatedly for frame-by-frame playback.
- SEARCH**  
Displays MARKER SEARCH menu.
- A-B RPT**  
Repeat sequence.
- REPEAT**  
Repeat chapter, track, title, group, all.
- ENTER**  
Confirms menu selection.
- ◀▶▲▼ (left/right/up/down)**  
Selects an item in the menu.

## Remote Control Operation Range

Point the remote control at the remote sensor and press the buttons.

- **Distance:** About 23 ft (7 m) from the front of the remote sensor.
- **Angle:** About 30° in each direction of the front of the remote sensor.

## Remote control battery installation

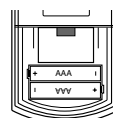

Detach the battery cover on the rear of the remote control, and insert two R03 (size AAA) batteries with + and - aligned correctly.



### Caution

Do not mix old and new batteries. Never mix different types of batteries (standard, alkaline, etc.).

## Rear Panel

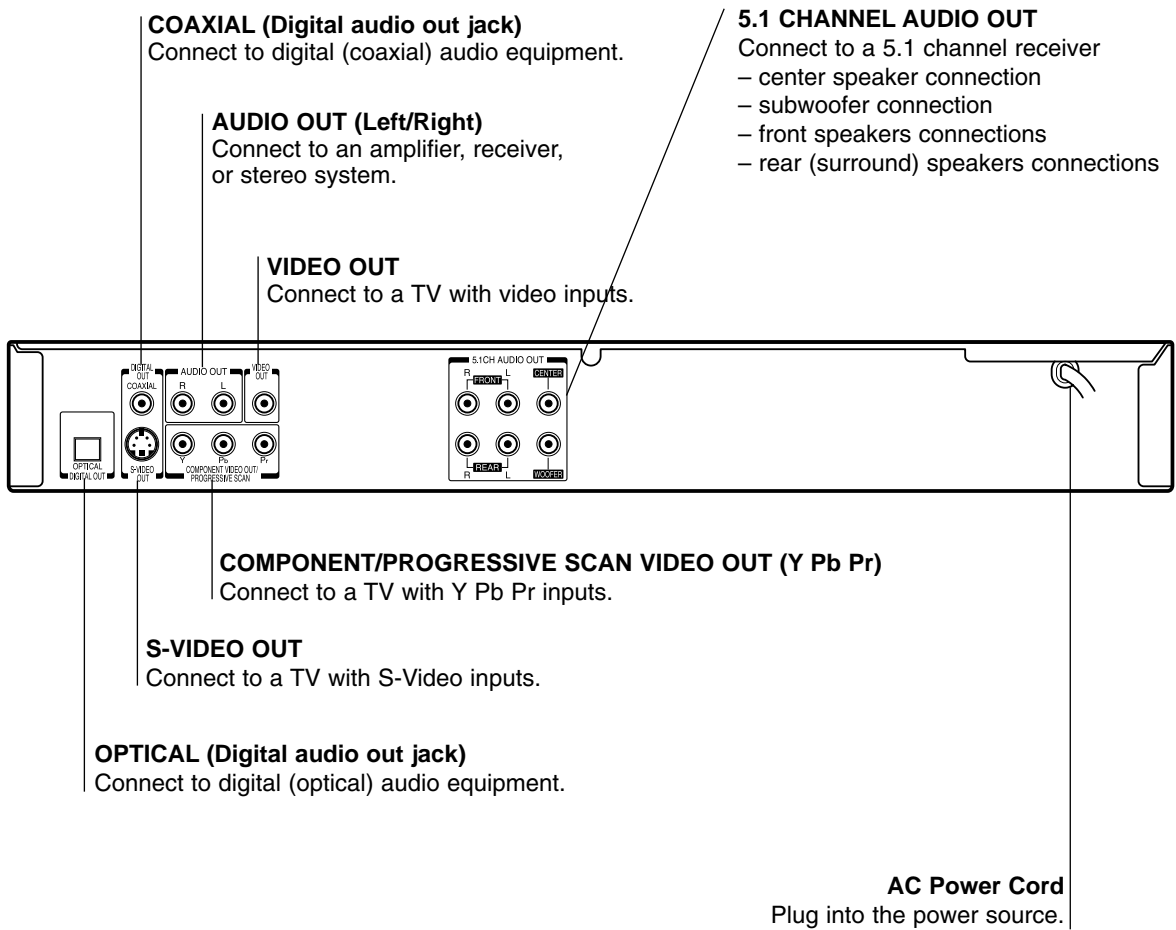

**Do not touch the inner pins of the jacks on the rear panel. Electrostatic discharge may cause permanent damage to the unit.**

# Connections

## Tips

- Depending on your TV and other equipment you wish to connect, there are various ways you could connect the player. Use only one of the connections described below.
- Please refer to the manuals of your TV, VCR, Stereo System or other devices as necessary to make the best connections.
- For better sound reproduction, connect the player's AUDIO OUT jacks to the audio in jacks of your amplifier, receiver, stereo or audio/video equipment. See "Connecting to Optional Equipment" on page 11.

## Caution

- Make sure the DVD Player is connected directly to the TV. Tune the TV to the correct video input channel.
- Do not connect the DVD Player's AUDIO OUT jack to the phono in jack (record deck) of your audio system.
- Do not connect your DVD Player via your VCR. The DVD image could be distorted by the copy protection system.

## Connecting to a TV

- Make one of the following connections, depending on the capabilities of your existing equipment.

### Video connection (Good)

- 1 Connect the VIDEO OUT jack on the DVD Player to the video in jack on the TV using the video cable (V).
- 2 Connect the Left and Right AUDIO OUT jacks of the DVD Player to the audio left/right in jacks on the TV (A) using the audio cables.

### S-Video connection (Better)

- 1 Connect the S-VIDEO OUT jack on the DVD Player to the S-Video in jack on the TV using the S-Video cable (S).
- 2 Connect the Left and Right AUDIO OUT jacks of the DVD Player to the audio left/right in jacks on the TV (A) using the audio cables.

### Component Video (ColorStream®) connection (Best)

- 1 Connect the COMPONENT VIDEO OUT/ PROGRESSIVE SCAN jacks on the DVD Player to the corresponding in jacks on the TV using the Y Pb Pr cable (C).
- 2 Connect the Left and Right AUDIO OUT jacks of the DVD Player to the audio left/right in jacks on the TV (A) using the audio cables.

### Progressive Scan (ColorStream®Pro) connection

- If your television is a high-definition or "digital ready" television, you may take advantage of the DVD Player's progressive scan output for the highest video resolution possible.
- If your TV does not accept the Progressive Scan format, the picture will appear scrambled if you try Progressive Scan on the DVD Player.

- 1 Connect the COMPONENT VIDEO OUT/ PROGRESSIVE SCAN jacks on the DVD Player to the corresponding in jacks on the TV using the Y Pb Pr cable (C).
- 2 Connect the Left and Right AUDIO OUT jacks of the DVD Player to the audio left/right in jacks on the TV (A) using the audio cables.

## Notes

- Set the Progressive to "On" on the setup menu for progressive signal, see page 14.
- Progressive scan does not work with the analog video connections (yellow VIDEO OUT jack) or S-VIDEO connection.

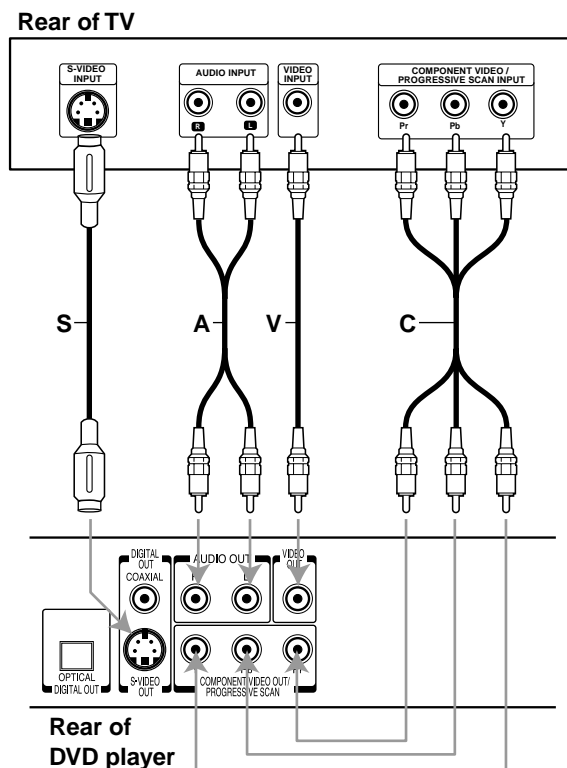

## Note

If the TV has an S-video input, connect the DVD player with the S-video cable. When using an S-video cable, do not connect the yellow video cable.

## Connections (Continued)

### Connecting to Optional Equipment

#### Connecting to an amplifier equipped with two channel analog stereo or Dolby Pro Logic II/ Pro Logic

Connect the Left and Right AUDIO OUT jacks on the DVD Player to the audio left and right in jacks on your amplifier, receiver, or stereo system, using the audio cables (A).

#### Connecting to an amplifier equipped with two channel digital stereo (PCM) or to an Audio/ Video receiver equipped with a multi-channel decoder (Dolby Digital™, MPEG 2, or DTS)

- 1 Connect one of the DVD Player's DIGITAL AUDIO OUT jacks (OPTICAL O or COAXIAL X) to the corresponding in jack on your amplifier. Use an optional digital (optical O or coaxial X) audio cable.
- 2 You will need to activate the player's digital output. (See "Digital Audio Output" on page 15).

#### Digital Multi-channel sound

A digital multi-channel connection provides the best sound quality. For this you need a multi-channel Audio/Video receiver that supports one or more of the audio formats supported by your DVD Player (MPEG 2, Dolby Digital™ and DTS). Check the receiver manual and the logos on the front of the receiver.

#### Caution:

Due to the DTS Licensing agreement, the digital output will be in DTS digital out when DTS audio stream is selected.

Rear of DVD player

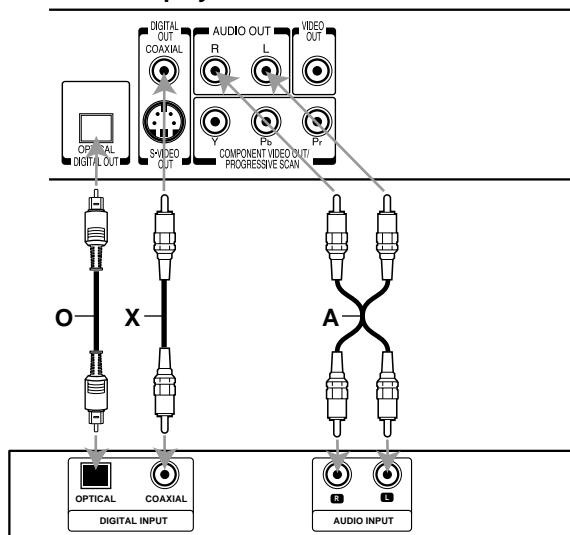

Amplifier (Receiver)

#### Notes

- If the audio format of the digital output does not match the capabilities of your receiver, the receiver will produce a strong, distorted sound or no sound at all.
- Six Channel Digital Surround Sound via digital connection can only be obtained if your receiver is equipped with a Digital Multi-channel decoder.
- To see the audio format of the current DVD in the on-screen display, press AUDIO.
- Repeated pressing of the AUDIO button may allow you to select between various audio formats available on the disc.

#### Note

This player does not perform internal (2 channel) decoding of a DTS sound track. To enjoy DTS multi channel surround, you must connect this player to a DTS compatible receiver via one of this player's digital audio outputs. There will be no output at 6 channel connectors of this player when DTS is selected.

#### Analog connection to a multi-channel A/V receiver with 6 Channel connectors (Dolby Digital)

This DVD Player contains a multi-channel decoder. This enables playback of DVDs recorded in Multi-channel Surround without the need for an optional decoder.

- 1 Connect the CENTER and WOOFER jacks for the Center speaker and the Subwoofer (C) to the corresponding in jacks on your receiver.
- 2 Connect the Left and Right FRONT speaker jacks (F) to the corresponding in jacks on your receiver.
- 3 Connect the Left and Right REAR speaker jacks (R) to the corresponding in jacks on your receiver.
- 4 Make the appropriate Sound settings for Analog Output and Speaker Settings in the setup menu. See page 15.

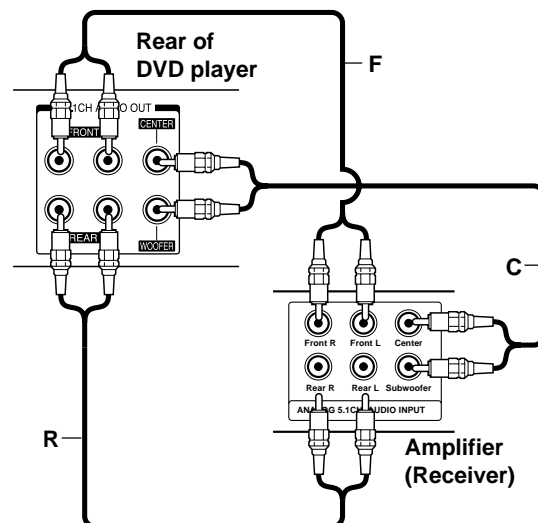

## Before Operation



### General Explanation

This manual gives basic instructions for operating the DVD Player. Some DVDs require specific operation or allow only limited operation during playback. When this occurs, the symbol  appears on the TV screen, indicating that the operation is not permitted by the DVD Player or is not available on the disc.









### On-Screen Display

General playback status can be displayed on the TV screen. Some items can be changed on the menu.

#### On-screen display operation

- 1** Press DISPLAY during playback.
- 2** Press  to select an item.  
The selected item will be highlighted.
- 3** Press  to change the setting of an item.  
The number buttons can also be used for setting numbers (e.g., title number). For some functions, press ENTER to execute the setting.















#### Temporary Feedback Field Icons

-  Repeat Title
-  Repeat Chapter
-  Repeat Group (DVD audio discs only)
-  Repeat Track (non-PBC Video CDs and DVD audio discs only)
-  Repeat All Tracks (non-PBC Video CDs only)
-  Repeat A-B
-  Repeat Off
-  Resume play from this point
-  Action prohibited or not available

#### Notes

- Some discs may not provide all of the features on the on-screen display example shown below.
- If no button is pressed for 10 seconds, the on-screen display disappears.







#### DVD-V

Items		Function (Press  to select desired item)	Selection Method
Title Number	 1/3	Shows the current title number and total number of titles, and skips to the desired title number.	 , or Numbers, ENTER
Chapter Number	 1/12	Shows the current chapter number and total number of chapters, and skips to the desired chapter number.	 , or Numbers, ENTER
Time search	 0:20:09	Shows the elapsed playing time, and searches the point by the elapsed time directly.	Numbers, ENTER
Audio language and Digital Audio Output mode	 1 ENG Dolby Digital 5.1 CH	Shows the current audio soundtrack language, encoding method, and channel number, and changes the setting.	 , or AUDIO
Subtitle language	 OFF	Shows the current subtitles language, and changes the setting.	 , or SUBTITLE
Angle	 1/1	Shows the current angle number and total number of angles, and changes the angle number.	 , or ANGLE
Sound	 NORM.	Shows the current sound mode, and changes the setting.	 , or E.A.M.





## Before Operation (Continued)

### On-Screen Display (Continued)

**DVD-A**

Items	Function (Press ▲/▼ to select desired item)	Selection Method
Group Number	 2 / 6 Shows the current group number and total number of groups, and skips to the desired group number.	◀ / ▶, or Numbers, SELECT/ENTER
Track Number	 1 / 12 Shows the current track number and total number of tracks, and skips to the desired track number.	◀ / ▶, or Numbers, SELECT/ENTER
Time search	 0:10:15 Shows the elapsed playing time.(Display only)	–
DVD Audio Output mode	1  PPCM 5 CH Shows the current encoding method, and channel number, and changes the setting.	◀ / ▶, or AUDIO
Subtitle language	 OFF Shows the current subtitles language, and changes the setting.	◀ / ▶, or SUBTITLE
Page (or Angle)	 1 / 12 or  1 / 1 Shows the current page (or angle) number and total number of pages (or angle), and changes the page (or angle) number.	◀ / ▶, or ANGLE

**VCD2.0**   **VCD1.1**

Items	Function (Press ▲/▼ to select desired item)	Selection Method
Track Number	 1 / 4 Shows the current track number, total number of tracks and PBC On mode, and skip to the desired track number.	◀ / ▶, or Numbers, ENTER
Time	 0:20:09 Shows the elapsed playing time (Display only)	–
Audio Channel	 STER. Shows the audio channel, and changes the audio channel.	◀ / ▶, or AUDIO
Sound	 NORM. Shows the current sound mode, and changes the setting.	◀ / ▶, or E.A.M.

## Before Operation (Continued)

### Initial Settings

You can set your own Personal Preferences on the player.

#### Initial Settings General Operation

- 1 Press **SETUP**.  
The setup menu appears.



- 2 Press **▲/▼** to select the desired item.  
The screen will show the current setting for the selected item, as well as alternate setting(s).
- 3 While the desired item is selected, press **▶**, then **▲/▼** to select the desired setting.
- 4 Press **ENTER** to confirm your selection.  
Some items require additional steps.
- 5 Press **SETUP**, **RETURN**, or **PLAY** to exit the setup menu.

### Language

#### Disc Language **DVD-V** **DVD-A**

Select a language for the disc's Menu, Audio, and Subtitle.

**Original** : The original language set for the disc is selected.

**Other** : To select another language, press number buttons to enter the corresponding 4-digit number according to the language code list on page 29. If you enter the wrong language code, press **CLEAR**.



#### Menu Language

Select a language for the setup menu. This is the menu you see when you press **SETUP**.

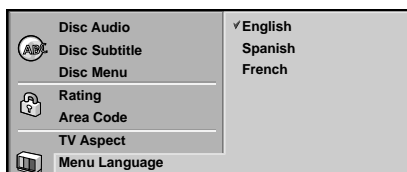

### Picture

#### TV Aspect **DVD-V** **DVD-A**

**4:3 Letterbox**: Select when a standard 4:3 TV is connected. Displays theatrical images with masking bars above and below the picture.

**4:3 Panscan**: Select when a conventional TV set is connected. The video material formatted in the Pan & Scan style is played back in that style (Both sides of the picture are cut off).

**16:9 Wide**: Select when a 16:9 wide TV is connected.

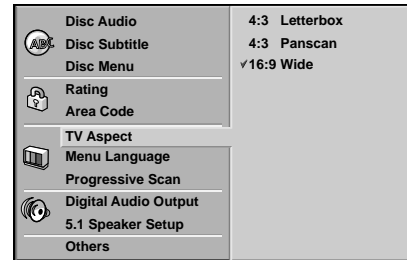

#### Progressive Scan **DVD-V** **DVD-A**

Progressive Scan Video provides the highest quality pictures with less flickering.

If you are using the **COMPONENT VIDEO OUT/PROGRESSIVE SCAN** jacks, but are connecting the DVD Player to a standard (analog) television, set Progressive Scan to Off.

If you are using the Component Video jacks for connection to a TV or monitor that is compatible with a progressive scan signal, set Progressive Scan to On.

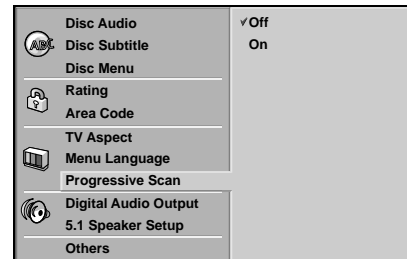

#### **Caution**

Once the setting for progressive scan output is entered, an image will only be visible on a progressive scan compatible TV or monitor. If you set Progressive Scan to On in error, you must reset the unit. Press **STOP** to stop any disc that is playing. Next, press **STOP** again and hold it for five seconds before releasing it. The video output will be restored to the standard setting, and a picture will once again be visible on a conventional analog TV or monitor.



## Before Operation (Continued)

### Sound

#### Digital Audio Output

Each DVD disc has a variety of audio output options. Set the player's Digital Audio Output according to the type of audio system you use.

**DOLBY DIGITAL/PCM:** Select "DOLBY DIGITAL/PCM" if you connected the DVD Player's DIGITAL OUT jack to a Dolby Digital decoder (or an amplifier or other equipment with a Dolby Digital decoder).

**Stream/PCM:** Select "Stream/PCM" if you connected the DVD Player's DIGITAL OUT jack to an amplifier or other equipment with a DTS decoder, Dolby Digital decoder or MPEG decoder.

If you like to have DTS sounds from the digital output jack, you have to select "Stream/PCM".

**PCM:** Select when connected to a 2-channel digital stereo amplifier. The DVD player outputs sounds in the PCM 2ch format when you play a DVD video disc recorded on the Dolby Digital, MPEG1, or MPEG2 recording system.

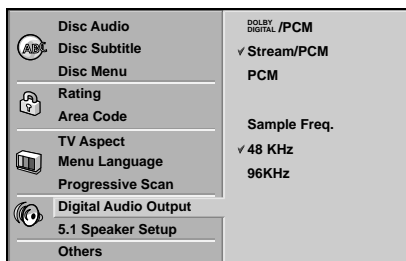

#### Sample Frequency

To change the Sample Frequency setting, first select the desired Digital Audio Output as indicated as above.

- (1) If your receiver or amplifier is NOT capable of handling 96KHz signals, loud buzzing sounds might be heard. In this case, select 48 KHz. When this choice is made, this unit will automatically convert any 96KHz signals to 48KHz so your system can decode them.
- (2) If your receiver or amplifier is capable of handling 96KHz signals, select 96KHz. When this choice is made, this unit will pass each type of signal through without any further processing.

#### 5.1 Speaker settings DVD-V DVD-A

Select speaker settings, including volume balance and delay time, or test the speaker settings.

Speaker settings are only active on the Analog Multi-Channel Output. (See "Speaker Settings", page 27.)

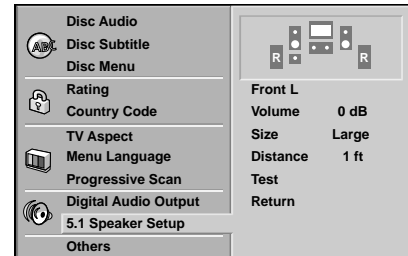

## Before Operation (Continued)

### Others

The DRC, Vocal, PBC, Auto Play, B.L.E., Pluge and DNR settings can be changed.

- Press ▲/▼ to select the desired item and press ENTER. The setting of the selected item is changed between On and Off.

Disc Audio	DRC	On
Disc Subtitle	Vocal	On
Disc Menu	PBC	On
Rating	Auto Play	Off
Area Code	B.L.E.	On
TV Aspect	Pluge	On
Menu Language	DNR	Off
Progressive Scan		
Digital Audio Output		
5.1 Speaker Setup		
Others		

### Dynamic Range Control (DRC) **DVD-V**

With the DVD format, you can hear a program's soundtrack in the most accurate and realistic presentation possible, thanks to digital audio technology. However, you may wish to compress the dynamic range of the audio output (the difference between the loudest sounds and the quietest ones). Then, you may listen to a movie at a lower volume without losing clarity of sound. Set DRC to On for this effect.

### Vocal **DVD-V**

Set Vocal to On only when a multi-channel karaoke DVD is playing. The karaoke channels on the disc will mix into normal stereo sound.

### PBC **VCD2.0 VCD1.1**

Set Playback Control (PBC) to On or Off.

**On:** Video CDs with PBC are played according to the PBC.

**Off:** Video CDs with PBC are played the same way as Audio CDs.

### Auto Play **DVD-V**

You can set up the DVD Player so a DVD disc automatically starts playing whenever the DVD is inserted.

If Auto Play mode is set to On, this DVD player will search a title where playback time is longest and then play back the title automatically.

**On:** Auto Play function is activated.

**Off:** Auto Play function is not activated.

### Note

The Auto Play function may not work for some DVDs.

### B.L.E. (Black Level Expansion) **DVD-V VCD2.0 VCD1.1**

To select the black level of playback pictures. Set your preference and monitor's ability.

**On:** Expanded grey scale. (0 IRE cut off)

**Off:** Standard grey scale. (7.5 IRE cut off)

### Pluge (Blacker than Black) **DVD-V**

For proper adjustment of your television brightness settings utilizing a commercially available test disc.

**On:** Select when you adjust the level of your TV using a commercially available test disc that contains pluge signals.

**Off:** For normal use.

### DNR (Digital Noise Reduction)

#### **DVD-V VCD2.0 VCD1.1**

You can reduce ambient noise in the picture.

**DNR1:** Normal level

**DNR2:** Expanded level.

**Off:** Off.

### Note

– Actual picture enhancement may vary depending on the quality of the disc.

– While the DNR2 (expanded level) can provide additional improvement in the reduction of noise in the video signal, it may produce undesirable picture artifacts on some discs. Should this occur, select a more appropriate DNR level (normal or off).

– Depending on the disc, some picture detail may be lost by the picture enhancement.

– A DVD audio disc with Dolby Digital or DTS soundtrack may be played, some DVD audio discs include moving pictures which may be modified by the above processes.

## Before Operation (Continued)

### Parental Control

#### Rating **DVD-V**

Movies on DVDs may contain scenes not suitable for children. Therefore, discs may contain Parental Control information that applies to the complete disc or to certain scenes on the disc. These scenes are rated from 1 to 8, and alternatively, more suitable scenes are available for selection on some discs. Ratings are country-dependent. The Parental Control feature allows you to prevent discs from being played by your children or to have certain discs played with alternative scenes.

Disc Audio	8
Disc Subtitle	7
Disc Menu	6
Rating	5
Area Code	4
TV Aspect	3
Menu Language	2
Progressive Scan	1
Digital Audio Output	✓Unlock
5.1 Speaker Setup	Change
Others	

- 1 Select "Rating" on the Setup menu using the ▲/▼ buttons.
- 2 While "Rating" is selected, press ►.
- 3 When you have not entered a password yet. Enter a 4-digit password using the numbered buttons to create a personal 4-digit security password, then press ENTER. Enter the 4-digit password again and press ENTER to verify.  
**When you have already entered a password;** Enter a 4-digit password using the numbered buttons to confirm the personal 4-digit security password, then press ENTER.  
  
If you make a mistake before pressing ENTER, press CLEAR and enter 4-digit security password again.
- 4 Select a rating from 1 to 8 using the ▲/▼ buttons.  
**Level 1: DVD software for adults cannot be played back.**  
**Level 8: All DVD software can be played back.**  
**Unlock:** If you select *Unlock*, Parental Control is not active. The disc will play in full.  
**Ratings 1 to 8:** Some discs contain scenes not suitable for children. If you set a rating for the player, all disc scenes with the same rating or lower will be played. Higher rated scenes will not be played unless an alternative scene is available on the disc. The alternative must have the same rating or a lower one. If no suitable alternative is found, playback will stop. You must enter the 4-digit password or change the rating level in order to play the disc.
- 5 Press ENTER to confirm your rating selection, then press SETUP to exit the menu.

#### Area Code **DVD-V**

Enter the code of a country/area whose standards were used to rate the DVD video disc, referring to the list (See "Area Code List", page 30.).

Disc Audio	Code Set
Disc Subtitle	U S
Disc Menu	
Rating	
Area Code	
TV Aspect	
Menu Language	
Progressive Scan	
Digital Audio Output	
5.1 Speaker Setup	
Others	

- 1 Select Area Code using the ▲/▼ buttons on the setup menu.
- 2 While Area Code is selected, press ►.
- 3 Follow step 3 of "Rating" on left.
- 4 Select the first character using the ▲/▼ buttons.
- 5 Shift the cursor using ► button and select the second character using ▲/▼ buttons.
- 6 Press ENTER to confirm your area code selection, then press SETUP to exit the menu.

#### **N** Note

Confirmation of the 4-digit password is necessary when the code is changed (see "Changing the 4-digit code" below.).

#### Changing the 4-digit code

- 1 Follow Steps 1-2 as shown above to the left (Rating).
- 2 Enter the old code, then press ENTER.
- 3 Select Change using ▲/▼ buttons then press ENTER.
- 4 Enter the new 4-digit code, then press ENTER.
- 5 Enter exactly the same code a second time and verify by pressing ENTER.
- 6 Press SETUP to exit the menu.

#### If you forget your 4-digit code

If you forget your password, to clear the current password, follow the procedure below.

- 1 Press SETUP to display the setup menu.
- 2 Use the Number buttons to enter the 6-digit number "210499".  
The 4-digit password is cleared. "P CLr" appears on the display for a moment.
- 3 Enter a new code as shown above to the left (Rating).

# Operation with DVD and Video CD

## Playing a DVD and Video CD

### Playback Setup **DVD-V** **DVD-A** **VCD2.0** **VCD1.1**

- Turn on the TV and select the video input source connected to the DVD player.
- Audio system: Turn on the audio system and select the input source connected to the DVD player.

**1** Press **OPEN/CLOSE** to open the disc tray.

**2** Load your chosen disc in the tray, with the playback side down.

**3** Press **OPEN/CLOSE** to close the tray. **READING** appears on the TV screen, and playback starts automatically. If playback does not start, press **PLAY**.

In some cases, the disc menu might appear instead.

### If a menu screen is displayed

The menu screen may be displayed first after loading a DVD or Video CD which offer a menu.

#### **DVD-V**

Use the **◀ ▶ ▲ ▼** buttons to select the title/chapter you want to view, then press **ENTER** to start playback. Press **TOP MENU** or **MENU** to return to the menu screen.

#### **DVD-A**

Use the **◀ ▶ ▲ ▼** buttons to select an option you want, then press **SELECT/ENTER** to view the option.

#### **VCD2.0**

- Use the number buttons to select the track you want to view.  
Press **RETURN** to return to the menu screen.
- Menu setting and the exact operating procedures for using the menu may differ depending on the disc. Follow the instructions on each menu screen. You also may set **PBC** to **Off** under setup. See page 16.

### Notes

- If Parental Control is set and the disc is not within the Rating settings (not authorized), the 4-digit code must be entered and/or the disc must be authorized (see “Parental Control”, on page 17).
- DVDs may have a region code.  
Your player will not play discs that have a region code different from your player. The region code for this player is 1 (one).

## General Features

### Note

Unless stated otherwise, all operations described use the remote control. Some features may also be available on the Setup menu.

## Moving to another TITLE/GROUP



When a disc has more than one title/group, you can move to another title/group as follows:

- Press **DISPLAY**, then press the appropriate numbered button (0-9) to select a title/group number.

## Moving to another CHAPTER/TRACK

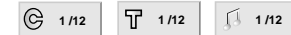

When a title on a disc has more than one chapter or a disc has more than one track, you can move to another chapter/track as follows:

- Press **SKIP** **◀◀** or **▶▶** briefly during playback to select the next chapter/track or to return to the beginning of the current chapter/track.
- Press **SKIP** **◀◀** twice in quick successions to step back to the previous chapter/track.
- To go directly to any chapter/track during DVD playback, press **DISPLAY**. Then, press **▲/▼** to select the chapter/track icon. Then, enter the chapter/track number using the numbered buttons (0-9).

### Note

For two-digit numbers, press the numbered buttons (0-9) in rapid succession.

## Search **DVD-V** **DVD-A** **VCD2.0** **VCD1.1**

- 1 Press **REV** **◀◀** or **FWD** **▶▶** during playback.  
The player will now go into **SEARCH** mode.
- 2 Press **REV** **◀◀** or **FWD** **▶▶** repeatedly to select the required speed: **◀◀X2**, **◀◀X4**, **◀◀X16**, **◀◀X100** (backward) or **▶▶X2**, **▶▶X4**, **▶▶X16**, **▶▶X100** (forward).  
With a Video CD, the Search speed changes: **◀◀X2**, **◀◀X4**, **◀◀X8**, (backward) or **▶▶X2**, **▶▶X4**, **▶▶X8**, (forward).
- 3 To exit **SEARCH** mode, press **PLAY**.

### Note

When using a DVD audio disc that includes pictures, this operation may be permitted in some picture segments.

## Pause **DVD-V** **DVD-A** **VCD2.0** **VCD1.1**

- 1 Press **PAUSE/STEP** during playback.
- 2 To return to playback, press **PLAY**.

### General Features (continued)

3 To cancel the sequence, press A-B RPT.

#### Still Picture and Frame-by-frame playback

DVD-V DVD-A VCD2.0 VCD1.1

- 1 Press PAUSE/STEP during playback.  
The player will now go into PAUSE mode.
- 2 You can advance the picture frame-by-frame by pressing PAUSE/STEP repeatedly on the remote control.

#### Note

When using a DVD audio disc that includes pictures, this operation may be permitted in some picture segments.

#### Slow Motion DVD-V DVD-A VCD2.0 VCD1.1

- 1 Press SLOW ◀ or ▶ during playback.  
The player will enter SLOW mode.
- 2 Use the SLOW ◀ or ▶ to select the required speed:  
◀ 1/16, ◀ 1/8, ◀ 1/4 or ◀ 1/2 (backward), or  
▶ 1/16, ▶ 1/8, ▶ 1/4 or ▶ 1/2 (forward).
- 3 To exit slow motion mode, press PLAY.

#### Notes

- Slow motion playback in reverse is not applicable for Video CD.
- When using a DVD audio disc that includes pictures, this operation may be permitted in some picture segments.

#### Random Karaoke DVD VCD2.0 VCD1.1

- 1 Press RANDOM during playback or in stop mode.  
The unit automatically begins Random Playback and "RANDOM" appears on the display window.
- 2 To return to normal playback, press RANDOM until "RANDOM" disappears on the display window.

#### Tip

By pressing SKIP ▶▶ during Random playback, the unit selects another title (track) and resumes Random playback.

#### Notes

- This function only works with DVD Karaoke discs and video CD without PBC.
- On a Video CD with PBC, you must set PBC to Off on the setup menu to use the Random function. See page 16.

#### Repeat A-B DVD-V DVD-A VCD2.0 VCD1.1

A \* A B OFF

To repeat a sequence in a title or group:

- 1 Press A-B RPT at your desired starting point.  
"A \*" appears briefly on the TV screen.
- 2 Press A-B RPT again at your desired end point.  
"A B" appears briefly on the TV screen, and the repeat sequence begins ("A↔B" appears on the display window).

## Operation with DVD and Video CD

### General Features (continued)

#### Selecting the sound enhancement



Press E.A.M. to select the sound enhancement during playback.

NORM. : Normal sound

3D SUR: This player can produce a 3D Surround effect, which simulates multi-channel audio playback from two conventional stereo speakers, instead of the five or more speakers normally required to listen to multi-channel audio from a home theater system.

DIALOGUE: Enhances critical center channel information to make dialogue more intelligible (only when playing a DVD video disc recorded on the Dolby Digital recording system).

- To use this enhancement on audio output from the DIGITAL AUDIO OUT jack, be sure to set "Digital Audio Output" to "PCM". See page 15.

#### Zoom

The Zoom function allows you to enlarge the video image and to move through the enlarged image.

- 1 Press ZOOM during playback or still playback to activate the Zoom function.  
If you press ZOOM repeatedly, the magnification level increases up to six steps.
- 2 Use the ◀▶▲▼ buttons to move through the zoomed picture.
- 3 Press CLEAR to resume normal playback or return to the paused image.



- The zoom function may not work for some DVD-V and DVD-A.

#### Marker Search



You can start playback from a memorized point. Up to nine points can be memorized.

To enter a mark, follow these steps.

- 1 During disc playback, press MARKER when playback reaches the spot that you want to memorize.  
The Marker icon will appear on the TV screen briefly.
- 2 Repeat step 1 to enter up to nine Marker points on a disc.

#### To Recall a Marked Scene

- 1 During disc playback, press SEARCH.  
The MARKER SEARCH menu will appear on the screen.
- 2 Within 10 seconds, press ◀▶ to select a Marker number that you want to recall.
- 3 Press ENTER.  
Playback will start from the Marked scene.

- 4 To remove the MARKER SEARCH menu, press SEARCH.

#### To clear a Marked Scene

- 1 During disc playback, press SEARCH.  
The MARKER SEARCH menu will appear on the screen.

- 2 Press ◀▶ to select the Marker number that you want to erase.
- 3 Press CLEAR.  
The Marker number will be erased from the list.
- 4 Repeat steps 2 and 3 to erase additional Marker numbers.
- 5 To remove the MARKER SEARCH menu, press SEARCH.

### Special DVD Features

#### Checking the contents of DVD Video discs: Menus

DVDs may offer menus that allow you to access special features. To use the disc menu, press MENU. Then, press the appropriate number button to select an option. Or, use the ◀▶▲▼ buttons to highlight your selection, then press ENTER.

#### Title Menu

- 1 Press TOP MENU.  
If the current title has a menu, the menu will appear on the screen. Otherwise, the disc menu may appear.
- 2 The menu can list camera angles, spoken language and subtitle options, and chapters for the title.
- 3 To remove the title menu, press TOP MENU again.

#### Disc Menu

- 1 Press MENU.  
The disc menu is displayed.
- 2 To remove the disc menu, press MENU again.

#### Camera Angle

If the disc contains scenes recorded at different camera angles, you can change to a different camera angle during playback.

- Press ANGLE repeatedly during playback to select a desired angle.  
The number of the current angle appears on the display.

#### Changing the Audio Language



Press AUDIO repeatedly during playback to hear a different audio language or audio track.

#### Changing the Audio Channel

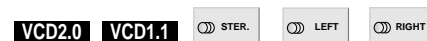

Press AUDIO repeatedly during playback to hear a different audio channel (STER., LEFT or RIGHT).

#### Subtitles

Press SUBTITLE repeatedly during playback to see the different subtitle languages.



If  appears, the feature is not available on the disc.

## Operation with DVD and Video CD

### DVD Audio Discs

DVD Audio is a new disc format building on the success of DVD to provide high quality, uncompressed, multi-channel audio for a new experience in audio quality. A DVD Audio disc can be identified by the DVD audio logo on the disc jacket or on the disc itself.

DVD Audio can provide higher quality stereo than Audio CDs with a sampling rate of up to 192kHz (compared to 44.1kHz for CDs). DVD Audio digital sound can be delivered with up to 24 bits of data (compared to 16 bits for a standard CD).

A typical DVD Audio disc contains up to seven times the data capacity of a CD. This additional space is used for music, either Advanced Resolution multi-channel sound quality that is closer to the artist's master recording or for longer recordings. Many DVD Audio discs contain on-screen text, such as artist biographies, playlists, or lyrics. Some DVD Audio discs contain photo galleries or video clips.

#### Note

To enjoy maximum sound quality and surround effect of DVD Audio, you must use 5.1 channel analog audio output (5.1CH AUDIO OUT jacks on the DVD Player). If you use the DIGITAL OUT (OPTICAL or COAXIAL) for your audio connection, the sound will only be similar to CD-quality sound even though you're playing a DVD Audio disc and might not have surround effect.

### Moving to another GROUP 2/6

Some DVD Audio discs divide content into different groups. Your player enables you to quickly access different groups during playback via the on-screen display.

- 1 Press DISPLAY during playback on in stop mode.
- 2 Press ▲/▼ to select Group icon.
- 3 Press ◀▶ or the numbered buttons (0-9) to select a group number.

#### Note

Sometimes the author of the disc creates hidden content that can only be accessed by entering a password. If the lock icon appears on the TV screen, enter the password (sometimes you'll find it on the disc's jacket cover or on a web site). This password control isn't dictated by your DVD Player — it is a function of the disc. Since the authoring of DVD Audio Discs varies, some of the on-screen display choices might not be available for the disc you're playing.

### Viewing another PAGE 1/12

Since DVD Audio discs can hold a lot of content, there are various ways to see what's available on the disc.

- 1 Press DISPLAY during playback.
- 2 Press ▲/▼ to select Page icon.
- 3 Press ◀▶ to select a page number.

What appears on the screen will vary from disc to disc because the information available depends upon the way the disc was created.

#### Note

Since the authoring of DVD Audio Discs varies, some of the on-screen display choices might not be available for the disc you're playing.

# Operation with Audio CD and MP3/WMA Disc

## Playing an Audio CD and MP3/WMA Disc

**CD** **MP3** **WMA**

The DVD Player can play MP3/WMA formatted recordings on CD-ROM, CD-R or CD-RW discs. Before playing MP3/WMA recordings, read the notes on MP3/WMA Recordings on right.

- 1 Insert a disc and close the tray.**  
**Audio CD;** Audio CD menu appears on the TV screen go to step 4.  
**MP3/WMA disc;** The MP3/WMA-JPEG choice menu appears on the TV screen. Go to step 2



- 2 Press ▲/▼ to select the MP3/WMA then press ENTER.**  
The MP3/WMA menu appears on the TV screen. Press RETURN to move to the MP3/WMA-JPEG choice menu.

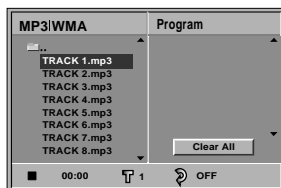

- 3 Press ▲/▼ to select a folder, and ENTER.**  
A list of files in the folder appears.

- 4 Press ▲/▼ to select a track then press PLAY or ENTER.**  
Playback starts.  
During playback, the current track's elapsed playing time will appear on the display window and menu. Playback will stop at the end of the disc.  
Press TOP MENU to move to the next page.  
Press MENU to move to the previous page.

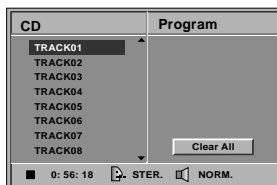

Audio CD menu

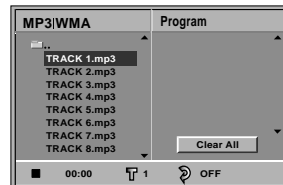

MP3/WMA menu

### **T** Tips

If you are in a file list and want to return to the Folder list, use the ▲/▼ to highlight and press ENTER to return to the previous menu screen.

- 5 To stop playback at any other time, press STOP.**

## Notes on MP3/WMA Recordings

### About MP3

- An MP3 file is audio data compressed by using the MPEG1 audio layer-3 file-coding scheme. We call files that have the “.mp3” file extension “MP3 files”.
- The player can not read an MP3 file that has a file extension other than “.mp3”.

### About WMA(Window Media Audio)

- An WMA file is a Microsoft audio compression technology.
- WMA(Windows Media Audio) offers double the audio compression of the MP3 format.

### MP3/WMA Disc compatibility with this player is limited as follows:

1. Sampling Frequency / only at 44.1kHz (MP3), 22.05 - 44.1kHz (WMA)
2. Bit rate / within 32 - 320kbps (MP3), 32 - 128kbps (WMA)
3. CD-R physical format should be “ISO 9660”
4. If you record MP3/WMA files using the software which cannot create a FILE SYSTEM, for example “Direct-CD” etc., it is impossible to playback MP3/WMA files. We recommend that you use “Easy CD Creator”, which creates an ISO9660 file system.
5. A single session disc requires MP3/WMA files in the first track. If there is no MP3/WMA file in the 1st track, it cannot playback MP3/WMA files. If you wish to playback MP3/WMA files, format all the data in the disc or use a new one.
6. File names should be named using 8 letters or less and must incorporate “.mp3” or “.wma” extension e.g. “\*\*\*\*\*.MP3” or “\*\*\*\*\*.WMA”.
7. Do not use special letters such as “/ : \* ? “ < > ” etc.
8. Total number of files on the disc should be less than 650.

This DVD player requires discs/recordings to meet certain technical standards in order to achieve optimal playback quality. Pre-recorded DVDs are automatically set to these standards. There are many different types of recordable disc formats (including CD-R containing MP3 or WMA files). That require certain pre-existing conditions (see above) to insure compatible playback.

**Customers should also note that permission is required in order to download MP3/WMA files and music from the Internet. Our company has no right to grant such permission. Permission should always be sought from the copyright owner.**

Microsoft, Windows Media, and the Windows Logo are trademarks or registered trademarks of Microsoft Corporation in both the United States and other countries





## Operation with Audio CD and MP3/WMA Disc (Continued)

### Pause **CD** **MP3** **WMA**

- 1 Press PAUSE/STEP during playback.
- 2 To return to playback, press PLAY or press PAUSE/STEP again.

### Moving to another Track **CD** **MP3**

#### **WMA**

- Press SKIP **▶▶** or **◀◀** briefly during playback to go to the next track or to return to the beginning of the current track.
- Press SKIP **◀◀** twice in quick successions to step back to the previous track.
- In case of audio CD, to go directly to any track, enter the track number using the numbered buttons (0-9) during playback.

### Repeat Track/All/Off **CD** **MP3** **WMA**

- 1 To repeat the track currently playing, press REPEAT. The Repeat icon and "TRACK" appears on the menu screen.
- 2 To repeat all tracks on a disc, press REPEAT a second time. The Repeat icon and "ALL" appears on the menu screen.
- 3 To cancel Repeat mode, press REPEAT a third time. The Repeat icon and "OFF" appears on the menu screen.

### Search **CD** **MP3** **WMA**

- 1 Press REV **◀◀** or FWD **▶▶** during playback. The player will now go into SEARCH mode.
- 2 Press REV **◀◀** or FWD **▶▶** repeatedly to select the required speed: **◀◀X2**, **◀◀X4**, **◀◀X8** (backward) or **▶▶X2**, **▶▶X4**, **▶▶X8** (forward). Search speed and direction are indicated on the menu screen.
- 3 To exit SEARCH mode, press PLAY.

### Random **CD** **MP3** **WMA**

- 1 Press RANDOM during playback or when playback is stopped. The unit automatically begins Random Playback and RANDOM or "RAND." appears on the display window and menu screen.
- 2 To return to normal playback, press RANDOM repeatedly until RANDOM or "RAND." disappears on the display window and menu screen.

### Repeat A-B **CD**

To repeat a sequence.

- 1 During disc playback, press A-B RPT at your desired starting point. The Repeat icon and "A \* " appears on the menu screen.
- 2 Press A-B RPT again at your desired end point. The Repeat icon and "A B" appears on the menu screen, and the sequence begins to play repeatedly.
- 3 To exit the sequence and return to normal play, press A-B RPT again. The Repeat icon and "OFF" appears on the menu screen.

### Selecting the sound enhancement

#### **CD**

This unit can produce a 3D Surround effect, which simulates multi-channel audio playback from two conventional stereo speakers, instead of the five or more speakers normally required to listen to multi-channel audio from a home theater system.

- 1 Press E.A.M. to select "3D SUR" during playback.
- 2 To turn off the 3D Surround effect, press E.A.M. again to select "NORM."

### Changing the Audio Channel **CD**

Press AUDIO repeatedly during playback to hear a different audio channel (STER., LEFT, or RIGHT).

## Operation with JPEG Disc

### Viewing a JPEG disc **JPEG**

This DVD Player can play discs with JPEG files. Before playing JPEG recordings, read the notes on JPEG Recordings on right.

- 1 Insert a disc and close the tray.**  
The MP3/WMA-JPEG choice menu appears on the TV screen.



- 2 Press ▲/▼ to select the JPEG then press ENTER.**  
The JPEG menu appears on the TV screen.



- 3 Press ▲/▼ to select a folder, and ENTER.**  
A list of files in the folder appears.  
Press RETURN to move to the MP3/WMA-JPEG choice menu.

#### **T** Tip

If you are in a file list and want to return to the Folder list, use the ▲/▼ buttons on the remote to highlight “..” and press ENTER to return to the previous menu screen.

- 4 If you want to view a particular file, press ▲/▼ to highlight a file and press ENTER or PLAY.**  
Viewing the file proceeding starts.  
During viewing a file, press RETURN to move to the previous menu (JPEG menu).  
Press TOP MENU to move to the next page.  
Press MENU to move to the previous page.

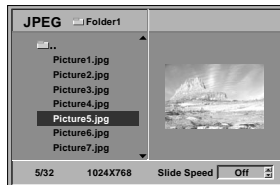

#### **T** Tip

There are three viewing Slide Speed options: Fast, Normal, Slow, and Off. Press ◀/▶ to highlight the Slide Speed then press ▲/▼ to select the option you want to use, and press ENTER.

- 5 To stop viewing at any other time, press STOP.**  
The JPEG menu appears.

### Moving to another File

Press SKIP ◀◀ or ▶▶ once during viewing a picture to advance to the next file or to the previous file.

### Still Picture

- Press PAUSE/STEP during slide show.  
The player will now go into PAUSE mode.
- To return to the slide show, press PLAY or press PAUSE/STEP again.

### To flip the picture

Press ▲/▼ during showing a picture to flip the picture horizontally or a vertically.

### To rotate picture

Press ◀/▶ during showing a picture to rotate the picture clockwise or counter clockwise.

### Notes on JPEG Recordings

- Depending upon the size and number of the JPEG files, it could take a long time for the DVD player to read the disc's contents. If you don't see an on-screen display after several minutes, some of the files are too big — reduce the resolution of the JPEG files to less than 2 mega pixels and burn another disc.
- Total number of files and folders on the disc should be less than 650.
- Some disc may be incompatible due to different recording format or condition of disc.
- When you are using software such as “Easy CD Creator” to burn the jpeg files into the CD-R, ensure that all the selected files have the “.jpg” extensions when copying into the CD layout.
- If the files have “.jpe” or “.jpeg” extensions, please rename them as “.jpg” files.
- File names without “.jpg” extension will not be able to be read by this DVD player. Even though the files are shown as JPEG image files in windows explorer.

## Programmed Playback with Audio CD and MP3/WMA Disc

The Program function enables you to store your favorite tracks from any disc in the player memory.

Program can contain 30 tracks.

### 1 Press PROGRAM during playback or in the stop mode to enter the Program Edit mode.

The [E] mark will appear to the right of the word Program on the right side of the menu screen.

#### Note

Press PROGRAM to exit the Program Edit mode; the [E] mark will disappear.

### 2 Select a track, then press ENTER to place the selected track on the Program list.

### 3 Repeat step 2 to place additional tracks on the Program list.

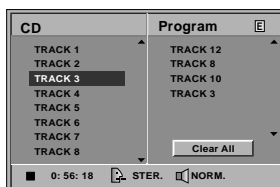

Audio CD menu

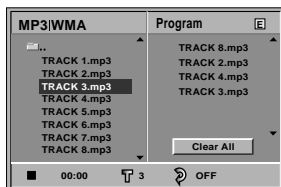

MP3/WMA menu

### 4 Press ►.

The programmed track you selected last is highlighted on the program list.

### 5 Press ▲/▼ to select the track you want to start playing.

Press TOP MENU to move to the next page.  
Press MENU to move to the previous page.

### 6 Press PLAY to start.

Playback begins in the order in which you programmed the tracks and "PROG." appears on both the menu screen and display window.  
Playback stops after all of the tracks on the Program list have played once.

### 7 To resume normal playback from programmed playback, press PROGRAM. Select a track of CD (or MP3/WMA) list and then press ENTER.

"PROG." indicator disappears from the menu screen and display window.

## Programmed Playback with Video CD

#### Note

On a Video CD with PBC, you must set PBC to Off on the setup menu to use the Program function. See page 16.

### 1 Insert Video CD and close the tray.

### 2 Press PROGRAM while playback is stopped.

The VCD Program menu will appear.

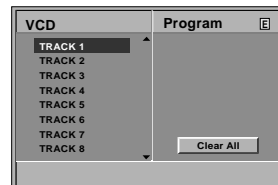

#### Note

Press RETURN or PROGRAM to exit the Program menu.

### 3 Follow steps 2-6 of "Programmed Playback with Audio CD and MP3/WMA disc" on left.

### 4 To resume normal playback from programmed playback, press PROGRAM.

"PROG." indicator disappears in the display window.

## Repeat Programmed Tracks

- To repeat the track currently playing, press REPEAT. The Repeat icon and "TRACK" appears on the menu screen.
- To repeat all tracks on the program list, press REPEAT a second time. The Repeat icon and "ALL" appears on the menu screen.
- To cancel Repeat mode, press REPEAT a third time. The Repeat icon and "OFF" appears on the menu screen.

## Erasing a Track from Program List

### 1 Press PROGRAM during playback (Audio CD and MP3/WMA disc only) or in the stop mode to enter the Program Edit mode.

The [E] mark will appear.

### 2 Press ► to move to the Program list.

### 3 Use ▲/▼ to select the track that you wish to erase from the Program list.

### 4 Press CLEAR.

The track will be erased from the Program list.

## Erasing the Complete Program List

### 1 Follow steps 1-2 of "Erasing a Track from Program List" as above.

### 2 Use ▲/▼ to select "Clear All", then press ENTER.

The complete Program for the disc will be erased.

The programs are also cleared when the disc is removed.

## Additional Information

### Screen Saver

The screen saver picture appears when you leave the DVD Player in stop mode for about five minutes. After the Screen Saver has been engaged for about five minutes, the DVD Player will automatically turn itself off.

### Dimmer Function

You can adjust the Display Window's brightness in 3 steps. Each press of the FL DIM button modifies the Display Window's brightness in the following order:

Normal → Dim → Display Off → Normal

### Video Mode Setting

**DVD-V** **DVD-A** **VCD2.0** **VCD1.1**

- With certain discs, the playback picture may be flickering or Dot Crawl is shown on straight lines. That means Vertical interpolation or De-interlace is not perfectly matched with the disc. In this case, the picture quality may be improved by changing the video mode.
- To change the video mode, press and hold DISPLAY about 3 seconds during disc playback. The new video mode number selected is displayed on the TV screen. Check whether the video quality has improved. If not, repeat the above procedure until picture quality is improved.
- Video mode sequence:  
Auto → Film → Video → Auto
- If you turn off the power, the video mode will return to initial default state (Auto).

#### Detailed Description of each Video Mode

**Auto** : The source material of the DVD video (film material or video material) is determined from disc information.

**Film** : Suitable for playing film based content or video based material recorded by the progressive scan method.

**Video** : Suitable for playing video based content with comparatively little motion.

#### Note

The video mode setting only works when the Progressive Scan mode is set to "On" on the setup menu.

# Speaker Settings

Make the following settings for the built-in 5.1 channel surround decoder.

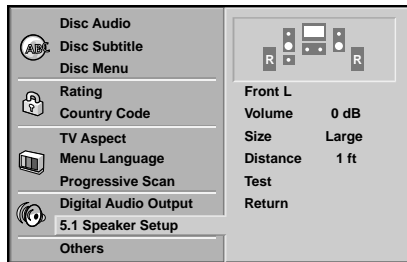

- 1** Select “5.1 Speaker Setup” using the ▲/▼ buttons on the setup menu.
- 2** While “5.1 Speaker Setup” is selected, press ► button.
- 3** Press ◀▶ buttons to select the desired speaker.
- 4** Adjust options by using ▲▼◀▶ buttons.

## Speaker selection

Select a speaker that you want to adjust. (Front speakers (Left), Front speakers (Right), Center Speaker, Rear speakers (Left), Rear speakers (Right), or Subwoofer)

### Note

Certain speaker settings are prohibited by the Dolby Digital licensing agreement.

## Volume

Press ◀/▶ to adjust the output level of the selected speaker. (-10dB - 0dB)

## Size

- Press ◀/▶ to set a mode. (Large, Small or None)
- If you have connected the system to a speaker with a low frequency of 100Hz or below, select “Large.”
- If you have connected the system to a speaker without a low frequency of 100Hz or below, select “Small.” If you have not connected a subwoofer, always select “Large” for Front speaker (L/R).
- When you do not have a certain speaker connected, select “None.”
- Front L/R speaker’s size can be set to “Large” or “Small.”
- If Front L/R speaker’s size is set to “Small,” Rear and Center speaker’s size can be set to “Small” or “None.”
- Subwoofer’s size can be set only to “Large” or “None”.

## Distance

If you connected speakers to your DVD Player, setting the Distance lets the speakers know how far the sound has to travel to reach your set listening point. This allows the sound from each speaker to reach the listener at the same time. (1 ft = 30.48 cm)

### Note

You can not set the distance of subwoofer speaker.

## Test

Press SELECT/ENTER to test the signals of each speaker. Adjust the volume to match the volume of test signals memorized in the system.

- Front Left (L) → Center → Front Right (R) → Rear Right (R) → Rear Left (L)

## Return

Press SELECT/ENTER to return to the previous menu.

## Troubleshooting

Check the following guide for the possible cause of a problem before contacting service.

Symptom	Cause	Correction
No power.	<ul style="list-style-type: none"> <li>The power cord is disconnected.</li> </ul>	<ul style="list-style-type: none"> <li>Plug the power cord into the wall outlet securely.</li> </ul>
The power is on, but the DVD player does not work.	<ul style="list-style-type: none"> <li>No disc is inserted.</li> </ul>	<ul style="list-style-type: none"> <li>Insert a disc. (Check that the DVD or, audio CD indicator in the display window is lit.)</li> </ul>
No picture.	<ul style="list-style-type: none"> <li>The TV is not set to receive DVD signal output.</li> </ul>	<ul style="list-style-type: none"> <li>Select the appropriate video input mode on the TV so the picture from the DVD player appears on the TV screen.</li> </ul>
	<ul style="list-style-type: none"> <li>The video cable is not connected securely.</li> </ul>	<ul style="list-style-type: none"> <li>Connect the video cable securely.</li> </ul>
	<ul style="list-style-type: none"> <li>The connected TV power is turned off.</li> </ul>	<ul style="list-style-type: none"> <li>Turn on the TV.</li> </ul>
No sound./Buzzing sounds.	<ul style="list-style-type: none"> <li>The equipment connected with the audio cable is not set to receive DVD signal output.</li> </ul>	<ul style="list-style-type: none"> <li>Select the correct input mode of the audio receiver so you can listen to the sound from the DVD player.</li> </ul>
	<ul style="list-style-type: none"> <li>The audio cables are not connected securely.</li> </ul>	<ul style="list-style-type: none"> <li>Connect the audio cable securely.</li> </ul>
	<ul style="list-style-type: none"> <li>The power of the equipment connected with the audio cable is turned off.</li> </ul>	<ul style="list-style-type: none"> <li>Turn on the equipment connected with the audio cable.</li> </ul>
	<ul style="list-style-type: none"> <li>The Digital Audio Output is set to the wrong selection.</li> </ul>	<ul style="list-style-type: none"> <li>Press Setup on the remote control. Move the cursor down to Digital Audio Output. Press the right cursor. Select the correct output desired. Press ENTER. To get DTS sounds, "Bit Stream/PCM" has to be selected. And use the Digital Output or Optical Out jack. Note that there will be no outputs at 6 ch analog outputs of this set for DTS selection. Next select the appropriate sampling frequency. If your equipment cannot receive 98 KHz, please select 48 KHz or else buzzing sounds will be heard.</li> </ul>
The playback picture is poor.	<ul style="list-style-type: none"> <li>The disc is dirty.</li> </ul>	<ul style="list-style-type: none"> <li>Clean the disc.</li> </ul>
The DVD player does not start playback.	<ul style="list-style-type: none"> <li>No disc is inserted.</li> </ul>	<ul style="list-style-type: none"> <li>Insert a disc. (Check that the DVD, or audio CD indicator in the DVD display is lit.)</li> </ul>
	<ul style="list-style-type: none"> <li>An unplayable disc is inserted.</li> </ul>	<ul style="list-style-type: none"> <li>Insert a playable disc. (Check the disc type, color system, and Regional code.)</li> </ul>
	<ul style="list-style-type: none"> <li>The disc is placed upside down.</li> </ul>	<ul style="list-style-type: none"> <li>Place the disc with the playback side down.</li> </ul>
	<ul style="list-style-type: none"> <li>The disc is not placed within the guide.</li> </ul>	<ul style="list-style-type: none"> <li>Place the disc on the disc tray correctly inside the guide.</li> </ul>
	<ul style="list-style-type: none"> <li>The disc is dirty.</li> </ul>	<ul style="list-style-type: none"> <li>Clean the disc.</li> </ul>
	<ul style="list-style-type: none"> <li>The Rating level is set.</li> </ul>	<ul style="list-style-type: none"> <li>Cancel the Rating function or change the rating level.</li> </ul>
The remote control does not work properly.	<ul style="list-style-type: none"> <li>The remote control is not pointed at the remote sensor of the DVD player.</li> </ul>	<ul style="list-style-type: none"> <li>Point the remote control at the remote sensor of the DVD player.</li> </ul>
	<ul style="list-style-type: none"> <li>The remote control is too far from the DVD player.</li> </ul>	<ul style="list-style-type: none"> <li>Operate the remote control within 23 ft (7 m).</li> </ul>
	<ul style="list-style-type: none"> <li>There is an obstacle in the path of the remote control and the DVD player.</li> </ul>	<ul style="list-style-type: none"> <li>Remove the obstacle.</li> </ul>
	<ul style="list-style-type: none"> <li>The batteries in the remote control are exhausted.</li> </ul>	<ul style="list-style-type: none"> <li>Replace the batteries with new ones.</li> </ul>

## Language Code List

Enter the appropriate code number for the initial settings “Disc Audio”, “Disc Subtitle” and/or “Disc Menu” (See page 14).

Code	Language	Code	Language	Code	Language	Code	Language
6566	Abkhazian	7074	Fiji	7678	Lingala	8373	Singhalese
6565	Afar	7073	Finnish	7684	Lithuanian	8375	Slovak
6570	Afrikaans	7082	French	7775	Macedonian	8376	Slovenian
8381	Albanian	7089	Frisian	7771	Malagasy	8379	Somali
6577	Ameharic	7176	Galician	7783	Malay	6983	Spanish
6582	Arabic	7565	Georgian	7776	Malayalam	8385	Sudanese
7289	Armenian	6869	German	7784	Maltese	8387	Swahili
6583	Assamese	6976	Greek	7773	Maori	8386	Swedish
6588	Aymara	7576	Greenlandic	7782	Marathi	8476	Tagalog
6590	Azerbaijani	7178	Guarani	7779	Moldavian	8471	Tajik
6665	Bashkir	7185	Gujarati	7778	Mongolian	8465	Tamil
6985	Basque	7265	Hausa	7865	Nauru	8484	Tatar
6678	Bengali; Bangla	7387	Hebrew	7869	Nepali	8469	Telugu
6890	Bhutani	7273	Hindi	7879	Norwegian	8472	Thai
6672	Bihari	7285	Hungarian	7982	Oriya	6679	Tibetan
6682	Breton	7383	Icelandic	8065	Panjabi	8473	Tigrinya
6671	Bulgarian	7378	Indonesian	8083	Pashto, Pushto	8479	Tonga
7789	Burmese	7365	Interlingua	7065	Persian	8482	Turkish
6669	Byelorussian	7165	Irish	8076	Polish	8475	Turkmen
7577	Cambodian	7384	Italian	8084	Portuguese	8487	Twi
6765	Catalan	7465	Japanese	8185	Quechua	8575	Ukrainian
9072	Chinese	7487	Javanese	8277	Rhaeto-Romance	8582	Urdu
6779	Corsican	7578	Kannada	8279	Rumanian	8590	Uzbek
7282	Croatian	7583	Kashmiri	8285	Russian	8673	Vietnamese
6783	Czech	7575	Kazakh	8377	Samoan	8679	Volapük
6865	Danish	7589	Kirghiz	8365	Sanskrit	6789	Welsh
7876	Dutch	7579	Korean	7168	Scots Gaelic	8779	Wolof
6978	English	7585	Kurdish	8382	Serbian	8872	Xhosa
6979	Esperanto	7679	Laothian	8372	Serbo-Croatian	7473	Yiddish
6984	Estonian	7665	Latin	8378	Shona	8979	Yoruba
7079	Faroese	7686	Latvian, Lettish	8368	Sindhi	9085	Zulu

## Area Code List

Enter the appropriate code number for the initial setting "Area Code" (See page 17).

Code	Area	Code	Area	Code	Area	Code	Area
AD	Andorra	ER	Eritrea	LC	Saint Lucia	SC	Seychelles
AE	United Arab Emirates	ES	Spain	LI	Liechtenstein	SD	Sudan
AF	Afghanistan	ET	Ethiopia	LK	Sri Lanka	SE	Sweden
AG	Antigua and Barbuda	FI	Finland	LR	Liberia	SG	Singapore
AI	Anguilla	FJ	Fiji	LS	Lesotho	SH	Saint Helena
AL	Albania	FK	Falkland Islands	LT	Lithuania	SI	Slovenia
AM	Armenia	FM	Micronesia	LU	Luxembourg	SJ	Svalbard and Jan Mayen Islands
AN	Netherlands Antilles	FO	Faroe Islands	LV	Latvia	SK	Slovak Republic
AO	Angola	FR	France	LY	Libya	SL	Sierra Leone
AQ	Antarctica	FX	France (European Territory)	MA	Morocco	SM	San Marino
AR	Argentina	GA	Gabon	MD	Moldavia	SN	Senegal
AS	American Samoa	GB	Great Britain	MG	Madagascar	SO	Somalia
AT	Austria	GD	Grenada	MH	Marshall Islands	SR	Suriname
AU	Australia	GE	Georgia	MK	Macedonia	ST	Saint Tome and Principe
AW	Aruba	GF	French Guyana	ML	Mali	SU	Former USSR
AZ	Azerbaijan	GH	Ghana	MM	Myanmar	SV	El Salvador
BA	Bosnia-Herzegovina	GI	Gibraltar	MN	Mongolia	SY	Syria
BB	Barbados	GL	Greenland	MO	Macau	SZ	Swaziland
BD	Bangladesh	GM	Gambia	MP	Northern Mariana Islands	TC	Turks and Caicos Islands
BE	Belgium	GN	Guinea	MQ	Martinique (French)	TD	Chad
BF	Burkina Faso	GP	Guadeloupe (French)	MR	Mauritania	TF	French Southern Territories
BG	Bulgaria	GQ	Equatorial Guinea	MS	Montserrat	TG	Togo
BH	Bahrain	GR	Greece	MT	Malta	TH	Thailand
BI	Burundi	GS	S. Georgia & S. Sandwich Isls.	MU	Mauritius	TJ	Tadjikistan
BJ	Benin	GT	Guatemala	MV	Maldives	TK	Tokelau
BM	Bermuda	GU	Guam (USA)	MW	Malawi	TM	Turkmenistan
BN	Brunei Darussalam	GU	Guam (USA)	MX	Mexico	TN	Tunisia
BO	Bolivia	GW	Guinea Bissau	MY	Malaysia	TO	Tonga
BR	Brazil	GY	Guyana	MZ	Mozambique	TP	East Timor
BS	Bahamas	HK	Hong Kong	NA	Namibia	TR	Turkey
BT	Bhutan	HM	Heard and McDonald Islands	NC	New Caledonia (French)	TT	Trinidad and Tobago
BV	Bouvet Island	HN	Honduras	NE	Niger	TV	Tuvalu
BW	Botswana	HR	Croatia	NF	Norfolk Island	TW	Taiwan
BY	Belarus	HT	Haiti	NG	Nigeria	TZ	Tanzania
BZ	Belize	HU	Hungary	NI	Nicaragua	UA	Ukraine
CA	Canada	ID	Indonesia	NL	Netherlands	UG	Uganda
CC	Cocos (Keeling) Islands	IE	Ireland	NO	Norway	UK	United Kingdom
CF	Central African Republic	IL	Israel	NP	Nepal	UM	USA Minor Outlying Islands
CG	Congo	IN	India	NR	Nauru	US	United States
CH	Switzerland	IO	British Indian Ocean Territory	NU	Niue	UY	Uruguay
CI	Ivory Coast	IQ	Iraq	NZ	New Zealand	UZ	Uzbekistan
CK	Cook Islands	IR	Iran	OM	Oman	VA	Vatican City State
CL	Chile	IS	Iceland	PA	Panama	VC	Saint Vincent & Grenadines
CM	Cameroon	IT	Italy	PE	Peru	VE	Venezuela
CN	China	JM	Jamaica	PF	Polynesia (French)	VG	Virgin Islands (British)
CO	Colombia	JO	Jordan	PG	Papua New Guinea	VI	Virgin Islands (USA)
CR	Costa Rica	JP	Japan	PH	Philippines	VN	Vietnam
CS	Former Czechoslovakia	KE	Kenya	PK	Pakistan	VU	Vanuatu
CU	Cuba	KG	Kyrgyzstan	PL	Poland	WF	Wallis and Futuna Islands
CV	Cape Verde	KH	Cambodia	PM	Saint Pierre and Miquelon	WS	Samoa
CX	Christmas Island	KI	Kiribati	PN	Pitcairn Island	YE	Yemen
CY	Cyprus	KM	Comoros	PR	Puerto Rico	YT	Mayotte
CZ	Czech Republic	KN	Saint Kitts & Nevis Anguilla	PT	Portugal	YU	Yugoslavia
DE	Germany	KP	North Korea	PW	Palau	ZA	South Africa
DJ	Djibouti	KR	South Korea	PY	Paraguay	ZM	Zambia
DK	Denmark	KW	Kuwait	QA	Qatar	ZR	Zaire
DM	Dominica	KY	Cayman Islands	RE	Reunion (French)	ZW	Zimbabwe
DO	Dominican Republic	KZ	Kazakhstan	RO	Romania		
DZ	Algeria	LA	Laos	RU	Russian Federation		
EC	Ecuador	LB	Lebanon	RW	Rwanda		
EE	Estonia			SA	Saudi Arabia		
EG	Egypt			SB	Solomon Islands		
EH	Western Sahara						



# Specifications

## General

Power requirements	AC 120V, 60 Hz
Power consumption	14W
Dimensions (approx.)	430 X 60 X 242 mm (16.9 x 2.4 x 9.5 inches) (w x h x d)
Mass (approx.)	2.4 kg (5.3 lbs)
Operating temperature	5°C to 35°C (41°F to 95°F)
Operating humidity	5 % to 90 %

## System

Laser	Semiconductor laser, wavelength 650 nm
Signal system	NTSC
Frequency response	DVD (PCM 96 kHz): 8 Hz to 44 kHz DVD (PCM 48 kHz): 8 Hz to 22 kHz CD: 8 Hz to 20 kHz
Signal-to-noise ratio	More than 100dB (ANALOG OUT connectors only)
Harmonic distortion	Less than 0.008%
Dynamic range	More than 100 dB (DVD) More than 95 dB (CD)

## Outputs

VIDEO OUT	1 Vp-p 75 Ω, sync negative, RCA jack x 1
S-VIDEO OUT	(Y) 1.0 V (p-p), 75 Ω, negative sync, Mini DIN 4-pin x 1 (C) 0.3 V (p-p) 75 Ω
COMPONENT VIDEO OUT	(Y) 1.0 V (p-p), 75 Ω, negative sync, RCA jack x 1 (Pb)/(Pr) 0.7 V (p-p), 75 Ω, RCA jack x 2
Audio output (digital audio)	0.5 V (p-p), 75 Ω, RCA jack x 1
Audio output (optical audio)	5 V (p-p), 75 Ω, Optical connector x 1
Audio output (analog audio)	2.0 Vrms (1 KHz, 0 dB), 600 Ω, RCA jack (L, R) x 1

## Accessory

Video cable . . . . .	1
Audio cable . . . . .	1
Remote control . . . . .	1
Batteries . . . . .	2

- Design and specifications are subject to change without notice.

Manufactured under license from Dolby Laboratories. Dolby, MLP Lossless and the double-D symbol are trademarks of Dolby Laboratories. Confidential unpublished works. Copyright 1992-1997 Dolby Laboratories. All rights reserved.

DTS and DTS Digital Out are trademarks of Digital Theater Systems, Inc.

## LIMITED WARRANTY DVD VIDEO PLAYER

Toshiba America Consumer Products, Inc. ("TACP") and Toshiba Hawaii, Inc. ("THI") make the following limited warranties to original consumers for DVD Players purchased and used in the United States. THESE LIMITED WARRANTIES EXTEND TO THE ORIGINAL CONSUMER PURCHASER OR ANY PERSON RECEIVING THIS DVD PLAYER AS A GIFT FROM THE ORIGINAL CONSUMER PURCHASER AND TO NO OTHER PURCHASER OR TRANSFEREE.

PRODUCTS PURCHASED IN THE U.S.A. AND USED IN CANADA ARE NOT COVERED BY THESE WARRANTIES.

PRODUCTS PURCHASED IN CANADA AND USED IN THE U.S.A. ARE NOT COVERED BY THESE WARRANTIES.

### Limited One (1) Year Warranty\*

TACP/THI warrants this DVD Player against defects in materials or workmanship for a period of one (1) year after the date of the original retail purchase. DURING THIS PERIOD TACP/THI WILL, AT TACP/THI'S OPTION, REPAIR OR EXCHANGE A DEFECTIVE DVD PLAYER WITH A NEW OR REFURBISHED DVD PLAYER, AT TACP/THI'S OPTION. DURING THE INITIAL NINETY (90) DAYS, THIS REPAIR OR EXCHANGE WILL BE WITHOUT CHARGE TO YOU, EXCEPT YOU MUST PAY FOR ALL TRANSPORTATION AND INSURANCE CHARGES FOR THE DVD PLAYER TO BE SHIPPED TO THE DESIGNATED TACP/THI FACILITY. AFTER THE INITIAL NINETY (90) DAYS AND FOR THE REMAINDER OF THE WARRANTY PERIOD, AN ADDITIONAL HANDLING FEE WILL APPLY. YOU MUST DELIVER THE ENTIRE DVD PLAYER AND ALL ACCESSORIES (SUCH AS POWER CORDS, CABLES, AND THE UNIT'S REMOTE CONTROL DEVICE) TO THE DESIGNATED TACP/THI FACILITY, AS INSTRUCTED BY TACP/THI. TACP/THI IS NOT RESPONSIBLE IF YOUR DVD PLAYER IS LOST OR DAMAGED DURING SHIPMENT.

### \*Commercial Units

DVD Players sold and used for commercial purposes have a limited ninety (90) day warranty.

### Rental Units

The warranty period for rental units begins with the first rental or thirty (30) days from the date of shipment to the rental firm, whichever comes first.

### Owner's Manual and Demographic Card

You should read this owner's manual thoroughly before operating this DVD Player. You should complete and mail the enclosed Demographic Card within ten days after you, or the person who has given you this product as a gift, purchased this DVD Player. This is one way to enable TACP/THI to provide you with better customer service and improved products. Failure to return the Demographic Card will not affect your rights under this warranty.

### Your Responsibility

THE ABOVE LIMITED WARRANTIES ARE SUBJECT TO THE FOLLOWING CONDITIONS:

- (1) You must provide your bill of sale or other proof of purchase. For rental firms, proof of first rental is also required.
- (2) The limited warranties from TACP and THI are effective only if the DVD Player is purchased and operated in the U.S.A. or Puerto Rico.
- (3) Labor service charges for installation, set up, and adjustment of customer controls are not covered by these limited warranties.
- (4) These limited warranties extend only to defects in materials or workmanship as limited above and do not extend to any DVD Player or accessories which have been lost or discarded by you, or to damage to any DVD Player or accessories caused by misuse, accident, Acts of God (such as lightning), or to fluctuations in electric power, improper installation, improper maintenance or use in violation of instructions furnished by TACP/THI; or to units which have been modified or which have had the serial number removed, altered, defaced or rendered illegible.
- (5) Physically damaged DVD Players are not acceptable for repair or exchange whether in or out of warranty and will be returned as received.

### How to Obtain Warranty Services

If, after following all of the operating instructions in this manual and checking the "Troubleshooting" section, you find that service is needed, call one of the following Customer Solutions Centers to obtain further instructions. Have your proof of purchase and your model and serial numbers available when you call.

For DVD Players purchased in the United States, except Hawaii, call TACP, toll free at **1-866-583-7353**.

For DVD Players purchased in Hawaii, call THI. at **808-591-9281**.

For additional updates, visit TACP's web site:  
[www.toshiba.com/tacp](http://www.toshiba.com/tacp).

## LIMITED WARRANTY DVD VIDEO PLAYER (Continued)

### LIMITATION OF IMPLIED WARRANTIES

ALL WARRANTIES IMPLIED BY THE LAW OF ANY STATE OF THE U.S.A., INCLUDING THE IMPLIED WARRANTIES OF MERCHANTABILITY AND FITNESS FOR A PARTICULAR PURPOSE, ARE EXPRESSLY LIMITED TO THE DURATION OF THE LIMITED WARRANTIES SET FORTH ABOVE.

### LIMITATION OF WARRANTY

WITH THE EXCEPTION OF ANY WARRANTIES IMPLIED BY THE LAW OF ANY STATE OF THE U.S.A. AS HEREBY LIMITED, THE FOREGOING LIMITED WARRANTY IS EXCLUSIVE AND IN LIEU OF ALL OTHER WARRANTIES, GUARANTEES, AGREEMENTS AND SIMILAR OBLIGATIONS OF TACP OR THI WITH RESPECT TO YOUR DVD PLAYER.

### EXCLUSION OF DAMAGES

IN NO EVENT SHALL TACP OR THI BE LIABLE FOR CONSEQUENTIAL OR INCIDENTAL DAMAGES.

### No Change, Modification, or Extension

No person, agent, distributor, dealer or company is authorized to change, modify or extend the terms of these limited warranties in any manner whatsoever.

### Time for Taking Action

The time within which action must be commenced to enforce any obligation of TACP or THI arising under this limited warranty or under any law of the United States or of any state thereof is hereby limited to 90 days from the date you discovered, or should have discovered, the defect. This limitation does not apply to implied warranties arising under the law of any state of the U.S.A.

### HOW STATE LAW RELATES TO WARRANTY

THIS WARRANTY GIVES YOU SPECIFIC LEGAL RIGHTS, AND YOU MAY ALSO HAVE OTHER RIGHTS WHICH MAY VARY FROM STATE TO STATE IN THE U.S.A.

SOME STATES OF THE U.S.A. DO NOT ALLOW LIMITATIONS ON HOW LONG AN IMPLIED WARRANTY LASTS, WHEN AN ACTION MAY BE BROUGHT, OR THE EXCLUSION OR LIMITATION OF INCIDENTAL OR CONSEQUENTIAL DAMAGES, SO THE ABOVE LIMITATIONS OR EXCLUSIONS MAY NOT APPLY TO YOU UNDER SUCH CIRCUMSTANCES.

OTHERS

### ATTENTION CANADIAN CONSUMERS:

Canadian consumers are requested to complete the special Canadian "Warranty Registration Form" enclosed, and forward this completed form with a copy of bill of sale to TOSHIBA OF CANADA to "Register and Validate" their warranty. Product must be purchased from an Authorized Canadian Dealer. Products purchased in the U.S.A. and used in Canada are not covered by these warranties.

#### Contact: Toshiba of Canada Limited

Consumer Electronics Group  
191 McNabb Street  
Markham, Ontario L3R 8H2  
(905)-470-5400

Consumer Electronics Group  
22171 Fraserwood Way  
Richmond, B.C. V6W 1J5  
(604)-303-2500

Consumer Electronics Group  
1643 North Service Road  
Droval, QC H9P 1J1  
(514)-856-4100

### IMPORTANT: PACKING AND SHIPPING INSTRUCTION

When you send the product to a Service Station, you must use the original carton box and packing material, then insert the original carton box containing the unit into another carton using more packing material.

# PRODUCT SAFETY SERVICING GUIDELINES FOR VIDEO PRODUCTS

**CAUTION :** DO NOT ATTEMPT TO MODIFY THIS PRODUCT IN ANY WAY. NEVER PERFORM CUSTOMIZED INSTALLATIONS WITHOUT MANUFACTURER'S APPROVAL. UNAUTHORIZED MODIFICATIONS WILL NOT ONLY VOID THE WARRANTY, BUT MAY LEAD TO YOUR BEING LIABLE FOR ANY RESULTING PROPERTY DAMAGE OR USER INJURY.

SERVICE WORK SHOULD BE PERFORMED ONLY AFTER YOU ARE THOROUGHLY FAMILIAR WITH ALL OF THE FOLLOWING SAFETY CHECKS AND SERVICING GUIDELINES. TO DO OTHERWISE, INCREASES THE RISK OF POTENTIAL HAZARDS AND INJURY TO THE USER.

WHILE SERVICING, USE AN ISOLATION TRANSFORMER FOR PROTECTION FROM A.C. LINE SHOCK.

## SAFETY CHECKS

AFTER THE ORIGINAL SERVICE PROBLEM HAS BEEN CORRECTED, A CHECK SHOULD BE MADE OF THE FOLLOWING.

### SUBJECT : FIRE & SHOCK HAZARD

1. BE SURE THAT ALL COMPONENTS ARE POSITIONED IN SUCH A WAY AS TO AVOID POSSIBILITY OF ADJACENT COMPONENT SHORTS. THIS IS ESPECIALLY IMPORTANT ON THOSE MODULES WHICH ARE TRANSPORTED TO AND FROM THE REPAIR SHOP.
2. NEVER RELEASE A REPAIR UNLESS ALL PROTECTIVE DEVICES SUCH AS INSULATORS, BARRIERS, COVERS, SHIELDS, STRAIN RELIEFS, POWER SUPPLY CORDS, AND OTHER HARDWARE HAVE BEEN REINSTALLED PER ORIGINAL DESIGN. BE SURE THAT THE SAFETY PURPOSE OF THE POLARIZED LINE PLUG HAS NOT BEEN DEFEATED.
3. SOLDERING MUST BE INSPECTED TO DISCOVER POSSIBLE COLD SOLDER JOINTS, SOLDER SPLASHES OR SHARP SOLDER POINTS. BE CERTAIN TO REMOVE ALL LOOSE FOREIGN PARTICLES.
4. CHECK FOR PHYSICAL EVIDENCE OF DAMAGE OR DETERIORATION TO PARTS AND COMPONENTS. FOR FRAYED LEADS, DAMAGED INSULATION (INCLUDING A.C. CORD), AND REPLACE IF NECESSARY FOLLOW ORIGINAL LAYOUT, LEAD LENGTH AND DRESS.
5. NO LEAD OR COMPONENT SHOULD TOUCH A RECEIVING TUBE OR A RESISTOR RATED AT 1 WATT OR MORE. LEAD TENSION AROUND PROTRUDING METAL SURFACES MUST BE AVOIDED.
6. ALL CRITICAL COMPONENTS SUCH AS FUSES, FLAMEPROOF RESISTORS, CAPACITORS, ETC. MUST BE REPLACED WITH EXACT FACTORY TYPES, DO NOT USE REPLACEMENT COMPONENTS OTHER THAN THOSE SPECIFIED OR MAKE UNRECOMMENDED CIRCUIT MODIFICATIONS.
7. AFTER RE-ASSEMBLY OF THE SET ALWAYS PERFORM AN A.C. LEAKAGE TEST ON ALL EXPOSED METALLIC PARTS OF THE CABINET, (THE CHANNEL SELECTOR KNOB, ANTENNA TERMINALS, HANDLE AND SCREWS) TO BE SURE THE SET IS SAFE TO OPERATE WITHOUT DANGER OF ELECTRICAL SHOCK. DO NOT USE A LINE ISOLATION TRANSFORMER DURING THIS TEST USE AN A.C. VOLT-METER, HAVING 5000 OHMS PER VOLT OR MORE SENSITIVITY, IN THE FOLLOWING MANNER; CONNECT A 1500 OHM 10 WATT RESISTOR, PARALLELED BY A .15 MFD. 150.V A.C TYPE CAPACITOR BETWEEN A KNOWN GOOD EARTH GROUND (WATER PIPE, CONDUIT, ETC.) AND THE EXPOSED METALLIC PARTS, ONE AT A TIME. MEASURE THE A.C. VOLTAGE ACROSS THE COMBINATION OF 1500 OHM RESISTOR AND .15 MFD CAPACITOR. REVERSE THE A.C. PLUG AND REPEAT A.C. VOLTAGE MEASUREMENTS FOR EACH EXPOSED METALLIC PART. VOLTAGE MEASURED MUST NOT EXCEED 75 VOLTS R.M.S. THIS CORRESPONDS TO 0.5 MILLIAMPS A.C ANY VALUE EXCEEDING THIS LIMIT CONSTITUTES A POTENTIAL SHOCK HAZARD AND MUST BE CORRECTED IMMEDIATELY.

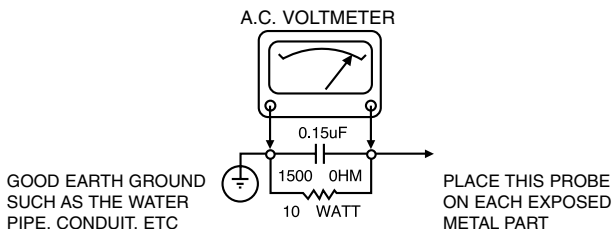

### SUBJECT: GRAPHIC SYMBOLS



THE LIGHTNING FLASH WITH ARROWHEAD SYMBOL, WITHIN AN EQUILATERAL TRIANGLE, IS INTENDED TO ALERT THE SERVICE PERSONNEL TO THE PRESENCE OF UNINSULATED "DANGEROUS VOLTAGE" THAT MAY BE OF SUFFICIENT MAGNITUDE TO CONSTITUTE A RISK OF ELECTRIC SHOCK.



THE EXCLAMATION POINT WITHIN AN EQUILATERAL TRIANGLE IS INTENDED TO ALERT THE SERVICE PERSONNEL TO THE PRESENCE OF IMPORTANT SAFETY INFORMATION IN SERVICE LITERATURE.

### SUBJECT : X-RADIATION

1. BE SURE PROCEDURES AND INSTRUCTIONS TO ALL SERVICE PERSONNEL COVER THE SUBJECT OF X-RADIATION. THE ONLY POTENTIAL SOURCE OF X-RAYS IN CURRENT T.V. RECEIVERS IS THE PICTURE TUBE. HOWEVER, THIS TUBE DOES NOT EMIT X-RAYS WHEN THE HIGH VOLTAGE IS AT THE FACTORY SPECIFIED LEVEL. THE PROPER VALUE IS GIVEN IN THE APPLICABLE SCHEMATIC. OPERATION AT HIGHER VOLTAGES MAY CAUSE A FAILURE OF THE PICTURE TUBE OR HIGH VOLTAGE SUPPLY AND, UNDER CERTAIN CIRCUMSTANCES, MAY PRODUCE RADIATION IN EXCESS OF DESIRABLE LEVELS.
2. ONLY FACTORY SPECIFIED C.R.T. ANODE CONNECTORS MUST BE USED. DEGAUSSING SHIELDS ALSO SERVE AS X-RAY SHIELD IN COLOR SETS, ALWAYS RE-INSTALL THEM.
3. IT IS ESSENTIAL THAT SERVICE PERSONNEL HAVE AVAILABLE AN ACCURATE AND RELIABLE HIGH VOLTAGE METER. THE CALIBRATION OF THE METER SHOULD BE CHECKED PERIODICALLY AGAINST A REFERENCE STANDARD, SUCH AS THE ONE AVAILABLE AT YOUR DISTRIBUTOR.
4. WHEN THE HIGH VOLTAGE CIRCUITRY IS OPERATING PROPERLY THERE IS NO POSSIBILITY OF AN X-RADIATION PROBLEM. EVERY TIME A COLOR CHASSIS IS SERVICED, THE BRIGHTNESS SHOULD BE RUN UP AND DOWN WHILE MONITORING THE HIGH VOLTAGE WITH A METER TO BE CERTAIN THAT THE HIGH VOLTAGE DOES NOT EXCEED THE SPECIFIED VALUE AND THAT IT IS REGULATING CORRECTLY. WE SUGGEST THAT YOU AND YOUR SERVICE ORGANIZATION REVIEW TEST PROCEDURES SO THAT VOLTAGE REGULATION IS ALWAYS CHECKED AS A STANDARD SERVICING PROCEDURE. AND THAT THE HIGH VOLTAGE READING BE RECORDED ON EACH CUSTOMER'S INVOICE.
5. WHEN TROUBLESHOOTING AND MAKING TEST MEASUREMENTS IN A PRODUCT WITH A PROBLEM OF EXCESSIVE HIGH VOLTAGE, AVOID BEING UNNECESSARILY CLOSE TO THE PICTURE TUBE AND THE HIGH VOLTAGE SUPPLY. DO NOT OPERATE THE PRODUCT LONGER THAN IS NECESSARY TO LOCATE THE CAUSE OF EXCESSIVE VOLTAGE.
6. REFER TO HV, B+ AND SHUTDOWN ADJUSTMENT PROCEDURES DESCRIBED IN THE APPROPRIATE SCHEMATIC AND DIAGRAMS (WHERE USED).

### SUBJECT: IMPLOSION

1. ALL DIRECT VIEWED PICTURE TUBES ARE EQUIPPED WITH AN INTEGRAL IMPLOSION PROTECTION SYSTEM, BUT CARE SHOULD BE TAKEN TO AVOID DAMAGE DURING INSTALLATION, AVOID SCRATCHING THE TUBE. IF SCRATCHED REPLACE IT.
2. USE ONLY RECOMMENDED FACTORY REPLACEMENT TUBES.

### SUBJECT : TIPS ON PROPER INSTALLATION

1. NEVER INSTALL ANY PRODUCT IN A CLOSED-IN RECESS, CUBBY-HOLE OR CLOSELY FITTING SHELF SPACE. OVER OR CLOSE TO HEAT DUCT, OR IN THE PATH OF HEATED AIR FLOW.
2. AVOID CONDITIONS OF HIGH HUMIDITY SUCH AS: OUTDOOR PATIO INSTALLATIONS WHERE DEW IS A FACTOR, NEAR STEAM RADIATORS WHERE STEAM LEAKAGE IS A FACTOR, ETC.
3. AVOID PALCEMENT WHERE DRAPERIES MAY OBSTRUCT REAR VENTING. THE CUSTOMER SHOULD ALSO AVOID THE USE OF DECORATIVE SCARVES OR OTHER COVERINGS WHICH MIGHT OBSTRUCT VENTILATION.
4. WALL AND SHELF MOUNTED INSTALLATIONS USING A COMMERCIAL MOUNTING KIT. MUST FOLLOW THE FACTORY APPROVED MOUNTING INSTRUCTIONS A PRODUCT MOUNTED TO A SHELF OR PLATFORM MUST RETAIN ITS ORIGINAL FEET (OR THE EQUIVALENT THICKNESS IN SPACERS) TO PROVIDE ADEQUATE AIR FLOW ACROSS THE BOTTOM, BOLTS OR SCREWS USED FOR FASTENERS MUST NOT TOUCH ANY PARTS OR WIRING. PERFORM LEAKAGE TEST ON CUSTOMIZED INSTALLATIONS.
5. CAUTION CUSTOMERS AGAINST THE MOUNTING OF A PRODUCT ON SLOPING SHELF OR A TILTED POSITION, UNLESS THE PRODUCT IS PROPERLY SECURED.
6. A PRODUCT ON A ROLL-ABOUT CART SHOULD BE STABLE ON ITS MOUNTING TO THE CART. CAUTION THE CUSTOMER ON THE HAZARDS OF TRYING TO ROLL A CART WITH SMALL CASTERS ACROSS THRESHOLDS OR DEEP PILE CARPETS.
7. CAUTION CUSTOMERS AGAINST THE USE OF A CART OR STAND WHICH HAS NOT BEEN LISTED BY UNDERWRITERS LABORATORIES, INC. FOR USE WITH THEIR SPECIFIC MODEL OF TELEVISION RECEIVER OR GENERALLY APPROVED FOR USE WITH T.V.'S OF THE SAME OR LARGER SCREEN SIZE.
8. CAUTION CUSTOMERS AGAINST THE USE OF EXTENSION CORDS, EXPLAIN THAT A FOREST OF EXTENSIONS SPROUTING FROM A SINGLE OUTLET CAN LEAD TO DISASTROUS CONSEQUENCES TO HOME AND FAMILY.

# SERVICING PRECAUTIONS

**CAUTION :** Before servicing the DVD covered by this service data and its supplements and addends, read and follow the **SAFETY PRECAUTIONS**. **NOTE :** if unforeseen circumstances create conflict between the following servicing precautions and any of the safety precautions in this publication, always follow the safety precautions.

*Remembers Safety First:*

## General Servicing Precautions

1. Always unplug the DVD AC power cord from the AC power source before:
  - (1) Removing or reinstalling any component, circuit board, module, or any other assembly.
  - (2) Disconnection or reconnecting any internal electrical plug or other electrical connection.
  - (3) Connecting a test substitute in parallel with an electrolytic capacitor.  
**Caution :** A wrong part substitution or incorrect polarity installation of electrolytic capacitors may result in an explosion hazard.
2. Do not spray chemicals on or near this DVD or any of its assemblies.
3. Unless specified otherwise in this service data, clean electrical contacts by applying an appropriate contact cleaning solution to the contacts with a pipe cleaner, cotton-tipped swab, or comparable soft applicator. Unless specified otherwise in this service data, lubrication of contacts is not required.
4. Do not defeat any plug/socket B+ voltage interlocks with which instruments covered by this service manual might be equipped.
5. Do not apply AC power to this DVD and/or any of its electrical assemblies unless all solid-state device heat sinks are correctly installed.
6. Always connect test instrument ground lead to the appropriate ground before connection the test instrument positive lead. Always remove the test instrument ground lead last.

## Insulation Checking Procedure

Disconnect the attachment plug from the AC outlet and turn the power on. Connect an insulation resistance meter(500V) to the blades of the attachment plug. The insulation resistance between each blade of the attachment plug and accessible conductive parts (Note 1) should be more than 1M-ohm.

**Note 1 :** Accessible Conductive Parts including Metal panels, Input terminals, Earphone jacks, etc.

## Electrostatically Sensitive (ES) Devices

Some semiconductor (solid state) devices can be damaged easily by static electricity. Such components commonly are called Electrostatically Sensitive (ES) Devices. Examples of typical ES devices are integrated circuits and some field effect transistors and semiconductor chip components.

The following techniques should be used to help reduce the incidence of component damage caused by static electricity.

1. Immediately before handling any semiconductor component or semiconductor-equipped assembly, drain off any electrostatic charge on your body by touching a known earth ground. Alternatively, obtain and wear a commercially available discharging wrist strap device, which should be removed for potential shock reasons prior to applying power to the unit under test.
2. After removing an electrical assembly equipped with ES devices, place the assembly on a conductive surface such as aluminum foil, to prevent electrostatic charge buildup or exposure of the assembly.
3. Use only a grounded-tip soldering iron to solder or unsolder ES devices.
4. Use only an anti-static solder removal device. Some solder removal devices not classified a "anti-static" can generate electrical charges sufficient to damage ES devices.
5. Do not use freon-propelled chemicals. These can generate electrical charge sufficient to damage ES devices.
6. Do not remove a replacement ES device from its protective package until immediately before you are ready to install it. (Most replacement ES devices are packaged with leads electrically shorted together by conductive foam, aluminum foil, or comparable conductive material).
7. Immediately before removing the protective material from the leads of a replacement ES device, touch the protective material to the chassis or circuit assembly into which the device will be installed.

**Caution :** Be sure no power is applied to the chassis or circuit, and observe all other safety precautions.

8. Minimize bodily motions when handling unpackaged replacement ES devices. (Normally harmless motion such as the brushing together of your clothes fabric or the lifting of your foot from a carpeted floor can generate static electricity sufficient to damage an ES device.)

**SECTION 2**  
**CABINET & MAIN CHASSIS**  
**CONTENTS**

<b>1. EXPLODED VIEWS .....</b>	<b>2-2</b>
<b>1. Cabinet and Main Frame Section .....</b>	<b>2-2</b>
<b>2. Packing Accessory Section .....</b>	<b>2-3</b>

# EXPLODED VIEWS

## 1. Cabinet and Main Frame Section

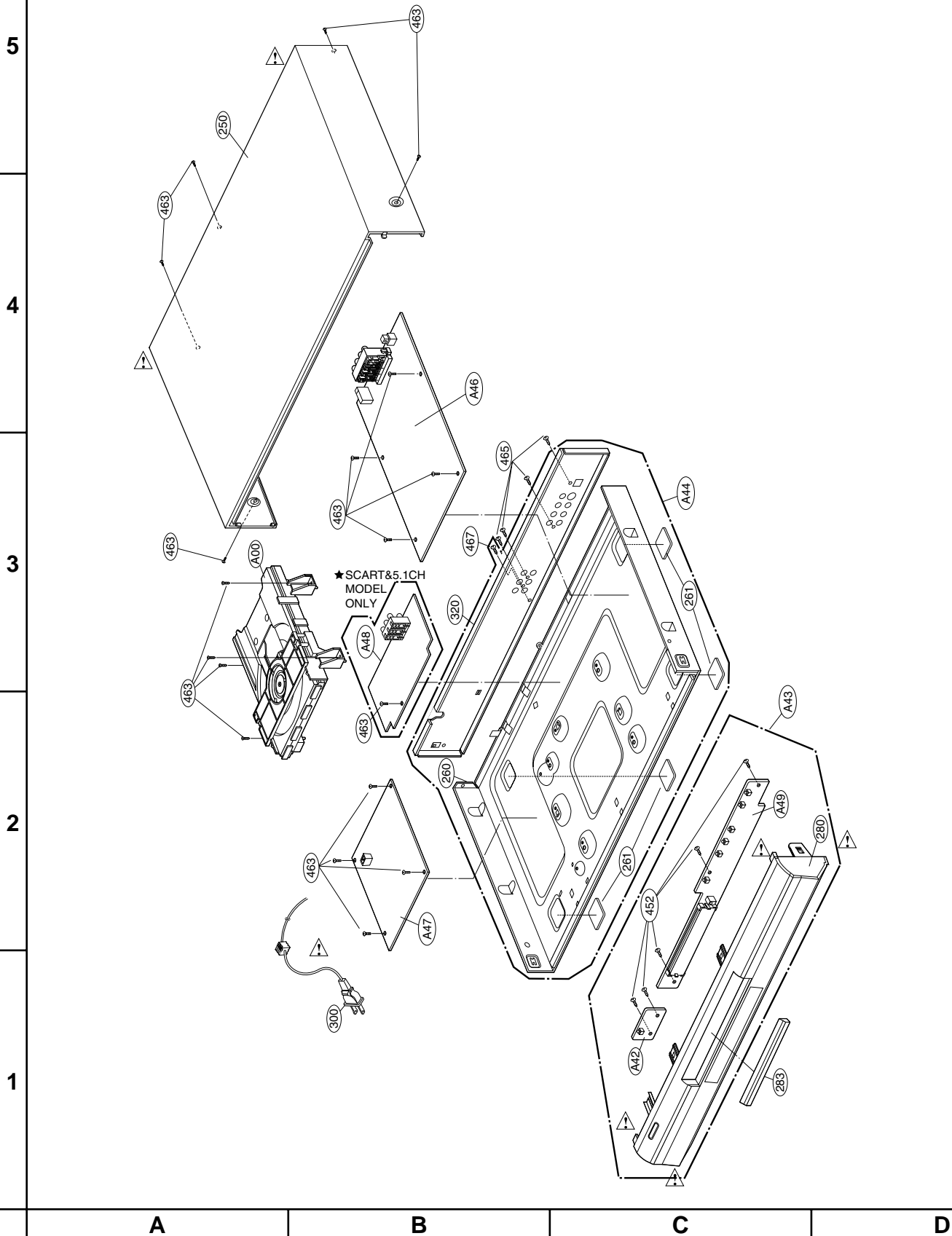

## 2. Packing Accessory Section

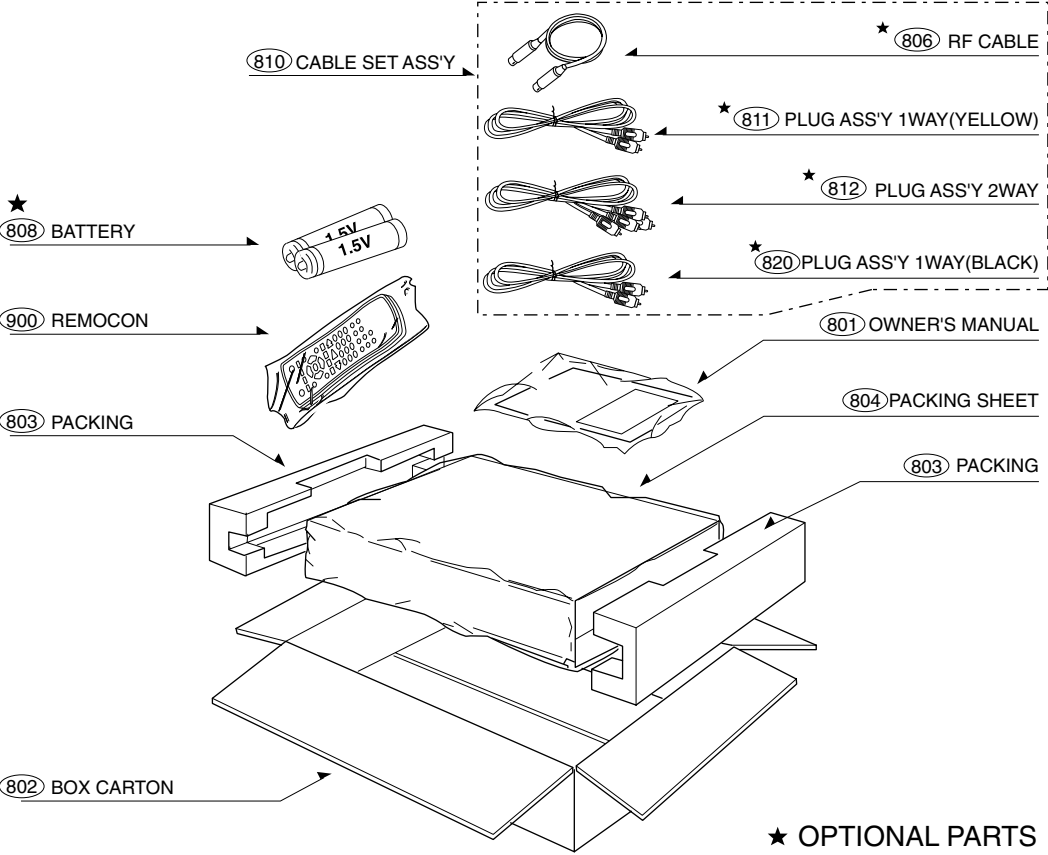



# SECTION 3 ELECTRICAL CONTENTS

<b>ELECTRICAL TROUBLESHOOTING GUIDE.....</b>	<b>3-2</b>
1. Power check flow.....	3-2
2. System operation flow .....	3-3
3. Test & debug flow .....	3-4
<b>DETAILS AND WAVEFORMS ON SYSTEM TEST AND DEBUGGING .....</b>	<b>3-10</b>
1. SYSTEM 27MHz CLOCK,RESET,FLASH R/W SIGNAL .....	3-10
2. SDRAM CLOCK.....	3-12
3. TRAY OPEN/CLOSE SIGNAL .....	3-12
4. SLED CONTROL RELATED SIGNAL (NO DISC CONDITION) .....	3-14
5. LENS CONTROL RELATED SIGNAL(NO DISC CONDITION) .....	3-14
6. LASER POWER CONTROL RELATED SIGNAL(NO DISC CONDITION).....	3-15
7. DISC TYPE JUDGEMENT WAVEFORM .....	3-15
8. FOCUS ON WAVEFORM.....	3-17
9. SPINDLE CONTROL WAVEFORM (NO DISC CONDITION).....	3-18
10. TRACKING CONTROL RELATED SIGNAL(System checking).....	3-19
11. RF WAVEFORM .....	3-20
12. MT1379 AUDIO OPTICAL AND COAXIAL OUTPUT (ASPDIF).....	3-20
13. MT1379 VIDEO OUTPUT WAVEFORM.....	3-21
14. AUDIO OUTPUT FROM AUDIO DAC .....	3-22
<b>BLOCK DIAGRAMS .....</b>	<b>3-24</b>
1. Overall Block Diagram .....	3-24
2. Power(SMPS) Block Diagram .....	3-25
3. SERVO Block Diagram .....	3-26
4. MPEG & MEMORY Block Diagram .....	3-27
5. VIDEO & AUDIO Block Diagram .....	3-28
<b>CIRCUIT DIAGRAMS .....</b>	<b>3-29</b>
1. Power(SMPS) Circuit DIAGRAM.....	3-29
2. SYSTEM Circuit DIAGRAM .....	3-31
3. RF & SERVO Circuit DIAGRAM .....	3-33
4. TIMER, 5.1CH, SCART, KARAOKE Circuit DIAGRAM .....	3-35
5. AV/JACK Circuit DIAGRAM.....	3-37
• CIRCUIT VOLTAGE CHART .....	3-39
<b>PRINTED CIRCUIT DIAGRAMS .....</b>	<b>3-43</b>
1. MAIN P.C.BOARD .....	3-43
2. KEY P.C.BOARD.....	3-45
3. TIMER P.C.BOARD .....	3-45
4. SMPS P.C.BOARD.....	3-47
5. 5.1CH P.C.BOARD.....	3-48

# ELECTRICAL TROUBLESHOOTING GUIDE

## 1. Power check flow

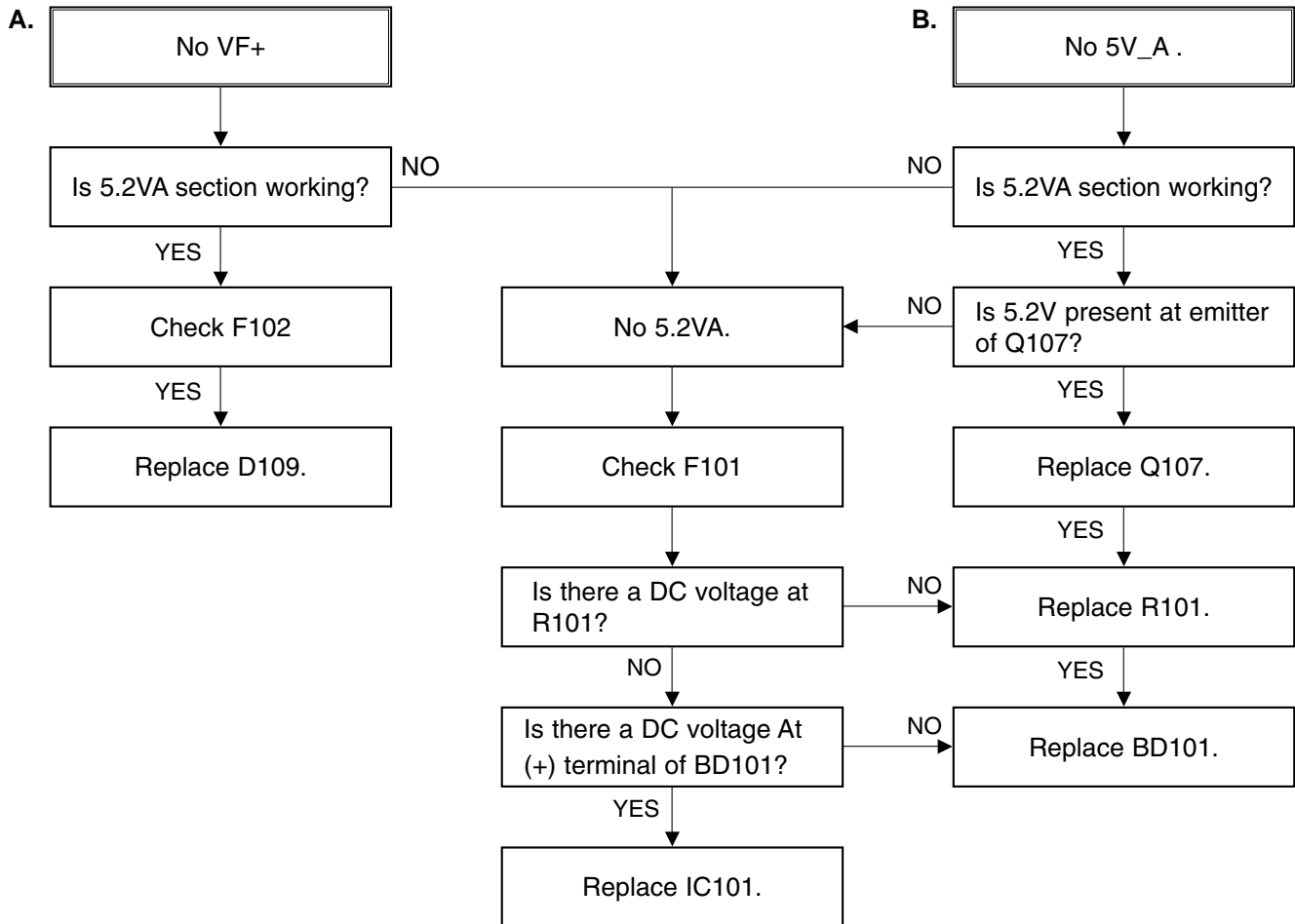

## 2. System operation flow

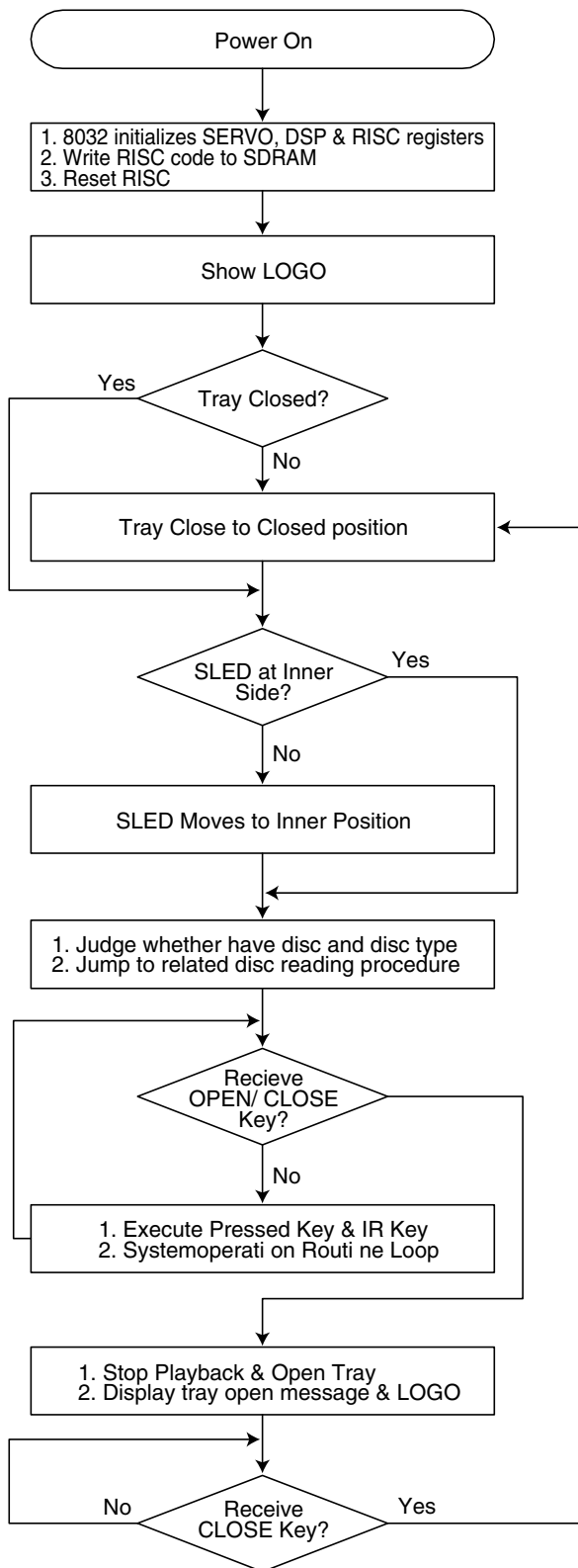

### 3. Test & debug flow

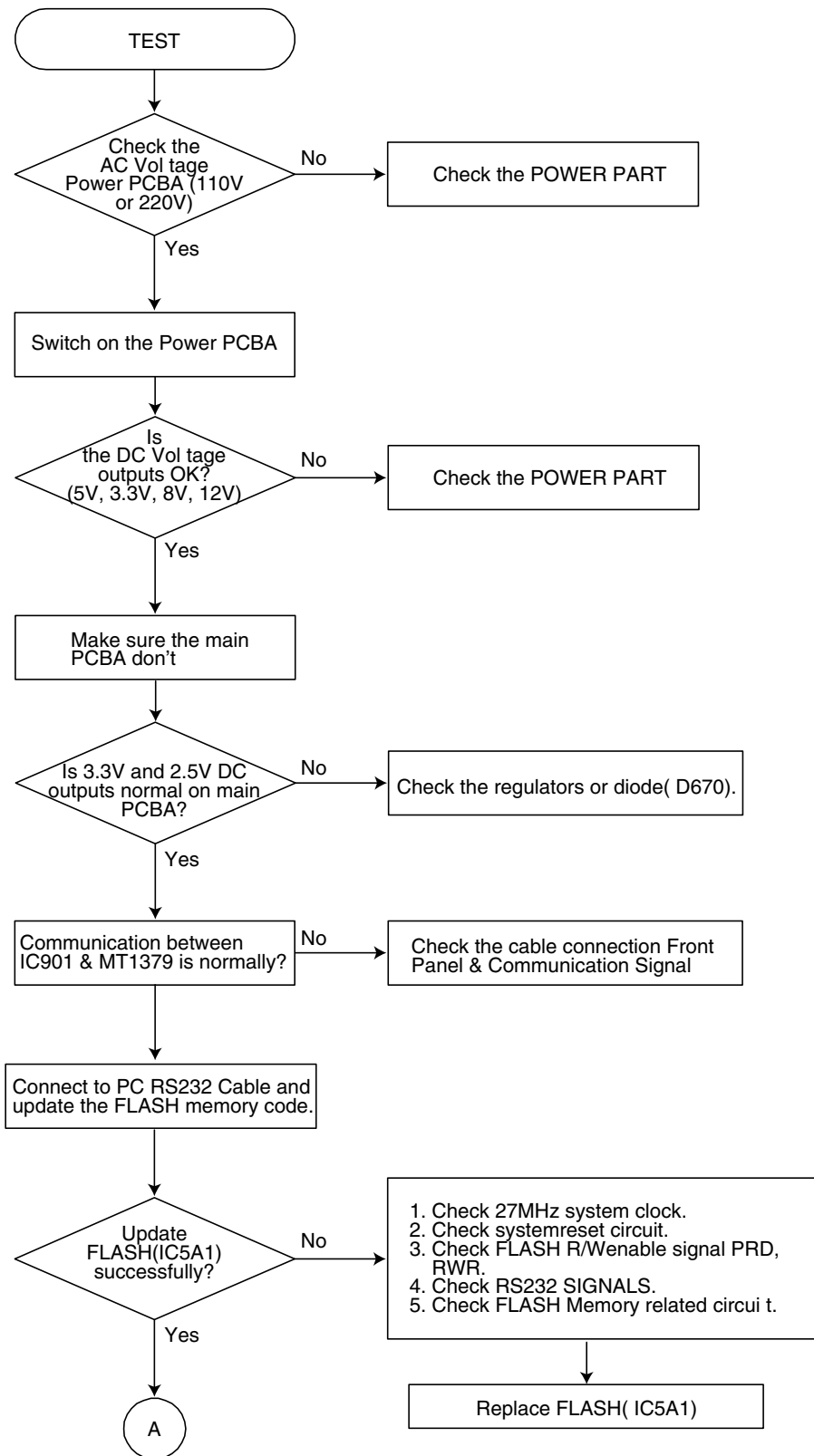

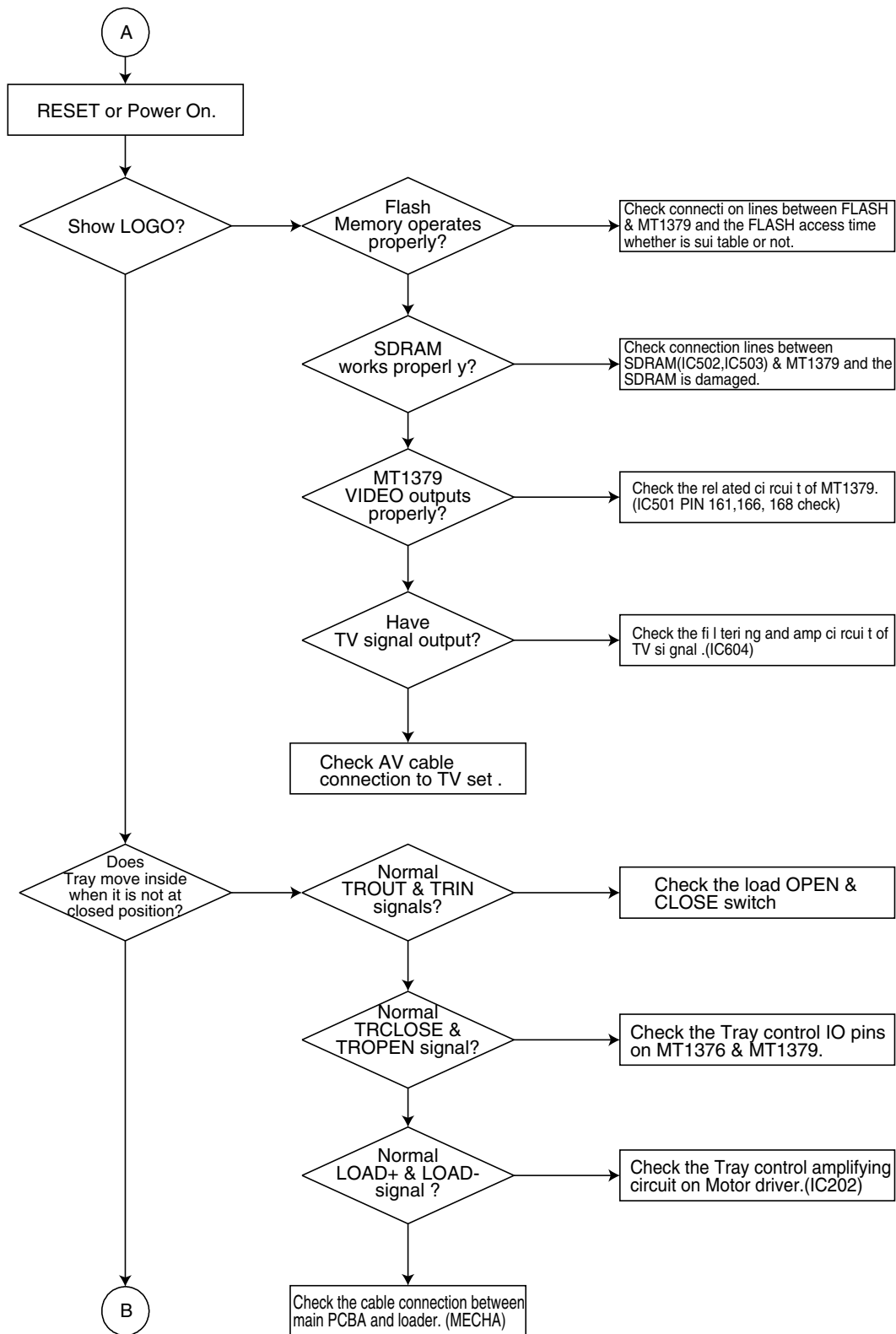

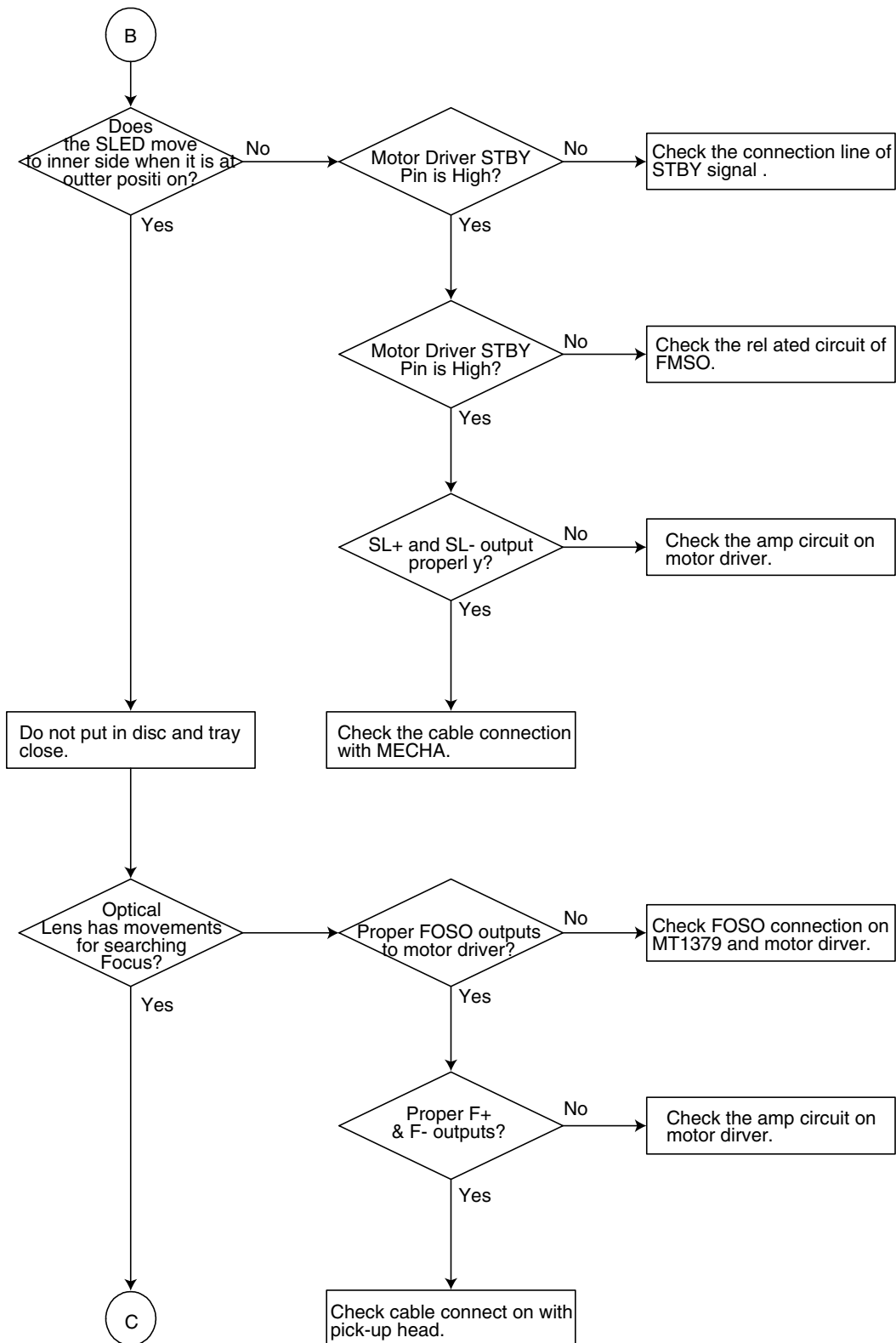

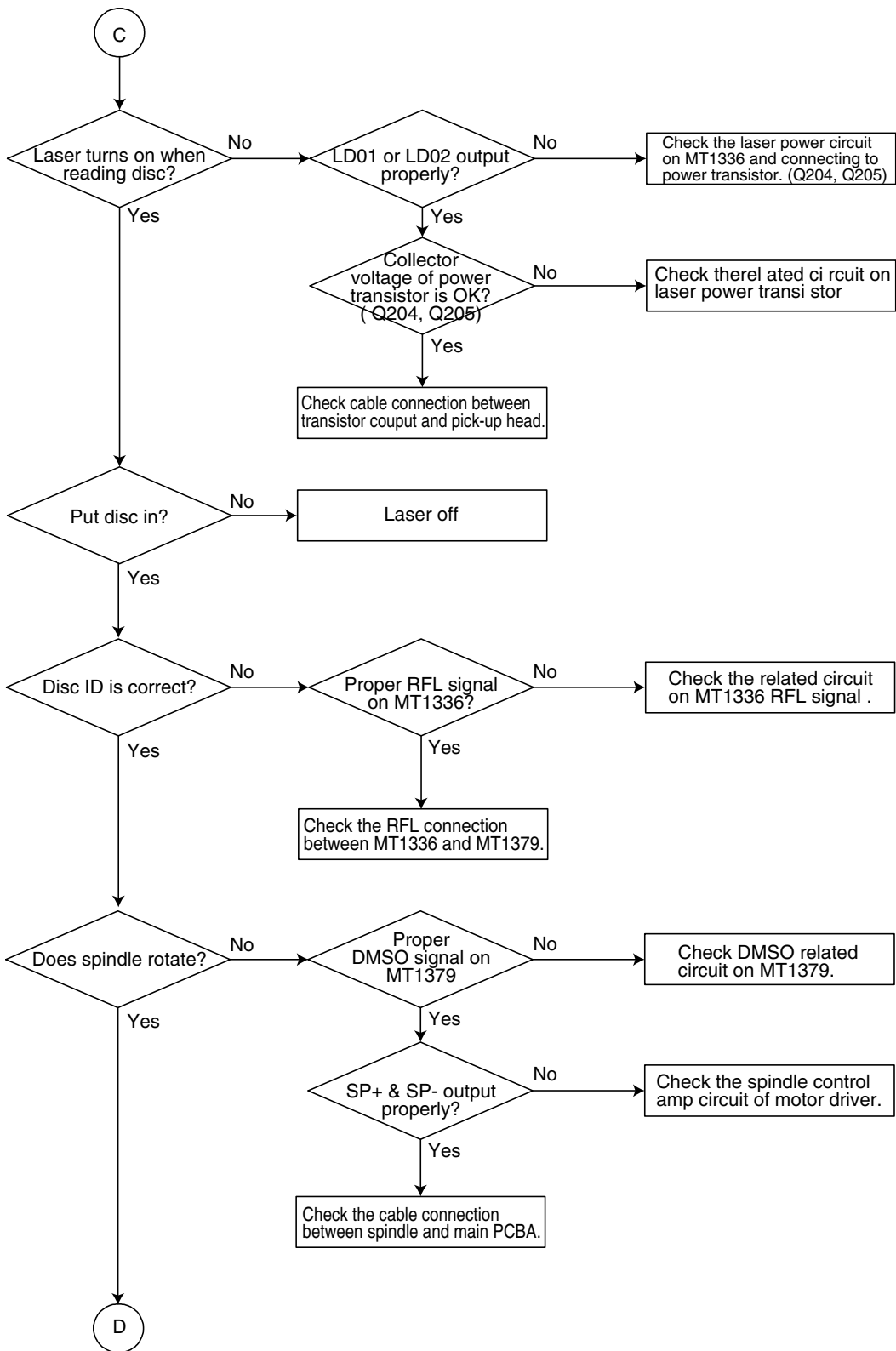

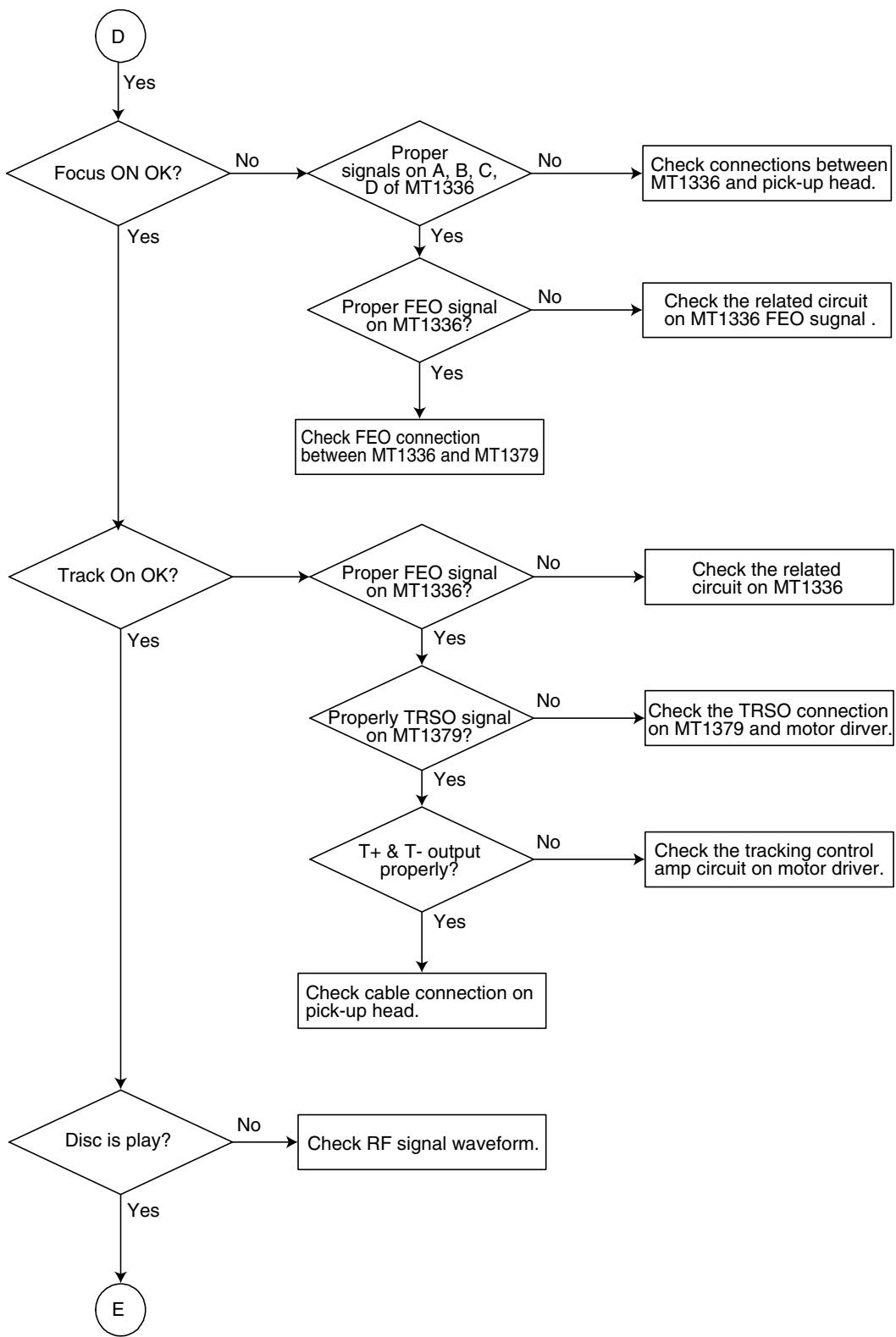



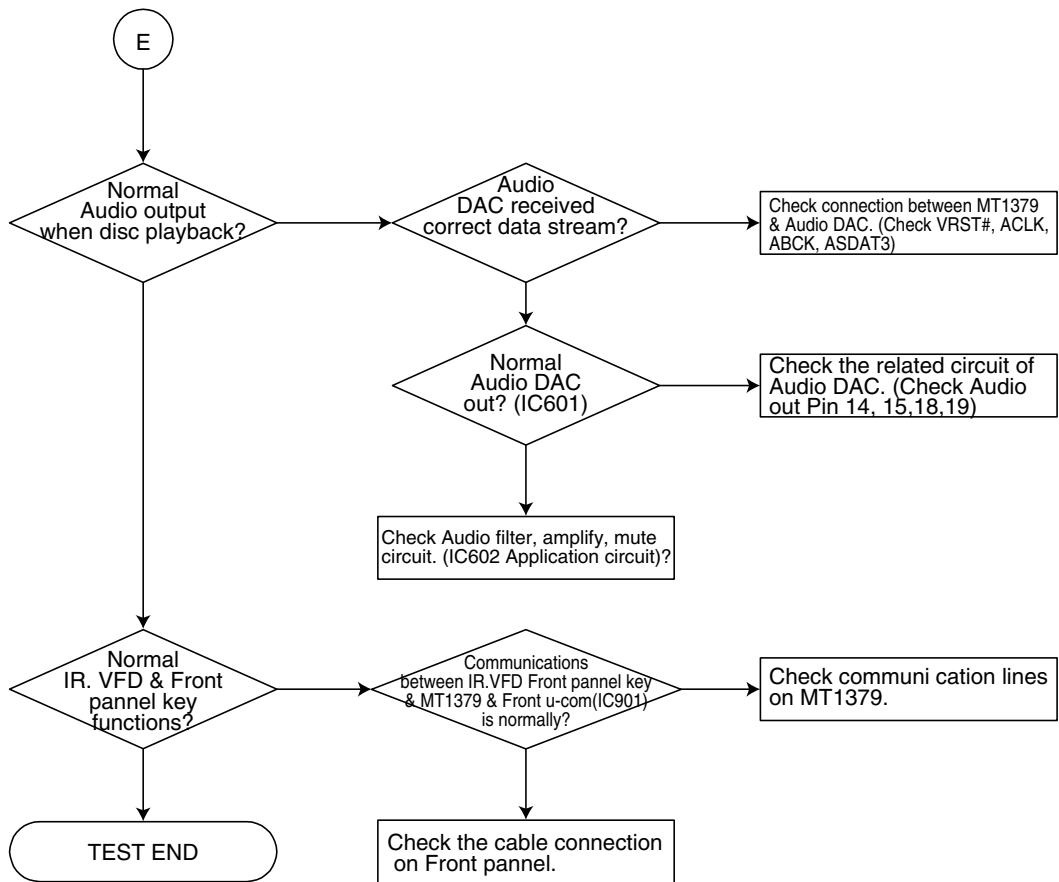

# DETAILS AND WAVEFORMS ON SYSTEM TEST AND DEBUGGING

## 1. SYSTEM 27MHz CLOCK,RESET,FLASH R/W SIGNAL

### 1) MT1379 main clock is at 27MHz(X501)

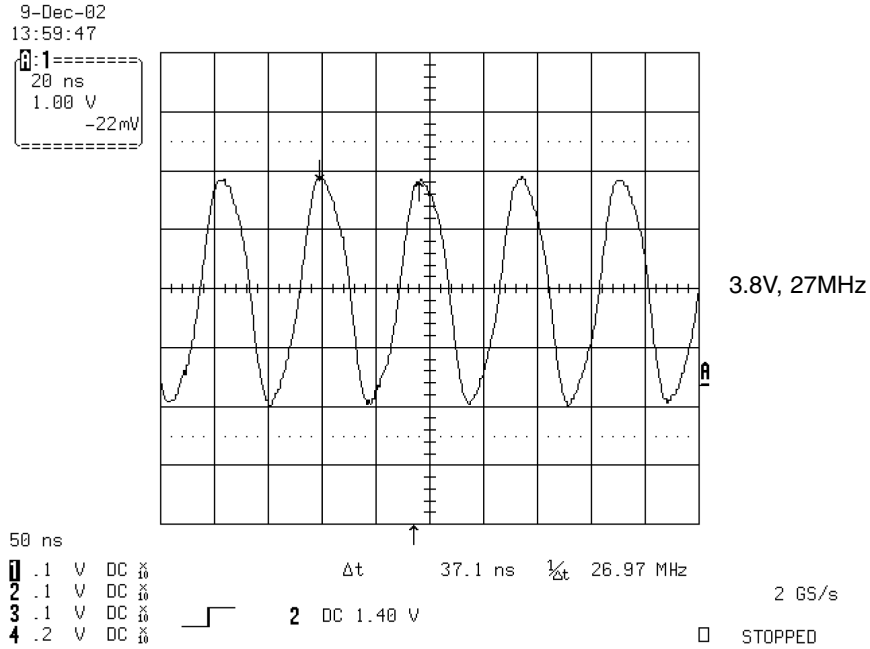

FIG 1-1

### 2) MT1379 & MT1336 reset is high active.

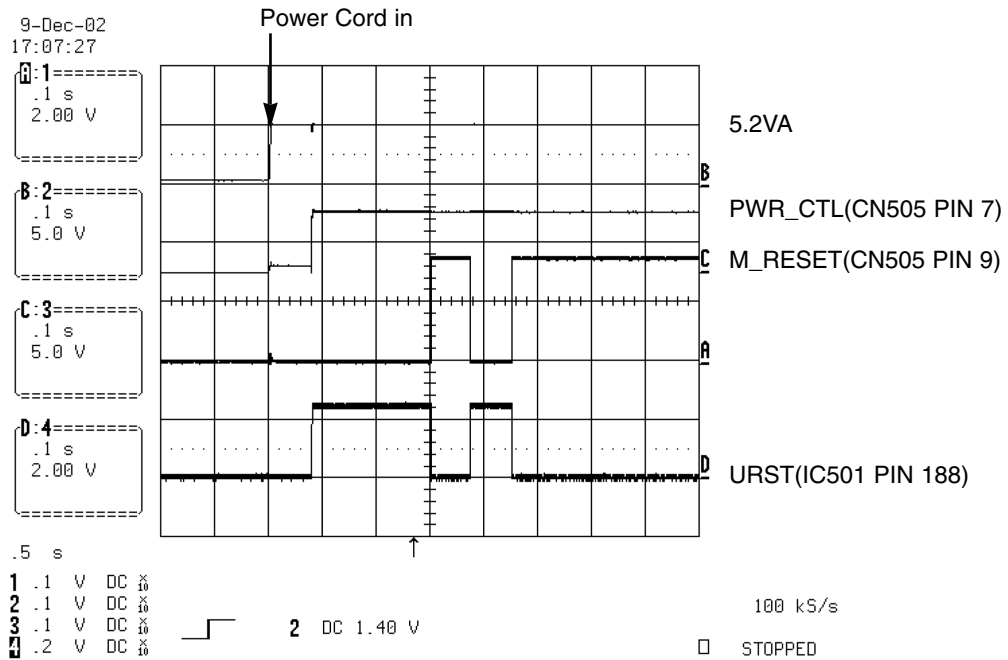

FIG 1-2

### 3) RS232 waveform during procedure(Downloading)

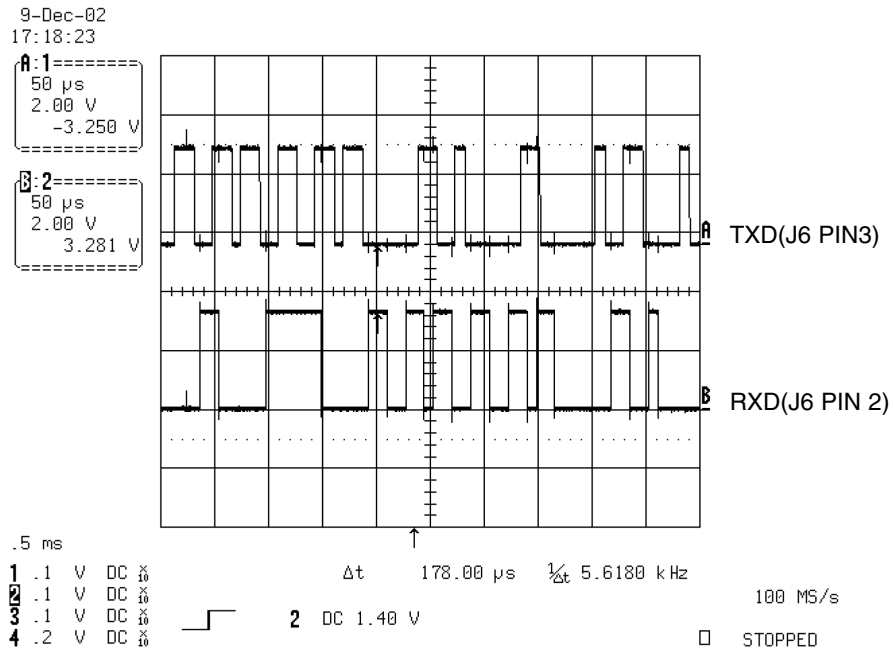

FIG 1-3

### 4) Flash R/W enable signal during download(Downloading)

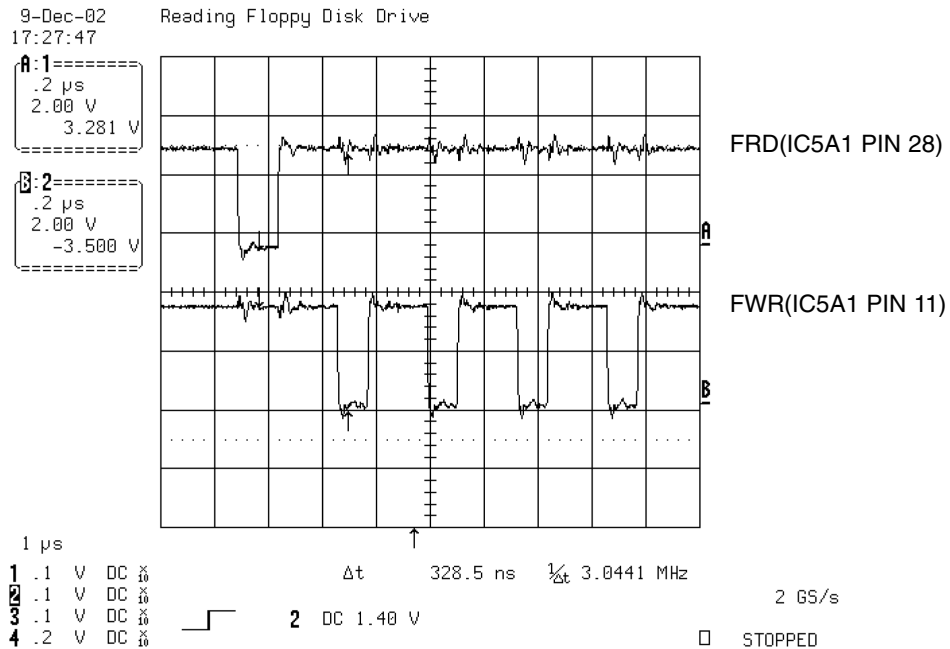

FIG 1-4

## 2. SDRAM CLOCK

### 1) MT1379 main clock is at 27MHz(X501)

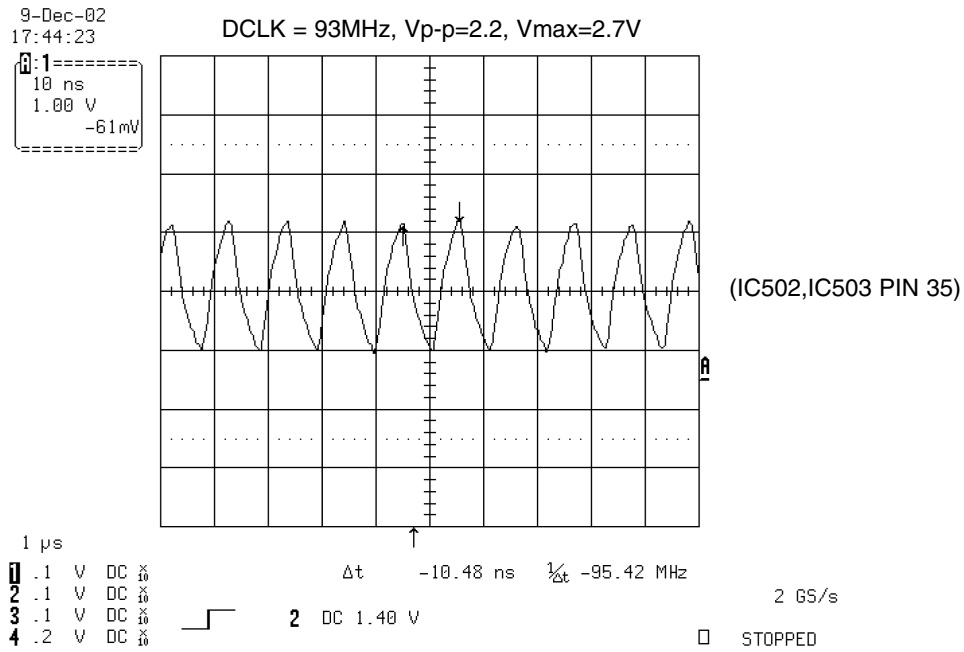

FIG 2-1

## 3. TRAY OPEN/CLOSE SIGNAL

### 1) Tray open/close waveform

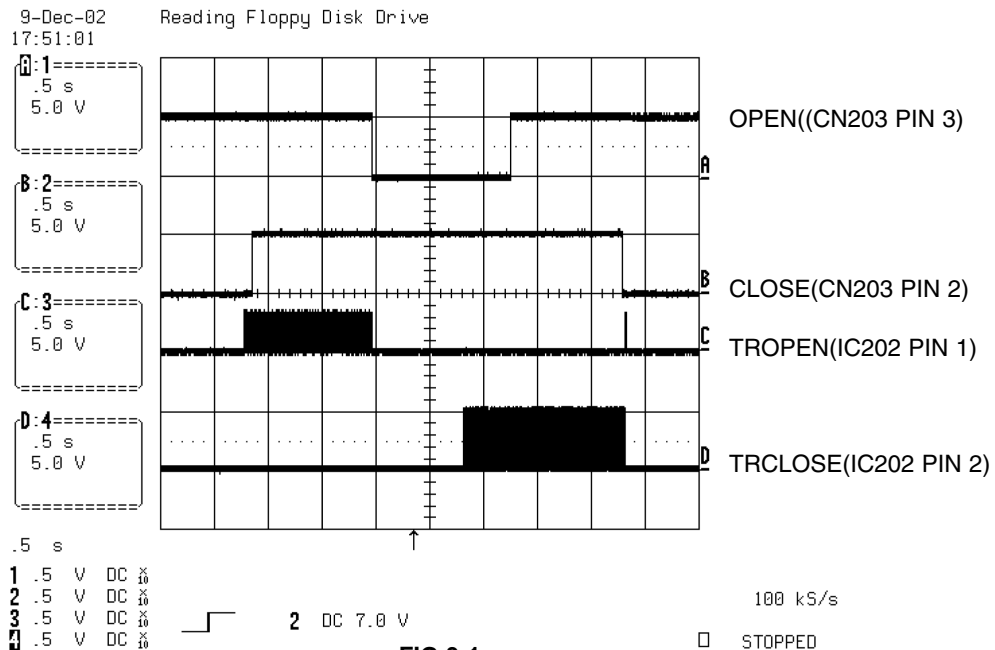

FIG 3-1

## 2) Tray close waveform

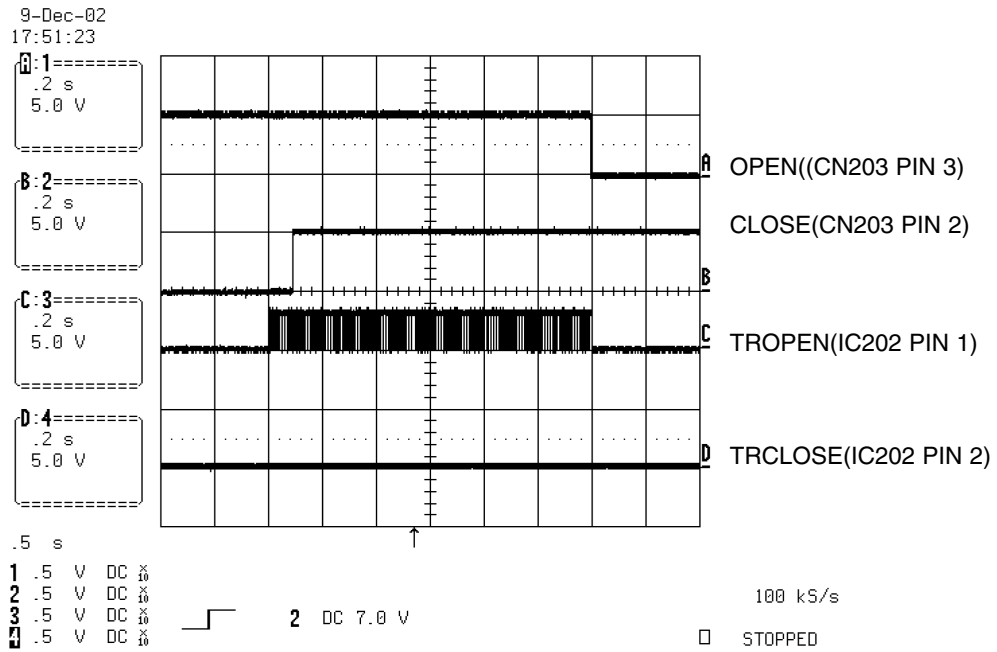

FIG 3-2

## 3) Tray open waveform

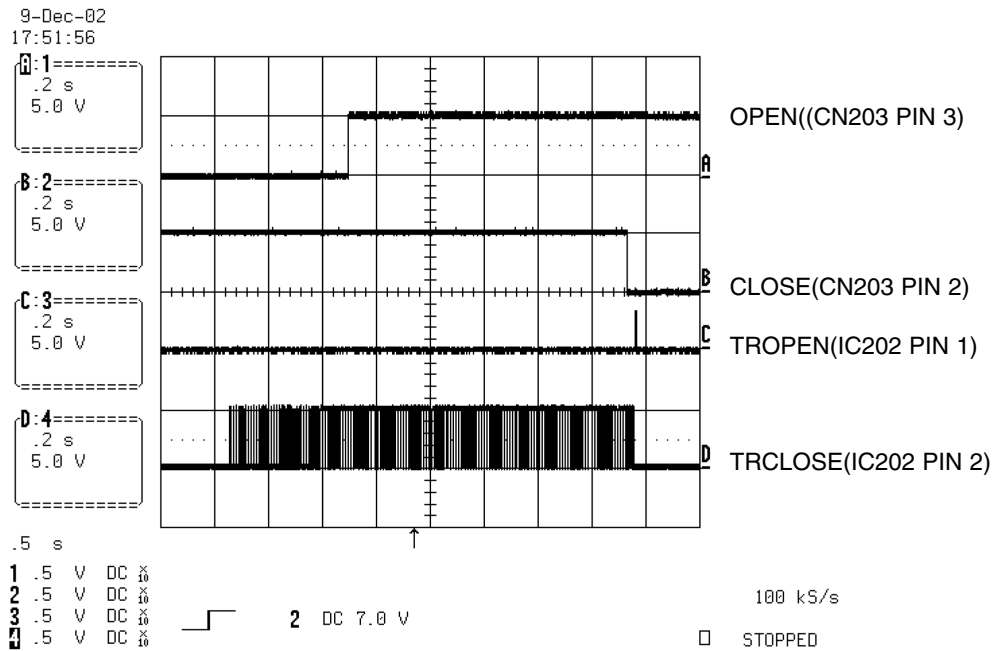

FIG 3-3

#### 4. SLED CONTROL RELATED SIGNAL (NO DISC CONDITION)

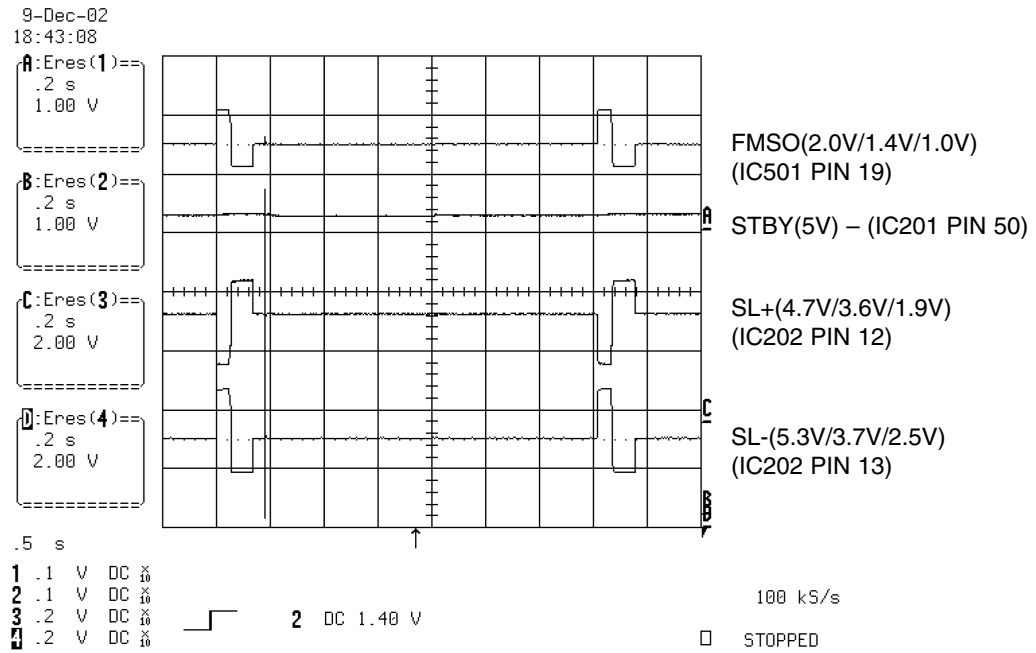

FIG 4-1

#### 5. LENS CONTROL RELATED SIGNAL(NO DISC CONDITION)

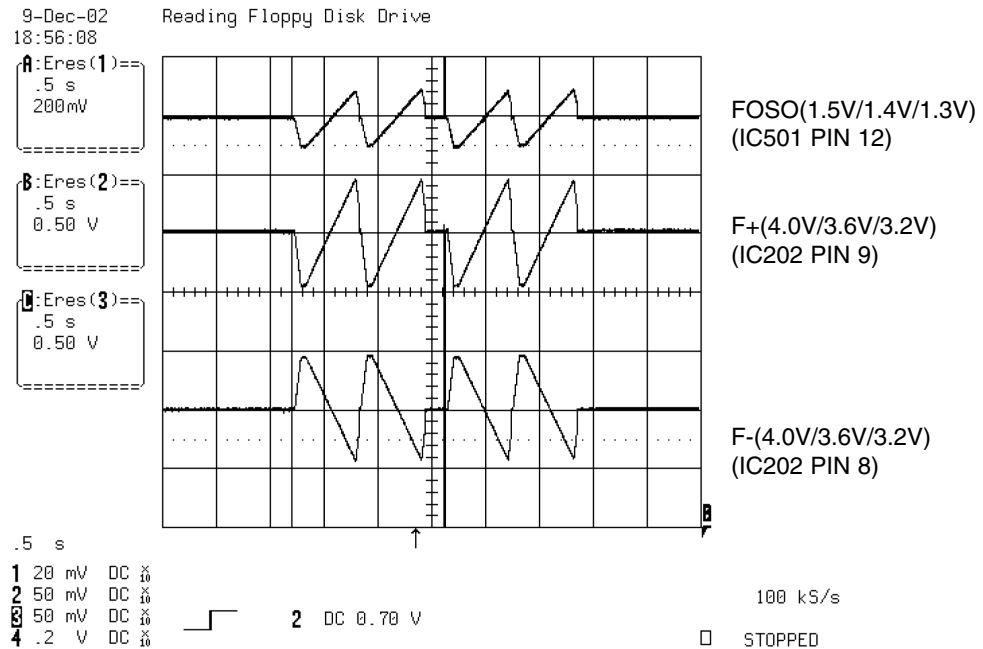

FIG 5-1

## 6. LASER POWER CONTROL RELATED SIGNAL(NO DISC CONDITION)

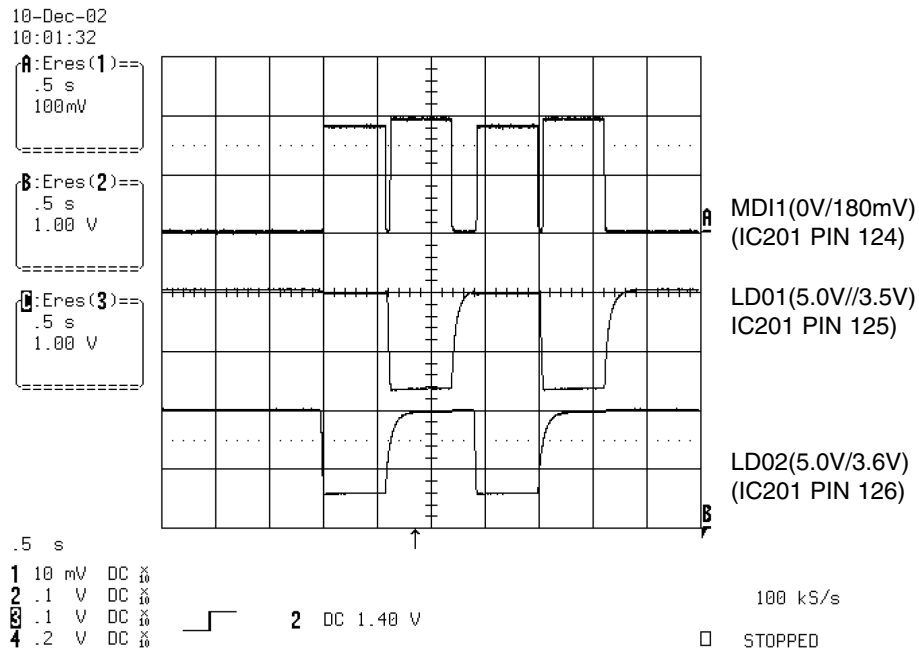

FIG 6-1

## 7. DISC TYPE JUDGEMENT WAVEFORM

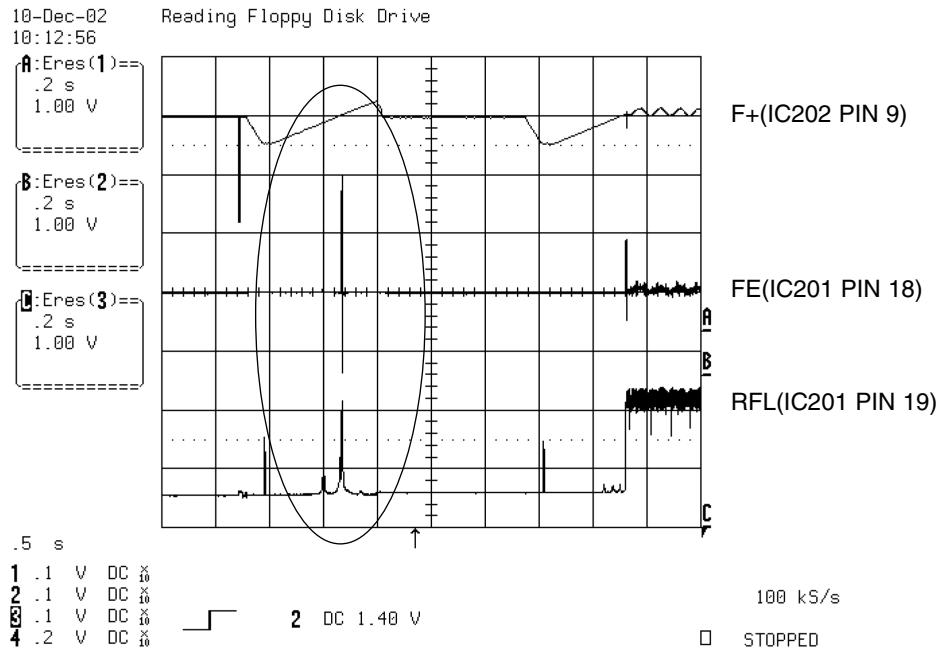

FIG 7-1 (DVD)

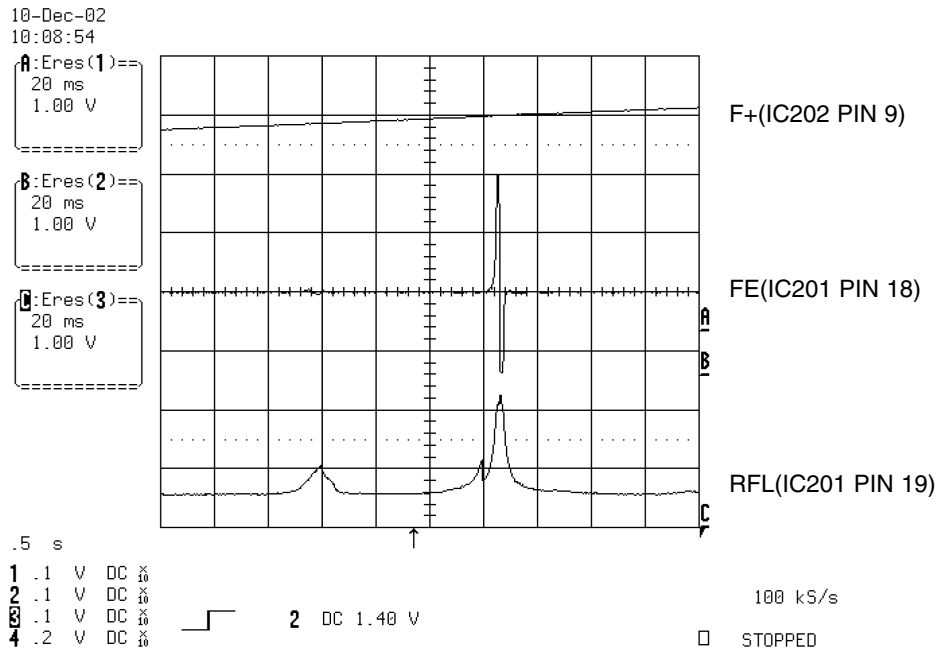

FIG 7-2 (DVD)

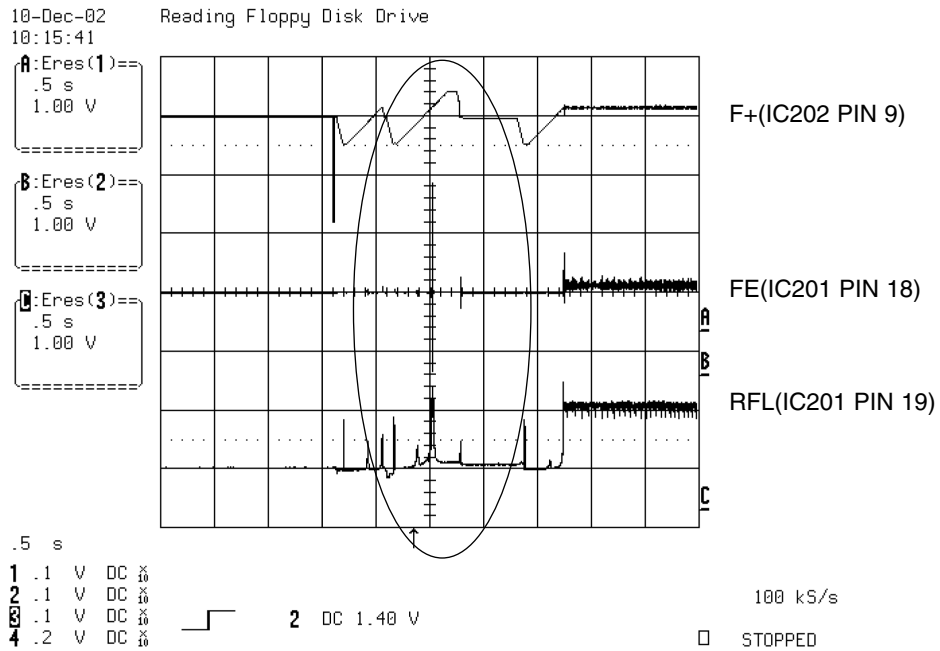

FIG 7-3 (CD)



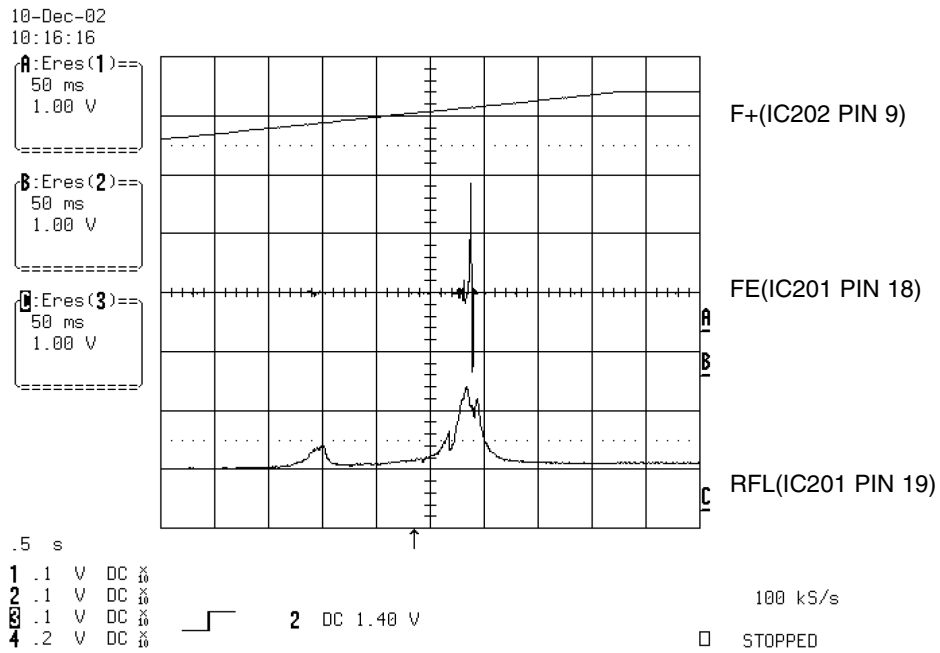

FIG 7-4 (CD)

## 8. FOCUS ON WAVEFORM

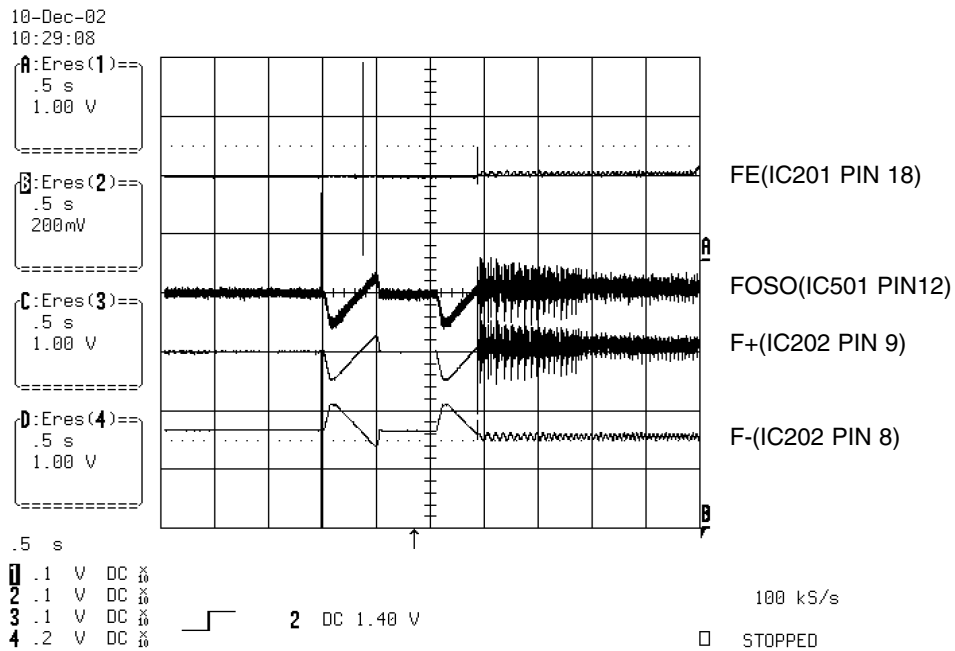

FIG 8-1 (DVD)

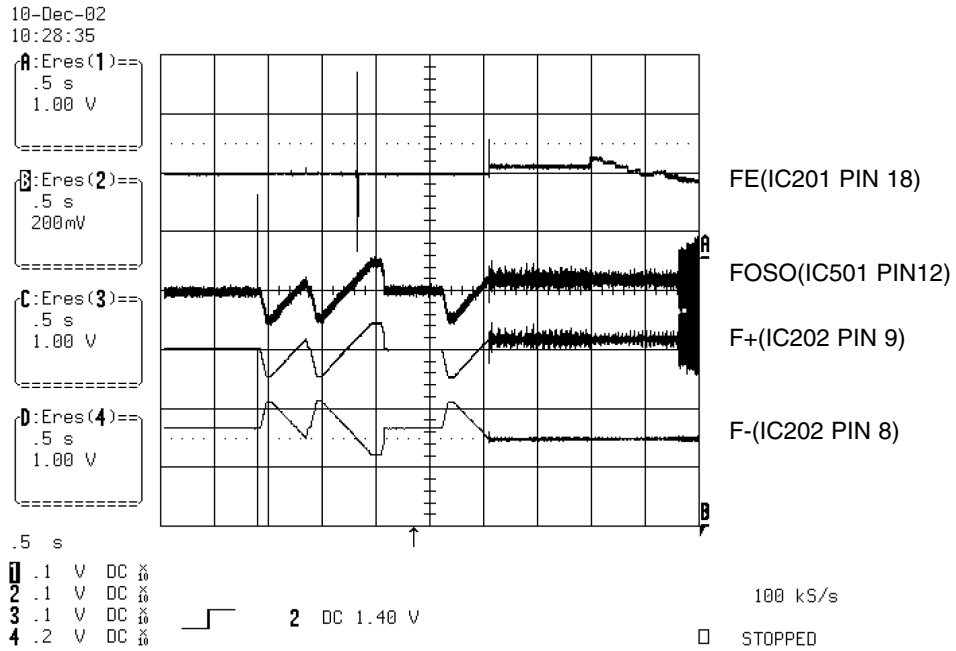

FIG 8-2 (CD)

## 9. SPINDLE CONTROL WAVEFORM (NO DISC CONDITION)

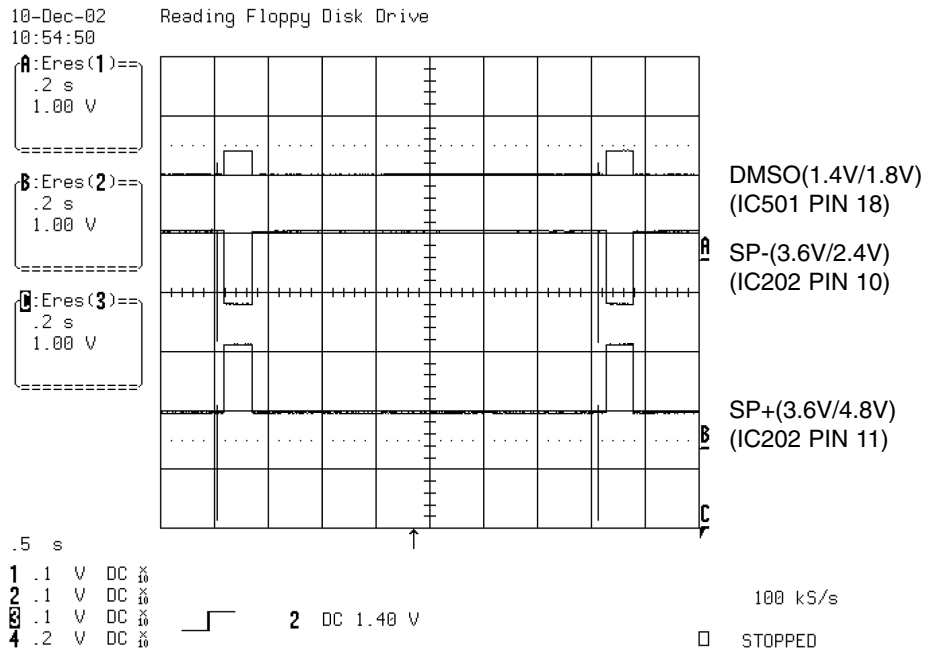

FIG 9-1

## 10. TRACKING CONTROL RELATED SIGNAL(System checking)

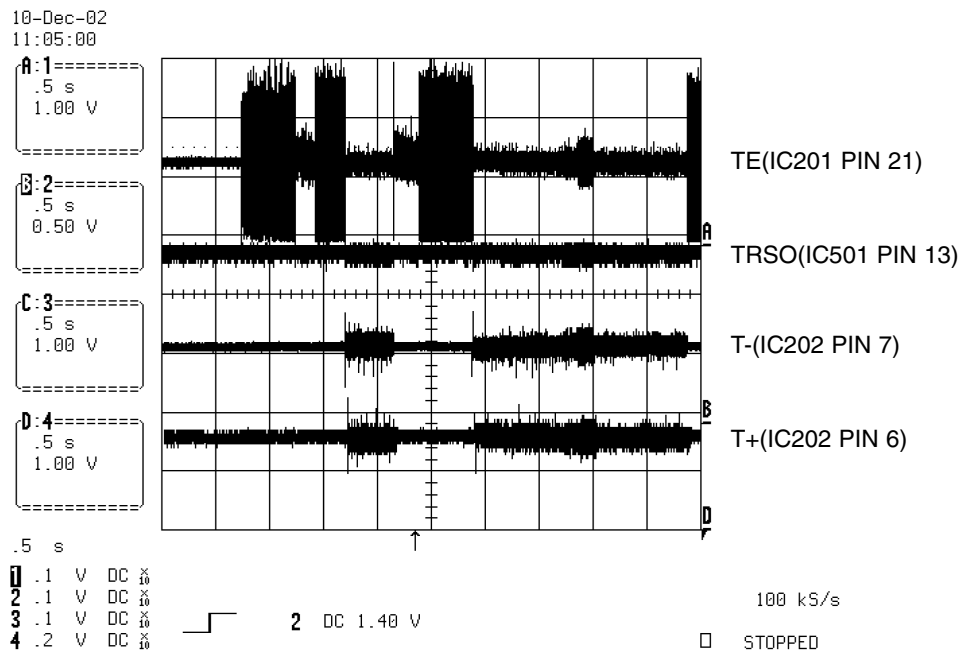

FIG 10-1(DVD)

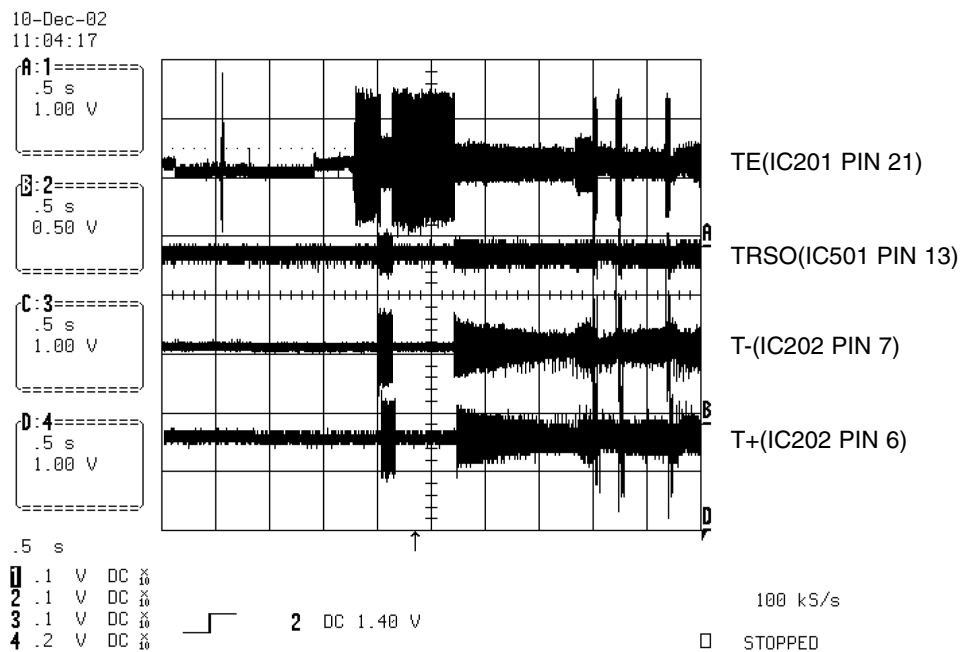

FIG 10-2(CD)

## 11. RF WAVEFORM

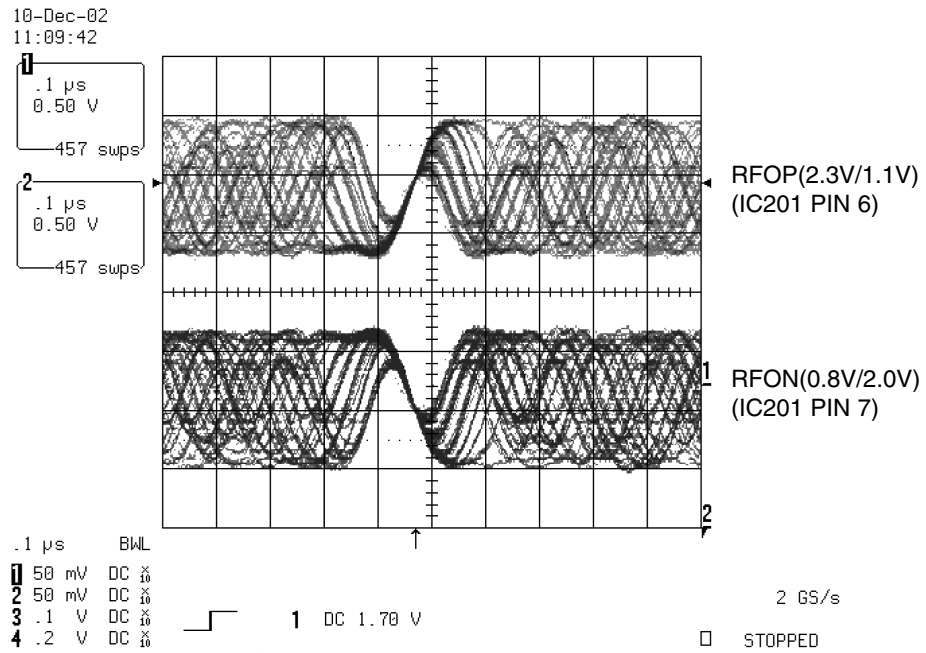

FIG 11-1

## 12. MT1379 AUDIO OPTICAL AND COAXIAL OUTPUT (ASPDIF)

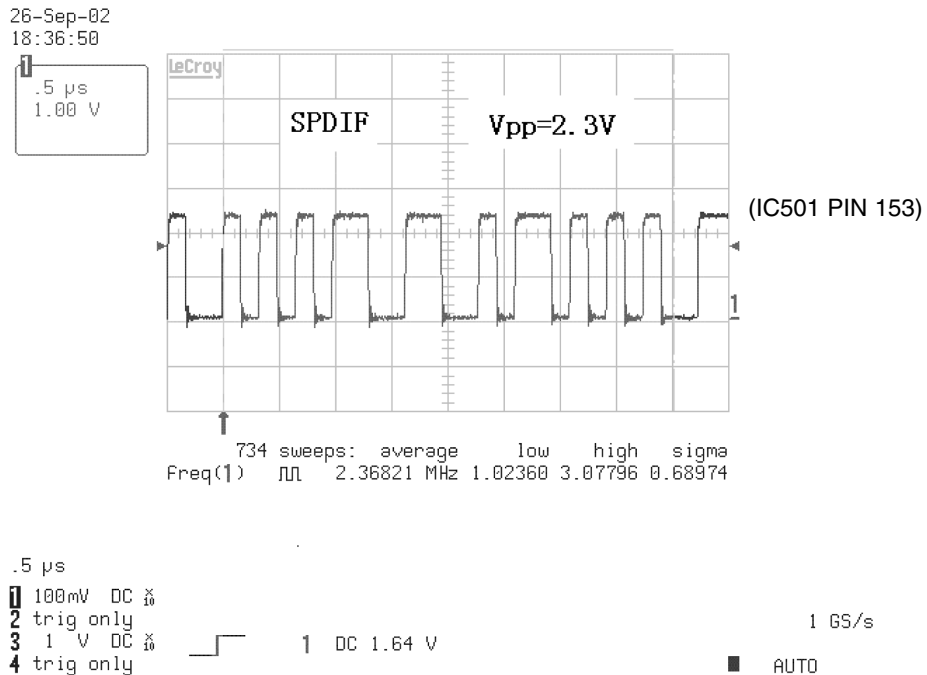

FIG 12-1

### 13. MT1379 VIDEO OUTPUT WAVEFORM

#### 1) Full colorbar signal(CVBS)

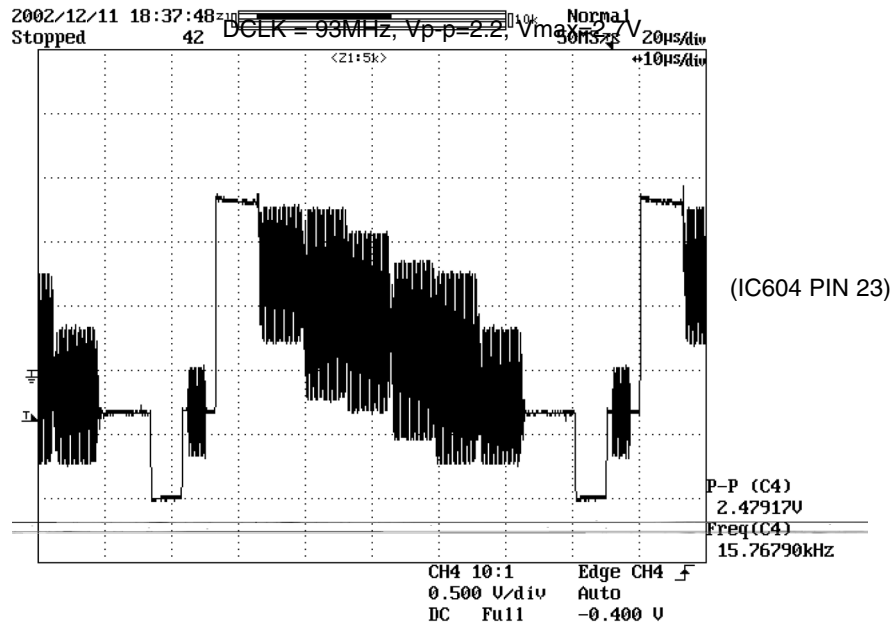

FIG 13-1

#### 2) Y

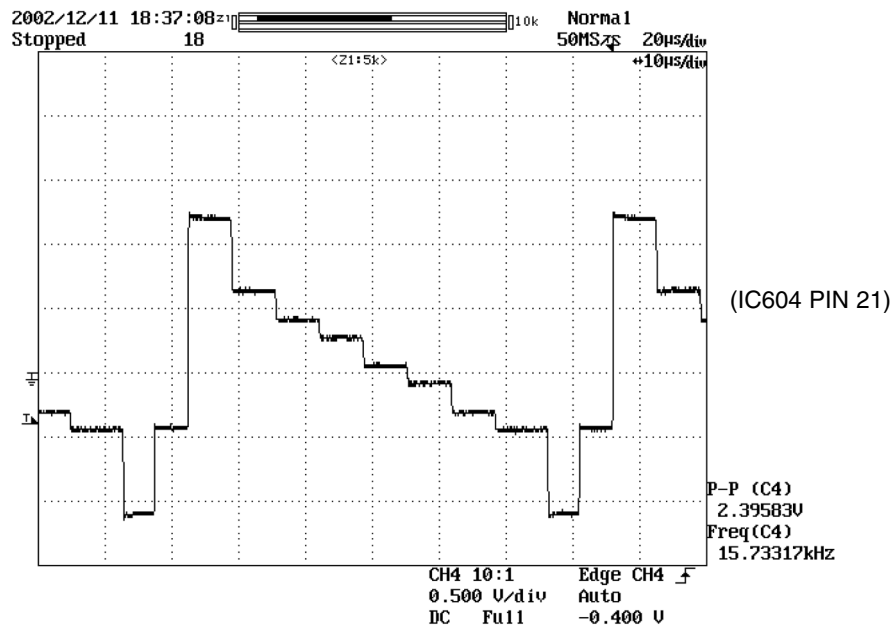

FIG 13-2

3) C

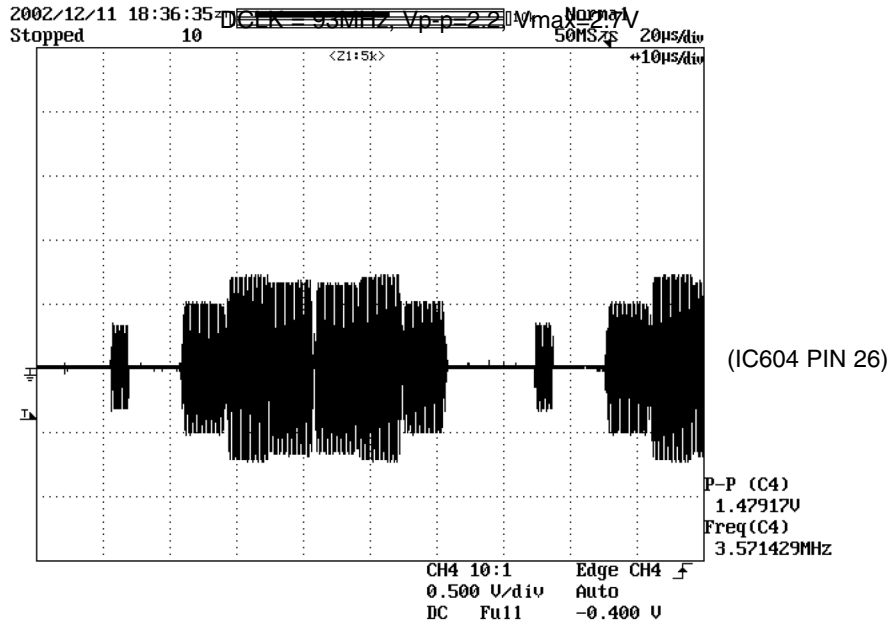

FIG 13-3

## 14. AUDIO OUTPUT FROM AUDIO DAC

### 1) Audio L/R

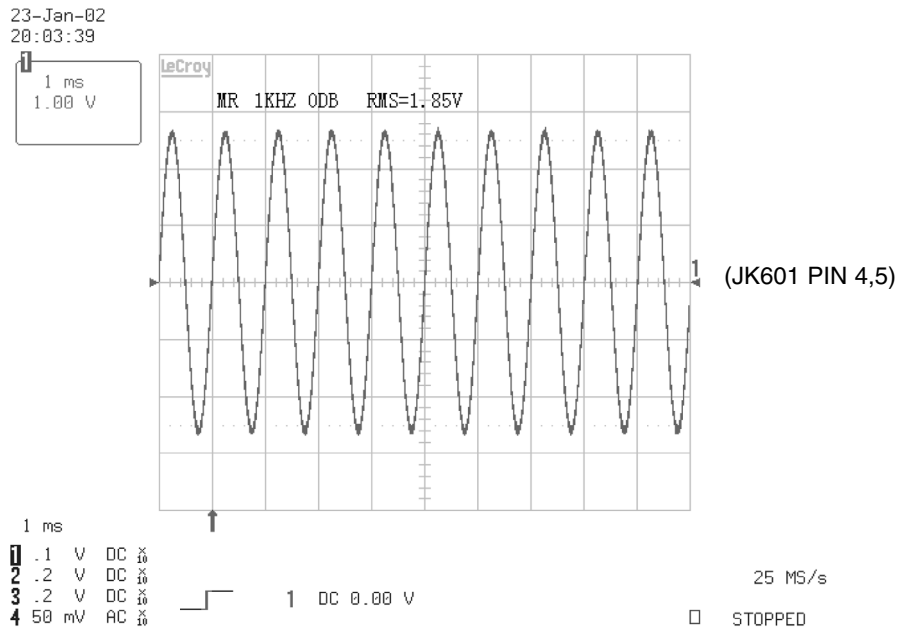

FIG 14-1

## 2) Audio related Signal

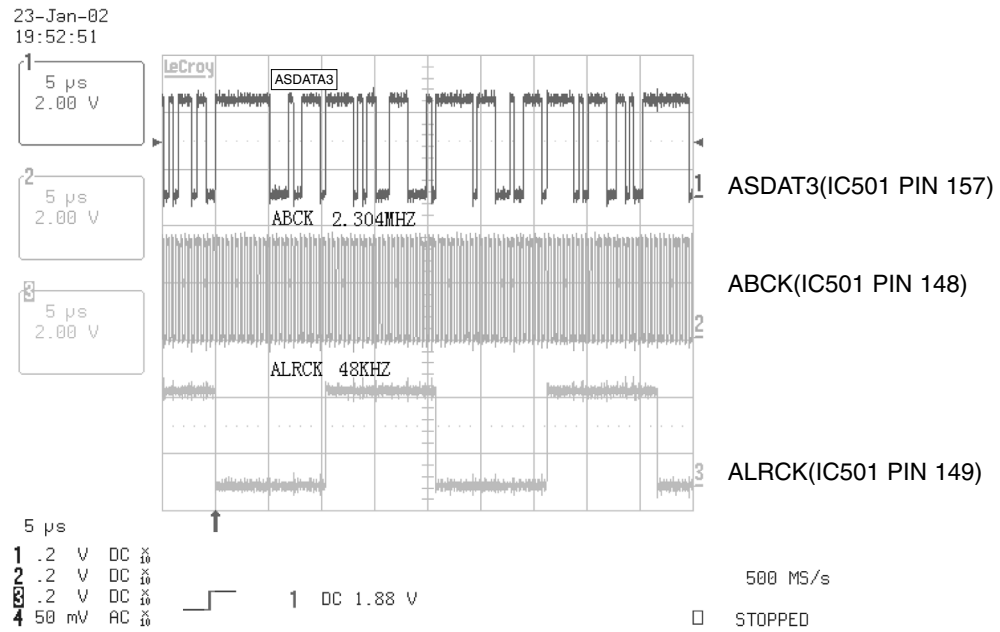
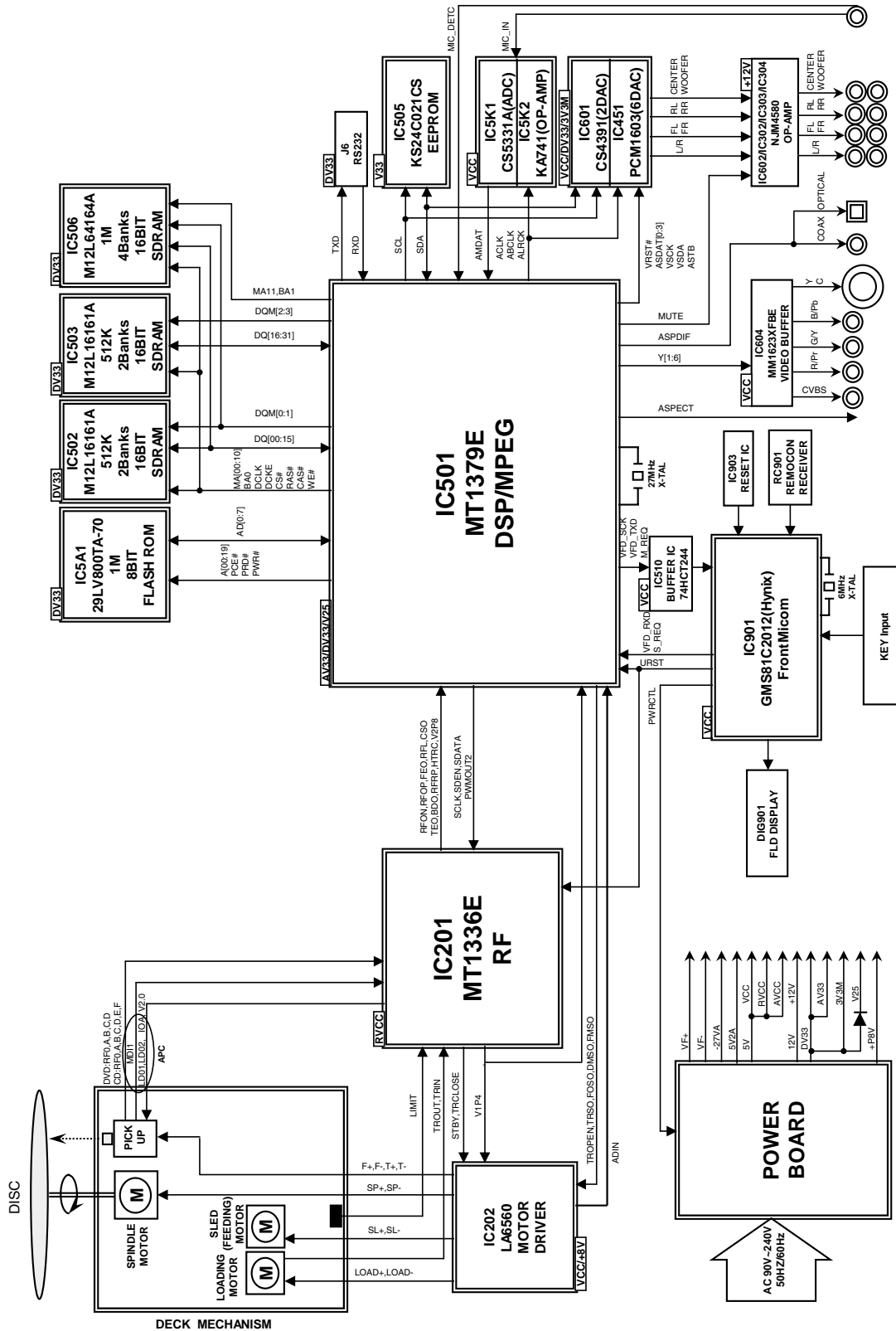

FIG 14-2

# BLOCK DIAGRAMS

## 1. Overall Block Diagram



DV7800M'S  
TOSHIBA



## 2. Power(SMPS) Block Diagram

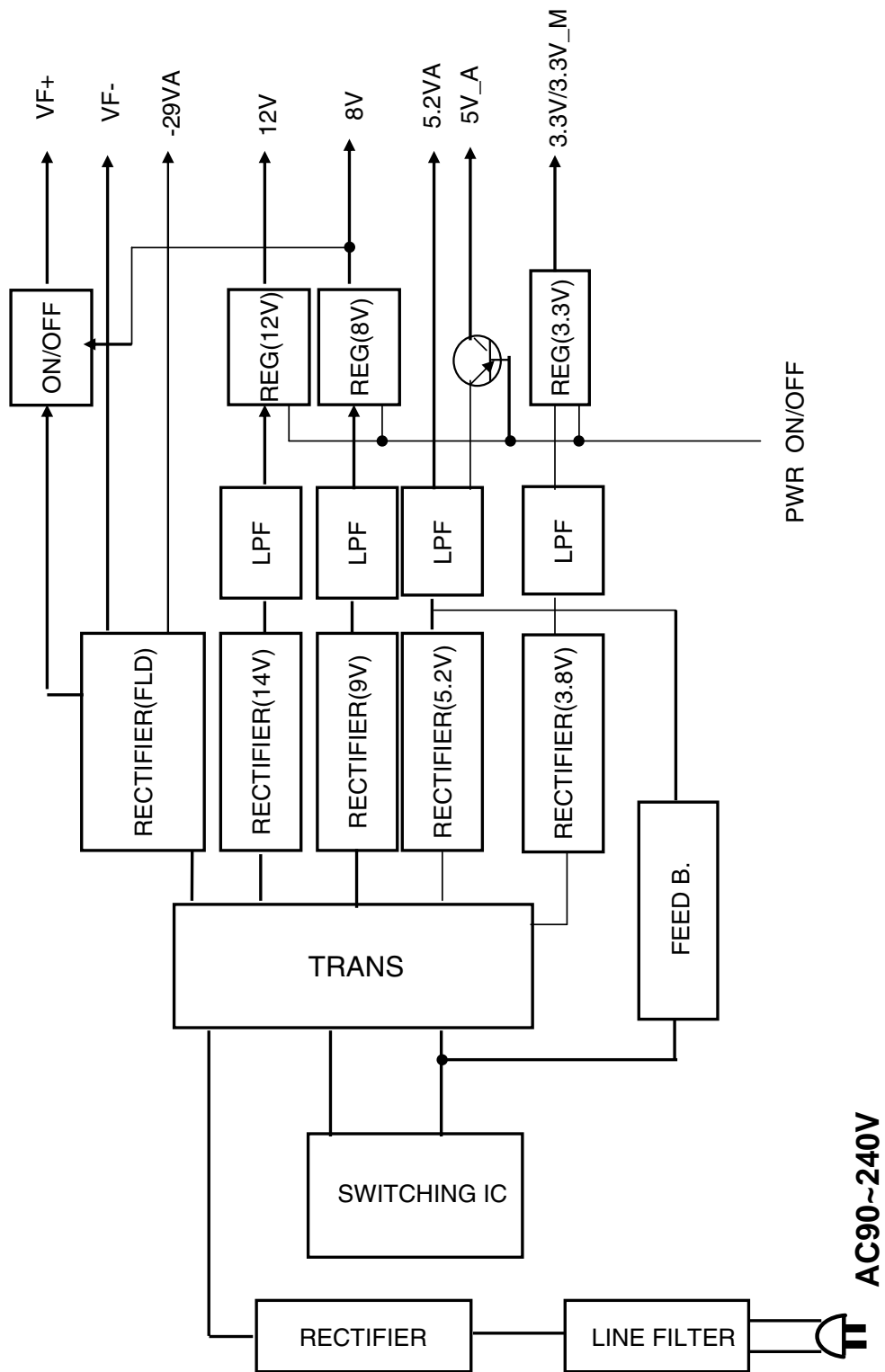

DV7800M'S  
TOSHIBA

### 3. SERVO Block Diagram

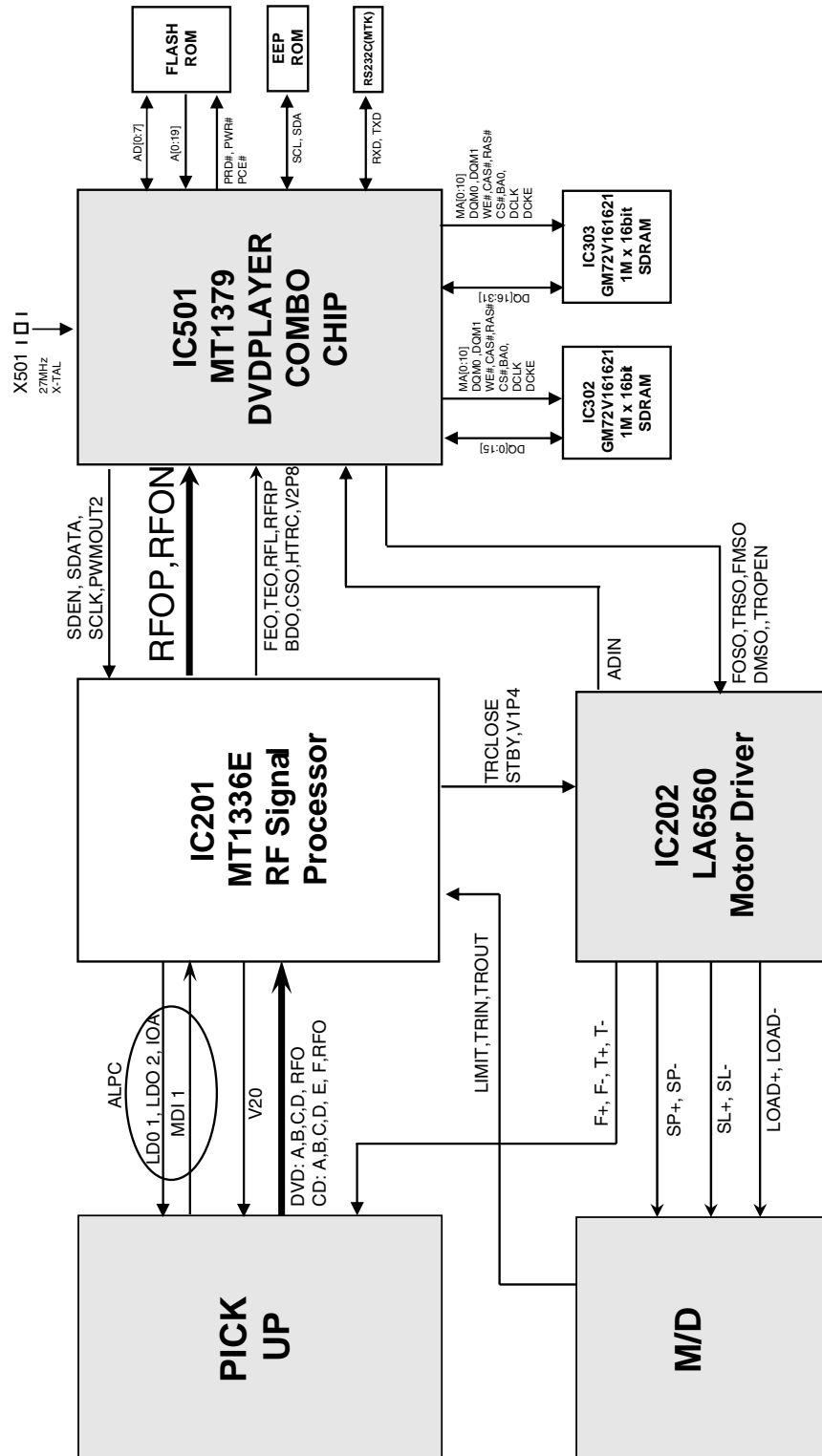

DV7800M'S  
TOSHIBA

# 4. MPEG & MEMORY Block Diagram

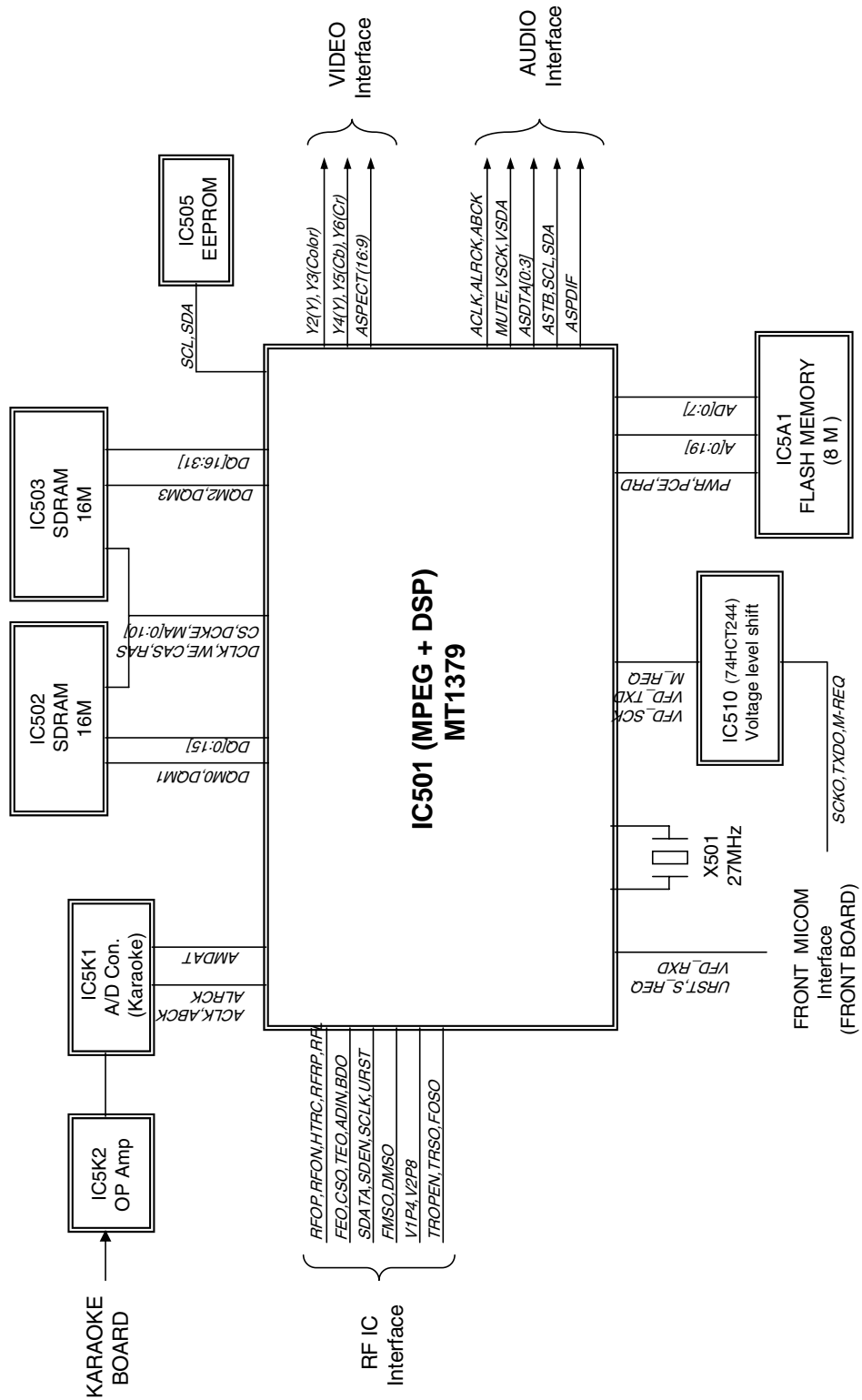

DV7800M'S  
TOSHIBA

# 5. VIDEO & AUDIO Block Diagram

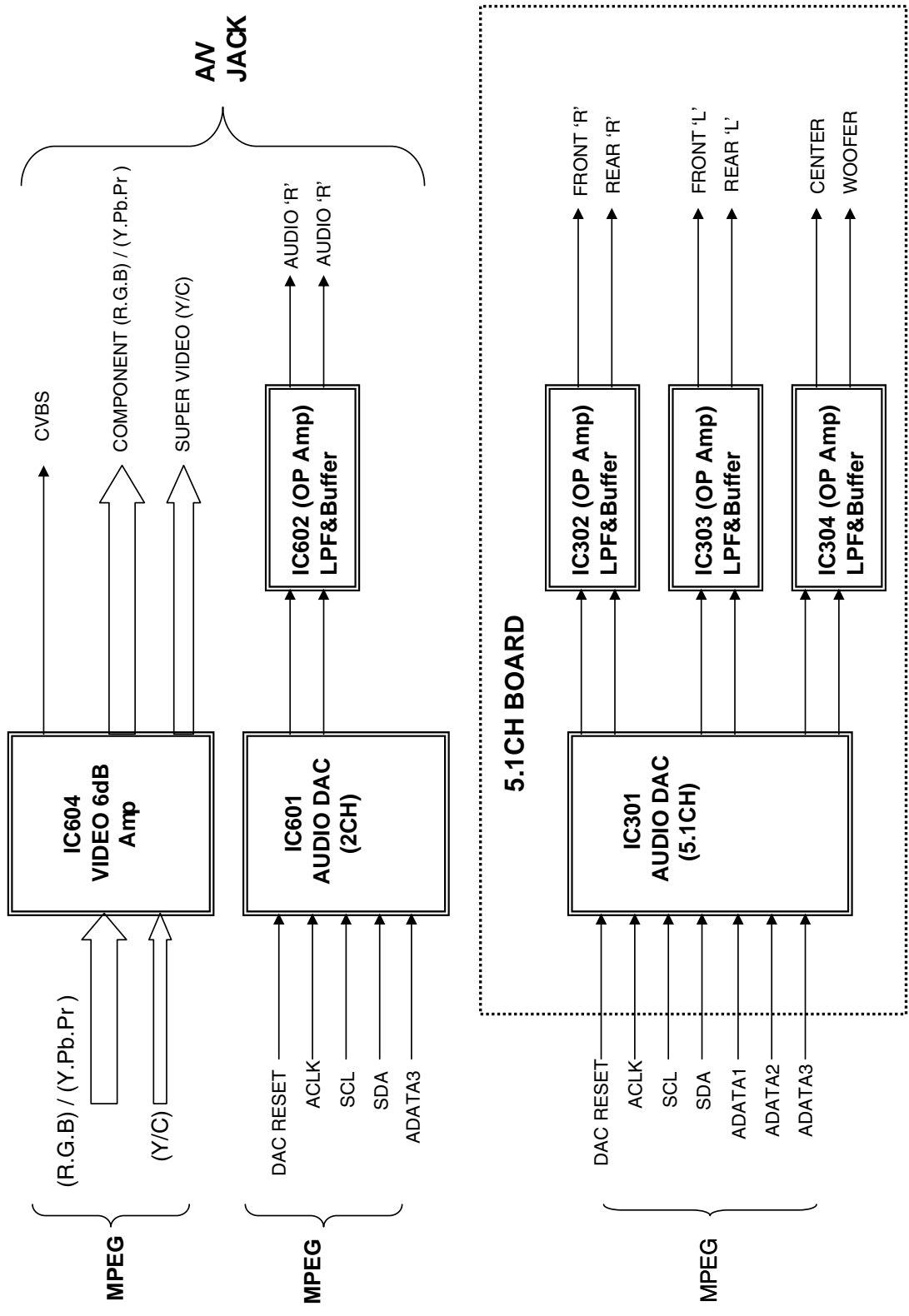

DV7800M'S  
TOSHIBA



# CIRCUIT DIAGRAMS

## 1. POWER(SMPS) CIRCUIT DIAGRAM

### IMPORTANT SAFETY NOTICE

WHEN SERVICING THIS CHASSIS, UNDER NO CIRCUMSTANCES SHOULD THE ORIGINAL DESIGN BE MODIFIED OR ALTERED WITHOUT PERMISSION FROM THE TOSHIBA ELECTRONICS CORPORATION. ALL COMPONENTS SHOULD BE REPLACED ONLY WITH TYPES IDENTICAL TO THOSE IN THE ORIGINAL CIRCUIT. SPECIAL COMPONENTS ARE SHADED ON THE SCHEMATIC FOR EASY IDENTIFICATION. THIS CIRCUIT DIAGRAM MAY OCCASIONALLY DIFFER FROM THE ACTUAL CIRCUIT USED. THIS WAY, IMPLEMENTATION OF THE LATEST SAFETY AND PERFORMANCE IMPROVEMENT CHANGES INTO THE SET IS NOT DELAYED UNTIL THE NEW SERVICE LITERATURE IS PRINTED.

WHEN SERVICING THIS CHASSIS, UNDER NO CIRCUMSTANCES SHOULD THE ORIGINAL DESIGN BE MODIFIED OR ALTERED WITHOUT PERMISSION FROM THE TOSHIBA ELECTRONICS CORPORATION. ALL COMPONENTS SHOULD BE REPLACED ONLY WITH TYPES IDENTICAL TO THOSE IN THE ORIGINAL CIRCUIT. SPECIAL COMPONENTS ARE SHADED ON THE SCHEMATIC FOR EASY IDENTIFICATION. THIS CIRCUIT DIAGRAM MAY OCCASIONALLY DIFFER FROM THE ACTUAL CIRCUIT USED. THIS WAY, IMPLEMENTATION OF THE LATEST SAFETY AND PERFORMANCE IMPROVEMENT CHANGES INTO THE SET IS NOT DELAYED UNTIL THE NEW SERVICE LITERATURE IS PRINTED.

### NOTE :

1. Shaded(■) parts are critical for safety. Replace only with specified part number.
2. Voltages are DC-measured with a digital voltmeter during Play mode.

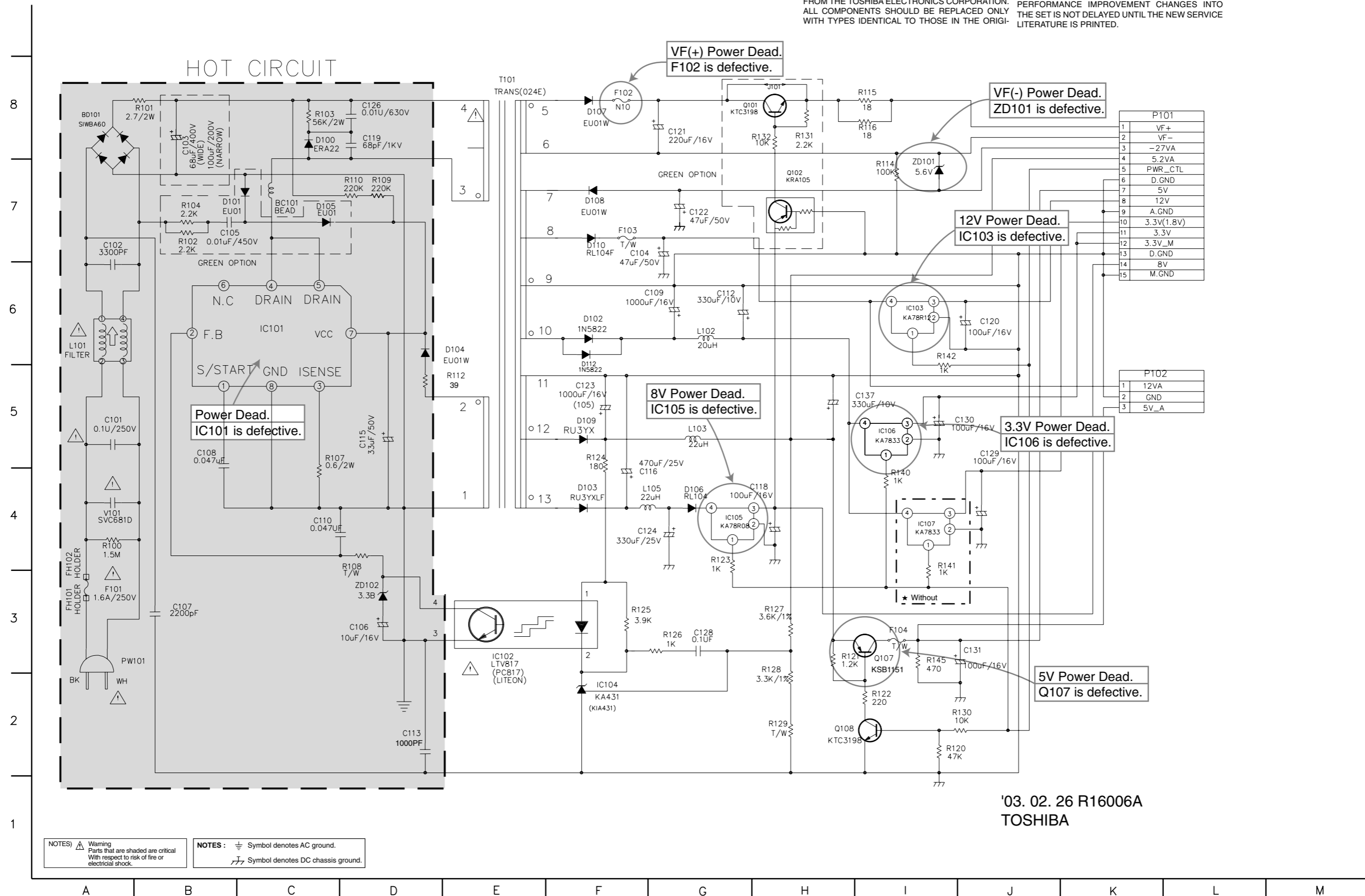

'03. 02. 26 R16006A  
TOSHIBA

NOTES: ⚠ Warning Parts that are shaded are critical With respect to risk of fire or electrical shock.

NOTES: ⚡ Symbol denotes AC ground. ⏏ Symbol denotes DC chassis ground.

## 2. SYSTEM CIRCUIT DIAGRAM

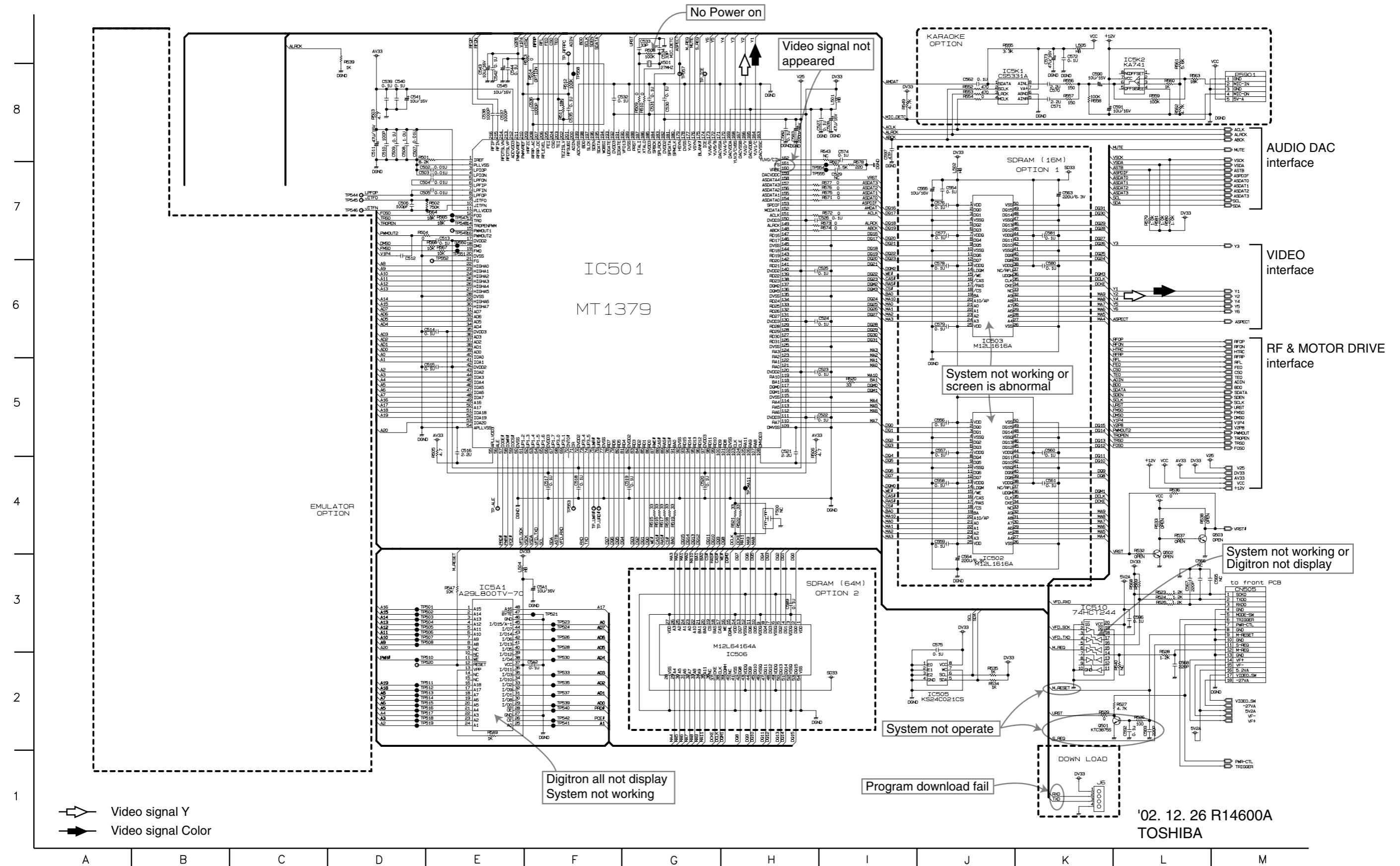

### 3. RF & SERVO CIRCUIT DIAGRAM

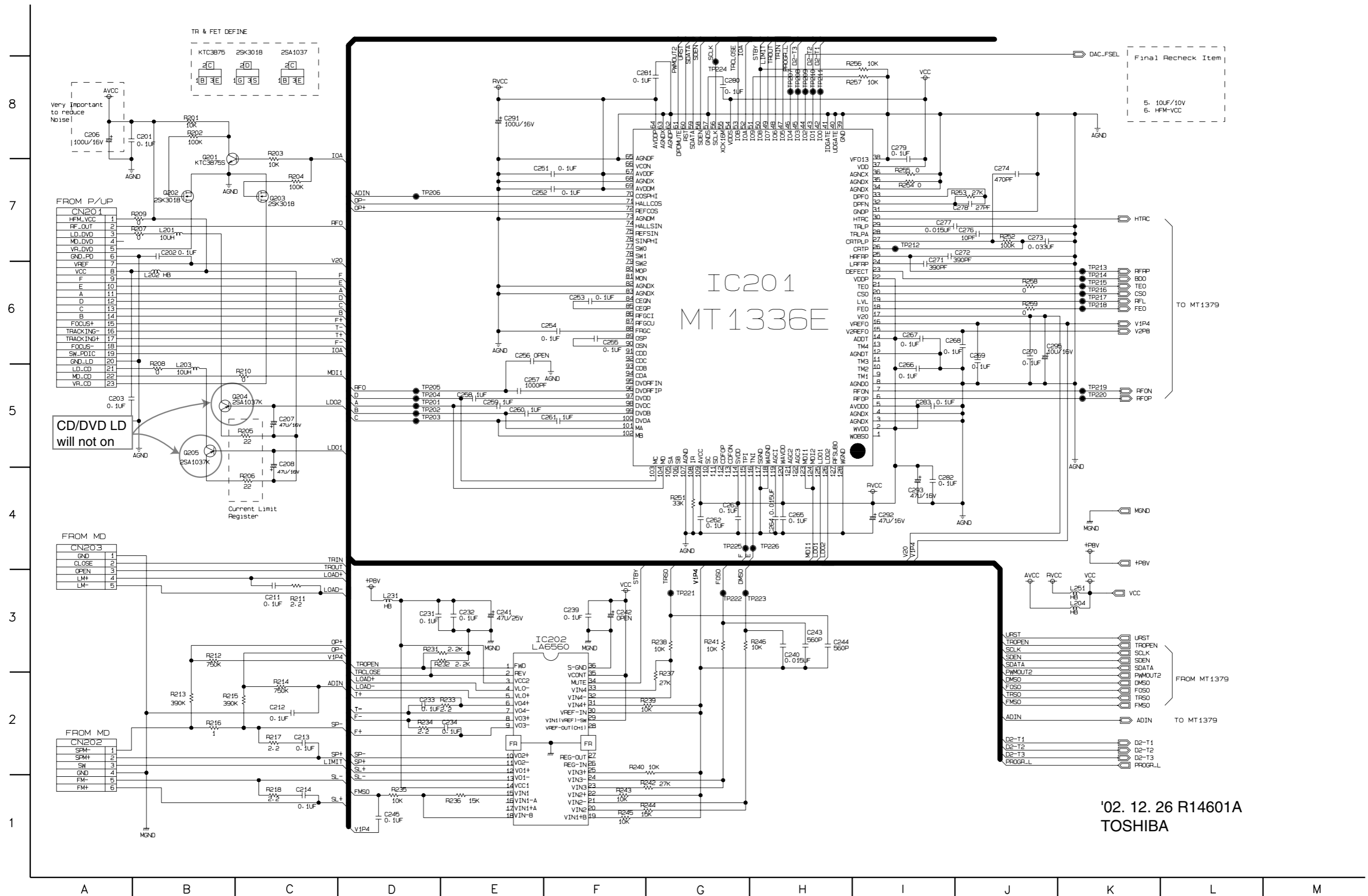



# 4. TIMER, 5.1CH, SCART, KARAOKE CIRCUIT DIAGRAM

11  
10  
9  
8  
7  
6  
5  
4  
3  
2  
1

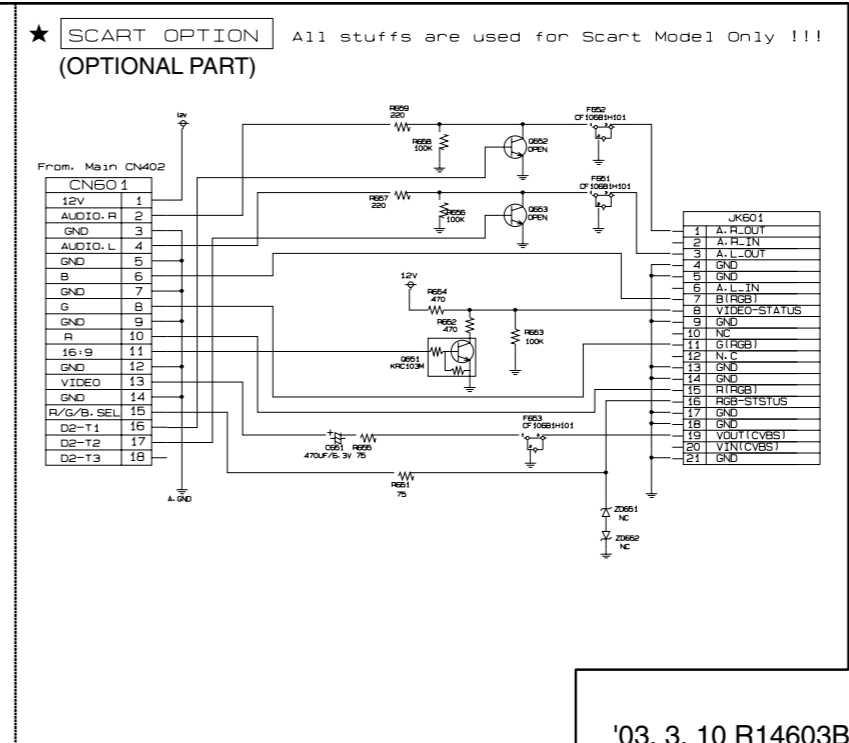
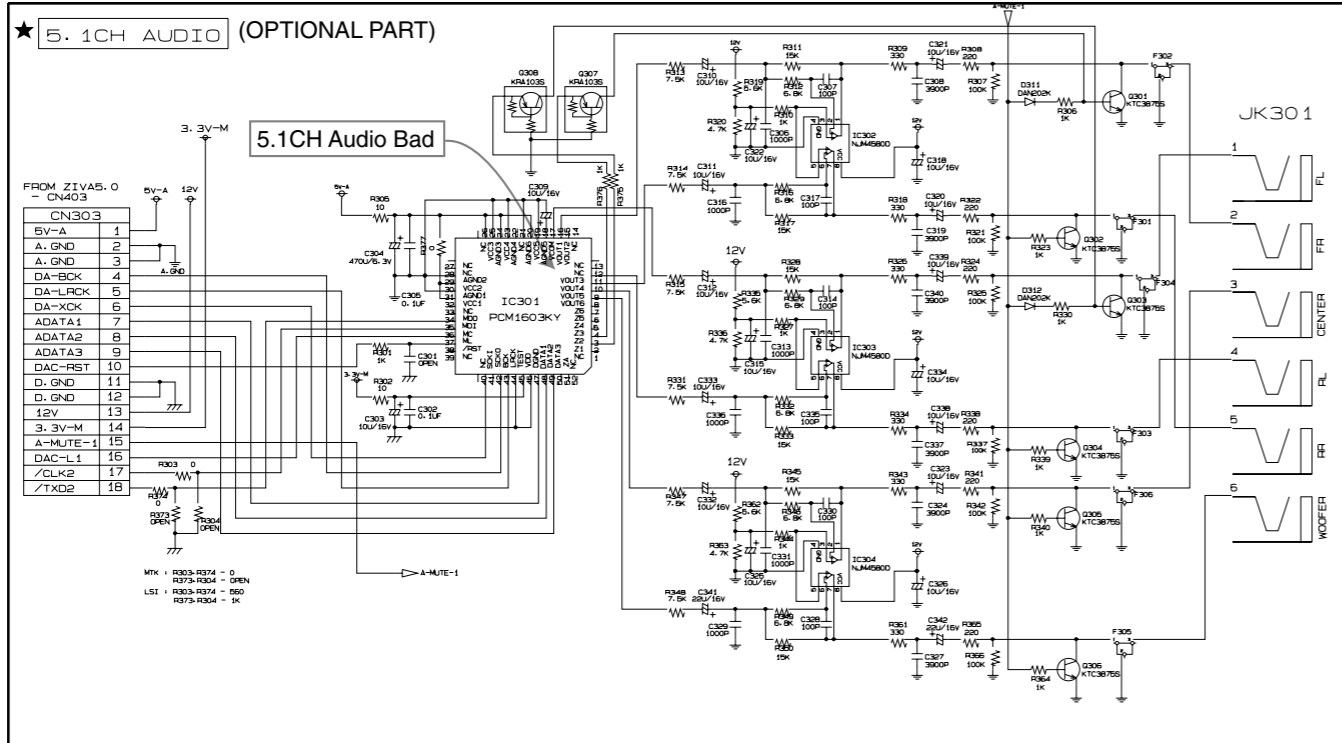
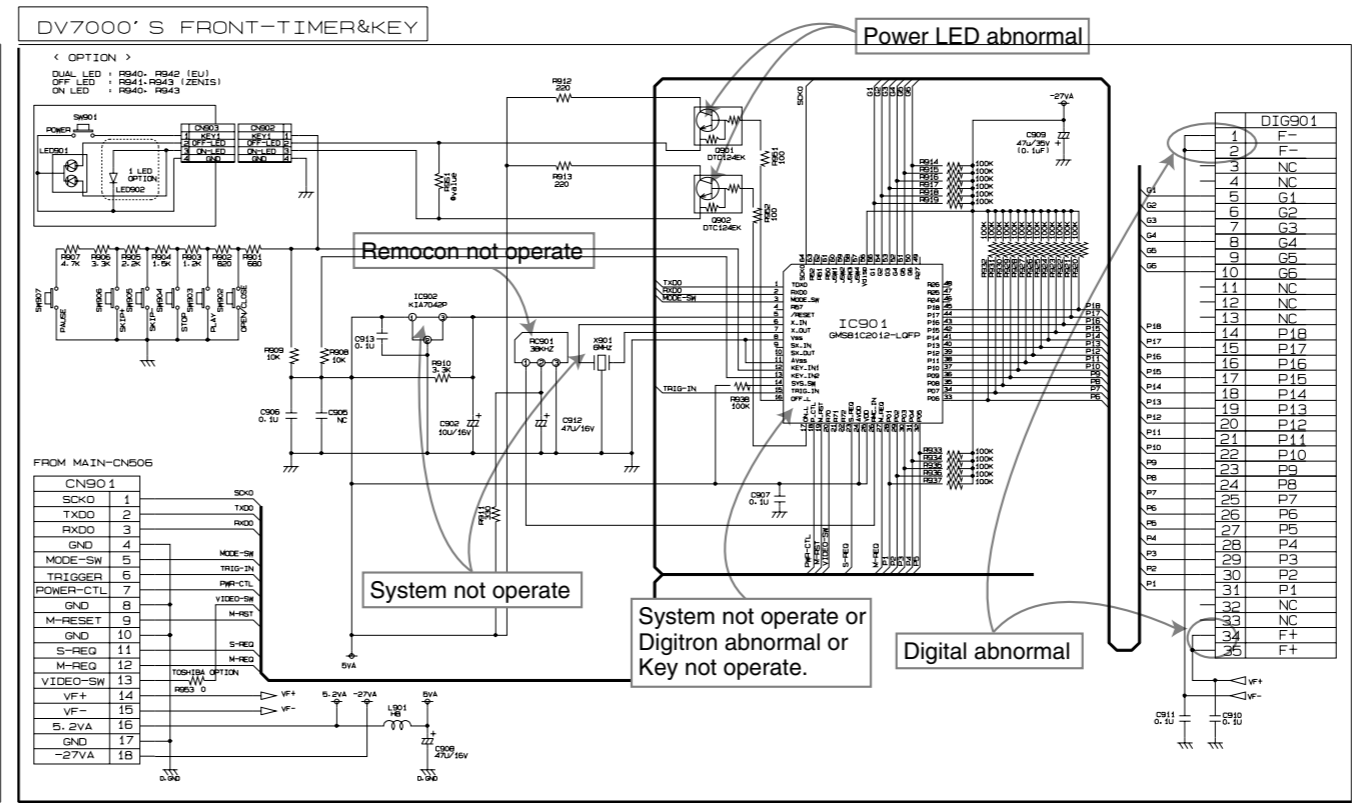
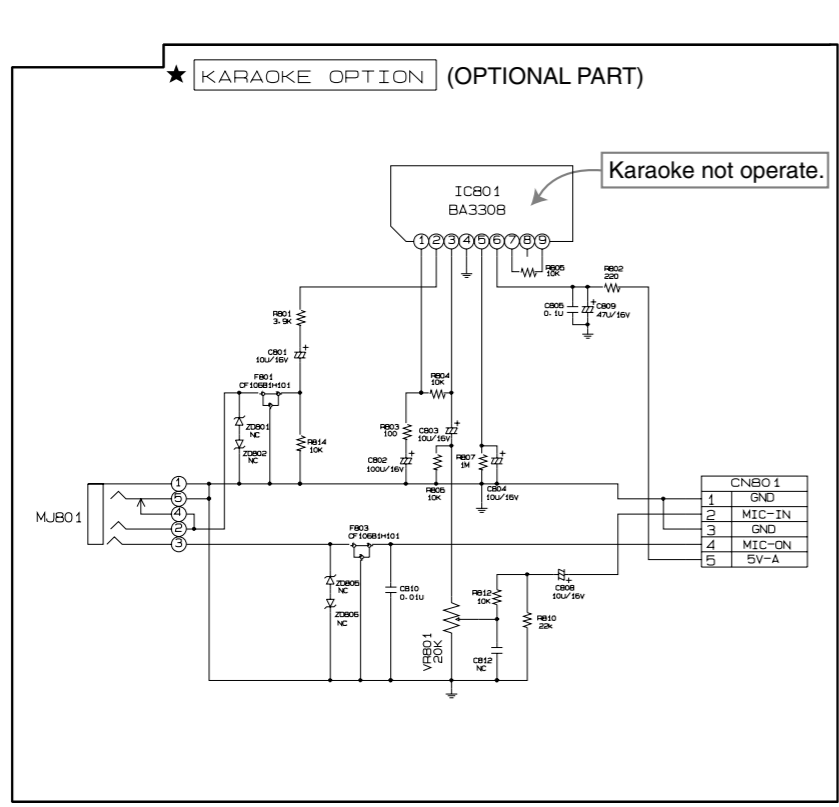

'03. 3. 10 R14603B  
TOSHIBA

# 5. AV/JACK CIRCUIT DIAGRAM

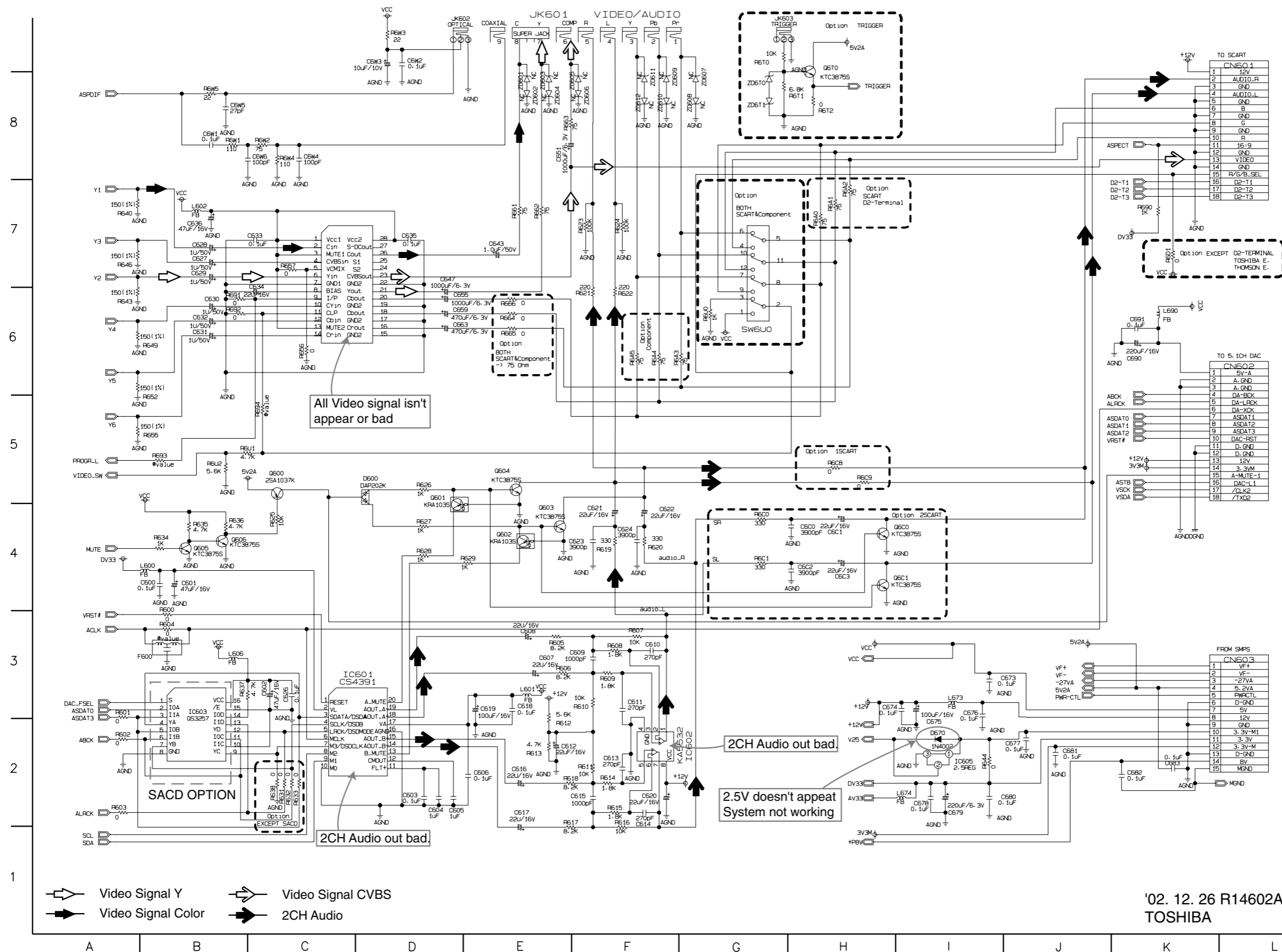

'02. 12. 26 R14602A  
TOSHIBA

• CIRCUIT VOLTAGE CHART

PIN	IC201(MT1338E)		IC202(MOTOR)		IC501(MT1379)		IC502(SDRAM)		IC505(EEPROM)		IC510(BUFFER)		IC5A1(FLASH)		IC5K1(KARAOKE)		IC601(CS4391)		IC602(AMP)		IC604(MM1623FBE)	
	STOP	PLAY	STOP	PLAY	STOP	PLAY	STOP	PLAY	STOP	PLAY	STOP	PLAY	STOP	PLAY	STOP	PLAY	STOP	PLAY	STOP	PLAY	STOP	PLAY
1	1.03	2.99	0	0	1.22	1.22	3.27	3.28	0	0	0	0	0.08	0.16	2	0	3.28	3.29	5.52	5.49	5.09	5.08
2	5.11	5.08	0	0	0	0	1.18	1.26	0	0	2.59	2.55	1.82	0.45	1.64	1.63	3.28	3.28	5.52	5.48	2.43	2.42
3	0	0	8.04	8.01	0.96	0.9	1.1	1.52	0	0	0	0	2.84	0	1.64	1.64	0	1.65	5.51	5.47	5.09	5.08
4	0	0	0.12	0.06	2	2.06	0	0	0	0	2.59	2.56	2.83	3.12	1.58	1.56	1.63	1.64	0	0	1.45	0
5	5.11	5.07	0	0.06	0	1.51	0.66	1.07	3.28	3.29	0	0	0.69	0.26	2.23	2.23	1.64	1.65	5.51	5.48	0	0
6	0	1.95	3.64	3.69	1.48	1.47	0.85	1.12	3.28	3.29	3.24	3.23	1.72	0.25	0	0	1.59	1.61	5.51	5.48	1.45	1.69
7	0	0	3.62	3.61	0	1.56	3.27	3.28	0	0	0	0	1.92	0.9	5.12	5.08	0	0	5.52	5.47	0	0
8	0	0	3.64	3.53	3.2	1.52	0.51	0.97	3.28	3.29	0.14	0.08	1.7	1.45	2.23	2.23	3.28	0	12.03	12.03	2.47	2.46
9	5.11	0	3.6	3.76	0.12	0.06	3.06	0	0	0	0	0	0	0	0	0	3.28	3.29	0	0	0	0
10	5.11	5.08	3.62	2.43	0.12	0.06	0	0	0	0	0	0	0	0	0	0	0	0	0	1.14	1.76	
11	5.11	5.08	3.63	4.85	3.25	3.25	0.06	0.98	0	0	0.15	0.09	3.27	3.29	0	0	5.01	5.01	0	0	0	0
12	0	0	3.62	3.72	1.41	1.49	3.18	0.87	0	0	0	0	3.56	3.55	0	0	2.31	2.31	0	0	2.42	2.42
13	5.11	0	3.64	3.57	1.41	1.41	3.27	3.28	0	0	0.15	0.08	3.29	3.29	0	0	4.96	0	0	0	5.09	5.08
14	5.11	5.08	8.04	8.01	0	0	2.94	2.56	0	0	5.19	5.19	0	0	0	0	1.42	2.41	0	0	2.43	2.42
15	2.84	2.81	1.45	1.48	1.42	1.42	0.47	0.42	0	0	0.14	0.09	0.23	0.06	0	0	2.4	2.39	0	0	0	0
16	1.45	1.43	0.27	1.39	3.3	0	2.93	3.01	0	0	5.25	5.24	0	0	0	0	0	0	0	0	2.49	2.47
17	2.08	2.07	0.29	1.32	2.53	2.53	3.21	3.22	0	0	0.15	0.08	0	0	0	0	5.11	5.09	0	0	0	0
18	1.37	1.42	1.45	1.43	1.42	2.27	2.87	2.95	0	0	5.23	5.23	0	0.87	0	0	2.41	2.41	0	0	2.48	2.47
19	0.69	2.3	1.45	1.43	1.42	1.39	0.15	1.32	0	0	0	0	1.98	2.64	0	0	2.43	2.43	0	0	0	0
20	2.4	0	1.45	0.82	0	0	0	0.05	0	0	5.25	5.25	2.28	2.18	0	0	0	0	0	0	1.18	2.3
21	2.35	0	1.45	1.43	2.61	2.58	3.09	1.32	0	0	0	0	2.13	1.96	0	0	0	0	0	0	1.76	2.17
22	5.11	5.08	1.45	1.43	0.75	1.46	3.09	1.32	0	0	0	0	1.67	2.01	0	0	0	0	0	0	0	0
23	0	0	1.47	1.37	2.83	1	3.09	1.32	0	0	0	0	1.99	1.72	0	0	0	0	0	0	1.76	2.24
24	2.59	3.2	1.45	1.43	1.9	0.89	3.09	1.33	0	0	0	0	1.93	2.19	0	0	0	0	0	0	0	0
25	0.19	1.88	1.45	1.43	1.72	0.39	3.27	3.29	0	0	0	0	2.05	1.94	0	0	0	0	0	0	0	0
26	1.58	0	0.95	0.91	0.68	0.31	0	0	0	0	0	0	0	0	0	0	0	0	0	0	0	0
27	2.56	3.13	0	0	2.84	3.16	0.15	1.36	0	0	0	0	0	0	0	0	0	0	0	0	0.06	0.05
28	2	2.01	1.45	1.43	0	0	1.84	2.36	0	0	0	0	0	0	0	0	0	0	0	0	5.09	0
29	2	2.06	5.15	5.11	2.85	0.66	1	2.32	0	0	0	0	1.49	2.03	0	0	0	0	0	0	0	0
30	2.96	1.52	1.45	1.43	1.83	0.49	0.54	1.75	0	0	0	0	0.16	1.07	0	0	0	0	0	0	0	0
31	0	0	1.45	1.43	0.91	1.39	0.06	0.06	0	0	0	0	1.96	1.25	0	0	0	0	0	0	0	0
32	0.06	2.07	1.45	1.43	1.43	1.2	0.05	0.06	0	0	0	0	0.16	1.1	0	0	0	0	0	0	0	0
33	0.07	2.07	1.46	1.45	1.51	1.57	0	0	0	0	0	0	0.99	2.2	0	0	0	0	0	0	0	0
34	0	0	5.08	5.06	1.51	1.43	0.73	1.26	0	0	0	0	1.17	1.07	0	0	0	0	0	0	0	0
35	0	0	5.15	5.11	3.3	3.29	1.48	1.55	0	0	0	0	0.79	1.82	0	0	0	0	0	0	0	0
36	0	0	0	0	0.81	1.26	2.91	2.53	0	0	0	0	0.15	1.07	0	0	0	0	0	0	0	0
37	5.13	0	0	0	1.45	1.02	0.07	0	0	0	0	0	3.29	3.3	0	0	0	0	0	0	0	0
38	0	0	0	0	1.82	1.6	3.27	3.28	0	0	0	0	1.93	3.09	0	0	0	0	0	0	0	0
39	0	0	0	0	1.2	1.5	1.06	1.05	0	0	0	0	0.16	1.07	0	0	0	0	0	0	0	0
40	0	0	0	0	2	2.06	0.47	0.98	0	0	0	0	1.5	2.2	0	0	0	0	0	0	0	0
41	0	0	0	0	2.17	1.95	0	0	0	0	0	0	0.16	1.07	0	0	0	0	0	0	0	0
42	5.12	5.09	0	0	2.53	2.52	0	0.6	0	0	0	0	1.21	2.64	0	0	0	0	0	0	0	0
43	5.12	5.09	0	0	1.96	1.9	1.12	1.24	0	0	0	0	0.16	1.08	0	0	0	0	0	0	0	0
44	5.12	5.09	0	0	1.79	1.9	3.27	3.28	0	0	0	0	1.64	1.48	0	0	0	0	0	0	0	0
45	5.12	5.09	0	0	0.8	1.72	1.21	0.99	0	0	0	0	2.05	2.06	0	0	0	0	0	0	0	0
46	5.12	5.09	0	0	0.8	1.96	1.31	1.34	0	0	0	0	0	0	0	0	0	0	0	0	0	0
47	0	0	0	0	0.8	1.84	0	0	0	0	0	0	0	0	0	0	0	0	0	0	0	0
48	5.12	5.09	0	0	3.3	2.63	1.43	1.44	0	0	0	0	0.07	0.13	0	0	0	0	0	0	0	0
49	5.12	0	0	0	0	0.13	0.88	1.01	0	0	0	0	0	0	0	0	0	0	0	0	0	0
50	5.08	5.06	0	0	0	0.07	0	0	0	0	0	0	0	0	0	0	0	0	0	0	0	0
51	5.09	5.07	0	0	0	0	0	0	0	0	0	0	0	0	0	0	0	0	0	0	0	0
52	5.1	0	0	0	0	0	0	0	0	0	0	0	0	0	0	0	0	0	0	0	0	0
53	0	0	0	0	0	0	0	0	0	0	0	0	0	0	0	0	0	0	0	0	0	0
54	5.13	0	0	0	0	0	0	0	0	0	0	0	0	0	0	0	0	0	0	0	0	0
55	0.09	0.2	0	0	3.25	3.27	0	0	0	0	0	0	0	0	0	0	0	0	0	0	0	0
56	1.61	0	0	0	1.21	1.18	0	0	0	0	0	0	0	0	0	0	0	0	0	0	0	0
57	0	0	0	0	0	0	0	0	0	0	0	0	0	0	0	0	0	0	0	0	0	0
58	0	0	0	0	3.29	3.29	0	0	0	0	0	0	0	0	0	0	0	0	0	0	0	0
59	0	0	0	0	0	0	0	0	0	0	0	0	0	0	0	0	0	0	0	0	0	0
60	0	0	0	0	0	0	0	0	0	0	0	0	0	0	0	0	0	0	0	0	0	0
61	3.28	0	0	0	2.59	2.57	0	0	0	0	0	0	0	0	0	0	0	0	0	0	0	0
62	0	0	0	0	2.58	2.58	0	0	0	0	0	0	0	0	0	0	0	0	0	0	0	0
63	0	0	0	0	0	0	0	0	0	0	0	0	0	0	0	0	0	0	0	0	0	0
64	0	0	0	0	2.59	2.56	0	0	0	0	0	0	0	0	0	0	0	0	0	0	0	0
65	0	0	0	0	3.29	3.29	0	0	0	0	0	0	0	0	0	0	0	0	0	0	0	0
66	0.26	0	0	0	3.3	3.29	0	0	0	0	0	0	0	0	0	0	0	0	0	0	0	0
67	5.12	5.08	0	0	3.29	3.29	0	0	0	0	0	0	0	0	0	0	0	0	0	0	0	0
68	0	0	0	0	2.57	2.56	0	0	0	0	0	0	0	0	0	0	0	0	0	0	0	0
69	5.12	0	0	0	5.19	5.18	0	0	0	0	0	0	0	0	0	0	0	0	0	0	0	0
70	3.21	2.03	0	0	2.59	2.57	0	0	0	0	0	0	0	0	0	0	0	0	0	0	0	0
71	3.46	2.2	0	0	0.12	0.08	0	0	0	0	0	0	0	0	0	0	0	0	0	0	0	0
72	2.81	0	0	0	2.53	2.52	0	0	0	0	0	0	0	0	0	0	0	0	0	0	0	0
73	0	0	0	0																		

PIN	IC201(MT1336E)		IC202(MOTOR)		IC501(MT1379)		IC502(SDRAM)		IC505(EEPROM)		IC510(BUFFER)		IC5A1(FLASH)		IC5K1(KARAOKE)		IC601(CS4391)		IC602(AMP)		IC604(MM1623XFB)		
	STOP	PLAY	STOP	PLAY	STOP	PLAY	STOP	PLAY	STOP	PLAY	STOP	PLAY	STOP	PLAY	STOP	PLAY	STOP	PLAY	STOP	PLAY	STOP	PLAY	
161					0	1.27																	
162					0	2.35																	
163					0	0																	
164					0	0.73																	
165					0	3.27																	
166					0	0.5																	
167					0	0																	
168					0	0.53																	
169					0	3.27																	
170					0	0.59																	
171					0	0																	
172					3.01	0.72																	
173					0	0.72																	
174					0	0																	
175					0	2.73																	
176					0	3.13																	
177					0	3.13																	
178					0	3.25																	
179					0	0																	
180					0	0																	
181					2.04	2.64																	
182					0	2.52																	
183					0	0																	
184					0	0.09																	
185					0	3.26																	
186					-	-																	
187					0	0.08																	
188					0	0																	
189					0	0																	
190					0	0																	
191					0.23	0																	
192					0	3.29																	
193					0	0																	
194					0	0																	
195					0	0																	
196					0	0																	
197					0	1.63																	
198					0	0																	
199					0	0																	
200					0	2.15																	
201					0	1.44																	
202					0	1.44																	
203					0	1.43																	
204					0	1.43																	
205					0	1.42																	
206					0	2.1																	
207					0	2.07																	
208					0	1.41																	
209					0	1.52																	
210					0	1.43																	
211					0	2.81																	
212					0	3.28																	
213					0	0.12																	
214					0	0.12																	
215					1.02	1.43																	
216					0	1.43																	

	Q201		Q202		Q203		Q204		Q205	
	STOP	PLAY	STOP	PLAY	STOP	PLAY	STOP	PLAY	STOP	PLAY
E	0	0	0	0	0	0	5.14	4.34	5.14	5.1
C	0	5.09	0	0	0	0.19	0	2.42	0.5	0
B	0.68	0	0	5.04	5.04	0	5.08	3.64	5.08	5.05
	Q501		Q600		Q603		Q604		Q605	
	STOP	PLAY	STOP	PLAY	STOP	PLAY	STOP	PLAY	STOP	PLAY
E	0	0	5.17	0	0	0	0	0	0	0
C	0	0	0	0.13	0	0	0	0	0	0
B	0.83	0.83	5.11	0	0.75	0	0.75	0.16	0.74	0.74



## 2. KEY P.C.BOARD

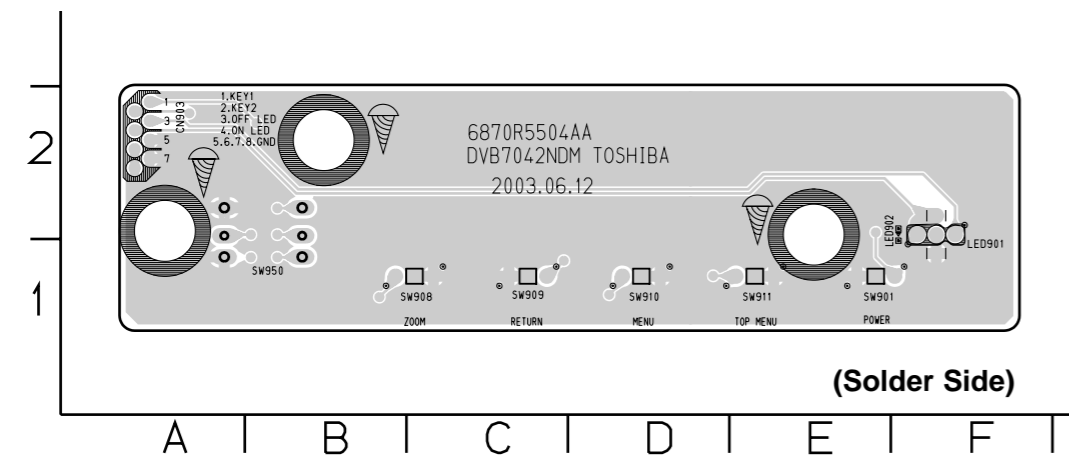

## 3. TIMER P.C.BOARD

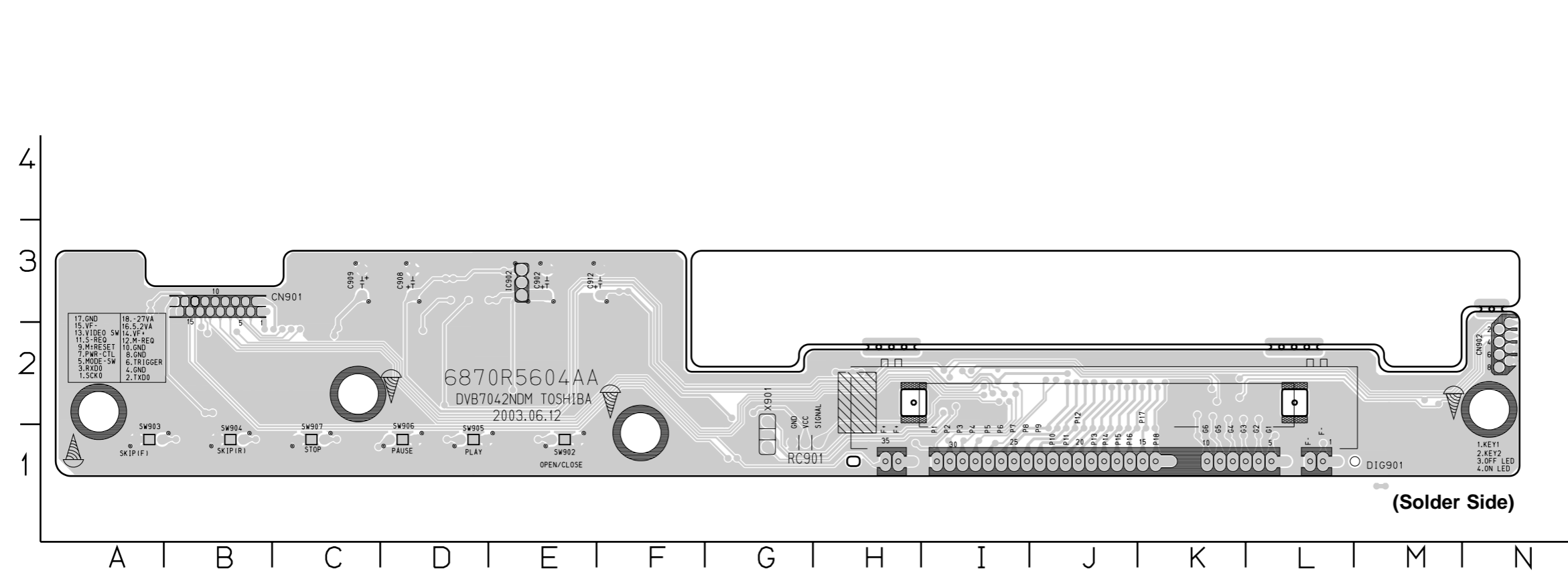

### LOCATION GUIDE

C902	E3	R917	L1
C905	D3	R918	L1
C906	D3	R919	L1
C907	I2	R920	K1
C908	D3	R921	K1
C909	C3	R922	J1
C910	G1	R923	J1
C911	L1	R924	J1
C912	F3	R925	J1
C913	D3	R926	J1
C9A1	G2	R927	J1
CN901	B3	R928	J1
CN902	N2	R929	J1
DIG901	L1	R930	J1
IC901	I2	R931	J1
IC902	E3	R932	J1
L901	D3	R933	I1
Q901	L2	R934	I1
Q902	L2	R935	I1
R901	D2	R936	I1
R902	B2	R937	I1
R903	B1	R938	E3
R904	C1	R951	K2
R905	C1	R952	K2
R906	C1	R953	E2
R907	C1	R951	M2
R908	D3	RC901	H1
R909	D3	SW902	E1
R910	D3	SW903	A1
R911	E3	SW904	B1
R912	L2	SW905	D1
R913	L2	SW906	D1
R914	K1	SW907	C1
R915	K1	X901	G1
R916	K1		

#### 4. SMPS P.C.BOARD

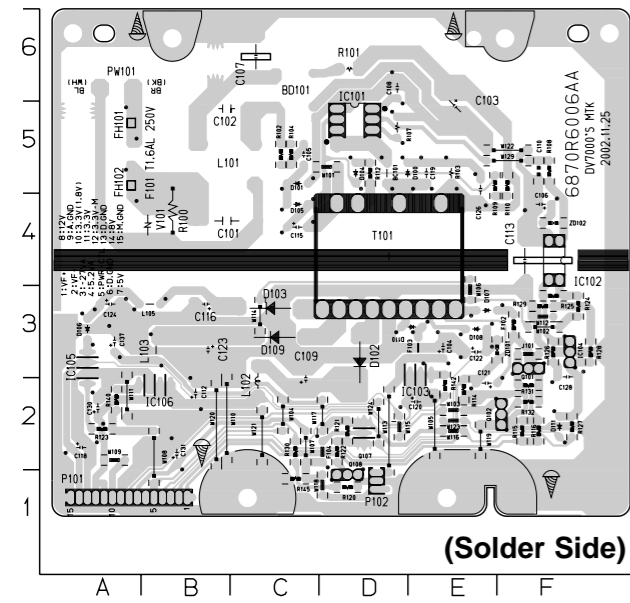

LOCATION GUIDE

BC101	D5	D104	D5	R101	D6
B0101	G6	D105	C4	R102	E5
C101	B4	D106	A3	R103	E5
C102	B5	D107	E3	R104	C5
C103	E5	D108	E3	R107	D5
C104	E3	D109	C3	R108	F5
C105	C5	D110	E3	R109	E5
C106	F4	D111	F2	R110	F5
C107	C6	F102	F3	R112	D5
C108	D6	F103	E3	R114	E2
C109	C2	F104	D2	R115	F2
C110	F5	FH01	A5	R116	F2
C112	B2	FH02	A5	R120	D1
C113	F4	IC101	D5	R121	D2
C115	C4	IC102	F4	R122	D2
C116	B3	IC103	D3	R123	A2
C118	A2	IC104	F3	R124	F3
C119	E5	IC105	A3	R125	F3
C120	E2	IC106	B2	R126	F3
C121	E2	J101	F3	R127	F2
C122	E3	L101	B5	R128	G4
C123	B3	L102	C2	R129	F3
C124	A3	L103	B3	R130	C2
C126	E5	L105	B3	R131	F3
C128	A3	P101	B1	R132	F2
C130	A2	P102	D1	R140	A2
C131	B2	PW101	A6	R142	E2
C137	A3	Q101	F3	R145	C1
D100	D5	Q102	F2	T101	D4
D101	C5	Q107	D2	T101	B4
D102	D3	Q108	D1	ZD101	F3
D103	C3	R100	B4	ZD102	F4

#### 5. 5.1CH P.C.BOARD

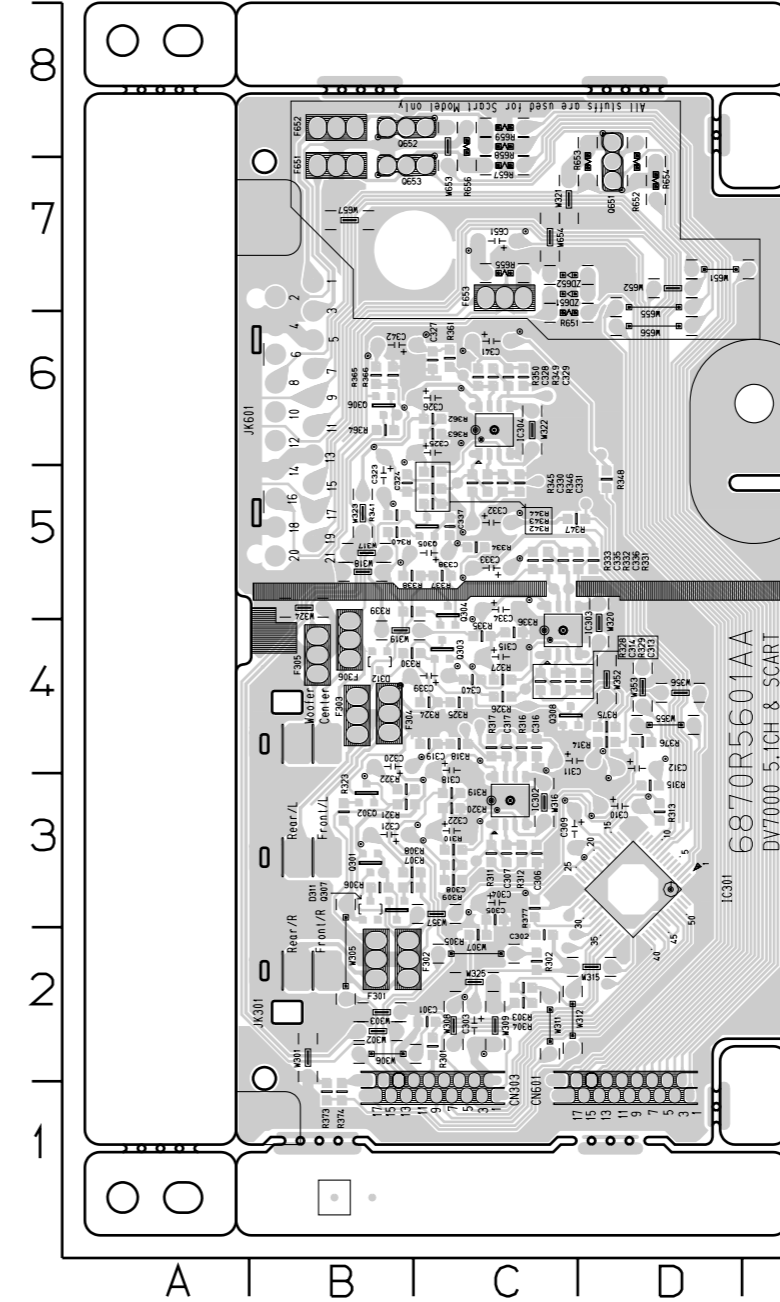

LOCATION GUIDE

C303	C2
C304	C3
C309	C3
C310	D3
C311	C4
C312	D4
C315	C4
C318	C4
C320	B4
C321	B3
C322	C3
C323	B5
C325	C6
C326	C6
C332	C5
C333	C5
C334	C5
C338	C5
C339	C4
C341	C6
C342	B6
C651	C7
CN303	C1
CN601	D1
F301	B2
F302	B2
F303	B4
F304	B4
F305	B4
F306	B4
F651	B7
F652	B8
F653	C7
JK301	B3
JK601	B6
Q651	D7
Q652	B8
Q653	B7
R651	C6
R652	D7
R653	D7
R654	D7
R655	C7
R656	C8
R657	C7
R658	C8
R659	C8
ZD651	C7
ZD652	C7

(Solder Side)

# SECTION 4 MECHANISM OF DVD PART

## CONTENTS

---

### DECK MECHANISM PARTS LOCATIONS

- Top View.....4-1
- Top View(without Tray Disc) .....4-1
- Bottom View .....4-1

### DECK MECHANISM DISASSEMBLY

1. Holder Clamp.....4-2
  - 1-1. Clamp Assembly Disc.....4-2
    - 1-1-1. Plate Clamp .....4-2
    - 1-1-2. Magnet Clamp .....4-2
    - 1-1-3. Clamp Upper.....4-2
2. Tray Disc .....4-2
3. Base Assembly Sled .....4-3
  - 3-1. Gear Assembly Feed .....4-3
  - 3-2. Gear Assembly Middle.....4-3
  - 3-3. Gear Assembly Rack.....4-3
4. Rubber Rear.....4-3

5. Frame Assembly Up/Down.....4-4
6. Belt Loading.....4-4
7. Gear Pulley .....4-4
8. Gear Loading .....4-4
9. Guide Up/Down.....4-4
10. PWB Assembly Loading .....4-4
11. Base Main.....4-4

### EXPLODED VIEW

1. Deck Mechanism Exploded View....4-5



# DECK MECHANISM PARTS LOCATION

## • Top View (With Tray)

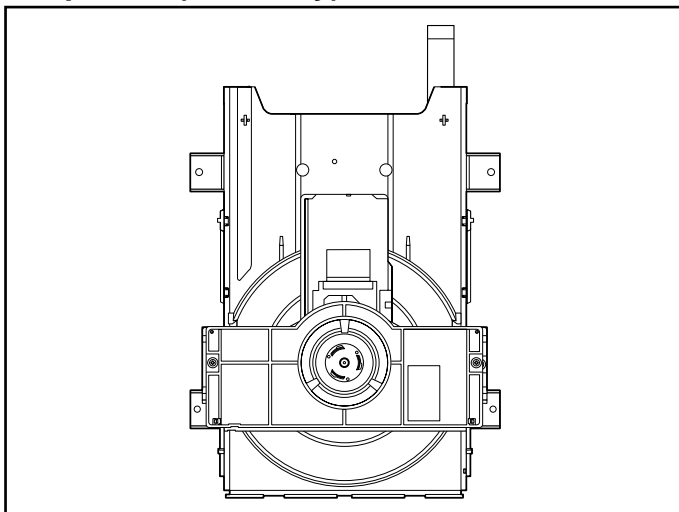

## • Top View (Without Tray)

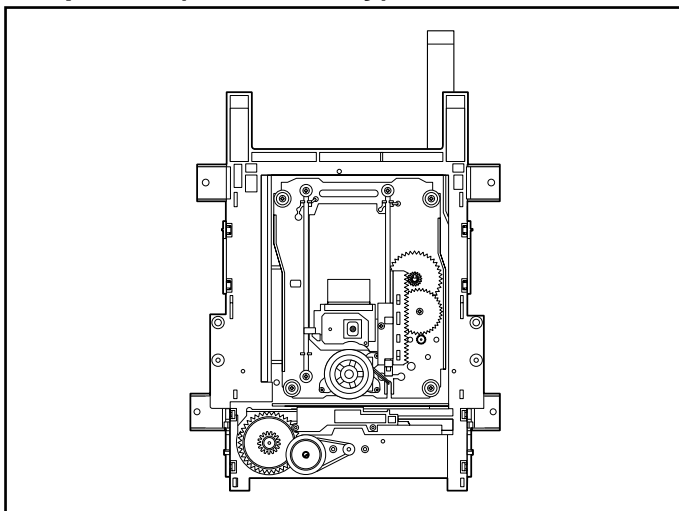

## • Bottom View

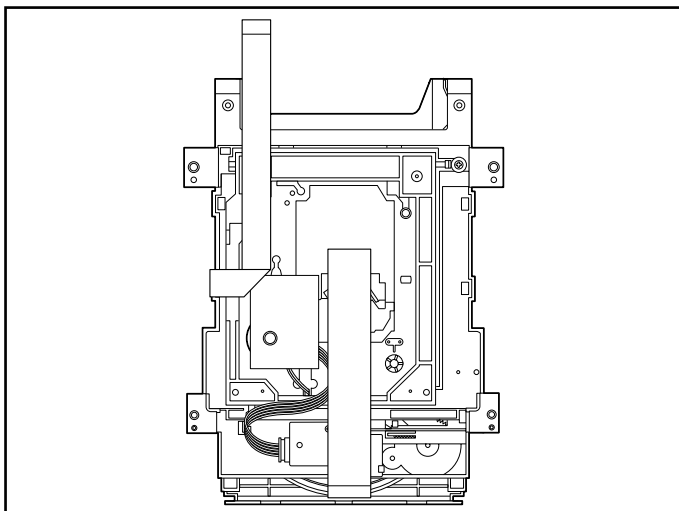

Procedure		Parts	Fixing Type	Disassembly	Figure
Starting No.					
	1	Holder Clamp	2 Screws, 2 Locking Tabs		4-1
1	2	Clamp Assembly Disc			4-1
1, 2	3	Plate Clamp			4-1
1, 2, 3	4	Magnet Clamp			4-1
1, 2, 3, 4	5	Clamp Upper			4-1
1	6	Tray Disc			4-2
1, 6	7	Base Assembly Sled	4 Screws,		4-3
1, 2, 6	8	Gear Assembly Feed			4-3
1, 2, 6, 8	9	Gear Middle			4-3
1, 2, 6, 8, 9	10	Gear Assembly Rack	1 Screw		4-3
1, 2, 7	11	Rubber Rear			4-3
1, 2, 7	12	Frame Assembly Up/Down	1 Screw	Bottom	4-4
1, 2	13	Belt Loading	1 Locking Tab		4-4
1, 2, 13	14	Gear Pulley			4-4
1, 2, 13, 14	15	Gear Loading	1 Locking Tab		4-4
1, 2, 7, 12, 13, 14	16	Guide Up/Down			4-4
1, 2, 13	17	PWB Assembly Loading	1 Locking Tab 1 Hook 2Screw	Bottom	4-4
1, 2, 7, 12, 13, 14, 15, 16, 17	18	Base Main			4-4

### Note

When reassembling, perform the procedure in reverse order.

The "Bottom" on Disassembly column of above Table indicates the part should be disassembled at the Bottom side.

# DECK MECHANISM DISASSEMBLY

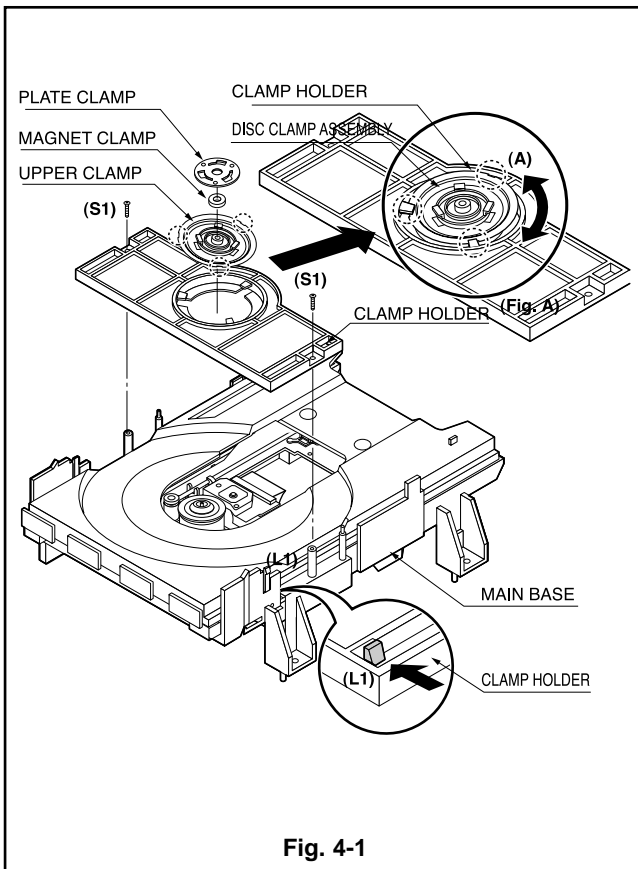

Fig. 4-1

## 1. Holder Clamp (Fig. 4-1)

- 1) Release 2 Screws(S1).
- 2) Unhook 2 Locking Tabs(L1).
- 3) Lift up the Holder Tabs and then separate it from the Base Main.

### 1-1. Clamp Assembly Disc

- 1) Place the Clamp Assembly Disc as Fig. (A)
- 2) Lift up the Clamp Assembly Disc in direction of arrow(A).
- 3) Separate the Clamp Assembly Disc from the Holder Clamp.

### 1-1-1. Plate Clamp

- 1) Turn the Plate Clamp to counterclockwise direction and then lift up the Plate Clamp.

### 1-1-2. Magnet Clamp

### 1-1-3. Clamp Upper

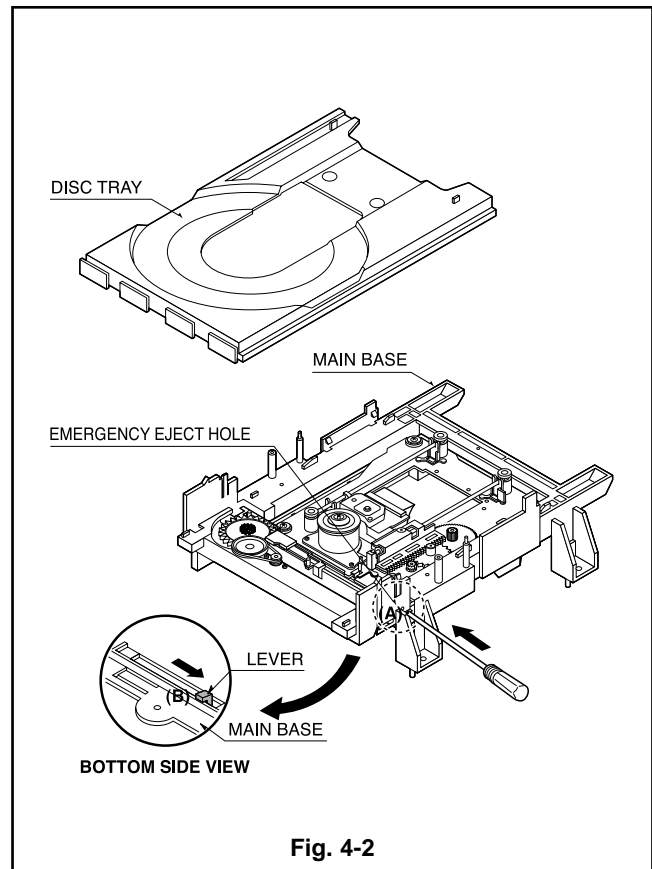

Fig. 4-2

## 2. Tray Disc (Fig. 4-2)

- 1) Insert and push a Driver in the emergency eject hole(A) at the right side, or put the Driver on the Lever(B) of the Gear Emergency and pull the Lever(B) in direction of arrow so that the Tray Disc is ejected about 15~20mm.
- 2) Pull the Tray Disc until it is separated from the Base Main completely.

# DECK MECHANISM DISASSEMBLY

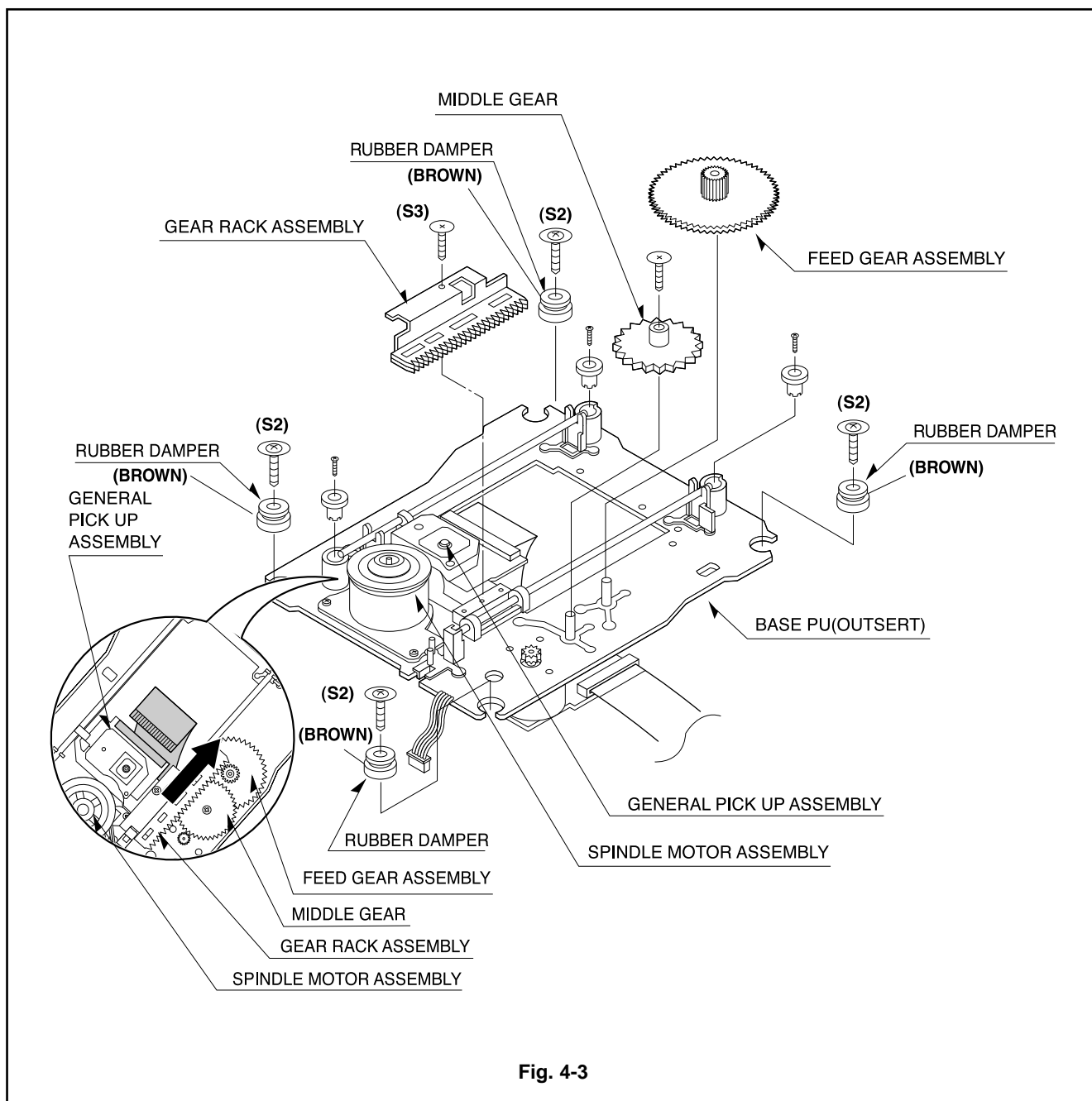

Fig. 4-3

### 3. Base Assembly Sled (Fig. 4-3)

- 1) Release 4 Screw(S2).
- 2) Disconnect the FFC Connector(C1)

#### 3-1. Gear Assembly Feed

#### 3-2. Gear Assembly Middle

### 3-3. Gear Assembly Rack

- 1) Release the Screw(S3)

### 4. Rubber Rear (Fig. 4-3)

# DECK MECHANISM DISASSEMBLY

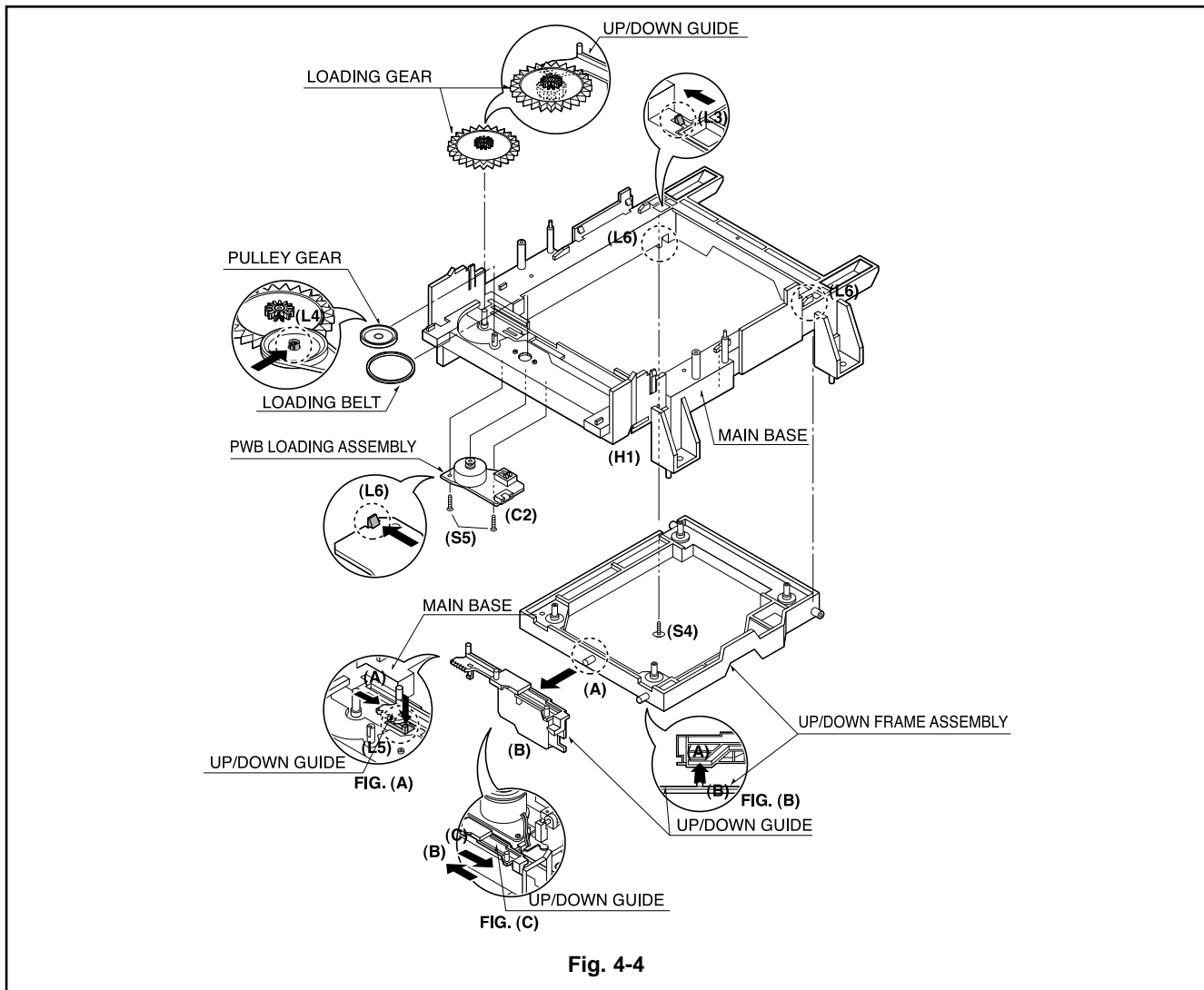

Fig. 4-4

## 5. Frame Assembly Up/Down (Fig. 4-4)

### Note

Put the Base Main face down(Bottom Side)

- 1) Release the Screw(S4)
- 2) Unlock the Locking Tab(L3) in direction of arrow and then lift up the Frame Assembly Up/Down to separate it from the Base Main.

### Note

- When reassembling move the Guide Up/Down in direction of arrow(C) until it is positioned as Fig.(C).
- When reassembling insert (A) portion of the Frame Assembly Up/Down in the (B) portion of the Guide Up/Down as Fig.(B)

## 6. Belt Loading(Fig. 4-4)

### Note

Put the Base Main on original position(Top Side)

## 7. Gear pulley (Fig. 4-4)

- 1) Unlock the Locking Tab(L4) in direction of arrow(B) and then separate the Gear Pulley from the Base Main.

## 8. Gear Loading (Fig. 4-4)

## 9. Guide Up/Down (Fig. 4-4)

- 1) Move the Guide Up/Down in direction of arrow(A) as Fig.(A)
- 2) Push the Locking Tab(L5) down and then lift up the Guide Up/Down to separate it from the Base Main.

### Note

When reassembling place the Guide Up/Down as Fig.(C) and move it in direction arrow(B) until it is locked by the Locking Tab(L5). And confirm the Guide Up/Down as Fig.(A)

## 10. PWB Assembly Loading (Fig. 4-4)

### Note

Put the Base Main face down(Bottom Side)

- 1) Release 2 Screws(S5)
- 2) Unlock the Loading Motor (C2) from the Hook (H1) on the Base Main.
- 3) Unlock 2 Locking Tabs(L6) and separate the PWB Assembly Loading from the Base Main.

## 11. Base Main(Fig. 4-4)

# MEMO

A series of horizontal dotted lines for writing.

# EXPLODED VIEWS

## 1. Deck Mechanism Exploded View

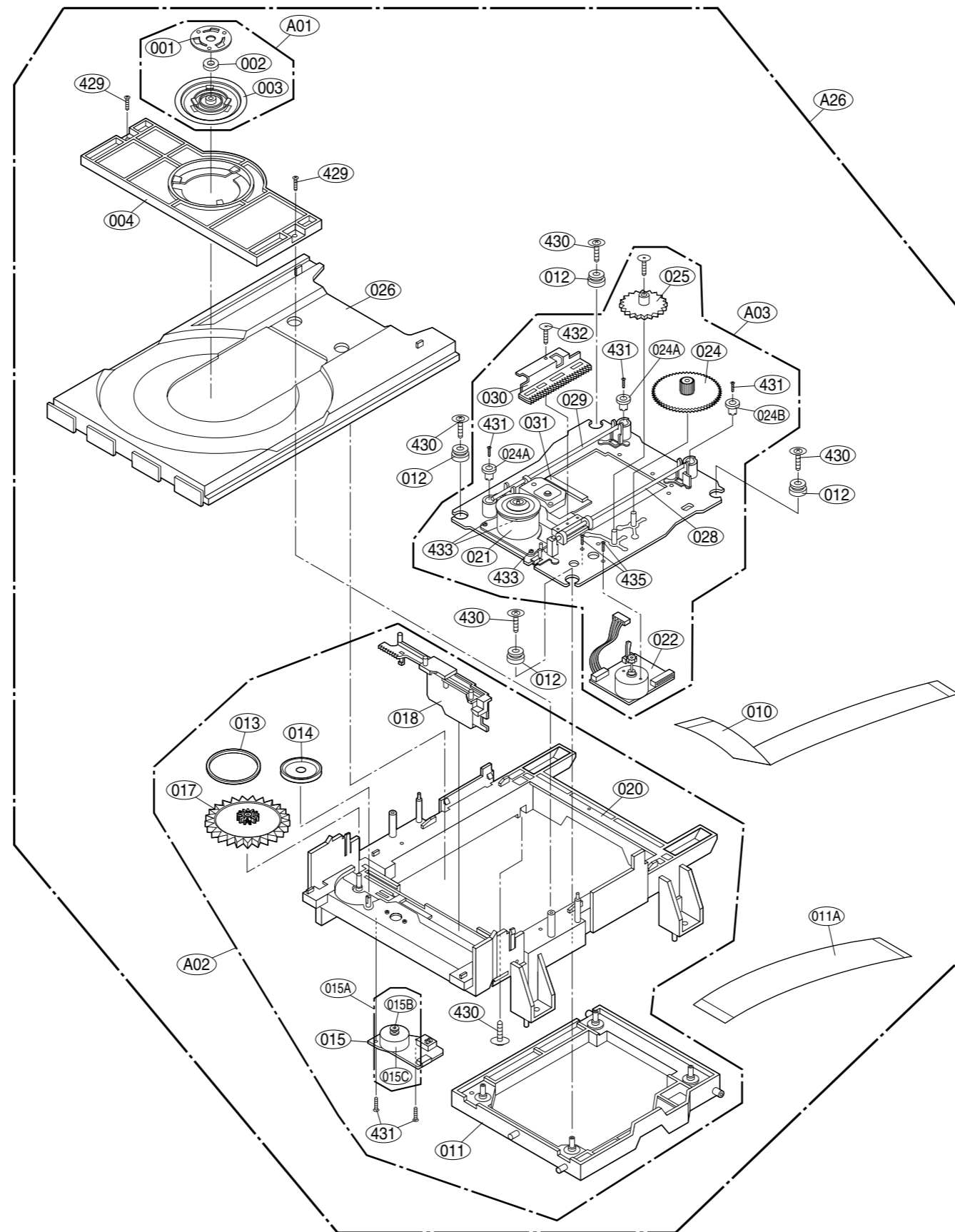

# MEMO

Lined area for writing on the left page.

# MEMO

Lined area for writing on the right page.

NOTES)  Warning  
Parts that are shaded are critical  
With respect to risk of fire or  
electrical shock.

# SECTION 5 REPLACEMENT PARTS LIST

TOSHIBA MODEL : SD-4900-S-TU/SD-4900-S-TC

NSP : Not available as service parts.

RUN DATE : 27-JULY-02

S	AL	LOCA. NO.	TOSHIBA PART	LG PART NO.	DESCRIPTION	SPECIFICATION	REMARKS
*** INDIVIDUAL PARTS ***							
		250	79096706	3110R-D001C	CASE	DVB7022NM PRESS 55-430-J597G W	
		283	AF000166	3580R-T091C	DOOR,CASE	DVD DVB7042NDM MOLD TRAY	
		300	79096072	6410RAHX02A	POWER CORD	SP-120P/JL001 CHAUS/JULIAN UL/	
		463	79096043	353-051G	SCREW,DRAWING	+ 2 D3.0 L8.0 MSWR3/FN TB ROUN	
		465	79097903	353-046K	SCREW	SPECIAL (3X10 B.K)	
*** PACKING ACCESSORY ***							
		801	AF000169	3835RS0060H	INSTRUCTION ASSEMBLY	DVD DVB7042NDM HA1UTT	SD-4900-S-TU
		801	AF000170	3835RS0060J	INSTRUCTION ASSEMBLY	DVD DVB7042NDM HA1CTT	SD-4900-S-TC
		802	AF000172	3890R-H820V	BOX	DVB7042NDM HA1UTT SWW3-A 0.870	SD-4900-S-TU
		802	AF000171	3890R-H820U	BOX	DVB7042NDM HA1CTT	SD-4900-S-TC
		803	79096672	3920R-E066A	PACKING,CASING	DV7000 0.02 68 EPS 10 1165 238	
		804	AF000019	292-053B	BAG	SOFT(MIDI)	NSP
		808	79096103	841-0021	BATTERY,MN	ER03X HI WATT 1.5V .MA/H AAA	
*** CABLE ASSY ***							
		810	79096094	6851RP0003N	CABLE ASSY,RF	DVD CABLE ASSY,RCA USING AREA	
		811	79096073	6611R1G001A	PLUG ASSY	1WAY YELLOW GLOBAL	
		812	AF000177	6611R2G001A	PLUG ASSY	2WAY RED/WHITE GLOBAL	
*** REMOTE CONTROLLER ***							
		900	79096699	6711R2N082A	REMOTE CONTROLLER ASSEMBLY	TOSHIBA DVB7021NM TOSHIBA SE-R	
*** PANEL ASSEMBLY & TIMER ***							
		A43	AF000165	3501RF8217A	BOARD ASSEMBLY	DVD DVB7042NDM HA1UTT	
		280	AF000168	3721R-F810A	PANEL ASSEMBLY,FRONT	DVD DVB7042NDM HA1UTT	
		452	79097905	353-051A	SCREW	SPECIAL	
		A42	AF000180	6871R-5705A	PWB(PCB) ASSEMBLY,TOTAL	DVB7042NDM TOSHIBA STEP UP KEY	
		A49	AF000179	6871R-5704A	PWB(PCB) ASSEMBLY,TOTAL	DVB7042NDM TOSHIBA STEP UP TIM	
		C902	79097104	0CE1064F638	CAPACITOR,ELECTROLYTIC	10M SRA 16V M FM5 TP(5)	
		C906	79092014	0CH1104K942	CAPACITOR,CHIP[CERAMIC M/L HD	0.1UF 50V Z Y5V(F) 1508 R/TP	
		C907	79092014	0CH1104K942	CAPACITOR,CHIP[CERAMIC M/L HD	0.1UF 50V Z Y5V(F) 1508 R/TP	
		C908	79098709	0CE2274C638	CAPACITOR,ELECTROLYTIC	220M SRA 6.3V M FM5 TP(5)	
		C909	79097109	0CE4764J638	CAPACITOR,AL.ELECTROLYTIC	47UF SRA,SS 35V M FM5 TP 5	
		C910	79092014	0CH1104K942	CAPACITOR,CHIP[CERAMIC M/L HD	0.1UF 50V Z Y5V(F) 1508 R/TP	
		C911	79092014	0CH1104K942	CAPACITOR,CHIP[CERAMIC M/L HD	0.1UF 50V Z Y5V(F) 1508 R/TP	
		C912	79097108	0CE4764F638	CAPACITOR,ELECTROLYTIC	47M SRA/SS 16V M FM5 TP(5)	
		C913	79092014	0CH1104K942	CAPACITOR,CHIP[CERAMIC M/L HD	0.1UF 50V Z Y5V(F) 1508 R/TP	
		DIG901	AF000176	6302R-V214A	DIGITRON	6BT-335GNK FUTABA SEG VFD DVD7	ALTERNATE
		DIG901	79096650	6302R-V205A	DIGITRON	HNV-06SC03T SS SDI SEG VFD DVD	
		DIG901	AF000176	6302RCV205A	DIGITRON	VFD16-0601FN ZEC SEG VFD TTL 1	ALTERNATE
		IC901	AF000155	0IMCRHY070B	IC,MICRO CONTROLLER	HMS81C2012A-HK006 HYNIX 64PIN	
		IC902	79098739	0IKE704200B	IC,KEC	KIA7042P 3P 4.2V RESET(TAPING)	
		L901	79091005	6200HJC102A	FILTER(CIRC),EMC	HB-1M2012-102JT CERATECH TP	
		LED901	79098732	0DL325319AA	LED	SPR325MVWT31 TP ROHM GREEN/RED	
		Q902	79095001	0TR103009AA	TRANSISTOR	CHIP KRC103S-T1(NC)22-22 KEC	
		R901	79093049	0RH6800C622	RESISTOR,METAL GLAZED(CHIP)	680 OHM 1 / 16 W 1608 5.00% D	
		R902	79096690	0RH8200C622	RESISTOR,METAL GLAZED(CHIP)	820 OHM 1 / 16 W 1608 5.00% D	
		R903	79093031	0RH1201C622	RESISTOR,METAL GLAZED(CHIP)	1.2K OHM 1 / 16 W 1608 5.00% D	
		R904	79093034	0RH1501C622	RESISTOR,METAL GLAZED(CHIP)	1.5K OHM 1 / 16 W 1608 5.00% D	
		R905	79093039	0RH2201C622	RESISTOR,METAL GLAZED(CHIP)	2.2K OHM 1 / 16 W 1608 5.00% D	
		R906	79093042	0RH3301C622	RESISTOR,METAL GLAZED(CHIP)	3.3K OHM 1 / 16 W 1608 5.00% D	
		R907	79093045	0RH4701C622	RESISTOR,METAL GLAZED(CHIP)	4.7K OHM 1 / 16 W 1608 5.00% D	



S	AL	LOCA. NO.	TOSHIBA PART	LG PART NO.	DESCRIPTION	SPECIFICATION	REMARKS
		R908	79093029	0RH1002C622	RESISTOR,METAL GLAZED(CHIP)	10K OHM 1 / 16 W 1608 5.00% D	
		R909	79093029	0RH1002C622	RESISTOR,METAL GLAZED(CHIP)	10K OHM 1 / 16 W 1608 5.00% D	
		R910	79093042	0RH3301C622	RESISTOR,METAL GLAZED(CHIP)	3.3K OHM 1 / 16 W 1608 5.00% D	
		R911	79093041	0RH3300C622	RESISTOR,METAL GLAZED(CHIP)	330 OHM 1 / 16 W 1608 5.00% D	
		R913	79098771	0RH2200C622	RESISTOR,METAL GLAZED(CHIP)	220 OHM 1 / 16 W 1608 5.00% D	
		R914	79096030	0RH1003C622	RESISTOR,METAL GLAZED(CHIP)	100K OHM 1 / 16 W 1608 5.00% D	
		R915	79096030	0RH1003C622	RESISTOR,METAL GLAZED(CHIP)	100K OHM 1 / 16 W 1608 5.00% D	
		R916	79096030	0RH1003C622	RESISTOR,METAL GLAZED(CHIP)	100K OHM 1 / 16 W 1608 5.00% D	
		R917	79096030	0RH1003C622	RESISTOR,METAL GLAZED(CHIP)	100K OHM 1 / 16 W 1608 5.00% D	
		R918	79096030	0RH1003C622	RESISTOR,METAL GLAZED(CHIP)	100K OHM 1 / 16 W 1608 5.00% D	
		R919	79096030	0RH1003C622	RESISTOR,METAL GLAZED(CHIP)	100K OHM 1 / 16 W 1608 5.00% D	
		R920	79096030	0RH1003C622	RESISTOR,METAL GLAZED(CHIP)	100K OHM 1 / 16 W 1608 5.00% D	
		R921	79096030	0RH1003C622	RESISTOR,METAL GLAZED(CHIP)	100K OHM 1 / 16 W 1608 5.00% D	
		R922	79096030	0RH1003C622	RESISTOR,METAL GLAZED(CHIP)	100K OHM 1 / 16 W 1608 5.00% D	
		R923	79096030	0RH1003C622	RESISTOR,METAL GLAZED(CHIP)	100K OHM 1 / 16 W 1608 5.00% D	
		R924	79096030	0RH1003C622	RESISTOR,METAL GLAZED(CHIP)	100K OHM 1 / 16 W 1608 5.00% D	
		R925	79096030	0RH1003C622	RESISTOR,METAL GLAZED(CHIP)	100K OHM 1 / 16 W 1608 5.00% D	
		R926	79096030	0RH1003C622	RESISTOR,METAL GLAZED(CHIP)	100K OHM 1 / 16 W 1608 5.00% D	
		R927	79096030	0RH1003C622	RESISTOR,METAL GLAZED(CHIP)	100K OHM 1 / 16 W 1608 5.00% D	
		R928	79096030	0RH1003C622	RESISTOR,METAL GLAZED(CHIP)	100K OHM 1 / 16 W 1608 5.00% D	
		R929	79096030	0RH1003C622	RESISTOR,METAL GLAZED(CHIP)	100K OHM 1 / 16 W 1608 5.00% D	
		R930	79096030	0RH1003C622	RESISTOR,METAL GLAZED(CHIP)	100K OHM 1 / 16 W 1608 5.00% D	
		R931	79096030	0RH1003C622	RESISTOR,METAL GLAZED(CHIP)	100K OHM 1 / 16 W 1608 5.00% D	
		R932	79096030	0RH1003C622	RESISTOR,METAL GLAZED(CHIP)	100K OHM 1 / 16 W 1608 5.00% D	
		R933	79096030	0RH1003C622	RESISTOR,METAL GLAZED(CHIP)	100K OHM 1 / 16 W 1608 5.00% D	
		R934	79096030	0RH1003C622	RESISTOR,METAL GLAZED(CHIP)	100K OHM 1 / 16 W 1608 5.00% D	
		R935	79096030	0RH1003C622	RESISTOR,METAL GLAZED(CHIP)	100K OHM 1 / 16 W 1608 5.00% D	
		R936	79096030	0RH1003C622	RESISTOR,METAL GLAZED(CHIP)	100K OHM 1 / 16 W 1608 5.00% D	
		R937	79096030	0RH1003C622	RESISTOR,METAL GLAZED(CHIP)	100K OHM 1 / 16 W 1608 5.00% D	
		R938	79096030	0RH1003C622	RESISTOR,METAL GLAZED(CHIP)	100K OHM 1 / 16 W 1608 5.00% D	
		R940	79093049	0RH6800C622	RESISTOR,METAL GLAZED(CHIP)	680 OHM 1 / 16 W 1608 5.00% D	
		R941	79096690	0RH8200C622	RESISTOR,METAL GLAZED(CHIP)	820 OHM 1 / 16 W 1608 5.00% D	
		R942	79093031	0RH1201C622	RESISTOR,METAL GLAZED(CHIP)	1.2K OHM 1 / 16 W 1608 5.00% D	
		R943	79093034	0RH1501C622	RESISTOR,METAL GLAZED(CHIP)	1.5K OHM 1 / 16 W 1608 5.00% D	
		R944	79093039	0RH2201C622	RESISTOR,METAL GLAZED(CHIP)	2.2K OHM 1 / 16 W 1608 5.00% D	
		R945	79093020	0RH0000C622	RESISTOR,METAL GLAZED(CHIP)	0 OHM 1 / 16 W 1608 5.00% D	
		R946	79093042	0RH3301C622	RESISTOR,METAL GLAZED(CHIP)	3.3K OHM 1 / 16 W 1608 5.00% D	
		R947	79093045	0RH4701C622	RESISTOR,METAL GLAZED(CHIP)	4.7K OHM 1 / 16 W 1608 5.00% D	
		R948	79096480	0RH8201C622	RESISTOR,METAL GLAZED(CHIP)	8.2K OHM 1 / 16 W 1608 5.00% D	
		R952	79093027	0RH1000C622	RESISTOR,METAL GLAZED(CHIP)	100 OHM 1 / 16 W 1608 5.00% D	
		RC901	79096647	6712R1038GA	REMOTE CONTROLLER RECEIVER	TSOP2438SB1 VISHAY 38KHZ 10.2M	
		SW901	79097338	556-219B	SWITCH,TACT	THVV502GAA POSTECH DC 12 V 5-	
		SW902	79097338	556-219B	SWITCH,TACT	THVV502GAA POSTECH DC 12 V 5-	
		SW903	79097338	556-219B	SWITCH,TACT	THVV502GAA POSTECH DC 12 V 5-	
		SW904	79097338	556-219B	SWITCH,TACT	THVV502GAA POSTECH DC 12 V 5-	
		SW905	79097338	556-219B	SWITCH,TACT	THVV502GAA POSTECH DC 12 V 5-	
		SW906	79097338	556-219B	SWITCH,TACT	THVV502GAA POSTECH DC 12 V 5-	
		SW907	79097338	556-219B	SWITCH,TACT	THVV502GAA POSTECH DC 12 V 5-	
		SW908	79097338	556-219B	SWITCH,TACT	THVV502GAA POSTECH DC 12 V 5-	
		SW909	79097338	556-219B	SWITCH,TACT	THVV502GAA POSTECH DC 12 V 5-	
		SW910	79097338	556-219B	SWITCH,TACT	THVV502GAA POSTECH DC 12 V 5-	
		SW911	79097338	556-219B	SWITCH,TACT	THVV502GAA POSTECH DC 12 V 5-	
		SW950	79098796	6600RRB003A	SWITCH,TACT	SKQUAA ALPS DC 12 V 50 MA VER	
		X901	79097349	6212BA3004A	RESONATOR,CERAMIC	CSTLS6M00G53-A0 MURATA 6MHZ +/-	
<b>*** CHASSIS ASSEMBLY ***</b>							
		A44	AF000164	3141R-D011U	CHASSIS ASSEMBLY	DVB7042NDM MTK 55MM	NSP
		260	79096705	3140R-D002A	CHASSIS	DV7000 PRESS MAIN	
		261	79096653	5040R-0069D	RUBBER	FOOT(SILICONE SPONGE DS-08 T=	
		320	AF000167	3720R-D085U	PANEL,VIDEO	DVD DVB7042NDM PRESS MTK 55MM	
		467	79097904	353-046N	SCREW,DRAWING	SPECIAL(3X8 BK.)	

S	AL	LOCA. NO.	TOSHIBA PART	LG PART NO.	DESCRIPTION	SPECIFICATION	REMARKS
*** DECK ASSEMBLY ***							
		A00	79096645	6721RH0370A	DECK ASSEMBLY,VIDEO	DECK/MECHA DP-7(55) MITSUMI GO	NSP
		A01	AF000173	4861R-0016B	CLAMP ASSEMBLY	DISC DP7 - SH	
		A02	79096682	3041R-M003B	BASE ASSEMBLY	MAIN(DP-7R) - SH	
		A03	AF000163	3041R-M002B	BASE ASSEMBLY	SLED DP7(MIT 502W-GOLD) - SH	
		001	79097006	3300R-0547A	PLATE	CLAMP	NSP
		002	79097007	5016H-1016B	MAGNET	CLAMP(LDM-R608,10*5,1*1.5T)	NSP
		003	AF000069	4860R-0021A	CLAMP	UPPER DP7	NSP
		004	79096657	4930R-0365A	HOLDER	CLAMP DP7	
		010	79096644	6850R-GF10B	CABLE,FLAT	P=1.0 FFC UL2896(0.05X0.65) 6	
		011	7909680	3210R-M001A	FRAME	UP/DOWN DP7 MOLD	
		011A	79096643	6850R-JW24Y	CABLE,FLAT	P=1.0 FFC UL2896(0.035X0.7) 23	
		012	79096652	5040R-0075B	RUBBER	DAMPER DP7 (CHUNG PUNG 30)	
		012	AF000076	5040R-0075D	RUBBER	DAMPER DP7 (YAMAUCHI 30)	ALTERNATE
		012	AF000174	5040R-0075F	RUBBER	DAMPER DP7 (JAE IL 30)	ALTERNATE
		013	79096669	4400H-1009A	BELT	GM-RT1332A	
		014	79096235	4470R-0055A	GEAR	PULLEY	
		015	79096638	6871R-9248B	PWB(PCB) ASSEMBLY,TOTAL	DP7 LOADING - SH	
		015A	79096660	4681R-A003B	MOTOR ASSEMBLY	LOADING DP7 - SH	
		015B	79096516	4560R-0008A	PULLEY	MOTOR	
		015C	79096662	4680R-E007A	MOTOR(MECH)	FEEDING BCZ3B01 SANKYO FOR DVD	
		015C	79096661	4680R-E008A	MOTOR(MECH)	FEEDING RF-300EA-1D390 MABUCHI	ALTERNATE
		017	79096236	4470R-0056A	GEAR	LOADING	
		018	79096656	4974R-0046A	GUIDE	UP/DOWN(DP-7)	
		020	AF000162	3040R-M004A	BASE	MAIN(DP7-55MM) MOLD	NSP
		021	79096663	4680R-C010A	MOTOR(MECH)	SPINDLE JCL9B78 SANKYO FOR DVD	
		022	79096659	4681R-B005B	MOTOR ASSEMBLY	FEEDING DP7 - SH	
		022A	79096662	4680R-E007A	MOTOR(MECH)	FEEDING BCZ3B01 SANKYO FOR DVD	
		022A	79096661	4680R-E008A	MOTOR(MECH)	FEEDING RF-300EA-1D390 MABUCHI	
		023	79096668	4470R-0119A	GEAR	FEED MOTOR	
		024	79096665	4470R-0124A	GEAR	PINION DP7	
		024A	79096654	5006R-0040A	CAP	SKEW (T) DP7	
		024B	79096655	5006R-0039A	CAP	SKEW (R) DP7	
		025	79096667	4470R-0122A	GEAR	MIDDLE A DP7	
		026	79096679	3390R-0015A	TRAY	DISC DP7	
		027	79096666	4470R-0123A	GEAR	MIDDLE B DP7	
		028	79096670	4370R-0083A	SHAFT	DECK/MECHA DP7 OTHER PU-T	
		029	79096671	4370R-0075A	SHAFT	PU	
		030	79096664	4471R-0010A	GEAR ASSEMBLY	RACK DP7	
		031	79096646	6716DPH005A	PICK UP,DVD	PVR-502W MITSUMI PLAYER H/HIGH	
		032	79096639	6871R-9243B	PWB(PCB) ASSEMBLY,TOTAL	DP7 FEEDING - SH	
		430	79096686	1SZZR-0046A	SCREW,DRAWING	+ 1 D2.0 L6.0 SWRCH16A/FZY	
		431	79096220	1SZZH-1007B	SCREW,DRAWING	+ D2.0 6MM SWRCH16A/ZNBK 4MM 1	
		433	79096541	1SZZR-0050A	SCREW,DRAWING	+ 1 D2.0 L4.5 SWRCH16A/ZNY S-T	
		434	79096687	1SZZR-0023B	SCREW,DRAWING	+ 1 D1.7 L6.0 SWRCH16A/FZY RAC	
		435	79097902	1SZZR-0011A	SCREW,	MACHINE	
		436	79096685	1SZZR-0047A	SCREW,DRAWING	+ 1 D1.4 L4.5 SWRCH16A/FZY TAP	
*** SUB PWB(PCB) ASSEMBLY ***							
		A46	AF000183	6885R-1012U	SUB PWB(PCB) ASSEMBLY	DVB7042NDM HA1UTT 55(U),53(S),	SD-4900-S-TU
		A46	AF000182	6885R-1012T	SUB PWB(PCB) ASSEMBLY	DVB7042NDM HA1CTT	SD-4900-S-TC
		C201	79092014	0CH1104K942	CAPACITOR,CHIP[CERAMIC M/L HD	0.1UF 50V Z Y5V(F) 1508 R/TP	
		C202	79092014	0CH1104K942	CAPACITOR,CHIP[CERAMIC M/L HD	0.1UF 50V Z Y5V(F) 1508 R/TP	
		C203	79092014	0CH1104K942	CAPACITOR,CHIP[CERAMIC M/L HD	0.1UF 50V Z Y5V(F) 1508 R/TP	
		C206	79098705	0CE1074F638	CAPACITOR,ELECTROLYTIC	100U SRA 16V M FM5 TP(5)	
		C207	79097108	0CE4764F638	CAPACITOR,ELECTROLYTIC	47M SRA/SS 16V M FM5 TP(5)	
		C208	79097108	0CE4764F638	CAPACITOR,ELECTROLYTIC	47M SRA/SS 16V M FM5 TP(5)	
		C211	79092014	0CH1104K942	CAPACITOR,CHIP[CERAMIC M/L HD	0.1UF 50V Z Y5V(F) 1508 R/TP	
		C212	79092014	0CH1104K942	CAPACITOR,CHIP[CERAMIC M/L HD	0.1UF 50V Z Y5V(F) 1508 R/TP	
		C213	79092014	0CH1104K942	CAPACITOR,CHIP[CERAMIC M/L HD	0.1UF 50V Z Y5V(F) 1508 R/TP	
		C214	79092014	0CH1104K942	CAPACITOR,CHIP[CERAMIC M/L HD	0.1UF 50V Z Y5V(F) 1508 R/TP	
		C231	79092014	0CH1104K942	CAPACITOR,CHIP[CERAMIC M/L HD	0.1UF 50V Z Y5V(F) 1508 R/TP	

S	AL	LOCA. NO.	TOSHIBA PART	LG PART NO.	DESCRIPTION	SPECIFICATION	REMARKS
		C232	79092014	0CH1104K942	CAPACITOR,CHIP[CERAMIC M/L HD	0.1UF 50V Z Y5V(F) 1508 R/TP	
		C233	79092014	0CH1104K942	CAPACITOR,CHIP[CERAMIC M/L HD	0.1UF 50V Z Y5V(F) 1508 R/TP	
		C234	79092014	0CH1104K942	CAPACITOR,CHIP[CERAMIC M/L HD	0.1UF 50V Z Y5V(F) 1508 R/TP	
		C239	79092014	0CH1104K942	CAPACITOR,CHIP[CERAMIC M/L HD	0.1UF 50V Z Y5V(F) 1508 R/TP	
		C240	79096609	0CH1153K562	CAPACITOR,FIXED CERAMIC(Temp.c	0.015UF 50V 10% X7R(X) 1608 R/	
		C241	79097108	0CE4764F638	CAPACITOR,ELECTROLYTIC	47M SRA/SS 16V M FM5 TP(5)	
		C243	79096595	0CH4561K412	CAPACITOR,FIXED CERAMIC(High d	560PF 50V 5% NP0 1608 R/TP	
		C244	79096595	0CH4561K412	CAPACITOR,FIXED CERAMIC(High d	560PF 50V 5% NP0 1608 R/TP	
		C245	79092014	0CH1104K942	CAPACITOR,CHIP[CERAMIC M/L HD	0.1UF 50V Z Y5V(F) 1508 R/TP	
		C251	79092014	0CH1104K942	CAPACITOR,CHIP[CERAMIC M/L HD	0.1UF 50V Z Y5V(F) 1508 R/TP	
		C252	79092014	0CH1104K942	CAPACITOR,CHIP[CERAMIC M/L HD	0.1UF 50V Z Y5V(F) 1508 R/TP	
		C253	79092014	0CH1104K942	CAPACITOR,CHIP[CERAMIC M/L HD	0.1UF 50V Z Y5V(F) 1508 R/TP	
		C254	79092014	0CH1104K942	CAPACITOR,CHIP[CERAMIC M/L HD	0.1UF 50V Z Y5V(F) 1508 R/TP	
		C255	79092014	0CH1104K942	CAPACITOR,CHIP[CERAMIC M/L HD	0.1UF 50V Z Y5V(F) 1508 R/TP	
		C257	79098715	0CH1105D942	CAPACITOR,CHIP[CERAMIC M/L HD	1UF 10V Z Y5V(F) 1508 R/TP	
		C258	79098715	0CH1105D942	CAPACITOR,CHIP[CERAMIC M/L HD	1UF 10V Z Y5V(F) 1508 R/TP	
		C259	79098715	0CH1105D942	CAPACITOR,CHIP[CERAMIC M/L HD	1UF 10V Z Y5V(F) 1508 R/TP	
		C260	79098715	0CH1105D942	CAPACITOR,CHIP[CERAMIC M/L HD	1UF 10V Z Y5V(F) 1508 R/TP	
		C261	79098715	0CH1105D942	CAPACITOR,CHIP[CERAMIC M/L HD	1UF 10V Z Y5V(F) 1508 R/TP	
		C262	79092014	0CH1104K942	CAPACITOR,CHIP[CERAMIC M/L HD	0.1UF 50V Z Y5V(F) 1508 R/TP	
		C263	79092014	0CH1104K942	CAPACITOR,CHIP[CERAMIC M/L HD	0.1UF 50V Z Y5V(F) 1508 R/TP	
		C264	79096609	0CH1153K562	CAPACITOR,FIXED CERAMIC(Temp.c	0.015UF 50V 10% X7R(X) 1608 R/	
		C265	79092014	0CH1104K942	CAPACITOR,CHIP[CERAMIC M/L HD	0.1UF 50V Z Y5V(F) 1508 R/TP	
		C266	79092014	0CH1104K942	CAPACITOR,CHIP[CERAMIC M/L HD	0.1UF 50V Z Y5V(F) 1508 R/TP	
		C267	79092014	0CH1104K942	CAPACITOR,CHIP[CERAMIC M/L HD	0.1UF 50V Z Y5V(F) 1508 R/TP	
		C268	79092014	0CH1104K942	CAPACITOR,CHIP[CERAMIC M/L HD	0.1UF 50V Z Y5V(F) 1508 R/TP	
		C269	79092014	0CH1104K942	CAPACITOR,CHIP[CERAMIC M/L HD	0.1UF 50V Z Y5V(F) 1508 R/TP	
		C270	79092014	0CH1104K942	CAPACITOR,CHIP[CERAMIC M/L HD	0.1UF 50V Z Y5V(F) 1508 R/TP	
		C271	79096598	0CH4391K412	CAPACITOR,CHIP[CERAMIC M/L TC	390PF 50V J NP0 1508 R/TP	
		C272	79096598	0CH4391K412	CAPACITOR,CHIP[CERAMIC M/L TC	390PF 50V J NP0 1508 R/TP	
		C273	79092019	0CH1333K562	CAPACITOR,CHIP[CERAMIC M/L HD	0.033UF 50V K X7R(X) 1508 R/TP	
		C274	79096596	0CH4471K412	CAPACITOR,CHIP[CERAMIC M/L TC	470PF 50V J NP0 1508 R/TP	
		C276	79092023	0CH4100K112	CHIP CAPA CERAMIC M/L T.C F/S	10P 50V D COG 1.6X0.8 R/TP	
		C277	79096609	0CH1153K562	CAPACITOR,FIXED CERAMIC(Temp.c	0.015UF 50V 10% X7R(X) 1608 R/	
		C278	79098721	0CH4270K412	CAPACITOR,CHIP[CERAMIC M/L TC	27PF 50V J NP0 1608 R/TP	
		C279	79092014	0CH1104K942	CAPACITOR,CHIP[CERAMIC M/L HD	0.1UF 50V Z Y5V(F) 1508 R/TP	
		C280	79092014	0CH1104K942	CAPACITOR,CHIP[CERAMIC M/L HD	0.1UF 50V Z Y5V(F) 1508 R/TP	
		C281	79092014	0CH1104K942	CAPACITOR,CHIP[CERAMIC M/L HD	0.1UF 50V Z Y5V(F) 1508 R/TP	
		C282	79092014	0CH1104K942	CAPACITOR,CHIP[CERAMIC M/L HD	0.1UF 50V Z Y5V(F) 1508 R/TP	
		C283	79092014	0CH1104K942	CAPACITOR,CHIP[CERAMIC M/L HD	0.1UF 50V Z Y5V(F) 1508 R/TP	
		C291	79098705	0CE1074F638	CAPACITOR,ELECTROLYTIC	100U SRA 16V M FM5 TP(5)	
		C292	79097108	0CE4764F638	CAPACITOR,ELECTROLYTIC	47M SRA/SS 16V M FM5 TP(5)	
		C293	79097108	0CE4764F638	CAPACITOR,ELECTROLYTIC	47M SRA/SS 16V M FM5 TP(5)	
		C295	79097104	0CE1064F638	CAPACITOR,ELECTROLYTIC	10M SRA 16V M FM5 TP(5)	
		C2A1	79092014	0CH1104K942	CAPACITOR,CHIP[CERAMIC M/L HD	0.1UF 50V Z Y5V(F) 1508 R/TP	
		C2A2	79092014	0CH1104K942	CAPACITOR,CHIP[CERAMIC M/L HD	0.1UF 50V Z Y5V(F) 1508 R/TP	
		C502	79092013	0CH1103K562	CAPACITOR,FIXED CERAMIC(Temp.c	0.01UF 50V 10% X7R(X) 1608 R/T	
		C503	79092013	0CH1103K562	CAPACITOR,FIXED CERAMIC(Temp.c	0.01UF 50V 10% X7R(X) 1608 R/T	
		C504	79092013	0CH1103K562	CAPACITOR,FIXED CERAMIC(Temp.c	0.01UF 50V 10% X7R(X) 1608 R/T	
		C505	79092013	0CH1103K562	CAPACITOR,FIXED CERAMIC(Temp.c	0.01UF 50V 10% X7R(X) 1608 R/T	
		C506	79097121	0CH4101K412	CHIP CAPA CERAMIC M/L T.C F/S	100P 50V J COG 1.6X0.8 R/TP	
		C507	79092013	0CH1103K562	CAPACITOR,FIXED CERAMIC(Temp.c	0.01UF 50V 10% X7R(X) 1608 R/T	
		C508	79092018	0CH1225F944	CAPACITOR,FIXED CERAMIC(Temp.c	2.2UF 16V 80%,-20% Y5V(F) 3216	
		C509	79092014	0CH1104K942	CAPACITOR,CHIP[CERAMIC M/L HD	0.1UF 50V Z Y5V(F) 1508 R/TP	
		C510	79097121	0CH4101K412	CHIP CAPA CERAMIC M/L T.C F/S	100P 50V J COG 1.6X0.8 R/TP	
		C511	79097108	0CE4764F638	CAPACITOR,ELECTROLYTIC	47M SRA/SS 16V M FM5 TP(5)	
		C513	79092014	0CH1104K942	CAPACITOR,CHIP[CERAMIC M/L HD	0.1UF 50V Z Y5V(F) 1508 R/TP	
		C514	79092014	0CH1104K942	CAPACITOR,CHIP[CERAMIC M/L HD	0.1UF 50V Z Y5V(F) 1508 R/TP	
		C515	79092014	0CH1104K942	CAPACITOR,CHIP[CERAMIC M/L HD	0.1UF 50V Z Y5V(F) 1508 R/TP	
		C516	79092018	0CH1225F944	CAPACITOR,FIXED CERAMIC(Temp.c	2.2UF 16V 80%,-20% Y5V(F) 3216	
		C517	79092014	0CH1104K942	CAPACITOR,CHIP[CERAMIC M/L HD	0.1UF 50V Z Y5V(F) 1508 R/TP	

S	AL	LOCA. NO.	TOSHIBA PART	LG PART NO.	DESCRIPTION	SPECIFICATION	REMARKS
		C518	79092014	0CH1104K942	CAPACITOR,CHIP[CERAMIC M/L HD	0.1UF 50V Z Y5V(F) 1508 R/TP	
		C519	79092014	0CH1104K942	CAPACITOR,CHIP[CERAMIC M/L HD	0.1UF 50V Z Y5V(F) 1508 R/TP	
		C520	79092014	0CH1104K942	CAPACITOR,CHIP[CERAMIC M/L HD	0.1UF 50V Z Y5V(F) 1508 R/TP	
		C521	79092014	0CH1104K942	CAPACITOR,CHIP[CERAMIC M/L HD	0.1UF 50V Z Y5V(F) 1508 R/TP	
		C522	79092014	0CH1104K942	CAPACITOR,CHIP[CERAMIC M/L HD	0.1UF 50V Z Y5V(F) 1508 R/TP	
		C523	79092014	0CH1104K942	CAPACITOR,CHIP[CERAMIC M/L HD	0.1UF 50V Z Y5V(F) 1508 R/TP	
		C524	79092014	0CH1104K942	CAPACITOR,CHIP[CERAMIC M/L HD	0.1UF 50V Z Y5V(F) 1508 R/TP	
		C525	79092014	0CH1104K942	CAPACITOR,CHIP[CERAMIC M/L HD	0.1UF 50V Z Y5V(F) 1508 R/TP	
		C526	79092014	0CH1104K942	CAPACITOR,CHIP[CERAMIC M/L HD	0.1UF 50V Z Y5V(F) 1508 R/TP	
		C527	79092014	0CH1104K942	CAPACITOR,CHIP[CERAMIC M/L HD	0.1UF 50V Z Y5V(F) 1508 R/TP	
		C528	79097108	0CE4764F638	CAPACITOR,ELECTROLYTIC	47M SRA/SS 16V M FM5 TP(5)	
		C530	79092014	0CH1104K942	CAPACITOR,CHIP[CERAMIC M/L HD	0.1UF 50V Z Y5V(F) 1508 R/TP	
		C531	79092014	0CH1104K942	CAPACITOR,CHIP[CERAMIC M/L HD	0.1UF 50V Z Y5V(F) 1508 R/TP	
		C532	79092014	0CH1104K942	CAPACITOR,CHIP[CERAMIC M/L HD	0.1UF 50V Z Y5V(F) 1508 R/TP	
		C533	79098720	0CH4180K412	CAPACITOR,CHIP[CERAMIC M/L TC	18P 50V J COG 1.6X0.8 R/TP	
		C534	79092026	0CH4330K412	CAPACITOR,CHIP[CERAMIC M/L TC	33P 50V J COG 1.6X0.8 R/TP	
		C535	79092014	0CH1104K942	CAPACITOR,CHIP[CERAMIC M/L HD	0.1UF 50V Z Y5V(F) 1508 R/TP	
		C536	79098714	0CH1102K562	CAPACITOR,FIXED CERAMIC(Temp.c	1000PF 50V 10% X7R(X) 1608 R/T	
		C537	79098714	0CH1102K562	CAPACITOR,FIXED CERAMIC(Temp.c	1000PF 50V 10% X7R(X) 1608 R/T	
		C538	79098714	0CH1102K562	CAPACITOR,FIXED CERAMIC(Temp.c	1000PF 50V 10% X7R(X) 1608 R/T	
		C539	79092014	0CH1104K942	CAPACITOR,CHIP[CERAMIC M/L HD	0.1UF 50V Z Y5V(F) 1508 R/TP	
		C540	79092014	0CH1104K942	CAPACITOR,CHIP[CERAMIC M/L HD	0.1UF 50V Z Y5V(F) 1508 R/TP	
		C541	79097104	0CE1064F638	CAPACITOR,ELECTROLYTIC	10M SRA 16V M FM5 TP(5)	
		C542	79092014	0CH1104K942	CAPACITOR,CHIP[CERAMIC M/L HD	0.1UF 50V Z Y5V(F) 1508 R/TP	
		C543	79097104	0CE1064F638	CAPACITOR,ELECTROLYTIC	10M SRA 16V M FM5 TP(5)	
		C544	79092014	0CH1104K942	CAPACITOR,CHIP[CERAMIC M/L HD	0.1UF 50V Z Y5V(F) 1508 R/TP	
		C545	79097104	0CE1064F638	CAPACITOR,ELECTROLYTIC	10M SRA 16V M FM5 TP(5)	
		C554	79092014	0CH1104K942	CAPACITOR,CHIP[CERAMIC M/L HD	0.1UF 50V Z Y5V(F) 1508 R/TP	
		C556	79092014	0CH1104K942	CAPACITOR,CHIP[CERAMIC M/L HD	0.1UF 50V Z Y5V(F) 1508 R/TP	
		C557	79092014	0CH1104K942	CAPACITOR,CHIP[CERAMIC M/L HD	0.1UF 50V Z Y5V(F) 1508 R/TP	
		C558	79092014	0CH1104K942	CAPACITOR,CHIP[CERAMIC M/L HD	0.1UF 50V Z Y5V(F) 1508 R/TP	
		C559	79092014	0CH1104K942	CAPACITOR,CHIP[CERAMIC M/L HD	0.1UF 50V Z Y5V(F) 1508 R/TP	
		C560	79092014	0CH1104K942	CAPACITOR,CHIP[CERAMIC M/L HD	0.1UF 50V Z Y5V(F) 1508 R/TP	
		C561	79092014	0CH1104K942	CAPACITOR,CHIP[CERAMIC M/L HD	0.1UF 50V Z Y5V(F) 1508 R/TP	
		C563	79098709	0CE2274C638	CAPACITOR,ELECTROLYTIC	220M SRA 6.3V M FM5 TP(5)	
		C564	79098709	0CE2274C638	CAPACITOR,ELECTROLYTIC	220M SRA 6.3V M FM5 TP(5)	
		C565	79092025	0CH4221K412	CAPACITOR,CHIP[CERAMIC M/L TC	220P 50V J COG 1.6X0.8 R/TP	
		C566	79092025	0CH4221K412	CAPACITOR,CHIP[CERAMIC M/L TC	220P 50V J COG 1.6X0.8 R/TP	
		C567	79092025	0CH4221K412	CAPACITOR,CHIP[CERAMIC M/L TC	220P 50V J COG 1.6X0.8 R/TP	
		C568	79092025	0CH4221K412	CAPACITOR,CHIP[CERAMIC M/L TC	220P 50V J COG 1.6X0.8 R/TP	
		C569	79092025	0CH4221K412	CAPACITOR,CHIP[CERAMIC M/L TC	220P 50V J COG 1.6X0.8 R/TP	
		C575	79092014	0CH1104K942	CAPACITOR,CHIP[CERAMIC M/L HD	0.1UF 50V Z Y5V(F) 1508 R/TP	
		C576	79092014	0CH1104K942	CAPACITOR,CHIP[CERAMIC M/L HD	0.1UF 50V Z Y5V(F) 1508 R/TP	
		C577	79092014	0CH1104K942	CAPACITOR,CHIP[CERAMIC M/L HD	0.1UF 50V Z Y5V(F) 1508 R/TP	
		C578	79092014	0CH1104K942	CAPACITOR,CHIP[CERAMIC M/L HD	0.1UF 50V Z Y5V(F) 1508 R/TP	
		C579	79092014	0CH1104K942	CAPACITOR,CHIP[CERAMIC M/L HD	0.1UF 50V Z Y5V(F) 1508 R/TP	
		C580	79092014	0CH1104K942	CAPACITOR,CHIP[CERAMIC M/L HD	0.1UF 50V Z Y5V(F) 1508 R/TP	
		C581	79092014	0CH1104K942	CAPACITOR,CHIP[CERAMIC M/L HD	0.1UF 50V Z Y5V(F) 1508 R/TP	
		C582	79092014	0CH1104K942	CAPACITOR,CHIP[CERAMIC M/L HD	0.1UF 50V Z Y5V(F) 1508 R/TP	
		C583	79098709	0CE2274C638	CAPACITOR,ELECTROLYTIC	220M SRA 6.3V M FM5 TP(5)	
		C589	79092014	0CH1104K942	CAPACITOR,CHIP[CERAMIC M/L HD	0.1UF 50V Z Y5V(F) 1508 R/TP	
		C592	79092014	0CH1104K942	CAPACITOR,CHIP[CERAMIC M/L HD	0.1UF 50V Z Y5V(F) 1508 R/TP	
		C596	79092014	0CH1104K942	CAPACITOR,CHIP[CERAMIC M/L HD	0.1UF 50V Z Y5V(F) 1508 R/TP	
		C597	79096155	0CH4470K412	CAPA,CHIP CERAMIC M/L T.C F/S	47P 50V J COG 1.6X0.8 R/TP	
		C5A1	79097104	0CE1064F638	CAPACITOR,ELECTROLYTIC	10M SRA 16V M FM5 TP(5)	
		C5A2	79092014	0CH1104K942	CAPACITOR,CHIP[CERAMIC M/L HD	0.1UF 50V Z Y5V(F) 1508 R/TP	
		C5A3	79092025	0CH4221K412	CAPACITOR,CHIP[CERAMIC M/L TC	220P 50V J COG 1.6X0.8 R/TP	
		C5A4	79092014	0CH1104K942	CAPACITOR,CHIP[CERAMIC M/L HD	0.1UF 50V Z Y5V(F) 1508 R/TP	
		C5A5	79092014	0CH1104K942	CAPACITOR,CHIP[CERAMIC M/L HD	0.1UF 50V Z Y5V(F) 1508 R/TP	
		C5A6	79092014	0CH1104K942	CAPACITOR,CHIP[CERAMIC M/L HD	0.1UF 50V Z Y5V(F) 1508 R/TP	
		C5A7	79092014	0CH1104K942	CAPACITOR,CHIP[CERAMIC M/L HD	0.1UF 50V Z Y5V(F) 1508 R/TP	

S	AL	LOCA. NO.	TOSHIBA PART	LG PART NO.	DESCRIPTION	SPECIFICATION	REMARKS
		C5A8	79092014	0CH1104K942	CAPACITOR,CHIP[CERAMIC M/L HD	0.1UF 50V Z Y5V(F) 1508 R/TP	
		C5A9	79092014	0CH1104K942	CAPACITOR,CHIP[CERAMIC M/L HD	0.1UF 50V Z Y5V(F) 1508 R/TP	
		C5D1	79098709	0CE2274C638	CAPACITOR,ELECTROLYTIC	220M SRA 6.3V M FM5 TP(5)	
		C600	79092014	0CH1104K942	CAPACITOR,CHIP[CERAMIC M/L HD	0.1UF 50V Z Y5V(F) 1508 R/TP	
		C601	79097108	0CE4764F638	CAPACITOR,ELECTROLYTIC	47M SRA/SS 16V M FM5 TP(5)	
		C603	79092014	0CH1104K942	CAPACITOR,CHIP[CERAMIC M/L HD	0.1UF 50V Z Y5V(F) 1508 R/TP	
		C604	79098715	0CH1105D942	CAPACITOR,CHIP[CERAMIC M/L HD	1UF 10V Z Y5V(F) 1508 R/TP	
		C605	79098715	0CH1105D942	CAPACITOR,CHIP[CERAMIC M/L HD	1UF 10V Z Y5V(F) 1508 R/TP	
		C606	79092014	0CH1104K942	CAPACITOR,CHIP[CERAMIC M/L HD	0.1UF 50V Z Y5V(F) 1508 R/TP	
		C607	79097106	0CE2264F638	CAPACITOR,ELECTROLYTIC	22M SRA 16V M FM5 TP(5)	
		C608	79097106	0CE2264F638	CAPACITOR,ELECTROLYTIC	22M SRA 16V M FM5 TP(5)	
		C609	79098714	0CH1102K562	CAPACITOR,FIXED CERAMIC(Temp.c	1000PF 50V 10% X7R(X) 1608 R/T	
		C610	79098722	0CH4271K412	CAPACITOR,FIXED CERAMIC(HIGH D	270PF 50V 5% NP0 1608 R/TP	
		C611	79098722	0CH4271K412	CAPACITOR,FIXED CERAMIC(HIGH D	270PF 50V 5% NP0 1608 R/TP	
		C612	79097106	0CE2264F638	CAPACITOR,ELECTROLYTIC	22M SRA 16V M FM5 TP(5)	
		C613	79098722	0CH4271K412	CAPACITOR,FIXED CERAMIC(HIGH D	270PF 50V 5% NP0 1608 R/TP	
		C614	79098722	0CH4271K412	CAPACITOR,FIXED CERAMIC(HIGH D	270PF 50V 5% NP0 1608 R/TP	
		C615	79098714	0CH1102K562	CAPACITOR,FIXED CERAMIC(Temp.c	1000PF 50V 10% X7R(X) 1608 R/T	
		C616	79097106	0CE2264F638	CAPACITOR,ELECTROLYTIC	22M SRA 16V M FM5 TP(5)	
		C617	79097106	0CE2264F638	CAPACITOR,ELECTROLYTIC	22M SRA 16V M FM5 TP(5)	
		C618	79092014	0CH1104K942	CAPACITOR,CHIP[CERAMIC M/L HD	0.1UF 50V Z Y5V(F) 1508 R/TP	
		C619	79098705	0CE1074F638	CAPACITOR,ELECTROLYTIC	100U SRA 16V M FM5 TP(5)	
		C620	79097106	0CE2264F638	CAPACITOR,ELECTROLYTIC	22M SRA 16V M FM5 TP(5)	
		C621	79097106	0CE2264F638	CAPACITOR,ELECTROLYTIC	22M SRA 16V M FM5 TP(5)	
		C622	79097106	0CE2264F638	CAPACITOR,ELECTROLYTIC	22M SRA 16V M FM5 TP(5)	
		C623	79098718	0CH1392K562	CAPACITOR,FIXED CERAMIC(Temp.c	3900PF 50V K Z5U(E) 1608 R/TP	
		C624	79098718	0CH1392K562	CAPACITOR,FIXED CERAMIC(Temp.c	3900PF 50V K Z5U(E) 1608 R/TP	
		C628	79098702	0CE1054K638	CAPACITOR,ELECTROLYTIC	1.0M SRA/SS50V M FM5 TP(5)	
		C629	79098702	0CE1054K638	CAPACITOR,ELECTROLYTIC	1.0M SRA/SS50V M FM5 TP(5)	
		C630	79098702	0CE1054K638	CAPACITOR,ELECTROLYTIC	1.0M SRA/SS50V M FM5 TP(5)	
		C631	79098702	0CE1054K638	CAPACITOR,ELECTROLYTIC	1.0M SRA/SS50V M FM5 TP(5)	
		C632	79098702	0CE1054K638	CAPACITOR,ELECTROLYTIC	1.0M SRA/SS50V M FM5 TP(5)	
		C633	79092014	0CH1104K942	CAPACITOR,CHIP[CERAMIC M/L HD	0.1UF 50V Z Y5V(F) 1508 R/TP	
		C634	79097106	0CE2264F638	CAPACITOR,ELECTROLYTIC	22M SRA 16V M FM5 TP(5)	
		C635	79092014	0CH1104K942	CAPACITOR,CHIP[CERAMIC M/L HD	0.1UF 50V Z Y5V(F) 1508 R/TP	
		C636	79097108	0CE4764F638	CAPACITOR,ELECTROLYTIC	47M SRA/SS 16V M FM5 TP(5)	
		C643	79098702	0CE1054K638	CAPACITOR,ELECTROLYTIC	1.0M SRA/SS50V M FM5 TP(5)	
		C647	79098706	0CE1086C638	CAPACITOR,FIXED ELECTROLYTIC	1000000000 PF SMS,SG 6.3V M FM	
		C651	79098706	0CE1086C638	CAPACITOR,FIXED ELECTROLYTIC	1000000000 PF SMS,SG 6.3V M FM	
		C655	79098706	0CE1086C638	CAPACITOR,FIXED ELECTROLYTIC	1000000000 PF SMS,SG 6.3V M FM	
		C659	79096020	0CE4775C638	CAPACITOR,FIXED ELECTROLYTIC	470UF SR,SV 6.3V 20% FM5 TP 5	
		C659	79098713	0CE477CC618	CAPACITOR,FIXED ELECTROLYTIC	470UF SHL,SD 6.3V 20% TP 5 FL	
		C663	79096020	0CE4775C638	CAPACITOR,FIXED ELECTROLYTIC	470UF SR,SV 6.3V 20% FM5 TP 5	
		C663	79098713	0CE477CC618	CAPACITOR,FIXED ELECTROLYTIC	470UF SHL,SD 6.3V 20% TP 5 FL	
		C673	79092014	0CH1104K942	CAPACITOR,CHIP[CERAMIC M/L HD	0.1UF 50V Z Y5V(F) 1508 R/TP	
		C674	79092014	0CH1104K942	CAPACITOR,CHIP[CERAMIC M/L HD	0.1UF 50V Z Y5V(F) 1508 R/TP	
		C675	79098705	0CE1074F638	CAPACITOR,ELECTROLYTIC	100U SRA 16V M FM5 TP(5)	
		C676	79092014	0CH1104K942	CAPACITOR,CHIP[CERAMIC M/L HD	0.1UF 50V Z Y5V(F) 1508 R/TP	
		C677	79092014	0CH1104K942	CAPACITOR,CHIP[CERAMIC M/L HD	0.1UF 50V Z Y5V(F) 1508 R/TP	
		C678	79092014	0CH1104K942	CAPACITOR,CHIP[CERAMIC M/L HD	0.1UF 50V Z Y5V(F) 1508 R/TP	
		C679	79098709	0CE2274C638	CAPACITOR,ELECTROLYTIC	220M SRA 6.3V M FM5 TP(5)	
		C680	79092014	0CH1104K942	CAPACITOR,CHIP[CERAMIC M/L HD	0.1UF 50V Z Y5V(F) 1508 R/TP	
		C681	79092014	0CH1104K942	CAPACITOR,CHIP[CERAMIC M/L HD	0.1UF 50V Z Y5V(F) 1508 R/TP	
		C682	79092014	0CH1104K942	CAPACITOR,CHIP[CERAMIC M/L HD	0.1UF 50V Z Y5V(F) 1508 R/TP	
		C683	79092014	0CH1104K942	CAPACITOR,CHIP[CERAMIC M/L HD	0.1UF 50V Z Y5V(F) 1508 R/TP	
		C690	79098709	0CE2274C638	CAPACITOR,ELECTROLYTIC	220M SRA 6.3V M FM5 TP(5)	
		C691	79092014	0CH1104K942	CAPACITOR,CHIP[CERAMIC M/L HD	0.1UF 50V Z Y5V(F) 1508 R/TP	
		C6A1	79092014	0CH1104K942	CAPACITOR,CHIP[CERAMIC M/L HD	0.1UF 50V Z Y5V(F) 1508 R/TP	
		C6A2	79092014	0CH1104K942	CAPACITOR,CHIP[CERAMIC M/L HD	0.1UF 50V Z Y5V(F) 1508 R/TP	
		C6A3	79092014	0CH1104K942	CAPACITOR,CHIP[CERAMIC M/L HD	0.1UF 50V Z Y5V(F) 1508 R/TP	
		C6W1	79092014	0CH1104K942	CAPACITOR,CHIP[CERAMIC M/L HD	0.1UF 50V Z Y5V(F) 1508 R/TP	

S	AL	LOCA. NO.	TOSHIBA PART	LG PART NO.	DESCRIPTION	SPECIFICATION	REMARKS
		C6W2	79092014	0CH1104K942	CAPACITOR,CHIP[CERAMIC M/L HD	0.1UF 50V Z Y5V(F) 1508 R/TP	
		C6W3	79097104	0CE1064F638	CAPACITOR,ELECTROLYTIC	10M SRA 16V M FM5 TP(5)	
		C6W4	79097121	0CH4101K412	CHIP CAPA CERAMIC M/L T.C F/S	100P 50V J COG 1.6X0.8 R/TP	
		C6W5	79098721	0CH4270K412	CAPACITOR,CHIP[CERAMIC M/L TC	27PF 50V J NP0 1608 R/TP	
		C6W6	79097121	0CH4101K412	CHIP CAPA CERAMIC M/L T.C F/S	100P 50V J COG 1.6X0.8 R/TP	
		D600	79096310	0DSRM00118A	DIODE,SWITCHING	DAP202K T146 ROHM R/TP SMD 80V	
		D670	79096023	0DR104009BA	DIODE,RECTIFIER	RL104F TP RECTRON NON 400V 1A	
		F600	79096503	6200JB8010V	FILTER(CIRC),EMC	LFA20-2A1E473MT MITSUBISHI MAT	
		IC201	79096585	0ILNRNF006A	IC,LINEAR	MT1336E MEDIATEK INCORPORATION	
		IC202	79096576	0IPRPSA010A	IC,PERIPHERALS	LA6560-A-TE-L SANYO HSOP-36R R	
		IC501	AF000154	0ILNRNF008B	IC,LINEAR	MT1379EEC MEDIATEK INCORPORATI	
		IC505	79096693	0ISS240210A	IC,SAMSUNG ELECTRONICS	S524A40X21-SCT0 SOP8 TP EEPROM	
		IC506	AF000156	0IMMRI006A	IC,MEMORIES	IS42S16400A-7T INTEGRATED SILI	
		IC510	79097140	0IFA742440F	IC,FAIRCHILD	MM74HCT244SJ 20P SOIC TP 3-STA	
		IC601	AF000159	0IPRPCI003C	IC,PERIPHERALS	CS4391A-KZR CIRRUS LOGIC 20PIN	
		IC601	79098755	0IPRPCI003B	IC,PERIPHERALS	CS4391-KZR CIRRUS LOGIC 20 TSS	
		IC602	79098737	0IJR458000B	IC,JRC	NJM4580M 8,DMP8 TP OP AMP 2K/R	
		IC604	79096577	0IPRPMT008A	IC,PERIPHERALS	MM1623XFBE MITSUMI 28PIN SOP R	
		JK601	79096649	6612JH003KC	JACK,RCA	RCA/DIN-150(SILVER) YUQIU	
		JK602	AF000087	6612K00003B	JACK,FIBER OPTIC	PLT131/T5/12(12MBPS) EVERLIGHT	
		JK602	79096076	6612K00003A	JACK,FIBER OPTIC	PLT131/T5/6 EVERLIGHT PUSH TYP	
		L201	79096571	0LR0102J025	INDUCTOR,RADIAL LEAD	10UH 5% 4X5 TR5	
		L202	79091005	6200HJC102A	FILTER(CIRC),EMC	HB-1M2012-102JT CERATECH TP	
		L203	79096571	0LR0102J025	INDUCTOR,RADIAL LEAD	10UH 5% 4X5 TR5	
		L204	79091005	6200HJC102A	FILTER(CIRC),EMC	HB-1M2012-102JT CERATECH TP	
		L231	79091005	6200HJC102A	FILTER(CIRC),EMC	HB-1M2012-102JT CERATECH TP	
		L251	79091005	6200HJC102A	FILTER(CIRC),EMC	HB-1M2012-102JT CERATECH TP	
		L501	79091005	6200HJC102A	FILTER(CIRC),EMC	HB-1M2012-102JT CERATECH TP	
		L502	79091005	6200HJC102A	FILTER(CIRC),EMC	HB-1M2012-102JT CERATECH TP	
		L504	79091005	6200HJC102A	FILTER(CIRC),EMC	HB-1M2012-102JT CERATECH TP	
		L510	79091005	6200HJC102A	FILTER(CIRC),EMC	HB-1M2012-102JT CERATECH TP	
		L600	79091005	6200HJC102A	FILTER(CIRC),EMC	HB-1M2012-102JT CERATECH TP	
		L601	79091005	6200HJC102A	FILTER(CIRC),EMC	HB-1M2012-102JT CERATECH TP	
		L602	79091005	6200HJC102A	FILTER(CIRC),EMC	HB-1M2012-102JT CERATECH TP	
		L673	79091005	6200HJC102A	FILTER(CIRC),EMC	HB-1M2012-102JT CERATECH TP	
		L674	79091005	6200HJC102A	FILTER(CIRC),EMC	HB-1M2012-102JT CERATECH TP	
		L690	79091005	6200HJC102A	FILTER(CIRC),EMC	HB-1M2012-102JT CERATECH TP	
		Q201	79095008	0TR387509AC	TRANSISTOR	CHIP KTC3875S-GR-T1(ALG) KEC	
		Q202	79096542	0TRRH80042A	TRANSISTOR,BIPOLARS	2SK3018 T106 ROHM KOREA R/TP U	
		Q203	79096542	0TRRH80042A	TRANSISTOR,BIPOLARS	2SK3018 T106 ROHM KOREA R/TP U	
		Q204	79095002	0TR103709BB	TRANSISTOR,BIPOLARS	2SA1037K-Q CHIP TP ROHM - -	
		Q205	79095002	0TR103709BB	TRANSISTOR,BIPOLARS	2SA1037K-Q CHIP TP ROHM - -	
		Q501	79095008	0TR387509AC	TRANSISTOR	CHIP KTC3875S-GR-T1(ALG) KEC	
		Q600	79095002	0TR103709BB	TRANSISTOR,BIPOLARS	2SA1037K-Q CHIP TP ROHM - -	
		Q601	79096031	0TR103009AC	TRANSISTOR	KRA103S-T1(PC)22-22 CHIP KEC	
		Q602	79096031	0TR103009AC	TRANSISTOR	KRA103S-T1(PC)22-22 CHIP KEC	
		Q603	79095008	0TR387509AC	TRANSISTOR	CHIP KTC3875S-GR-T1(ALG) KEC	
		Q604	79095008	0TR387509AC	TRANSISTOR	CHIP KTC3875S-GR-T1(ALG) KEC	
		Q605	79095008	0TR387509AC	TRANSISTOR	CHIP KTC3875S-GR-T1(ALG) KEC	
		Q606	79095008	0TR387509AC	TRANSISTOR	CHIP KTC3875S-GR-T1(ALG) KEC	
		R201	79093029	0RH1002C622	RESISTOR,METAL GLAZED(CHIP)	10K OHM 1 / 16 W 1608 5.00% D	
		R202	79096030	0RH1003C622	RESISTOR,METAL GLAZED(CHIP)	100K OHM 1 / 16 W 1608 5.00% D	
		R203	79093029	0RH1002C622	RESISTOR,METAL GLAZED(CHIP)	10K OHM 1 / 16 W 1608 5.00% D	
		R204	79096030	0RH1003C622	RESISTOR,METAL GLAZED(CHIP)	100K OHM 1 / 16 W 1608 5.00% D	
		R205	79096563	0RH0272C622	RESISTOR,METAL GLAZED(CHIP)	27 OHM 1 / 16 W 1608 5.00% D	
		R206	79096563	0RH0272C622	RESISTOR,METAL GLAZED(CHIP)	27 OHM 1 / 16 W 1608 5.00% D	
		R207	79093020	0RH0000C622	RESISTOR,METAL GLAZED(CHIP)	0 OHM 1 / 16 W 1608 5.00% D	
		R208	79093020	0RH0000C622	RESISTOR,METAL GLAZED(CHIP)	0 OHM 1 / 16 W 1608 5.00% D	
		R209	79093020	0RH0000C622	RESISTOR,METAL GLAZED(CHIP)	0 OHM 1 / 16 W 1608 5.00% D	
		R210	79093020	0RH0000C622	RESISTOR,METAL GLAZED(CHIP)	0 OHM 1 / 16 W 1608 5.00% D	
		R211	79096564	0RH0221C622	RESISTOR,METAL GLAZED(CHIP)	2.2 OHM 1 / 16 W 1608 5.00% D	

S	AL	LOCA. NO.	TOSHIBA PART	LG PART NO.	DESCRIPTION	SPECIFICATION	REMARKS
		R212	79096547	0RJ7503C677	RESISTOR,METAL GLAZED(CHIP)	750K OHM 1/16 W 5% 1608 R/TP	
		R213	79096553	0RH3903C622	RESISTOR,METAL GLAZED(CHIP)	390K OHM 1 / 16 W 1608 5.00% D	
		R214	79096547	0RJ7503C677	RESISTOR,METAL GLAZED(CHIP)	750K OHM 1/16 W 5% 1608 R/TP	
		R215	79096553	0RH3903C622	RESISTOR,METAL GLAZED(CHIP)	390K OHM 1 / 16 W 1608 5.00% D	
		R216	79096565	0RH0101C622	RESISTOR,METAL GLAZED(CHIP)	1 OHM 1 / 16 W 1608 5.00% D	
		R217	79096564	0RH0221C622	RESISTOR,METAL GLAZED(CHIP)	2.2 OHM 1 / 16 W 1608 5.00% D	
		R218	79096564	0RH0221C622	RESISTOR,METAL GLAZED(CHIP)	2.2 OHM 1 / 16 W 1608 5.00% D	
		R220	79096563	0RH0272C622	RESISTOR,METAL GLAZED(CHIP)	27 OHM 1 / 16 W 1608 5.00% D	
		R221	79096563	0RH0272C622	RESISTOR,METAL GLAZED(CHIP)	27 OHM 1 / 16 W 1608 5.00% D	
		R231	79093039	0RH2201C622	RESISTOR,METAL GLAZED(CHIP)	2.2K OHM 1 / 16 W 1608 5.00% D	
		R232	79093039	0RH2201C622	RESISTOR,METAL GLAZED(CHIP)	2.2K OHM 1 / 16 W 1608 5.00% D	
		R233	79096564	0RH0221C622	RESISTOR,METAL GLAZED(CHIP)	2.2 OHM 1 / 16 W 1608 5.00% D	
		R234	79096564	0RH0221C622	RESISTOR,METAL GLAZED(CHIP)	2.2 OHM 1 / 16 W 1608 5.00% D	
		R235	79093029	0RH1002C622	RESISTOR,METAL GLAZED(CHIP)	10K OHM 1 / 16 W 1608 5.00% D	
		R236	79093035	0RH1502C622	RESISTOR,METAL GLAZED(CHIP)	15K OHM 1 / 16 W 1608 5.00% D	
		R237	79096557	0RH2702C622	RESISTOR,METAL GLAZED(CHIP)	27K OHM 1 / 16 W 1608 5.00% D	
		R238	79093029	0RH1002C622	RESISTOR,METAL GLAZED(CHIP)	10K OHM 1 / 16 W 1608 5.00% D	
		R239	79093029	0RH1002C622	RESISTOR,METAL GLAZED(CHIP)	10K OHM 1 / 16 W 1608 5.00% D	
		R240	79093029	0RH1002C622	RESISTOR,METAL GLAZED(CHIP)	10K OHM 1 / 16 W 1608 5.00% D	
		R241	79093029	0RH1002C622	RESISTOR,METAL GLAZED(CHIP)	10K OHM 1 / 16 W 1608 5.00% D	
		R242	79096557	0RH2702C622	RESISTOR,METAL GLAZED(CHIP)	27K OHM 1 / 16 W 1608 5.00% D	
		R243	79093029	0RH1002C622	RESISTOR,METAL GLAZED(CHIP)	10K OHM 1 / 16 W 1608 5.00% D	
		R244	79093035	0RH1502C622	RESISTOR,METAL GLAZED(CHIP)	15K OHM 1 / 16 W 1608 5.00% D	
		R245	79093029	0RH1002C622	RESISTOR,METAL GLAZED(CHIP)	10K OHM 1 / 16 W 1608 5.00% D	
		R246	79093029	0RH1002C622	RESISTOR,METAL GLAZED(CHIP)	10K OHM 1 / 16 W 1608 5.00% D	
		R251	79096215	0RH3302C622	RESISTOR,METAL GLAZED(CHIP)	33K OHM 1 / 16 W 1608 5.00% D	
		R252	79096030	0RH1003C622	RESISTOR,METAL GLAZED(CHIP)	100K OHM 1 / 16 W 1608 5.00% D	
		R253	79096557	0RH2702C622	RESISTOR,METAL GLAZED(CHIP)	27K OHM 1 / 16 W 1608 5.00% D	
		R254	79093020	0RH0000C622	RESISTOR,METAL GLAZED(CHIP)	0 OHM 1 / 16 W 1608 5.00% D	
		R255	79093020	0RH0000C622	RESISTOR,METAL GLAZED(CHIP)	0 OHM 1 / 16 W 1608 5.00% D	
		R256	79093029	0RH1002C622	RESISTOR,METAL GLAZED(CHIP)	10K OHM 1 / 16 W 1608 5.00% D	
		R257	79093029	0RH1002C622	RESISTOR,METAL GLAZED(CHIP)	10K OHM 1 / 16 W 1608 5.00% D	
		R258	79093020	0RH0000C622	RESISTOR,METAL GLAZED(CHIP)	0 OHM 1 / 16 W 1608 5.00% D	
		R259	79093020	0RH0000C622	RESISTOR,METAL GLAZED(CHIP)	0 OHM 1 / 16 W 1608 5.00% D	
		R501	79096480	0RH8201C622	RESISTOR,METAL GLAZED(CHIP)	8.2K OHM 1 / 16 W 1608 5.00% D	
		R502	79096547	0RJ7503C677	RESISTOR,METAL GLAZED(CHIP)	750K OHM 1/16 W 5% 1608 R/TP	
		R503	79093024	0RH0471C622	RESISTOR,METAL GLAZED(CHIP)	4.7 OHM 1 / 16 W 1608 5.00% D	
		R504	79093020	0RH0000C622	RESISTOR,METAL GLAZED(CHIP)	0 OHM 1 / 16 W 1608 5.00% D	
		R505	79093024	0RH0471C622	RESISTOR,METAL GLAZED(CHIP)	4.7 OHM 1 / 16 W 1608 5.00% D	
		R506	79093024	0RH0471C622	RESISTOR,METAL GLAZED(CHIP)	4.7 OHM 1 / 16 W 1608 5.00% D	
		R507	79098770	0RH1801C622	RESISTOR,METAL GLAZED(CHIP)	1.8K OHM 1 / 16 W 1608 5.00% D	
		R508	79096030	0RH1003C622	RESISTOR,METAL GLAZED(CHIP)	100K OHM 1 / 16 W 1608 5.00% D	
		R509	79093020	0RH0000C622	RESISTOR,METAL GLAZED(CHIP)	0 OHM 1 / 16 W 1608 5.00% D	
		R510	79093020	0RH0000C622	RESISTOR,METAL GLAZED(CHIP)	0 OHM 1 / 16 W 1608 5.00% D	
		R511	79093037	0RH1802C622	RESISTOR,METAL GLAZED(CHIP)	18K OHM 1 / 16 W 1608 5.00% D	
		R512	79096030	0RH1003C622	RESISTOR,METAL GLAZED(CHIP)	100K OHM 1 / 16 W 1608 5.00% D	
		R513	79093020	0RH0000C622	RESISTOR,METAL GLAZED(CHIP)	0 OHM 1 / 16 W 1608 5.00% D	
		R515	AF000119	0RH0332C622	RESISTOR,METAL GLAZED(CHIP)	33 OHM 1 / 16 W 1608 5.00% D	
		R516	AF000119	0RH0332C622	RESISTOR,METAL GLAZED(CHIP)	33 OHM 1 / 16 W 1608 5.00% D	
		R517	AF000119	0RH0332C622	RESISTOR,METAL GLAZED(CHIP)	33 OHM 1 / 16 W 1608 5.00% D	
		R518	AF000119	0RH0332C622	RESISTOR,METAL GLAZED(CHIP)	33 OHM 1 / 16 W 1608 5.00% D	
		R519	AF000119	0RH0332C622	RESISTOR,METAL GLAZED(CHIP)	33 OHM 1 / 16 W 1608 5.00% D	
		R520	AF000119	0RH0332C622	RESISTOR,METAL GLAZED(CHIP)	33 OHM 1 / 16 W 1608 5.00% D	
		R521	AF000119	0RH0332C622	RESISTOR,METAL GLAZED(CHIP)	33 OHM 1 / 16 W 1608 5.00% D	
		R522	AF000119	0RH0332C622	RESISTOR,METAL GLAZED(CHIP)	33 OHM 1 / 16 W 1608 5.00% D	
		R523	79093031	0RH1201C622	RESISTOR,METAL GLAZED(CHIP)	1.2K OHM 1 / 16 W 1608 5.00% D	
		R524	79093031	0RH1201C622	RESISTOR,METAL GLAZED(CHIP)	1.2K OHM 1 / 16 W 1608 5.00% D	
		R525	79093031	0RH1201C622	RESISTOR,METAL GLAZED(CHIP)	1.2K OHM 1 / 16 W 1608 5.00% D	
		R526	79093027	0RH1000C622	RESISTOR,METAL GLAZED(CHIP)	100 OHM 1 / 16 W 1608 5.00% D	
		R527	79093045	0RH4701C622	RESISTOR,METAL GLAZED(CHIP)	4.7K OHM 1 / 16 W 1608 5.00% D	
		R528	79093031	0RH1201C622	RESISTOR,METAL GLAZED(CHIP)	1.2K OHM 1 / 16 W 1608 5.00% D	

S	AL	LOCA. NO.	TOSHIBA PART	LG PART NO.	DESCRIPTION	SPECIFICATION	REMARKS
		R529	79093020	0RH0000C622	RESISTOR,METAL GLAZED(CHIP)	0 OHM 1 / 16 W 1608 5.00% D	
		R534	79098767	0RH1001C622	RESISTOR,METAL GLAZED(CHIP)	1K OHM 1 / 16 W 1608 5.00% D	
		R535	79098767	0RH1001C622	RESISTOR,METAL GLAZED(CHIP)	1K OHM 1 / 16 W 1608 5.00% D	
		R536	79093020	0RH0000C622	RESISTOR,METAL GLAZED(CHIP)	0 OHM 1 / 16 W 1608 5.00% D	
		R549	79093045	0RH4701C622	RESISTOR,METAL GLAZED(CHIP)	4.7K OHM 1 / 16 W 1608 5.00% D	
		R564	79093037	0RH1802C622	RESISTOR,METAL GLAZED(CHIP)	18K OHM 1 / 16 W 1608 5.00% D	
		R565	79093037	0RH1802C622	RESISTOR,METAL GLAZED(CHIP)	18K OHM 1 / 16 W 1608 5.00% D	
		R566	79093029	0RH1002C622	RESISTOR,METAL GLAZED(CHIP)	10K OHM 1 / 16 W 1608 5.00% D	
		R567	79093029	0RH1002C622	RESISTOR,METAL GLAZED(CHIP)	10K OHM 1 / 16 W 1608 5.00% D	
		R571	79093044	0RH4700C622	RESISTOR,METAL GLAZED(CHIP)	470 OHM 1 / 16 W 1608 5.00% D	
		R572	79093020	0RH0000C622	RESISTOR,METAL GLAZED(CHIP)	0 OHM 1 / 16 W 1608 5.00% D	
		R573	79093020	0RH0000C622	RESISTOR,METAL GLAZED(CHIP)	0 OHM 1 / 16 W 1608 5.00% D	
		R574	79093020	0RH0000C622	RESISTOR,METAL GLAZED(CHIP)	0 OHM 1 / 16 W 1608 5.00% D	
		R575	79093044	0RH4700C622	RESISTOR,METAL GLAZED(CHIP)	470 OHM 1 / 16 W 1608 5.00% D	
		R576	79093044	0RH4700C622	RESISTOR,METAL GLAZED(CHIP)	470 OHM 1 / 16 W 1608 5.00% D	
		R577	79093044	0RH4700C622	RESISTOR,METAL GLAZED(CHIP)	470 OHM 1 / 16 W 1608 5.00% D	
		R578	79093041	0RH3300C622	RESISTOR,METAL GLAZED(CHIP)	330 OHM 1 / 16 W 1608 5.00% D	
		R579	79098767	0RH1001C622	RESISTOR,METAL GLAZED(CHIP)	1K OHM 1 / 16 W 1608 5.00% D	
		R580	79098767	0RH1001C622	RESISTOR,METAL GLAZED(CHIP)	1K OHM 1 / 16 W 1608 5.00% D	
		R581	79098767	0RH1001C622	RESISTOR,METAL GLAZED(CHIP)	1K OHM 1 / 16 W 1608 5.00% D	
		R5A3	79093031	0RH1201C622	RESISTOR,METAL GLAZED(CHIP)	1.2K OHM 1 / 16 W 1608 5.00% D	
		R5A7	79093029	0RH1002C622	RESISTOR,METAL GLAZED(CHIP)	10K OHM 1 / 16 W 1608 5.00% D	
		R5A9	79098767	0RH1001C622	RESISTOR,METAL GLAZED(CHIP)	1K OHM 1 / 16 W 1608 5.00% D	
		R600	79098767	0RH1001C622	RESISTOR,METAL GLAZED(CHIP)	1K OHM 1 / 16 W 1608 5.00% D	
		R601	79093020	0RH0000C622	RESISTOR,METAL GLAZED(CHIP)	0 OHM 1 / 16 W 1608 5.00% D	
		R602	79093020	0RH0000C622	RESISTOR,METAL GLAZED(CHIP)	0 OHM 1 / 16 W 1608 5.00% D	
		R603	79093020	0RH0000C622	RESISTOR,METAL GLAZED(CHIP)	0 OHM 1 / 16 W 1608 5.00% D	
		R605	79093051	0RH7501C622	RESISTOR,METAL GLAZED(CHIP)	7.5K OHM 1 / 16 W 1608 5.00% D	
		R606	79093051	0RH7501C622	RESISTOR,METAL GLAZED(CHIP)	7.5K OHM 1 / 16 W 1608 5.00% D	
		R607	79096480	0RH8201C622	RESISTOR,METAL GLAZED(CHIP)	8.2K OHM 1 / 16 W 1608 5.00% D	
		R608	79098770	0RH1801C622	RESISTOR,METAL GLAZED(CHIP)	1.8K OHM 1 / 16 W 1608 5.00% D	
		R609	79098770	0RH1801C622	RESISTOR,METAL GLAZED(CHIP)	1.8K OHM 1 / 16 W 1608 5.00% D	
		R610	79096480	0RH8201C622	RESISTOR,METAL GLAZED(CHIP)	8.2K OHM 1 / 16 W 1608 5.00% D	
		R611	79096480	0RH8201C622	RESISTOR,METAL GLAZED(CHIP)	8.2K OHM 1 / 16 W 1608 5.00% D	
		R612	79093047	0RH5601C622	RESISTOR,METAL GLAZED(CHIP)	5.6K OHM 1 / 16 W 1608 5.00% D	
		R613	79093045	0RH4701C622	RESISTOR,METAL GLAZED(CHIP)	4.7K OHM 1 / 16 W 1608 5.00% D	
		R614	79098770	0RH1801C622	RESISTOR,METAL GLAZED(CHIP)	1.8K OHM 1 / 16 W 1608 5.00% D	
		R615	79098770	0RH1801C622	RESISTOR,METAL GLAZED(CHIP)	1.8K OHM 1 / 16 W 1608 5.00% D	
		R616	79096480	0RH8201C622	RESISTOR,METAL GLAZED(CHIP)	8.2K OHM 1 / 16 W 1608 5.00% D	
		R617	79093051	0RH7501C622	RESISTOR,METAL GLAZED(CHIP)	7.5K OHM 1 / 16 W 1608 5.00% D	
		R618	79093051	0RH7501C622	RESISTOR,METAL GLAZED(CHIP)	7.5K OHM 1 / 16 W 1608 5.00% D	
		R619	79093041	0RH3300C622	RESISTOR,METAL GLAZED(CHIP)	330 OHM 1 / 16 W 1608 5.00% D	
		R620	79093041	0RH3300C622	RESISTOR,METAL GLAZED(CHIP)	330 OHM 1 / 16 W 1608 5.00% D	
		R621	79098771	0RH2200C622	RESISTOR,METAL GLAZED(CHIP)	220 OHM 1 / 16 W 1608 5.00% D	
		R622	79098771	0RH2200C622	RESISTOR,METAL GLAZED(CHIP)	220 OHM 1 / 16 W 1608 5.00% D	
		R623	79096030	0RH1003C622	RESISTOR,METAL GLAZED(CHIP)	100K OHM 1 / 16 W 1608 5.00% D	
		R624	79096030	0RH1003C622	RESISTOR,METAL GLAZED(CHIP)	100K OHM 1 / 16 W 1608 5.00% D	
		R625	79093029	0RH1002C622	RESISTOR,METAL GLAZED(CHIP)	10K OHM 1 / 16 W 1608 5.00% D	
		R626	79098767	0RH1001C622	RESISTOR,METAL GLAZED(CHIP)	1K OHM 1 / 16 W 1608 5.00% D	
		R627	79098767	0RH1001C622	RESISTOR,METAL GLAZED(CHIP)	1K OHM 1 / 16 W 1608 5.00% D	
		R628	79098767	0RH1001C622	RESISTOR,METAL GLAZED(CHIP)	1K OHM 1 / 16 W 1608 5.00% D	
		R629	79098767	0RH1001C622	RESISTOR,METAL GLAZED(CHIP)	1K OHM 1 / 16 W 1608 5.00% D	
		R631	79093020	0RH0000C622	RESISTOR,METAL GLAZED(CHIP)	0 OHM 1 / 16 W 1608 5.00% D	
		R632	79093020	0RH0000C622	RESISTOR,METAL GLAZED(CHIP)	0 OHM 1 / 16 W 1608 5.00% D	
		R633	79093020	0RH0000C622	RESISTOR,METAL GLAZED(CHIP)	0 OHM 1 / 16 W 1608 5.00% D	
		R634	79098767	0RH1001C622	RESISTOR,METAL GLAZED(CHIP)	1K OHM 1 / 16 W 1608 5.00% D	
		R635	79093045	0RH4701C622	RESISTOR,METAL GLAZED(CHIP)	4.7K OHM 1 / 16 W 1608 5.00% D	
		R636	79093045	0RH4701C622	RESISTOR,METAL GLAZED(CHIP)	4.7K OHM 1 / 16 W 1608 5.00% D	
		R638	79093020	0RH0000C622	RESISTOR,METAL GLAZED(CHIP)	0 OHM 1 / 16 W 1608 5.00% D	
		R640	79093033	0RH1500C422	RESISTOR,METAL GLAZED(CHIP)	150 OHM 1 / 16 W 1608 1.00% D	
		R643	79093033	0RH1500C422	RESISTOR,METAL GLAZED(CHIP)	150 OHM 1 / 16 W 1608 1.00% D	



S	AL	LOCA. NO.	TOSHIBA PART	LG PART NO.	DESCRIPTION	SPECIFICATION	REMARKS
		R644	79093020	0RH0000C622	RESISTOR,METAL GLAZED(CHIP)	0 OHM 1 / 16 W 1608 5.00% D	
		R649	79093033	0RH1500C422	RESISTOR,METAL GLAZED(CHIP)	150 OHM 1 / 16 W 1608 1.00% D	
		R652	79093033	0RH1500C422	RESISTOR,METAL GLAZED(CHIP)	150 OHM 1 / 16 W 1608 1.00% D	
		R655	79093033	0RH1500C422	RESISTOR,METAL GLAZED(CHIP)	150 OHM 1 / 16 W 1608 1.00% D	
		R656	79093020	0RH0000C622	RESISTOR,METAL GLAZED(CHIP)	0 OHM 1 / 16 W 1608 5.00% D	
		R661	79093025	0RH0752C622	RESISTOR,METAL GLAZED(CHIP)	75 OHM 1 / 16 W 1608 5.00% D	
		R662	79093025	0RH0752C622	RESISTOR,METAL GLAZED(CHIP)	75 OHM 1 / 16 W 1608 5.00% D	
		R663	79093025	0RH0752C622	RESISTOR,METAL GLAZED(CHIP)	75 OHM 1 / 16 W 1608 5.00% D	
		R664	79093020	0RH0000C622	RESISTOR,METAL GLAZED(CHIP)	0 OHM 1 / 16 W 1608 5.00% D	
		R665	79093020	0RH0000C622	RESISTOR,METAL GLAZED(CHIP)	0 OHM 1 / 16 W 1608 5.00% D	
		R666	79093020	0RH0000C622	RESISTOR,METAL GLAZED(CHIP)	0 OHM 1 / 16 W 1608 5.00% D	
		R670	79093020	0RH0000C622	RESISTOR,METAL GLAZED(CHIP)	0 OHM 1 / 16 W 1608 5.00% D	
		R671	79093020	0RH0000C622	RESISTOR,METAL GLAZED(CHIP)	0 OHM 1 / 16 W 1608 5.00% D	
		R672	79093020	0RH0000C622	RESISTOR,METAL GLAZED(CHIP)	0 OHM 1 / 16 W 1608 5.00% D	
		R673	79093020	0RH0000C622	RESISTOR,METAL GLAZED(CHIP)	0 OHM 1 / 16 W 1608 5.00% D	
		R674	79093020	0RH0000C622	RESISTOR,METAL GLAZED(CHIP)	0 OHM 1 / 16 W 1608 5.00% D	
		R675	79093020	0RH0000C622	RESISTOR,METAL GLAZED(CHIP)	0 OHM 1 / 16 W 1608 5.00% D	
		R690	79098767	0RH1001C622	RESISTOR,METAL GLAZED(CHIP)	1K OHM 1 / 16 W 1608 5.00% D	
		R691	79093020	0RH0000C622	RESISTOR,METAL GLAZED(CHIP)	0 OHM 1 / 16 W 1608 5.00% D	
		R694	79093020	0RH0000C622	RESISTOR,METAL GLAZED(CHIP)	0 OHM 1 / 16 W 1608 5.00% D	
		R6A0	79093025	0RH0752C622	RESISTOR,METAL GLAZED(CHIP)	75 OHM 1 / 16 W 1608 5.00% D	
		R6A1	79093025	0RH0752C622	RESISTOR,METAL GLAZED(CHIP)	75 OHM 1 / 16 W 1608 5.00% D	
		R6A2	79093025	0RH0752C622	RESISTOR,METAL GLAZED(CHIP)	75 OHM 1 / 16 W 1608 5.00% D	
		R6A3	79093025	0RH0752C622	RESISTOR,METAL GLAZED(CHIP)	75 OHM 1 / 16 W 1608 5.00% D	
		R6A4	79093025	0RH0752C622	RESISTOR,METAL GLAZED(CHIP)	75 OHM 1 / 16 W 1608 5.00% D	
		R6A5	79093025	0RH0752C622	RESISTOR,METAL GLAZED(CHIP)	75 OHM 1 / 16 W 1608 5.00% D	
		R6C8	79093020	0RH0000C622	RESISTOR,METAL GLAZED(CHIP)	0 OHM 1 / 16 W 1608 5.00% D	
		R6C9	79093020	0RH0000C622	RESISTOR,METAL GLAZED(CHIP)	0 OHM 1 / 16 W 1608 5.00% D	
		R6D1	79093020	0RH0000C622	RESISTOR,METAL GLAZED(CHIP)	0 OHM 1 / 16 W 1608 5.00% D	
		R6T2	79093020	0RH0000C622	RESISTOR,METAL GLAZED(CHIP)	0 OHM 1 / 16 W 1608 5.00% D	
		R6U1	79093045	0RH4701C622	RESISTOR,METAL GLAZED(CHIP)	4.7K OHM 1 / 16 W 1608 5.00% D	
		R6U2	79093047	0RH5601C622	RESISTOR,METAL GLAZED(CHIP)	5.6K OHM 1 / 16 W 1608 5.00% D	
		R6W1	79098768	0RH1100C622	RESISTOR,METAL GLAZED(CHIP)	110 OHM 1 / 16 W 1608 5.00% D	
		R6W2	79093025	0RH0752C622	RESISTOR,METAL GLAZED(CHIP)	75 OHM 1 / 16 W 1608 5.00% D	
		R6W3	79093023	0RH0222C622	RESISTOR,METAL GLAZED(CHIP)	22 OHM 1 / 16 W 1608 5.00% D	
		R6W4	79098768	0RH1100C622	RESISTOR,METAL GLAZED(CHIP)	110 OHM 1 / 16 W 1608 5.00% D	
		R6W5	79093023	0RH0222C622	RESISTOR,METAL GLAZED(CHIP)	22 OHM 1 / 16 W 1608 5.00% D	
		X501	79097346	6202R-BL06C	RESONATOR,CRYSTAL	HC-49/S BUBANG 27MHZ 20PPM 1	
		ZD510	79096015	0DZ562609AA	DIODE,ZENER	GDZJ5.6B 26MM TP GRANDE DQ34	
<b>*** PWB(PCB) ASSEMBLY, TOTAL 5.1CH ***</b>							
		A48	AF000181	6871R-7601B	PWB(PCB) ASSEMBLY,TOTAL	DV7000S MTK SH 5.1CH	
		C302	79096283	0CH1104K946	CAPACITOR,FIXED CERAMIC(TEMP.C	0.1UF 2012 50V 80%,-20% Y5V(F)	
		C303	79097104	0CE1064F638	CAPACITOR,ELECTROLYTIC	10M SRA 16V M FM5 TP(5)	
		C304	79098709	0CE2274C638	CAPACITOR,ELECTROLYTIC	220M SRA 6.3V M FM5 TP(5)	
		C305	79096283	0CH1104K946	CAPACITOR,FIXED CERAMIC(TEMP.C	0.1UF 2012 50V 80%,-20% Y5V(F)	
		C306	AF000152	0CH4102K406	CHIP CAPA CERAMIC M/L T.C F/S	1000P 50V J SL 2.0X1.2 R/TP	
		C307	79096292	0CH4101K416	CAPA,CHIP CERAMIC M/L T.C F/S	100P 50V J NP0 2.0*1.25 R/TP	
		C308	79096608	0CH1392K566	CAPACITOR,FIXED CERAMIC(Temp.c	3900P 50V K X7R 2.0X1.2 R/TP	
		C309	79097104	0CE1064F638	CAPACITOR,ELECTROLYTIC	10M SRA 16V M FM5 TP(5)	
		C310	79097104	0CE1064F638	CAPACITOR,ELECTROLYTIC	10M SRA 16V M FM5 TP(5)	
		C311	79097104	0CE1064F638	CAPACITOR,ELECTROLYTIC	10M SRA 16V M FM5 TP(5)	
		C312	79097104	0CE1064F638	CAPACITOR,ELECTROLYTIC	10M SRA 16V M FM5 TP(5)	
		C313	AF000152	0CH4102K406	CHIP CAPA CERAMIC M/L T.C F/S	1000P 50V J SL 2.0X1.2 R/TP	
		C314	79096292	0CH4101K416	CAPA,CHIP CERAMIC M/L T.C F/S	100P 50V J NP0 2.0*1.25 R/TP	
		C315	79097104	0CE1064F638	CAPACITOR,ELECTROLYTIC	10M SRA 16V M FM5 TP(5)	
		C316	AF000152	0CH4102K406	CHIP CAPA CERAMIC M/L T.C F/S	1000P 50V J SL 2.0X1.2 R/TP	
		C317	79096292	0CH4101K416	CAPA,CHIP CERAMIC M/L T.C F/S	100P 50V J NP0 2.0*1.25 R/TP	
		C318	79097104	0CE1064F638	CAPACITOR,ELECTROLYTIC	10M SRA 16V M FM5 TP(5)	
		C319	79096608	0CH1392K566	CAPACITOR,FIXED CERAMIC(Temp.c	3900P 50V K X7R 2.0X1.2 R/TP	
		C320	79097104	0CE1064F638	CAPACITOR,ELECTROLYTIC	10M SRA 16V M FM5 TP(5)	
		C321	79097104	0CE1064F638	CAPACITOR,ELECTROLYTIC	10M SRA 16V M FM5 TP(5)	

S	AL	LOCA. NO.	TOSHIBA PART	LG PART NO.	DESCRIPTION	SPECIFICATION	REMARKS
		C322	79097104	0CE1064F638	CAPACITOR,ELECTROLYTIC	10M SRA 16V M FM5 TP(5)	
		C323	79097104	0CE1064F638	CAPACITOR,ELECTROLYTIC	10M SRA 16V M FM5 TP(5)	
		C324	79096608	0CH1392K566	CAPACITOR,FIXED CERAMIC(Temp.c	3900P 50V K X7R 2.0X1.2 R/TP	
		C325	79097104	0CE1064F638	CAPACITOR,ELECTROLYTIC	10M SRA 16V M FM5 TP(5)	
		C326	79097104	0CE1064F638	CAPACITOR,ELECTROLYTIC	10M SRA 16V M FM5 TP(5)	
		C327	79096608	0CH1392K566	CAPACITOR,FIXED CERAMIC(Temp.c	3900P 50V K X7R 2.0X1.2 R/TP	
		C328	79096292	0CH4101K416	CAPA,CHIP CERAMIC M/L T.C F/S	100P 50V J NP0 2.0*1.25 R/TP	
		C329	AF000152	0CH4102K406	CHIP CAPA CERAMIC M/L T.C F/S	1000P 50V J SL 2.0X1.2 R/TP	
		C330	79096292	0CH4101K416	CAPA,CHIP CERAMIC M/L T.C F/S	100P 50V J NP0 2.0*1.25 R/TP	
		C331	AF000152	0CH4102K406	CHIP CAPA CERAMIC M/L T.C F/S	1000P 50V J SL 2.0X1.2 R/TP	
		C332	79097104	0CE1064F638	CAPACITOR,ELECTROLYTIC	10M SRA 16V M FM5 TP(5)	
		C333	79097104	0CE1064F638	CAPACITOR,ELECTROLYTIC	10M SRA 16V M FM5 TP(5)	
		C334	79097104	0CE1064F638	CAPACITOR,ELECTROLYTIC	10M SRA 16V M FM5 TP(5)	
		C335	79096292	0CH4101K416	CAPA,CHIP CERAMIC M/L T.C F/S	100P 50V J NP0 2.0*1.25 R/TP	
		C336	AF000152	0CH4102K406	CHIP CAPA CERAMIC M/L T.C F/S	1000P 50V J SL 2.0X1.2 R/TP	
		C337	79096608	0CH1392K566	CAPACITOR,FIXED CERAMIC(Temp.c	3900P 50V K X7R 2.0X1.2 R/TP	
		C338	79097104	0CE1064F638	CAPACITOR,ELECTROLYTIC	10M SRA 16V M FM5 TP(5)	
		C339	79097104	0CE1064F638	CAPACITOR,ELECTROLYTIC	10M SRA 16V M FM5 TP(5)	
		C340	79096608	0CH1392K566	CAPACITOR,FIXED CERAMIC(Temp.c	3900P 50V K X7R 2.0X1.2 R/TP	
		C341	79097106	0CE2264F638	CAPACITOR,ELECTROLYTIC	22M SRA 16V M FM5 TP(5)	
		C342	79097106	0CE2264F638	CAPACITOR,ELECTROLYTIC	22M SRA 16V M FM5 TP(5)	
		D311	79096013	0DS202009CA	DIODE,SWITCHING	DAN202K TP ROHM KOREA SOT23 80	
		D312	79096013	0DS202009CA	DIODE,SWITCHING	DAN202K TP ROHM KOREA SOT23 80	
		F301	79091006	6200HJC901A	FILTER(CIRC),EMC	CFI06B1H101MF SAMHWA TP 2-5K	
		F302	79091006	6200HJC901A	FILTER(CIRC),EMC	CFI06B1H101MF SAMHWA TP 2-5K	
		F303	79091006	6200HJC901A	FILTER(CIRC),EMC	CFI06B1H101MF SAMHWA TP 2-5K	
		F304	79091006	6200HJC901A	FILTER(CIRC),EMC	CFI06B1H101MF SAMHWA TP 2-5K	
		F305	79091006	6200HJC901A	FILTER(CIRC),EMC	CFI06B1H101MF SAMHWA TP 2-5K	
		F306	79091006	6200HJC901A	FILTER(CIRC),EMC	CFI06B1H101MF SAMHWA TP 2-5K	
		IC301	AF000158	0IPRPBB002A	IC,PERIPHERALS	PCM1603KY BUR BROWN 52 TQFP TR	
		IC302	79098737	0IJR458000B	IC,JRC	NJM4580M 8,DMP8 TP OP AMP 2K/R	
		IC303	79098737	0IJR458000B	IC,JRC	NJM4580M 8,DMP8 TP OP AMP 2K/R	
		IC304	79098737	0IJR458000B	IC,JRC	NJM4580M 8,DMP8 TP OP AMP 2K/R	
		JK301	AF000178	6612JH002XA	JACK,RCA	RCA-617A-01 YUQIU	
		Q301	79095008	0TR387509AC	TRANSISTOR	CHIP KTC3875S-GR-T1(ALG) KEC	
		Q302	79095008	0TR387509AC	TRANSISTOR	CHIP KTC3875S-GR-T1(ALG) KEC	
		Q303	79095008	0TR387509AC	TRANSISTOR	CHIP KTC3875S-GR-T1(ALG) KEC	
		Q304	79095008	0TR387509AC	TRANSISTOR	CHIP KTC3875S-GR-T1(ALG) KEC	
		Q305	79095008	0TR387509AC	TRANSISTOR	CHIP KTC3875S-GR-T1(ALG) KEC	
		Q306	79095008	0TR387509AC	TRANSISTOR	CHIP KTC3875S-GR-T1(ALG) KEC	
		Q307	79096031	0TR103009AC	TRANSISTOR	KRA103S-T1(PC)22-22 CHIP KEC	
		Q308	79096031	0TR103009AC	TRANSISTOR	KRA103S-T1(PC)22-22 CHIP KEC	
		R301	79096344	0RH1001D622	RESISTOR,METAL GLAZED(CHIP)	1K OHM 1 / 10 W 2012 5.00% D	
		R302	AF000161	0RH0102D622	RESISTOR,METAL GLAZED(CHIP)	10 OHM 1 / 10 W 2012 5.00% D	
		R303	79096206	0RH0000D622	RESISTOR,METAL GLAZED(CHIP)	0 OHM 1 / 10 W 2012 5.00% D	
		R305	AF000161	0RH0102D622	RESISTOR,METAL GLAZED(CHIP)	10 OHM 1 / 10 W 2012 5.00% D	
		R306	79096344	0RH1001D622	RESISTOR,METAL GLAZED(CHIP)	1K OHM 1 / 10 W 2012 5.00% D	
		R307	79096346	0RH1003D622	RESISTOR,METAL GLAZED(CHIP)	100K OHM 1 / 10 W 2012 5.00% D	
		R308	79096355	0RH2200D622	RESISTOR,METAL GLAZED(CHIP)	220 OHM 1 / 10 W 2012 5.00% D	
		R309	79096556	0RH3300D622	RESISTOR,METAL GLAZED(CHIP)	330 OHM 1 / 10 W 2012 5.00% D	
		R310	79096344	0RH1001D622	RESISTOR,METAL GLAZED(CHIP)	1K OHM 1 / 10 W 2012 5.00% D	
		R311	79096351	0RH1502D622	RESISTOR,METAL GLAZED(CHIP)	15K OHM 1 / 10 W 2012 5.00% D	
		R312	79096370	0RH6801D622	RESISTOR,METAL GLAZED(CHIP)	6.8K OHM 1 / 10 W 2012 5.00% D	
		R313	79096371	0RH7501D622	RESISTOR,METAL GLAZED(CHIP)	7.5K OHM 1 / 10 W 2012 5.00% D	
		R314	79096371	0RH7501D622	RESISTOR,METAL GLAZED(CHIP)	7.5K OHM 1 / 10 W 2012 5.00% D	
		R315	79096371	0RH7501D622	RESISTOR,METAL GLAZED(CHIP)	7.5K OHM 1 / 10 W 2012 5.00% D	
		R316	79096370	0RH6801D622	RESISTOR,METAL GLAZED(CHIP)	6.8K OHM 1 / 10 W 2012 5.00% D	
		R317	79096351	0RH1502D622	RESISTOR,METAL GLAZED(CHIP)	15K OHM 1 / 10 W 2012 5.00% D	
		R318	79096556	0RH3300D622	RESISTOR,METAL GLAZED(CHIP)	330 OHM 1 / 10 W 2012 5.00% D	
		R319	79096551	0RH5601D622	RESISTOR,METAL GLAZED(CHIP)	5.6K OHM 1 / 10 W 2012 5.00% D	
		R320	79096365	0RH4701D622	RESISTOR,METAL GLAZED(CHIP)	4.7K OHM 1 / 10 W 2012 5.00% D	

S	AL	LOCA. NO.	TOSHIBA PART	LG PART NO.	DESCRIPTION	SPECIFICATION	REMARKS
		R321	79096346	0RH1003D622	RESISTOR,METAL GLAZED(CHIP)	100K OHM 1 / 10 W 2012 5.00% D	
		R322	79096355	0RH2200D622	RESISTOR,METAL GLAZED(CHIP)	220 OHM 1 / 10 W 2012 5.00% D	
		R323	79096344	0RH1001D622	RESISTOR,METAL GLAZED(CHIP)	1K OHM 1 / 10 W 2012 5.00% D	
		R324	79096355	0RH2200D622	RESISTOR,METAL GLAZED(CHIP)	220 OHM 1 / 10 W 2012 5.00% D	
		R325	79096346	0RH1003D622	RESISTOR,METAL GLAZED(CHIP)	100K OHM 1 / 10 W 2012 5.00% D	
		R326	79096556	0RH3300D622	RESISTOR,METAL GLAZED(CHIP)	330 OHM 1 / 10 W 2012 5.00% D	
		R327	79096344	0RH1001D622	RESISTOR,METAL GLAZED(CHIP)	1K OHM 1 / 10 W 2012 5.00% D	
		R328	79096351	0RH1502D622	RESISTOR,METAL GLAZED(CHIP)	15K OHM 1 / 10 W 2012 5.00% D	
		R329	79096370	0RH6801D622	RESISTOR,METAL GLAZED(CHIP)	6.8K OHM 1 / 10 W 2012 5.00% D	
		R330	79096344	0RH1001D622	RESISTOR,METAL GLAZED(CHIP)	1K OHM 1 / 10 W 2012 5.00% D	
		R331	79096371	0RH7501D622	RESISTOR,METAL GLAZED(CHIP)	7.5K OHM 1 / 10 W 2012 5.00% D	
		R332	79096370	0RH6801D622	RESISTOR,METAL GLAZED(CHIP)	6.8K OHM 1 / 10 W 2012 5.00% D	
		R333	79096351	0RH1502D622	RESISTOR,METAL GLAZED(CHIP)	15K OHM 1 / 10 W 2012 5.00% D	
		R334	79096556	0RH3300D622	RESISTOR,METAL GLAZED(CHIP)	330 OHM 1 / 10 W 2012 5.00% D	
		R335	79096551	0RH5601D622	RESISTOR,METAL GLAZED(CHIP)	5.6K OHM 1 / 10 W 2012 5.00% D	
		R336	79096365	0RH4701D622	RESISTOR,METAL GLAZED(CHIP)	4.7K OHM 1 / 10 W 2012 5.00% D	
		R337	79096346	0RH1003D622	RESISTOR,METAL GLAZED(CHIP)	100K OHM 1 / 10 W 2012 5.00% D	
		R338	79096355	0RH2200D622	RESISTOR,METAL GLAZED(CHIP)	220 OHM 1 / 10 W 2012 5.00% D	
		R339	79096344	0RH1001D622	RESISTOR,METAL GLAZED(CHIP)	1K OHM 1 / 10 W 2012 5.00% D	
		R340	79096344	0RH1001D622	RESISTOR,METAL GLAZED(CHIP)	1K OHM 1 / 10 W 2012 5.00% D	
		R341	79096355	0RH2200D622	RESISTOR,METAL GLAZED(CHIP)	220 OHM 1 / 10 W 2012 5.00% D	
		R342	79096346	0RH1003D622	RESISTOR,METAL GLAZED(CHIP)	100K OHM 1 / 10 W 2012 5.00% D	
		R343	79096556	0RH3300D622	RESISTOR,METAL GLAZED(CHIP)	330 OHM 1 / 10 W 2012 5.00% D	
		R344	79096344	0RH1001D622	RESISTOR,METAL GLAZED(CHIP)	1K OHM 1 / 10 W 2012 5.00% D	
		R345	79096351	0RH1502D622	RESISTOR,METAL GLAZED(CHIP)	15K OHM 1 / 10 W 2012 5.00% D	
		R346	79096370	0RH6801D622	RESISTOR,METAL GLAZED(CHIP)	6.8K OHM 1 / 10 W 2012 5.00% D	
		R347	79096371	0RH7501D622	RESISTOR,METAL GLAZED(CHIP)	7.5K OHM 1 / 10 W 2012 5.00% D	
		R348	79096371	0RH7501D622	RESISTOR,METAL GLAZED(CHIP)	7.5K OHM 1 / 10 W 2012 5.00% D	
		R349	79096370	0RH6801D622	RESISTOR,METAL GLAZED(CHIP)	6.8K OHM 1 / 10 W 2012 5.00% D	
		R350	79096351	0RH1502D622	RESISTOR,METAL GLAZED(CHIP)	15K OHM 1 / 10 W 2012 5.00% D	
		R361	79096556	0RH3300D622	RESISTOR,METAL GLAZED(CHIP)	330 OHM 1 / 10 W 2012 5.00% D	
		R362	79096551	0RH5601D622	RESISTOR,METAL GLAZED(CHIP)	5.6K OHM 1 / 10 W 2012 5.00% D	
		R363	79096365	0RH4701D622	RESISTOR,METAL GLAZED(CHIP)	4.7K OHM 1 / 10 W 2012 5.00% D	
		R364	79096344	0RH1001D622	RESISTOR,METAL GLAZED(CHIP)	1K OHM 1 / 10 W 2012 5.00% D	
		R365	79096355	0RH2200D622	RESISTOR,METAL GLAZED(CHIP)	220 OHM 1 / 10 W 2012 5.00% D	
		R366	79096346	0RH1003D622	RESISTOR,METAL GLAZED(CHIP)	100K OHM 1 / 10 W 2012 5.00% D	
		R374	79096206	0RH0000D622	RESISTOR,METAL GLAZED(CHIP)	0 OHM 1 / 10 W 2012 5.00% D	
		R375	79096344	0RH1001D622	RESISTOR,METAL GLAZED(CHIP)	1K OHM 1 / 10 W 2012 5.00% D	
		R376	79096344	0RH1001D622	RESISTOR,METAL GLAZED(CHIP)	1K OHM 1 / 10 W 2012 5.00% D	
		R377	79096206	0RH0000D622	RESISTOR,METAL GLAZED(CHIP)	0 OHM 1 / 10 W 2012 5.00% D	
<b>*** PWB(PCB) ASSEMBLY , TOTAL POWER ***</b>							
		A47	79096640	6871R-7605F	PWB(PCB) ASSEMBLY,TOTAL	DV7000S MTK SMPS SH 110V(UL) L	
		BC101	79091008	636-004C	FILTER(CIRC),EMC	BEAD CORE BFS3550R2FD8,R T/P	
		BD101	79096005	0DD160000DA	DIODE	S1WBA60(1A 600V) SHIDENKEN	
	⚠	C101	79097353	624-088S	CAPACITOR,DRAWING	MPX104K ETR/EUROPTRONIC BULK	
		C102	79097353	624-088S	CAPACITOR,DRAWING	MPX104K ETR/EUROPTRONIC BULK	
		C103	79097105	0CE1076Q600	CAPACITOR,ELECTROLYTIC	100UF SMS 200V M W BULK	
		C104	79092035	624-085D	CAPACITOR	CE 47UF/50V KME (SMPS)	
		C106	79097104	0CE1064F638	CAPACITOR,ELECTROLYTIC	10M SRA 16V M FM5 TP(5)	
		C107	79096148	0CG2220U630	CAPACITOR,SEMI CERAMIC	2200 PF 400V M E R (NK,AD,SD)	
		C108	79096616	0CE4744K638	CAPACITOR,ELECTROLYTIC	0.47M SRA 50V M FM5 TP(5)	
		C109	79092003	0CE108BF630	CAPACITOR,FIXED ELECTROLYTIC	1000UF KME 16V M FM5 BULK	
		C110	79098729	0CN4730K948	CAPACITOR,FIXED TUBULAR(High d	0.047UF D 50V 80%,-20% F(Y5V)	
		C112	79092007	0CE3376D638	CAPACITOR,ELECTROLYTIC	330UF SMS 10V M FM5 TP5	
		C113	79096279	0CG1020U630	CAPACITOR,SEMI CERAMIC	1000PF 400V M E(Z5U) R	
		C115	79096697	0CE3366K638	CAPACITOR,FIXED ELECTROLYTIC	33UF SMS,SG 50V 20% FM5 TP 5	
		C116	79092010	0CE477BH630	CAPACITOR,AL.ELECTROLYTIC	470UF KME TYPE 25V M FM5 BULK	
		C118	79098705	0CE1074F638	CAPACITOR,ELECTROLYTIC	100U SRA 16V M FM5 TP(5)	
		C119	79096651	624-087G	CAPACITOR	HIGH-VOL 68PF/1KV SMPS SAMHWA	
		C120	79098705	0CE1074F638	CAPACITOR,ELECTROLYTIC	100U SRA 16V M FM5 TP(5)	
		C121	79009200	0CE2276F638	CAPACITOR,ELECTROLYTIC	220U SMS 16V M FM5 TP(5)	

S	AL	LOCA. NO.	TOSHIBA PART	LG PART NO.	DESCRIPTION	SPECIFICATION	REMARKS
		C121	79092005	0CE2276F638	CAPACITOR,ELECTROLYTIC	220U SMS 16V M FM5 TP(5)	
		C122	79092035	624-085D	CAPACITOR	CE 47UF/50V KME (SMPS)	
		C123	79092003	0CE108BF630	CAPACITOR,FIXED ELECTROLYTIC	1000UF KME 16V M FM5 BULK	
		C124	79098711	0CE337CH618	CAPACITOR,FIXED ELECTROLYTIC	330UF SHL,SD 25V 20% FL TP 5	
		C126	79092033	0CQ1031Y519	CAPACITOR,POLYESTER	0.01UF D 630V K PE NI TP	
		C128	79098731	0CQ1042K409	CAPACITOR,FIXED FILM	0.1UF S 50V J PE TP	
		C130	79098705	0CE1074F638	CAPACITOR,ELECTROLYTIC	100U SRA 16V M FM5 TP(5)	
		C131	79098705	0CE1074F638	CAPACITOR,ELECTROLYTIC	100U SRA 16V M FM5 TP(5)	
		C137	79092007	0CE3376D638	CAPACITOR,ELECTROLYTIC	330UF SMS 10V M FM5 TP5	
		D100	79096002	0DD010009CA	DIODE,RECTIFIER	EG01CW(R-FORM 5MM) TP SANKEN	
		D100	79096006	0DD221009AA	DIODE,RECTIFIERS	ERA22-10 KFLB,TP ,R T/P,FUJI	
		D101	AF000153	0DZ240009AF	DIODE,ZENERS	GDZJ24B GRANDE TP26 DO34 0.5W	
		D102	79096011	0DR810040BA	DIODE,RECTIFIER	ERC81-004L22 BK FUJI DO201AD 4	
		D102	79096009	0DR158220AA	DIODE,RECTIFIER	1N5822 BK RECTRON DO201AD 40V	
		D103	79096696	0DR202000AB	DIODE,RECTIFIER	HER202 BK RECTRON NON 100V 2A	
		D104	79096023	0DR104009BA	DIODE,RECTIFIER	RL104F TP RECTRON NON 400V 1A	
		D106	79096008	0DR104009AB	DIODE,RECTIFIER	RL104 R. TP GULF SEMICONDUCTOR	
		D107	79096023	0DR104009BA	DIODE,RECTIFIER	RL104F TP RECTRON NON 400V 1A	
		D108	79096023	0DR104009BA	DIODE,RECTIFIER	RL104F TP RECTRON NON 400V 1A	
		D109	79096696	0DR202000AB	DIODE,RECTIFIER	HER202 BK RECTRON NON 100V 2A	
		D110	79096023	0DR104009BA	DIODE,RECTIFIER	RL104F TP RECTRON NON 400V 1A	
		D111	79096012	0DRRE00029A	DIODE,RECTIFIERS	1N17 RECTRON TP NON 20V 1A 20	
	⚠	F101	79096318	0FS1601B51B	FUSE,SLOW BLOW	1600MA 250 V 5.2X20 CY/GL KS /	
	⚠	F101	79098701	585-027B	FUSE,SLOW BLOW	1600MA 250 V 5.2X20 CY/GL KS /	
		F102	79096691	0RF0200F708	RESISTOR,VARIABLE(CARBON FILM]	0.2 OHM 1/6 W 10% TA26	
		FH101	79098790	586-008B	HOLDER	FUSE CLIP TP SINSUNG	
		FH102	79098790	586-008B	HOLDER	FUSE CLIP TP SINSUNG	
	⚠	IC101	79096694	0IPMGIH004A	IC,POWER MANAGEMENT	ICE2B0565 INFINEON 8PIN DIP ST	
	⚠	IC102	79094030	657-063A	SENSOR	LTV-817B,PHOTO COUPLER(LITEON)	
		IC103	AF000157	0IPMGSH010A	IC,POWER MANAGEMENT	PQ12RD1L SHARP 4PIN TO-220 ST	ALTERNATE
		IC103	79098750	0IPMGFA017A	IC,POWER MANAGEMENT	KA78R12TSTU FAIRCHILD 4P TO-22	ALTERNATE
		IC103	79098740	0IKE781200S	IC,KEC	KIA78R12PI CU 4P TO-220IS ST 1	
		IC104	79097152	0IPMGUK001A	IC,POWER MANAGEMENT	SL431-AT AUK 3PIN TO-92 TP PRO	ALTERNATE
		IC104	79094010	0IKE431000A	IC,KEC	KIA431 3 PIN TP	
		IC104	79094020	0ISS431000A	IC,SAMSUNG ELECTRONICS	KA431AZ (LM431AZ)	ALTERNATE
		IC105	AF000115	0IPMGSH009A	IC,POWER MANAGEMENT	PQ08RD1L SHARP 4PIN TO-220 ST	ALTERNATE
		IC105	79098753	0IPMGKE008B	IC,POWER MANAGEMENT	KIA78R08PI CU KEC 4P TO-220IS	
		IC105	79098749	0IPMGFA016A	IC,POWER MANAGEMENT	KA78R08TSTU FAIRCHILD 4P TO-22	ALTERNATE
		IC106	AF000160	0ISH313000C	IC,SHARP	PQ3RD13L 4PIN TO-220 ST 3.3V L	ALTERNATE
		IC106	79098752	0IPMGKE006B	IC,POWER MANAGEMENT	KIA78R33PI CU KEC 4P TO-220IS	
		IC106	79098748	0IPMGFA015A	IC,POWER MANAGEMENT	KA78R33TSTU FAIRCHILD 4P TO-22	ALTERNATE
	⚠	L101	79091004	616-145J	FILTER(CIRC),DRAWING	BUJEON V-04350	
	⚠	L101	79098791	616-145M	FILTER(CIRC),DRAWING	V-04350 LS FUTAI BULK =616-145	
		L102	79098794	633-088D	COIL,CHOKE	CHOCK ,20UH KWANGSUNG LEAD CU	
		L103	79091007	633-088G	COIL,CHOKE	CHOCK(22MH) 5MM TOKO TP	
		L105	79091007	633-088G	COIL,CHOKE	CHOCK(22MH) 5MM TOKO TP	
		Q101	79095006	0TR319809AC	TRANSISTOR	KTC3198-TP-BL (KTC1815)KEC	ALTERNATE
		Q101	79095007	0TR319909AF	TRANSISTOR,BIPOLARS	KTC3199-BL MINI TP KEC	ALTERNATE
		Q101	79096377	0TR534309BA	TRANSISTOR	2SC5343-L TP AUK TO92	
		Q102	79096688	0TR105009AD	TRANSISTOR,BIPOLARS	KRA105M KEC TP TO92 50V 100MA	
		Q107	AF000018	0TR115100AC	TRANSISTOR,BIPOLARS	KTB1151-Y BK KEC TO126 -	
		Q107	79096546	0TR115100AA	TRANSISTOR	KSB1151-Y BK SAMSUNG TO-126	
		Q108	79095006	0TR319809AC	TRANSISTOR	KTC3198-TP-BL (KTC1815)KEC	ALTERNATE
		Q108	79096377	0TR534309BA	TRANSISTOR	2SC5343-L TP AUK TO92	
		Q108	79095007	0TR319909AF	TRANSISTOR,BIPOLARS	KTC3199-BL MINI TP KEC	ALTERNATE
		R100	79093009	0RD1504H632	RESISTOR,FIXED CARBON FILM	1.5M OHM 1/2 W 5.00% MF10	
		R101	79093056	614-007A	RESISTOR	2.7/2W CEMENT SMPS V	
		R103	79093055	0RS5602K619	RESISTOR,FIXED METAL OXIDE FIL	56K OHM 2 W 5.00% TR	
		R107	79096689	0RS0600K619	RESISTOR,FIXED METAL OXIDE FIL	0.6 OHM 2 W 5% TR	
		R109	79093012	0RD2203F608	RESISTOR,FIXED CARBON FILM	220K OHM 1/6 W 5% TA26	
		R110	79093012	0RD2203F608	RESISTOR,FIXED CARBON FILM	220K OHM 1/6 W 5% TA26	

S	AL	LOCA. NO.	TOSHIBA PART	LG PART NO.	DESCRIPTION	SPECIFICATION	REMARKS
		R112	79096692	ORD0392F608	RESISTOR, FIXED CARBON FILM	39 OHM 1/6 W 5% TA26	
		R114	79093006	ORD1003F608	RESISTOR, FIXED CARBON FILM	100K OHM 1/6 W 5% TA26	
		R115	79097165	ORD0182F608	RESISTOR, FIXED CARBON FILM	18 OHM 1/6 W 5.00% TA26	
		R116	79097165	ORD0182F608	RESISTOR, FIXED CARBON FILM	18 OHM 1/6 W 5.00% TA26	
		R120	79093018	ORD4702F608	RESISTOR, FIXED CARBON FILM	47K OHM 1/6 W 5% TA26	
		R121	79093007	ORD1201F608	RESISTOR, FIXED CARBON FILM	1.2K OHM 1/6 W 5% TA26	
		R121	79096185	ORD1201F608	RESISTOR, FIXED CARBON FILM	1.2K OHM 1/6 W 5% TA26	
		R122	79093011	ORD2200F608	RESISTOR, FIXED CARBON FILM	220 OHM 1/6 W 5% TA26	
		R123	79093004	ORD1001F608	RESISTOR, FIXED CARBON FILM	1K OHM 1/6 W 5% TA26	
		R124	79093010	ORD1800F608	RESISTOR, FIXED CARBON FILM	180 OHM 1/6 W 5% TA26	
		R125	79093015	ORD3901F608	RESISTOR, FIXED CARBON FILM	3.9K OHM 1/6 W 5% TA26	
		R126	79093004	ORD1001F608	RESISTOR, FIXED CARBON FILM	1K OHM 1/6 W 5% TA26	
		R127	79093054	ORN3601E408	RESISTOR, FIXED METAL FILM	3.6K OHM 1/8 W 1.00% TA26	
		R128	79093053	ORN3301E408	RESISTOR, FIXED METAL FILM	3.3K OHM 1/8 W 1.00% TA26	
		R130	79093005	ORD1002F608	RESISTOR, FIXED CARBON FILM	10K OHM 1/6 W 5% TA26	
		R131	79098761	ORD2201F608	RESISTOR, FIXED CARBON FILM	2.2K OHM 1/6 W 5% TA26	
		R132	79093005	ORD1002F608	RESISTOR, FIXED CARBON FILM	10K OHM 1/6 W 5% TA26	
		R140	79093004	ORD1001F608	RESISTOR, FIXED CARBON FILM	1K OHM 1/6 W 5% TA26	
		R142	79093004	ORD1001F608	RESISTOR, FIXED CARBON FILM	1K OHM 1/6 W 5% TA26	
		R145	79093016	ORD4700F608	RESISTOR, FIXED CARBON FILM	470 OHM 1/6 W 5% TA26	
⚠		T101	79096069	6170RNGW05B	TRANSFORMER, SMPS[COIL]	EER2828 SOOJUNG DVD SLIM	
⚠		V101	79098795	656-004C	VARISTOR, DRAWING	SVC681D-10A SAMHWA 4.O CUT	
		ZD101	79098735	0DZ560009CJ	DIODE, ZENERS	GDZJ5.6B 26MM GRANDE TP26 DO34	
		ZD102	79098734	0DZ332609FB	DIODE, ZENERS	GDZJ3.3B 26MM GRANDE TP26 DO34	

# **TOSHIBA CORPORATION**

1-1, SHIBAURA 1-CHOME, MINATO-KU, TOKYO 105-8001, JAPAN

## Free Manuals Download Website

<http://myh66.com>

<http://usermanuals.us>

<http://www.somanuals.com>

<http://www.4manuals.cc>

<http://www.manual-lib.com>

<http://www.404manual.com>

<http://www.luxmanual.com>

<http://aubethermostatmanual.com>

Golf course search by state

<http://golfingnear.com>

Email search by domain

<http://emailbydomain.com>

Auto manuals search

<http://auto.somanuals.com>

TV manuals search

<http://tv.somanuals.com>