

TOSHIBA

5 Disc DVD Changer SD-6915SU

TOSHIBA

Instruction Manual



AK68-00479A Rev01



Important Safety Instructions

- 1) Read these instructions.
- 2) Keep these instructions.
- 3) Heed all warnings.
- 4) Follow all instructions.
- 5) Do not use this apparatus near water.
- 6) Clean only with dry cloth.
- 7) Do not block any ventilation openings. Install in accordance with the manufacturer's instructions.
- 8) Do not install near any heat sources such as radiators, heat registers, or other apparatus (including amplifiers) that produce heat.
- 9) Do not defeat the safety purpose of the polarized or grounding-type plug. A polarized plug has two blades with one wider than the other. A grounding type plug has two blades and a third grounding prong. The wide blade or the third prong are provided for your safety. If the provided plug does not fit into your outlet, consult an electrician for replacement of the obsolete outlet.
- 10) Protect the power cord from being walked on or pinched particularly at plugs, convenience receptacles, and the point where they exit from the apparatus.
- 11) Only use attachments/accessories specified by the manufacturer.
- 12) Use only with cart, stand, tripod, bracket, or table specified by the manufacturer, or sold with the apparatus.
- 13) Unplug this apparatus. When a cart is used, use caution when moving the cart/apparatus combination to avoid injury from tip-over.
- 14) Refer all servicing to qualified service personnel. Servicing is required when the apparatus has been damaged in any way, such as power-supply cord or plug is damaged, liquid has been spilled or objects have fallen into the apparatus the apparatus has been exposed to rain or moisture, does not operate normally, or has been dropped.



Precautions



TO REDUCE THE RISK OF ELECTRIC SHOCK, DO NOT REMOVE THE COVER(OR BACK). NO USER-SERVICEABLE PARTS ARE INSIDE. REFER SERVICING TO QUALIFIED SERVICE PERSONNEL.



This symbol indicates "dangerous voltage" inside the product that presents a risk of electric shock or personal injury.



This symbol indicates important instructions accompanying the product.

Do not install this equipment in a confined space such as a bookcase or similar unit.

WARNING : To prevent damage which may result in fire or electric shock hazard, do not expose this appliance to rain or moisture.

CAUTION : DVD PLAYERS USE AN INVISIBLE LASER BEAM WHICH CAN CAUSE HAZARDOUS RADIATION EXPOSURE IF DIRECTED. BE SURE TO OPERATE PLAYER CORRECTLY AS INSTRUCTED.

CAUTIONS

Caution: To prevent electric shock, match wide blade of plug to wide slot, fully insert.

Attention: Pour éviter les chocs électriques, introduire la lame la plus large de la fiche dans la borne correspondante de la prise et pousser jusqu'au fond.

This product satisfies FCC regulations when shielded cables and connectors are used to connect the unit to other equipment. To prevent electromagnetic interference with electric appliances, such as radios and televisions, use shielded cables and connectors for connections.

FCC NOTE (for U.S.A):

This equipment has been tested and found to comply with the limits for a Class B digital device, pursuant to Part 15 of the FCC rules. These limits are designed to provide reasonable protection against harmful interference in a residential installation. This equipment generates, uses and can radiate radio frequency energy and, if not installed and used in accordance with the instructions, may cause harmful interference to radio or television reception, which can be determined by turning the equipment off and on.

The user is encouraged to try to correct the interference by one or more of the following measures.

- Reorient or relocate the receiving antenna.
- Increase the separation between the equipment and receiver.
- Connect this equipment into an outlet on a circuit different from that to which the receiver is connected.
- Consult the dealer or an experienced radio/TV technician for help.

This class B digital apparatus meets all requirements of the Canadian Interference -- Causing Equipment Regulations.

CLASS 1 LASER PRODUCT
 KLASSE 1 LASER PRODUKT
 LUOKAN 1 LASER LAITE
 KLASS 1 LASER APPARAT
 PRODUCTO LÁSER CLASE 1

Precautions

CAUTION

THIS PRODUCT UTILIZES A LASER. USE OF CONTROLS OR ADJUSTMENTS OR PERFORMANCE OF PROCEDURES OTHER THAN THOSE SPECIFIED HEREIN MAY RESULT IN HAZARDOUS RADIATION EXPOSURE. DO NOT OPEN COVER AND DO NOT REPAIR YOURSELF. REFER SERVICING TO QUALIFIED PERSONNEL.

Note:

- This unit can be used only where the power supply is AC 120V, 60Hz. It cannot be used elsewhere.
- This DVD player is designed and manufactured to respond to the Region Management Information. If the Region number of a DVD disc does not correspond to the Region number of this DVD player, the DVD player cannot play the disc.
- This device is protected by U.S. Patent Nos. 4,631,603; 4,577,216; 4,819,098; 4,907,093; and 6,516,132. This product incorporates copyright protection technology that is protected by U.S. patents and other intellectual property rights. Use of this copyright protection technology must be authorized by Macrovision, and is intended for home and other limited viewing uses only unless otherwise authorized by Macrovision. Reverse engineering or disassembly is prohibited.

Handling Cautions

- Before connecting other components to this player, be sure to turn them all off.
- Do not move the player while a disc is being played, or the disc may be scratched or broken, and the player's internal parts may be damaged.
- Do not put a flower vase filled with water or any small metal objects on the player.
- Be careful not to put your hand into the disc tray.
- Do not place anything other than the disc in the disc tray.
- Exterior interference such as lightning and static electricity can affect normal operation of this player. If this occurs, turn the player off and on again with the POWER button, or disconnect and then reconnect the AC power cord to the AC power outlet. The player will operate normally.
- Be sure to remove the disc and turn off the player after use.
- Disconnect the AC power cord from the AC outlet when you don't intend to use the player for long periods of time.
- Clean the disc by wiping in a straight line from the inside to the outside of the disc.

Disc Storage

Be careful not to harm the disc because the data on these discs is highly vulnerable to the environment.

- Do not keep under direct sunlight.
- Keep in a cool ventilated area.
- Store vertically.
- Keep in a clean protection jacket.

Maintenance of Cabinet

For safety reasons, be sure to disconnect the AC power cord from the AC outlet.

- Do not use benzene, thinner, or other solvents for cleaning.
- Wipe the cabinet with a soft cloth.

Before you start

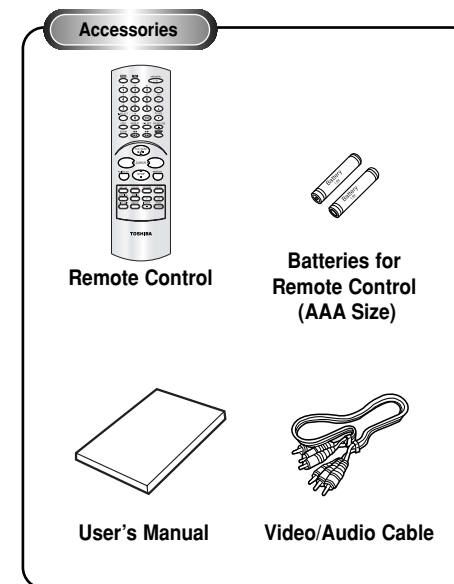

Install Batteries in the Remote

1. Open the battery cover on the back of the remote.
2. Insert two AAA batteries. Make sure that the polarities (+ and -) are aligned correctly.
3. Replace the battery cover.

If remote doesn't operate properly:

- Check the polarity + - of the batteries (Dry-Cell)
- Check if the batteries are drained.
- Check if remote sensor is blocked by obstacles.
- Check if there is any fluorescent lighting nearby.
- Add in the distance & angle of the remote control with reference with remote receiver.

Table of Contents

Setup

Important Safety Instructions	2
Precautions	3
Before you start	5
General Features	6
Disc Type and Characteristics	7
Description-Front Panel	8
Display Indicators	9
Description-Rear Panel	10
Tour of the Remote Control	11

Connections

Choosing a Connection	12
-----------------------	----

Basic Functions

Playing a Disc	14
Operating the Disc Changer	15
Using the Search & Skip Functions	15
Using the Display Function	16
Using the Disc and Title Menu	17
Using the Function Menu	17
Repeat Play	18
Slow Repeat Play	18
Program Play & Random Play	19

Advanced Functions

Selecting the Audio Language	20
Selecting the Subtitle Language	20
Changing the Camera Angle	21
Using the Bookmark Function	21
Using the Zoom Function	22
SACD Playback	23
DVD AUDIO Playback	24
Clips Menu for MP3/WMA/JPEG	26
Folder Selection	26
MP3/WMA Playback	27
Picture CD Playback	28

Changing Setup menu

Using the Setup Menu	29
Setting Up the Language Features	29
Setting Up the Audio Options	31
Surround Sound Speaker Setup	32
Setting Up the Display Options	33
Setting Up the Parental Control	34

Reference

Controlling a TV with the Remote	36
Troubleshooting	37
Specifications	38
Warranty	39

General Features

DVD Changer

The DVD Changer holds 5 discs and provides full random play with fast disc changes when press and hold NUMBER button.

Excellent Sound

Dolby Digital, a technology developed by Dolby Laboratories, provides crystal clear sound reproduction.

Screen

Both regular and widescreen(16:9) pictures can be viewed.

Slow Motion

An important scene can be viewed in slow motion.

Programmed Play (CD)

You can program tracks to play in desired order.

Parental Control (DVD)

The parental control allows users to set the level necessary to prohibit children from viewing harmful movies such as those with violence, adult subject matter, etc.

Various On-Screen Menu Functions

You can select various languages (Audio/Subtitle) and screen angles while enjoying movies.

Progressive Scan

Progressive scanning creates an improved picture with double the scan lines of a conventional interlaced picture.

Digital Photo Viewer (JPEG)

You can view Digital Photos on your TV.

Repeat

You can repeat a song or movie simply by pressing the REPEAT button.

MP3/WMA

This unit can play discs created from MP3/WMA files.

SACD (Super Audio CD)

SACD is a high quality audio format with higher sampling rates and fuller, richer sound as compared to regular CD.

DVD AUDIO

DVD AUDIO is a format specifically designed to provide the highest possible audio fidelity capable on DVD.

Note

* Discs which cannot be played with this player.

- DVD-ROM • DVD-RAM
- CD-ROM • CDV
- CDI
- CDGs play audio only, not graphics.

* Ability to play back may depend on recording conditions.

- DVD-R, +R • CD-RW
- DVD+RW, -RW

* It may not play CD-R, CD-RW and DVD-R in all cases due to the type of disc or condition of the recording.

COPY PROTECTION

Many DVD discs are encoded with copy protection. Because of this, you should only connect your DVD player directly to your TV, not to a VCR. Connecting to a VCR results in a distorted picture from copy-protected DVD discs.





This product incorporates copyright protection technology that is protected by methods claims of certain U.S. patents and other intellectual property rights owned by Macrovision Corporation and other rights owners. Use of this copyright protection technology must be authorized by Macrovision Corporation, and is intended for home and other limited viewing uses only unless otherwise authorized by Macrovision Corporation. Reverse engineering or disassembly is prohibited.

PROGRESSIVE SCAN OUTPUTS (525p/625p)

"CONSUMERS SHOULD NOTE THAT NOT ALL HIGH DEFINITION TELEVISION SETS ARE FULLY COMPATIBLE WITH THIS PRODUCT AND MAY CAUSE ARTIFACTS TO BE DISPLAYED IN THE PICTURE, IN CASE OF 525 OR 625 PROGRESSIVE SCAN PICTURE PROBLEMS, IT IS RECOMMENDED THAT THE USER SWITCH THE CONNECTION TO THE 'STANDARD DEFINITION' OUTPUT. IF THERE ARE QUESTIONS REGARDING OUR TV SET COMPATIBILITY WITH THIS MODEL 525p AND 625p DVD PLAYER, PLEASE CONTACT OUR CUSTOMER SERVICE CENTER."

Disc Type and Characteristics



This DVD player is capable of playing the following types of discs with the corresponding logos:

Disc Types (Logos)	Recording Types	Disc Size	Max. Playing Time	Characteristics
	Audio + Video	5"	Single-sided 240 min. Double-sided 480 min.	<ul style="list-style-type: none"> • DVD contains excellent sound and video due to Dolby Digital and MPEG-2 system. • Various screen and audio functions can be easily selected through the on-screen menu.
		3 1/2"	Single-sided 80 min. Double-sided 160 min.	
	Audio	5"	74 min.	<ul style="list-style-type: none"> • CD is recorded as a Digital Signal with better audio quality, less distortion and less deterioration of audio quality over time.
		3 1/2"	20 min.	
	Audio + Video	5"	400 min.	<ul style="list-style-type: none"> • DVD AUDIO is a format specifically designed to provide the highest possible audio fidelity capable on DVD.
	Audio	5"	74 min.	<ul style="list-style-type: none"> • SACD is a high quality audio format with higher sampling rates and fuller, richer sound as compared to regular CD.

Disc Markings

	Play Region Number
	NTSC broadcast system in U.S.A, Canada, Korea, Japan, etc.
	Dolby Digital disc
	Stereo disc
	Digital Audio disc
	DTS disc
	MP3 disc
	SACD disc
	DVD Audio disc

Play Region Number

Both the DVD player and the discs are coded by region. These regional codes must match in order for the disc to play. If the codes do not match, the disc will not play. The Region number for this player is 1. If region for numbers, which stand for their playable area, are printed on your DVD video disc and you do not find  or , disc playback will not be allowed by the player. If the DVD disc does not have any region number printed, the disc playback is not guaranteed.

Description-Front Panel

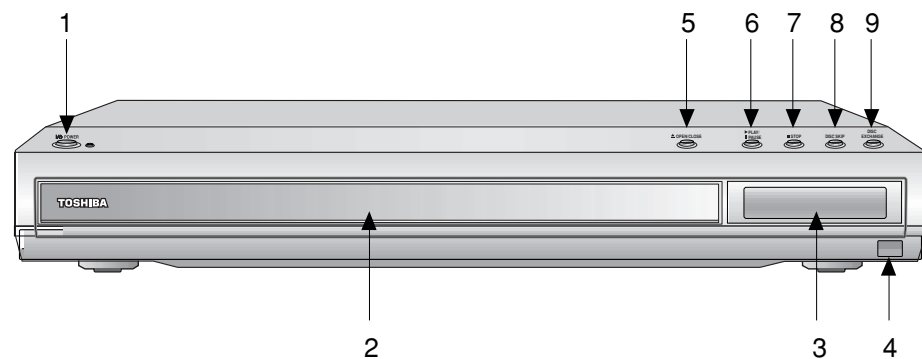

Front Panel Controls

1. **POWER** (I/O)
 - Use to turn your player on and off (standby).
2. **DVD CHANGER (TRAY)**
 - Press OPEN/CLOSE to open and close the disc changer.
3. **FRONT DISPLAY**
 - Operation indicators are displayed here.
4. **REMOTE CONTROL SENSOR**
5. **OPEN/CLOSE** (▲)
 - Press to open and close the disc tray.
6. **PLAY/PAUSE** (▶/||)
 - Begin or pause disc play.
7. **STOP** (■)
 - Stops disc play.
8. **DISC SKIP**
 - Use to skip a disc in order.
9. **DISC EXCHANGE**
 - Press this button when you want to change a disc without stopping playback of the current disc.

Display Indicators

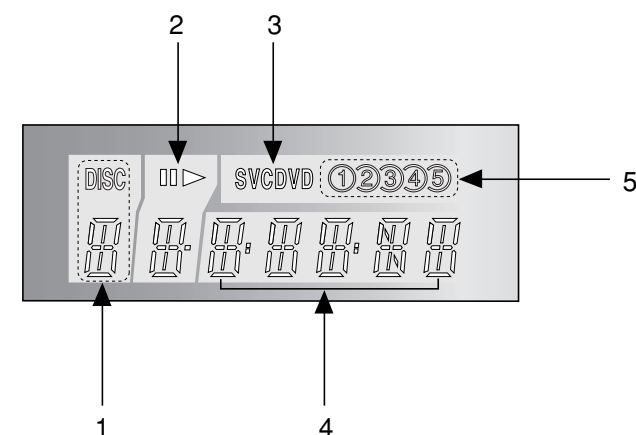

Front Panel Display

1. Tray number / Chapter / Track Indicator
2. Play / Pause / Forward play
3. Disc type indicator
4. Displays various messages concerning operations such as PLAY, STOP, LOAD, ...
 - no DISC** : No disc loaded.
 - OPEN** : The disc tray is open.
 - LOAD** : Player is loading disc information.
5. Disc indicator
 - Indicates all the discs being in tray.
 - The tray number in playing twinkles.

Important Note

- In case of initial playback after opening, the indicator inexactly displays a tray number whether or not each tray has a disc, please check the tray by using the DISC SKIP button.
- During playback of SACD, the indicator scrolls "SACD" once after first loading and display "CD".
- During playback of DVD-AUDIO, the indicator scrolls "DVD-AUDIO" once after first loading and display "DVD".

Description-Rear Panel

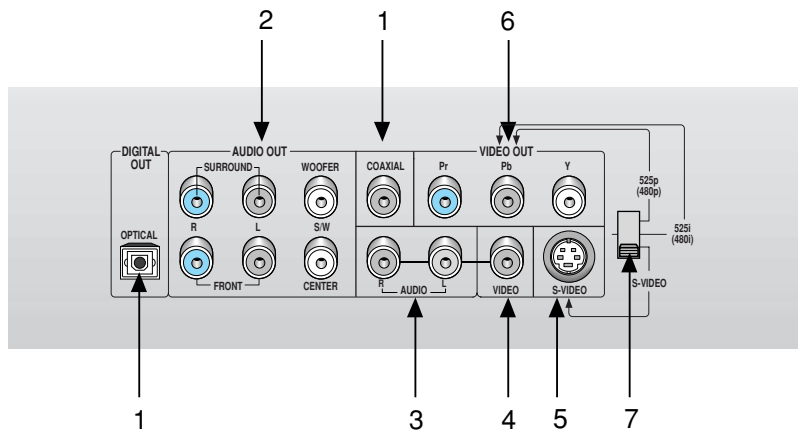

Rear Panel

1. DIGITAL AUDIO OUT JACKS

- Use an optical or coaxial digital cable to connect to a compatible Dolby Digital receiver.
- Use to connect to an A/V Amplifier that contains a Dolby Digital or DTS decoder.

2. 5.1CH ANALOG AUDIO OUT JACKS

- Connect to an amplifier with 5.1ch analog input jacks.

3. MIXED AUDIO OUT JACKS

- Connect to the Audio input jacks of your television, audio/video receiver.

4. VIDEO OUT JACK

- Use a video cable to connect to the Video input jack on your television.
- The Video Output must select the 525i(480i) or S-Video by setting Video select switch.

5. S-VIDEO OUT JACK

- Use the S-Video cable to connect this jack to the S-Video jack on your television for a higher quality picture.
- The Video Output must select the S-Video by setting Video select switch.

6. COMPONENT VIDEO OUT JACKS

- Use these jacks if you have a TV with Component Video in jacks. These jacks provide Pr, Pb and Y video. Along with Component Video provides the best picture quality.
- If 525p(480p) Video Out is selected by setting Video select switch progressive scan mode will work.
- If 525i(480i) Video Out is selected by setting Video select switch interlace scan mode will work.

7. Video Select Switch

Important Note

- Consult your TV User's Manual to find out if your TV supports Progressive Scan. If Progressive Scan is supported, follow the TV User's Manual's instructions regarding Progressive Scan settings in the TV's menu system.
- If 525p(480p) Video Output is selected by setting Video select switch, Video (Composite) and S-Video will not work.

Tour of the Remote Control

This remote control can also control most TVs. See pages 36.

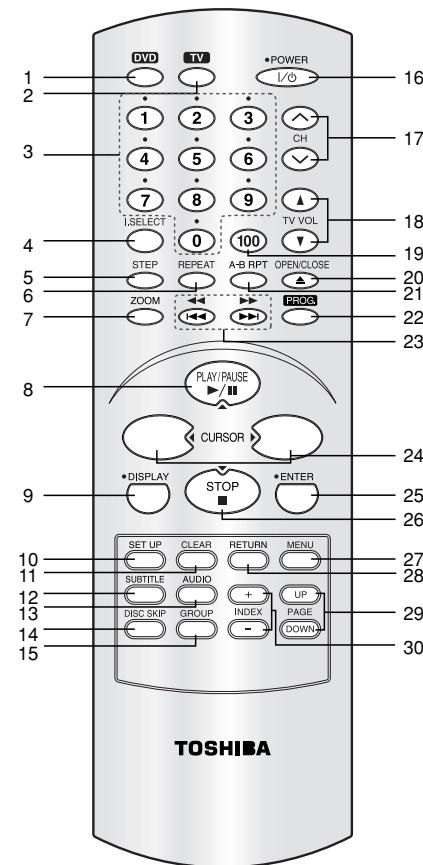

8. PLAY/PAUSE Button (▶/||)

- Press and hold the button for about 2 second to begin/pause disc play in menu.

9. DISPLAY Button

- Displays the current disc mode.

10. SET UP Button

- Brings up the DVD player's menu.

11. CLEAR Button

- Use to remove menus or status displays from the screen.

12. SUBTITLE Button

13. AUDIO Button

- Use this button to access various audio functions on a disc.

14. DISC SKIP Button

- Use to skip a disc in order.

15. GROUP Button

- Use to select the GROUP.

16. POWER Button

- Turns the DVD player's power on or off.

17. TV CH ^/∇ Buttons

- Channel selection.

18. TV VOL +/- Buttons

- Control volumes.

19. TV 100 button

- Channel number button.

20. OPEN/CLOSE (▲) Button

- To open and close the disc tray.

21. A-B REPEAT Button

- Use to mark a segment to repeat between A and B.

22. PROG Button

- Allows you to program a specific order.

23. SEARCH/SKIP Buttons (◀ / ▶, ◀◀ / ▶▶)

- Allows you to search forward/backward through a disc. Use to skip the title, chapter or track.

24. CURSOR Button

25. ENTER Button

- This button functions as a toggle switch.

26. STOP Button (■)

- Press and hold the button in menu for about 2 second.

27. MENU Button

- Brings up the Disc menu.

28. RETURN Button

- Returns to a previous menu.

29. PAGE Buttons

- Use to skip the PAGE.

30. INDEX Buttons

- Use to skip the INDEX.

DVD Function Buttons

1. DVD Button

- DVD mode select button.

2. TV Button

- TV mode select button.

3. NUMBER Buttons

4. I.SELECT Button

- TV input select.

5. STEP Button

- Advances play one frame at a time.

6. REPEAT Button

- Allows you to repeat play a title, chapter, track, or disc.

7. ZOOM Button

- Enlarges DVD picture.

Choosing a Connection

The following shows examples of connections commonly used to connect the DVD player with a TV and other components.

Before Connecting the DVD Player

- Always turn off the DVD player, TV, and other components before you connect or disconnect any cables.
- If you connected an external Audio System, turn on your Audio System and set it to the correct Audio Input.
- Refer to the owner's manual of the additional components you are connecting for more information on those particular components.

Connection to an Audio System

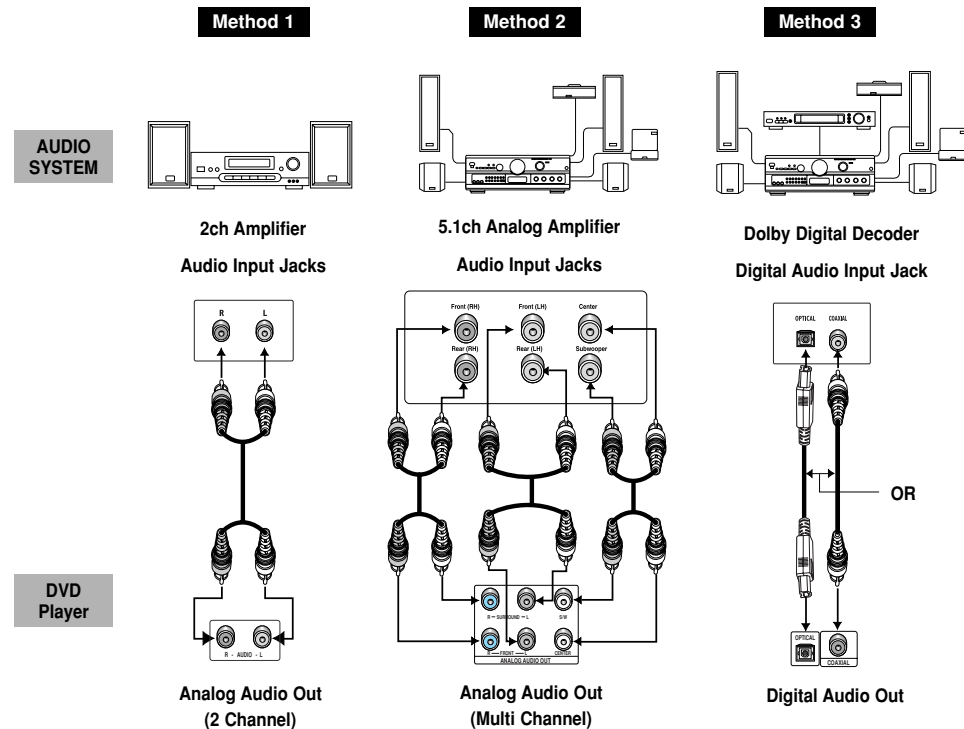

Note

- In case of DVD-AUDIO, SACD playback cannot use Digital Audio Out.
- In case of SACD playback cannot use multi channel or 2 channel Digital Audio out. (See page 31~32)

Choosing a Connection

Connection to a TV (For Video)

TV (Normal, Widescreen, Projection, etc..)

- Turn on your TV and set it to the correct Video Input by pressing TV/VIDEO button on.

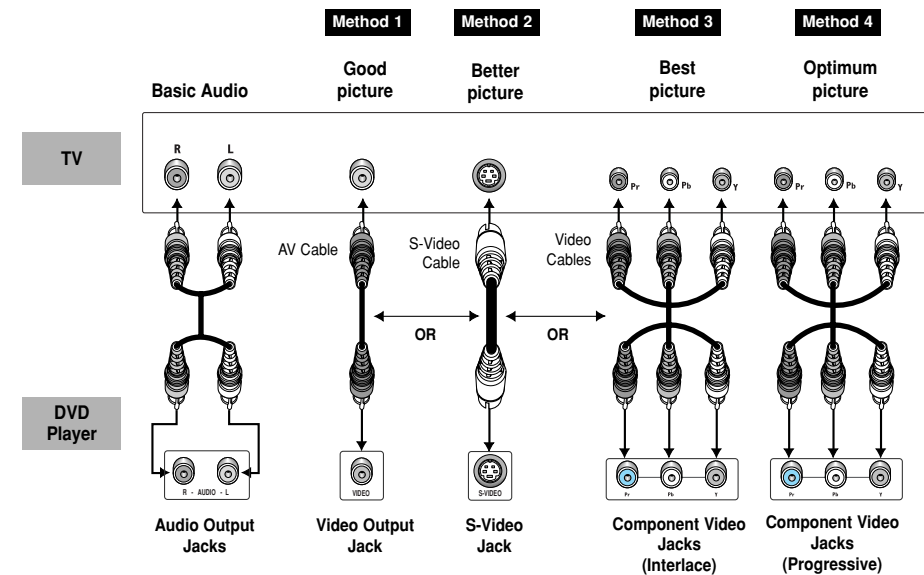

Method 1

DVD Player + TV with Video Input Jack
(The Video Output must select the S-Video or 525i(480i) by setting Video select switch.)

Method 2

DVD Player + TV with S-Video Input Jack
(The Video Output must select the S-Video by setting Video select switch.)

Method 3

DVD Player + TV with Component Video Jacks
(The Video Output must select the 525i(480i) by setting Video select switch.)

Method 4

DVD Player + TV with Progressive Scan Jacks.
(The Video Output must select the 525p(480p) by Video select switch.)

- If you want to convert Video Output to the Progressive Scan, you have to first connect Video or S-Video on your TV. Then select 525p(480p) by using Video select switch.
- If 525p(480p) Video Output is selected by setting Video select switch, Video(Composite) and S-Video will not work.
- Our set do not have Video output setting in setup menu.

Important Note

- Consult your TV User's Manual to find out if your TV supports Progressive Scan. If Progressive Scan is supported, follow the TV User's Manual's instructions regarding Progressive Scan settings in the TV's menu system.
- Depending on your TV, the Method of connection may differ from the illustration above.

Playing a Disc

Before Play

- Turn on your TV and set it to the correct Video Input by pressing TV/VIDEO button on.
- If you connected an external Audio System, turn on your Audio System and set it to the correct Audio Input.

After plugging in the player, the first time you press the DVD POWER button, this screen comes up :
If you want to select language, press a NUMBER button. (This screen will only appear when you plug in the player for the first time.)
If you don't select language, at first time, setting value of Setup menu will be lost.



Play

1. Press the OPEN/CLOSE button.
The STANDBY indicator light goes out and the tray opens.
2. Place a disc gently into the tray with the disc's label facing up.
3. Press and hold the PLAY/PAUSE (▶/||) button or OPEN/CLOSE button to close the disc tray.
4. Stopping Play
Press the STOP (■) button during play.
5. Removing Disc
Press the OPEN/CLOSE button.
6. Pausing Play
Press and hold the PLAY/PAUSE (▶/||) or STEP button on the remote during play.
 - Screen stops, no sound.
 - To resume, press and hold the PLAY/PAUSE (▶/||) button once again.

7. Step Motion Play

- (Except CD/DVD-AUDIO/SACD)
Press the STEP button on the remote during play.
- Each time the button is pressed, a new frame will appear.
 - No sound is heard during STEP mode.
 - Press and hold the PLAY/PAUSE (▶/||) to resume normal play.
(You can only perform step motion play in the forward direction.)

8. Slow Motion Play

- (Except CD/DVD-AUDIO/SACD)
Press and Hold the FWD SEARCH (▶▶) button on the remote during PAUSE or STEP mode.
- By pressing the FWD SEARCH (▶▶) button, you can select slow motion play for 1/8, 1/4 or 1/2 of normal speed.
 - No sound is heard during slow mode.
 - Press and hold the PLAY/PAUSE (▶/||) to resume normal play.
 - Reverse slow motion play will not work.

RESUME function

When you stop disc play, the player remembers where you stopped, so when you press and hold the PLAY/PAUSE (▶/||) button again, it will pick up where you left off. (unless the disc is removed or the player is unplugged, or if you press and hold the STOP (■) button twice.)

Note

- If the player is left for about 5 minutes in pause mode, it will stop.
- If the player is left in the stop mode for more than about 30 minutes, the power will automatically shut off. (Automatic Power-Off Function)
- If the player is left in the stop mode for more than one minute without any user interaction, a screen saver will be activated. Press and hold the PLAY/PAUSE (▶/||) button to resume normal play.
- This  icon indicates an invalid button press.
- When menu screen is displayed, one press of PLAY/PAUSE (▶/||) button or STOP (■) button function as the Up/down cursor. It will only activate the Play, Pause or Stop function when it is press and hold for about 2 seconds.

Operating the Disc Changer

The DVD Changer holds 5 discs and provides full random play with fast disc changes when press and hold NUMBER button.

Exchanging Discs

Exchange allows you to change up to 4 discs except the disc currently playing.

1. Press the DISC EXCHANGE button on the front of the player when in the play mode.
The tray opens with two slots available for you to load or change discs.
2. Press the DISC SKIP button on the remote or on the front of the player to turn the platter to the other two slots. And load or change the third and fourth discs.
 - To change all the discs, first press the STOP button, then the OPEN/CLOSE and DISC SKIP buttons.
3. Press the DISC EXCHANGE or OPEN/CLOSE button on the front of the player to close the disc tray.

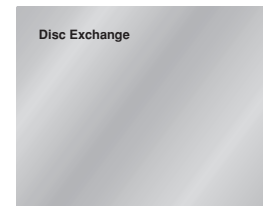

Using the DISC SKIP function

Use the Disc Skip function to change to another disc currently in the disc platter.

1. While in play or stop mode, press the DISC SKIP button. The platter turns clockwise to the next available disc.

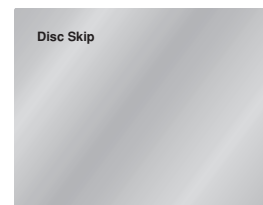

Using the Search & Skip Functions

During play, you can search quickly through a chapter or track or use the skip function to jump to the next selection.

Searching through a Chapter or Track

During play, press and hold the ◀◀ or ▶▶ button on the remote.

- In case of SACD, when the clip menu is off, you can use this function. (See page 23)

DVD	2X, 4X, 8X, 32X, 128X
CD/SACD/DVD-AUDIO	2X, 4X, 8X

Skipping Tracks

During play, press the ◀◀ or ▶▶ button.

- When playing a DVD/DVD-AUDIO, if you press the ▶▶ button, it moves to the next chapter. If you press the ◀◀ button, it moves to the beginning of the chapter. One more press makes it move to the beginning of the previous chapter.
- When playing a SACD or CD, if you press the ▶▶ button, it moves to the next track. If you press the ◀◀ button, it moves to the beginning of the track. One more press makes it move to the beginning of the previous track.

Using the Display Function

When Playing a DVD

1. During play, press the DISPLAY button on the remote.
2. Use the UP/DOWN buttons to select the desired item.
3. Use the LEFT/RIGHT buttons to make the desired setup and then press the ENTER button.
 - You may use the number buttons of the remote control to directly access a title, chapter or to start the playback from the desired time.
4. To make the screen disappear, press the DISPLAY button again.

DVD



When Playing a CD

1. A CD play starts.
The DISPLAY window appears directly.
2. Press the DISPLAY button, the display window disappears

CD



Title To access the desired title when there is more than one in the disc.
For example, if there is more than one movie on a DVD, each movie will be identified.



Chapter Most DVD discs are recorded in chapters so that you can quickly find a specific passage (similar to tracks on an audio CD).



Time Allows playback of the film from a desired time. You must enter the starting time as a reference.



Audio Refers to the language of the film soundtrack. In the example, the soundtrack is played in English 5.1CH. A DVD disc can have up to eight different soundtracks.



Subtitle Refers to the subtitle languages available in the disc. You will be able to choose the subtitle languages or, if you prefer, turn them off from the screen. A DVD disc can have up to 32 different subtitles.

Using the Disc and Title Menu

Using the Disc Menu

1. During the playback of a DVD disc, press the SETUP button on the remote.
2. Select **Disc Menu** using the UP/DOWN buttons, then press the RIGHT or ENTER button.

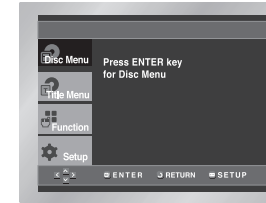

Using the Title Menu

1. During the playback of a DVD disc, press the SETUP button on the remote.
2. Select **Title Menu** using the UP/DOWN buttons, then press the RIGHT or ENTER button.



Note

- Depending on a disc, the Title and Disc Menus may not work.
- Title Menu will only be displayed if there are at least two titles in the disc.
- You can also use the Disc Menu, using the MENU button on the remote.

Using the Function Menu

Using the Function Menu

1. Press the SETUP button during playback.
2. Use the UP/DOWN buttons to highlight **Function**, then press the RIGHT or ENTER button.
3. Function selection screen appears: Info, Zoom, Bookmark, Repeat and EZ View.
 - Info (See Page 17)
 - Zoom (See Page 22)
 - Bookmark (See Page 21~22)
 - Repeat (See Page 18)
 - SACD/CD (See Page 23~24)
 - Angle (See Page 21)
4. Use the UP/DOWN button to highlight one of the 6 functions. Then press the RIGHT or ENTER button to access the function.

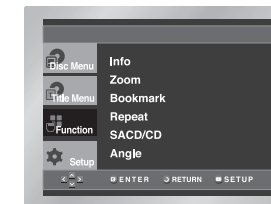

Note

- You can also directly select these functions using their respective buttons on the remote.

Repeat Play

Repeat the current track, chapter, title, a chosen section (A-B), or all of the disc.

When playing a DVD/CD

1. Press the REPEAT button on the remote.
Repeat screen appears.
2. Select Chapter, Title or A-B using the LEFT/RIGHT buttons.
 - Chapter (): repeats the chapter that is playing.
 - Title (): repeats the title that is playing.
 - A-B : repeats a segment of the disc that you select.

DVD



CD



* A-B REPEAT

- Press the REPEAT button. Select A-B on screen with the LEFT/RIGHT buttons or press the A-B RPT button on the remote.
 - Press ENTER at the point where you want the repeat play to start (A). The B is automatically highlighted.
 - Press ENTER at the point where you want the repeat play to stop (B).
 - To terminate the function, press the CLEAR button or A-B RPT button again.
 - A-B REPEAT does not allow you to set point (B) until at least 5 seconds has elapsed after point (A) has been set.
3. Press ENTER.
 4. To return to normal play, press REPEAT again, then press the LEFT/RIGHT buttons to select Off and press ENTER.

Note

- DVD repeats play by chapter or title, CD repeats play by disc or track.
- Depending on a disc, the Repeat function may not work.

Slow Repeat Play

This feature allows you slowly to repeat scenes containing sports, dancing, musical instruments being played etc. so you can study them more closely.

When playing a DVD

1. During play, press and hold the PLAY/PAUSE () button.
2. Press and hold the ►► button on the remote during PAUSE or STEP mode. Press again and you can select slow motion play for 1/8, 1/4 and 1/2 of normal speed.
3. Press the A-B RPT button to select the point where the function starts. (A)
4. Press the A-B RPT button to select the point where the function ends. (B)

Note

- The disc will play from A to B repeatedly at the speed you chose.
- To terminate the function, press the CLEAR button or A-B RPT button again.

ENG-18

Program Play & Random Play

Program Play (CD)

1. Press the PROG. button.
2. Use the LEFT/RIGHT buttons to select PROGRAM. Press the ENTER button.
3. Use the LEFT/RIGHT/UP/DOWN buttons to select the first track to add to the program. Press the ENTER button. The selection numbers appear in the Program Order box.
4. Press and hold the PLAY/PAUSE () button. The disc will be played in programmed order.

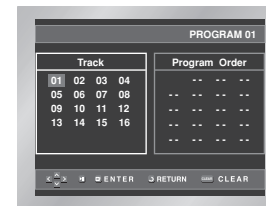

Random Play (only CD-DA)

1. Press the PROG. button.
2. Use the LEFT/RIGHT buttons to select RANDOM. Press the ENTER button.
3. You can see the RANDOM 1/2/3, choose a number by using the LEFT/RIGHT buttons and then press the ENTER button.
 - Random 1 : Plays all the tracks on a single disc in random order and then stop.
 - Random 2 : Plays all the tracks on current disc in random order and then plays all the tracks on each succeeding disc in random order and then stops.
 - Random 3 : Plays 3 tracks randomly from a disc and then plays 3 tracks randomly on other discs until all CD discs turn twice.
4. To return to normal playback, press CLEAR button.



Note

- Depending on a disc, the Program and Random Play functions may not work.
- This unit can support a maximum of 20 programmed tracks.
- While in playback mode, press the CLEAR button on the remote control to cancel Programmed Play or Random Play.
- During EXCHANGE function, Random play doesn't work.

ENG-19

Selecting the Audio Language

You can select a desired language quickly and easily with the AUDIO button.

Using the AUDIO button

1. Press the AUDIO button.
2. The Audio changes when the button is pressed repeatedly.
 - The audio languages are represented by abbreviations.
3. Press the AUDIO button to select Stereo, Left or Right. (On CD)

DVD



CD



Note

- This function depends on what languages are encoded on the disc and may not work with all DVDs.
- A DVD disc can contain up to 8 audio languages.
- **How to have the same audio language come up whenever you play a DVD;** Refer to "Setting Up the Language Features" on page 30.

Selecting the Subtitle Language

You can select a desired subtitle quickly and easily with the SUBTITLE button.

Using the SUBTITLE button

1. Press the SUBTITLE button.
2. The subtitle changes when the button is pressed repeatedly.
3. To turn off the display, press the CLEAR or RETURN button.
 - Initially, the subtitle will not appear on screen.
 - The subtitle languages are represented by abbreviations.



Note

- This function depends on what languages are encoded on the disc and may not work with all DVDs.
- A DVD disc can contain up to 32 subtitle languages.
- **How to have the same subtitle language come up whenever you play a DVD;** Refer to "Setting Up the Language Features" on page 31.

ENG-20

Changing the Camera Angle

When a DVD contains multiple angles of a particular scene, you can use the ANGLE function.

Using the ANGLE Function

If the disc contains multiple angles, the ANGLE mark appears on the screen.

1. Press the SETUP button and select the angle in Function, then ANGLE icon will appear with the current angle number and the number of angles available.
2. Select the desired angle by using the LEFT/RIGHT button and press ENTER.
3. To remove the ANGLE icon, press the CLEAR or RETURN button.

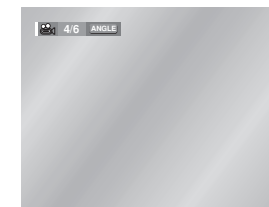
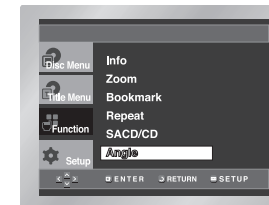

Note

- If the disc has only one angle, this feature won't work. Currently, very few discs have this feature.

Using the Bookmark Function

This feature lets you bookmark sections of a DVD so you can quickly find them at a later time.

Using the Bookmark Function (DVD)

1. During play, press the SETUP button on the remote.
2. Use the UP/DOWN buttons to highlight **Function**, then press the RIGHT or ENTER button.
3. Select **Bookmark** using the UP/DOWN buttons, then press the RIGHT or ENTER button.
4. Use the LEFT/RIGHT buttons to move to the desired bookmark icon.
5. When you reach the scene you want to mark, press the ENTER button. The icon will change to a number (1, 2, or 3).

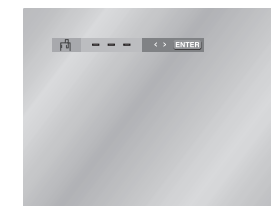
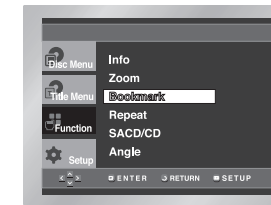

Note

- If you want to playback the marked scene press and hold PLAY/PAUSE button (▶||) at the Highlighted number.

ENG-21

Using the Bookmark Function

Recalling a Marked Scene

1. During play, press the SETUP button on the remote and select the **Bookmark**.
2. Use the LEFT/RIGHT buttons to select a marked scene.
3. Press and hold the PLAY/PAUSE (▶/⏸) button to skip to the marked scene.



Clearing a Bookmark

1. During play, press the SETUP button on the remote and select the **Bookmark**.
2. Use the LEFT/RIGHT buttons to select the bookmark number you want to delete.
3. Press the CLEAR button to delete a bookmark number.

Note

- Up to three scenes may be marked at a time.
- Depending on a disc, the Bookmark function may not work.

Using the Zoom Function

Using the Zoom Function (DVD)

1. During play or pause mode, press the ZOOM button on the remote.
A Zoom mark will be displayed on screen.
2. Use the UP/DOWN or LEFT/RIGHT buttons to select the part of the screen you want to zoom in on.
3. Press the ENTER button.
- During DVD play, press ENTER to zoom in 2X/4X/2X/Normal in order.

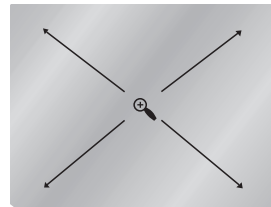

SACD Playback

1. Open the disc tray.
2. Place the SACD disc on the tray.
- Place the SACD disc with the labeled side up.
3. Close the tray.
- The tray closes and you should get a screen that looks like the one below.



SACD Clips Menu On Play Function

1. Use the UP/DOWN buttons to select a music title.
2. Press the ENTER button to begin playback of the music title.
- If you want to use the Repeat Function, press the REPEAT button to change the mode, such as Off, Track, Disc.
*Off : Normal Playback
*Track : Repeats the current music track.
*Disc : Repeats the music disc in the SACD.
- If you want to see information about the Disc title and Artist, press the DISPLAY button.
- During play or stop mode, you can change the 2CH or MULTI mode use LEFT/RIGHT button.
- On the stop mode, press the SETUP button and select the SACD/CD in Function to playback in regular CD mode.

Note

- You can use this function when SACD disc includes multi channel and 2 channel audio format.

SACD Clips Menu Off Play Function

1. In Stop mode, press the MENU button until the Clips menu is off.
2. Press and hold the PLAY/PAUSE (▶/⏸) button.
3. The Display appears directly. A SACD play starts in Menu Off mode.
4. Use the UP/DOWN buttons to select the desired item.



5. Use the LEFT/RIGHT buttons to make the desired setup and then press ENTER.
• You may use the number buttons of the remote control to directly access a track and to start the playback from the desired time.
6. To make the screen disappear, press the DISPLAY button.



To access the desired Track when there is more than one in the disc.



Allows playback from a desired time by using the number buttons.



If you want to change the 2channel or multi channel play or stop mode, press AUDIO button.
- 2CH : L, R
- MULTI : F/L, F/R, R/L, R/R, C/T, S/W

Note

- You can use this function when SACD disc includes multi channel and 2 channel audio format.

SACD Playback

CD Layer Play Function

At SACD disc stop mode, press the SETUP button and select the SACD/CD in Function by using LEFT/RIGHT/UP/DOWN and then press the ENTER button. You can playback CD layer in SACD disc. (Refer to the page 16 to setting CD playback Function).

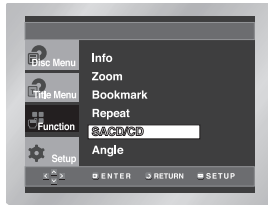

Track To access the desired Track when there is more than one in the disc.

Time Allows playback from a desired time. You must enter the starting time as a reference.

Note

- Some SACD discs do not include a CD layer.
- Depending on a disc, this function may not work.

DVD AUDIO Playback

1. Open the disc tray.
2. Place the DVD AUDIO disc on the tray.
 - Place the DVD AUDIO disc with the labeled side up.
3. Close the tray.
 - The tray closes and disc plays.

Using the Display Function

1. During play, press the DISPLAY button on the remote.
2. Use the UP/DOWN buttons to select the desired item.
3. Use the LEFT/RIGHT buttons to make the desired setup and then press ENTER.
 - You may use the number buttons of the remote control to directly access a Group, Track, Page or to start the playback from the desired time.
4. To make the screen disappear, press the DISPLAY button again.



Note

Some DVD-AUDIO discs don't audio down-mixing. These discs always output 5.1ch analog audio regardless of audio setup.

ENG-24

DVD AUDIO Playback

Group Most DVD AUDIO discs are recorded in Group, you can change Groups with this Function.

Note

- * Bonus Group playback.
- Some DVD AUDIO discs have Bonus groups. If you want to play a Bonus group you must enter the Bonus Group code. The code is usually on DVD AUDIO disc case.

Track To access the desired Track when there is more than one on the DVD AUDIO disc.

Page If pages are included with the DVD-AUDIO, you can see this icon. To access the desired page, you can use this Function.

Slide If a slide show is included with the DVD-AUDIO, you can see this icon. In this case you cannot use PAGE UP/DOWN buttons.

Vzone If a video zone is included with the DVD-AUDIO, you can see this icon. In this case you cannot use PAGE UP/DOWN buttons.

Time Allows playback of the music from a desired time by using the number buttons.

Group, Index, Page Function

- Use the GROUP button to change a group.
- Use PAGE UP/DOWN buttons to Skip the Page when there is more than one in a group.
- Some DVD-AUDIO discs include a slide show. In the slide show mode, this function can not use.
- PAGE is still images. You can see the still images when DVD-AUDIO disc plays .
- Use INDEX +/- buttons to Skip the Index when there is more than one in a track.

Note Depending on a disc, this function may not work.

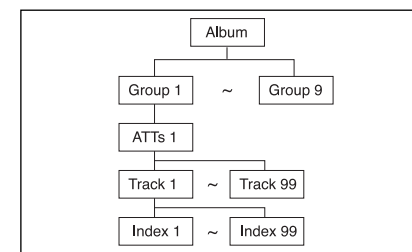

ENG-25

REPEAT Play

1. Press the REPEAT button on the remote.
2. Select Title, Group using the LEFT/RIGHT button.
3. Press ENTER.

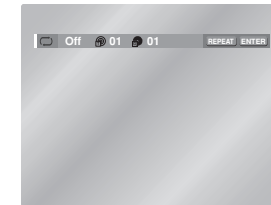

AUDIO Format Display

During DVD AUDIO playback, press the AUDIO button to see AUDIO Format information.

- LPCM : Linear Pulse Code Modulation.
Not compressed Audio data format.
- PPCM : Packet Pulse Code Modulation.
Lossless compressed Audio data format.



Note

Some DVD-AUDIO discs don't allow audio down-mixing. These discs always output 5.1ch analog audio regardless of audio setup.

Clips Menu for MP3/WMA/JPEG

Discs with MP3/WMA/JPEG contain individual song or pictures that can be organized into folders as shown below. They are similar to how you use your computer to put files into different folders.

1. Open the disc tray.
2. Place the disc on the tray.
- Place the disc with the labeled side up.
3. Close the tray.
- The tray closes and you should get a screen that looks like the one below.

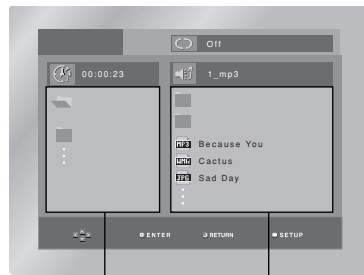

Parent Folder, Current Folder and Peer Folders Folders and Files in Current Folder

- : Name of currently playing file.
- : Current Playback Time.
- : Current Playback Mode : There are 4 modes. They can be selected in order by pressing the REPEAT button.
 - Off : Normal Playback
 - Track : Repeats the current track.
 - Folder : Repeats the current folder.
 - Random : Files in the disc will be played in random order.
- : MP3 file icon.
- : WMA file icon.
- : JPEG file icon.
- : Folder icon.
- : Current Folder icon.

Folder Selection

The folder can only be selected in the Stop mode.

- **To select the Parent Folder**
Press the RETURN button to go to parent folder, or use the UP/DOWN buttons to select “..” and press ENTER to go to the parent folder.
- **To select the Peer Folder**
Use the LEFT/RIGHT buttons to highlight left window. Use the UP/DOWN buttons to select the desired folder, then press ENTER.
- **To select the Sub-Folder**
Use the LEFT/RIGHT buttons to highlight right window. Use the UP/DOWN buttons to select the desired folder, then press ENTER.

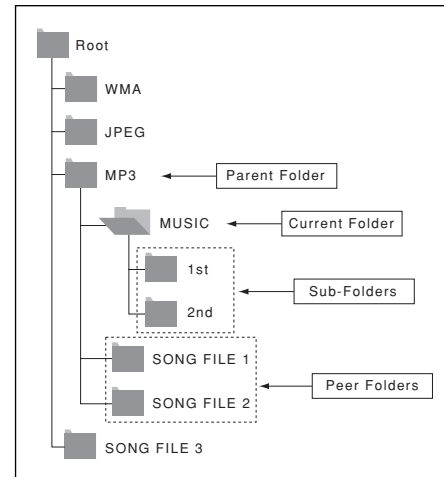

MP3/WMA Playback

1. Open the disc tray.
2. Place the disc on the tray.
- Place the disc with the labeled side up.
3. Close the tray.
- The tray closes and you should get a screen that looks like the one below.

MP3/WMA Play Function

1. Select the desired folder.
2. Use the UP/DOWN or LEFT/RIGHT buttons to select a song file.
3. Press ENTER to begin playback of the song file.



Repeat/Random playback

- Press the REPEAT button to change playback mode. There are 4 modes, such as Off, Track, Folder and Random.
- Off : Normal Playback
 - Track : Repeats the current song file.
 - Folder : Repeats the song files which have the same extension in the current folder.
 - Random : Song files which have the same extension will be played in random order.

* To resume normal play, press the CLEAR button.

CD-R MP3/WMA discs

When you record MP3 or WMA files on CD-R, please refer to the following.

- **Your MP3 or WMA files should be ISO 9660 or JOLIET format.**
ISO 9660 format and Joliet MP3 or WMA files are compatible with Microsoft's DOS and Windows, and with Apple's Mac. This format is the most widely used.
- **When naming your MP3 or WMA files, do not exceed 8 characters, and enter “.mp3, .wma” as the file extension.**
General name format of: Title.mp3. or Title.wma.
When composing your title, make sure that you use 8 characters or less, have no spaces in the name, and avoid the use of special characters including: (,./\,=,+).
- **Use a decompression transfer rate of at least 128 Kbps when recording MP3 files.**
Sound quality with MP3 files basically depends on the rate of compression/decompression you choose. Getting CD audio sound requires an analog/digital sampling rate, that is conversion to MP3 format, of at least 128 Kbps and up to 160 Kbps. However, choosing higher rates, like 192 Kbps or more, only rarely give better sound quality. Conversely, files with decompression rates below 128 Kbps will not be played properly.

- **Use a decompression transfer rate of at least 64Kbps when recording WMA files.**
Sound quality with WMA files basically depends on the rate of compression/decompression you choose. Getting CD audio sound requires an analog/digital sampling rate, that is conversion to WMA format, of at least 64Kbps and up to 192Kbps. Conversely, files with decompression rates below 64Kbps or over 192Kbps will not be played properly.

- **Do not try recording copyright protected MP3 files.**
Certain "secured" files are encrypted and code protected to prevent illegal copying. These files are of the following types: Windows Media™ (registered trade mark of Microsoft Inc) and SDMI™ (registered trade mark of The SDMI Foundation). You cannot copy such files.

- **Important:** The above recommendations cannot be taken as a guarantee that the DVD player will play MP3 recordings, or as an assurance of sound quality. You should note that certain technologies and methods for MP3 file recording on CD-Rs prevent optimal playback of these files on your DVD player (degraded sound quality and in some cases, inability of the player to read the files).

- This unit can play a maximum of 3000 files and 300 folders per disc.

Picture CD Playback

1. Select the desired folder. (See page 26 to select the folder)
2. Use the UP/DOWN buttons to select a Picture file in clips menu and then press the ENTER button. You should get a screen that looks like the one below.

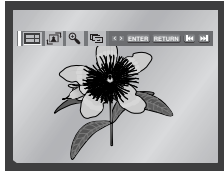

- Use the DISPLAY button on the remote control to select the menu you want to view and then press the ENTER button.
- : Returns to the Album Screen.
- To see the next 6 pictures, press the button.
- To see the previous 6 pictures, press the button.
- : Each time the ENTER button is pressed, the picture rotates 90 degrees clockwise.
- : Each time the ENTER button is pressed, the picture is enlarged up to 4X. (Normal → 2X → 4X → 2X → Normal)
- The unit enters slide show mode.

*Before beginning the Slide Show, the picture interval must be set.

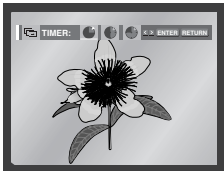

- : When this icon is selected and ENTER is pressed, the pictures change automatically with about a 6 second interval.
- : The pictures change automatically with about a 12 second interval.
- : The pictures change automatically with about a 18 second interval.

*Depending on a file size, the amount of time between each picture may be different from the manual.

*If you don't press any button, the slide show will start automatically in about 10 seconds by default.

Note

- If no buttons on the remote control pressed for 10 seconds, the menu will disappear. Press the DISPLAY button on the remote control to display the menu again.
- Press and hold the STOP button to return to the clips menu.
- When playing a Kodak Picture CD, the unit displays the Photo directly, not the clips menu.

CD-R JPEG Discs

- Only files with the ".jpg" and ".JPG" extensions can be played.
- If the disc is not closed, it will take longer to start playing and not all of the recorded files may be played.
- Only CD-R discs with JPEG files in ISO 9660 or Joliet format can be played.
- The name of the JPEG file may not be longer than 8 characters and should contain no blank spaces or special characters (. / = +).
- Only a consecutively written multisession disc can be played. If there is a blank segment in the multisession disc, the disc can be played only up to the blank segment.
- A maximum of 3000 images can be stored on a single CD.
- Kodak Picture CDs are recommended.
- When playing a Kodak Picture CD, only the JPEG files in the pictures folder can be played.
- Kodak Picture CD : The JPEG files in the pictures folder can be played automatically.
- Konica Picture CD : If you want to see the Picture, select the JPEG files in the clips menu.
- Fuji Picture CD : If you want to see the Picture, select the JPEG files in the clips menu.
- QSS Picture CD : The unit cannot play QSS Picture CD.
- If the number of files in 1 Disc is over 3000, only 3000 JPEG files can be played.
- If the number of folders in 1 Disc is over 300, only JPEG files in 300 folders can be played.

ENG-28

Using the Setup Menu

The Setup menu lets you customize your DVD player by allowing you to select various language preferences, set up a parental level, even adjust the player to the type of television screen you have.

1. With the unit in Stop mode, press the SETUP button on the remote. Select **Setup** using UP/DOWN buttons, then press the RIGHT or ENTER button.

- ❶ **Language Setup** : Setup of the Language.
- ❷ **Audio Setup** : Setup of the Audio Options
- ❸ **Display Setup** : Setup of the Display Options
Use to select which type of screen you want to watch and several display options.
- ❹ **Parental Setup** : Setup of the Parental Level
Allows users to set the level necessary to prevent children from viewing unsuitable movies such as those with violence, adult subject matter, etc.

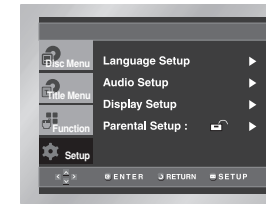

2. Use the UP/DOWN buttons on the remote to access the different features.
3. Press the ENTER button to access the sub features.

To make the setup screen disappear after setting up, press the SETUP button again.

Note

Depending on a disc, some Setup Menu selections may not work.

ENG-29

Setting Up the Language Features

If you set the player menu, disc menu, audio and subtitle language in advance, they will come up automatically every time you watch a movie.

Using the Player Menu Language

1. With the unit in Stop mode, press the SETUP button.
2. Select **Setup** using UP/DOWN buttons, then press the RIGHT or ENTER button.
3. Select **Language Setup** using UP/DOWN buttons, then press the RIGHT or ENTER button.

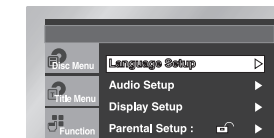

4. Select **Player Menu** using UP/DOWN buttons, then press the RIGHT or ENTER button.

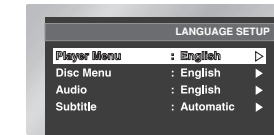

5. Use the UP/DOWN buttons to select the desired language.



6. Press the ENTER button.

- The language is selected and the screen returns to LANGUAGE SETUP menu.
- To make the SETUP menu disappear, press the RETURN or LEFT button.

Setting Up the Language Features

Using the Disc Menu Language

This function changes the text language only on the disc menu screens.

1. With the unit in Stop mode, press the SETUP button.
2. Select **Setup** using UP/DOWN buttons, then press the RIGHT or ENTER button.
3. Select **Language Setup** using UP/DOWN buttons, then press the RIGHT or ENTER button.
4. Select **Disc Menu** using UP/DOWN buttons, then press the RIGHT or ENTER button.
5. Use the UP/DOWN buttons to select the desired language.
 - Select "Others" if the language you want is not listed.



6. Press the ENTER button.
 - The language is selected and the screen returns to LANGUAGE SETUP menu.

Setting Up the Language Features

Using the Audio Language

1. With the unit in Stop mode, press the SETUP button.
2. Select **Setup** using UP/DOWN buttons, then press the RIGHT or ENTER button.
3. Select **Language Setup** using UP/DOWN buttons, then press the RIGHT or ENTER button.
4. Select **Audio** using UP/DOWN buttons, then press the RIGHT or ENTER button.
5. Use the UP/DOWN buttons to select the desired language.
 - Select "Original" if you want the default soundtrack language to be the original language the disc is recorded in.
 - Select "Others" if the language you want is not listed.



6. Press the ENTER button.
 - The language is selected and the screen returns to LANGUAGE SETUP menu.

Setting Up the Language Features

Using the Subtitle Language

1. With the unit in Stop mode, press the SETUP button.
2. Select **Setup** using UP/DOWN buttons, then press the RIGHT or ENTER button.
3. Select **Language Setup** using UP/DOWN buttons, then press the RIGHT or ENTER button.
4. Select **Subtitle** using UP/DOWN buttons, then press the RIGHT or ENTER button.
5. Use the UP/DOWN buttons to select the desired language.
 - Select "Automatic" if you want the subtitle language to be the same as the language selected as the audio preference.
 - Select "Others" if the language you want is not listed. Some discs may not contain the language you select as your initial language; in that case the disc will use its original language setting.



6. Press the ENTER button.
 - The language is selected and the screen returns to LANGUAGE SETUP menu.

Note

- If the selected language is not recorded on the disc, the original pre-recorded language is selected.
- **How to make the SETUP menu disappear or return to menu screen during set up;** Press RETURN or LEFT button.

Setting Up the Audio Options

1. With the unit in Stop mode, press the SETUP button.
2. Select **Setup** using UP/DOWN buttons, then press the RIGHT or ENTER button.
3. Select **Audio Setup** using UP/DOWN buttons, then press the RIGHT or ENTER button.
4. Use the UP/DOWN buttons to select the desired item. Then press the RIGHT or ENTER button.

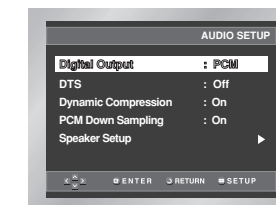
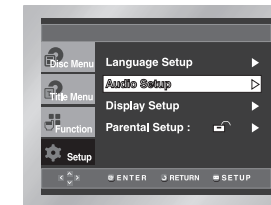

1 Digital Output

1. PCM : Converts to PCM(2CH) 48kHz audio. Select PCM when using the Analog Audio Outputs.
2. Bitstream : Converts to Dolby Digital Bitstream (5.1CH). Select Bitstream when using the Digital Audio Output.

Note

- Even when PCM Down sampling is Off
 - Some discs will only output down sampled audio through the digital outputs.
 - High sampling rate DVD-Audio discs (192KHz or 176.4KHz) always output audio down sampled to 96KHz or 88.2KHz through the digital outputs.
 - When playing LPCM or PPCM DVD protected by copyright. If digital audio source is 48KHz/16bit the Digital output is mute.

Setting Up the Audio Options

2 DTS

- Off : Doesn't output digital signal.
- On : Outputs DTS Bitstream via digital output only.
Select DTS when connecting to a DTS Decoder.

Note There is no analog audio output when you play DTS sound disc.

3 Dynamic Compression

- On : To select dynamic compression.
- Off : To select the standard range.

4 PCM Down Sampling

- On : Select this when the amplifier connected to the player is not 96KHz compatible. In this case, the 96KHz signals will be down converted to 48KHz.
- Off : Select this when the amplifier connected to the player is 96KHz compatible. In this case, all signals will be output without any changes.

5 Speaker Setup

Note

- How to make the SETUP menu disappear or return to menu screen during set up;** Press RETURN or LEFT button.
- Manufactured under license from Dolby Laboratories. "Dolby" and the double-D symbol are trademarks of Dolby Laboratories.
- "DTS" and "DTS Digital Out" are trademarks of Digital Theater Systems, Inc.
- In case of DVD-Audio
Digital output discs will be output as 2 channel Discs that prohibit downmixing also mute the digital output.
- In case of SACD
Digital output is mute.

Surround Sound Speaker Setup

- With the unit in Stop mode, press the SETUP button.
- Select **Setup** using UP/DOWN buttons, then press the RIGHT or ENTER button.
- Select **Audio Setup** using UP/DOWN buttons, then press the RIGHT or ENTER button.

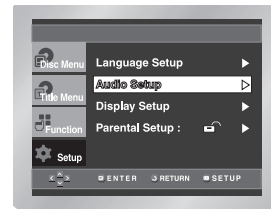

- Use the UP/DOWN buttons to select **Speaker Setup**. Then press the RIGHT or ENTER button.

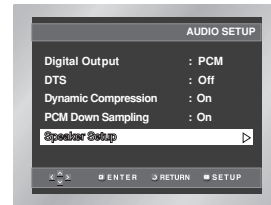

- Use the UP/DOWN or LEFT/RIGHT buttons to select the desired item. Then press the ENTER button.



Surround Sound Speaker Setup

The default settings : FRONT L, R (Small), CENTER (Small), SURROUND (Small) Select the size of the speakers to be connected.

• Front (FL, FR)

- Large:** Normally select this.
- Small:** When the sound distorts or the surround sound effects are difficult to hear, select this. This activates the Dolby Digital bass redirection circuitry and outputs the bass frequencies of the speaker from the subwoofer.

• Center

- None:** If you do not connect a center speaker, select this.
- Large:** Normally select this.
- Small:** When the sound distorts, select this. This activates the Dolby Digital bass redirection circuitry and outputs the bass frequencies of the center speaker from other speakers.

• Surround (SL, SR)

- None:** If you do not connect a surround speaker, select this.
- Large (Rear/Side):** Normally select either of these according to the rear speaker's position.
- Small (Rear/Side):** When the sound distorts or the surround sound effects are difficult to hear, select either of these according to the rear speaker's position. This activates the Dolby Digital bass redirection circuitry and outputs the bass frequencies of the rear speaker from other speakers.

Setting up TEST

The test output signals come clockwise starting from the Front Speaker(L). Adjust Channel Balance to match to the volume of test signals memorized in the system.

FRONT(L) → CENTER → SUBWOOFER (LFE) → FRONT(R) → SURROUND(R) → SURROUND(L)

Note

- How to make the SETUP menu disappear or return to menu screen during set up. Press RETURN or LEFT button.
- The subwoofer test output signal is lower than the other speakers.
- The MPEG Multichannel logo is a trademark registered by PHILIPS Corporation.
- If you Set Front (FL, FR) "Small", LFE is sat "On" automatically.

Setting Up the Display Options

- With the unit in Stop mode, press the SETUP button.
- Select **Setup** using UP/DOWN buttons, then press the RIGHT or ENTER button.
- Select **Display Setup** using UP/DOWN buttons, then press the RIGHT or ENTER button.

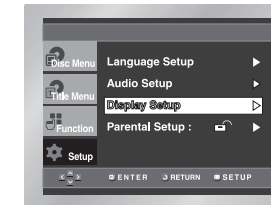

- Use the UP/DOWN buttons to select the desired item. Then press the RIGHT or ENTER button.

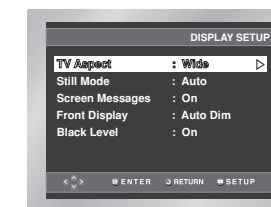

1 TV Aspect

Depending on the type of television you have, you may want to adjust the screen setting (aspect ratio).

- 4:3 Letter Box : Select when you want to see the total 16:9 ratio screen DVD supplies, even though you have a TV with a 4:3 ratio screen. Black bars will appear at the top and bottom of the screen.
- 4:3 Pan Scan : Select this for conventional size TVs when you want to see the central portion of the 16:9 screen. (Extreme left and right side of movie picture will be cut off.)
- 16:9 Wide : You can view the full 16:9 picture on your widescreen TV.

Setting Up the Display Options

2 Still Mode

These options will help prevent picture shake in still mode and display small text clearer.

1. Auto : When selecting Auto, Field/Frame mode will be automatically converted.
2. Field : Select this feature when the screen shakes in the Auto mode.
3. Frame : Select this feature when you want to see small letters more clearly in the Auto mode.

3 Screen Messages

Use to turn on-screen messages On or Off.

4 Front Display

Adjust the brightness of the unit's front panel display.

1. Auto Dim : Makes the Front Panel Display dim automatically when playing a DVD.
2. Bright : Makes the Front Panel Display bright.
3. Dim : Makes the Front Panel Display dim.

5 Black Level

Adjusts the brightness of the screen.(On/Off)

Setting Up the Parental Control

The Parental Control function works in conjunction with DVDs that have been assigned a rating - which helps you control the types of DVDs that your family watches. There are up to 8 rating levels on a disc.

1. With the unit in Stop mode, press the SETUP button.
2. Select **Setup** using UP/DOWN buttons, then press the RIGHT or ENTER button.
3. Select **Parental Setup** using UP/DOWN buttons, then press the RIGHT or ENTER button.

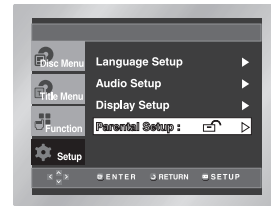

4. Use RIGHT or ENTER to select **Yes** if you want to use a password.
The **Enter Password** screen appears.

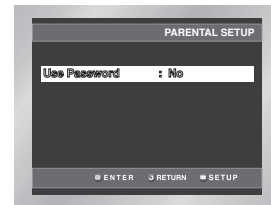

5. Enter your password.
The **Re-enter Password** screen appears to confirm the password.
Enter your password again.
The player is locked (🔒).

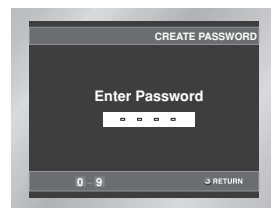

Setting Up the Parental Control

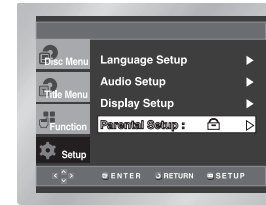
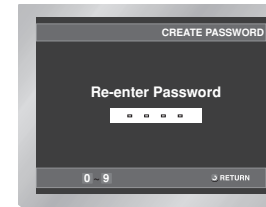

Setting Up the Rating Level

1. With the unit in Stop mode, press the SETUP button.
2. Select **Setup** using UP/DOWN buttons, then press the RIGHT or ENTER button.
The player is locked (🔒).

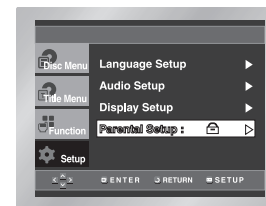

3. Select **Parental Setup** using UP/DOWN buttons, then press the RIGHT or ENTER button.
4. Enter your password.
The Parental Setup screen appears.

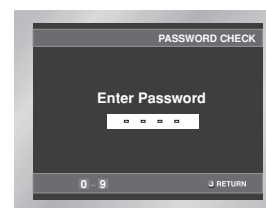

5. Select **Rating Level** using UP/DOWN buttons, and press ENTER or RIGHT button.

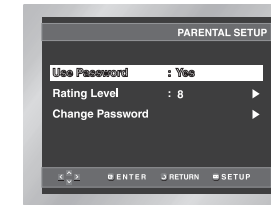

6. Select Rating Level you want using UP/DOWN buttons. For example, if you select up to Level 6, discs that contain Level 7, 8 will not play.
- To cancel the Rating Level, select No using RIGHT or ENTER in Use Password.

e.g) Setting up in LEVEL6.

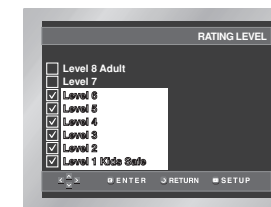

About the Change Password;

- Highlight **Change Password** using UP/DOWN buttons.
- Press ENTER button.
The **Change Password** screen appears.
- Enter your new password. Enter the new password again.

Note

- **How to make the SETUP menu disappear or return to menu screen during set up;**
Press RETURN or LEFT button.
- If you have forgotten your password, see Forgot Password in the Troubleshooting Guide.

Controlling a TV with the Remote

The remote control can be compatible with various brands of TV by setting their control codes. The TOSHIBA code has initially been set to control TOSHIBA TVs.

Setting Control Codes

- Press **TV** to set the remote control operating your TV.
- While holding down **PROG** button enter the two digits of your TV's brand code (listed right) using number buttons.
- Release **PROG**.
- Point the remote control at your TV and use each button listed below to make sure your TV is operated correctly.

TV POWER	To turn the TV on or off.
CH	To select TV channels in the upper or lower direction.
TV VOL.	To adjust the sound level.
I.SELECT	To select an external source such as a VCR.
Number buttons	To select TV channels. When selecting channels 1 to 9, first enter 0 and then the desired number.
100	To substitute for 100 channel key.
DISPLAY	To turn on or off TV's screen display.
ENTER	To use for the TV's ENTER key.

Important Note

- Some TV's may not respond to all the operations above, or may not be operated at all with this remote control. In this case, operate your TV with its own remote control.
- For some brands, several control codes (brand codes) are allocated. Try each of them until the buttons work on your TV.
- If you replace the remote control's batteries, set the brand code again.

Table of Brand Codes

BRAND	CODE
TOSHIBA	PROG + 01
RCA/GE	PROG + 02
SONY	PROG + 03
MITSUBISHI	PROG + 04
JVC	PROG + 05
HITACHI	PROG + 06
PANASONIC A	PROG + 07
SHARP NEW	PROG + 08
SANYO	PROG + 09
MAGNAVOX	PROG + 10
GOLDSTAR NEW	PROG + 11
SAMSUNG	PROG + 12
SHARP OLD	PROG + 13
ZENITH	PROG + 14
PANASONIC B	PROG + 15
PIONEER	PROG + 16

Troubleshooting

Before requesting service (troubleshooting), please check the following.

Problem	Action	Page
No operations can be performed with remote.	<ul style="list-style-type: none"> Check the batteries in the remote. They may need replacing. Operate the remote control within 30 angle on either side of the remote sensor, up to a distance of no more than 23 feet. Remove batteries and hold down one or more buttons for several minutes to drain the microprocessor inside the remote to reset it. Reinstall batteries and try to operate the remote again. 	P5
Disc does not play.	<ul style="list-style-type: none"> Ensure that the disc is installed with the label side facing up. Check the region number of the DVD. 	P7
5.1 channel sound is not being reproduced.	<ul style="list-style-type: none"> 5.1 channel sound is reproduced only when the following conditions are met. : <ol style="list-style-type: none"> The DVD player is connected with the proper amplifier The disc is recorded with 5.1 channel sound. Check whether the disc being played has the "Dolby 5.1 ch" mark on the outside. Check if your audio system is connected and working properly. In a SETUP Menu, is the Audio Output set to Bitstream? 	P12 P31-32
The  icon appears on screen.	<ul style="list-style-type: none"> The features or action cannot be completed at this time because: <ol style="list-style-type: none"> The DVD's software restricts it. The DVD's software doesn't support the feature (e.g., angles). The feature is not available at the moment. You've requested a title or chapter number or search time that is out of range. 	P14
Disc Menu doesn't appear.	<ul style="list-style-type: none"> Check if the disc has a Menu. 	
Play mode differs from the Setup Menu selection.	<ul style="list-style-type: none"> Some of the functions selected in the Setup Menu may not work properly if the disc is not encoded with the corresponding function. 	P29-35
The screen ratio cannot be changed.	<ul style="list-style-type: none"> The Screen Ratio is fixed on your DVD discs. 	P33
No audio.	<ul style="list-style-type: none"> Make sure you have selected the correct Digital Output in the Audio Options Menu. 	P31-32
The screen is blocked	<ul style="list-style-type: none"> Press power on from a cold start with no disc in the unit. Press the STOP (■) and PLAY (▶/) buttons simultaneously on the front panel for three seconds. The SELECT MENU LANGUAGE display will appear. Select the number button of the desired language. 	P14
Forgot password	<ul style="list-style-type: none"> Press power on from a cold start with no disc in the unit. Press the STOP (■) and PLAY (▶/) buttons simultaneously on the front panel for three seconds. The SELECT MENU LANGUAGE display will appear. Select the number button of the desired language. Press the SETUP select Setup, then press RIGHT or ENTER. Press Up or Down to select Parental Setup. The Parental Setup is now unlocked as indicated on the display. You can change your password. 	P34-35
If you experience other problems.	<ul style="list-style-type: none"> Go to the contents and find the section of the instruction book that contains the explanations regarding the current problem, and follow the procedure once again. If the problem still cannot be solved, please contact your nearest authorized service center. 	

Specifications

General	Power Requirements	AC 120 V, 60 Hz
	Power Consumption	13W
	Weight	9.5 lbs
	Dimensions	(W) 16.9 in x (D) 15.7 in x H 2.7 in
	Operating Temperature Range	+41°F to +95°F
	Operating Humidity Range	10 % to 75 %
Disc	DVD (DIGITAL VERSATILE DISC)	Reading Speed : 11.45 ~ 15.09 ft/sec. Approx. Play Time (Single Sided, Single Layer Disc) : 135 min.
	CD : 5" (COMPACT DISC)	Reading Speed : 15.75 ~ 18.37 ft/sec. Maximum Play Time : 74 min.
	CD : 3 1/2" (COMPACT DISC)	Reading Speed : 15.75 ~ 18.37 ft/sec. Maximum Play Time : 20 min.
Video Output	Composite Video	1 channel : 1.0 Vp-p (75 Ω load) Y : 1.0 Vp-p (75 Ω load) Pr : 0.70 Vp-p (75 Ω load) Pb : 0.70 Vp-p (75 Ω load)
	Component Video	Luminance Signal : 1.0 Vp-p (75 Ω load) Chrominance Signal : 0.286 Vp-p (75 Ω load)
	S-VIDEO	
Audio Output	2 Channel	L(1/L), R(2/R)
	5.1 Channel	F/L, F/R, R/L, R/R, C/T, S/W
	*Frequency Response	48 kHz Sampling : 4 Hz to 22 kHz 96 kHz Sampling : 4 Hz to 44 kHz
	*S/N Ratio	110 dB
	*Dynamic Range	100 dB
	*Total Harmonic Distortion	0.004 %

*: Nominal specification

- Toshiba Electronics Co., Ltd reserves the right to change the specifications without notice.
- Weight and dimensions are approximate.

Limited Warranty DVD Players

Toshiba America Consumer Products, L.L.C. ("TACP") makes the following limited warranties to original consumers in the United States. THESE LIMITED WARRANTIES EXTEND TO THE ORIGINAL CONSUMER PURCHASER OR ANY PERSON RECEIVING THIS DVD PLAYER AS A GIFT FROM THE ORIGINAL CONSUMER PURCHASER AND TO NO OTHER PURCHASER OR TRANSFEREE.

PRODUCTS PURCHASED IN THE U.S.A. AND USED IN CANADA ARE NOT COVERED BY THESE WARRANTIES.

PRODUCTS PURCHASED IN CANADA AND USED IN THE U.S.A. ARE NOT COVERED BY THESE WARRANTIES.

Limited Ninety (90) Day Warranty on Labor*

TACP warrant this DVD Player and its parts against defects in materials or workmanship for a period of ninety (90) days after the date of original retail purchase. DURING THIS PERIOD, TACP WILL, AT TACP'S OPTION, REPAIR OR REPLACE A DEFECTIVE PART WITH A NEW OR REFURBISHED PART WITHOUT CHARGE TO YOU FOR PARTS OR LABOR. YOU MUST DELIVER THE ENTIRE DVD PLAYER TO AN AUTHORIZED TACP SERVICE STATION. YOU MUST PAY FOR ALL TRANSPORTATION AND INSURANCE CHARGES FOR THE DVD PLAYER TO AND FROM THE SERVICE STATION.

Limited One (1) Year Warranty on Parts*

TACP further warrant the parts in this DVD Player against defects in materials or workmanship for a period of one (1) year after the date of original retail purchase. DURING THIS PERIOD, TACP WILL, AT TACP'S OPTION, REPAIR OR REPLACE A DEFECTIVE PART WITH A NEW OR REFURBISHED PART WITHOUT CHARGE TO YOU FOR THE PART, PROVIDED THAT IF A DEFECTIVE PART IS REPAIRED OR REPLACED **AFTER NINETY (90) DAYS FROM THE DATE OF ORIGINAL RETAIL PURCHASE, THE CONSUMER PAYS ALL LABOR CHARGES INVOLVED IN THE REPAIR OR REPLACEMENT.** YOU MUST DELIVER THE ENTIRE DVD PLAYER TO AN AUTHORIZED TACP SERVICE STATION. YOU MUST PAY FOR ALL TRANSPORTATION AND INSURANCE CHARGES FOR THE DVD PLAYER TO AND FROM THE SERVICE STATION.

*Rental Units

The warranty for rental units begins with the first rental or thirty (30) days from the date of shipment to the rental firm, whichever comes first.

*Commercial Units

DVD PLAYER(s) sold and used for commercial purposes have a limited ninety (90) day warranty.

Owner's Manual and Demographic Card

You should read this owner's manual thoroughly before operating this DVD PLAYER. You should complete and mail the enclosed Demographic card within ten days after you, or the person who has given you this product as a gift, purchased this DVD PLAYER. This is one way to enable TACP to provide you with better customer service and improved products. Failure to return the Demographic card will not affect your rights under this warranty.

Your Responsibility

THE ABOVE WARRANTIES ARE SUBJECT TO THE FOLLOWING CONDITIONS:

- (1) You must provide your bill of sale or other proof of purchase.
- (2) All in-warranty servicing of this DVD PLAYER must be made by a specified Authorized TACP Service Station.
- (3) The warranties from TACP are effective only if the DVD PLAYER is purchased and operated in the U.S.A. or Puerto Rico.
- (4) Labor service charges for set installation, set up, adjustment of customer controls and installation or repair of hook up related items and/or antenna systems are not covered by these warranties. Reception problems caused by inadequate antenna systems are your responsibility.
- (5) Warranties extend only to defects in materials or workmanship as limited above and do not extend to any DVD PLAYER or parts which have been lost or discarded by you or to damage to DVD PLAYER or parts caused by misuse, accident, Acts of God, such as lightning or fluctuations in electric power, improper installation, improper maintenance or use in violation of instructions furnished by TACP; or to units which have been modified or had the serial number removed, altered, defaced or rendered illegible.

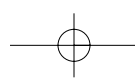

How to Obtain Warranty Services

If, after following all of the operating instructions in this manual and checking the section "Troubleshooting", you find that service is needed:

- (1) For instructions on how to obtain warranty service for your DVD Player, contact TACP Call Center's toll free number at 1-866-583-7353.
- (2) You must include a copy or original bill of sale or other proof of purchase along with the entire DVD PLAYER to the Authorized TACP Service Station specified by the Call Center. You must pay for all transportation and insurance charges for the DVD PLAYER to the Service Station.

For additional information, visit TACP's web site:
www.tacp.toshiba.com.

Time for Taking Action

ALL WARRANTIES IMPLIED BY THE LAW OF ANY STATE OF THE U.S.A., INCLUDING THE IMPLIED WARRANTIES OF MERCHANTABILITY AND FITNESS FOR A PARTICULAR PURPOSE, ARE EXPRESSLY LIMITED TO THE DURATION OF THE LIMITED WARRANTIES SET FORTH ABOVE. WITH THE EXCEPTION OF ANY WARRANTIES IMPLIED BY THE LAW OF ANY STATE OF THE U.S.A. AS HEREBY LIMITED, THE FOREGOING WARRANTY IS EXCLUSIVE AND IN LIEU OF ALL OTHER WARRANTIES, GUARANTEES, AGREEMENTS AND SIMILAR OBLIGATIONS OF TACP WITH RESPECT TO THE REPAIR OR REPLACEMENT OF ANY PARTS. IN NO EVENT SHALL TACP OR BE LIABLE FOR CONSEQUENTIAL OR INCIDENTAL DAMAGES.

No person, agent, distributor, dealer or company is authorized to change, modify or extend the terms of these warranties in any manner whatsoever. The time within which action must be commenced to enforce any obligation of TACP arising under this warranty or under any law of the United States or of any state thereof is hereby limited to 90 days from the date you discovered or should have discovered, the defect. This limitation does not apply to implied warranties arising under the law of any state of the U.S.A.

HOW STATE LAW RELATES TO WARRANTY

THIS WARRANTY GIVES YOU SPECIFIC LEGAL RIGHTS, AND YOU MAY ALSO HAVE OTHER RIGHTS WHICH MAY VARY FROM STATE TO STATE IN THE U.S.A. SOME STATES OF THE U.S.A. DO NOT ALLOW LIMITATIONS ON HOW LONG AN IMPLIED WARRANTY LASTS, WHEN AN ACTION MAY BE BROUGHT, OR THE EXCLUSION OR LIMITATION OF INCIDENTAL OR CONSEQUENTIAL DAMAGES, SO THE ABOVE LIMITATIONS OR EXCLUSIONS MAY NOT APPLY TO YOU UNDER SUCH CIRCUMSTANCES.

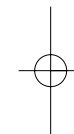
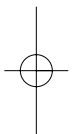

Free Manuals Download Website

<http://myh66.com>

<http://usermanuals.us>

<http://www.somanuals.com>

<http://www.4manuals.cc>

<http://www.manual-lib.com>

<http://www.404manual.com>

<http://www.luxmanual.com>

<http://aubethermostatmanual.com>

Golf course search by state

<http://golfingnear.com>

Email search by domain

<http://emailbydomain.com>

Auto manuals search

<http://auto.somanuals.com>

TV manuals search

<http://tv.somanuals.com>