

TOSHIBA HDD/DVD VIDEO RECORDER RD-XS54SU

**TOSHIBA**



HDD/DVD VIDEO RECORDER  
**RD-XS54SU**

OWNER'S MANUAL



**OPERATIONS  
GUIDE**

Read "INSTALLATION GUIDE" first.



Introduction  
Recording  
Playback  
Editing  
Library  
Network Nav!  
Function setup  
Others

**TOSHIBA**

# Table of contents

## Introduction

■ <b>Caution for safety</b> .....	4
■ <b>About this product</b> .....	5
■ <b>Choosing a disc</b> .....	6
■ <b>Index to parts and controls</b> .....	12
Front panel .....	12
Rear panel .....	14
Remote control .....	16
Display .....	18
■ <b>Before operating this recorder</b> .....	20
■ <b>Using TV Guide On Screen™</b> .....	23
Services and options .....	24
■ <b>Key operation - EASY NAVI &amp; QUICK MENU</b> ..	29

## Recording

■ <b>Before recording</b> .....	32
Initializing a DVD-RAM/RW disc (Logical format) ....	34
DVD-RAM physical format .....	35
Entering characters .....	36
Selecting a disc according to purposes of use (DVD-RAM/R/RW) .....	38
Setting for recording on a DVD-R/RW disc in Video mode .....	39
■ <b>Setting a timer recording using TV Guide On Screen®</b> .....	40
With recording frequency selection only .....	40
Changing the recording options .....	41
Set recording by specifying details manually .....	43
■ <b>Recording a TV program</b> .....	45
■ <b>Recording an external source</b> .....	49
■ <b>DV recording (Recording from a digital video camera)</b> .....	52
■ <b>Deleting recorded contents</b> .....	55
To delete a title (chapter) .....	55
Deleting multiple specified parts .....	55
■ <b>Others</b> .....	56
To protect recorded content .....	56
Relay recording .....	56
Technical Information .....	56

## Playback

■ <b>Playing recorded contents (CONTENT MENU)</b> .....	60
Playing at various speeds .....	62
■ <b>Playing a DVD video disc</b> .....	66
■ <b>Other playback functions</b> .....	68
Pausing a TV broadcast to resume later (Pause TV) .....	68
Playing a TV program currently being recorded (Chase Play) .....	69
Zooming a picture .....	70
Watching a TV broadcast in the sub window (P in P playback) .....	70
Locating by entering the number of a desired section .....	71
Locating a specific point by entering its elapsed time (Time Search) .....	71
Selecting the sound .....	72
Viewing JPEG files .....	74
Playing MP3/WMA files .....	76
■ <b>Checking the current status and settings</b> .....	78
■ <b>Functions in Quick Menu</b> .....	80

## Editing

■ <b>Creating your own title</b> .....	84
Editing procedure .....	84
Basic flow .....	85
1: Changing a name of a recorded title .....	86
2: Dividing a recorded title into several chapters .....	87
3: Collecting necessary scenes .....	92
4: Dubbing to save .....	97
■ <b>Creating a DVD-Video using DVD-R/RW</b> .....	112
■ <b>DVD-Video finalizing process</b> .....	122
■ <b>Other editing functions</b> .....	126
Changing the picture on CONTENT MENU .....	126
Combining two titles (Original) into one .....	128

## Library

- **Using Library data** ..... 132
  - Basic operation of the Library system ..... 132
- **Searching for a desired title** ..... 133
  - Changing the listing order ..... 133
  - Searching ..... 133
  - Jumping ..... 134
- **Viewing Library data** ..... 135
  - Viewing title information ..... 135
  - Viewing disc information ..... 135
  - Maintenance of Library data ..... 136
- **Checking remaining space** ..... 139
  - Viewing a number and space of a disc ..... 139
  - Viewing remaining space ..... 139

## Network Navi

- **What is Network Navi?** ..... 142
  - Main features of Network Navi ..... 142
  - Flow of Network Navi setting ..... 142
  - Operating environment ..... 143
  - Terminology and trademarks ..... 143
  - Restrictions and disclaimer ..... 143
- **Preparation for Network Navi** ..... 145
  - 1: Connection to a PC ..... 145
  - 2: Recorder's setup-Network setting ..... 147
  - 3: Setting up the PC ..... 151
  - 4: Starting Network Navi ..... 152
  - 5: Network Navi settings ..... 153
- **Network Navi features** ..... 154
- **Displaying thumbnails (Title List)** ..... 155
- **Operating with the remote control screen** .... 157
  - Net Keyboard ..... 158
  - Operation using the Virtual Remote Control ..... 159
- **Using Library information (Library)** ..... 160
- **Setting for custom menu addition (Custom Menu Editor)** ..... 161
- **Net Dubbing** ..... 163
  - Dubbing to a device on the same network ..... 163
- **Net Monitor** ..... 165

- **Setting a timer recording using email** ..... 168
  - Setting a timer recording by directly specifying the date, time, and channel ..... 168
  - Useful features of timer recording setting using email ..... 169
- **If you are having a difficulty with Network Navi features** ..... 170

## Function setup

- **Customizing the function settings** ..... 172
  - Initial settings ..... 175
  - DVD player settings ..... 176
  - Picture/Audio settings ..... 179
  - Display settings ..... 181
  - Operational settings ..... 182
  - DVD recorder operation ..... 183
  - Management settings ..... 186

## Others

- **Before calling service personnel** ..... 190
- **Output sound conversion table** ..... 192
- **Error codes on the display window** ..... 193
- **Recording duration** ..... 194
- **Language code list** ..... 195
- **Specification** ..... 196
- **Limited United States Warranty** ..... 197

# Caution for safety

**Read “SAFETY PRECAUTIONS”, “IMPORTANT SAFETY INSTRUCTIONS”, “Precautions” and all other sections of the “INSTALLATION GUIDE” that came with this product prior to reading this “OPERATIONS GUIDE”.**

# About this product

## Some differences

Because of its recording capability and hard disc drive (HDD), this DVD recorder operates more like a computer and differently than a standard DVD player. In addition to containing a microprocessor, it contains a HDD, an operating system, random access memory (RAM), and a DVD-RAM/RW/R drive. The operating system includes software stored on the HDD that is transferred to the RAM when the machine is turned on and at other times during operation. This transfer can take time. Therefore, when you turn the DVD recorder on, it may take a little while before it is ready to use. Likewise, other functions may not be performed as quickly as they would on other AV equipment. Additionally, because programs stored on the DVD-RAM/RW/R drive cannot be accessed as quickly as those stored on the HDD, accessing those programs (or deleting a program from a DVD-RAM disc) may take more time. Please take these factors into consideration as you use the DVD recorder.

## About the hard disc drive (HDD)

Like any HDD, the HDD in the DVD recorder is a fragile device that is susceptible to partial or complete failure if it is jarred or as a result of use over time. It will not last forever. Therefore, do not use the HDD for longer term storage of programs you wish to retain. [If portions of the HDD become damaged, programs recorded on those portions may exhibit pixelization or block noise when played back. Repeated playback of the program may cause the problem to get worse and, eventually, the program may become unplayable. Accordingly, if you notice such noise in a program that you want to save, you should transfer to a recordable DVD disc as soon as possible.] Recordable DVD discs are also susceptible to damage if not handled and stored carefully and some or all of the programs on them may become unplayable. You can reduce these risks by using high quality DVD recordable discs and checking their playability from time to time. If it becomes necessary to service your DVD recorder, it may be necessary to delete some or all of the programs on the HDD.

## Playback Restrictions

This owner's manual explains the basic instructions for this recorder. Some DVD video discs are produced in a manner that allows specific or limited operation during playback. As such, the recorder may not respond to all operating commands. This is not a defect in the recorder. Please refer to the notes on compatible discs later in this Introduction and to the discussion of DVD playback and features later in this manual.

“Ⓢ” may appear on the TV screen during operation.  
 “Ⓢ” means that the operation is not permitted by the recorder or the disc.

## Recording Restrictions and Copyright

Copy-protected contents of DVD-Video discs, VIDEO CDs or audio CDs on the market cannot be copied on this recorder. Contents without copy protection should be copied or edited only in accordance with applicable copyright laws, which may restrict copying or editing. Contents that permit single copying (copy once contents) can be recorded onto DVD-RAM discs, with some dubbing and editing restrictions. DVD-R/RW discs cannot record these contents.

The unauthorized recording, use, distribution, or revision of copyrighted materials including, without limitation, television programs, videotapes, and DVDs, is prohibited under the Copyright Laws of the United States and other countries, and may subject you to civil and criminal liability.

## Compatibility

In isolated cases, a disc bearing the DVD or CD logo may not fully and properly play back all features or as intended by the creator of the disc. This can be due, among other reasons, to problems and errors that can occur during the creation or recording of DVD and other software and the manufacture of software discs (including blank discs). Moreover, because of variations in the quality of discs, this recorder may not be able to record on all discs that bear a DVD-RAM, DVD-RW or DVD-R logo, but you should not encounter difficulty if you use only high quality recordable DVD discs. Additionally, discs recorded in this device may not operate properly in other DVD players, recorders and/or personal computer drives. If you happen to encounter difficulties playing or recording a DVD disc or playing a CD disc, please feel free to call our Customer Service Hotline at 1-800-319-6684.



# Choosing a disc

When you want to play DVD or CD software or copy programs from the HDD to a recordable DVD, load an appropriate disc into the recorder. There are many types and formats of discs. Please use the following information to select an appropriate disc.

## Notes

- Handle the disc according to the disc instruction manual.
- Toshiba cannot guarantee that all discs bearing the DVD or CD logos will operate as expected. Additionally, Toshiba cannot guarantee that discs recorded in this device will operate properly in other DVD players, recorders and/or personal computer drives.

## For recording / playback

Disc	Mark	Specification	Remarks
DVD-RAM		<ul style="list-style-type: none"> <li>• Single sided 4.7GB (12cm (4<sup>3</sup>/<sub>4</sub> in.))</li> <li>• Double sided 9.4GB (12cm (4<sup>3</sup>/<sub>4</sub> in.))</li> </ul>	<p>Read carefully the section “On DVD-RAM discs” (➡ page 8).</p> <p>Select a DVD-RAM disc that shows a statement on its package such as “this disc can be used with video recorders and drives compatible with 4.7GB DVD-RAM discs” or “this disc can copy images that permit single copying.”</p>
DVD-R		<ul style="list-style-type: none"> <li>• 4.7GB For General Ver.2.0 (12cm (4<sup>3</sup>/<sub>4</sub> in.))</li> </ul>	<p>Read carefully the section “On DVD-R discs” (➡ page 9).</p> <p>Depending on the disc status or the recording equipment, playback of the disc may not be possible on this recorder.</p>
DVD-RW		<ul style="list-style-type: none"> <li>• Ver. 1.1 or later (12cm (4<sup>3</sup>/<sub>4</sub> in.))</li> </ul>	<p>Read carefully the section “On DVD-RW discs” (➡ page 9).</p> <p>Depending on the disc status or the recording equipment, playback of the disc may not be possible on this recorder.</p>

## Using different disc types for different purposes

### DVD-RAM discs for your personal library

DVD-RAM discs comply with the global standard DVD-VR (Video Recording) format, and are optimized for recording of TV programs. You can rewrite repeatedly without deterioration of an image quality, erase unnecessary parts, divide a chapter, or specify playback area by frame. Its cartridge is suitable for a longer-term storage and family use, and its large capacity of 9.4 GB allows more recording space.

### DVD-R/RW discs when creating your own original discs for distribution

DVD-R discs are designed to comply with the global standard DVD-Video format, and can be recorded only once. DVD-R discs are convenient when you edit your original content (recorded personal events such as a wedding party) with this recorder, transfer them to the recorder and make copies to send to your friends or relatives. The discs can be played on other compatible DVD players. DVD-RW discs, which are rewritable, can be used as well.









\* DVD-R and DVD-RW may not be the best suited format for recording TV programs. Because of the way the discs are formatted, it may not be possible to edit or divide the program as you may prefer, to record secondary languages, or programs that are copy protected in a way that allows only one copy. (NOTE: “Copy once” protected programs generally can be recorded to DVD-RAM discs.)



\* This recorder records on a DVD-R/RW disc in DVD-Video format only.

\* On DVD-R/RW discs, direct recording, copying or the method “Creating a DVD-Video using DVD-R/RW” (➡ page 112) are available.

We cannot guarantee that DVD-RAM/R/RW discs recorded on this recorder will be playable on all DVD recorders/players. Similarly, there is no guarantee that all DVD-RAM/R/RW discs recorded on other recorders will be playable on this recorder.

## For playback only

Disc	Mark	Specification	Remarks
DVD video disc		<ul style="list-style-type: none"> <li>12cm (4<sup>3</sup>/<sub>4</sub> in.) / 8cm (3<sup>1</sup>/<sub>4</sub> in.) Region number</li> <li> or </li> <li>Color system: NTSC</li> </ul>	The region number of this DVD recorder is 1. If region numbers, corresponding to a specific playable area, are printed on your DVD video disc and you do not find  or  , or the disc is encoded to permit playback only in regions other than Region 1, disc playback will not be allowed by the recorder.
VIDEO CD		<ul style="list-style-type: none"> <li>12cm (4<sup>3</sup>/<sub>4</sub> in.) / 8cm (3<sup>1</sup>/<sub>4</sub> in.)</li> <li>Color system: NTSC</li> <li>Version 1.1 and 2.0</li> </ul>	
Audio CD		<ul style="list-style-type: none"> <li>12cm (4<sup>3</sup>/<sub>4</sub> in.) / 8cm (3<sup>1</sup>/<sub>4</sub> in.)</li> </ul>	
CD-R		<ul style="list-style-type: none"> <li>12cm (4<sup>3</sup>/<sub>4</sub> in.)</li> <li>CD-DA (audio CD) format</li> </ul>	Depending on the disc status, playback may not be possible.
CD-RW			

- You cannot play discs other than those listed above.
- You cannot play non-standardized discs even if they may be labeled as above.
- You cannot play discs with specialized encoding (such as SACD discs) or the DVD audio portions of DVD Audio discs.
- This recorder uses the NTSC color system, and cannot play DVD video discs recorded in any other color system (PAL, SECAM, etc.), even if they have region marks  or .
- Toshiba cannot guarantee that all discs bearing the DVD or CD logos will operate as expected. Please see the discussion of compatibility on page 5.

- Toshiba is not liable for any damage or loss caused directly or indirectly by the malfunction of this recorder, including, without limitation, any one of the following:
  - Failure to record contents intended to be recorded by the consumer.
  - Failure to edit contents as intended by the consumer.
  - When a DVD-RAM/R/RW disc created on this recorder is used (e.g., insertion, playback, recording or editing) in another DVD player, recorder or personal computer drive.
  - When a DVD-RAM/R/RW disc that is used in the manner described in the immediately preceding bullet point is used again in this recorder.
  - When a DVD-RAM/R/RW disc that was recorded in another DVD recorder, or in a personal computer drive is used in this recorder.
- Some functions such as Library may not work with personal computer discs.
- Discs recorded in this recorder may not operate as expected on other DVD players, recorders or personal computer drives.

## On DVD-RAM discs

### ■ Use only DVD-RAM discs that comply with DVD-RAM standard Version 2.0, 2.1 or 2.2.

The recorder cannot record on a disc formatted in any other standard. When using such a disc, initialize it by using the disc-format function of this recorder.

- The recorder may not record, dub, or edit some DVD-RAM discs, because they are edited/recorded with another manufacturer's equipment or PC, contain a large number of titles, or have little remaining capacity. Also, a DVD-RAM disc may not be edited or recorded if its title contains still pictures.
- DVD-RAM discs formatted in UDF2.0 on a PC are not compatible with this recorder. Before using these discs, initialize them on this recorder.
- This recorder complies with current copyright protection technology and can copy a disc only when the disc permits copying once. When there is no indication on the disc, copying will not be allowed. Such an indication on a disc is required also for the Library Management database.

### ■ DVD-RAM discs with cartridges are recommended for recording.

- Two types of DVD-RAM discs are available: ones with cartridges and ones without cartridges. You can use either of them with this recorder, but the former ones are recommended.
- In order to record highly detailed data, make sure the disc is clean. DVD-RAM discs with cartridges are easier to handle in this regard.
- Do not open the cartridge shutter. The disc may not play, or may not be recorded or edited once it becomes dirty.
- There are two types of DVD-RAM cartridges; removable (TYPE 2/4) and not removable (TYPE 1). It is recommended you do not remove the disc even when you can.  
Refer to the instruction manual that comes with the disc if it is absolutely necessary to remove the disc.
- Some commercially available cartridge discs cannot be recorded or edited once the inside discs are removed.

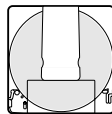

### ● To protect recorded contents

Slide the write-protect tab to "PROTECT" with something small enough. The disc can play, but cannot be edited or erased. Refer to the instructions that come with the disc.

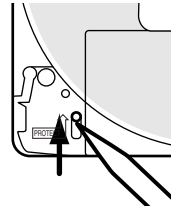

### ■ When using a disc without a cartridge (commercially available discs)

- Discs without cartridges can easily attract fingerprints and dust, which is the reason they are not recommended. If you cannot avoid using them, handle with proper care.
- When you write in a title column on a disc, use a pen with a soft tip. Do not use a pen with a hard tip, such as a ballpoint pen.

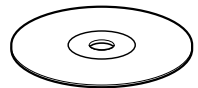

### Recommended discs

The following discs have been tested with this recorder:  
 9.4 GB double-sided cartridge: Panasonic 2X, 3X, 5X  
 4.7 GB single-sided cartridge: Panasonic 2X, 3X, 5X



## On DVD-R discs

### ■ Standards

- DVD-R for General Ver.2.0 discs can be used for recording and playback.
- Discs compatible with the following recording speeds can also be used:  
Ver. 2.0/2X  
Ver. 2.0/4X  
Ver. 2.0/8X  
Ver. 2.0/16X
- Select discs labeled "for video," "for recording," "120 min." etc.

### ■ Recording conditions

- Images for which copying is prohibited or restricted (copy once or copy prohibited) cannot be recorded. Even if the disc is labeled as CPRM compatible, this recorder can only be used to record copy-free material.
- DVD-VR mode recording is not possible.

### ■ Recommended discs

That's (Taiyo-Yuden) 4X, 8X, 16X

## On DVD-RW discs

### ■ Standards

- Discs labeled DVD-RW Ver.1.1 or 1.2 can be used.
- Discs compatible with the following recording speeds can also be used:  
Ver. 1.1/2X  
Ver. 1.2/4X  
Ver. 1.2/6X
- Select discs labeled "for video," "for recording," "120 min." etc.

### ■ Recording conditions

- Images for which copying is prohibited or restricted (copy once or copy prohibited) cannot be recorded. Even if the disc is labeled as CPRM compatible, this recorder can only be used to record copy-free material.
- DVD-VR mode recording is not possible.





### ■ Recommended discs\*

JVC 2X, 4X, 6X

\*Operation has been confirmed with recommended discs and tested disc, but some other discs may not be usable.

## Marks on DVD video discs

The following are examples of marks and the meanings.

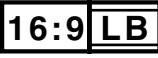
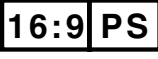
Mark	Meanings
	Number of audio streams recorded in the disc. (2 streams such as English and Japanese in this example.)
	Number of subtitle languages recorded in the disc. (2 subtitle languages are recorded in this example.)
	Number of camera angles recorded in the disc. (3 camera angles are recorded in this example.)
	Pictures are recorded in the standard picture shape (4:3 aspect ratio).
	
	Pictures are recorded in the 16:9 wide picture shape. TVs with 4:3 aspect ratio will display them in the letter box style.
	Pictures are recorded in the 16:9 wide picture shape. TVs with 4:3 aspect ratio will display them in the pan scan style (one or both sides of pictures are cut).
	Actual picture shape may vary depending on the aspect ratio or mode selection of the TV.

## Choosing a disc (Continued)

## Structure of disc contents

Normally, DVD video discs are divided into titles, and the titles are subdivided into chapters.

VIDEO CDs/audio CDs are divided into tracks.

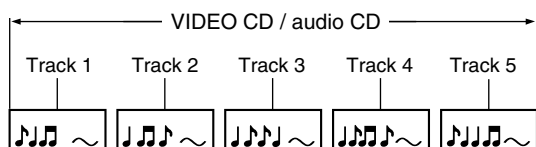
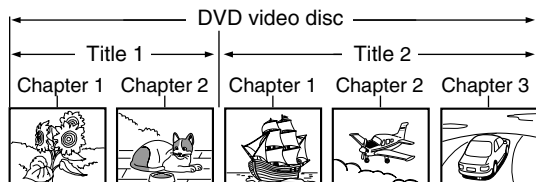

**Title:** Divided contents of a DVD video disc. Roughly corresponds to a story title in short stories.

**Chapter:** Divided contents of a title. This corresponds to a chapter in a story.

**Track:** Divided contents of a VIDEO CD or an audio CD.

Each title, chapter, or track is assigned a number, which is called "title number", "chapter number", or "track number" respectively.

Some discs may not have these numbers.

When you record on the HDD or a DVD-RAM disc, one recording will always equal one title. You can divide a title into several chapters by marking borders in it to facilitate scene search.

## On handling discs

- Do not touch the playback side of the disc.

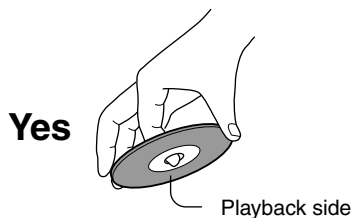

- Do not stick paper or tape to discs.



## On cleaning discs

- Fingerprints and dust on the disc cause picture and sound deterioration. Wipe the disc from the center outwards with a soft cloth. Always keep the disc clean.



- Do not use any type of solvent such as thinner, benzene, commercially available cleaners or antistatic spray for vinyl LPs. It may damage the disc.

## On storing discs

- Do not store discs in a place subject to direct sunlight or near heat sources.
- Do not store discs in places subject to moisture and dust such as a bathroom or near a humidifier.
- Store discs vertically in a case. Stacking or placing objects on discs outside of their case may cause warping.

## Discs and purposes

The table shows main functions which are available on this recorder per disc category. This will help you choose discs.

	DVD-RAM disc	DVD-RW disc	DVD-R disc
Characteristics on this recorder	Suitable for repeat use of the disc, and data storage for video library. Copy once contents can be recorded using a compatible disc.	Suitable for saving data in DVD-Video format to play on compatible devices.  You can erase recorded contents to use the disc repeatedly.	Suitable for saving data in DVD-Video format to play on compatible devices.  Once you execute DVD-Video finalizing process on a recorded disc so that it can be played on other players, you cannot make additions, corrections and deletions of contents on the disc.
For the first use	No preparatory steps required, however initializing is recommended.	Initialize the disc.	No preparatory steps required.
Recording a TV program	Yes	Yes	Yes
Erasing recorded contents	Yes	Yes If the disc has been executed DVD-Video finalizing process, first cancel the process then delete contents.	Yes Deleting contents cannot restore the disc space. <u>After you execute DVD-Video finalizing process on a recorded disc, you cannot delete contents of the disc.</u>
Recording additional content on a recorded disc	Yes	Yes If the disc has been executed DVD-Video finalizing process, first cancel the process then delete contents.	Yes <u>After you execute DVD-Video finalizing process on a recorded disc, you cannot add contents to the disc.</u>
Indexing recorded contents Naming a title Creating a thumbnail	Yes Yes	Yes Yes <u>After you execute DVD-Video finalizing process on a recorded disc, you cannot name a title or create a thumbnail.</u>	Yes Yes <u>After you execute DVD-Video finalizing process on a recorded disc, you cannot name a title or create a thumbnail.</u>
Collecting favorite scenes (Playlist Editing) Making a new title from a Playlist containing favorite scenes (Copy within the same disc)	Yes Yes	No No	No No
Playing contents recorded on this recorder, on other devices	Contents can be played on any devices compatible with DVD-RAM discs. Follow the instruction of the device to play.	Execute DVD-Video finalizing process on this recorder. This process makes the disc playable on other compatible devices. (Some models excepted.)	Execute DVD-Video finalizing process on this recorder. This process makes the disc playable on other compatible devices. (Some models excepted.)
When a message appears and the loaded disc cannot be used:	Initialize the disc. If it is still unusable, try to execute DVD-RAM physical Format.	Initialize the disc.	–

# Index to parts and controls

See pages with arrows for details.

## Front panel

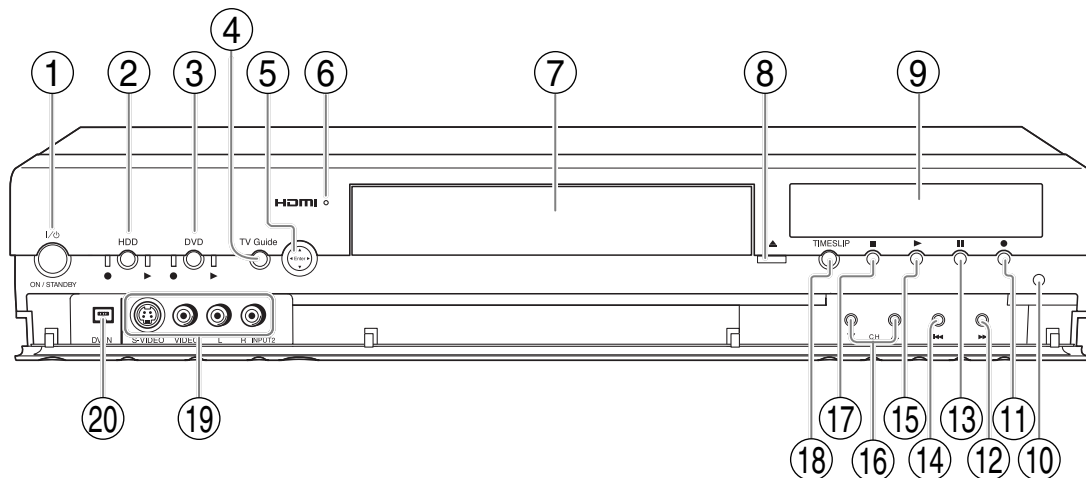

\* The above illustration displays the front panel with the cover open. See the following page on how to open or close the cover.

- ① **ON/STANDBY button / ON/STANDBY indicator** ➔ **page 20**  
Turns the power on/restores the unit in the standby mode.
  - ② **HDD button/HDD indicator** ➔ **page 45, 50**  
Press this to operate the HDD.
  - ③ **DVD button/DVD indicator** ➔ **page 45, 66**  
Press this to operate a disc inside the disc tray.
  - ④ **TV Guide button** ➔ **page 23, 40**  
Starts/exits TV Guide On Screen.
  - ⑤ **▲ / ▼ / ◀ / ▶ / Enter button**
    - ▲ / ▼ / ◀ / ▶ :  
Moves highlight or changes value.
    - Enter:  
Makes a selection or executes an action.
  - ⑥ **HDMI indicator**  
Illuminates while the HDMI connection is verified.
- HDMI, the HDMI logo and High-Definition Multimedia Interface are trademarks or registered trademarks of HDMI Licensing LLC.
- ⑦ **Disc tray** ➔ **page 20**  
Loads a disc into the disc drive.
  - ⑧ **▲ (OPEN/CLOSE) button** ➔ **page 20**  
Opens and closes the disc tray.
  - ⑨ **Front panel display** ➔ **page 18**
  - ⑩ **Remote sensor** ➔ **page 18** in “INSTALLATION GUIDE”
  - ⑪ **● (REC) button** ➔ **page 46**  
Starts recording.
  - ⑫ **▶▶ (SKIP) button**  
Skips to the next chapter or track. ➔ **page 62**
  - ⑬ **|| (PAUSE) button**  
Stops playback or recording momentarily. ➔ **page 47, 61**
  - ⑭ **◀◀ (SKIP) button**  
Skips to the previous chapter or track. ➔ **page 62**
  - ⑮ **▶ (PLAY) button** ➔ **page 66**  
Starts playback.
  - ⑯ **CH buttons** ➔ **page 20, 45**  
Selects the channel.

- ⑰ ■ **(STOP) button** ➡ page 50, 61  
Stops playback or recording.
- ⑱ **TIME SLIP button/TIMESLIP indicator**  
➡ page 68, 69  
Selects the time slip mode.  
Illuminates in the time slip mode.
- ⑲ **INPUT2 jacks** ➡ page 49  
Use this when recording from other input source  
such as a VCR or a camcorder.
- ⑳ **DV IN terminal** ➡ page 52  
Use this when recording from a digital video  
device such as a digital video camera.

■ **To open or close the cover on the front panel**

Put your finger on the left edge of the cover and pull it down to open.

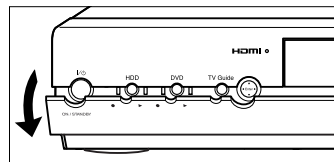

**Note**

- Do not place a heavy object on the cover while it is open. Doing so may damage the recorder.

## Rear panel

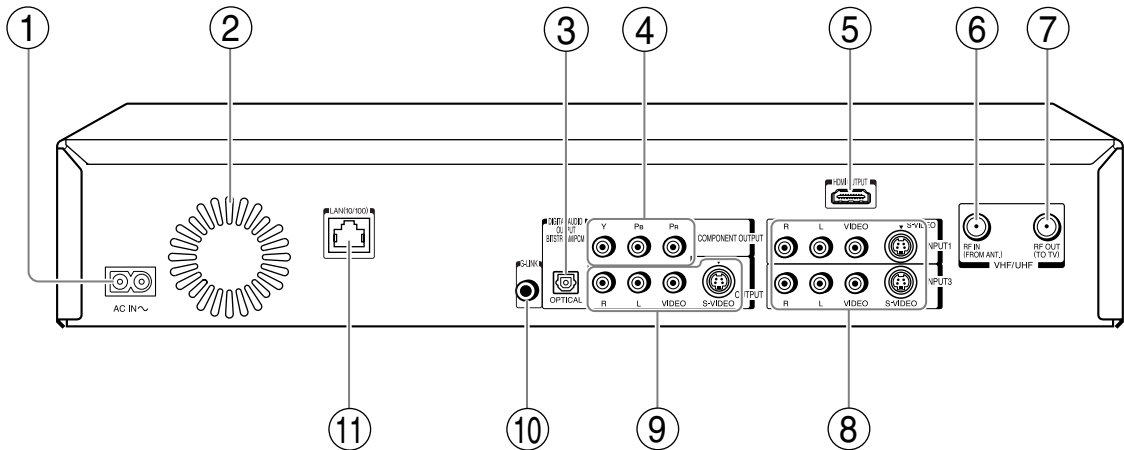

① **AC IN socket** ➔ page 21 in “INSTALLATION GUIDE”

② **Ventilation fan**

③ **DIGITAL AUDIO OUT BITSTREAM/PCM OPTICAL jack** ➔ page 29 in “INSTALLATION GUIDE”

Use this to connect the recorder to an audio receiver equipped with an optical digital audio input jack.

④ **COMPONENT OUTPUT jacks** ➔ page 28 in “INSTALLATION GUIDE”

Outputs video signals to a connected TV or monitor.

Connects to a TV or monitor equipped with component video jacks.

⑤ **HDMI OUTPUT jack** ➔ page 26 in “INSTALLATION GUIDE”

Use this to connect the recorder to a HDMI compatible TV or monitor.

HDMI, the HDMI logo and High-Definition Multimedia Interface are trademarks or registered trademarks of HDMI Licensing LLC.

⑥ **VHF/UHF RF IN (FROM ANT.) input socket** ➔ page 20 in “INSTALLATION GUIDE”

Connects to an antenna or cable signal.

⑦ **VHF/UHF RF OUT (TO TV) output socket** ➔ page 20 in “INSTALLATION GUIDE”

Connects the supplied coaxial cable to a TV.

⑧ **INPUT1/INPUT3 jacks** ➔ page 49

Use this to connect the recorder to output jacks of external devices such as another player or camcorder.

- ⑨ **OUTPUT jacks** ➡ page 21, 23, 24, 28 in “INSTALLATION GUIDE”  
Outputs video and audio signals to a connected TV or amplifier.
- ⑩ **G-LINK jack** ➡ page 25 in “INSTALLATION GUIDE”  
Connect the supplied G-LINK cable to this jack if you are connecting this recorder to a cable set top box. While the recorder is turned off, the TV Guide On Screen system changes channels on your cable box via the G-LINK cable to download free program listings for your area. You are also able to control your cable set top box using the recorder’s remote control after you connect the G-LINK cable and go through the TV Guide On Screen setup.
- ⑪ **LAN(10/100) port**  
For an optional connection to operate the recorder via a PC.  
See “Network Navi” (➡ page 145, 146) for details.

Remote control

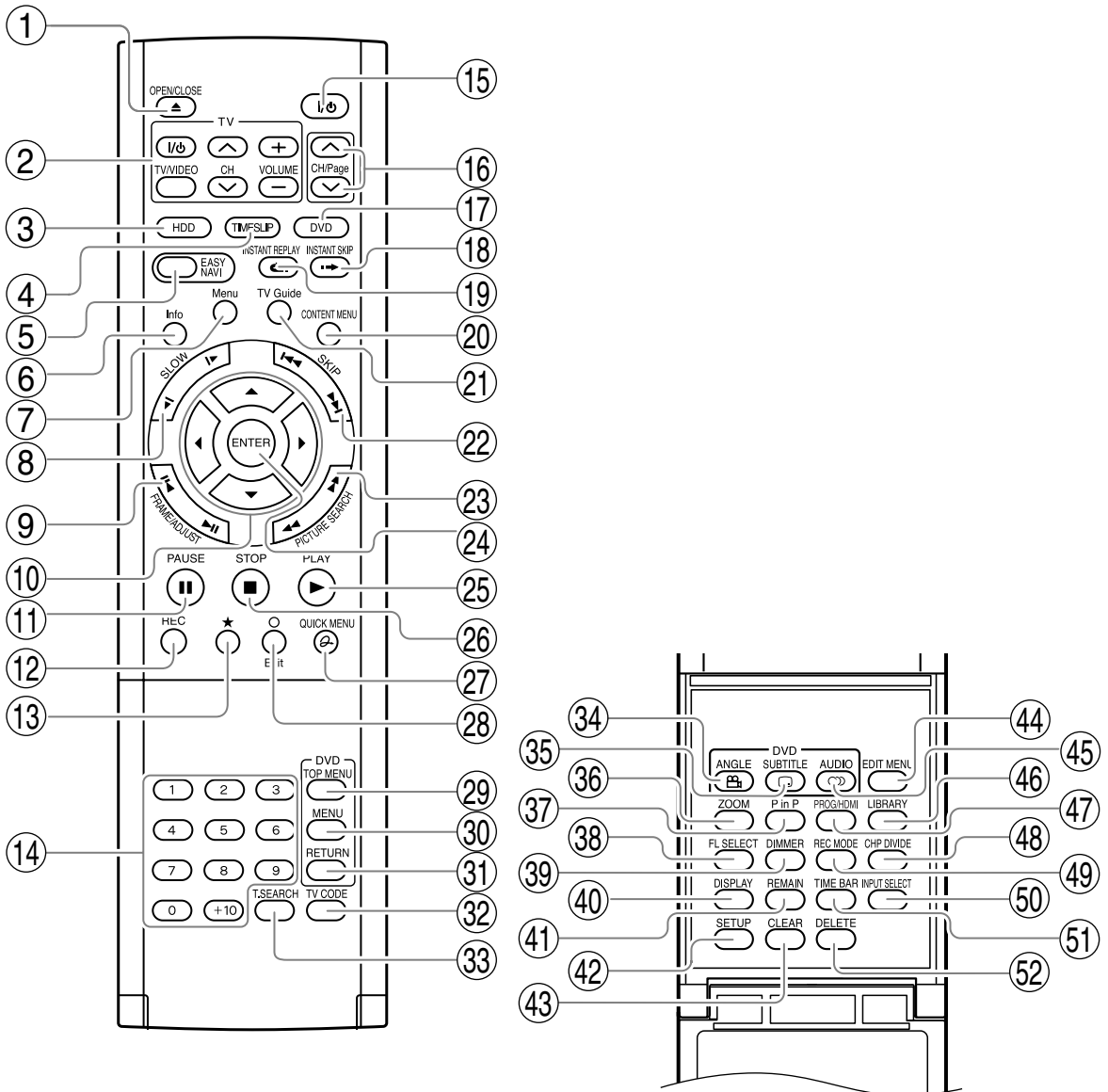



- ① OPEN/CLOSE button ➞ page 20
- ② Buttons for TV operation ➞ page 46 in "INSTALLATION GUIDE"
- ③ HDD button ➞ page 45, 50
- ④ TIMESLIP button ➞ page 68, 69
- ⑤ EASY NAVI button ➞ page 29
- ⑥ Info button ➞ page 23
- ⑦ Menu button ➞ page 23
- ⑧ SLOW button ➞ page 62
- ⑨ FRAME/ADJUST button ➞ page 62, 72
- ⑩ Direction buttons (▲/▼/◀/▶) ➞ page 60, 172
- ⑪ PAUSE button ➞ page 61, 62
- ⑫ REC button ➞ page 40, 46
- ⑬ ★ button ➞ page 70
- ⑭ Number buttons ➞ page 45, 71
- ⑮ ON/STANDBY button ➞ page 20, 21
- ⑯ CH/Page buttons ➞ page 20, 23, 45
- ⑰ DVD button ➞ page 45, 66
- ⑱ INSTANT SKIP button ➞ page 61
- ⑲ INSTANT REPLAY button ➞ page 61
- ⑳ CONTENT MENU button ➞ page 60
- ㉑ TV Guide button ➞ page 23, 40
- ㉒ SKIP button ➞ page 62
- ㉓ PICTURE SEARCH button ➞ page 62
- ㉔ ENTER button ➞ page 23, 24, 60, 172
- ㉕ PLAY button ➞ page 66, 127
- ㉖ STOP button ➞ page 50, 61, 111
- ㉗ QUICK MENU button ➞ page 46, 92
- ㉘ O button ➞ page 123
- ㉙ TOP MENU button ➞ page 66
- ㉚ MENU button\*<sup>1</sup>
- ㉛ RETURN button\*<sup>2</sup>
- ㉜ TV CODE button ➞ page 46 in "INSTALLATION GUIDE"
- ㉝ T.SEARCH button ➞ page 71
- ㉞ ANGLE button ➞ page 67
- ㉟ SUBTITLE button ➞ page 67
- ㊱ ZOOM button ➞ page 70
- ㊲ P in P button ➞ page 70
- ㊳ FL SELECT button ➞ page 19
- ㊴ DIMMER button ➞ page 19
- ㊵ DISPLAY button ➞ page 78
- ㊶ REMAIN button ➞ page 33
- ㊷ SETUP button ➞ page 172
- ㊸ CLEAR button ➞ page 36
- ㊹ EDIT MENU button ➞ page 102, 113
- ㊺ AUDIO button ➞ page 72
- ㊻ LIBRARY button ➞ page 132
- ㊼ PROG/HDMI button ➞ page 26 in "INSTALLATION GUIDE"
- ㊽ CHP DIVIDE button ➞ page 87
- ㊾ REC MODE button ➞ page 45
- ㊿ INPUT SELECT button ➞ page 50
- ① TIME BAR button ➞ page 79
- ② DELETE button ➞ page 55

\*<sup>1</sup> MENU

Use this to display a menu screen that is recorded on a DVD video disc.

Operate the menu screen as the same manner as "Locating a title using the top menu (➞ page 66)". A menu screen is not recorded on some discs.

\*<sup>2</sup> RETURN

Returns to the previous screen (the screen may be specified depending on the disc).

Refer to the instructions of the disc.

## Display

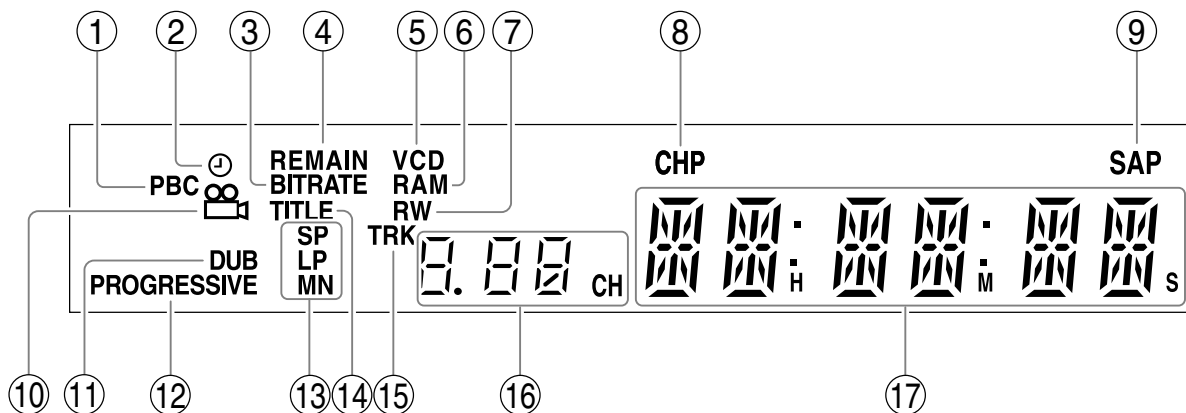

- ① **PBC indicator**  
Illuminates when a PBC-controllable VIDEO CD is loaded.
- ② **Program recording indicator**  
Illuminates when the recorder holds a timer program.
- ③ **Bit rate indicator**  
Illuminates when displaying the bit rate selected for recording, or when displaying the actual bit rate.
- ④ **REMAIN (Remaining space) indicator**  
Illuminates when an available recording time is displayed.
- ⑤ **VCD/CD indicator**  
VCD : Illuminates when a VIDEO CD is loaded.  
CD : Illuminates when an audio CD is loaded.
- ⑥ **DVD-RAM indicator**  
Illuminates when a DVD-RAM disc is loaded.
- ⑦ **DVD-RW/R indicator**  
Illuminates when a DVD-RW/R disc is loaded.
- ⑧ **CHP (Chapter) indicator**  
Illuminates when a chapter number is displayed.
- ⑨ **SAP indicator**  
Illuminates when receiving a SAP broadcast.
- ⑩ **Angle icon** ➡ page 67  
Illuminates when playing a scene recorded with multi angles.
- ⑪ **DUB (Dubbing) indicator**  
Illuminates when copying.
- ⑫ **PROGRESSIVE indicator**  
Illuminates when video signals are output in the progressive format.
- ⑬ **Picture quality mode indicator** ➡ page 183  
The current picture quality mode lights up.  
The modes are: MN (Manual)/SP (Standard Play)/LP (Long Play)

### ■ Dimming the display

Pressing DIMMER button on the remote control changes the brightness of the display (normal/dimmed/off).

### ■ Switching the display

Every time you press FL SELECT button, the display changes between the channel, title number, and time. The display may not change, depending on the disc or recording conditions.

#### ⑭ TITLE indicator

Illuminates when a title number is displayed.

#### ⑮ TRK (Track) indicator

Illuminates when a track number is displayed.

#### ⑯ Channel indicator

Displays the current channel or other numbers such as a title number, track number, bit rate or input selection.

#### ⑰ Multi display

Displays the current time, elapsed time, remaining time, starting time of programmed recording, chapter number or message, etc.

# Before operating this recorder

## ■ Is your recorder ready?

- Refer to "INSTALLATION GUIDE" manual and finish the necessary preparations.
- Turn on the connected equipment such as a TV or audio system and select the input from the recorder.

## ■ Turning the power on

(This owner's manual instructions are based on the premise that all proper connections have been completed and the TV is turned on.)

Press ON/STANDBY on the front panel of the recorder or on the remote control.

ON/STANDBY button/  
ON/STANDBY indicator

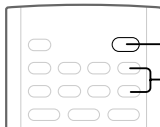

ON/STANDBY button  
CH/Page buttons

When the power turns on, the ON/STANDBY indicator changes from red (standby mode) to green (operation). After a few seconds, a start-up screen appears. The following icon appears at the top right corner of the screen.



When this icon disappears, the recorder is ready to operate. If the disc drive contains a disc, it takes a little longer to start up.

## ■ Viewing TV channels through this recorder

After turning the power on, the recorder will output TV channel signals to the connected TV (also in the stop mode).

You can select a desired channel by pressing the CH/Page or the number buttons.

## ■ Loading a disc

Check disc compatibility beforehand (➡ page 6, 7) and use a proper playable disc.

### Caution

- Keep your fingers well clear of the disc tray. Neglecting this may cause serious personal injury. Keep a close watch on children.
- Do not use a cracked, deformed, or repaired disc.

### 1 Open the disc tray.

Press  on the front panel or the OPEN/CLOSE button on the remote control.

 button

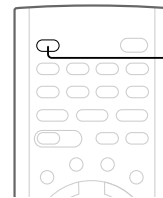
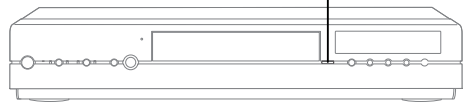

OPEN/CLOSE button

### 2 Insert a disc.

#### Disc without a cartridge

Insert with the playback side down.

There are two kinds of disc size. Place a disc to fit the dish. If a disc is out of the dish, it may result in damage to the disc or malfunction.

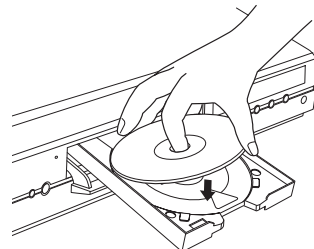

Place a disc in the inside hollow.

#### DVD-RAM disc with cartridge (TYPE1/TYPE2/TYPE4)

##### Single sided

Turn the printed side up, and insert the cartridge into the tray frame following the direction of the arrow on the cartridge.

##### Double sided

Turn the desired recording/playback side up, and insert the cartridge into the tray frame following the direction of the arrow on the cartridge.

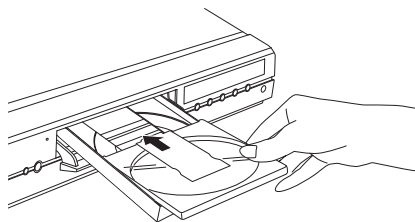

### 3 Close the disc tray.

Press **▲** on the front panel or OPEN/CLOSE button on the remote control.

#### Notes

- Use the button on the front panel or the remote control to open and close the disc tray. Do not push or hold the disc tray while it is moving. Doing so may cause the recorder to malfunction.
- Do not insert a disc which is unplayable, or any object other than a playable disc.
- Do not apply downforce to the disc tray. Doing so may cause the recorder to malfunction.
- If the disc tray stops while closing, the mechanical protection system of this recorder will open it. Do not force it to close. Doing so may cause malfunction.
- If the disc tray would not open, turn the recorder off, and press **▲** button on the front panel or OPEN/CLOSE button on the remote control. This may turn the recorder on and open the disc tray. If it still wouldn't open, contact your nearest TOSHIBA dealer.

### ■ Turning the power off

Press **ON/STANDBY** on the front panel of the recorder or on the remote control.

The "Unloading" icon appears at the top right corner of the screen, and ON/STANDBY indicator turns red, then the power turns off (Standby mode.)

#### Caution

- If the power fails or the power cord is disconnected from a wall outlet while the recorder is in operation (ON/STANDBY indicator lit in green), the HDD or a loaded disc may become recording disabled. In such a case, executing an initialization of the disc using the formatting function of the recorder may refresh it. However, all contents stored on the disc will be completely erased by this initialization process.
- This recorder may indicate alert messages with some DVD-RAM discs right after insertion. If such a disc is used for playback or recording on other equipment, all data in the disc may be damaged and the disc will not be played. By executing an initialization of the disc using the formatting function of the recorder, the disc will become operational.
- If the recorder freezes and does not respond at all, leave it alone for about 15 minutes or longer. This may restore the recorder. After the recorder has recovered, turn it off once and turn it on again to use as usual. If the recorder is still inoperable after more than 15 minutes have passed, press and hold the ON/STANDBY button on the front panel for about 10 seconds or longer. The recorder is forced to quit and the power turns off. Turn the recorder on again and use it as usual. (This is an emergency measure, which may cause losses and/or damages of data. Avoid casual use of this measure. If you try this while the recorder is working properly, especially while the "Loading" or "Unloading" icon is flashing, it may result in initializing of the HDD.) (This 15-minute measure is available only when "Screen protector" is set to "On." (▶ page 181))

#### Note

- If there are any performance malfunctions of the HDD or the DVD-RAM drive, immediately discontinue use of this recorder, and disconnect the power cord from a wall outlet, then contact your dealer. Continuous use of the recorder in such a condition will aggravate the condition and result in increased cost and repair time.

### ■ Disc tray lock (Child lock)

You can lock the disc tray.

**Press and hold PAUSE on the remote control for longer than about 3 seconds.**

To unlock, press the button for longer than about 3 seconds.

#### Note

- Turning the power off also unlocks the disc tray.

## Before operating this recorder (Continued)

### ■ Start-up/Shutdown (closing) icons

These icons are displayed at the top right corner of the screen when startup or finishing. While they are flashing, the recorder is operating as follows:



Start-up, reading a disc, finishing the recording



Unloading a disc, finishing the operation



Opening a disc tray



Closing a disc tray

### ■ Status display

Each time you operate the recorder, the following displays appear on the TV screen to indicate the status of the recorder.



#### Main on-screen displays

(Depending on the disc, some of these may not appear.)

- ▶ : Playback
- || : Pause
- : Stop
- ▶ : Fast-forward\*
- ◀ : Fast-reverse\*
- ▶▶ : Forward skip\*\*
- ◀◀ : Reverse skip\*\*
- ▶|x1/2 : Forward slow-motion
- ◀|x1/2 : Reverse slow-motion
- ||▶ : Forward frame by frame playback
- ◀|| : Reverse frame by frame playback
- : Recording
- || : Recording pause
- Title End : When title playback is completed
- : Instant skip
- ↶ : Instant replay
- Chapter Divide : Chapter division
- ↶ 1/20 : Forward skip by 1/20
- ↷ 1/20 : Reverse skip by 1/20

\* The number of the mark varies according to the playback speed you select.

\*\* Accompanied with the followings:

- HDD | DVD-RAM | DVD-RW | DVD-R :  
Title number/title name and chapter number/  
chapter name
- DVD-VIDEO :  
Title number and chapter number
- VCD | CD :  
Track number

#### Notes

- To disable the status display, set "On screen display" (▶ page 181) to "Off."
- You can add the current status of the settings to this display. See ▶ page 78.

# Using TV Guide On Screen®

The TV Guide On Screen system in your recorder is a free interactive program guide that provides up to 8 days of program listings for over-the-air, cable-ready and analog cable in your area. The system allows you to easily find, set up reminders and schedule recordings of your favorite TV programs.

## ■ Entering TV Guide On Screen mode

### Press TV Guide.

TV Guide On Screen LISTINGS service is displayed.

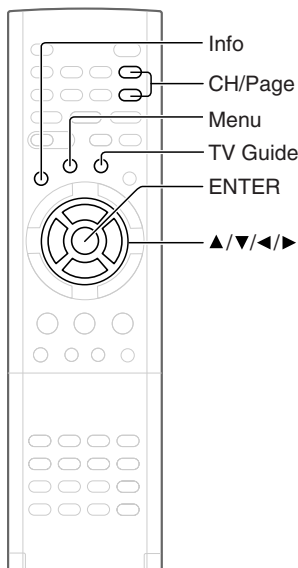

## ■ Buttons in TV Guide On Screen mode

▲ / ▼ / ◀ / ▶:

Moves the highlight.

ENTER:

Makes a selection or executes an action.

Menu:

Displays a Panel Menu with options.

Info: (while **INFO** is displayed)

Changes the Info Box size.

Opens a Help screen when you move the highlight on the service bar.

CH/Page:

Scrolls one page up or down in the LISTINGS service.

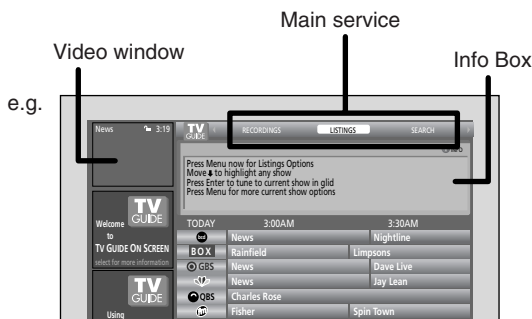

The LISTINGS service contains a list of up to 8 days of TV programs including today.

### To view a TV program

Press ▲ / ▼ to select a TV program and press ENTER.

### To view information of a TV program

Press ▲ / ▼ to select a TV program and press Info.

To close the Info Box, press Info twice.

### To access options (e.g., recording, reminder, etc.)

See the next page.

You also have access to the following services besides the LISTINGS service. While on the Main service bar select a service by pressing ◀ / ▶, then press ENTER. If you press Info while a service is highlighted, an Info box opens to show you more information about the service. Follow any instructions provided. For details, see the next page.

### RECORDINGS :

List all shows recorded through the TV Guide On Screen system.

### SEARCH

Sort by keyword, movies, sports, HDTV, and more.

### SCHEDULE

Review, add or modify scheduled recordings and reminders.

### SETUP

Change the TV Guide On Screen defaults to your preference or redo the setup

### Notes

- To exiting TV Guide On Screen mode, press TV Guide.
- While the TV Guide On Screen system is displayed other menus (e.g. EASY NAVI, CONTENT MENU, EDIT MENU, LIBRARY MENU) are not available. To use these menus, exit the TV Guide On Screen system.

In the United States, TV Guide and other related marks are registered marks of Gemstar-TV Guide International, Inc. and/or one of its affiliates. In Canada, TV Guide is a registered mark of Transcontinental Inc., and is used under license by Gemstar-TV Guide International, Inc.

The TV Guide On Screen system is manufactured under license from Gemstar-TV Guide International, Inc. and/or one of its affiliates.

The TV Guide On Screen system is protected by one or more of the following issued United States patents 6,498,895; 6,418,556; 6,331,877; 6,239,794; 6,154,203; 5,940,073; 4,908,713; 4,751,578; 4,706,121.

Using TV Guide On Screen® (Continued)

**Note**

Over-the-air or cable access to stations carrying TV Guide On Screen data is required for the TV Guide On Screen system to operate. TV Guide On Screen does not work with satellite programming. Toshiba does not provide the TV Guide On Screen data. Rather, such data is provided by a third party, which is responsible for its accuracy and availability. Additionally, occasional compatibility issues may exist between the TV Guide On Screen system contained in your DVD Recorder and the data provided by the third party. In the event that you experience any performance issues with your TV Guide On Screen system, please contact TACP Consumer Solutions by calling (800) 631-3811 or by visiting <http://www.tacp.com/customersupport/contact.asp>.

**Services and options**

For more details press Info while navigating through the various options and services.

**LISTINGS**

If you select a TV program and press Menu, a panel menu appears under the video window. Press ▲ / ▼ to select an option then press ENTER.

e.g.

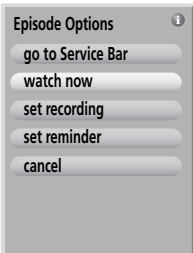
	go to Service Bar	Closes the menu, changes no information, and returns a Highlight to the Service Bar.
	watch now	The selected TV program appears in a full screen.
	set recording	You can set the TV program to record. See ➡ page 40.
	set reminder	You can set a reminder to the TV program. See ➡ page 26.
	cancel	Changes are canceled and this menu is closed.

e.g.

	schedule reminder	Your selections below are entered and this menu is closed.
	frequency	Press ◀ / ▶ to select the frequency.
	auto tune TV	Press ◀ / ▶ to select whether to tune to the channel.
	when	Press ◀ / ▶ to select the time you want the reminder to appear.

**Tips on panel menu operation**

- ▲ / ▼ buttons move a highlight. If you see “▲” or “▼” on the top or bottom of a panel menu, CH/Page buttons can be used to turn the page.
- To enter a digit, use the number buttons.
- When a box has “◀” and “▶” on both sides, use ◀ / ▶ buttons to cycles between the options.
- Press ENTER from an option to highlight the default command button (e.g., “done”). Press ENTER again to execute the action and close the panel menu.
- To cancel any changes and close the menu, press Menu, or select “Cancel” then press ENTER.

**Notes**

- You can set the video window to remain on a single channel (“lock”) or change channels (“unlock”) as you navigate through LISTINGS. With a channel logo or “LISTINGS” is highlighted, press Menu button to display the option to select “lock” or “unlock”.
- You can access a TV program advertised in a panel ad. While the panel ad is highlighted press ENTER. If the TV program is airing now, you would tune to it. A panel menu appears, if the program is in the future.

**SEARCH**

If you select this service and press ENTER, categories appear on a bar under the Service Bar. By selecting one of the categories, you can search TV programs. After searching, you can open “Episode Options” by pressing Menu to access the options (above).

**To search by Search type (Alphabetical, HDTV, Movies, Sports, Children, Educational, News, Variety, Series)**

- 1) Press ◀ / ▶ to select a Search type.
- 2) Press ▲ / ▼ to select a category, then press ENTER.



## To search by entering a keyword

- 1) Press ◀/▶ to select "KEYWORD" then press ENTER.  
"Keyword Search" appears.
- 2) Press ▲/▼ to select "new search" then press ENTER.  
"Search Options" appears.
- 3) Press ▲/▼ to select "category" then press ◀/▶ to select a category.
- 4) Press ▲/▼ to select "enter keyword" then press ENTER.  
The keyboard appears.
- 5) Press ▲/▼/◀/▶ to enter a keyword.

e.g.

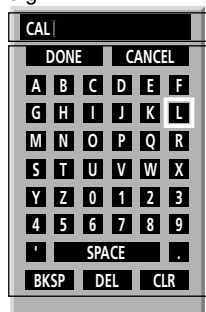

Press ◀/▶ to select an entry point then press ENTER.

The selected letter is entered.

Press ▲/▼/◀/▶ to select then press ENTER.

The text entry box is highlighted.

BKSP erases a letter on the left of the cursor.

DEL erases a letter on the right of the cursor.

SPACE inserts a space on the left of the cursor.

CLR erases all letters.

- 6) When complete, press ▲/▼/◀/▶ to select "DONE" then press ENTER.  
A list of all matching TV programs for that keyword is displayed.

## RECORDINGS

If you select this service and press ENTER, TV programs previously recorded or currently recording are listed. You can select one from the list to view or delete.

### To list programs in alphabetical order or by date and time

- 1) While "RECORDINGS" is highlighted, press Menu.  
"Recordings Options" appears.

- 2) Press ▲/▼ to select an option.

e.g.

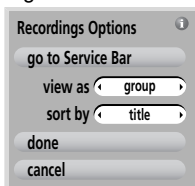

view as

Press ◀/▶ to select.

group: Titles of recorded TV programs are listed.

list: Displays a detailed list of every recorded program.

sort by

Press ◀/▶ to select.

title: Listed in alphabetical order

date: Listed by date and time, with most recent date and time first.

- 3) When complete, press ▲/▼ to select "done" then press ENTER.  
A list of all matching TV programs for that keyword is displayed.

### To play recorded program ("view as" is set to "group")

- 1) Press ▲/▼ to select a TV program then press ENTER.
- 2) Press ▼ to select an episode and press ENTER.

#### Notes

- If you play a TV program which you played before, playback starts from where you last stopped. To view it from the beginning, select the TV program on RECORDINGS, then press ENTER and ▼ to select an episode then Menu. On "Episode Options" select "play from beginning" then press ENTER.
- When "view as" is set to "list", press ▲/▼ to select a TV program, then press ENTER.

## Using TV Guide On Screen® (Continued)

## To delete recorded programs (“view as” is set to “group”)

- 1) Press ▲ / ▼ to select a TV program and press ENTER.
- 2) Press ▼ to select an episode and press Menu.  
“Episode Options” appears.
- 3) Press ▲ / ▼ to select “delete episode” then press ENTER.  
A confirming menu appears.
- 4) Press ▲ / ▼ to select “yes” or “no” then press ENTER.

**Note**

- When “view as” is set to “list”, press ▲ / ▼ to select a TV program and Menu. On “Episode Options”, press ▲ / ▼ to select “delete episode” then ENTER. Press ▲ / ▼ to select “yes” or “no” then ENTER.

## SCHEDULE

If you select this service and press ENTER, reminder and recordings you set previously are listed. You can edit or delete them.

- 1) Press ▲ / ▼ to select a TV program.
- 2) Press Menu.  
“Schedule Options” appears.
- 3) Press ▲ / ▼ to select then press ENTER.

e.g.

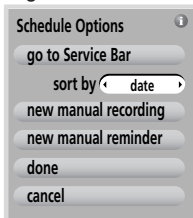

- sort by Press ◀/▶ to select how you display the list. (date, title, event)
- new manual recording You can set recording manually. See ➞ page 43.
- new manual reminder You can set a reminder manually. See below.

e.g.

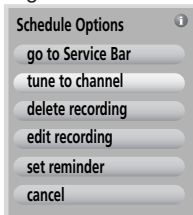

- delete recording (delete reminder) A confirming menu appears.  
Press ▲ / ▼ to select “yes” or “no” then press ENTER.
- edit recording (set recording) Opens a menu.  
For a recording, see ➞ page 43.
- set reminder (edit reminder) You can set a reminder manually. See below.

e.g.

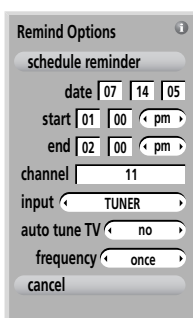

- schedule reminder Your selections below are entered and this menu is closed.
- date Press the number buttons to input the date (month, day, year).  
To shift the highlight, press ▲ / ▼.
- start Press the number buttons or ◀/▶ to input the time (hour, minute, am/pm).  
end To shift the highlight, press ▲ / ▼.
- channel Press the number buttons to input a channel number.
- input Press ◀/▶ to select the input.
- auto tune TV Press ◀/▶ to select whether the TV is automatically tuned to the channel you have selected.
- frequency Press ◀/▶ to select the frequency.

**Notes**

- When a reminder message appears, select an option by pressing ◀/▶ and then press ENTER. If you don't make a selection within 30 seconds, the recorder proceeds with the scheduled recording or reminder.
- If reminders conflict, “REMINDER CONFLICT!” appears. Press ▲ / ▼ to select an option, then press ENTER.

## SETUP

If you select this service and press ENTER, options to change settings are listed.

### To execute the setup again

- 1) Press ▲ / ▼ to select “Change system settings” then press ENTER.  
Your current settings are displayed.
- 2) Press ▲ / ▼ to select your answer then press ENTER.
- 3) Follow the on-screen guidance.

### To arrange the position the channel appears in LISTINGS

#### To change the tuning channel number

#### To switch channels on/off in LISTINGS

- 1) Press ▲ / ▼ to select “Change channel display” then press ENTER.  
“Grid Options” appears.

- 2) Press ▲ / ▼ to select a channel then press Menu.
- 3) Press ▲ / ▼ to select then press ENTER.

e.g.

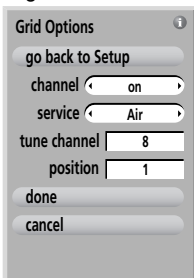

channel

Press ◀/▶ to select “on” or “off”.  
on: the channel is always displayed.  
off: the channel is never displayed.  
auto-hide: the channel hides automatically.

service

Press ◀/▶ to select the signal type of the channel.

tune channel

Press the number button to enter a channel.

position

Press the number button to enter a desired position for the channel in LISTINGS.

- 4) When complete, press ▲ / ▼ to select “done” then press ENTER.

### To change Info Box size

- 1) Press ▲ / ▼ to select “Change default options” then press ENTER.
- 2) Press ▲ / ▼ to select “General defaults” then press Menu.  
“General Defaults” appears.
- 3) Press ▲ / ▼ to select then press ENTER.

e.g.

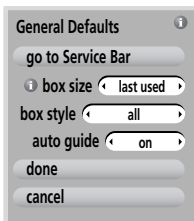

i box size

Press ◀/▶ to select the initial size of the Info Box.

box style

Press ◀/▶ to select the size location when Info is pressed.

auto guide

Press ◀/▶ to select whether the recorder enters TV Guide On Screen system when powered on.

- 4) When complete, press ▲ / ▼ to select “done” then press ENTER.

## Using TV Guide On Screen® (Continued)

## To change recording defaults

- 1) Press ▲ / ▼ to select “Change default options” then press ENTER.
- 2) Press ▲ / ▼ to select “Record defaults” then press Menu.

“Record Defaults” appears.

e.g.

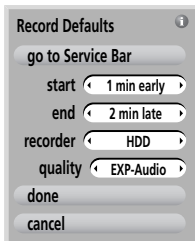

- |          |                                                                            |
|----------|----------------------------------------------------------------------------|
| start    | Press ◀ / ▶ to select the time to start recording.                         |
| end      | Press ◀ / ▶ to select the time to end recording.                           |
| recorder | Press ◀ / ▶ to select the drive.                                           |
| quality  | Press ◀ / ▶ to select the recording mode.<br>(For details, see ➡ page 42.) |

- 3) When complete, press ▲ / ▼ to select “done” then press ENTER.

## To change reminder defaults

- 1) Press ▲ / ▼ to select “Change default options” then press ENTER.
- 2) Press ▲ / ▼ to select “Remind defaults” then press Menu.

“Remind Defaults” appears.

e.g.

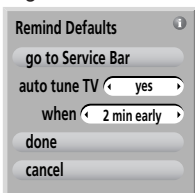

- |              |                                                                                                    |
|--------------|----------------------------------------------------------------------------------------------------|
| auto tune TV | Press ◀ / ▶ to select whether the channel is automatically tuned to the channel you have selected. |
| when         | Press ◀ / ▶ to select the time you want the reminder to appear.                                    |

- 3) When complete, press ▲ / ▼ to select “done” then press ENTER.

### ■ Note on watching TV with TV Guide On Screen

If you leave the recorder turned on without executing any action for about 3 hours, a message will appear on the TV asking you want to continue watching TV.

If you want to continue watching TV, press ENTER.

If you do not press ENTER, the recorder will automatically turn off within about 10 minutes.

### Note

- The TV Guide On Screen menus shown in this manual are for illustration purposes only. The channels, programs, and TV Guide On Screen information as illustrated may not be available in your area, may be subject to change.

# Key operation - EASY NAVI & QUICK MENU

The **EASY NAVI** button opens “EASY NAVI Main Menu”, a main gate to the functions of this recorder. From this menu, you can access the desired functions while viewing a current picture. Additionally, **QUICK MENU** button provides you a sub menu of the current function.

## ■ EASY NAVI

Press **EASY NAVI**.

Sound is muted and the following GUI appears. (Actual displays vary depending on operational status.)

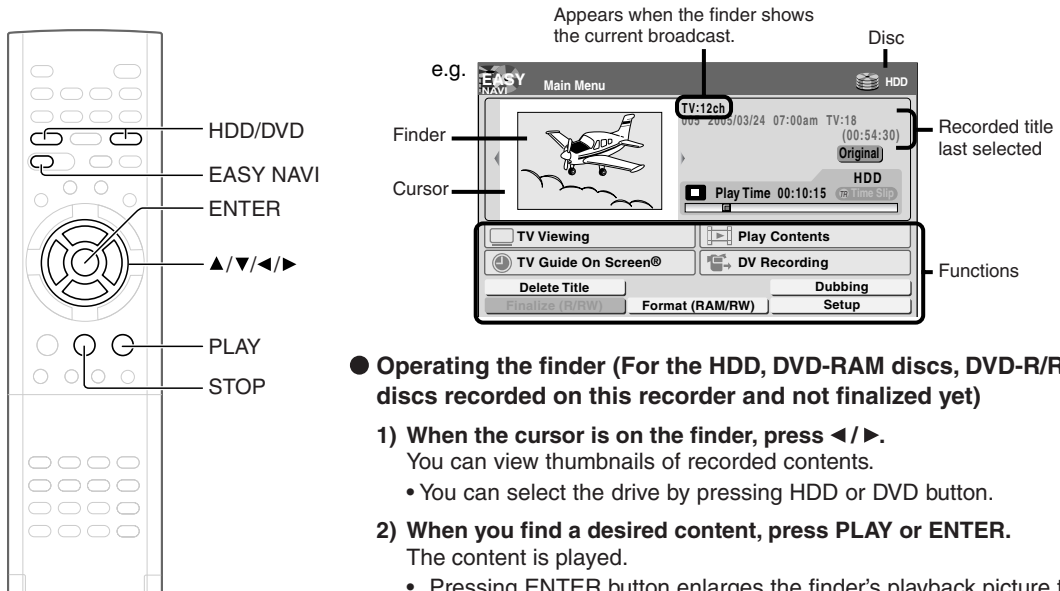

### ● Operating the finder (For the HDD, DVD-RAM discs, DVD-R/RW discs recorded on this recorder and not finalized yet)

#### 1) When the cursor is on the finder, press ◀/▶.

You can view thumbnails of recorded contents.

- You can select the drive by pressing HDD or DVD button.

#### 2) When you find a desired content, press **PLAY** or **ENTER**.

The content is played.

- Pressing **ENTER** button enlarges the finder's playback picture to the full of the screen.
- You can change playback speed. See ➡ page 62.

#### 3) To stop, press **STOP**.

A current channel broadcast appears. (“TV:xxxch” accompanies.)

- Pressing **REC** button starts recording. On recording, see ➡ page 32.

### ● Item selection

Press **▲/▼/◀/▶** to select an item, then press **ENTER**.

(Unavailable features are grayed out.)

Item	Function	➡ page
<b>TV Viewing</b>	Return to current broadcast channel.	–
<b>Play Contents</b>	Recorded contents are listed in a thumbnail view.	60
<b>TV Guide On Screen®</b>	TV Guide On Screen SCHEDULE appears.	24
<b>DV Recording</b>	The setting menu for recording contents from equipment connected to the DV terminal.	52
<b>Delete Title</b>	You can delete the current content. Operate according to the message.	55
<b>Dubbing</b>	You can access a menu to dub the current content.	100
<b>Finalize (R/RW)</b>	You can execute the DVD-Video finalizing process on the loaded disc.	122
<b>Format (RAM/RW)</b>	You can format the loaded disc.	34
<b>Setup</b>	A setup menu appears.	172

(Continued)

- **To exit the EASY NAVI**  
**Press EASY NAVI again.**

**Note**

- For a disc other than the specified one, the finder cannot be operated. To play the disc, exit the EASY NAVI then press the PLAY button, or select the “Play Contents” function.

■ **Quick Menu operation**

To access various optional functions of this recorder, open Quick Menu. Quick Menu displays a list of selections relevant to your current mode.

● **Opening Quick Menu**

1) **Press QUICK MENU.**

The following menu (“Quick Menu”) appears.  
(Actual selections vary depending on operational status.)

e.g.

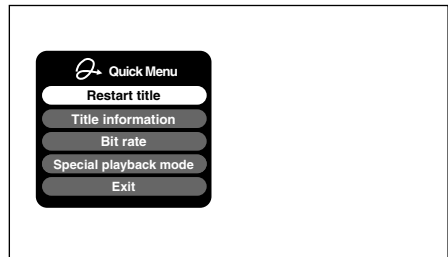

- 2) **Press ▲ / ▼ to select an item, then press ENTER.**

● **To exit Quick Menu**

**Press QUICK MENU again.**

Alternatively

**Select “Exit” with ▲ / ▼, then press ENTER.**

## Hint on reading this manual

The following icons show the playable discs for each function described on this instruction manual.

**HDD** : HDD

**DVD-RAM** : DVD-RAM disc

**DVD-RW** : DVD-RW disc

**DVD-R** : DVD-R disc

**DVD-VIDEO** : DVD video disc

**VCD** : VIDEO CD

**CD** : Audio CD  
(For CD containing JPEG or MP3/WMA files,  
see  page 74, 76.)

Most instructions are based on remote control operation, unless otherwise noted. You can use the buttons on the remote control and those on the main unit as well when they have the same function.

If copy protection signal is detected during recording on this recorder, the recording automatically pauses and a message appears. In this case, the PAUSE button cannot release the recording. (It is possible to end the recording by pressing the STOP button.) If the copy protection signal continues, the recording will terminate.

# Recording

Recording variations for many types of programs or situations.

- **Before recording**
- **Setting a timer recording using TV Guide On Screen®**
- **Recording a TV program**
- **Recording an external source**
- **DV recording (Recording from a digital video camera)**
- **Deleting recorded contents**
- **Others**

# Before recording

Please be sure to read this critical background information prior to making a recording.

**This recorder is equipped with a built-in HDD. Conventional video cassette recorders have required tapes to record, while this recorder enables recording on the HDD whenever you want, without selecting an available tape or confirming its recording time or tape remaining. Further, the DVD-RAM drive on this recorder can record on a DVD-RAM/R/RW disc in the same way as a tape. You can also copy contents recorded on the HDD to a DVD-RAM/R/RW disc to create your own library.**

## ■ Is your recorder ready?

Before recording a TV program on this recorder, insure that channels you want to record are correctly tuned in on this recorder.

If not tuned in, read the separate "INSTALLATION GUIDE" volume again, and confirm all the necessary connections and settings have been done.

Also, insure the clock is set precisely for program recording.

## ■ Disc initializing

Whenever you use a new DVD-RAM disc on this recorder, be sure to initialize the disc. For DVD-RAM discs, initialization is indispensable to the database system of this recorder.

Normally, the HDD does not need to be formatted. If the HDD does not work normally due to a problem, format the HDD for possible recovery. Once you format the HDD, all the recorded titles and Library information are deleted. Before formatting, be sure to write library information to a DVD-RAM disc and check any titles to be deleted.

DVD-RW discs can be emptied by initializing.

DVD-R discs can be used on this recorder without initializing.

For details of initialization of DVD-RAM discs, see  page 34.

If an initialized DVD-RAM disc is still unusable, it may become usable by executing "DVD-RAM physical format" in "Management settings" menu.

For "DVD-RAM physical format", see  page 35.

## ■ Note on recording on a DVD-RAM disc

Confirm disc compatibility and prepare an available DVD-RAM disc to record on ( page 6, 8).

Some discs may need to be formatted for use on this recorder. A message will appear asking you to execute disc formatting. Follow the procedure displayed on-screen to format the DVD-RAM disc compatible with this recorder.

Some DVD-RAM discs formatted on a PC may not be usable.

## Note

- This recorder records on a DVD-RAM disc if it complies with DVD-RAM standard Version 2.0, 2.1 or 2.2. However, you may not record on some DVD-RAM discs that have complicated contents (often, to protect the recorded data). When you select a DVD-RAM disc that has already been recorded, check that the disc is suitable for recording or the remaining time of the disc is displayed. It is recommended to use a new DVD-RAM disc for an important recording.

## ■ Note on recording on a DVD-RW disc

Confirm disc compatibility and prepare an available DVD-RW disc to record on ( page 6, 9).

Some discs may need to be initialized for use on the recorder. A message will appear asking you to execute disc initializing. Follow the procedure displayed on-screen for initializing the DVD-RW disc compatible with this recorder.

Some DVD-RW discs initialized on a PC may not be usable.

To play a DVD-RW disc recorded on this recorder on an other device, finalize the DVD-RW disc on this recorder. ( page 122)

The finalization disables the disc's rewritability. To rewrite a finalized DVD-RW disc, cancel the finalization ( page 125).

- On DVD-RW discs recorded on other devices, you cannot execute DVD-Video finalize process or cancel the finalize process, or add recordings on this recorder.
- DVD-RW discs which are recorded on other devices and not finalized yet, cannot be read on this recorder. Do not rush to initialization. Check that the contents can be erased or not.



### ■ Note on recording on a DVD-R disc

Confirm disc compatibility and prepare an available DVD-R disc to record on (➡ page 6, 9).

To play a DVD-R disc recorded on this recorder on other devices, finalize the DVD-R disc on this recorder. (➡ page 122)

The finalization permanently disables the disc's writeability. (Canceling the finalization is not possible.)

- DVD-Video finalize process cannot be canceled if once executed on a DVD-R disc.
- On DVD-R discs recorded on other devices, you cannot execute DVD-Video finalize process or add recordings on this recorder.
- DVD-R discs with the method of "DVD-Video Creation" have been already executed the DVD-Video finalize process. Therefore, they cannot be added the contents.

### ■ If you want to record contents which will be copied to a DVD-R/RW disc later on

See ➡ page 48.

### ■ To check space remaining on a disc

#### 1) Press REMAIN.

The current capacity per disc is displayed at the bottom of the screen. The current capacity of the selected drive is displayed on the front panel display.

#### 2) After checking the capacity, press REMAIN again to turn off the display.

### ■ When "HDD recording is not possible due to..." appears

The HDD is full. To record new content, delete unnecessary titles or transfer some content to a DVD-RAM disc.

### ■ Programmed recording and operational status

The recorder gives priority to programmed recordings in every operating mode. Even if the recorder is playing, recording or editing, or even in standby mode, at a starting time of a programmed recording the recorder will make itself ready or stop those operations and start the recording.

However, "Creating a DVD-Video" (➡ page 112) and "DVD-Video finalizing process" (➡ page 122) operations may have priority over programmed recordings.

### ■ When the programmed settings overlap

Before the first recording is completed, the second program is scheduled to begin recording. When using a DVD-RAM disc, the recording of the previous program stops 10 seconds before the next program starts. (If you have been recording over 9 hours on the same drive, the current recording stops approximately 2 minutes before the next programme starts.)

When using a DVD-R/RW disc, the recording of the previous program stops about 2 minutes before the next program starts, to complete data process. In this 2 minutes, you cannot operate the loaded DVD-R/RW disc.

### Notes

- The "Loading" icon appears in the top right of the screen after recording. This indicates that the unit is executing the final recording process (writing managing information). Operations other than changing channels cannot be done until this icon disappears. The time for executing this process differs depending on the recording time or capacity of the disc.
- Note that all recording content may be deleted if the unit is disconnected from a wall outlet, or a power failure occurs, during recording.
- If a power failure occurs within 5 minutes prior to the programmed recording start time, the programmed recording may not be executed.

## Initializing a DVD-RAM/RW disc (Logical format)

**Be sure to read this section prior to using a DVD-RAM/RW disc on this recorder for the first time. For DVD-R, initializing is not necessary.**

A disc should be initialized in the following cases: (The recorder may display a message to request you to do so.)

e.g.

- When you use a DVD-RAM/RW disc on this recorder for the first time.
- If data fragments produced by repeated recording or erasing have accumulated.
- If a disc error has occurred.
- When you want to record on a DVD-RAM disc for PC. (➡ page 8)

Initializing formats a disc logically and insures that it will perform to its full capability. However, this erases all data on the disc, so make sure that it does not matter if data on the disc is erased whenever you initialize a disc.

### ■ How to initialize a disc

To initialize a DVD-RAM disc, load it in the recorder. See ➡ page 20 for loading a disc.

#### 1) Press QUICK MENU.

The following menu appears. (The actual contents depends on the operational status of the recorder.)

e.g.

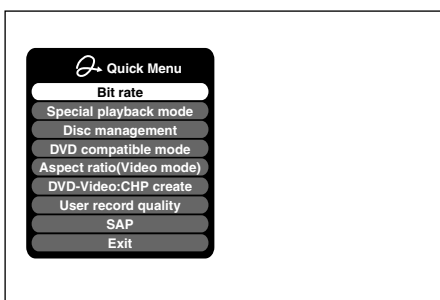

#### 2) Press ▲ / ▼ to select “Disc management,” then press ENTER.

A sub menu appears on the right side.

e.g.

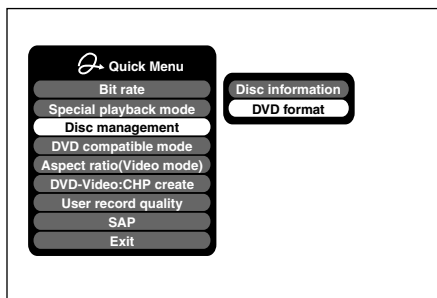

#### 3) Press ▲ / ▼ to select “DVD format,” then press ENTER.

e.g.



### Numbering a disc

The recorder automatically numbers discs when initializing. However, you can assign a desired number (using 3 digits) and designate sides A and B on a double-sided disc. (DVD-RW discs cannot be numbered.)

- (1) Press ▲ / ▼ buttons to select “Edit” of “Disc Number” then press the ENTER button.
- (2) Press ▲ / ▼ buttons to select a digit.
- (3) Press ◀ / ▶ buttons to shift.
- (4) Repeat steps (2) and (3).
- (5) Press ENTER button.

### Naming a disc

You can name a disc.

- (1) Press ▲ / ▼ buttons to select “Edit” of “Disc Name,” then press ENTER button.  
The character input window appears.
- (2) Enter a disc name following the procedure of “Entering characters” (➡ page 36).
- (3) Press ★ button to eliminate the window.

- 4) Press ◀/▶ to select “Start,” then press ENTER.

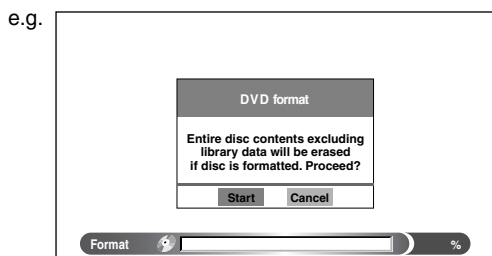

- 5) Press ◀/▶ to select “Start,” then press ENTER. Initialization starts.

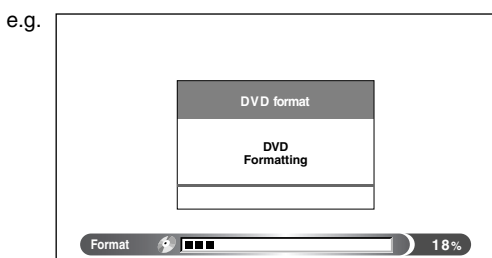

When the initialization is completed, the setup window disappears.

## DVD-RAM physical format

Physical formatting is a simple execution for a disc which cannot be used or read (or which is becoming hard to read). It may refresh such a disc for recording and playback. (There is no guarantee that all such discs will be recovered.)

“DVD-RAM logical format” process only rewrites certain data on file system and management information, however, “DVD-RAM physical format” rewrites all data on a disc, therefore it takes a much longer time to complete. For a 4.7GB single sided DVD-RAM, about 70 minutes will be necessary. While processing, all recorder operations and functions including program recording will not work until the process is finished. Also this process erases all data stored on the DVD-RAM disc.

- 1) Press SETUP.

- 2) Press ◀/▶ to select “Management settings” then press ENTER.

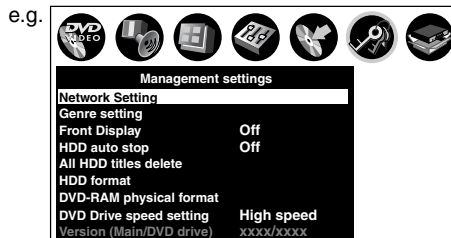

- 3) Press ▲/▼ to select “DVD-RAM Physical Format,” then press ENTER.

- 4) Press ◀/▶ to select “Yes,” then press ENTER to execute.

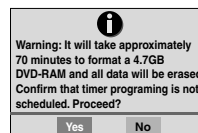

To cancel, select “No”, then press ENTER button.

- 5) Read the message, and press ◀/▶ to select “Yes” or “No”, then press ENTER.

### Notes

- The physical format process may fail if executed to a dirty DVD-RAM disc. Also, the disc may be difficult to record, even if it is finished. Before executing DVD-RAM physical format process, be sure to confirm the disc is not dirty. Clean it if necessary. If the disc has scratches or dust beyond cleaner's efficacy, do not execute DVD-RAM physical format process on the disc.
- The following DVD-RAM discs require physical formatting:
  - A disc which is not formatted correctly.
  - The disc which has errors during writing because of dirt on the disc, and cannot be further recorded, or cannot initialize normally.
- You need to start physical formatting from the first step again when you use a failed disc.
- Physical formatting does not work if the disc contains a lot of voids beyond the limitation of this recorder.
- If an error occurs in physical formatting, “ERR-01” appears in the front panel display. To turn off the message, press DISPLAY button on the remote control.

## Entering characters

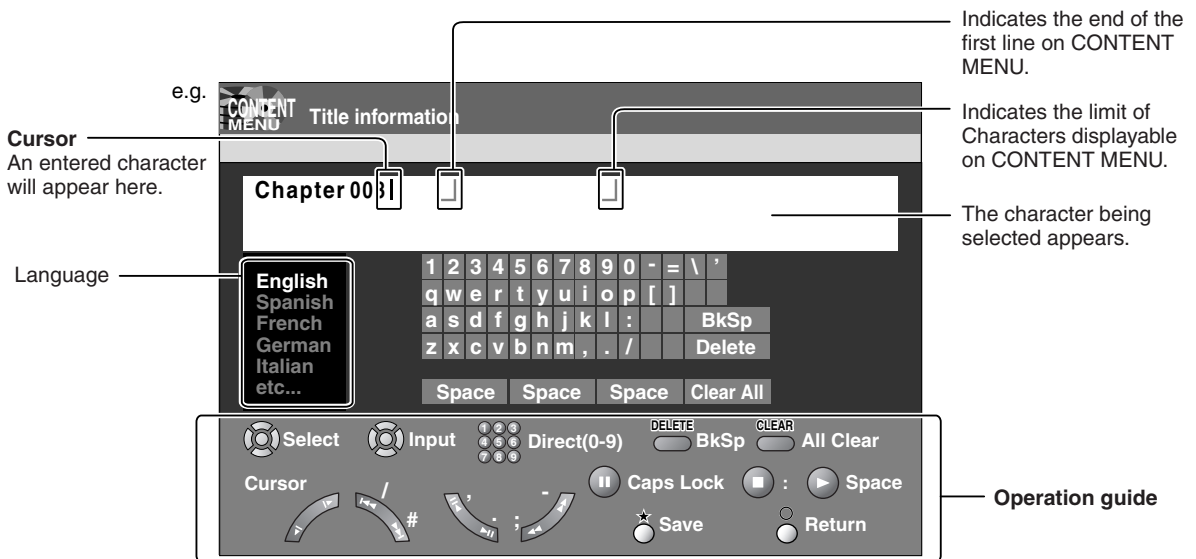



### ■ Operation guidance of the remote control

To enter the character, normally use ▲ / ▼ / ◀ / ▶ buttons on the remote. About the other buttons to be used are shown on the operation guide.

 : Shifts the cursor.

 : Enters a number.

 : Erases one character immediately to the left side of the cursor.

 : Erases all the characters.

 : Caps Lock

 : Saves the changes and returns to the previous screen.

 : Cancels the changes and returns to the previous screen.

 : Enters a space.

 : Enters a symbol.

### ■ Switching a language

Before entering a character, move a cursor to the language selection area by pressing ◀ / ▶ buttons. Then press ▲ / ▼ buttons to select a language, then press ENTER button.

## ■ Entering characters

The cursor may be followed by unwanted characters.

You can erase them if necessary by either of the following measures:

### Erasing characters

- Erasing all the characters on the writing board  
Select "Clear All" by pressing ▲ / ▼ / ◀ / ▶ buttons, then press ENTER button.  
Alternatively, press CLEAR button.
- Erasing one character before the cursor  
Select "BkSp" by pressing ▲ / ▼ / ◀ / ▶ buttons, then press ENTER button.  
Alternatively, press DELETE button.

- (1) Press ■■ button to select an input mode.
- (2) Press ▲ / ▼ / ◀ / ▶ buttons to select a character, then press ENTER button.  
The selected character is input on the cursor.
- (3) Repeat steps (1) and (2) to enter characters.
- (4) When finished, press ★ button to save the characters.  
The characters you entered appears.

### Notes

- You can enter up to 64 characters.
- When unnecessary information appears, or when you want to alter the input character, press CLEAR button to erase all, or press DELETE button to erase an unnecessary character.

## Selecting a disc according to purposes of use (DVD-RAM/R/RW)

There are various types of discs having different standards.

Select one for your purpose of use.

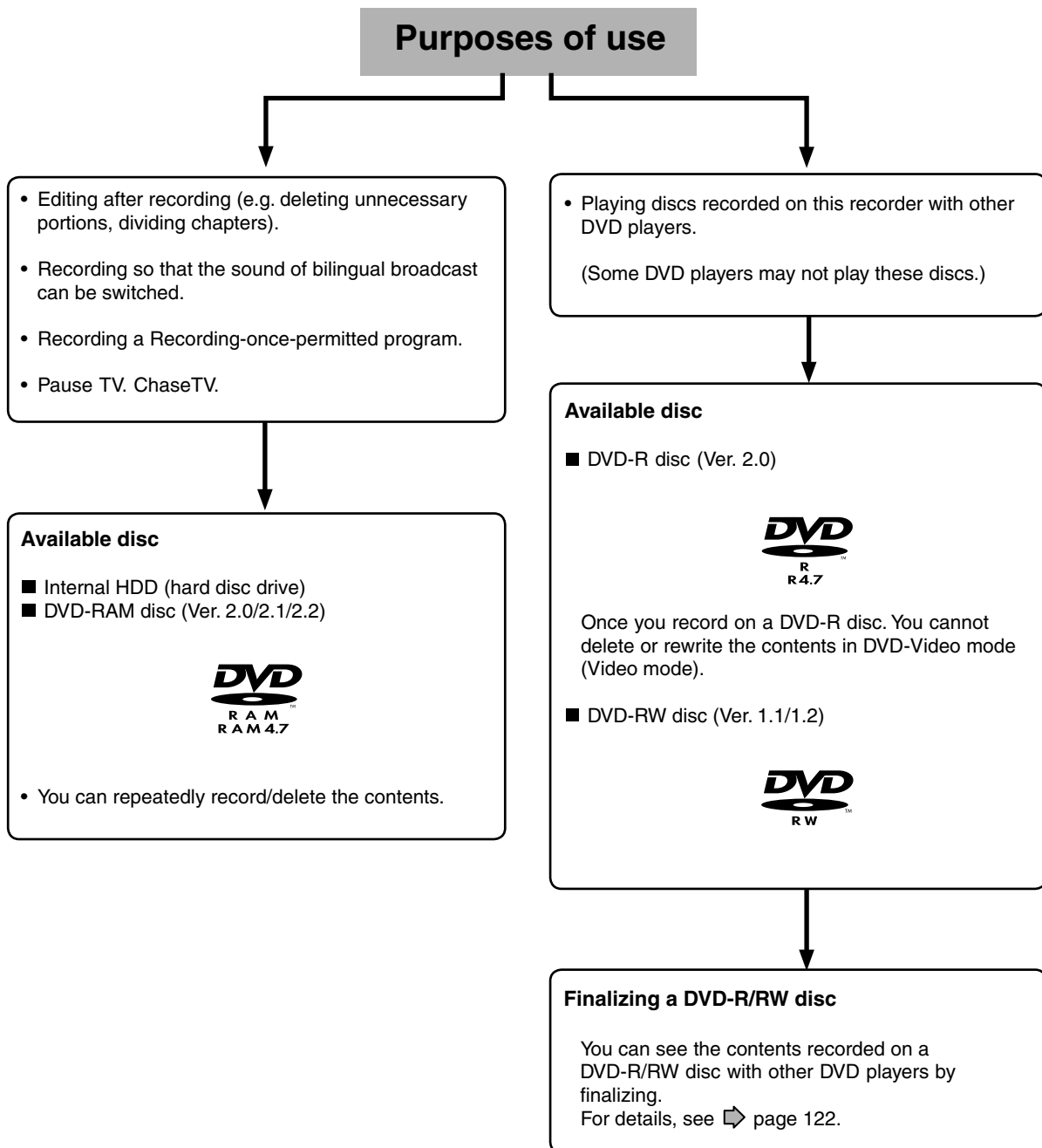

When recording on a DVD-R/RW disc you need to set up the recorder due to the restriction by the DVD-Video standard.  
For details, see the next page.

## Setting for recording on a DVD-R/RW disc in Video mode

This setting is necessary to play the contents on a DVD-R/RW disc with other DVD players.

### ■ Items to set up

When recording in Video mode, there are some restrictions by DVD-Video standard. Therefore, it is necessary to set up these items below. Set up the items in advance before copying contents from the HDD to a DVD-R/RW disc.

#### ● DVD compatible mode

Only the main sound and SAP sound are available for recording in Video mode under DVD-R/RW standard.

Off: This is not for recording on a DVD-R/RW disc. Depending on Picture/Audio settings, making DVD Video may not be possible. (When recording directly on a DVD-R/RW disc in DVD-Video mode, the recording proceeds with "Main" on even though "Off" is set.)

Main: In multichannel broadcasting, only the main sound is recorded.

SAP: In multichannel broadcasting, only SAP sound is recorded.

#### ● Aspect ratio

"4:3" and "16:9" cannot be mixed in one title. Therefore, set the aspect ratio before recording.

4:3: Set the aspect ratio to 4:3

16:9: Set the aspect ratio to 16:9

#### ● Chapter dividing ("DVD-Video:CHP Create")

This is the setting to divide a title into some chapters. It is convenient to skip scenes.

Off: Chapter dividing is not available.

5 min, 10 min, 15 min, 20 min:

Select an interval for chapter dividing.

### Note

- When the number of chapters reaches a limit, chapters are not divided anymore. The limit number of chapters is dependent on conditions of a DVD-R/RW disc.

### How to set up

#### 1 Press SETUP.



SETUP menu appears.

#### 2 Select "DVD recorder operation" and press ENTER.

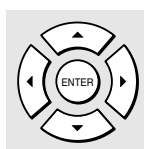

#### 3 Select "Aspect ratio (Video mode)" and press ENTER.

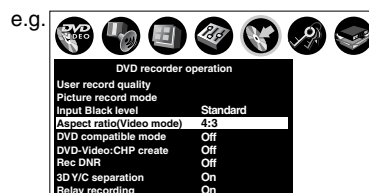
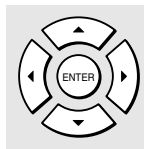

#### 4 Press ▲ / ▼ to select an item and press ENTER.

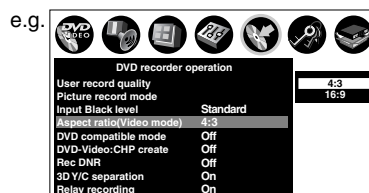
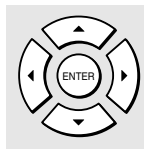

Set up "DVD compatible mode" and "DVD-Video: CHP create" as step 3, 4.

# Setting a timer recording using TV Guide On Screen®

To record TV programs and end them automatically, follow the procedures of this chapter. Before setting recording, see “Before recording” (➡ page 32).

## ■ Preparation

- When you record on a DVD-RAM/R/RW disc, load it into the recorder.
  - Load a disc which has sufficient remaining space to record the program.
  - Make sure the loaded disc is not write-protected.
- Make sure that the disc has enough space to record.
- Set “DVD Compatible mode” beforehand. (➡ page 39)
- To record satellite TV programs, set a recording manually (➡ page 43)

If you **do not need to change recording options** (recording mode or time range), see “With recording frequency selection only” below.

If you want to change these recording options, follow the procedure of “Changing the recording options” procedure (➡ page 41) or “Set recording by specifying details manually” (➡ page 43).

## With recording frequency selection only

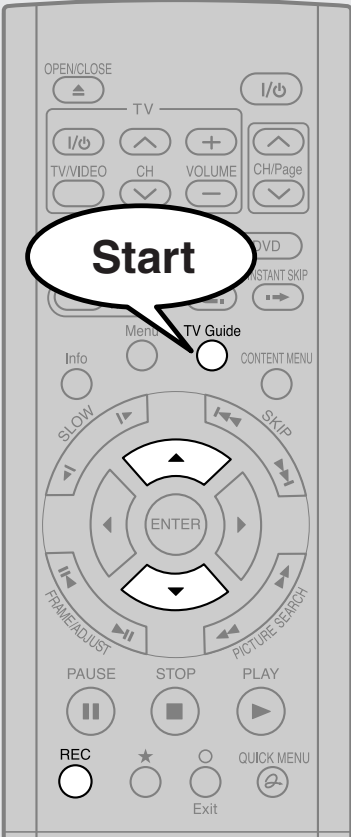

**1 Press TV Guide.**

TV Guide On Screen LISTINGS appears.



**2 Press ▲ / ▼ to select a TV program to record.**

For searching a TV program, see ➡ page 24.

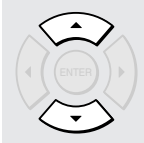

**3 Press REC repeatedly to select the recording frequency.**

Each time you press REC button, the icon changes. For the icons, see ➡ page 42.



### Note

- Recording will be executed on the default settings (➡ page 28).



## Changing the recording options

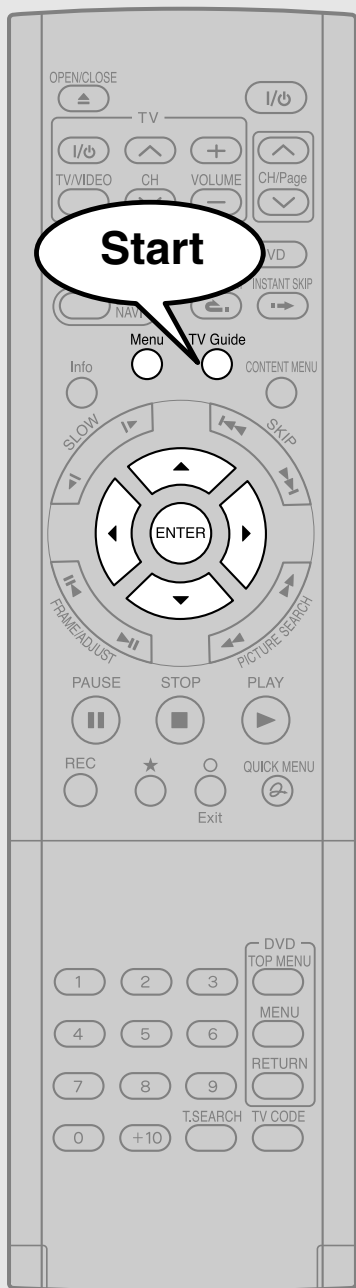

### 1 Press TV Guide, then press ▲ / ▼ to select a TV program to record.



Or to search for a TV program, see ➤ page 24.

### 2 Press MENU.

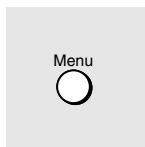

"Episode Options" appears.

### 3 Press ▲ / ▼ to select "set recording" then press ENTER.

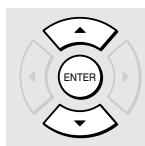

"Record Options" appears.

e.g.

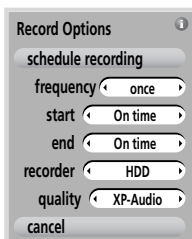

### 4 Press ▲ / ▼ to shift and press ◀ / ▶ to select.

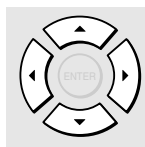

frequency:  
See the next page.

start:  
Choices are between 120 minutes early and 120 minutes late, to "On time". (Default = "On time")

end:  
Choices are between 120 minutes early and 120 minutes late, to "On time". (Default = "On time")

(Continued)

recorder:  
 HDD: Records onto the HDD.  
 DVD: Records onto a loaded disc.

quality:  
 See "Recording mode"

## 5 When complete, press ▲ / ▼ to select "schedule recording" then ENTER.

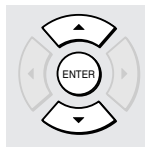

"Record Options" is closed.  
 The icon appears on the TV program.

**Note**

If you cancel the selections, select "cancel" then press ENTER button.

■ **Frequency of recordings/reminders and icon**

- Recording
- 🕒 Reminder

Icon	Meaning
	One time execution
	For a program on the same channel and at the same start time
	For a program on the same channel and at the same start time of Monday through Friday
	For a program on the same channel and at the same start time on the selected day of the week.
	Keeps information without executing, until the frequency is changed.

\*For "new manual recording" and "new manual reminder" only.

■ **Recording quality (recording mode)**

Mode	Bit rate	Sound quality	Recording time*
XP-Audio	8.0	L-PCM	1
XP	9.2	□□D/M2	1
EXP-Audio	4.8	L-PCM	1.5
EXP	6.2	□□D/M1	1.5
SP-Audio	3.2	L-PCM	2
SP	4.6	□□D/M1	2
MP	3.0	□□D/M1	3
LP	2.2	□□D/M1	4
EP	1.4	□□D/M1	6
SEP	1.0	□□D/M1	8
User	See ➡ page 183.		

\*4.7GB DVD-RAM disc

The recording times listed above are for reference purposes only and are not guaranteed. Recording times may vary.

## Set recording by specifying details manually

### 1) Press TV Guide.

TV Guide On Screen LISTINGS appears.

### 2) Press ◀/▶ to select "SCHEDULE".

### 3) Press Menu.

"Schedule Options" appears.

### 4) Press ▲/▼ to select "new manual recording" then press ENTER.

"Record Options" appears.

### 5) Press ▲/▼ to select "date" then press the number buttons to input the date (month, day, year).

To shift the highlight, press ▲/▼.

### 6) Press ▲/▼ to select "start" then press the number buttons or ◀/▶ to input the start time (hour, minute, am/pm).

To shift the highlight, press ▲/▼.

Also set "end" in the same manner.

### 7) Press ▲/▼ to select "channel" then press the number buttons to input a channel number.

### 8) Press ▲/▼ to select "input" then press ◀/▶ to select the input.

Tuner: TV broadcast

Line 1, 2, 3: external device connected to the recorder

### 9) Press ▲/▼ to select "recorder" then press ◀/▶ to select the recording drive (HDD, DVD).

### 10) Press ENTER.

"Record Options" is closed.

The icon appears on the TV program.

### Notes

- The disc tray does not close automatically, even when the recording start time arrives. Set the recorder loaded an available DVD-RAM/R/RW disc beforehand.
- It is not possible to record the same contents onto both the HDD and a DVD-RAM/R/RW disc simultaneously.
- When there is little time before a programmed recording starts, you may not be able to start another recording.
- Playback of the DVD drive pauses when a programmed recording onto the HDD starts.
- Do not change TV Guide On Screen settings (e.g., cable input, brand, etc.) while a recording is programmed. After then, make the programming again if necessary.
- Confirm the "DVD compatible mode" (➡ page 184) setting. "Main" or "SAP" records main sound or sub-sound of multiplex broadcasts respectively, and does not record the other. Therefore, select "Main" or "SAP" only when you record onto a DVD-R/RW disc.
- When recording onto a DVD-R/RW disc, set "DVD compatible mode" (➡ page 184) to the desired recording sound for each timer program.
- When recordings conflict, "RECORDINGS CONFLICT!" appears. Read the message, and choose an option by pressing ▲/▼ then press ENTER button.

■ **Deleting a recording**

2 ways are available.

On LISTINGS

- 1) Press TV Guide.
- 2) Select a TV program you have set to record (icon displayed).
- 3) Press Menu.  
"Episode Options" appears.
- 4) Press ▲ / ▼ to select "delete recording", then press ENTER.
- 5) Read the message, and press ▲ / ▼ to select "yes" (if you want to delete), then press ENTER to exit.

On SCHEDULE

- 1) Press TV Guide.
- 2) Press ◀ / ▶ to select "SCHEDULE".
- 3) Press ▲ / ▼ to select a TV program you have set to record.
- 4) Press Menu.  
"Episode Options" appears.
- 5) Press ▲ / ▼ to select "delete recording", then press ENTER.
- 6) Read the message, and press ▲ / ▼ to select "yes" (if you want to delete), then press ENTER to exit.

■ **Correcting a recording**

- 1) Press TV Guide.
- 2) Press ◀ / ▶ to select "SCHEDULE".
- 3) Press ▲ / ▼ to select a TV program you have set to record.
- 4) Press Menu.  
"Episode Options" appears.
- 5) Press ▲ / ▼ to select "edit recording", then press ENTER.  
"Record Options" appears.
- 6) Change the selections.
- 7) Press ▲ / ▼ to select "schedule recording", then press ENTER.

■ **To stop a scheduled recording**

- 1) Press TV Guide.
- 2) Press ▲ / ▼ / ◀ / ▶ to select the TV program currently being recorded.
- 3) Press REC repeatedly until the recording icon disappears.

■ **Turning the power off automatically after completing a scheduled recording**

- 1) While executing a scheduled recording, press QUICK MENU.  
Quick Menu appears.
- 2) Press ▲ / ▼ to select "Auto power off" then press ENTER.

■ **Keeping the power on even after the scheduled recording finished**

If the recorder turns itself on to execute a scheduled recording, it will turn itself off after finishing the recording. You can restrict this and keep the recorder powered on.

- 1) While executing a scheduled recording, press QUICK MENU.
- 2) Press ▲ / ▼ to select "Continuous power on" then press ENTER.

# Recording a TV program

To record a TV program currently being broadcast, follow the procedures of this chapter.

## ■ Preparation

- When you record on a DVD-RAM/R/RW disc, load it into the recorder.
  - Load a disc which has sufficient space available to record the program.
  - Make sure the loaded disc is not write-protected.
- If you record on a DVD-R/RW disc, set "DVD compatible mode" (➡ page 184) to "Main" or "SAP." In DVD-R/RW recording, "Off" setting is regarded as "Main."
- If you record on a DVD-R/RW disc, set "Aspect Ratio(Video mode)" (➡ page 184) according to recording sources.



## 1 Press HDD or DVD to select a media to record on.

HDD

HDD : To record on the HDD.

DVD : To record on a DVD-RAM/R/RW disc.

DVD

## 2 Select a channel to record.

CH/Page

Use any of the followings:

- CH/Page buttons (↕)
- Number buttons
- TV Guide On Screen (➡ page 23)

1 2 3  
4 5 6  
7 8 9  
0

## 3 Press REC MODE repeatedly to select the recording mode.

REC MODE

Each time you press the button, the recording mode indicator (SP/LP/MN) on the front panel changes.

### Recording mode

The REC MODE button sets the following recording modes; 2 modes (SP, LP) with fixed picture and sound quality, and 1 (MN) for your customizing.

e.g. When a single sided 4.7GB DVD-RAM is used:

Recording mode	Recording time	Picture quality
SP	Approx. 2 hours	Standard quality
LP	Approx. 4 hours	Inferior to SP
MN	Variable according to your setting. See ➡ page 46, 183.	

(Continued)

You can set in advance the desired mode for each recording media ("HDD", "DVD"). See below.  
Also for your customization of the MN mode, see below.

## 4 Press REC.

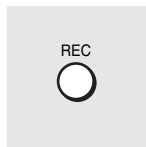

Recording starts.

### ■ Customizing the MN mode

- 1) During stop or at step 3 on page 45, press QUICK MENU.
- 2) Press ▲ / ▼ to select "User record quality" then press ENTER.
- 3) Change the setting for each recording media.

- Press ◀ / ▶ to select "HDD" or "DVD".
- Press ADJUST to select the setting number (1 - 5).

e.g.

Setting	Mode	Rate	Audio quality
1	Manual	6.6	L-PCM
2	SP	4.6	DDM1
3	LP	2.2	DDM1
4	Manual	6.0	DDM2
5	Manual	3.2	DDM1

You can customize each setting.  
Press ▲ / ▼ / ◀ / ▶ to select "Mode", "Rate" or "Audio quality", then press ADJUST to change the value.

### Notes

- To record a high quality picture, select "MN" to raise a bit rate. The higher the bit rate, the better the picture quality is, but the shorter the recording length becomes. We recommend that you set this between 6.0 Mbps and 6.8 Mbps.
- You can change the combination of picture and audio quality settings also by displaying the Quick Menu on LIBRARY MENU or in stop mode, then selecting "User Record Quality". Either of the above methods updates the setting of this recorder.
- If you set "SP" or "LP", you cannot select "L-PCM".
- Depending on the audio quality settings, the upper limit for the picture quality setting differs.
- You can adjust the manual rate for picture quality by 0.2 Mbps from 2.0 to 9.2. (You cannot set the rate from 1.4 to 2.0.)

### 4) Press ENTER.

The menu disappears.

## Notes

- During recording, you cannot change the recording parameters, such as modes, channels, etc.
- The number of titles cannot exceed 99 for a DVD-RAM/R/RW disc or 396 for the HDD.
- One continuous recording cannot exceed in any case 9 hours. Recording automatically stops at 9 hours.
- Even during normal recording, you can set the programmed recording.
- You cannot start recording immediately before a programmed recording starts.
- For recorded sound, see ➡ page 73.
- During monaural sound recording, the same sound is recorded on both the left and right channels.
- When "Audio" is set to "L-PCM", multi-channel sound is recorded as stereo sound. When playing this recorded sound, you will hear MAIN and SAP sounds simultaneously. Press AUDIO button to select a desired sound.
- When "DVD compatible mode" is set to "Main" or "SAP", the unit records the same sounds on both the left and right channels when receiving monaural sound. When receiving the multi-channel sound, the selected sound, Main or SAP, is recorded on both the left and right channels.
- Depending on the disc contents, pressing REC button may take a longer time to start recording.
- When a starting time of a programmed recording comes, a recording in execution is stopped and the programmed recording starts. If you do not want to stop the recording, cancel the timer program before it starts.
- Even if you set "Aspect ratio(Video mode)" (➡ page 184) to "16:9", images are recorded in 4:3 aspect ratio when using a DVD-R/RW disc with "Rate" set to "1.0" (Mbps) or "1.4" (Mbps).

### ■ To stop recording

Press STOP.

### ■ To pause recording (to omit an unnecessary portion)

During recording, press PAUSE.

To resume recording, press it again.

#### Note

- Pausing recording automatically creates a new chapter division at that point.

### ■ To change a TV channel to be recorded

- 1) During recording, press PAUSE.  
Recording pauses.
- 2) Press CH/Page or the number buttons to change the channel.
- 3) Press PAUSE to resume recording.

### ■ To view a TV program while recording another

- 1) Start recording on this recorder.
- 2) On a connected TV, select the TV mode.
- 3) Using the channel selector of the TV, select a desired channel on the TV.

### ■ To reduce noise on recordings (Rec DNR)

Before recording, set "Rec DNR" (➡ page 185).

### ■ To record and play at the same time

- To start recording while playing a disc  
Stop playback, then select the other disc by pressing HDD or DVD button, and start recording on that disc.
- To play a disc while recording on another disc  
Select the disc that is not being recorded by pressing HDD or DVD button, and start playback on the disc.

#### Note

- During a dubbing job, the unoccupied drive is available for recording or playback, however, cannot perform a function which records and plays simultaneously.

### Recording a TV program (Continued)

#### ■ To play a recorded title while recording another on the same disc (Recorded Title Play)

HDD DVD-RAM

During recording, you can play a title recorded on the same disc.

- 1) While recording, press **CONTENT MENU**.
- 2) Press **▲ / ▼ / ◀ / ▶** to select a desired title, then press **ENTER**.

Playback of the selected title starts.

Pressing **STOP** button stops playback, and the content currently being recorded returns. If you press **PLAY** button, playback resumes from the location you last stopped.

#### Notes

- The playback picture may appear after a delay of several seconds.
- While you are using this function, the following operations/ functions are not available.
  - Programmed playback (repeat playback, intro scan etc.)
  - Editing (Playlist programming, dubbing, title/chapter naming, title thumbnail setting, etc.)
- This function is not available during the 10 minutes overlapped portion of the relay recording (➡ page 56).
- Depending on the data condition, playback may pause.
- During a dubbing job, this function is not available.

#### ■ When recording contents which will be copied to a DVD-R/RW disc later on

Before recording, set "DVD compatible mode" (➡ page 184) to "On".

Each timer program must be set its "DVD compatible mode" from Quick Menu.

#### ■ Creating chapters while recording

Press **CHP DIVIDE** button.

The content is divided into two chapters at the point you pressed the button.

#### Note

- If you want to divide into chapters at desired points on DVD-R/RW discs, use this method. On those discs, you cannot create chapters after recording.

#### ■ Creating chapters automatically at regular intervals

Set "DVD-Video:CHP Create" (➡ page 185).



# Recording an external source

You can record programs from connected equipment on the HDD or a DVD-RAM/R/RW disc.

Connect according to A or B.

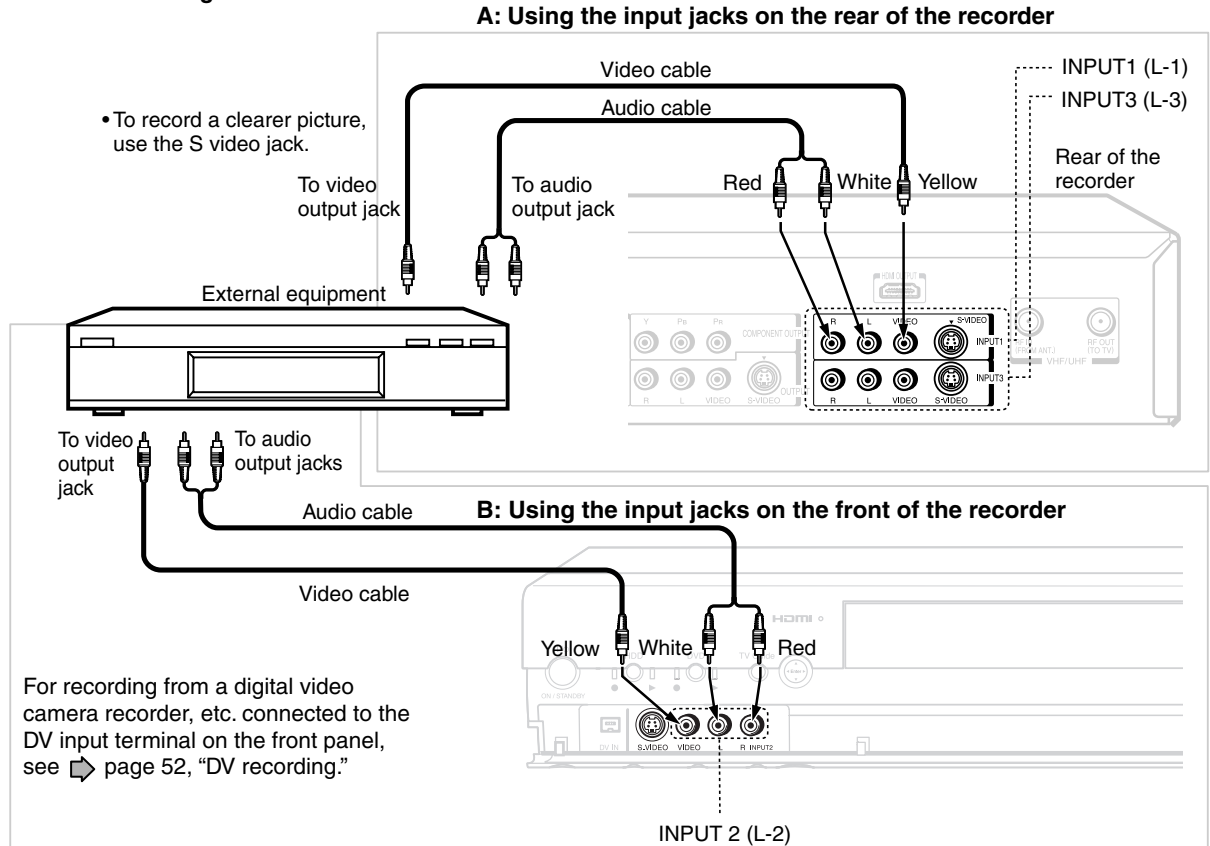

## ■ Preparation

- When you record on a DVD-RAM/R/RW disc, load it into the recorder.
  - Load a disc which has sufficient remaining space to record the program.
  - Make sure the loaded disc is not write-protected.

## Notes

- If a source of high quality sound track such as DVD audio is recorded with this recorder, the sound quality becomes regular audio CD quality. Refer to the instructions of the connected equipment.
- When you record an external source onto a DVD-R/RW disc or the contents which will be copied to a DVD-R/RW disc later on, set the connected equipment to output sound you want to record (if selectable such as multiplex broadcasting), as the recorder records sounds of an external source in stereo onto a DVD-R/RW disc, ignoring the setting of "DVD compatible mode" (➔ page 184).
- DVD-R/RW discs cannot record contents with copy restriction signal embedded (copy-protected or copy once contents), DVD-RAM discs can record copy once contents.
- Some satellite programs via a connected tuner may contain both 4:3 pictures and 16:9 pictures. DVD-R/RW discs cannot record such contents under the restriction of the DVD-Video standard. To record these programs, use the HDD or DVD-RAM discs.
- Depending on the source recording device used and how that device is set up, the video and sound quality of the recording may vary slightly from the video and sound quality of the source device.

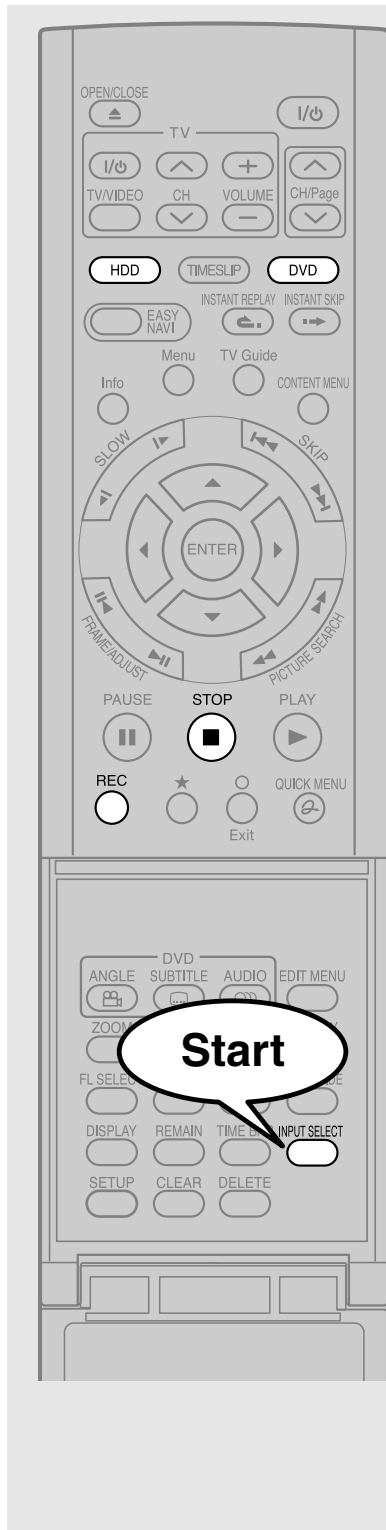

**1** Press **INPUT SELECT** repeatedly so that “L-1,” “L-2,” or “L-3” appears on the front panel display, corresponding to the input in which the device is connected.



Each time you press the button, the indicator changes.

**L-1:** To record pictures from equipment connected to the INPUT1 jacks on the rear panel.

**L-2:** To record pictures from equipment connected to the INPUT2 jacks on the front panel.

**L-3:** To record pictures from equipment connected to the INPUT3 jacks on the rear panel.

**L-U:** To record pictures currently played (➡ page 110).

**2** Press **HDD** or **DVD** to select a recording media.



**HDD :** To record on the HDD.

**DVD :** To record on a DVD-RAM/R/RW disc.



**3** Press **REC** of this recorder to start recording.



**4** Start playback of the source content on the connected equipment.

**5** When recording is completed, press **STOP**.



## ■ Notes on recording from a connected VCR or camcorder

### ● Check the condition of the source equipment before playing.

Set the equipment in a good condition, e.g. clean the head or adjust the tracking, etc. to obtain optimum playback. Bad conditions may produce noises in playback. These noises may be detected as copy protection signals, resulting in a stoppage of the recording.

Play a source in an usual mode. Avoid using any correcting or enhancing features, as they may add signals which can be detected as copy protection signals.

Source quality or tape condition beyond adjustments on the source equipment may stop a recording on this recorder.

### ● Do not operate the source equipment during recording on this recorder.

Operations such as pausing, resuming, fast-forwarding (CUE) and fast-reversing (REVIEW), etc. may produce noises, which may be detected as copy protection signals. Therefore, first start playback on the source equipment to confirm that the desired source can be played properly, and then start recording on this recorder.

Do not operate the source equipment during recording. After completing the desired scene, stop the recording on the recorder, and then stop the playback on the source equipment. Delete unnecessary scenes using editing functions (▶ page 55). If you want to operate the source equipment during recording, pause or stop the recording. After operating the source equipment, resume the recording as above.

### ● When recording from a camcorder

Follow the above notes. Be sure to power the camcorder with its AC adapter, not batteries. If batteries are run down, the recording may not be finished completely.

# DV recording (Recording from a digital video camera)

You can connect a DV format digital video camera to the DV terminal to record from it.

## ■ Preparation

- Press HDD or DVD button to select a recording media
- Connect a DV format digital video camera to the DV terminal on the front panel.

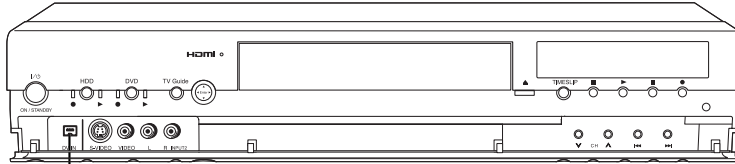

DV IN terminal

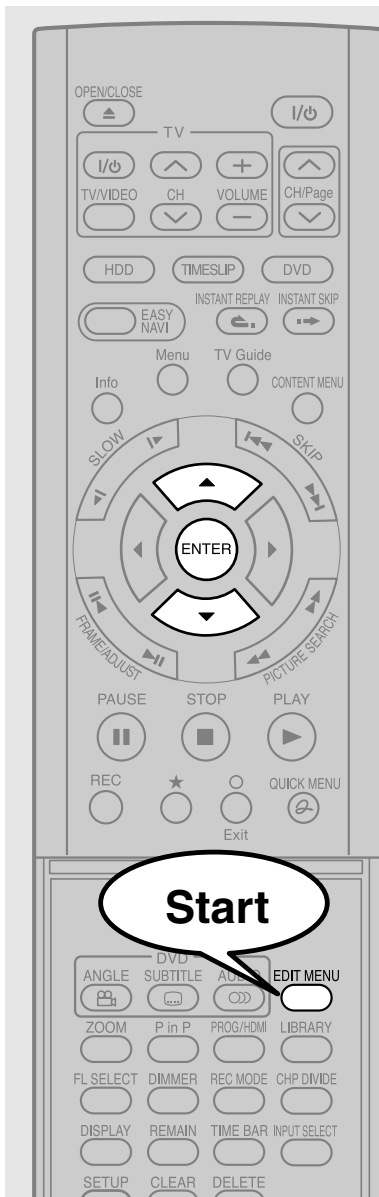

## 1 Press EDIT MENU.



“EDIT MENU Main Menu” appears.

## 2 Press ▲ / ▼ to select “DV Recording”.

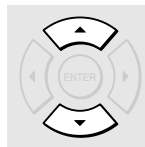

e.g.



## 3 Press ENTER.



“EDIT MENU DV Recording (Option Setting)” appears.

e.g.



This display will also appear when a DV format digital video camera connected to the DV terminal is turned on.

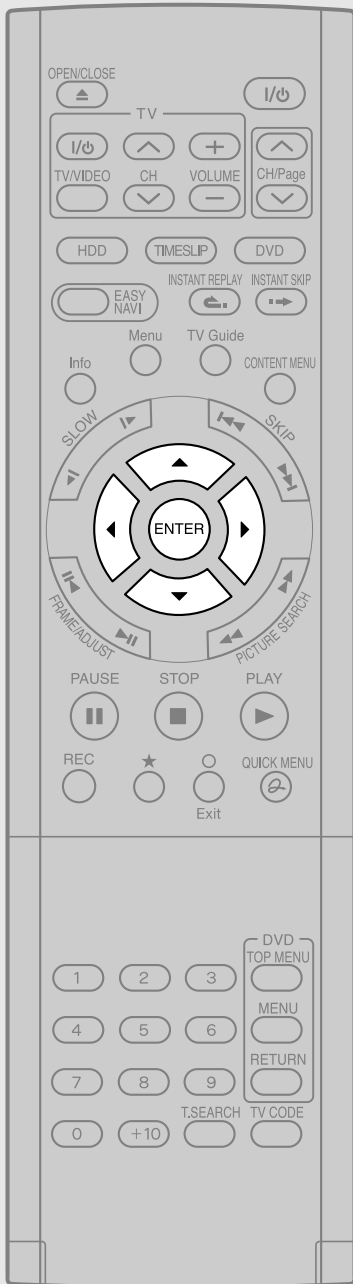

## 4 Press ▲/▼/◀/▶ to make the settings.

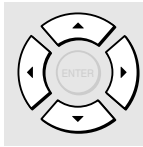

As you select each item, an explanation is provided.

To change the picture and sound rates:

- 1) Press ▲/▼ buttons to select “Change” then press ENTER button.
- 2) On the “User record quality” display, press ADJUST button to select a setting number.
- 3) Press ENTER button.

## 5 Press ▲/▼/◀/▶ to select “Next”, then press ENTER.

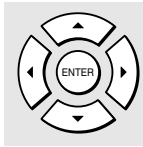

Details of the recording appears.

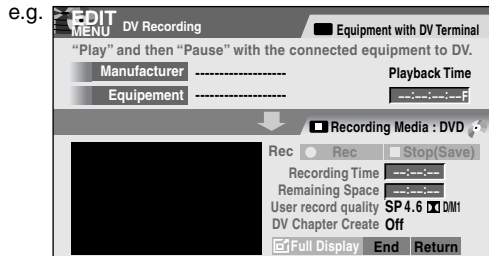

## 6 Play a connected DV format digital video camera and pause the playback at a desired scene.

## 7 Press ▲/▼/◀/▶ to select “Rec”, then press ENTER.

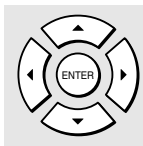

Recording starts.

- To pause the recording, select “Pause” by ▲/▼/◀/▶ buttons then press ENTER button.
- To stop the recording, select “Stop (Save)” by ▲/▼/◀/▶ buttons then press ENTER button.

#### Notes

- The DV terminal of this recorder supports only input from a DV format digital video camera. It cannot output to a connected device. Some models of DV format digital video cameras may be not compatible.
- At step 5, you can enlarge the video image by selecting “Full Display”, then pressing ENTER button.
- If “DV Chapter Create” is set to “Off” and you record onto a DVD-R/RW disc, chapters are automatically made according to “DVD-Video:CHP create” setting (➡ page 185). The number of chapters has the limit. Chapters are divided with a margin of about 0.5 second or less according to the DVD-Video standard.
- DV recording does not start in the following cases:
  - While recording or in the time slip mode.
  - While operating TV Guide On Screen, CONTENT MENU or LIBRARY MENU.
  - If the recorder’s clock is not set yet.
  - Within 2 minutes before programmed recording starts, or during programmed recording.
- If DV recording overlaps with programmed recording, the DV recording will stop 2 minutes before the programmed recording starts, and the programmed recording will be executed.
- DV recording does not work if the DV terminal is connected to equipment other than DV format digital video camera, such as a PC.
- Depending on the connected DV format digital video camera, the display at step 5 may not show “Manufacturer” or “Equipment”.
- If the DV terminal is connected to more than one DV format digital video camera, DV recording may not work properly. For proper functioning of DV recording, connect only one device to the DV terminal.
- DV recording is not compatible with Relay recording.
- Do not keep the DV terminal connected unless you record from a DV format digital video camera, as it may give influence on the recorder if operated.
- If you leave “EDIT MENU DV Recording” unoperated for about 15 minutes, it switches to the full mode if “Screen protector” (➡ page 181) is set to “On.”
- When you want to record both stereo 1 and stereo 2 sounds from a DV format digital video camera, additionally make a connection to the audio input jacks on this recorder using cables such as audio/video cables supplied with the DV format digital video camera. (➡ page 52)
- If a DV format digital video camera is not recognized, pull out the plug and connect it again.
- Some models of DV format digital video cameras may support a different compression format. From such equipment, recording is not possible.
- Depending on the models of DV format digital video cameras, recording may not work properly or some functions may be disabled.
- On an input source from a DV tape which is partly recorded over, chapters may not be made properly.

# Deleting recorded contents

## Important note

Any deleted title/chapter (original) cannot be restored. Before deleting, be sure to check contents on the disc.

On a finalized DVD-R/RW disc, this feature is not possible.

## To delete a title (chapter)

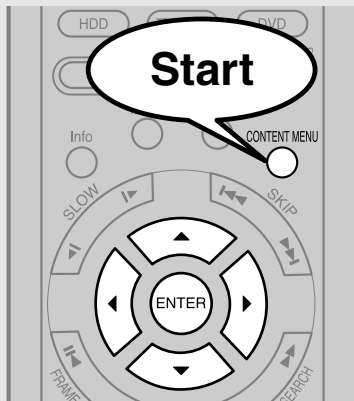

### 1 Press CONTENT MENU, then press ▲ / ▼ / ◀ / ▶ to select a title to delete.

To display chapters, press ★ button.

e.g.

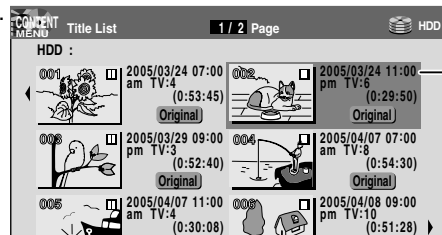

### 2 Press DELETE.

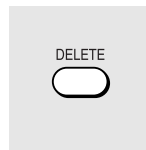

Alternate method:

Press QUICK MENU button, then press ▲ / ▼ buttons to select "Title delete" ("Chapter delete") and press ENTER button.

### 3 Read the message and press ◀ / ▶ to select "Yes," then press ENTER.

## Deleting multiple specified parts

- 1) Press HDD or DVD to select a disc that contains titles or chapters you want to delete.
- 2) Press EDIT MENU.
- 3) Press ▲ / ▼ to select "Del selected items," then press ENTER.  
"EDIT MENU Del Selected items" appears.
- 4) Select a part (a title or chapter) to delete.  
(To select a part, see ⇨ page 93 – 94.)
- 5) Press ▼ repeatedly to select "Start", then press ENTER.  
The recorder begins the deletion process.  
To cancel deleting, press ◀ / ▶ buttons to select "No", then press ENTER button.

## Notes

- Deleting a title (a chapter) decreases the numbers of the succeeding titles (chapters).
- A chapter for under 5 seconds or shorter may not be deleted. Deleting a short chapter may not change the display of the available disc volume.
- Deleting a playlist title/chapter does not affect the original title/chapter.
- Deleting an original title/chapter affects all the corresponding playlist title/chapters.
- Deleting all chapters in a title erases the title itself.
- Titles and chapters which contain still pictures cannot be deleted.
- On a DVD-R/RW disc, deleting is not possible if the disc is finalized (⇨ page 122).
- Chapters in a DVD-R/RW disc cannot be deleted.
- On a DVD-RW disc, only the last title recorded can restore the disc capacity by being deleted.
- On a DVD-R disc, deleting cannot restore the disc capacity.

# Others

## To protect recorded content

You can protect recorded contents of the HDD or a DVD-RAM disc from unexpected deletion. Protection is provided for each title (original).

- 1) Perform steps 1 and 2 in “Playing recorded contents (CONTENT MENU)” (➡ page 60) to select a title.
- 2) Press QUICK MENU button, and press ▲ / ▼ buttons to select “Title information”. Then press ENTER button.
- 3) Press QUICK MENU button, and press ▲ / ▼ buttons to select “Lock” and then press ENTER button.

The mark  appears.

### Notes

- To cancel protection, repeat this procedure.
- Disc initialization erases all titles on a disc even if they are protected.
- Executing “All HDD titles delete” (➡ page 186) erases all titles on the HDD even if they are protected.

## Relay recording HDD DVD-RAM

This function automatically diverts a recording to the HDD if a DVD-RAM disc is near capacity.

When the remaining time of the DVD-RAM disc has reached about 10 minutes, the recorder starts recording the same content on the HDD as well as DVD-RAM. The chapter marks are automatically made at the start and end points of the overlapped recording portion. You can delete the unnecessary overlapped portion afterwards by referring to the chapter marks.

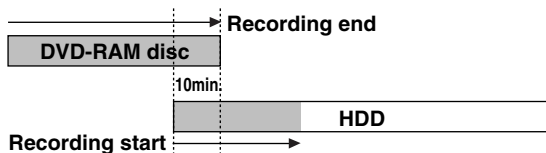

To engage the Relay Recording function, set “Relay recording” to “On” (➡ page 185).

### Notes

- When the capacity of the HDD is not sufficient, the operation is canceled.
- While recording the overlapped portion, you cannot pause the recording.
- While recording the overlapped portion, you cannot play a recorded title on the same disc.
- When another programmed recording is set just after the relay recording, the relay recording stops about 2 minutes before the next programmed recording starts.

## Technical Information

### ● About recording time

The recording time of a typical VCR (Video Cassette Recorder) is determined by the length of a video tape and recording speed (SP, LP, etc.). Video tapes with various recording times are available on the market. On the other hand, the recording time of a DVD-RAM/R/RW depends on the bit rate (Mbps: amount of data transmitted per second), which can be varied in MPEG2 (Moving Picture Experts Group2) compression technology.

As an example, when you pour water into a bucket from a faucet, the faster the water flows, the sooner the bucket is filled with water. On the other hand, the slower the water flows, the more slowly the bucket is filled. A DVD-RAM/R/RW is, so to speak, like a bucket, and the degree you turn the faucet is bit rate, the time required to fill the bucket with water is the recording time available for a disc. The higher you set the bit rate (making much more water flow), the sooner a disc is filled. Consequently, the recording time becomes shorter. The lower you set the bit rate, the longer time it takes to fill a disc.

### ● About picture quality (SP, LP, MN (Manual) mode)

The higher you set the bit rate, the more the volume of information for the picture. The lower the bit rate, the less the volume of picture information. However a high bit rate does not always mean that the picture quality is high. The difference between the 1.4 Mbps and 9.2 Mbps is obvious, but when comparing similar bit rates, the difference may be insignificant. Generally when you set the bit rate low for a longer recording, the data volume shortage will result in a lack of detail information. As a result, the picture quality is decreased (more noticeable with dynamically moving images). For example, square noises (block noise) may occur in a scene with fast action or a scene with light and shadows, such as a water surface.

This recorder has two settings, 2 hour recording at “SP” mode or 4 hour recording at “LP” mode (both assume a blank 4.7 GB DVD-RAM). It is recommended to consider the “SP” mode as a standard mode and use the “LP” mode when you want to record for long time regardless of the picture quality. When you want to record a music program or animation with high picture quality, it is recommended that you select the “MN” mode. If you select more than 6 Mbps, you can usually record with considerably higher picture quality. However the higher you set the bit rate, the shorter the recording time.



---

- **Dolby D /M1, Dolby D /M2**

Sound recording format onto DVD-RAM discs. When recording, sounds are converted into digital signals and compressed. In playback, they are extracted to the original sound. The standard differentiates Dolby D /M1 and Dolby D /M2 in data volume to use. Dolby D /M1 and Dolby D /M2 are applied the digital recording technology for consumer products of Dolby Laboratories. Dolby Digital 192 kbps is set for Dolby D /M1 and Dolby Digital 384 kbps for Dolby D /M2.

- **L-PCM (Linear PCM)**

Sound recording format, like Dolby Digital. However, sounds are converted into digital signals and recorded as they are without compression. This process requires more data than Dolby Digital.



# Playback

Play your favorite contents.

- **Playing recorded contents (CONTENT MENU)**
- **Playing a DVD video disc**
- **Other playback functions**

# Playing recorded contents (CONTENT MENU)

Titles and chapters recorded on the HDD or a DVD-RAM/R/RW disc are displayed in thumbnail view, so that you can easily locate a desired one.

You can play recorded TV programs also from TV Guide On Screen. See  page 25.

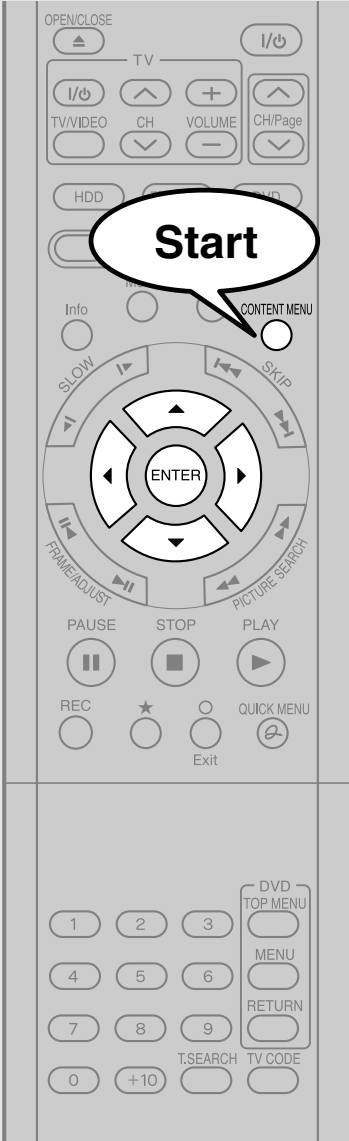

## 1 Press CONTENT MENU.

"CONTENT MENU Title List" appears.

e.g.

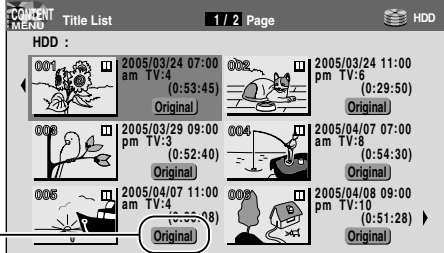

Attribution (original/playlist)

You can switch between HDD and DVD drives by pressing HDD or DVD button.

---

## 2 Press ▲ / ▼ / ◀ / ▶ to select a title (chapter).

You can view succeeding or prior pages by pressing PICTURE SEARCH (◀◀ / ▶▶) button.

To select a chapter, select a title and press ★ button. The Chapter List appears.





By pressing ★ button again, you can return to Title List.

---

## 3 Press ENTER.

Playback starts from a selected title (chapter).

### Notes

- On CONTENT MENU, titles (Original) precede titles (Playlist) in order from the oldest one respectively.
- To turn off CONTENT MENU, press CONTENT MENU button. Absence of operations for longer than about 15 minutes also turns off CONTENT MENU.
- The mark  is displayed in every thumbnail when "HDD/RAM title play" ( page 183) is set to "Title resume". When set to "Serial playback", it is displayed in a thumbnail last operated.
- You can change a thumbnail picture. See  page 126.
- You cannot display CONTENT MENU for DVD-R/RW discs recorded on other devices.
- For playing a recorded title while recording another, see  page 48.
- A black thumbnail with "Recording" means that the title is being recorded or its recording will start within 15 seconds. This thumbnail cannot start playback.

## ■ Reading CONTENT MENU

Each recorded content is displayed as its thumbnail.

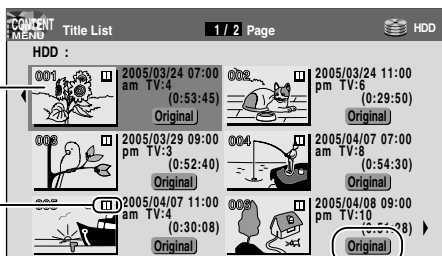

A recorded title is marked with "Original". A fictitious title created by editing is marked with "Playlist".

This shows that the recorder memorizes the location you last stopped playback in each title. To use this function, set "HDD/RAM title play" to "Title resume". (➡ page 183)  
You can make the recorder memorize only the very last point, regardless of the number of titles. Set "HDD/RAM title play" to "Serial playback". (➡ page 183)

Titles (Original) precede titles (Playlist) in order from the oldest one.

## ■ To stop playback

STOP



Press STOP.

## ■ To pause playback (still playback)

PAUSE



Press PAUSE.

To resume normal playback, press PLAY button or PAUSE button.

### Note

- Sound is muted in still mode.

## ■ To skip by 1/20 of whole

During playback, press ◀/▶.

Each time you press the button, you can skip by 1/20 of the current title or track if it is longer than 1 minute.

## ■ To skip the contents in pre-determined increments

During playback, press INSTANT SKIP.

Each time you press the button, you can skip by a specified time.

You can select the interval per press of the button. See "Instant skip interval" (➡ page 183).

## ■ To skip back in pre-determined increments

During playback, press INSTANT REPLAY.

Each time you press the button, you can go back by the specified time to resume playback.

You can select the interval per press of the button. See "Instant replay interval" (➡ page 183).

### Notes

- This operation may not work for some discs.
- Depending on the structure of a disc, some operations may be limited.
- Depending on playback conditions, some operations may not work.

## ■ Erasing content

1) On CONTENT MENU, select an unnecessary title (chapter).

2) Press QUICK MENU.

A Quick Menu appears.

3) Press ▲/▼/◀/▶ to select "Title delete".

e.g.

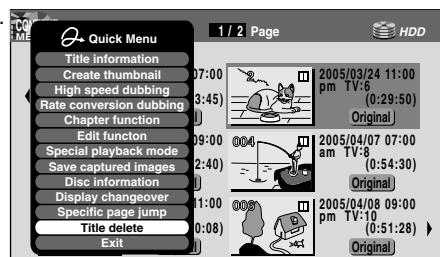

4) Press ENTER.

The confirmation message appears.

5) Press ◀/▶ to select "Yes" or "No" then press ENTER again.

**Playing at various speeds**

HDD DVD-RAM DVD-RW DVD-R DVD-VIDEO VCD CD

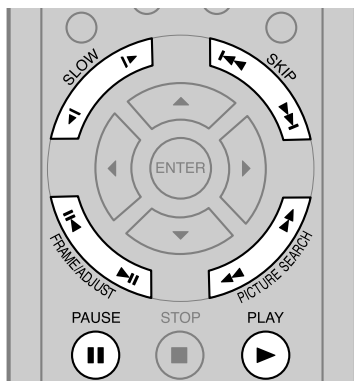

● **Playing in fast reverse or fast forward**

**During normal playback, press PICTURE SEARCH.**

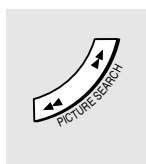

- ▶▶ : Fast forward playback
- ◀◀ : Fast reverse playback

Each time you press the button, the playback speed changes. During fast forward playback at “▶▶” speed, sound is reproduced. (Not available on VIDEO CD.)

- This function is not available when you play a title recorded on a DVD-RAM disc while recording another.

**Notes**

- The playback speed may vary depending on the disc.
- Depending on the disc or data condition, picture and sound in fast forward playback at “▶▶” speed may be disturbed.

● **Playing in slow-motion (Not available in CD playback)**

**Press SLOW during playback.**



- ▶▶ : Forward slow-motion
- ◀◀ : Reverse slow-motion

Each time you press the SLOW button, the slow-motion speed changes.

- **To resume normal playback**  
Press **PLAY**.

**Notes**

- Slow-motion does not provide smooth playback.
- When playing a VIDEO CD, reverse slow-motion playback is not available.
- The speed level displayed is approximate.

● **Playing frame by frame**

**1) During playback, press PAUSE.**

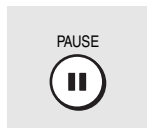

A still picture is displayed.

**2) Press FRAME (◀◀/▶▶).**



- ▶▶ : Playback direction
- ◀◀ : Opposite direction

- **To resume normal playback**  
Press **PLAY** or **PAUSE**.

**Notes**

- Sound is muted during frame by frame playback.
- Frame by frame playback cannot provide smooth playback.
- Frame may advance more than 1 frame at a time.
- Depending on scenes, some frames may not be played.
- When playing a VIDEO CD, reverse frame by frame playback is not available.

● **Skipping to the next/previous chapter or track**

**Press SKIP (◀◀/▶▶) repeatedly until the chapter or track number you want appears.**



Playback starts from the selected chapter or track.

- ▶▶ : Playback starts from the beginning of the next chapter or track.
- ◀◀ : Playback starts from the beginning of the current chapter or track. When you press twice, playback starts from the beginning of the previous chapter or track.

**Notes**

- Some titles may not display chapter numbers.
- When playing the HDD or a DVD-RAM disc, you can access chapters only in the current title if “HDD/RAM title play” (▶ page 183) is set to “Title resume”. To access chapters in other titles, set to “Serial playback”.
- When playing a DVD video disc or a DVD-R/RW disc, you can locate chapters only in the current title if “DVD title stop” (▶ page 178) is set to “On”. However, in this instance even though you press SKIP button (◀◀) to go back to the previous title, playback will not start from the last chapter of the title but from the first chapter.

● **Viewing still pictures** DVD-RAM DVD-VIDEO  
**(Playing a disc that contains still pictures)**

**1) Press PLAY.**



The first still picture on a disc is displayed.

Some DVD video discs may allow you to change the pictures using the PLAY, ENTER or SKIP button.

**2) Press FRAME (◀◀/▶▶).**



- ▶▶ : Displays the next still picture.
- ◀◀ : Displays the previous still picture.

## ■ Resuming playback from the location last stopped (Title resume)

The recorder memorizes the location you last stopped playback to resume from there.

To use this function, set "HDD/RAM title play" (➡ page 183) to "**Title resume.**" The recorder will memorize the location you last stopped at in each title, so you can resume playback from there. For example, if there are 6 titles, you can start each of them as if you had stored 6 video tapes in the recorder.

- **To return to the beginning of the title**  
During playback, press QUICK MENU button, then press ▲ / ▼ buttons to select "Restart title," then press ENTER button.
- **To play another title**  
Press CONTENT MENU button to display "CONTENT MENU Title List," then select a title.

You can make the recorder memorize only the very last point, regardless of the number of titles. Set "HDD/RAM title play" (➡ page 183) to "**Serial playback.**"

- **To return to the beginning of the title**  
Press SKIP (⏮) button repeatedly until the beginning of the title appears.
- **To play the other title**  
Press SKIP (⏮ / ⏭) button repeatedly.

### Notes

- Depending on conditions or contents, playback may not start from the location last stopped at, but instead another location. For example, from the beginning of the disc or title.
- Depending on a disc, there may be a slight difference between the location the recorder memorizes and the actual location where playback starts.
- This function is not available on DVD-R/RW discs.
- The resuming function will not work if the write-protect tab is set to "PROTECT" (➡ page 8).

## ■ Playing the digest (Skip Search)

This feature repeats playback of about 5 seconds and skip of 1 minute from the beginning to the end of a recorded title, so that you can view the digest of it.

- 1) **Perform steps 1 and 2 on ➡ page 60, and select a title that you want to view the digest.**
- 2) **Press QUICK MENU.**  
Quick Menu is displayed.
- 3) **Press ▲ / ▼ to select "Special playback mode", then press ENTER.**
- 4) **Press ▲ / ▼ to select "Skip search", then press ENTER.**  
The Skip Search starts.

### Notes

- This feature can be used for only one title (original) recorded on the HDD or a DVD-RAM disc.
- While using this feature, you cannot use speed-related functions such as fast forward or fast reverse.
- If you press ENTER button while using this feature, the normal playback starts.
- To cancel this feature, press STOP button twice.

## ■ Viewing the first scene of a title (Original) (Intro scan)

- 1) **After step 1 on ➡ page 60, press QUICK MENU.**  
Quick Menu appears.
- 2) **Press ▲ / ▼ to select "Special playback mode", then press ENTER.**
- 3) **Press ▲ / ▼ to select "Intro scan", then press ENTER.**  
The recorder plays the first 5 seconds of each title beginning from title 1.  
You can go forward or back by pressing SKIP buttons.  
▶▶ : to go to the next title.  
⏮ : to go back to the current title.  
Press twice to go back to the previous title.
- 4) **When you find a desired title, press ENTER.**  
The selected title is played.

### Notes

- To stop Intro Scan, press STOP button twice.
- This feature can be used for only titles (Original) recorded on the HDD or a DVD-RAM disc.

## ■ Playing all titles (original/playlist) in a disc

Set "HDD/RAM title play" (➡ page 183) to "Serial playback". You can play all titles in the HDD and DVD-RAM disc in the order of the thumbnails on CONTENT MENU, as if they were recorded in one video tape.

■ **Playing all titles (original) in a disc (Play All ORG Titles)**

You can play all Original titles in the HDD or a DVD-RAM disc in the order of the thumbnails on CONTENT MENU, as if they were recorded in one video tape.

- 1) Press **QUICK MENU**.  
Quick Menu appears.
- 2) Press **▲ / ▼** to select “Special playback mode”, then press **ENTER**.

e.g.

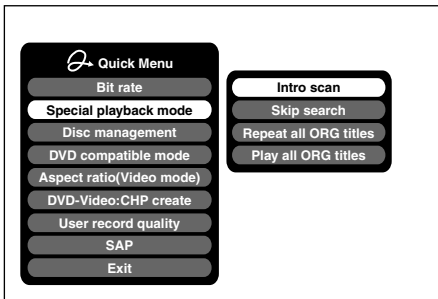

- 3) Press **▲ / ▼** to select “Play all ORG titles”, then press **ENTER**.

e.g.

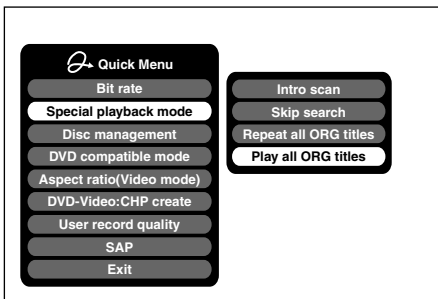

Playback starts from the beginning of title 1.

■ **Checking the background information on a selected title**

- 1) At step 2 on [page 60](#), select a title (chapter) then press **QUICK MENU**.  
Quick Menu appears.
- 2) Press **▲ / ▼** to select “Title information”, then press **ENTER**.  
Detail information of a selected title (chapter) appears. You can switch the chapters on the title by pressing PICTURE SEARCH (**◀◀ / ▶▶**) buttons.

**Notes**

- From Quick Menu on “CONTENT MENU Title Information”, you can change the details such as names, genres or dates which will help sorting and searching on Library system ([page 132](#)). Also you can protect the title from unexpected erasure ([page 56](#)).
- To return to the previous menu, press **O** button.
- To cancel the procedure, press **CONTENT MENU** button.

**Notes**

- To stop “Play all ORG titles”, press **STOP** button twice. (However, do this when you are playing a title recorded in the HDD or a DVD-RAM disc while recording ([page 48](#)) will stop the recording.)  
Alternatively, press **QUICK MENU** button to display the quick menu, and press **▲ / ▼** buttons to select “Cancel play all ORG titles” and press **ENTER** button.
- When the last title is complete, All ORG Title Play stops.
- If you select “Repeat all ORG titles” at step 3), “Play all ORG titles” repeats.
- This function is available only for titles recorded on HDD or DVD-RAM discs.



## ■ Changing the order of titles

You can change the order or sort the titles by genres.

- 1) **Press CONTENT MENU.**  
CONTENT MENU appears.
- 2) **Press QUICK MENU.**  
Quick Menu appears.
- 3) **Press ▲ / ▼ to select “Display changeover”, then press ENTER.**

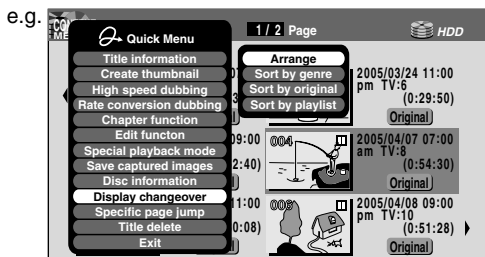

## ■ Jumping to a specified page

- 1) **Press CONTENT MENU.**  
CONTENT MENU appears.
- 2) **Press QUICK MENU.**  
Quick Menu appears.
- 3) **Press ▲ / ▼ to select “Specific page jump”, then press ENTER.**
- 4) **Enter the page number you want by pressing ADJUST, ▲ / ▼ or the number buttons.**

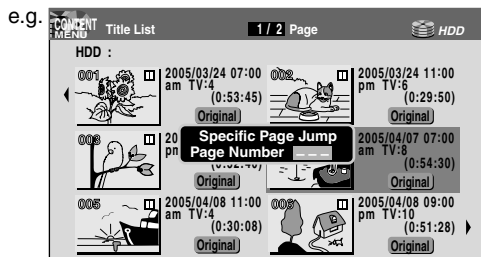

- 4) **Press ▲ / ▼ to select the item, then press ENTER.**

- **Arrange**  
Titles are rearranged along with the selected order.  
Press ▲ / ▼ buttons to select the order, then press ENTER button.
- **Sort by genre**  
Titles of the selected genre are sorted.  
Press ▲ / ▼ buttons to select the genre, then press ENTER button.
- **Sort by original**  
Titles (Original) are sorted.
- **Sort by playlist**  
Titles (Playlist) are sorted.

### Note

- To cancel, select “Display changeover” then “Cancel Arrange/Narrowing” from Quick Menu.

To clear the number, press CLEAR button.

- 5) **Press ENTER.**

The specified page appears.

### Notes

- Some disc's conditions or discs which contain copy once contents may not permit proper playback.
- “Title resume” (➡ page 183) is not available.

# Playing a DVD video disc

You can also play VIDEO CDs, audio CDs or finalization processed DVD-R discs in the same manner. To play recorded contents, follow the instructions on  page 60.

## ■ Preparation

- Turn on a TV or audio system and select the corresponding input source that the recorder is connected to.
- Load a disc you want to play. ( page 20)

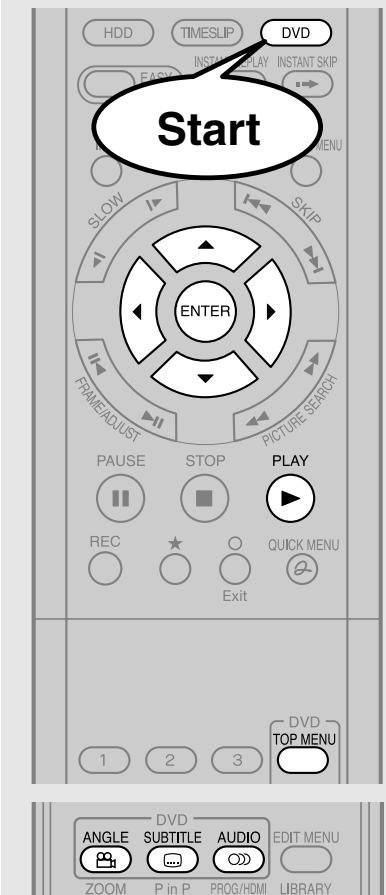

## 1 Press DVD.

The DVD indicator on the front panel will illuminate. This indicates that the recorder is ready to play a disc in the disc tray (DVD mode).



---

## 2 Press PLAY.

Playback starts.

- Depending on a disc, playback starts automatically by loading the disc.
- The recorder may take a short time to start playback. This occurs because the recorder is reading the data of a disc.







**Note**

- DVD video discs provide high resolution pictures and a lot of information. Because of this, you may notice some fine picture noises on TV screen, which you have never seen with regular broadcast TV program. While the amount of noise depends on the TV you use with the recorder, you should generally reduce the sharpness adjustment on your TV when viewing DVD video discs.

## Locating a title using the top menu DVD-RW DVD-R DVD-VIDEO

Some DVD video discs may include a top menu, on which you can view the structure of contents or select a scene. Most of the top menus automatically appear in certain scenes, and also are displayed on demand. Actual operation of the top menu depends on a disc. This section explains a general example of how to operate a top menu. Also refer to the instructions of the disc itself.

- 1) Press TOP MENU.
- 2) Press  /  /  /  to select the title you want.  
If the titles in the top menu are assigned a number, you can directly locate a specific title by pressing its designated number with the number buttons.
- 3) Press ENTER.

### Notes

- The instructions above describe basic procedures which may vary depending on the contents of a DVD video disc. If different instructions appear on the TV screen, follow those instructions.
- If you display the top menu during playback and press TOP MENU button again without selecting any title, the recorder may resume playback from the point where you first pressed TOP MENU button. (depending on the actual DVD video disc.)
- This method of locating a title is available only on a disc that contains a top menu.
- Instruction notes of discs may refer to the button that displays the top menu as TITLE button.

## ■ Resuming playback from the location last stopped at (Resume Play)

DVD-RW DVD-R DVD-VIDEO VCD CD

You can resume playback from the location where you stopped at.

If you press PLAY button after stopping playback, the playback resumes from the location you have stopped.

If you stop playback by pressing STOP button twice, the resume playback feature will be cancelled.

### Notes

- Resume feature cannot function when:
  - you select a disc menu language (➡ page 176) or change the parental lock setting (➡ page 177).
  - you play a PBC-featured VIDEO CD.
  - you open the disc tray.
- There may be a difference in the location where playback resumes depending on the disc.
- While the recorder retains a location in memory, initial setting changes may function only after the memory is cleared.

## ■ Selecting the sound

If a disc contains several languages, you can select a preferred language from them to hear.

### 1) During playback, press AUDIO.

Each time you press the button, output sound changes.

## ■ Selecting Subtitles

You can display subtitles on the TV screen and select a subtitle language from those included on the disc.

### 1) Press SUBTITLE during playback.

The current subtitle setting appears.

e.g.

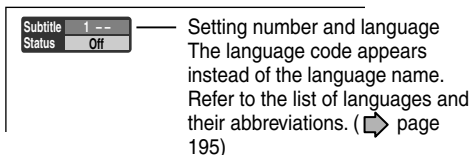

### 2) Press ▼ to select "Status," then press ADJUST to select "On."

Skip to step 3 if "On" is already displayed.

### 3) Press ▲ to select "Subtitle," then press ADJUST to select a language.

The subtitles of recorded languages appear.

### • To turn the subtitles on or off

At step 2, select "Off" by pressing ADJUST button.

### Notes

- Some DVD video discs are set to display subtitles automatically.
- Depending on the scene, subtitles may not appear immediately after you set the subtitle function to on.
- Some DVD video discs will allow you to change subtitle languages and turn subtitles on or off only via the disc menu.

## ■ Selecting the camera angle

If the scene was recorded with multiple angles, you can easily change the camera angle of the scene you are watching.

### 1) Press ANGLE while playing a scene recorded with multiple angles.

While playing a scene recorded with multiple angles, the angle icon appears on the TV screen and on the front panel. Press ANGLE button while the angle icon is displayed.

e.g.

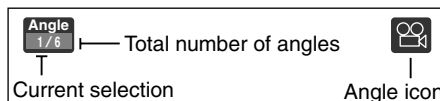

### 2) Press ADJUST while the angle number is displayed on the TV screen.

You can also select the camera angle by pressing ANGLE button several times.

- The angle icon disappears after about 3 seconds if no further selections are made.

### • To turn off the angle icon

Set "On screen display" in the setup menu to "Off" (➡ page 181).

Most of the on-screen display including the angle icon will not appear.

While the angle icon is flashing on the front panel display, you can change the camera angle.

### Notes

- You can also change the camera angle during still playback. The camera angle changes to the new setting when you resume normal playback.
- If you pause a picture immediately after changing a camera angle, the resumed playback picture may not display the new camera angle.
- Depending on a disc, the camera angle may not change even though the angle number changes.

# Other playback functions

## Pausing a TV broadcast to resume later (Pause TV) HDD

This function enables you to pause a TV broadcast and resume viewing at a later, more convenient time, by storing the TV broadcast temporarily on the HDD.

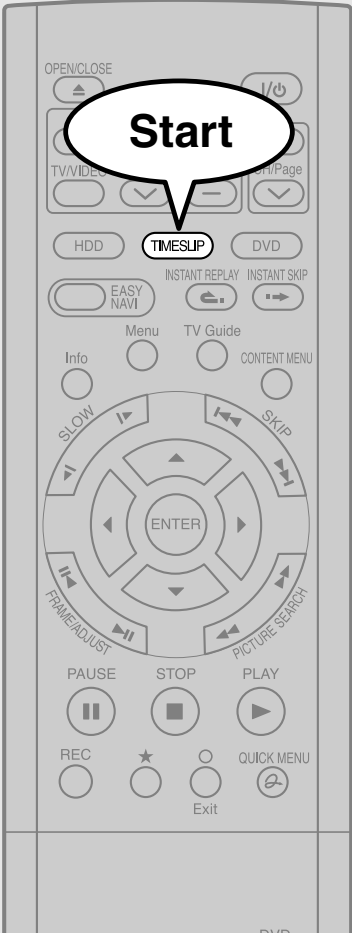

**1 While viewing a TV broadcast via this recorder or immediately before it starts, press TIMESLIP.**

**TIMESLIP** When pause TV mode is ready, playback starts automatically.  
The recorder begins to store the broadcast on the HDD the moment you press TIMESLIP button.

---

**2 Locate a scene you want by the following methods.**

**Fast-forward/fast-reverse:**  
Press PICTURE SEARCH button.

**Forward/reverse Slow-motion:**  
Press SLOW button.

**Forward/reverse frame by frame play:**  
First press PAUSE button then press FRAME button.

- To resume normal playback, press PLAY button.
- You can play in fast-forward to within 10 seconds prior to the current broadcast.

---

**3 Press TIMESLIP to exit this mode.**

**TIMESLIP** The recorder stops storing the broadcast on the HDD. A message appears and asks you whether you will save the stored data or erase it. Press ◀/▶ buttons to select, then press ENTER button.

### Notes

- This function is not available during recording.
- Pause TV recording stops when the HDD is filled up. It will not begin if the HDD has no remaining space.
- While using this pause TV recording, you cannot program a recording.
- Playback may jump a few seconds back or pause depending on the disc or data condition.

## Playing a TV program currently being recorded (Chase Play) HDD DVD-RAM

You can begin playback from the beginning of a program currently being recorded. You will find this function of great advantage on long programs, as you do not have to wait for the end of recording to begin playback.



**1** While recording a TV program on the HDD or a DVD-RAM disc, press **TIMESLIP**.

The recorder displays a TV program as it is being recorded.

**2** Go back to the beginning of the TV program using **SKIP**.

When you go back to the beginning, playback starts automatically.

You can confirm how far you are from the current broadcast by pressing **TIME BAR** button.

**3** Locate a scene you want through the following operations if necessary.

**Fast-forward/fast-reverse:**  
Press **PICTURE SEARCH** button.

**Forward/reverse Slow-motion:**  
Press **SLOW** buttons.

**Forward/reverse frame by frame play:**  
First press **PAUSE** button then press **FRAME** button.

- To resume normal playback, press **PLAY** button.
- You can play in fast-forward to within 10 seconds prior to the current broadcast.

**4** Press **TIMESLIP** to exit.

The current broadcast returns.

### Notes

- Time slip recording/playback stops when the capacity of a disc is filled up. You can play a location where the recorder stopped the recording. The time slip recording/playback cannot begin if the disc has no remaining space.
- The playback picture may appear after a delay of several seconds.
- The playback location will never follow up to the recorded location in the program. It will always trail the recorded location by a few seconds.
- While using time slip recording/playback, you cannot program recording.
- While **TIMESLIP** indicator is on, you cannot change the setting of the feature, which turns off the recorder after a programmed operation has finished.
- Even while "Auto power off" is selected, the recorder does not turn off if the recording end time comes during playback of a program being recorded.
- This function is not available on a DVD-RAM disc when "Relay recording" (▶ page 185) is set to "On."
- Playback may jump a few seconds back or pause depending on the disc or data condition.

Other playback functions (Continued)



### Zooming a picture

HDD DVD-RAM DVD-RW DVD-R DVD-VIDEO VCD

You can magnify areas within a picture.

**1) Press ZOOM.**

A zoom scope appears.

Zoom scope

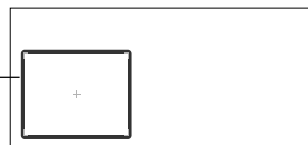

**2) Select a zoom point and magnification level.**

★ :

Raises the magnification level.

○ :

Lowers the magnification level.

▲ / ▼ / ◀ / ▶ :

Moves the zoom point. (only after the image has been magnified)

CLEAR :

Returns the zoom point to the center of the picture.

**Notes**

- Some discs may not respond to zoom feature.
- During some scenes, the buttons may not work as described.
- The zoom feature is canceled when the disc menu is operated.
- The magnification level varies depending on the picture size you select (➡ page 44, in "INSTALLATION GUIDE").
- The zoom feature is not available while displaying on the screen menu.
- The zoom feature is canceled when you stop playback or start playback.

**■ To cancel the zoom**

Press ZOOM.

### Watching a TV broadcast in the sub window (P in P playback)

HDD DVD-RAM DVD-RW DVD-R DVD-VIDEO VCD

During playback, you can watch a TV broadcast in the sub window. (P in P : Picture in Picture)

**1) During playback, press P in P.**

A sub window (program on the air or on the recording) appears.

**2) Press ▲ / ▼ / ◀ / ▶ to select the position of the sub window.**

You can shift the sub window in following 4 directions.

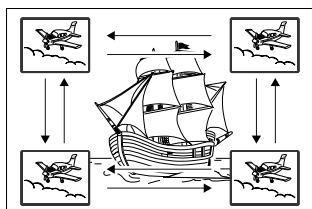

**Notes**

- You can change the channel of the sub window by pressing CH ▼ / ▲ button.
- The P in P function is available only during playback.
- You cannot swap the playback picture with the picture within the sub window, or change the audio settings.
- Press P in P button during "Chase Play" or "Pause TV", the actual broadcast appears on the sub window in real time.
- If this function is stopped after shifting the sub window, before you press P in P button again, the sub window will appear in the last position you set.

↑ / ↓ / ← / → is the moving range.

To turn off the sub window, press P in P button.

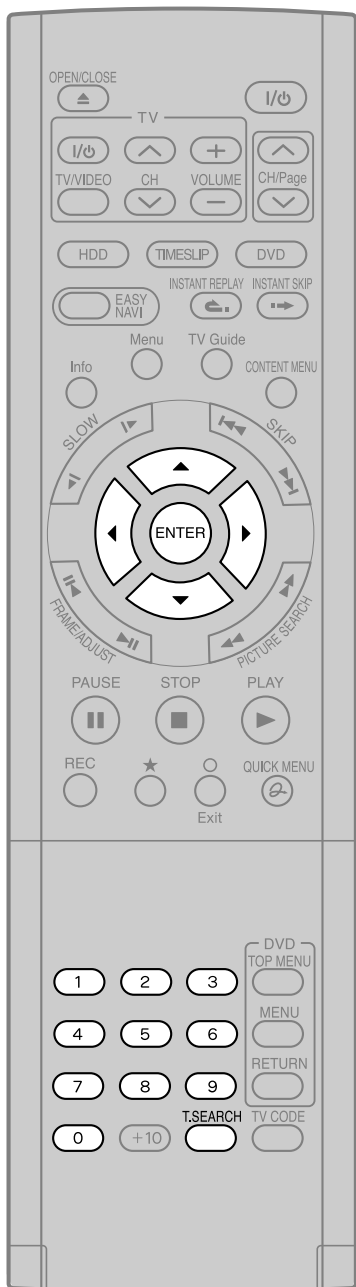

## Locating by entering the number of a desired section

HDD DVD-RAM DVD-RW DVD-R DVD-VIDEO VCD CD

Normally titles, chapters, and tracks are numbered. By entering these numbers, you can access a desired section.

### 1) Press T.SEARCH.

e.g.



If you are using a VIDEO CD/audio CD, skip step 2.

### 2) Press ▲ / ▼ to select a section (title or chapter) you want to locate.

e.g.



When you want to locate a chapter.

### 3) Press the number buttons to enter a number of the section.

e.g. To enter 25, press “2”, then press “5”.

### 4) Press ENTER.

#### Notes

- Pressing CLEAR button resets the numbers. To clear the display, press T.SEARCH button several times (depending on a disc).
- This method of locating a title is available only on a disc that contains title numbers.
- If a title is erased, the numbers of the following titles decrease respectively.
- When you record a new title (Original) on the HDD or a DVD-RAM disc, it is added prior to current titles (Playlist), and each following title (Playlist) reference number will advance by a factor of 1.

## Locating a specific point by entering its elapsed time (Time Search)

HDD DVD-RAM DVD-RW DVD-R DVD-VIDEO VCD CD

### 1) Press T.SEARCH.

You may have to press repeatedly, depending on a disc. Press the button until the following display appears.

e.g.

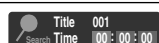

### 2) Press the number buttons and ◀ / ▶ to enter the desired time location on the disc.

e.g. To enter 1 hour, 25 minutes, and 30 seconds

“0” → “1” → ▶ → “2” → “5” → ▶ → “3” → “0”  
hour minute second

### 3) Press ENTER.

#### Notes

- Some discs may not respond to this process.
- Some scenes may not be accessed precisely as you specified.
- This method for accessing specific locations is available only within the current title of the HDD or a DVD-RAM/R/RW/DVD video disc or within a current track of a VIDEO CD/audio CD.
- Pressing CLEAR button resets the numbers.

**Selecting the sound** HDD DVD-RAM DVD-RW DVD-R DVD-VIDEO VCD

You can select a preferred language and a sound format.

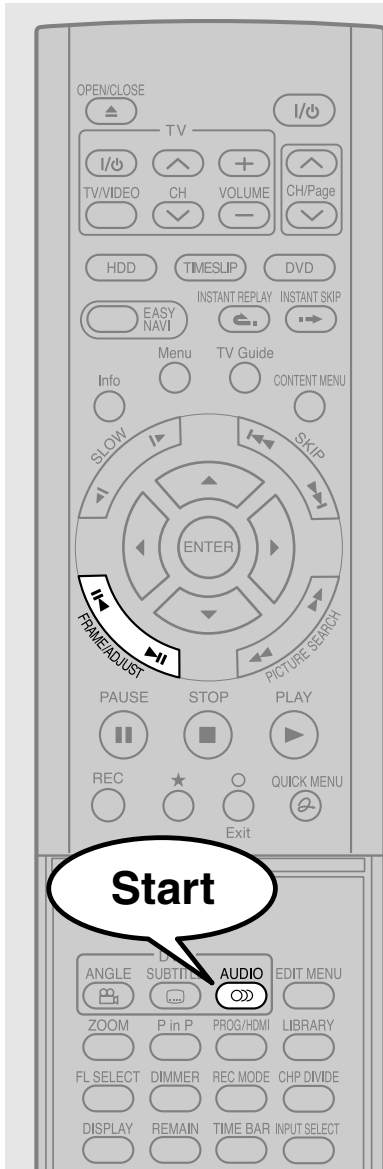

**1 Press AUDIO during playback or while receiving a broadcast.**

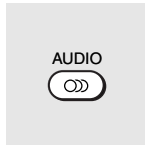

The current audio setting appears.

The language code appears instead of the language name. Refer to the list of languages and their abbreviations. (➡ page 195)

**2 Press ADJUST while the audio setting is displayed on the TV screen.**

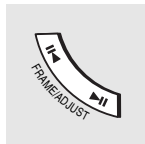

Variation of channels depends on the disc or the type of TV broadcast.

- HDD DVD-RAM, TV channel signals

Stereo sound

- "Stereo" (left channel and right channel)
- "Stereo L" (left channel)
- "Stereo R" (right channel)
- (→ Back to "Stereo")

SAP sound

- "Main" → "SAP" → "Main + SAP" (→ Back to "Main")

- DVD-R DVD-VIDEO

Language name / sound recording system / No. of channels

e.g.



- VCD

- "Stereo" → "Stereo L" → "Stereo R" (→ Back to "Stereo")

The display turns off if you do not operate for more than 3 seconds.

If you press ▲ / ▼ buttons to select "Output," you can select the audio output setting (➡ page 180) by using ADJUST buttons.

■ **MTS Broadcast Compatibility**

This recorder can receive or record MTS (Multichannel TV sound) broadcast. By connecting the recorder to your stereo system or stereo TV, you will try the SAP or stereo sound.

**SAP (Second Audio Program broadcast)**

A separate audio program, usually broadcast in a second language with the main language.

**Sounds in playback**

You can play SAP and/or stereo broadcasts with this recorder. Refer to steps 1 and 2 to select a desired audio.

Desired sound	Sound output
SAP sound	SAP
Stereo sound	Stereo Sound



## Notes

- Some discs allow you to change audio selections only via the disc menu. If this is the case, press MENU button and choose the appropriate language from the selections on the disc menu.
- When you turn on the recorder or replace a disc, the recorder returns to the initial default setting. (➡ page 176)  
Depending on a disc, a specific type of audio the disc has is output.
- Immediately after you have switched sounds, there may be a temporary discrepancy between the display and actual sound.
- The BITSTREAM/PCM jack may not output SAP sound you select. In this instance, set "Audio out select" to "PCM". (➡ page 180)
- You cannot change SAP sound if recorded with "DVD compatible mode" (➡ page 184) set to "Main". Even when "DVD compatible mode" (➡ page 184) is set to "Off," the recorder regards it as "Main" when recording to a DVD-R/RW disc.

## Recorded sounds

According to your setting of "SAP" on the setup menu screen, (➡ page 180), the sound is recorded onto different channels of the disc below. Set "SAP" to "On" or "Off" appropriately.

Setting on the setup screen		Type of receiving broadcast	Contents of recorded sound		Type of record
DVD Compatible Mode	SAP		Lch	Rch	
Off	Off	Stereo + SAP	L	R	Stereo
		Mono + SAP	Mono	Mono	Stereo
		Stereo	L	R	Stereo
		Mono	Mono	Mono	Stereo
	On	Stereo + SAP	L + R	SAP	Dual Mono*
		Mono + SAP	Mono	SAP	Dual Mono*
		Stereo	L	R	Stereo
		Mono	Mono	Mono	Stereo
Main	Off	Stereo + SAP	L	R	Stereo
		Mono + SAP	Mono	Mono	Stereo
		Stereo	L	R	Stereo
		Mono	Mono	Mono	Stereo
	On	Stereo + SAP	L + R	L + R	Stereo
		Mono + SAP	Mono	Mono	Stereo
		Stereo	L	R	Stereo
		Mono	Mono	Mono	Stereo
SAP	Off	Stereo + SAP	L	R	Stereo
		Mono + SAP	Mono	Mono	Stereo
		Stereo	L	R	Stereo
		Mono	Mono	Mono	Stereo
	On	Stereo + SAP	SAP	SAP	Stereo
		Mono + SAP	SAP	SAP	Stereo
		Stereo	L	R	Stereo
		Mono	Mono	Mono	Stereo

\* This will be "Stereo" when a recording is made with "L-PCM" selected.

## Viewing JPEG files

You can play JPEG files that have been recorded on a CD-R or CD-ROM on the recorder.

### ■ Preparations

- Prepare a compatible disc (➔ page 75) that contains JPEG files you want to view.
- Set "Priority contents" (➔ page 183) to "Photo".
- Make your TV shape conform to the 4:3 picture size. Only 4:3 pictures can be played regardless of the function settings via the on-screen displays of the recorder (➔ page 44, "INSTALLATION GUIDE"). If the TV is adjusted to other sizes, e.g. "WIDE," images will appear to be horizontally expanded. For details, refer to the owner's manual of your TV.



**1 Press DVD.**



---

**2 Load a CD that contains JPEG files.**



Each photo appears for about 3 seconds (slide show).  
If a slide show does not start, press PLAY button.

Depending on the disc, "CONTENT MENU Picture List" appears. See "On "CONTENT MENU Picture List"" (➔ page 75) to operate.

### Notes

- Some files may not display their own entire images depending on the size.
- JPEG picture playback is not available during recording on the HDD.
- Operation to JPEG file will be disabled at about 2 minutes before a programmed recording starts.

### ■ To stop playback (slide show)

Press **STOP**.

If you press **PLAY** button after pressing **STOP** button, playback will start from the photo you stopped at.

### ■ To pause playback (slide show)

Press **PAUSE**.

To resume, press **PAUSE** button again or press **PLAY** button.

### ■ To skip photos

During playback, press **SKIP** button repeatedly.

▶▶: To skip forward.

◀◀: To skip backward.

### ■ To rotate a picture

Press **ANGLE** repeatedly.

Each time you press the button, the picture rotates by 90° degree.

#### Note

- The rotated image is displayed after its original posture appears momentarily.

### ■ To magnify a picture

Follow the procedure on ➔ page 70.

#### Notes

- The magnified image is displayed after its original posture appears momentarily.
- For small pictures, the reduction level may be limited.

## ■ Viewing a specified photo (single view)

Full screen still view.  
2 ways are available:

### ● On “CONTENT MENU Picture List”

#### 1) Press CONTENT MENU.

“CONTENT MENU Picture List” appears.

Depending on the disc, the recorder creates either temporary folder, “Auto” or “All”.

“Auto”: For CD of which compatibility confirmed by TOSHIBA. Only playable files are listed.

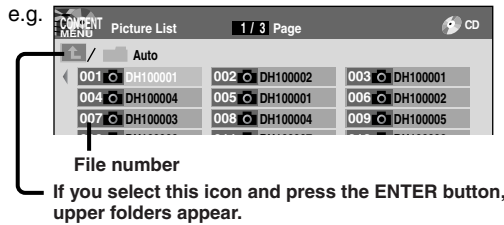

“All”: For CD other than above. All files are listed.

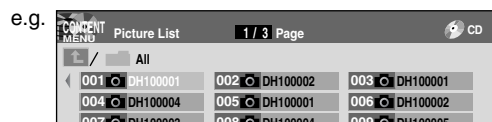

• Some CDs may not comply with the above.

#### 2) Press ▲/▼/◀/▶ to select a folder or photo.

Pressing PICTURE SEARCH (◀▶) button turns the pages.

If you press ★ button, the list changes to thumbnail view (“CONTENT MENU Pictures”).

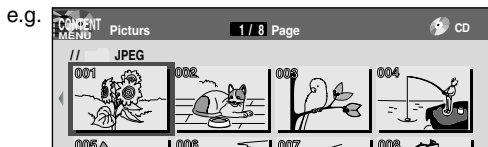

Pressing ANGLE button rotates the picture. The rotation of pictures is kept until the CD is ejected.

To return to the previous list, press ★ button again.

#### 3) Press ENTER.

If you select a folder at step 2), repeat steps 2) and 3) until your favorite file appears.

The selected photo appears in full screen.

### Notes

- “CONTENT MENU Picture List” cannot show all the files in a disc, but only ones regarded as objects of regular play of the disc.
- The larger the file size is, the longer the thumbnail takes time to appear.
- Letters of a file/folder name overflowing the given space are not displayed.

### ● Direct input of a photo number

#### 1) Press T.SEARCH.

An input window appears.

e.g.



#### 2) Input a photo number using the number buttons or ADJUST.

#### 3) Press ENTER.

The selected photo appears in full screen.

### ■ To change the playback order

#### 1) Press QUICK MENU.

#### 2) Press ▲/▼ to select an item, then press ENTER.

To shift the cursor, press ▲/▼ buttons.

- Reverse** : To reverse the order.
- Repeat** : To repeat the current folder.

#### 3) Press ENTER.

Playback in the selected mode starts.

### ● JPEG files compatibility

Discs whose compatibility with this recorder has been confirmed by TOSHIBA are as follows.

CANON QuickCD  
FUJICOLOR CD  
Kodak Picture CD  
NORITSU QSS CD

JPEG disc compatibility with this recorder is limited as follows:

- Playable discs:
  - CD-ROM, CD-R
  - CD-RW is not recommendable.
- CD physical format:
  - Mode 1, Mode 2 XA Form 1
- File system:
  - ISO9660 Level 1, 2 or Joliet
- File name:
  - A file name should be in alphabet and numerals only, and must incorporate “JPG” extension.
  - e.g. “\*\*\*\*\*.JPG”
- Total number of folders:
  - Less than 256
- Total number of files:
  - Less than 1000

Some files may not display their own entire image depending on the size.

Some discs may not permit this operation. Especially, the following conditions of included files will increase the disc’s disability.

1. Pixels over 5000 x 5000 in height and/or width
2. File format except Exif

## Playing MP3/WMA files

You can play MP3/WMA files that have been recorded on a CD-R or CD-ROM on this recorder.

### ■ Preparations

- Make sure that a disc you want to play is compatible with this recorder. See ➡ page 77.
- Set “Priority contents” (➡ page 183) to “Audio”.

**1 Press DVD.**

**2 Load a CD that contains MP3/WMA files.**

Playback starts from the first track of a current folder.

### Notes

- WMA tracks copy-protected cannot be played.
- The DIGITAL AUDIO OUT BITSTREAM/PCM jack outputs MP3/WMA sounds in the linear PCM format regardless of the current “Audio out select” (➡ page 180) selection.
- You cannot change the playback speed of MP3/WMA playback.

### ■ To stop playback

Press **STOP**.

If you press **PLAY** button after pressing **STOP** button, playback will start from the beginning of the track.

### ■ To pause playback

Press **PAUSE**.

To resume, press **PAUSE** button again or press **PLAY** button.

### ■ To skip tracks

During playback, press **SKIP** repeatedly.

▶▶ : To skip forward.

◀◀ : To skip backward.

### ■ Selecting a track in the disc

2 ways are available:

### On “CONTENT MENU Audio List”

#### 1) Press **CONTENT MENU** button.

“CONTENT MENU Audio List” appears.

e.g.

Current folder

001	MP3_0001	002	MP3_0002	003	MP3_0003
004	MP3_0004	005	MP3_0005	006	MP3_0006
007	MP3_0007	008	MP3_0008	009	MP3_0009

File number

If you select this icon and press **ENTER** button, upper folders appear.

e.g.

Disc name

The recorder creates temporary folder “All”, which contains all playable files.

## 2) Press ▲ / ▼ / ◀ / ▶ to select a track or folder.

Pressing PICTURE SEARCH (◀◀ / ▶▶) button turns the pages.

## 3) Press ENTER.

If you select a folder at step 2), repeat steps 2) and 3) until your favorite file appears.

### Notes

- “CONTENT MENU Audio List” cannot show all the tracks in a disc, but only ones regarded as objects of proper play of the disc.
- Letters of a file/folder name overflowing the given space are not displayed.

### Direct input of a track number

#### 1) Press T.SEARCH.

An input window appears.

e.g.

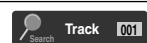

#### 2) Input a track number using the number buttons or ADJUST button.

#### 3) Press ENTER.

### ■ To change the playback order

#### 1) Press QUICK MENU.

#### 2) Press ▲ / ▼ to select “Special playback mode”, then press ENTER.

e.g.

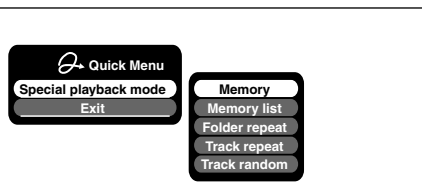

#### 3) Press ▲ / ▼ to select an item, then press ENTER.

**Memory list** : To play favorite tracks only in a favorite order.

Input a track number by using the number buttons or ADJUST button.

To shift the cursor, press ▲ / ▼ buttons.

**Folder repeat** : To repeat the current folder.

**Track repeat** : To repeat the current file.

**Track random** : To play files in the current folder in a random order.

### Note

- To cancel these modes, stop the playback or select the cancel command from Quick Menu.

## ● Playable files

MP3/WMA disc compatibility with this recorder is limited as follows:

- Playable discs:
  - CD-ROM, CD-R
  - CD-RW is not recommendable.
- Sampling Frequency / Bitrate:
  - WMA: 32 kHz / 48 kbps (CBR), VBR  
44.1 kHz / 48-192 kbps (CBR), VBR  
48 kHz / 128-192 kbps (CBR), VBR
  - MP3: 8 kHz, 11.025 kHz, 12kHz, 16 kHz,  
22.05 kHz, 24 kHz / 8-160 kbps (CBR), VBR  
32 kHz, 44.1 kHz, 48 kHz / 32-320 kbps (CBR), VBR
- CD physical format:
  - Mode 1, Mode 2 XA Form 1
- File system:
  - ISO9660 Level 1, 2 or Joliet
- File name:
  - A file name should be in alphabet and numerals only, and must incorporate “MP3” or “WMA” extension.
  - e.g. “\*\*\*\*\*.MP3”, “\*\*\*\*\*.WMA”
- Total number of folders:
  - Less than 256
- Total number of files:
  - Less than 1000
- WMA codec version:
  - V7, V8, V9

\* This recorder supports ID3v2 (ID3 Tag Version 2) of MP3, to display text data such as names of title and artist. Some characters may be displayed properly.

This recorder requires discs/recordings to meet certain technical standards in order to achieve optimal playback quality. Pre-recorded DVDs are automatically set to these standards. There are many different types of recordable disc formats (including CD-R containing MP3/WMA files). Because this area of technology is still evolving, Toshiba cannot guarantee that all recordable discs will produce optimal playback quality. The technical criteria set forth in this owner’s manual are meant only as a guide.

Please be advised that you must obtain permission from the applicable copyright owners to download copyrighted content, including music files, in any format, including the MP3 and WMA formats, prior to the downloading thereof. Toshiba has no right to grant and does not grant permission to download any copyrighted content.

Microsoft, Windows Media, and the Windows Logo are trademarks or registered trademarks of Microsoft Corporation in both the United States and other countries.



**Checking the current status and settings**

HDD DVD-RAM DVD-RW DVD-R DVD-VIDEO VCD CD

You can confirm operational status and setting details.

● **Operational status and setting details**



**1 Press DISPLAY.**

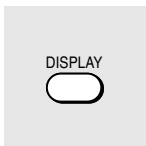

The following on-screen display appears. (The actual display varies depending on the disc.)

e.g. while playing the HDD

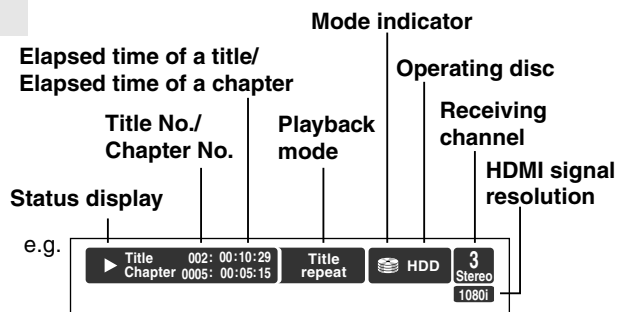

**2 Press DISPLAY again.**

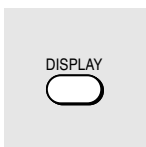

An expanded display appears. (Actual display varies depending on the disc.)

e.g.

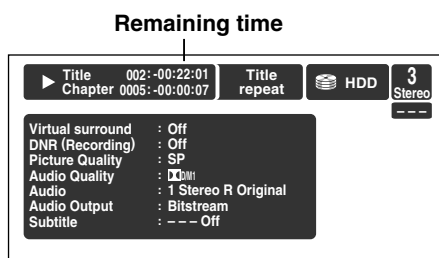

**3 Press DISPLAY again to turn the display off.**

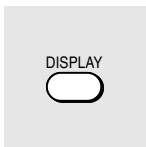

## ● Using the time bar

The time bar shows the current progress in playback or recording.

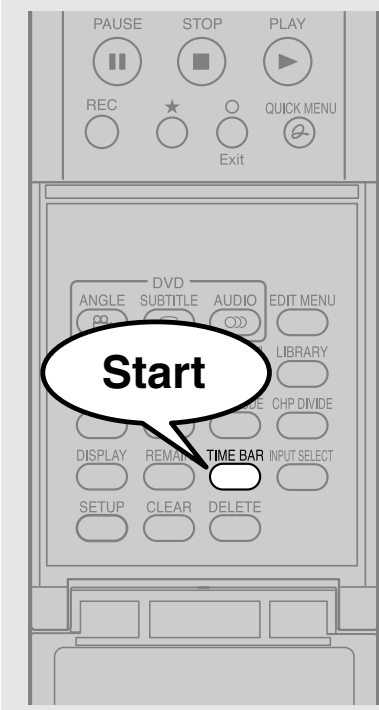

### 1 During playback or recording, press TIME BAR.

The time bar appears. (The actual display varies depending on the disc.)

**e.g. Playback**

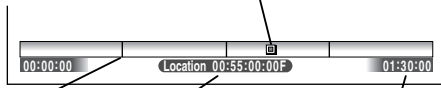

Locator (Shows the current location.)

Chapter division

Elapsed time

Total playing time of a current title  
(In the case of a VIDEO CD or audio CD, it shows the total playing time of the disc.)

**e.g. Recording**



Locator (Shows the current location.)

Elapsed time

Elapsed recording time (per 30 minutes)  
(Recording end time if it comes within 30 minutes.)

### Note

- Time display is an approximation.

### ■ Changing the location of the time bar

While the time bar is displayed, press ▲ / ▼.  
The time bar shifts up and down.

### ■ Turning off the time bar

Press TIME BAR.

## Functions in Quick Menu

Besides these examples, various other ones are introduced on respective pages for your convenience. See  page 30 on how to operate Quick Menu.

### ■ To play repeatedly (Repeat playback)

HDD DVD-RAM DVD-RW DVD-R DVD-VIDEO VCD CD

You can repeat a desired section.

- 1) During playback, press **QUICK MENU**.
- 2) Press **▲ / ▼** to select “Special playback mode”, then press **ENTER**.

#### Special playback mode

The sub menu appears. Select the next item by pressing **▲ / ▼** buttons and **ENTER** button.

#### Repeat all ORG titles

To repeat all original titles in a disc.

#### Title repeat

To repeat the same title.

#### Chapter repeat

To repeat the same chapter.

#### A-B repeat

You can designate a portion in a title or track to repeat continuously.

If you select “A-B repeat” and press **ENTER** button, the following display appears. Perform steps 1 and 2 below.

e.g.



To cancel the procedure, press **O** button.

- 1) Press **ENTER** at the beginning of the segment (point A) you want to repeat.

The location of point A is memorized.  
The display changes to “Set B”.

- 2) Press **ENTER** at the end of the segment (point B).

The location of point B is memorized, and repeat playback begins between point A and B.

#### Track repeat

To repeat the same track.

#### Disc repeat

To repeat the entire disc.

#### Repeat all PL titles

To repeat all playlist titles in a disc.

#### Cancel repeat

(in Repeat playback mode)

To resume normal playback.

Playback of the HDD or a DVD-RAM disc stops.

#### Notes

- Some discs may not permit repeat operation.
- You cannot use the repeat playback function in conjunction with the random playback function.
- If you press **STOP** button during repeat playback, this operation is canceled.
- While you are performing repeat playback on the HDD or a DVD-RAM disc, other operations ( page 62) except stopping this operation are not available.

### ■ To play in random order (Random play)

DVD-RW DVD-R DVD-VIDEO VCD CD

You can play sections in random order.

- 1) Press **QUICK MENU**.
- 2) Press **▲ / ▼** to select “Special playback mode”, then press **ENTER**.

#### Special playback mode

The sub menu appears. Select the next item by pressing **▲ / ▼** buttons and **ENTER** button.

#### Title random

Plays all titles in a loaded disc in random order. Each title is played beginning from chapter 1.

#### Chapter random

Plays all chapters in a current title in random order.

#### Track random

Plays all tracks on a loaded disc in random order.



**Cancel random** (in Random play mode)

Resumes normal playback.

**Notes**

- Some discs may not permit random playback operation.
- You cannot use the random playback function in conjunction with the memory playback function.
- You cannot use the random playback function in conjunction with the repeat playback function.
- Pressing STOP button during operation cancels random playback.

**To play in favorite order (Memory playback)**

DVD-RW | DVD-R | DVD-VIDEO | VCD | CD

You can select 30 titles, chapters, or tracks and play them in favorite order.

(To play contents in the HDD or a DVD-RAM disc in favorite order, make a playlist. For details, see "Editing" on  page 84.)

**1) Press QUICK MENU.****2) Press ▲ / ▼ to select "Special playback mode", then press ENTER.****Special playback mode**

The sub menu appears. Select the next item by pressing ▲ / ▼ buttons and ENTER button.

**Memory list**

If you select this and press ENTER button, the following display appears. Perform the steps below.

e.g.

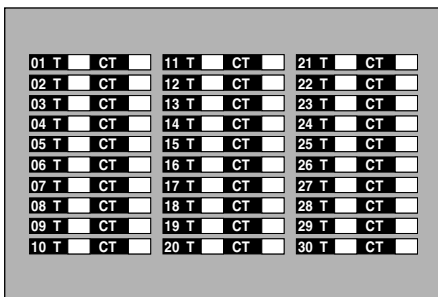
**1) Input numbers of titles, chapters, or tracks by using the number buttons, in favorite order.**

Input each 3-digit number.

To input a 1- or 2-digit number, first input 0.

(e.g. "0", "0", "3".)

To cancel the numbers, press CLEAR button.

To input a chapter number, press ◀ / ▶ buttons to shift the cursor.

**2) Press ▲ / ▼ to select the next box, then perform step 1).**

To select another chapter in the same title, you do not need to select the title number.

Repeat these steps if necessary.

You can program up to 30 selections into memory.

**3) Press ENTER.**

Memory playback starts.

**Memory** (in normal playback mode)

To display an entry box for one program selection.

**Memory release** (in memory playback mode)

To resume normal playback.

**Memory repeat** (in memory playback mode)

To repeat a current memory playback.

**Notes**

- Some discs may not permit memory playback operation.
- Inputting numbers of titles, chapters or tracks that a disc does not contain will result in error.
- You cannot program/change selections during memory playback. To change selections, cancel memory playback by pressing STOP button.
- When you disconnect the power cord, the selected memory is erased.
- You can exit the memory playback display by pressing O button.

**To display the current bit rate**

HDD | DVD-RAM | DVD-RW | DVD-R | DVD-VIDEO

**1) During playback, press QUICK MENU.****2) Press ▲ / ▼ to select "Bit rate", then press ENTER.****Bit rate****Note**

- To turn off the bit rate display, select this item again.

**To check information on a title**

HDD | DVD-RAM | DVD-RW | DVD-R

**1) During playback, press QUICK MENU.****2) Press ▲ / ▼ to select "Title information", then press ENTER.****Title information****To exit Quick Menu**

HDD | DVD-RAM | DVD-RW | DVD-R | DVD-VIDEO | VCD | CD

Press QUICK MENU again.

or

Press ▲ / ▼ to select "Exit", then press ENTER.

**Exit**



# Editing

You can create your own movie from your assembled scenes. Save your favorite videos in DVD discs.

- **Creating your own title**
- **Creating a DVD-Video using DVD-R/RW**
- **DVD-Video finalizing process**
- **Other editing functions**

# Creating your own title

You can edit recorded contents and create your own library.

## Note on deleting unnecessary scenes

It is not recommended that you delete many chapters from titles recorded on the HDD to remove unnecessary parts of the titles and copy those contents on a DVD-RAM disc. The reason is that discontinuous space inside the HDD expands and recorded contents are stored in gaps between used locations. Operating this repeatedly makes a recording area inside the HDD broken down into small and complicated spaces. (It is called fragmentation.) Even normal operations may get slow. Moreover, available space may not be restored by deleting or the HDD may have protection disabling playback or recording.

When you want to delete unnecessary parts from titles, collect necessary parts of chapters to make a playlist. Then copy the playlist and delete the original title or the playlist. For example, make a playlist and copy it to a DVD-RAM. Then delete original titles on the HDD. It can save time and effort and retain continuity in the HDD space. However, when moving a copy once program from the HDD to a DVD-RAM disc, delete unnecessary chapters from original titles. For details (➡ page 98).

Running "All HDD titles delete" regularly prevents fragmentation from occurring.

In addition, if you select and run "HDD format", all data on the HDD will be erased. Copy TV programs you want to save recorded on the HDD from the HDD to a DVD-RAM or DVD-R/RW disc.

When it comes to library data, back it up to a DVD-RAM disc before initializing the HDD. Then rewrite the data on the HDD.

## Editing procedure

- 1: Changing a name of a recorded title** (➡ page 86)
  - 2: Dividing a recorded title into several chapters** (➡ page 87)
  - 3: Collecting necessary chapters** (➡ page 92)
  - 4: Dubbing to save** (➡ page 97)  
To save in DVD-R/RW for distribution, see ➡ page 112.
- **Other editing functions**
    - Changing the picture on CONTENT MENU** (➡ page 126)
    - Combining two titles (Original) into one** (➡ page 128)

## Basic flow

### ● Recording a TV program

Record a TV program and it becomes an original title.



e.g.  
Title: The world of cats and dogs.

### ● Chapter editing

Divide the original title into chapters.

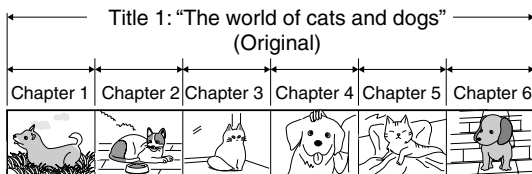

Divide chapters and create divisions of chapter

- You can play desired scenes from the top by "Chapter Divide".
- Divide chapters to edit a playlist.

### ● Playlist editing

Collect your favorite chapters to make them as one title. (Playlist)  
If an original title is deleted, a playlist will be also deleted because playlists are fictitious titles.

e.g. Making a playlist by collecting scenes of cats from title 1 "The world of cats and dogs".

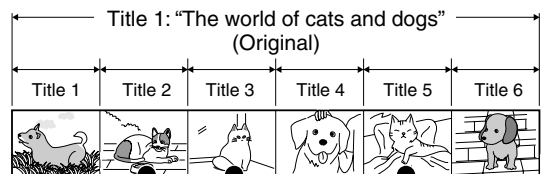

Playlist Editing



A fictitious playlist title that is different from the original title is created.

### ● Dubbing

Copy the playlist and it becomes an original title.

Using these editing functions to modify copyrighted content for any purpose other than your private viewing may be prohibited under the Copyright Laws of the United States and other countries, and may subject you to civil and criminal liability.

**1: Changing a name of a recorded title** HDD DVD-RAM DVD-RW

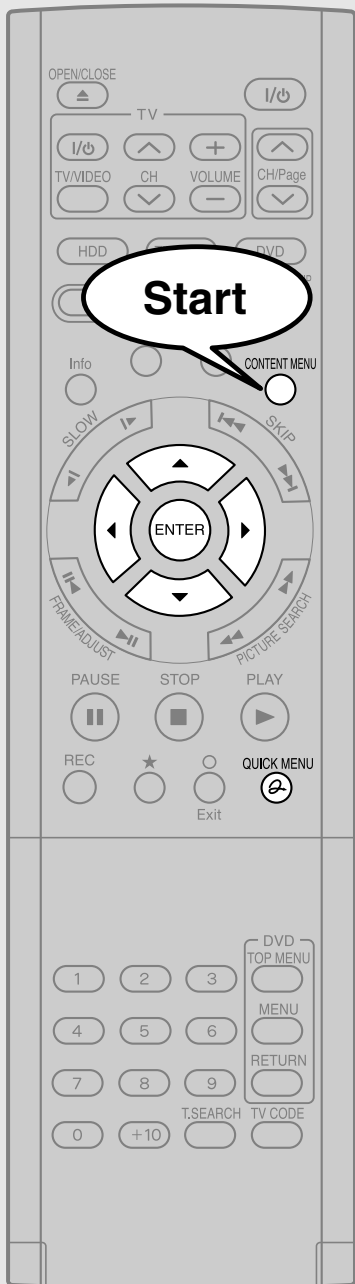

**1** Press **CONTENT MENU**, then press **▲ / ▼ / ◀ / ▶** to select a title.

**2** Press **QUICK MENU** then select “Title information” by pressing **▲ / ▼** from the Quick Menu, then press **ENTER**.



“CONTENT MENU Title information” appears.

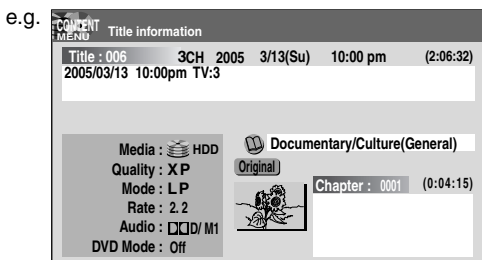

**3** Press **QUICK MENU** then select “Edit title name” or “Edit chapter name” by pressing **▲ / ▼** from the Quick Menu, then press **ENTER**.



The character entry screen appears.

- To change a title name or chapter name, see the steps on [page 36](#).

## 2: Dividing a recorded title into several chapters HDD DVD-RAM

1 title is created by recording at a time, which includes 1 chapter. By dividing it into several chapters, it will be easier to access a desired scene, and your editing or playback will be much easier.

### ● Simple method

To create chapters in a title, insert a chapter mark. Playback the contents, locate a point where you want to divide, then press **CHP DIVIDE** button. You can insert a chapter mark also while recording, by pressing **CHP DIVIDE** button. (A chapter will also be placed in the recording when you pause.)

The point divides the chapter (into two). You can create multiple chapters by repeating the above operation.

### Notes

- Chapters cannot be created in the following modes:  
Dubbing / Fast-reverse, Fast-forward / Slow-motion
- You cannot divide a title of a DVD-R/RW disc into chapters. It is possible to create chapters in a DVD-R/RW disc by pressing **CHP DIVIDE** button while recording at the desired points, or by selecting an option that inserts chapter marks automatically while recording at regular intervals. (➡ page 185)

### ● Precise method

If you want to modify the chapter division, or want to place a chapter mark more precisely monitoring the frame counter, follow the procedures below.



**1** Press **CONTENT MENU**, then press **▲/▼/◀/▶** to select a title.

**2** Press **QUICK MENU**.

Quick Menu appears.

e.g.

Quick Menu		1 / 2 Page	HDD
Title information			
Create thumbnail	07:00	008	2005/03/24 11:00 pm TV-8 (0:29:50)
High speed dubbing	3:45		Original
Rate conversion dubbing			Original
Chapter function			Original
Edit function	09:00	004	2005/04/07 07:00 am TV-8 (0:54:30)
Special playback mode			Original
Save captured images	2:40		Original
Disc information			Original
Display changeover	11:00	008	2005/04/08 09:00 pm TV-10 (0:51:28) ▶
Specific page jump	0:08		Original
Title delete			
Exit			

(Continued)



### 3 Press ▲ / ▼ to select “Chapter function”, then press ENTER.

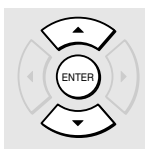

The submenu appears.

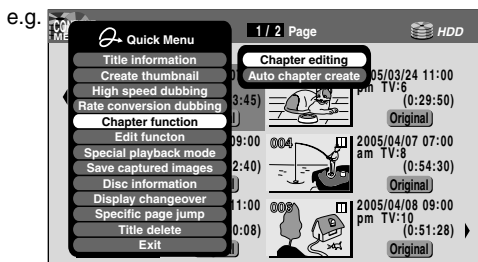

### 4 Press ▲ / ▼ to select “Chapter editing”, then press ENTER.

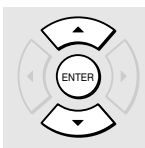

“EDIT MENU Chapter Editing” appears.

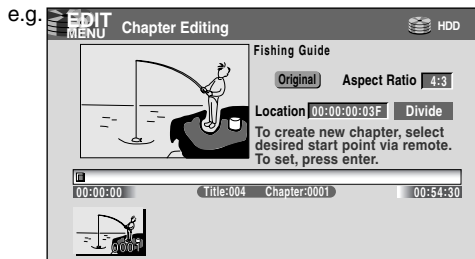

### 5 Press PLAY to start playback.



Locate a scene where you want to insert a chapter mark.

You can use the following buttons. PICTURE SEARCH, SLOW, SKIP, PAUSE, FRAME/ADJUST, etc.

The locator shows the current position on the time bar. And the live video plays in the upper left.

- To access other chapters:  
Press ▲ / ▼ buttons to move to the thumbnail display, then press ◀ / ▶ buttons to select a desired thumbnail. To go to the next page, press PICTURE SEARCH button.
- You can confirm the first and last scenes of a chapter. Select a thumbnail and press ENTER button. 3 seconds of the first and last scenes are played.



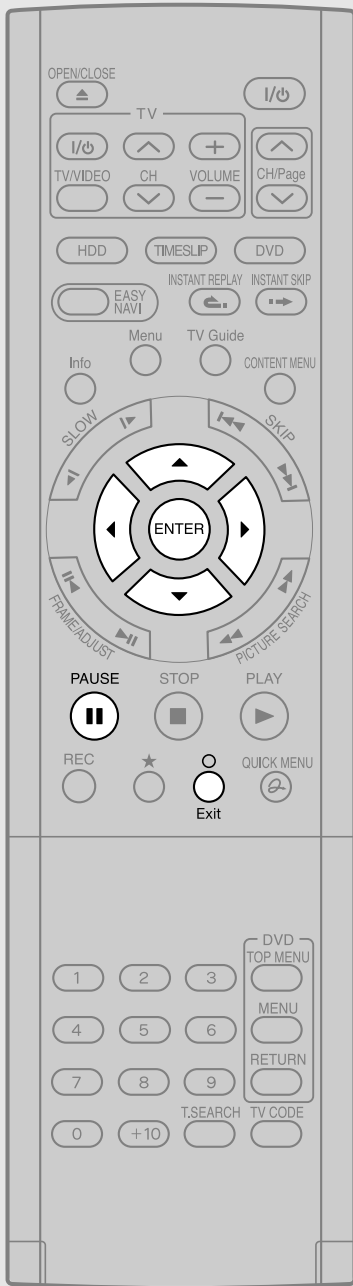

## 6 At a point where you want to make a chapter division, press PAUSE.

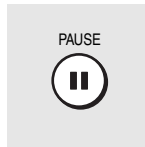

The picture pauses.

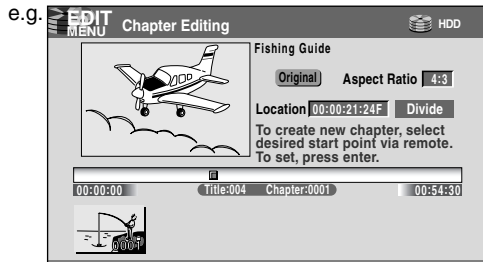

## 7 Press ▲/▼/◀/▶ to select “Divide,” then press ENTER.

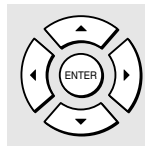

A chapter division is created at the selected location, and the first scene of the new chapter is registered as a chapter thumbnail.

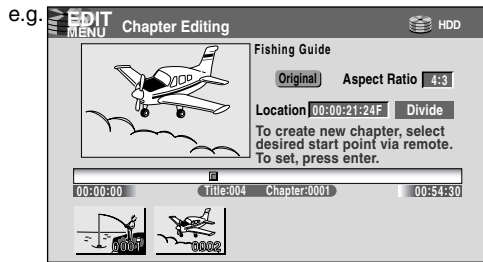

## 8 Repeat steps 5 to 7.

Locations of chapter division are indicated by the markers on the time bar.

To erase a chapter division, see “Merging chapters” (➔ page 91).

## 9 When all chapter divisions have been made, press ○.

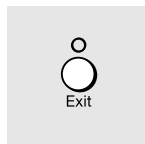

The recorder displays a message, and starts saving the chapter divisions on the time bar.

When complete, CONTENT MENU is displayed.

**Notes**

- This recorder supports a limited number of chapters on a disc. If exceeded, a message appears. In this event, reduce the number of chapters by merging chapters. (➡ page 91)
- “EDIT MENU Chapter Editing” can also be viewed by selecting “Chapter Editing” from “EDIT MENU Main Menu”.

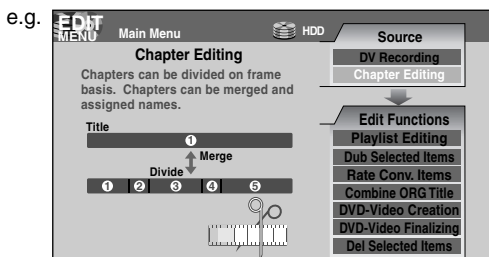

- To exit “EDIT MENU Main Menu”, press EDIT MENU button.
- Making chapters in a title (Original) does not affect the related titles (Playlist).
- There may be a small difference between a location you marked and a chapter division actually played.
- Pausing a recording automatically creates a chapter division.
- During relay recording (➡ page 56), a chapter division is automatically created at the start point of relay record.
- If you create chapters in a title which is stored in the HDD and copy the title to a DVD-R/RW, the chapter divisions may shift.

**■ Creating chapters automatically when recording**

You can create chapter marks from the beginning of a title at regular intervals automatically. (Chapter marks are added to those already existing.) This is convenient for long programs, such as live sports games.

- 1) Perform steps 1 to 4 on ➡ pages 87 to 88.
- 2) Press ▲ / ▼ to select “Auto chapter create”, then press ENTER.
- 3) Press ▲ / ▼ to select a chapter division interval, then press ENTER.

Chapter divisions are automatically marked at the selected intervals.

**■ Editing chapter break**

You can adjust positions of chapter marks. You can shift the beginning of a chapter currently selected.

- 1) Perform steps 1 to 5 on ➡ page 87 to 88.
- 2) Press QUICK MENU.
- 3) Press ▲ / ▼ to select “Chapter break edit mode”, then press ENTER.
- 4) Press ▲ / ▼ to select the item, then press ENTER.

**“by frame (VR mode)”**

The chapter mark shifts by one frame.

For contents which will be copied to DVD-RAM discs.

**“by GOP (Video mode)”**

The chapter mark shifts by a GOP (about 0.5 second), which is a unit of editing in DVD-Video format.

For contents which will be copied to DVD-R/RW.

- 5) Press ◀ / ▶ to select a chapter whose beginning you want to shift.
- 6) Press FRAME (II◀ / ▶II) repeatedly until a desired scene appears.
 

Select a point while monitoring the thumbnail, which changes as you press the button. To operate other chapters, press ◀ / ▶ buttons to select another, then follow the above steps.
- 7) When complete, press QUICK MENU, and select “Chapter break edit mode off (by frame)” or “Chapter Break Edit Mode off (by GOP)” then press ENTER.

The recorder exits the adjusting mode.

**Notes**

- You cannot shift a chapter mark beyond the adjacent chapter marks or a logical gap on recorded data within a chapter.
- Shifting a chapter mark restores a thumbnail to the beginning of a chapter. This may occur also on the previous chapter depending on the data condition.

## ■ Merging chapters

- 1) Perform steps 1 to 5 on  pages 87 to 88, to view the **EDIT MENU Chapter Editing display**.
- 2) Press **▲ / ▼ / ◀ / ▶** to highlight a chapter.  
Pressing PICTURE SEARCH button can access preceding or following pages.
- 3) Press **QUICK MENU**.

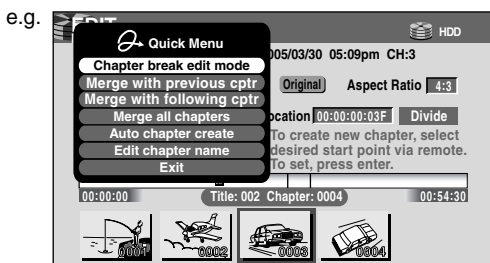

- 4) Press **▲ / ▼** to select an item.

### Merge with previous cptr:

To delete the chapter division between the selected chapter and the previous one.

### Merge with following cptr:

To delete the chapter division between the selected chapter and the succeeding one.

### Merge all chapters:

To merge all chapters in the title.

- 5) Press **ENTER**.

e.g. When “Merge with previous cptr” is selected:  
The selected chapter is merged into the previous chapter and its thumbnail is erased.

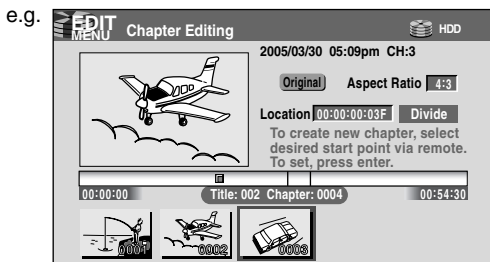

## Notes

- To turn off “EDIT MENU Main Menu”, press EDIT MENU button.
- When chapters are merged, the numerical value of following chapters will decrease correspondingly.
- Merging chapters does not affect the related titles (Playlist). You can also merge chapters in the title (Playlist). In this case, the title (Original) is not affected.
- You can access the feature of merging chapters also from Quick Menu on CONTENT MENU Chapter List.

## ■ Naming a chapter

- 1) From **EDIT MENU Chapter Editing**, select a chapter which you want to name.
- 2) Press **QUICK MENU**.
- 3) Press **▲ / ▼ / ◀ / ▶** to select “Edit Chapter Name”, then press **ENTER**.

A keyboard appears.

Enter a name following the on-screen icon guides.

## Notes

- There is a limit to the number of chapters which can be named. If exceeded, a message appears.
- You can also access the keyboard to enter a chapter name by selecting a chapter with PICTURE SEARCH button on CONTENT MENU Title Information, and by selecting “Edit chapter name” from the Quick Menu on CONTENT MENU Chapter List.
- You can change chapter names also on a DVD-R/RW disc, if the disc is not finalized yet.

**3: Collecting necessary scenes** HDD DVD-RAM

Create a "Playlist" to omit unnecessary scenes for dubbing, or compile desired scenes.



**1** Press **CONTENT MENU**.

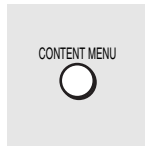

"CONTENT MENU Title List" appears.

Pressing the HDD or DVD button can switch the drives.

**2** Press **QUICK MENU**.

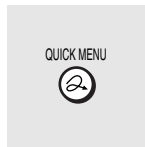

Quick Menu appears.

e.g.

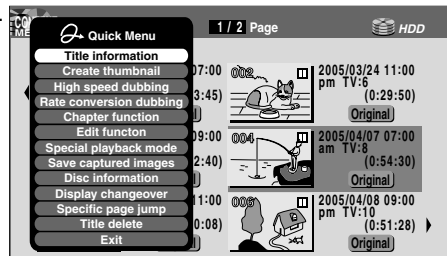

**3** Press **▲ / ▼** to select "Edit function", then press **ENTER**.

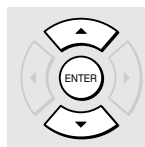

Submenu appears.

e.g.

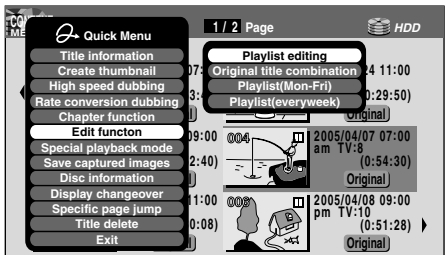

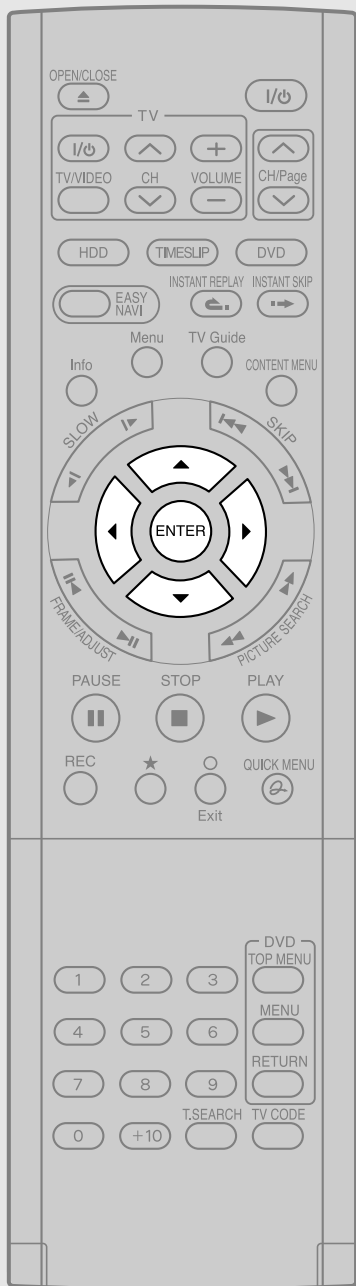

## 4 Press ▲ / ▼ to select “Playlist editing”, then press ENTER.

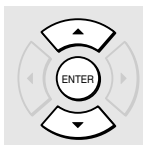

“EDIT MENU Playlist editing” appears.

e.g.

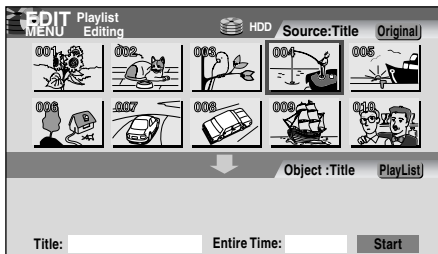

## 5 Press ▲ / ▼ / ◀ / ▶ to select a title or chapter.

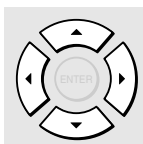

To select between titles and chapters, press ★ button.

e.g.

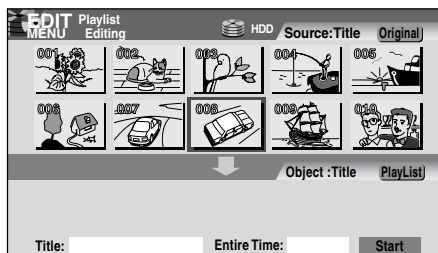

## 6 Press ENTER.



A cursor appears, indicating the point where the selected item will be inserted.

e.g.

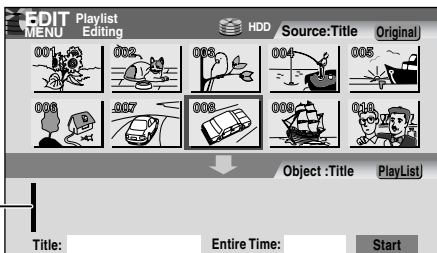

Cursor

(Continued)



## 7 Press ◀/▶ to select a point where you want to insert the item, then press ENTER.

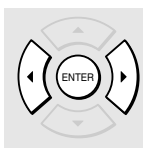

If there are no parts in the lower area, leave the cursor to the left and press ENTER button.

The selected part is inserted at the location of the cursor.

e.g.

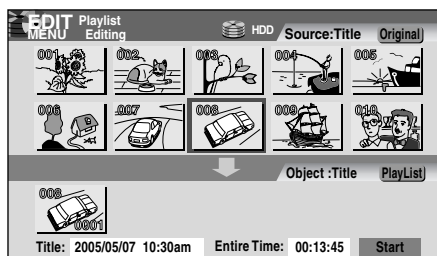

## 8 Repeat steps 5 to 7 to insert items.

To cancel the selection, see “Canceling selection of a part” (➡ page 95).

## 9 When all items have been inserted, press ○.

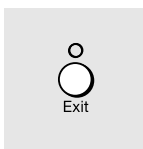

The recorder displays a message, and starts saving the Playlist.

When completed, CONTENT MENU is displayed.

### Notes

- You can access “EDIT MENU Playlist Editing” also by selecting “Playlist editing” on EDIT MENU.
- If you delete titles and chapters (Original), the corresponding titles and chapters (Playlist) are also deleted. Contrarily, if you delete titles and chapters (Playlist), the corresponding titles and chapters (Original) are not deleted.
- Playback may pause if a gap between the content is played.
- There may be a small difference between the chapter boundary and the actual playback picture.
- A title or chapter which is being edited cannot be selected as an item.
- You cannot add a title of still pictures, or a title or a chapter which contains both still and moving pictures, to a playlist.
- By copying (dubbing) a Playlist, a title (Original) of the same contents is created.
- You cannot program a Playlist of contents recorded on a DVD-R/RW disc.
- Down arrow on the thumbnails means: Orange: This title already selected. Green trimmed: Some chapters in this title already selected. Green: This chapter already selected.
- A black thumbnail with “Recording” means that the title is being recorded or its recording will start within 10 seconds. This thumbnail cannot start playback.

### ■ Canceling selection of a part

- 1) From **EDIT MENU Playlist editing**, press **▲ / ▼ / ◀ / ▶** to select a part to cancel.
- 2) Press **QUICK MENU**.  
Quick Menu appears.
- 3) Press **▲ / ▼** to select **“Cancel selected title”**, then press **ENTER**.  
The part you have selected is canceled.

### ■ Confirming the first and last scenes of a part or a Playlist

You can play the first and last 3 seconds of a scene (Preview). (If a title contains several chapters, the first and last scenes of the chapters are also played.)

Preview of a part:

- 1) At step 5 on  page 93, select a title or a chapter, then press **QUICK MENU**.
- 2) Press **▲ / ▼** to select **“Preview”**, then press **ENTER**.

Preview of all parts:

- 1) Move the cursor to an any part (in the lower area), then press **QUICK MENU** button.
- 2) Press **▲ / ▼** to select **“Preview all playlists”**, then press **ENTER**.

### ■ Confirming the title information

- 1) At step 5 on  page 93, select a title or a chapter, then press **QUICK MENU**.
- 2) Press **▲ / ▼** to select **“Title information”** then press **ENTER**.

### ■ Correcting a Playlist

You can add or delete parts to correct a Playlist.

- 1) From **CONTENT MENU**, select a playlist to correct.
- 2) Press **QUICK MENU**.
- 3) Press **▲ / ▼** to select **“Playlist re-editing”** and then press **ENTER**.  
“EDIT MENU Playlist editing” appears.

Follow the procedure from steps 5 on  page 93, add or delete parts as necessary.

### Note

- You cannot edit a title (Playlist) of still pictures, or a title (Playlist) which contains both still and moving pictures.

### ■ Using a part in a Playlist also in another Playlist

- 1) Press **EDIT MENU**.  
“EDIT MENU Main Menu” appears.
- 2) Press **▲ / ▼ / ◀ / ▶** to select **“Playlist editing,”** then press **ENTER**.  
“EDIT MENU Playlist editing” appears.
- 3) Press **▲ / ▼ / ◀ / ▶** to select **“Start”** then press **ENTER**.  
The areas of title name and part selection become blank.
- 4) Following the procedures outlined on  page 93, make a Playlist.

### ■ Naming a title (Playlist)

- 1) From **EDIT MENU Playlist editing**, move a cursor to the lower side (selected parts) then press **QUICK MENU**.
- 2) Press **▲ / ▼** to select **“Edit title name,”** then press **ENTER**.  
A keyboard appears.
- 3) Following the procedures outlined on  page 36, enter a title name.

### Note

- You can name a title also while viewing its information. From **“CONTENT MENU Title List”**, select a title and press **QUICK MENU** button then select **“Title Information”** by **▲ / ▼** buttons and **ENTER** button. Further press **QUICK MENU** button, and select **“Edit title name”** by **▲ / ▼** buttons and **ENTER** button.

■ **Making a Playlist of recorded contents where starting times are the same (i.e. daily or weekly recordings)**

This will help to sort serials.

- 1) From “CONTENT MENU Title List”, press **QUICK MENU**.
- 2) Press **▲ / ▼** to select “Edit function”, then press **ENTER**.
- 3) Press **▲ / ▼** to select the item.
  - “**Playlist(Mon-Fri)**”  
To sort out programs recorded on the same time on Monday to Friday to make a Playlist.
  - “**Playlist(every week)**”  
To sort out programs recorded on the same time of the same day of the week to make a Playlist.
- 4) Press **ENTER**.

**Notes**

- Only titles (Original) can be sorted.
- The maximum number of sorted titles on a DVD-RAM disc is 99.
- If you modify the recording start time or date of one of the recorded serials, the title will not be sorted out. Contrarily, any program can be sorted if its channel, recording start time and date are modified as the same as others.
- “Playlist(Mon-Fri)” can sort titles even if they are not complete 5 collections of Monday to Friday, on the condition that they have the same channel and recording start time, and exclude Saturday and Sunday.



## 4: Dubbing to save

You can dub (copy or move) contents recorded in the HDD or DVD-RAM/R/RW, between HDD and DVD-RAM drive or within the same drives.

Learn about dubbing on this recorder to select the best method.

Purpose	Operation
<ul style="list-style-type: none"> <li>● Dubbing a whole title or a chapter Converting a title (Playlist) into a title (Original)</li> </ul>	<ul style="list-style-type: none"> <li>⇒ <b>A: High speed dubbing</b> (⇒ page 100)</li> </ul>
<ul style="list-style-type: none"> <li>● Dubbing a title reducing its data size</li> </ul>	<ul style="list-style-type: none"> <li>⇒ <b>B: Rate conversion dubbing</b> (⇒ page 106)</li> </ul>
<ul style="list-style-type: none"> <li>● Dubbing a title which is being played</li> </ul>	<ul style="list-style-type: none"> <li>⇒ <b>C: Line-U dubbing</b> (⇒ page 110)</li> </ul>
<ul style="list-style-type: none"> <li>● Dubbing titles recorded on the HDD to DVD-R/RW for distribution to DVD player users</li> </ul>	<ul style="list-style-type: none"> <li>⇒ <b>Creating a DVD-Video using DVD-R/RW</b> (⇒ page 112)</li> </ul>

### A: High speed dubbing

You can copy recorded contents without changing the picture and sound quality.

“High speed” means the dubbing time is shorter than the actual time of the content.

Use this function on the purposes such as the followings:

- when you copy a whole title to a DVD-RAM/R/RW disc.
- when you convert a Playlist into an Original title (produce an Original title from a Playlist)

#### High speed dubbing of several contents - “Dub selected items”

You can select titles and chapters and copy them all at once.

### B: Rate conversion dubbing

You can copy content and change its data size from the original recording.

Use this function on the purposes such as the followings:

- When you have recorded a content on the HDD at a high rate, and you cannot copy it to a DVD-RAM disc because the data size is too large. (→ Reduce the data size.)

- When you recorded a content while “DVD compatible mode” (⇒ page 184) was set to “Off”, and you cannot copy it to a DVD-R/RW in the DVD-Video format; or when a DVD-RAM disc was recorded with the other equipment which is not compatible with this recorder’s recording format, and you want to copy it to a DVD-R/RW (→ Set “DVD compatible mode” to “Main” or “SAP”.)

#### Rate conversion dubbing of several parts

You can select titles and chapters and change the data size and copy them all at once.

Use this function when you unify the compatibility of several titles and contents all at once.

### C: Line-U dubbing

You can record pictures recorded which is being played.

Use this function when you want to copy contents in DVD-R/RW recorded on other device, which cannot show thumbnails in “CONTENT MENU Title List”, to the HDD.

All the above functions can copy data as original digital signals. “Rate conversion dubbing” and “Line-U dubbing”, however, needs data processing and may deteriorate the original picture and sound quality. Also, it is not possible to improve the picture and sound quality by the Rate conversion dubbing at increased bit rate.

From	To	High speed Library dubbing	High speed Library dubbing of several parts	Rate conversion dubbing	Rate conversion dubbing of several parts	Line-U dubbing
HDD	HDD	Yes	Yes	Yes	Yes	Yes
	DVD-RAM	Yes	Yes	Yes	Yes	Yes
	DVD-R/RW (Not finalized yet)	Yes	Yes	Yes	Yes	Yes
DVD-RAM	HDD	Yes	Yes	Yes	Yes	Yes
	DVD-RAM	Yes	Yes	No	No	No
DVD-R/RW	HDD	Yes	Yes	Yes	Yes	Yes
	DVD-R/RW	No	No	No	No	No

- It is not possible to copy to a DVD-R/RW of DVD-VR mode.
- “High speed dubbing” between the HDD and a DVD-R/RW recorded on other equipment is not possible.
- “High speed dubbing” to a finalized DVD-R/RW is not possible.
- “Line-U dubbing” using a DVD-R/RW which was recorded on other equipment and is not finalized yet is not possible.

■ **“Copy” and “Move”**

This recorder’s “Dubbing” has the following two definitions:

**Copy:**

The original program remains after the operation is completed.

**Move:**

The moved program will be erased from the original location after the operation is completed.

Whether or not you select either command depends entirely on the given situation. The command may be predetermined in some situations.

You cannot “move” contents in the following situations. (Instead, you will want to “copy” them.)

- The content is protected (➡ page 56).
- A specified portion of the title (chapter) is copy-protected, in which case, you cannot move from DVD-RAM to the HDD.
- You cannot move a Playlist. Only copying is permitted. When you copy a Playlist to a disc, it will be treated an Original on the disc. The original Playlist does not change to an Original.

Also, you cannot “move” or “copy” contents in the following situations:













- The recorded content contains a program that permits a single copy only.
- The title (Playlist) contains a portion that prohibits copying. Edit the title from the Original and create a new Playlist.

**Notes**

- If either the HDD or DVD-RAM is not in optimum physical condition, an error may occur when you execute “Move” and some titles or chapters may be lost. If you want to “Move” non-copy-protected titles and chapters, it is recommended for safety that you first “Copy” them to the opposite drive and confirm they have been copied properly. Then delete the titles and chapters to which you have executed “Move”.
- The recorder cannot copy/move the following discs:  
 DVD-VIDEO  
 VIDEO CD  
 Audio CD  
 CD-R  
 CD-RW
- If you cannot copy/move for some other reason, such as insufficient disc capacity, etc., a message will appear on screen. In such a case, follow the instructions in the message.
- Depending on the content, associated information such as data management may not be copied/moved.
- You cannot copy/move titles containing still pictures.
- Dubbing to DVD-R/RW may divide the original title depending on the contents. Also, the DVD-Video format recording (➡ page 112) may shift thumbnails.
- A part with aspect ratio 16:9 recorded at bit rate 1.0Mbps or 1.4Mbps cannot be dubbed to a DVD-R/RW. Change the aspect ratio to 4:3.
- “High speed dubbing” (➡ page 100) and “A: High speed dubbing (Dubbing specified parts together)” (➡ page 102) procedures always comply with “Aspect ratio(Video mode)” setting (➡ page 184).

## ■ Recording and playback while dubbing

Dubbing process by “High speed dubbing” and “Dub selected items” procedures will allow you to make a recording or playback of other titles.

	 HDD Playback	 HDD Recording	 DVD Playback	 DVD Recording
 HDD →  DVD	Available	Available	Not available	Not available
 DVD →  HDD	Not available	Not available	Not available	Not available
 HDD →  HDD	Not available	Not available	Available	Available
 DVD →  DVD	Available	Available	Not available	Not available

### Notes

- Timer programmed recording have priority over other operations. Dubbing may be stopped if a timer program recording starts.
- While recording and dubbing are in progress at the same time, CONTENT MENU and LIBRARY MENU will not appear.
- Playing a recorded title while recording another on the same disc (➡ page 48), is not possible while dubbing.

### A: High speed dubbing (Dubbing only a specified part)

HDD DVD-RAM DVD-RW DVD-R

This section explains how to dub a specific title or chapter. To select several parts and dub them all at once, refer to  page 102.

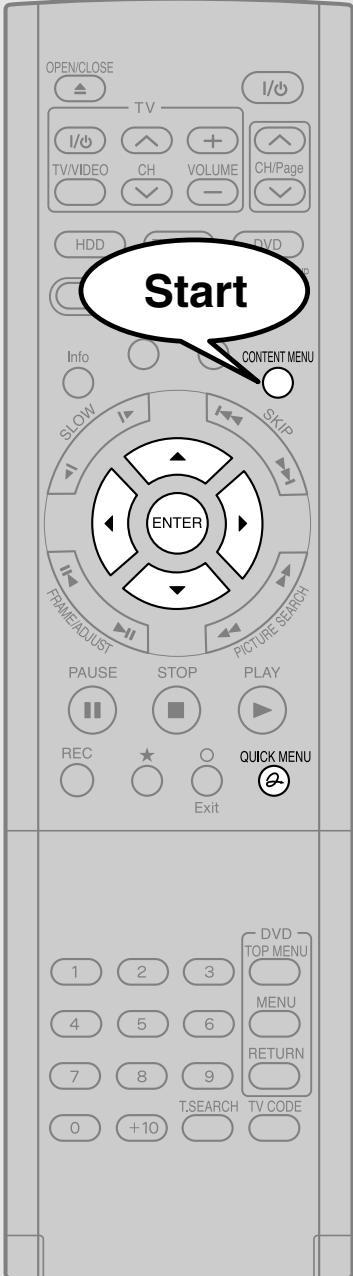

**1** Press **CONTENT MENU**, then press **▲ / ▼ / ◀ / ▶** to select a title.

---

**2** Press **QUICK MENU**.

The Quick Menu appears.





---

**3** Press **▲ / ▼** to select “High speed dubbing” from the Quick Menu, then press **ENTER**.

“CONTENT MENU High Speed Library Dubbing” appears.

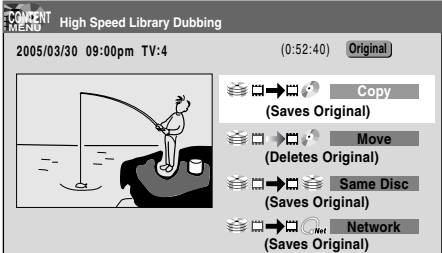

e.g.



## Free Manuals Download Website

<http://myh66.com>

<http://usermanuals.us>

<http://www.somanuals.com>

<http://www.4manuals.cc>

<http://www.manual-lib.com>

<http://www.404manual.com>

<http://www.luxmanual.com>

<http://aubethermostatmanual.com>

Golf course search by state

<http://golfingnear.com>

Email search by domain

<http://emailbydomain.com>

Auto manuals search

<http://auto.somanuals.com>

TV manuals search

<http://tv.somanuals.com>