

TOSHIBA



COMBINATION FLAT COLOR TELEVISION AND VIDEO CASSETTE RECORDER / DVD VIDEO PLAYER

MW26H82

OWNER'S MANUAL



Introduction 2

Connections 13

Basic setup 20

TV operation 25

Playback (VCR) 46

Recording (VCR) 51

Other functions (VCR) 55

Basic playback (DVD) 57

Advanced playback (DVD) 60

Function setup (DVD) 72

Others 78

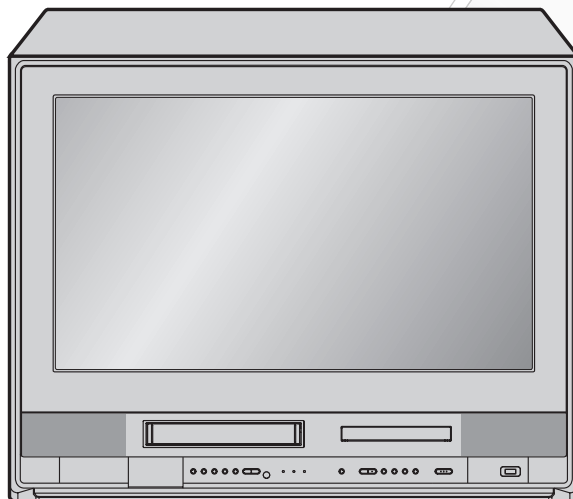

©2006 Toshiba Corporation
This device does not tape-record copy protected DVD video discs.

Dear Customer,

Thank you for purchasing this Toshiba TV. This manual will help you use the many exciting features of your new TV. **Before operating the TV, please read this manual completely**, and keep it nearby for future reference.

Safety Precautions**WARNING**

TO REDUCE THE RISK OF FIRE OR ELECTRIC SHOCK, DO NOT EXPOSE THIS APPLIANCE TO RAIN OR MOISTURE.

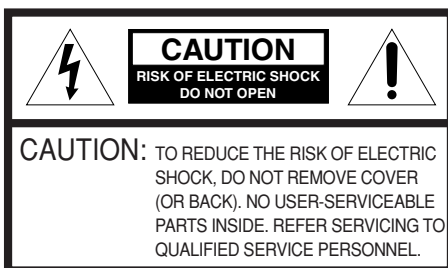

The lightning symbol in the triangle tells you that the voltage inside this product may be strong enough to cause an electric shock. **DO NOT TRY TO SERVICE THIS PRODUCT YOURSELF.**



The exclamation mark in the triangle tells you that important operating and maintenance instructions follow this symbol.

CAUTION: To reduce the risk of electric shock, do not use the polarized plug with an extension cord, receptacle, or other outlet unless the blades can be inserted completely to prevent blade exposure.

NOTE TO CATV INSTALLERS

This is a reminder to call the CATV system installer's attention to Article 820-40 of the NEC, which provides guidelines for proper grounding and, in particular, specifies that the cable ground shall be connected to the grounding system of the building, as close to the point of cable entry as practical. For additional antenna grounding information, see items 26 and 27 on page 4.

NOTICE OF POSSIBLE ADVERSE EFFECTS ON TV PICTURE DISPLAY

If a fixed (non-moving) pattern or image remains on the TV screen for extended periods of time, the image can become permanently ingrained in the cathode ray tube(s) of the TV and cause subtle but permanent ghost images. **This type of damage is NOT COVERED BY YOUR WARRANTY.** See page 4 for details.

It Makes A Difference Where Your TV Stands

Congratulations on your purchase! As you enjoy your new TV, keep these safety tips in mind:

The Issue

- If you are like most consumers, you have a TV in your home. Many homes, in fact, have more than one TV.
- The home theater entertainment experience is a growing trend, and larger TVs are popular purchases; however, they are not always supported on the proper TV stands.
- Sometimes TVs are improperly secured or inappropriately situated on dressers, bookcases, shelves, desks, audio speakers, chests, or carts. As a result, TVs may fall over, causing unnecessary injury.

Toshiba Cares!

- The consumer electronics industry is committed to making home entertainment enjoyable and safe.
- The Consumer Electronics Association formed the Home Entertainment Support Safety Committee, comprised of TV and consumer electronics furniture manufacturers, to advocate children's safety and educate consumers and their families about television safety.

Tune Into Safety

- One size does NOT fit all! Use appropriate furniture large enough to support the weight of your TV (and other electronic components).
- Use appropriate angle braces, straps, and anchors to secure your furniture to the wall (but never screw anything directly into the TV).
- Carefully read and understand the other enclosed instructions for proper use of this product.
- Do not allow children to climb on or play with furniture and TVs.
- Avoid placing any item on top of your TV (such as a VCR, remote control, or toy) that a curious child may reach for.
- Remember that children can become excited while watching a program and can potentially push or pull a TV over.
- Share our safety message about this hidden hazard of the home with your family and friends. Thank you!



2500 Wilson Blvd.
Arlington, VA 22201 U.S.A.
Tel. 703-907-7600 Fax 703-907-7690
www.CE.org

CEA is the Sponsor, Producer and Manager of the International CES®



IMPORTANT SAFEGUARDS

Important Safety Instructions

- 1) Read these instructions.
- 2) Keep these instructions.
- 3) Heed all warnings.
- 4) Follow all instructions.



5) Do not use this apparatus near water.

6) Clean only with a dry cloth.

7) Do not block any ventilation openings. Install in accordance with the manufacturer's instructions.

8) Do not install near any heat sources such as radiators, heat registers, stoves, or other apparatus (including amplifiers) that produce heat.

9) Do not defeat the safety purpose of the polarized or grounding type plug. A polarized plug has two blades with one wider than the other. A grounding type plug has two blades and a third grounding prong.

The wide blade or the third prong are provided for your safety. If the provided plug does not fit into your outlet, consult an electrician for replacement of the obsolete outlet.

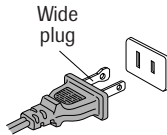

10) Protect the power cord from being walked on or pinched, particularly at plugs, convenience receptacles, and the point where it exits the apparatus.

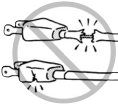

11) Only use attachments/accessories specified by the manufacturer.

12) Use only with the cart, stand, tripod, bracket, or table specified by the manufacturer, or sold with the apparatus. When a cart is used, use caution when moving the cart/apparatus combination to avoid injury from tip-over.



13) Unplug this apparatus during lightning storms or when unused for long periods of time.



14) Refer all servicing to qualified service personnel. Servicing is required when the apparatus has been damaged in any way, such as power supply cord or plug is damaged, liquid has been spilled or objects have fallen into the apparatus, the apparatus has been exposed to rain or moisture, does not operate normally, or has been dropped.

14a) **CAUTION:** If the TV is dropped and the cabinet or enclosure surface has been damaged or the TV does not operate normally, take the following precautions:

- ALWAYS turn off the TV and unplug the power cord to avoid possible electric shock or fire.
- To prevent personal injury, never handle the damaged television.
- ALWAYS contact a service technician to inspect the TV any time it has been damaged or dropped.

15) **CAUTION:** To reduce the risk of electric shock, do not use the polarized plug with an extension cord, receptacle, or other outlet unless the blades can be inserted completely to prevent blade exposure.



Installation, Care, and Service

Installation

Follow these recommendations and precautions and heed all warnings when installing your TV:

16) Never modify this equipment. Changes or modifications may void: a) the warranty, and b) the user's authority to operate this equipment under the rules of the Federal Communications Commission.

17) **DANGER: RISK OF SERIOUS PERSONAL INJURY, DEATH, OR EQUIPMENT DAMAGE!** Never place the TV on an unstable cart, stand, or table. The TV may fall, causing serious personal injury, death, or serious damage to the TV.



18) Never place or store the TV in direct sunlight; hot, humid areas; areas subject to excessive dust or vibration; or locations with temperatures at or below 41°F (5°C).



19) Always place the TV on the floor or a sturdy, level, stable surface that can support the weight of the unit.



20) Never place items such as vases, aquariums, or candles on top of the TV.



21) Never block or cover the slots or openings in the TV cabinet back, bottom, and sides. Never place the TV:

- on a bed, sofa, rug, or similar surface;
- too close to drapes, curtains, or walls; or
- in a confined space such as a bookcase, built-in cabinet, or any other place with poor ventilation.



The slots and openings are provided to protect the TV from overheating and to help maintain reliable operation of the TV.

22) Always place the back of the television at least one (1) inch away from any vertical surface (such as a wall) to allow proper ventilation.

23) Never allow anything to rest on or roll over the power cord, and never place the TV where the power cord is subject to wear or abuse.

24) Never overload wall outlets and extension cords.



IMPORTANT SAFEGUARDS

- 25) Always operate this equipment from a 120 V AC, 60 Hz power source only.

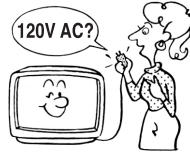

- 26) Always make sure the antenna system is properly grounded to provide adequate protection against voltage surges and built-up static charges (see Section 810 of the National Electric Code).

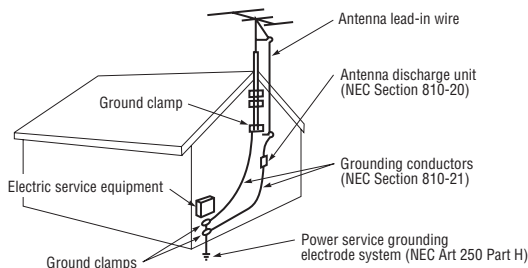

- 27) **! DANGER: RISK OF SERIOUS PERSONAL INJURY OR DEATH!**
- Use extreme care to make sure you are never in a position where your body (or any item you are in contact with, such as a ladder or screwdriver) can accidentally touch overhead power lines. Never locate the antenna near overhead power lines or other electrical circuits.
 - Never attempt to install any of the following during lightning activity:
 - a) an antenna system; or b) cables, wires, or any home theater component connected to an antenna or phone system.

Care

For better performance and safer operation of your TOSHIBA TV, follow these recommendations and precautions:

- 28) Always sit approximately 10–25 feet away from the TV and as directly in front of it as possible. The picture can appear dull if you sit too far to the left or right of the TV, or if sunlight or room lights reflect on the screen. Turn the TV off to check for reflections on the screen, and then remove the source of reflections while viewing the TV.

- 29) Always unplug the TV before cleaning. Never use liquid or aerosol cleaners.

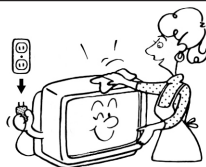

- 30) **! WARNING: RISK OF ELECTRIC SHOCK!** Never spill liquids or push objects of any kind into the TV cabinet slots.

- 31) [This item applies to projection TVs only.] If the air temperature rises suddenly (for example, when the TV is first delivered), condensation may form on the lenses. This can make the picture appear distorted or the color appear faded. If this happens, turn off the TV for 6 to 7 hours to allow the condensation to evaporate.

- 32) For added protection of your TV from lightning and power surges, always unplug the power cord and disconnect the antenna from the TV if you leave the TV unattended or unused for long periods of time.

- 33) During normal use, the TV may make occasional snapping or popping sounds. This is normal, especially when the unit is being turned on or off. If these sounds become frequent or continuous, unplug the power cord and contact a Toshiba Authorized Service Center.

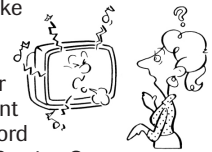

- 34) **Possible Adverse Effects on TV Picture Display:** If a fixed (non-moving) pattern or image remains on the TV screen for extended periods of time, the image can become permanently ingrained in the cathode ray tube(s) of the TV and cause subtle but permanent ghost images. **This type of damage is NOT COVERED BY YOUR WARRANTY.** Never leave the TV on for extended periods of time while it is displaying the following images or formats:

- **Fixed Images**, including but not limited to PIP/POP windows, closed captions, video game patterns, TV station logos, stock tickers, and websites.
- **Special Formats** that do not use the entire screen, including but not limited to widescreen or letterbox format media viewed on a 4:3 aspect ratio display (with gray or black bars at the top and bottom of the screen); or 4:3 aspect ratio format media viewed on a widescreen/16:9 aspect ratio display (with gray or black bars on the left and right sides of the screen).

Service

- 35) **! WARNING: RISK OF ELECTRIC SHOCK!** Never attempt to service the TV yourself. Opening and removing the covers may expose you to dangerous voltage or other hazards. Refer all servicing to a Toshiba Authorized Service Center.

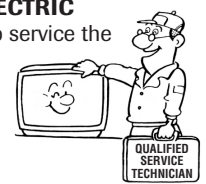

- 36) If you have the TV serviced:

- Ask the service technician to use only replacement parts specified by the manufacturer.
- Upon completion of service, ask the service technician to perform routine safety checks to determine that the TV is in safe operating condition.

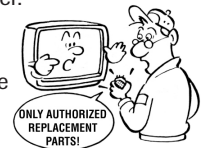

- 37) When the TV reaches the end of its useful life, ask a qualified service technician to properly dispose of the TV. Improper disposal may result in a picture tube implosion and possible personal injury.

SAFETY PRECAUTION/ Power source

WARNING: This equipment has been tested and found to comply with the limits for a Class B digital device, pursuant to Part 15 of the FCC Rules. These limits are designed to provide reasonable protection against harmful interference in a residential installation. This equipment generates, uses and can radiate radio frequency energy and, if not installed and used in accordance with the instructions, may cause harmful interference to radio communications. However, there is no guarantee that interference will not occur in a particular installation. If this equipment does cause harmful interference to radio or television reception, which can be determined by turning the equipment off and on, the user is encouraged to try to correct the interference by one or more of the following measures:

- Reorient or relocate the receiving antenna.
- Increase the distance between the equipment and receiver.
- Connect the equipment into an outlet on a circuit different from that to which the receiver is connected.
- Consult the dealer or an experienced radio/TV technician for help.

CAUTION: Changes or modifications not expressly approved by the party responsible for compliance with the FCC (Federal Communications Commission) Rules could void the user's authority to operate this equipment.

CAUTION:
THIS DIGITAL VIDEO PLAYER EMPLOYS A LASER SYSTEM.

TO ENSURE PROPER USE OF THIS PRODUCT, PLEASE READ THIS OWNER'S MANUAL CAREFULLY AND RETAIN FOR FUTURE REFERENCE. SHOULD THE UNIT REQUIRE MAINTENANCE, CONTACT AN AUTHORIZED SERVICE LOCATION.

USE OF CONTROLS, ADJUSTMENTS OR THE PERFORMANCE OF PROCEDURES OTHER THAN THOSE SPECIFIED HEREIN MAY RESULT IN HAZARDOUS RADIATION EXPOSURE.

TO PREVENT DIRECT EXPOSURE TO LASER BEAM, DO NOT TRY TO OPEN THE ENCLOSURE. VISIBLE LASER RADIATION MAY BE PRESENT WHEN THE ENCLOSURE IS OPENED. DO NOT STARE INTO BEAM.

Location of the required Marking

The rating sheet and the safety caution are on the rear of the unit.

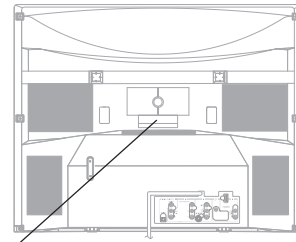

CERTIFICATION: COMPLIES WITH
FDA RADIATION PERFORMANCE
STANDARDS, 21 CFR SUBCHAPTER J.

WARNING: This product contains a laser beam. Do not attempt to stare at the beam through the DVD disc tray or the ventilation openings. Staring directly at the beam may cause permanent damage to your eyesight.

IMPORTANT RECYCLING INFORMATION

This product uses both Cathode Ray Tube (CRT) and other components that contain lead. In your community there might be regulations that require you to dispose these materials properly under environmental considerations. Please contact your local authorities, or the Electronic Industries Alliance (<http://www.eiae.org>) for disposal or recycling information.

Power source

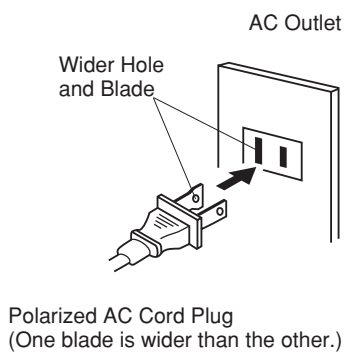

TO USE AC POWER SOURCE

Use the AC polarized line cord provided for operation on AC. Insert the AC cord plug into a standard 120V 60Hz polarized AC outlet.

Notes:

- Never connect the AC line cord plug to other than the specified voltage (120V 60Hz). Use the attached power cord only.
- If the polarized AC cord does not fit into a non-polarized AC outlet, do not attempt to file or cut the blade. It is the user's responsibility to have an electrician replace the obsolete outlet.
- If you cause a static discharge when touching the unit and the unit fails to function, simply unplug the unit from the AC outlet and plug it back in. The unit should return to normal operation.
- If the AC cord plug is plugged in for the first time, wait for approx. 5 seconds before pressing the POWER button.

Precautions

Notes on handling

- When shipping the unit, the original shipping carton and packing materials come in handy. For maximum protection, repack the unit as it was originally packed at the factory.
- Do not use volatile liquids, such as insect spray, near the unit. Do not leave rubber or plastic products in contact with the unit for a long time. They will leave marks on the finish.
- The top and rear panels of the unit may become warm after a long period of use. This is not a malfunction.
- When the unit is not in use, be sure to remove the disc and the video cassette turn off the power.
- If you do not use the unit for a long period, the unit may not function properly in the future. Turn on and use the unit occasionally.

Notes on locating

- Place the unit on a level surface. Do not use it on a shaky or unstable surface such as a wobbling table or inclined stand. The loaded disc or the video tape may come off the proper position and cause damage to the unit.
- When you place this unit near a TV, radio, or VCR, the playback picture may become poor and the sound may be distorted. In this case, place the unit away from the TV, radio or VCR.

Notes on cleaning

Use a soft, dry cloth for cleaning.

- For stubborn dirt, Do not use any type of solvent, such as thinner and benzene, as they may damage the surface of the unit.
- If you use a chemical saturated cloth to clean the unit, follow that product's instructions.

Notes on moisture condensation

Moisture condensation damages the unit. Please read the following carefully.

Moisture condensation occurs, for example, when you pour a cold drink into a glass on a warm day. Drops of water form on the outside of the glass. In the same way, moisture may condense on the head drum or the optical pick-up lens inside this unit, one of the most crucial internal parts of the unit.

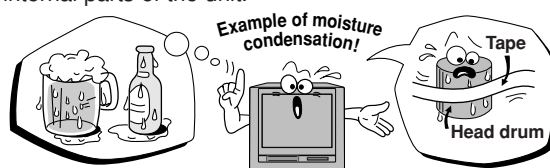

■ **Moisture condensation occurs during the following cases.**

- When you bring the unit directly from a cold place to a warm place.
- When you use the unit in a room where you just turned on the heater, or a place where the cold wind from the air conditioner directly hits the unit.
- In summer, when you use the unit in a hot and humid place just after you move the unit from an air conditioned room.
- When you use the unit in a humid place.

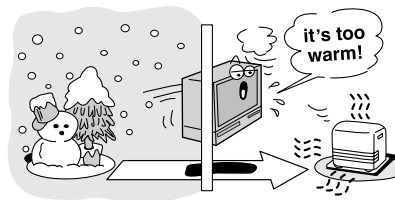

■ **Do not use the unit when moisture condensation may occur.**

If you use the unit in such a situation, it may damage discs and internal parts. Remove the disc or the video tape, connect the power cord of the unit to the wall outlet, turn on the unit, and leave it for two or three hours. After two or three hours, the unit will have warmed up and evaporated any moisture. Keep the unit connected to the wall outlet and moisture condensation will seldom occur.

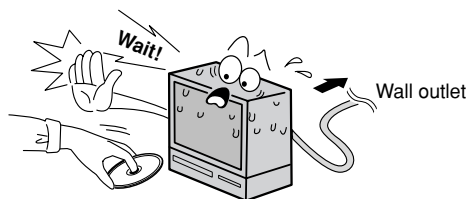



Contents

Introduction

- IMPORTANT SAFEGUARDS 3
- SAFETY PRECAUTION 5
- Power source 5
- Precautions 6
- Contents 7
- Notes and Information 8
- Identification of controls 10

Connections

- Antenna connections 13
- Cable TV connections 14
- Connecting to optional equipment 15
- Connecting to a USB Storage Device 19

Basic setup

- Starting setup 20
- Clock setting 21
- Setting the language 23
- TV/VCR operation status 24

TV operation

- TV operation 25
- To memorize channels 27
- Closed captions 28
- Programming your favorite channels 30
- Labeling channels 31
- Labeling the video input sources 31
- Setting the V-Chip 32
- Using the front panel lock feature 34
- To set the on timer 35
- To set the off timer 36
- Picture control adjustment 37
- Adjusting the picture preference 37
- Using the CableClear® feature 38
- Selecting the color temperature 38
- Selecting the display format 39
- Selecting the Scan Velocity Modulation (SVM) 39
- Resetting your picture adjustments 40
- Selecting the picture size 40
- Picture scroll 42
- Selecting the cinema mode 42
- Stereo and Second Audio Program (SAP) 43
- Sound control adjustment 43
- Selecting the HDMI audio input source 44
- Selecting the audio languages 44
- Selecting the digital output 45
- Resetting your audio adjustments 45
- Checking the digital signal strength 45

Playback (VCR)

- Loading and unloading a cassette tape 46
- Cassette tape playback 47
- Special playback 48
- Convenient function 49

Recording (VCR)

- Recording a TV program 51
- One-touch Timer Recording (OTR) 52
- Timer recording 53

Other functions (VCR)

- Duplicating a video tape 55
- Recording a DVD/CD disc 56

Basic playback (DVD)

- Playing a disc 57

Advanced playback (DVD)

- Zooming 60
- Locating desired scene 60
- Repeat playback 61
- A-B Repeat playback 61
- Program playback 62
- Random playback 62
- Changing angles 63
- Title selection 63
- DVD menu 63
- Changing soundtrack language 64
- Subtitles 64
- Disc status 65
- To turn off the PBC 65
- MP3/WMA/JPEG/DivX® and Audio CD operation 66

Function setup (DVD)

- Customizing the function settings 72
- Temporary cancel the rating level by DVD disc 77

Others

- Language code list 78
- Reception disturbances 79
- Troubleshooting 80
- Specifications 82
- Limited United States Warranty 83

Introduction

Notes and Information

On handling discs

- Do not touch the playback side of the disc.



- Do not attach paper or tape to discs.



On cleaning discs

- Fingerprints and dust on the disc cause picture and sound deterioration. Wipe the disc from the center outwards with a soft cloth. Always keep the disc clean.



- Do not use any type of solvent such as thinner, benzene, commercially available cleaners or antistatic spray for vinyl LPs. It may damage the disc.

On storing discs

- Do not store discs in a place subject to direct sunlight or near heat sources.
- Do not store discs in places subject to moisture and dust such as a bathroom or near a humidifier.
- Store discs vertically in a case. Stacking or placing objects on discs outside of their case may cause warping.

On Video CDs

This DVD supports Video CDs equipped with the PBC (Version 2.0) function. (PBC is the abbreviation of Playback Control.) You can enjoy two playback variations depending on types of discs.

- Video CD not equipped with PBC function (Version 1.1)**

Sound and movie can be played on this DVD in the same way as an audio CD.

- Video CD equipped with PBC function (Version 2.0)**

In addition to operation of a Video CD not equipped with the PBC function, you can enjoy playback of interactive software with search function by using the menu displayed on the TV screen (Menu Playback). Some of the functions described in this owner's manual may not work with some discs.

Structure of disc contents

Normally, DVD video discs are divided into titles, and the titles are sub-divided into chapters. Video CDs and Audio CDs are divided into tracks.

DVD video disc

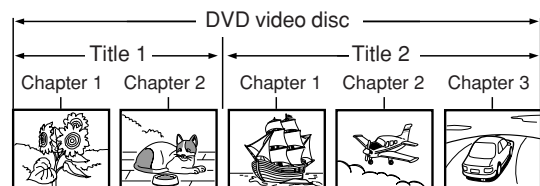

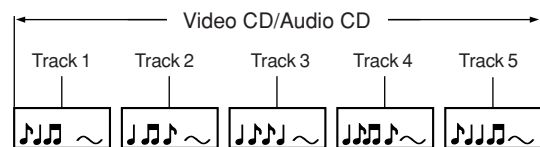

Video CD/Audio CD



Each title, chapter or track is assigned a number, which is called "title number", "chapter number" or "track number" respectively.

There may be discs that do not have these numbers.

Notes on region numbers

The region number of this unit is 1. If region numbers, which stand for their playable area, are printed on your DVD video disc and you do not find  or , disc playback will not be allowed by the player. (In this case, the unit will display a message on-screen.)

Notes on copyright

The unauthorized recording, use, distribution, or revision of copyrighted materials including, without limitation, television programs, videotapes, and DVDs, is prohibited under the Copyright Laws of the United States and other countries, and may subject you to civil and criminal liability.

This product incorporates copyright protection technology that is protected by method claims of certain U.S. patents and other intellectual property rights owned by Macrovision Corporation and other rights owners. Use of this copyright protection technology must be authorized by Macrovision Corporation, and is intended for home and other limited viewing uses only unless otherwise authorized by Macrovision Corporation. Reverse engineering or disassembly is prohibited.



About this owner's manual

This owner's manual explains the basic instructions of this unit. Some DVD video discs are produced in a manner that allows specific or limited operation during playback. As such, the unit may not respond to all operating commands. This is not a defect in the unit. Refer to instruction notes of discs.

The following symbol may appear on the TV screen during operation.

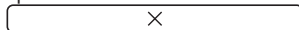

It means that the operation is not permitted by the unit or the disc.

For example, sometimes it is unable to stop the playback of copyright message of the disc when the STOP (■) button is pressed. Alternatively, this symbol may also indicate that the feature is not available for the disc.

USB Port Information

The USB port can be connected to USB storage devices (USB memory, memory card readers, [external USB hard drives, external USB optical drives], MP3 and WMA music players, and certain cameras with USB connectivity) that comply with the standards for the USB Mass Storage Class of USB compatible equipment. Because there are a broad variety of such devices, some functions of your storage device may not operate properly with the TV or it may not operate at all with the TV.

From the USB port, this TV is designed to display compatible JPEG, WMA, MP3 and DivX® data files. DivX VOD content and WMA content protected by DRM (digital rights management) is not supported for storage devices connected to the USB port.

Proper function may depend upon having the proper version of firmware installed on your storage device, and may further depend upon memory capacity and the connection status. The USB port has been tested and found to operate with test samples of the equipment listed below. You may find that versions of this equipment available to you do not operate properly for all functions or at all. The USB port can only be connected to USB storage devices (USB memory, memory card readers, [external USB hard drives, external USB optical drives], MP3 and WMA music players, and certain cameras with USB connectivity) that comply with the standards for the USB Mass Storage Class of USB compatible equipment. Please refer to "Connecting to a USB Storage Device" (19) for details and certain important precautions on connecting a USB storage device to this TV.

Equipment	Brand	Models
Memory Card Reader	San Disk	SDDR-89
	ZIO	CM-28100
	GE	HO97949
Digital Camera	Nikon	COOLPIX P2
	FUJIFILM	FinePix A345
USB Memory	Lexar	JDA1GB-275
	San Disk	SDCZ2-512-A10
	PNY	PFD01GU20RF
MP3 Player	SAMSUNG	YP-T7Z
	Sony	NW-E507
	RCA	RD2780

Playable discs

This unit can play the following discs.

	Disc Mark	Contents	Disc Size	Maximum playback time
DVD video discs		Audio + Video (moving pictures)	12 cm	Approx. 4 hours (single sided disc)
				Approx. 8 hours (double sided disc)
			8 cm	Approx. 80 minutes (single sided disc)
				Approx. 160 minutes (double sided disc)
Video CDs		Audio + Video (moving pictures)	12 cm	Approx. 74 minutes (single sided disc)
			8 cm	Approx. 20 minutes (single sided disc)
Audio CDs		Audio	12 cm	Approx. 74 minutes (single sided disc)
			8 cm	Approx. 20 minutes (single sided disc)

The following discs are also available.

- DVD-R/RW discs of DVD video format
 - CD-R/CD-RW discs of CD-DA, Video CD, MP3, WMA, JPEG or DivX® format
 - Kodak picture CD and FUJICOLOR CD format
- Some of these discs may be incompatible.

- You cannot play discs other than those listed above.
- You cannot play discs of DVD-RAM, DVD-ROM, Photo CD, etc., or non standardized discs even if they may be labeled as above.
- Some CD-R/RWs cannot be played back depending on the recording conditions.
- This unit uses the NTSC color system, and cannot play DVD video discs recorded in any other color system (PAL, SECAM, etc.).

Because of problems and errors that can occur during the creation of DVD and CD Software and/or the manufacture of DVD and CD discs, Toshiba cannot assure that the DVD player contained in this television will successfully play every disc bearing the DVD and CD logos. If you happen to experience any difficulty playing a DVD and/or CD disc on the DVD player contained in this television, please contact Toshiba Customer Service.

is a trademark of DVD Format/Logo Licensing Corporation.

Identification of controls

See the page in for details.

Front panel

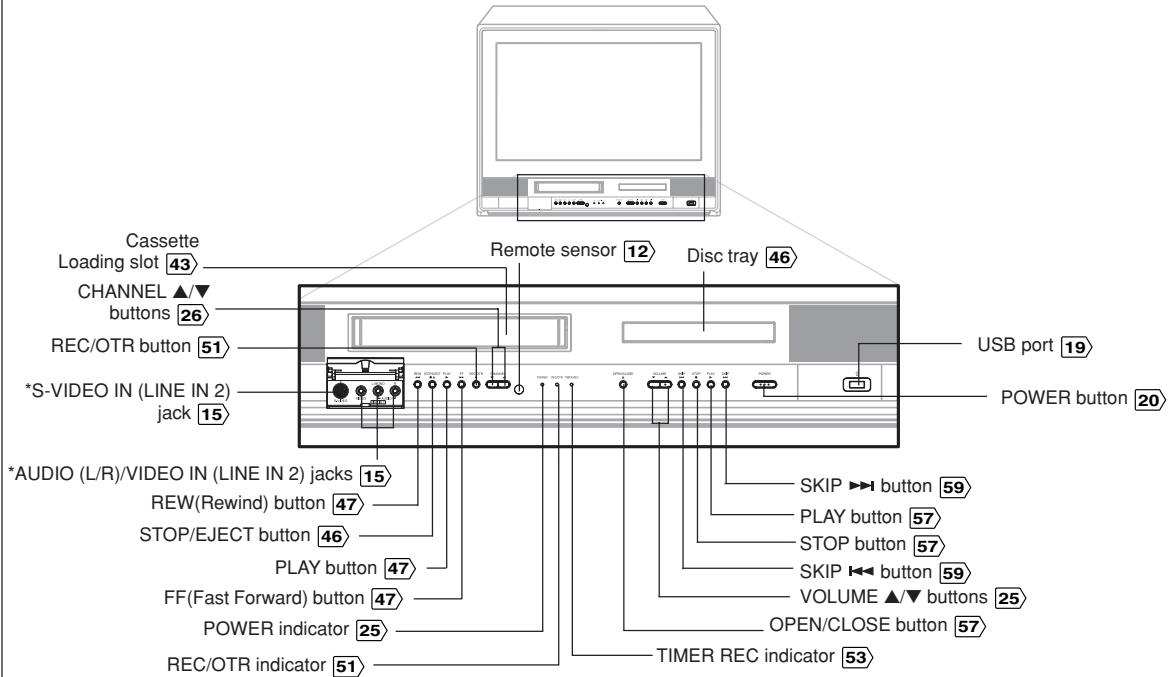

Please open the door on the front panel to access the *S-VIDEO/AUDIO (L/R)/VIDEO IN (LINE IN 2) jacks.

Rear panel

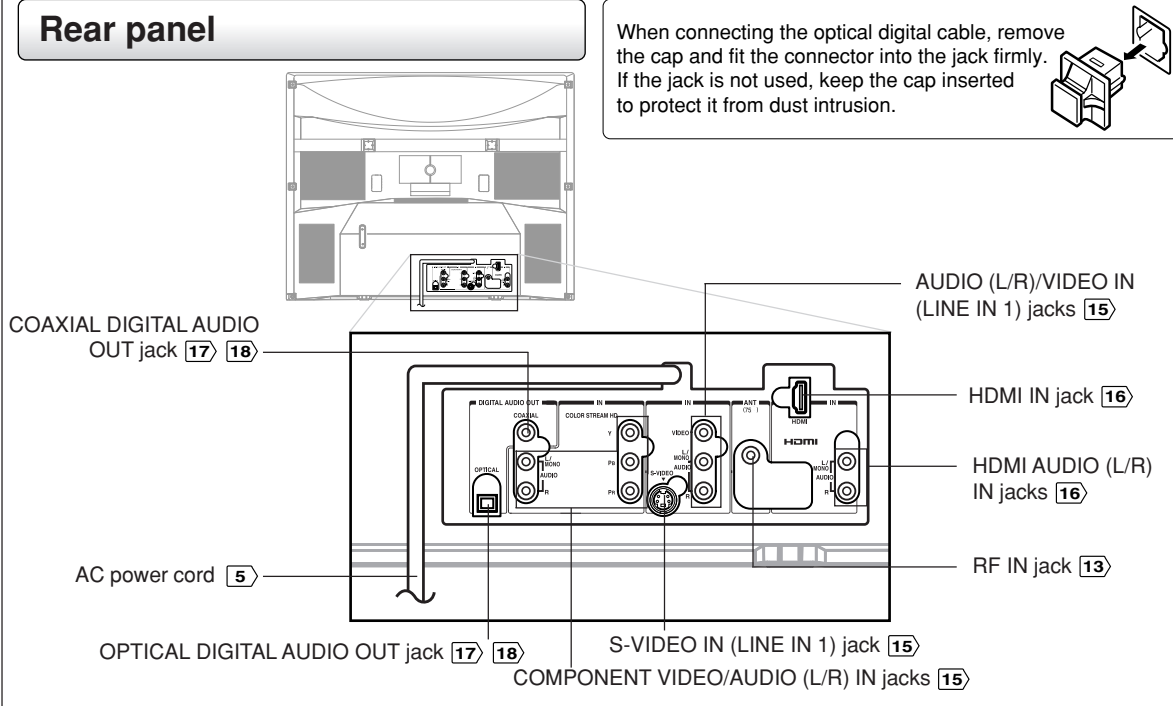

Remote control

The instructions in this manual describe the function on the remote control. See the page in  for details.

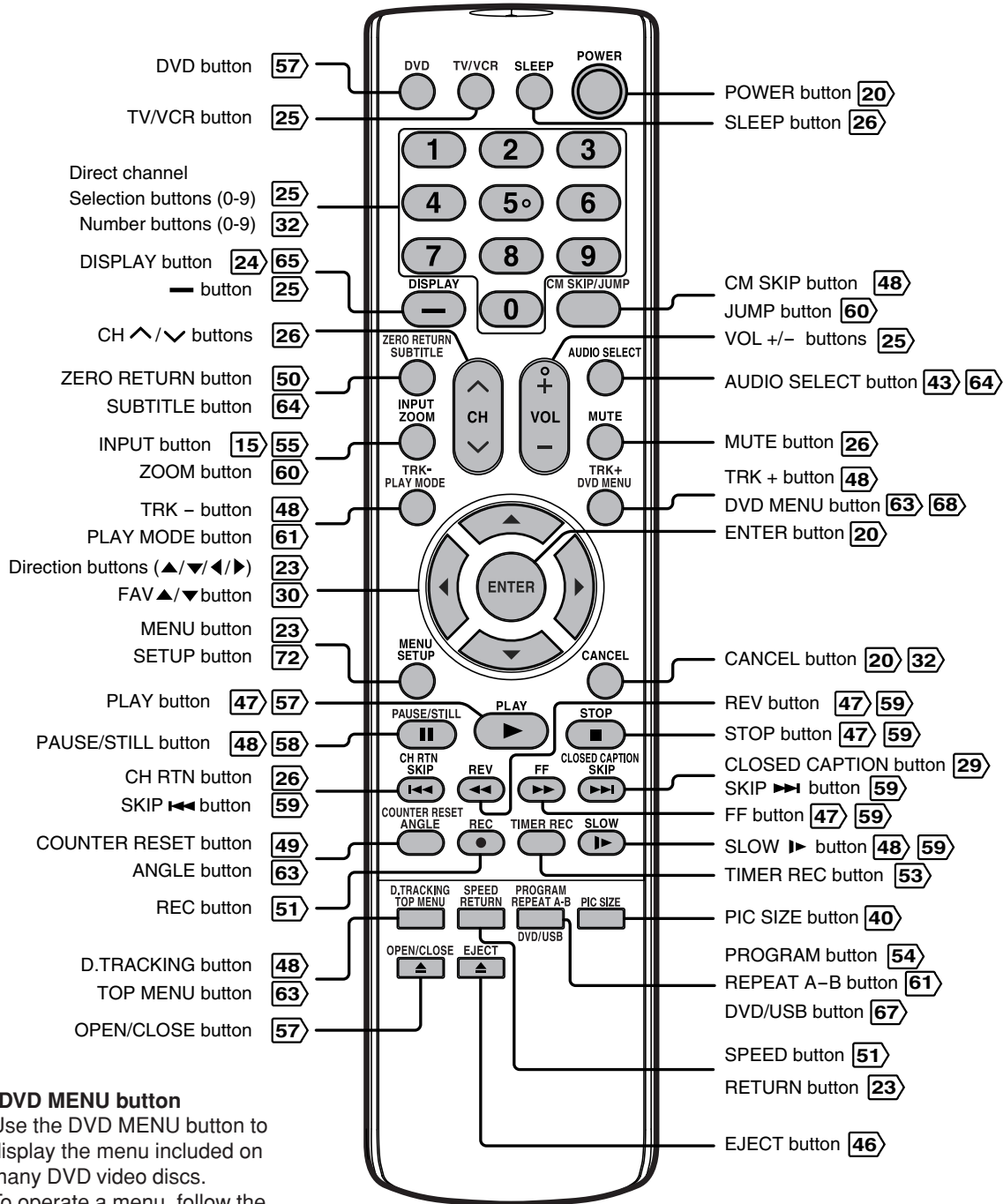

***DVD MENU button**
 Use the DVD MENU button to display the menu included on many DVD video discs. To operate a menu, follow the instructions in "DVD menu." **63**

Identification of controls (Continued)

Inserting batteries

1 Open the battery compartment cover in the direction of the arrow.

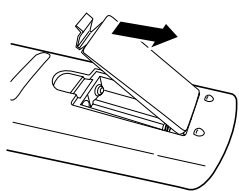

2 Install two "AAA" batteries (supplied), paying attention to the polarity diagram in the battery compartment.

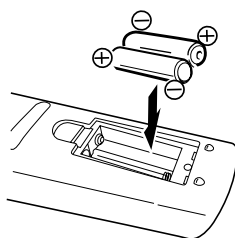

3 Replace the compartment cover.

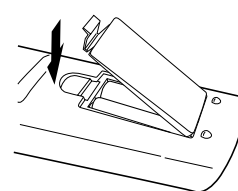

Caution:

Never throw batteries into a fire.

Notes:

- Be sure to use AAA size batteries.
- Dispose of batteries in a designated disposal area.
- Batteries should always be disposed of with the environment in mind. Always dispose of batteries in accordance with applicable laws and regulations.
- If the remote control does not operate correctly, or if the operating range becomes reduced, replace batteries with new ones.
- When necessary to replace batteries in the remote control, always replace both batteries with new ones. Never mix battery types or use new and used batteries in combination.
- Always remove batteries from remote control if they are dead or if the remote control is not to be used for an extended period of time. This will prevent battery acid from leaking into the battery compartment.

Remote control basics

- Press **POWER** to turn the unit on or off.
- Select your desired operating mode (TV or DVD) using **TV/VCR** or **DVD**.
- Tap **CH** \wedge or \vee to move through the channels one channel at a time.
- The **Direction** buttons (\blacktriangle / \blacktriangledown / \blacktriangleleft / \blacktriangleright) are also used to navigate on-screen menu system.
- You can directly access specific channels using **Direct channel selection** buttons.

Operation:

- Aim the remote control at the remote sensor and press control buttons to operate.
- Operate the remote control within 30° angle on either side of the remote sensor, up to a distance of approx. 5 meters.

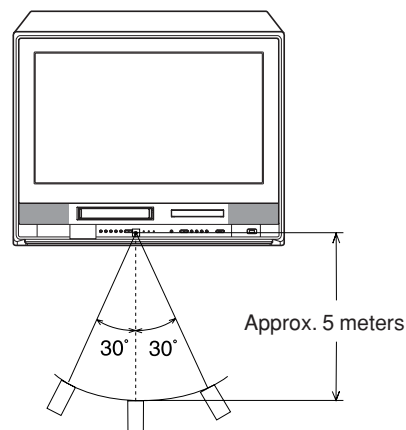

Antenna connections

If you are using an indoor or outdoor antenna, follow the instructions below that correspond to your antenna system. If you are using a cable TV service (CABLE), see page 14 for cable TV connections.

Combination VHF/UHF antenna (Single 75 ohm cable or 300 ohm twin-lead wire)

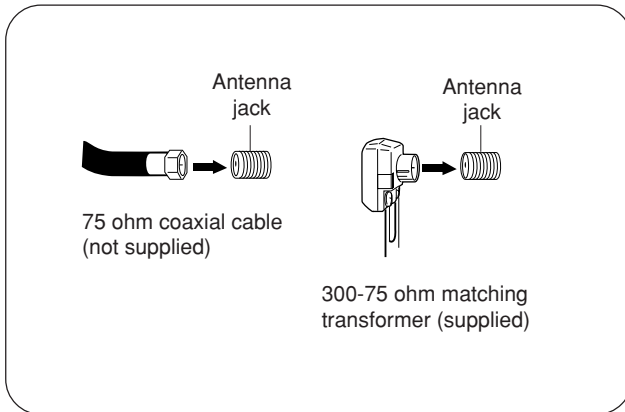

Connect the 75 ohm cable from the combination VHF/UHF antenna to the antenna jack.

If your combination VHF/UHF antenna has a 300 ohm twin-lead wire, the use of the 300-75 ohm matching transformer may be necessary.

Connections

Combination VHF/UHF antenna (Separate VHF and UHF 300 ohm twin-lead wires)

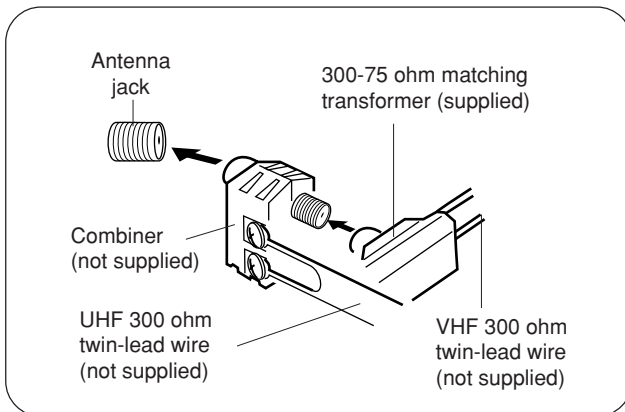

Connect the UHF 300 ohm twin-lead wire to the combiner (not supplied). Connect the VHF 300 ohm twin-lead wire to the 300-75 ohm matching transformer. Attach the transformer to the combiner, then attach the combiner to the antenna jack.

Separate VHF/UHF antennas (75 ohm VHF cable and 300 ohm UHF twin-lead wires)

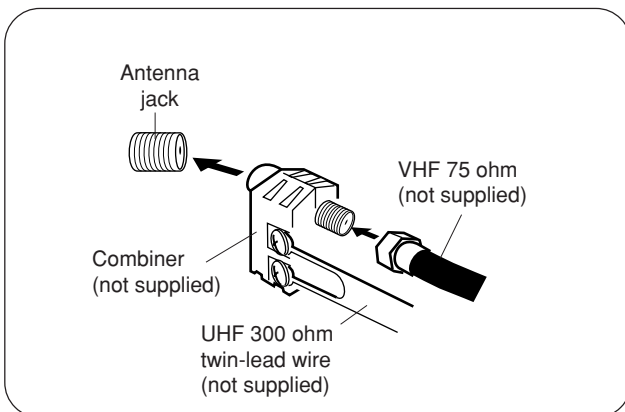

Connect the VHF 75 ohm cable and UHF 300 ohm twin-lead wire to the combiner (not supplied). Attach the combiner to the antenna jack.

Cable TV connections

This unit has an extended tuning range and can tune most cable channels without using a cable TV converter box. Some cable companies offer "premium pay channels" in which the signal is scrambled. Descrambling these signals for normal viewing requires the use of a descrambler device which is generally provided by the cable TV company.

For subscribers to basic cable TV service

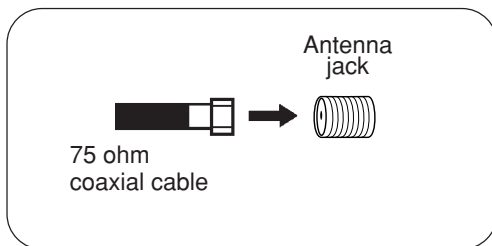

For basic cable TV service not requiring a converter/descrambler box, connect the cable TV 75 ohm coaxial cable directly to the Antenna jack on the back of the unit.

For subscribers to scrambled cable TV service

If you subscribe to a cable TV service which requires the use of a converter/descrambler box, connect the incoming 75 ohm coaxial cable to the converter/descrambler box. Using another 75 ohm coaxial cable, connect the output jack of the converter/descrambler box to the antenna jack on the unit. Follow the connections shown below. Set the unit to the output channel of the converter/descrambler box (usually channel 3 or 4) and use the converter/descrambler box to select channels.

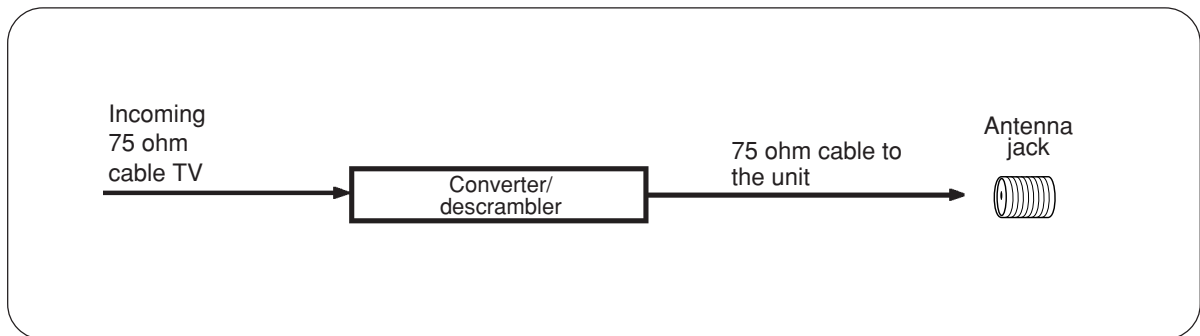

For subscribers to unscrambled basic cable TV service with scrambled premium channels

If you subscribe to a cable TV service in which basic channels are unscrambled and premium channels require the use of a converter/descrambler box, you may wish to use a signal splitter and an A/B switch box (available from the cable TV company or an electronics supply store). Follow the connections shown below. With the switch in the "B" position, you can directly tune any unscrambled channels on your unit. With the switch in the "A" position, tune your unit to the output of the converter/descrambler box (usually channel 3 or 4) and use the converter/descrambler box to tune scrambled channels.

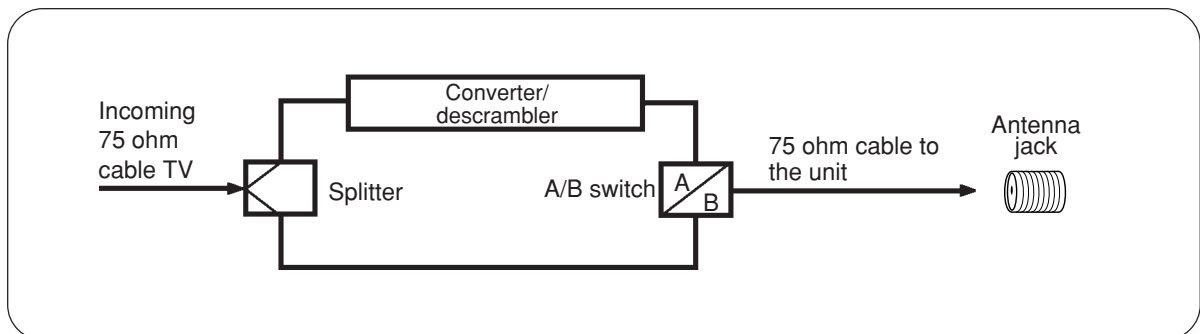



Connecting to optional equipment

Before connecting the unit to other equipment, be sure to turn off the power and unplug all of the equipment from the wall outlet before making any connections. You can enjoy the camcorder or high quality dynamic sounds of DVD video discs or audio CDs by connecting the unit to optional audio equipment.

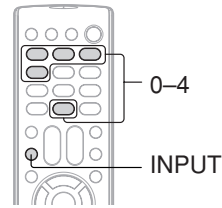

Selecting the video input source

Press **INPUT** to view a signal from another device connected to your TV, such as a VCR or DVD player. You can select ANT, VIDEO1, VIDEO2 (on the front panel), ColorStream HD or HDMI depending on which input jacks you used to connect your devices.

SOURCE SELECTION	
0.	ANT
1.	VIDEO1
2.	VIDEO2
3.	ColorStream HD
4.	HDMI
@/0-4:SELECT	

Press **INPUT** on the remote control to display the current signal source. To change the input source, press **INPUT** again or press **0-4**.

Connecting to a camcorder

To playback from the camcorder, connect the camcorder to the unit as shown. And select "VIDEO2" input source.

➔ Signal flow

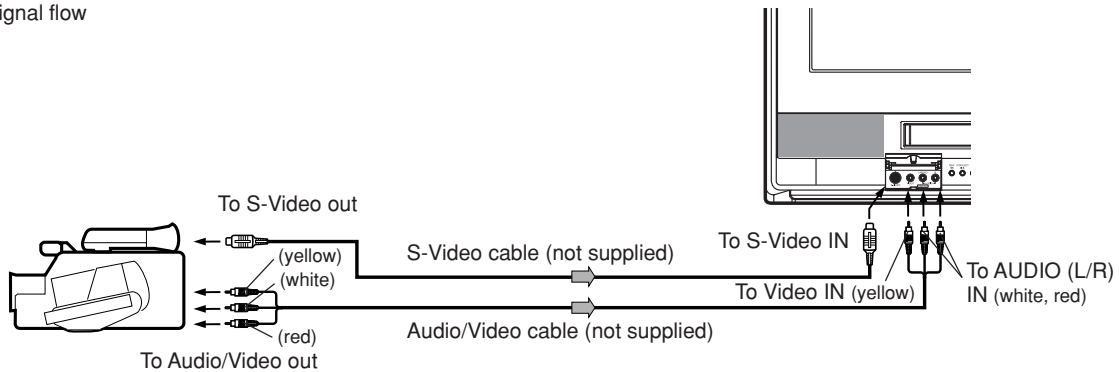

Notes:

- If your camcorder has S-video, you can use an S-video cable (plus the standard audio cables) instead of a standard video cable for better picture quality. Do not connect both a standard video cable and an S-video cable at the same time, or the picture performance will be unacceptable.
- You can also use the S-VIDEO IN or AUDIO(L/R)/VIDEO IN jacks on the rear of the unit.

Connecting to a DTV receiver / set-top box with ColorStream® (component video)

This connection allows you to watch DTV (digital TV) and TV programs, and record DTV and TV programs. Your TV has ColorStream® (component video) inputs. Connecting your TV to a DTV receiver with component video can greatly enhance picture quality and realism.

➔ Signal flow

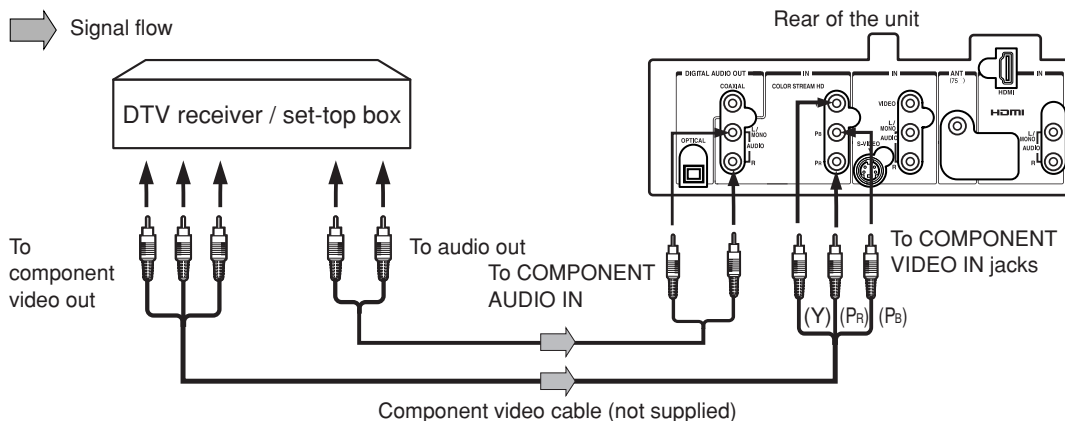

Connecting to optional equipment (Continued)

Connecting an HDMI™ device to the HDMI input

The HDMI^[1] input on your unit receives digital audio and uncompressed digital video from an HDMI device or uncompressed digital video from a DVI^[2] device.

This input is designed to accept HDCP^[3] program material in digital form from EIA/CEA-861/861B-compliant^[4] consumer electronic devices (such as a set-top box or DVD player with HDMI or DVI output.)

The HDMI input is designed for best performance with high definition video signals. It will accept and display 480i, 480p, 720p and 1080i signals.

[1] HDMI = High-Definition Multimedia Interface.

[2] DVI = Digital Visual Interface.

[3] HDCP = High-bandwidth Digital Content Protection.

[4] EIA/CEA-861/861B compliance covers the transmission of uncompressed digital video with high-bandwidth digital content protection, which is being standardized for reception of high-definition video signals. **Because this is an evolving technology, it is possible that some devices may not operate properly with the unit.**

HDMI cable transfers both video and audio. Separate analog audio cables are not required (see illustration below.)

For proper operation, it is recommended that you use as short an HDMI cable as possible. You should not encounter difficulty if you use an HDMI cable that is shorter than 16.4 ft (5m.)

You must set the HDMI audio input setting to “HDMI” in the AUDIO menu [44].

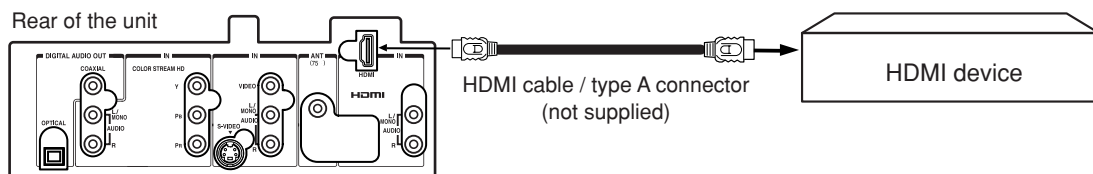

Connecting a DVI device to the HDMI input

An HDMI-to-DVI adapter cable transfers only video.

Separate analog audio cables are required (see illustration below.)

For proper operation, the length of an HDMI-to-DVI adapter cable should not exceed 9.8 ft (3m.) The recommended length is 6.6 ft (2m.)

You must set the HDMI audio input setting to “DVI” in the AUDIO menu [44].

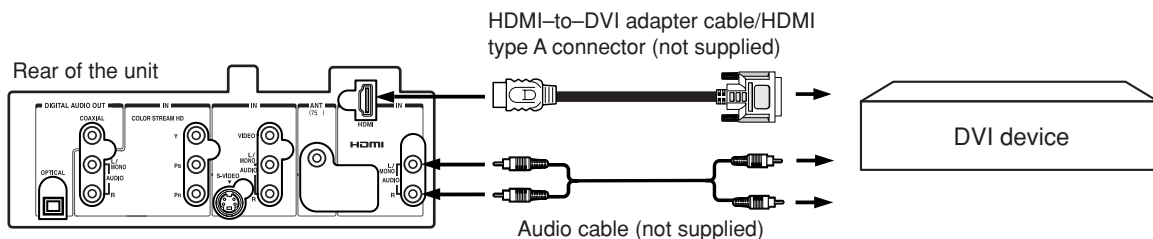

Notes:





- **NEVER CONNECT THIS TV TO A PERSONAL COMPUTER (PC.) This TV is not intended for use with a PC.**
- To ensure that the HDMI or DVI device is reset properly, please follow these procedures:
- When turning on your electronic components, **turn on the TV first**, and then the HDMI or DVI device.
- When turning off your electronic components, **turn off the HDMI or DVI device first**, and then the unit.
- If you connect an HDMI device and analog audio cables and play media with digital audio output, to hear digital audio you must set the HDMI audio input setting to “HDMI” [44].

HDMI, the HDMI logo, and High-Definition Multimedia Interface are trademarks or registered trademarks of HDMI Licensing, LLC.



You can enjoy high quality dynamic sounds by connecting the unit to optional audio equipment.

This section uses the following reference mark.

-  : Front speaker
-  : Rear speaker
-  : Sub woofer
-  : Center speaker
-  : Signal flow

Connecting to an amplifier equipped with a Dolby® Digital decoder

Dolby Digital
 Dolby Digital is the surround sound technology used in theaters showing the latest movies, and is now available to reproduce this realistic effect in the home. You can enjoy motion picture and live concert DVD video discs with this dynamic realistic sound by connecting the unit to a 6 channel amplifier equipped with a Dolby Digital decoder or Dolby Digital processor. If you have a Dolby Surround Pro Logic decoder, you will obtain the full benefit of Pro Logic from the same DVD movies that provide full 5.1-channel Dolby Digital soundtracks, as well as from titles with the Dolby Surround mark.

Connections

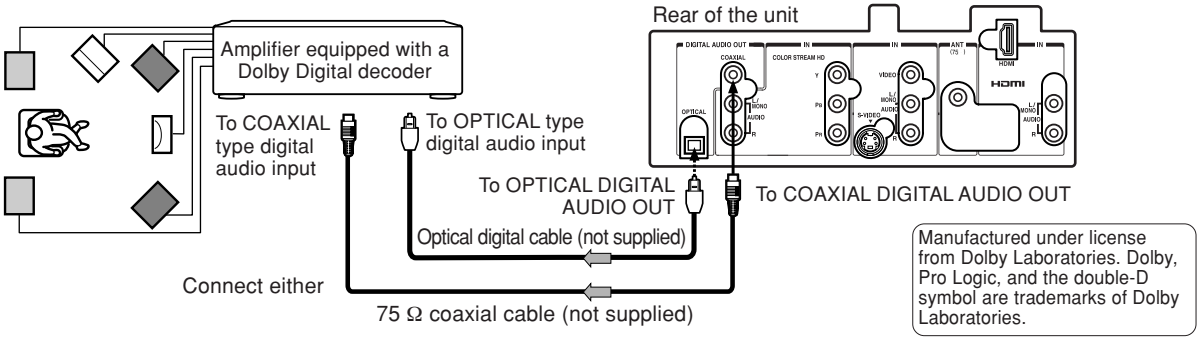

Connecting to an amplifier equipped with a DTS decoder

Digital Theater Systems (DTS)
 DTS is a high quality surround technology used in theaters and now available for home use, on DVD video discs or audio CDs. If you have a DTS decoder or processor, you can obtain the full benefit of 5.1 channel DTS encoded sound tracks on DVD video discs or audio CDs.

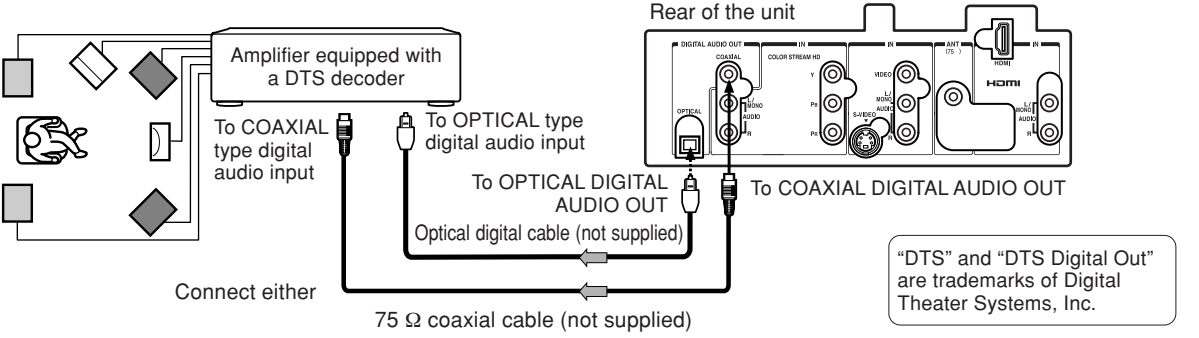

Connecting to optional equipment (Continued)

Connecting to an amplifier equipped with a MPEG audio decoder

MPEG2 sound

You can enjoy motion picture and live concert DVD video discs with dynamic realistic sound by connecting an amplifier equipped with an MPEG2 audio decoder or MPEG2 audio processor.

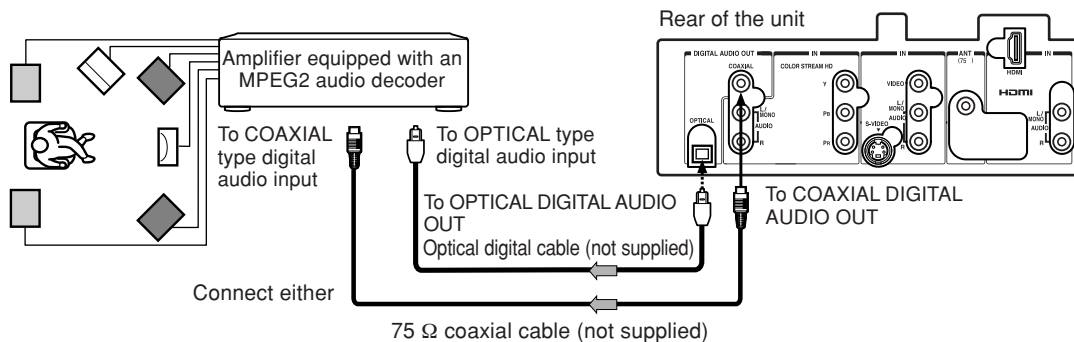

Connecting to an amplifier equipped with a digital audio input

2 channel digital stereo

You can enjoy the dynamic sound of 2 channel digital stereo by connecting an amplifier equipped with a digital audio input and speaker system (right and left front speakers).

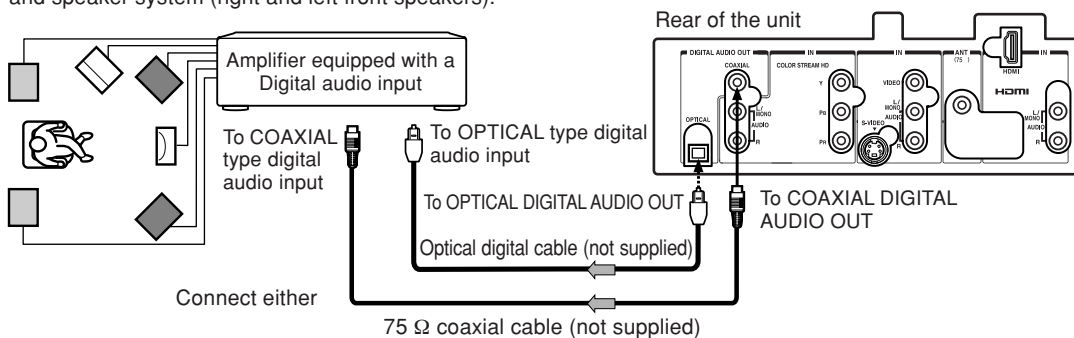

Notes:

- DO NOT connect the OPTICAL DIGITAL AUDIO OUT jack or COAXIAL DIGITAL AUDIO OUT jack of the unit to the AC-3 RF input of a Dolby Digital Receiver. This input on your A/V Receiver is reserved for Laserdisc use only and is incompatible with the OPTICAL DIGITAL AUDIO OUT jack or COAXIAL DIGITAL AUDIO OUT jack of the unit.
- Connect the OPTICAL DIGITAL AUDIO OUT jack or COAXIAL DIGITAL AUDIO OUT jack of the unit to the "OPTICAL" or "COAXIAL" input of a Receiver or Processor.
- Refer to the owner's manual of the connected equipment as well.
- When you connect the unit to other equipment, be sure to turn off the power and unplug all of the equipment from the wall outlet before making any connections.
- The output sound of the unit has a wide dynamic range. Be sure to adjust the receiver's volume to a moderate listening level. Otherwise, the speakers may be damaged by a sudden high volume sound.
- Turn off the amplifier before you connect or disconnect the unit's power cord. If you leave the amplifier's power on, the speakers may be damaged.



Connecting to a USB Storage Device

This unit can be used to read JPEG, WMA, MP3 and DivX® data for any memory card reader/writer or digital camera that accepts USB Mass Storage Class.

For devices that are compatible with the unit's USB port, please refer to page 9.

Note:

Some USB storage device or USB cable may not be able to connect to the USB port of the TV because the shape of the USB connector is not compatible with the USB port of the TV. In that case, please use a USB extension cable (not supplied).

Connecting to a USB Storage Device

➔ Signal flow

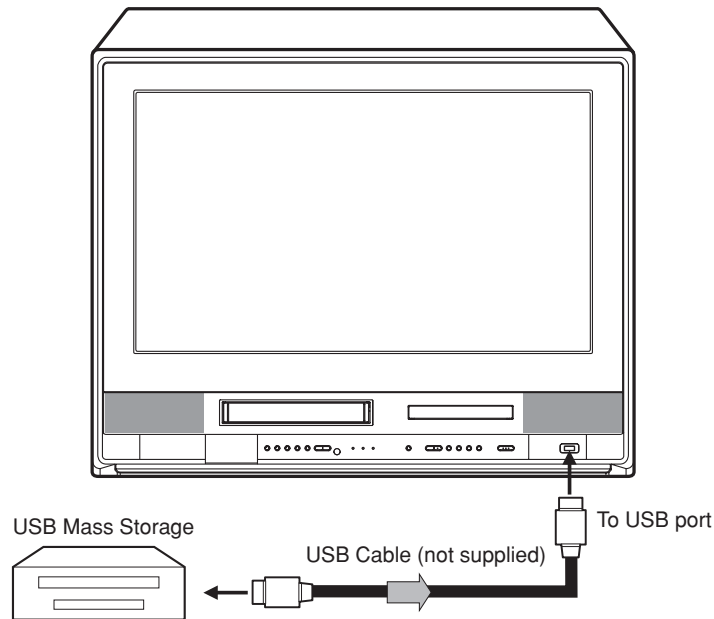

Notes:

To be read by the TV, compatible files must comply with the naming and directory requirements described on 66.

The following procedures should be followed when connecting and disconnecting any USB storage device to the TV or inserting or removing any memory card from any memory reader connected to the USB port of the TV:

- Do not connect or disconnect the USB storage device, or insert or remove any memory card from any memory reader, music player or camera connected to the USB port of the TV unless the TV is off or in DISC mode 67.
- Do not connect or disconnect the TV's power cord while any USB storage device is connected to the TV. This restriction applies no matter what the operating mode of the TV.
- Review the instructions for your USB storage device and comply with them in using the device with the TV.
- Do not connect other USB devices (keyboards, printers, or any other non-USB Mass Storage Class device) to the USB port. Doing so may damage the TV or the USB device.
- Do not attempt to use a USB hub. Only one USB storage device may be connected to the TV at once.

Failure to comply with these directions may result in data loss or in damage to the USB storage device or the memory card.

IMPORTANT: BECAUSE OF THE RISK OF DATA LOSS OR DAMAGE WHEN USING THIS DEVICE, WE RECOMMEND THAT YOU BACK UP ANY FILES THAT WILL BE USED WITH THIS DEVICE. IT IS YOUR RESPONSIBILITY TO COMPLY WITH APPLICABLE COPYRIGHT LAWS IN USING THIS DEVICE (INCLUDING MAKING BACK UP COPIES).



Starting setup

The STARTING SETUP function makes installing your unit easily. It leads you the Language selection, TV/CABLE selection and auto channel memory automatically.

IMPORTANT: Make sure that the antenna or cable TV system connection is made!

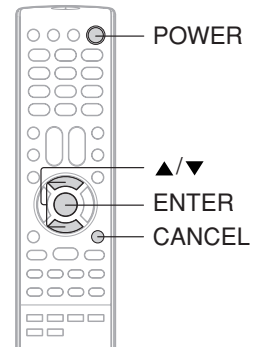

Starting setup

- 1** Press **POWER**.
The starting setup function begins and the Language setup menu appears on the screen. Press **▲** or **▼** to select your desired language, then press **ENTER**.



- 2** Press **▲** or **▼** to select "TV" or "CABLE", then press **ENTER**.



- 3** Press **▲** or **▼** to select "START", then press **ENTER**.
If you select "CANCEL" and press **ENTER**, the STARTING SETUP stops and changes to the TV screen.



- 4** Now the "CH PROGRAM" starts.
After the starting setup is completed, the TV channel appears on the screen.



Notes:

- The starting setup function will work only when you press **POWER** for the first time.
- The process of "CH PROGRAM" may take 15 - 30 minutes to complete, depending on your regional cable service.
- If you press **CANCEL** in the process of "CH PROGRAM", you can do starting setup function again.



Clock setting

The auto clock function will automatically set the built-in clock (Month, Day, Year and Time) when the unit is connected to an antenna or cable system and it is turned off. As the unit searches for a receivable station in your area and it receives a broadcast signal for auto clock, the auto clock needs several minutes to set itself.

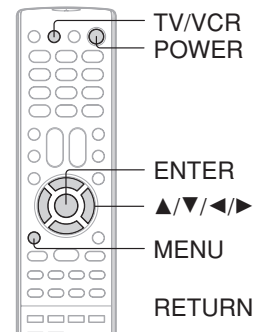

Auto clock setting

Preparation:

- Connect the antenna or cable system.
- If you use a cable box, turn it on.
- Plug the AC power cord to the AC outlet.

- 1 Make sure the unit is turned off.**
 - If you press **POWER**, the Auto Clock set is not effective.

- 2 Wait at least three minutes and press POWER.**
 - Depending on the reception condition, it may take approx. thirty minutes.
 - The **POWER** indicator will light.

- 3 Press TV/VCR to select TV/VCR mode.**

Auto clock adjustment

The Auto clock adjustment will be performed at 12:00 PM everyday if you turn off the unit.

- If you use a cable box and you want Auto Clock adjustment to be performed, the cable box must be left on.
- The Auto Clock adjustment is not effective when there is a difference of more than 5 minutes exists between the built-in clock time and the actual time.

To set auto clock to OFF

When shipped from factory the AUTO CLOCK is set to "ON". But if you do not want auto clock set (Adjustment):

- 1 Press MENU in the TV mode, then press ◀ or ▶ to select TV SETUP menu.**



- 2 Press ▲ or ▼ to select "AUTO CLOCK".**



- 3 Press ◀ or ▶ to select "OFF".**



- 4 Press MENU repeatedly until the menu screen is cleared.**

- When the AUTO CLOCK is set to "OFF", the Auto Clock adjustment does not function.
- Set the clock manually [23].

Notes:

- If the unit does not operate properly, or No key operation (by the unit and/or the remote control): Static electricity, etc., may affect the player's operation. Disconnect the AC power cord once, then connect it again.
- The TV section has its own menu and also DVD section has its own menu [72].
- If no buttons are pressed for more than 60 seconds, the TV/VCR menu screen will return to normal TV operation automatically.

Clock setting (Continued)

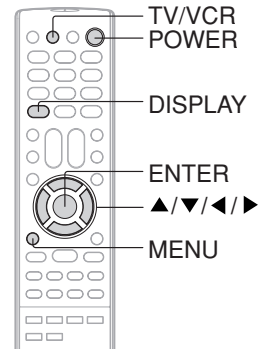

To set standard time

In the rare event that you live within broadcast range of two stations in two different time zones, the unit may recognize the wrong station for the auto clock set. To correct the situation:

- 1** Press **MENU** in the TV mode, then press **◀** or **▶** to select **TV SETUP** menu.
- 2** Press **▲** or **▼** to select **"STANDARD TIME"**, then press **▶**.
- 3** Press **▲/▼/◀/▶** to select your time zone, then press **ENTER**.

ATLANTIC	: GMT-4hours
EASTERN	: GMT-5hours
CENTRAL	: GMT-6hours
MOUNTAIN	: GMT-7hours
PACIFIC	: GMT-8hours
ALASKA	: GMT-9hours
HAWAII	: GMT-10hours
AUTO	: AUTO SET

(GMT: Greenwich Mean Time)
- 4** Press **MENU** repeatedly until the menu screen is cleared.

Note:
To be able to select the standard time, the clock must first be set by "AUTO CLOCK" once.

To set daylight saving time

You can set the daylight saving time automatically or manually.

- 1** Press **MENU** in the TV mode, then press **◀** or **▶** to select **TV SETUP** menu.
- 2** Press **▲** or **▼** to select **"DAYLIGHT SAVING TIME"**.
- 3** Press **◀** or **▶** to select one of the options, then press **ENTER**.

ON: for manual setting (forward one hour)
OFF: for manual setting (back one hour)
AUTO: for automatic setting (read EDS in the signal)

When you want to set the daylight saving time manually, on the first Sunday in April you set to "ON", and on the last Sunday in October you set to "OFF".
- 4** Press **MENU** repeatedly until the menu screen is cleared.

Notes:

- When shipped from factory, the DAYLIGHT SAVING TIME is set to "AUTO" position.
- When the clock is not set, daylight saving time setting is not available.
- When there is no daylight saving time in your area, always select "OFF" position in step 3.



Clock setting (Continued) / Setting the language

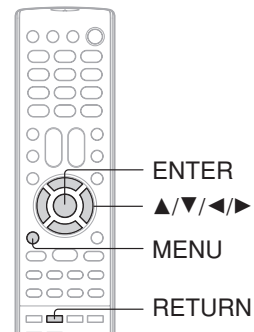

Manual Clock setting

You must set the date and time manually for timer recordings, ON/OFF timer.

EXAMPLE: Setting the clock to "8:30 AM", 28th. (SAT) October, 2006.

1 Press MENU in the TV mode, then press ◀ or ▶ to select TV SETUP menu.



2 Press ▲ or ▼ to select "CLOCK SET", then press ▶. The CLOCK SET menu will appear.



3 Press ◀ or ▶ to set the month, then press ▼.

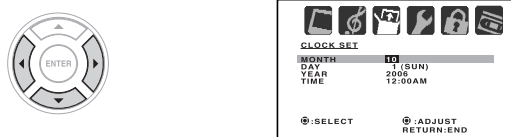

4 Set the day, year and time as in step 3, then press ENTER.

5 After setting the clock, date and time starts functioning automatically.

■ **To make corrections anytime during the process**

Press ▲ or ▼ repeatedly until the item you want, then set the item again.

Notes:

- After a power failure or disconnection of the power, the timer settings will be lost. In this case, reset the present time.
- When you set the minute, you can change in 10-minutes step by holding down ◀ or ▶.

Setting the language

This unit can display the on screen language in English, Spanish or French.

1 Press TV/VCR to select TV/VCR mode.



2 Press MENU in the TV mode, then press ◀ or ▶ to select TV SETUP menu.



3 Press ▲ or ▼ to select "LANGUAGE".



4 Press ◀ or ▶ to select the desired language: English (ENGLISH), French (FRANÇAIS) or Spanish (ESPAÑOL).



5 Press RETURN to clear the menu screen.



Basic setup

TV/VCR operation status

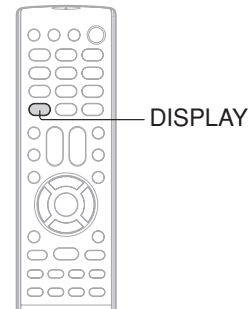

TV/VCR operation status

While watching TV

Press **DISPLAY** to display the information on the screen.
 To cancel the display, press **DISPLAY** again.
 When the TV receives a digital signal, press once, the digital information will appear.

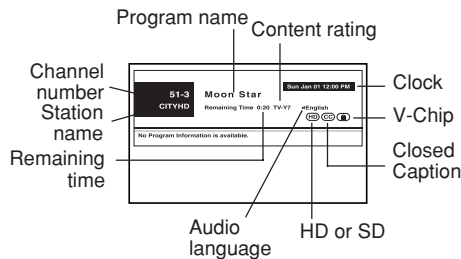

Press **DISPLAY** again, the analog information will appear.

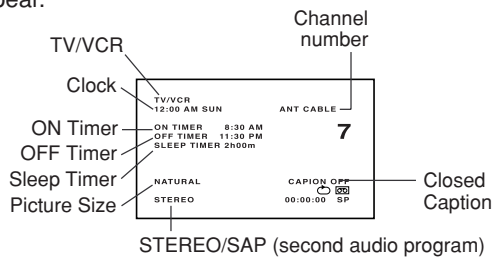

Press **DISPLAY** again to clear the call display.

While operating a tape

Press **DISPLAY** to display the information on the screen.
 To cancel the display, press **DISPLAY** again.

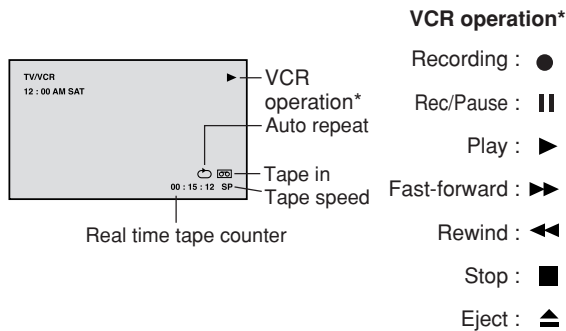



TV operation

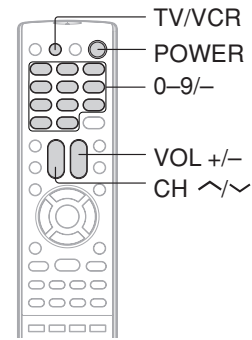

TV operation

1 To turn on the unit, press POWER.
The Power indicator will light.
• Every time you turn on the TV, the unit starts from TV mode. When you use TV after DVD operation, press TV/VCR.

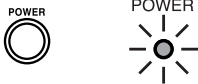

2 Adjust the volume level by pressing VOL + or -.
The volume level will be indicated on the screen by green bars. As the volume level increases, so do the number of bars. If the volume decreases, the number of green bars also decreases.



3 Set the TV/CABLE selection to the appropriate position [27].

TV - VHF/UHF channels
CABLE - Cable TV channels

4 Press Direct channel selection buttons (0-9) or CH ^ or v to select the channel.



TO SELECT ANALOG CHANNELS

When the TV/CABLE selection is in the CABLE position, channels can be selected as follows:

TO SELECT CABLE TV CHANNELS:

- 1-9: Press **0** twice, then 1-9 as needed.
Example, to select channel 2, press **0 0 2**.
- 10-99: Press **0**, then the remaining 2 digits.
Example, to select channel 12, press **0 1 2**.
- 100-125: Press the 3 digits in order. Example, to select channel 120, press **1 2 0**.

TO SELECT DIGITAL CHANNELS

Press the first 3 digits, then press the **"/DISPLAY"** button, followed by the remaining 3 digits.

Example, to select channel 015-001, press **0 1 5 - 0 0 1**.

TV	Cable TV
VHF	VHF
2-13	2-13
UHF	STD/HRC/IRC
14-69	14-36
	(A) (W)
	37-59
	(AA) (WW)
	60-85
	(AAA) (ZZZ)
	86-94
	(86) (94)
	95-99
	(A-5) (A-1)
	100-125
	(100) (125)
	01
	(5A)

Notes:

- If a channel with no broadcast is selected, the sound will automatically be muted.
- If a station being viewed stops broadcasting, the TV will automatically shut itself off after 15 minutes.
- Digital cable channels may be represented by channel numbers that include a "dash" (e.g., 85-002). These digital channel numbers may not match the numbers in the channel line-up provided by your cable company. This is not a malfunction.

TV operation

TV operation (Continued)

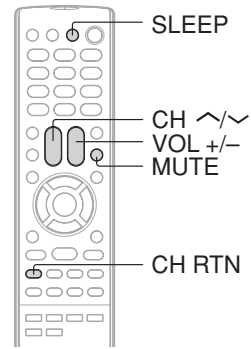

TV operation

■ CHANNEL UP/DOWN

Press and release **CH** \wedge or \vee . The channel automatically stops at the next channel set into memory. For proper operation, before selecting channels, they should be set into the memory. See "To memorize channels" **27**.

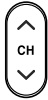

■ CHANNEL RETURN

This button allows you to go back to the last channel selected by pressing **CH RTN**. Press **CH RTN** again to return to the last channel you were watching.

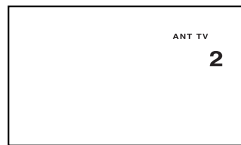

■ MUTE

Press **MUTE** to switch off the sound. The unit's sound will be silenced and "MUTE" will appear briefly on the screen. The sound can be switched back on by pressing this button again or one of **VOL +/-**.

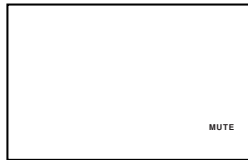

■ SLEEP

To set the unit to turn off after a preset amount of time, press **SLEEP** on the remote control. The clock will count down 10 minutes for each press of **SLEEP** (2h00m, 1h50m, ... 0h10m, 0h00m,). After the sleep time is programmed, the display will appear briefly every 10 minutes to remind you that the sleep timer is operating. To confirm the sleep timer setting, press **SLEEP** and the remaining time will be displayed for a few seconds. To cancel the sleep timer, press **SLEEP** repeatedly until the display turns to "0h00m".





To memorize channels

This unit is equipped with a channel memory feature which allows channels to skip up or down to the next channel set into memory, skipping over unwanted channels. Before selecting channels, they must be programmed into the unit's memory. To use this unit with an antenna, set the TV/CABLE selection to the TV position. When shipped from the factory, this selection is in the CABLE position.

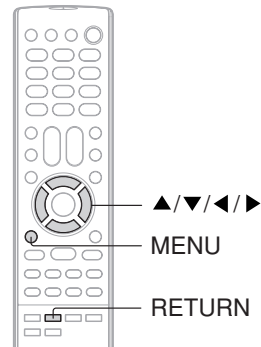

TV/CABLE selection

- 1 Press MENU in the TV mode, then press ◀ or ▶ to select TV SETUP menu.



- 2 Press ▲ or ▼ to select "TV/CABLE".



- 3 Press ◀ or ▶ to select "TV" or "CABLE".

TV - VHF/UHF channels
CABLE - Cable TV channels



- 4 Press RETURN to clear the menu screen.



To ADD/ERASE channels

- 1 Press MENU in the TV mode, then press ◀ or ▶ to select TV SETUP menu. Press ▲ or ▼ to select "ADD/ERASE".



- 2 Press ▶. The ADD/ERASE menu will appear. Press ▲ or ▼ to select "ADD/ERASE", then press ▶.



- 3 Press ▲ or ▼ to select the channel you want and then press ◀ or ▶ to select "ADD" or "ERASE".

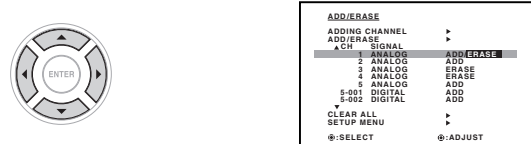

- 4 Repeat steps 3 for other channel you want to add or erase.

- 5 Press RETURN to clear the menu screen.



Automatic memory tuning

Press MENU in the TV mode, then press ◀ or ▶ to select TV SETUP menu. Press ▲ or ▼ to select the "CH PROGRAM", then press ▶.

The TV will begin memorizing all the channels available in your area.



To add a digital channel you are watching:
Select a channel you want to add. Then select "ADDING CHANNEL" in step 2, then press ▶.

TV operation

Closed captions

WHAT IS CLOSED CAPTIONING?

This television has the capability to decode and display closed captioned television programs. Closed captioning will display text on the screen for hearing impaired viewers or it will translate and display text in another language.

Closed captions

Captions: This closed caption mode will display text on the screen in English or another language (depending on the setting of the closed captions CH 1/2).

Generally, closed captions in English are transmitted on captions channel 1 and closed captions in other languages are transmitted on captions channel 2.

Text: The text closed caption mode will usually fill the screen with a programming schedule or other information. After selecting a closed caption mode, it will stay in effect until it is changed, even if the channel is changed. If the captions signal is lost due to a commercial or a break in the signal, the captions will reappear when the signal is received again. If the channels are changed, the captions will be delayed approximately 10 seconds. The captions will appear in places on the screen where they will least interfere with the picture, usually on the bottom of the screen. News programs will usually show three-line closed captions which scroll onto the screen. Most other shows provide two or three lined captions placed near the character who is speaking so the viewer can follow the dialogue. Words in italics or underlined describe titles, words in foreign languages or words requiring emphasis. Words that are sung usually appear enclosed by musical notes.

For television programs broadcasting with closed captions, look in your TV guide for the closed captions symbol (CC).

Notes:

- When selecting closed captions, the captioning will be delayed approximately 10 seconds.
- If no caption signal is received, no captions will appear, but the television will remain in the caption mode.
- Misspellings or unusual characters may occasionally appear during closed captioning. This is normal with closed captioning, especially with live programs. This is because during live programs, captions are also entered live. These transmissions do not allow time for editing.
- When captions are being displayed, on-screen displays, such as volume and mute may not be seen or may interfere with closed captions.
- Some cable systems and copy protection systems may interfere with the closed captioned signal.
- If using an indoor antenna or if TV reception is very poor, the closed caption decoder may not appear or may appear with strange characters or misspelled words. In this case, adjust the antenna for better reception or use an outdoor antenna.

NOTICE OF POSSIBLE ADVERSE EFFECTS ON TV PICTURE DISPLAY

Avoid displaying stationary images on your TV screen for extended periods of time. Fixed (non-moving) patterns or images (including but not limited to PIP/POP windows, closed captions, video game patterns, TV station logos, stock tickers, websites, and special formats that do not use the entire screen) can become permanently ingrained in the cathode ray tube(s) of the TV and cause subtle but permanent ghost images. **This type of damage is NOT COVERED BY YOUR WARRANTY.** See item 34 on page 4.

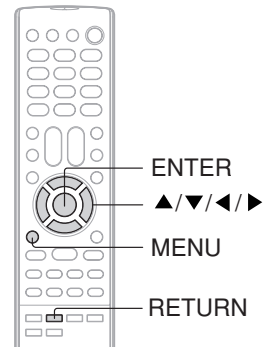

Using the closed caption feature

1 Press **MENU** in the TV mode, then press **◀** or **▶** to select **TV SETUP** menu.



2 Press **▲** or **▼** to select **"CLOSED CAPTION"**.



3 Press **◀** or **▶** to select the desired Closed Caption mode, as follows:

- To view captions, select C1 or C2 (C1 displays translation of the primary language in your area.)
Note: If the program or video you selected is not closed captioned, no captions will display on-screen.
- To view text, select T1 or T2.
Note: If text is not available in your viewing area, a black rectangle may appear on-screen. If this happens, set the Closed Caption feature to OFF.
- To turn the Closed Caption feature off, select OFF in the Closed Caption menu.

4 Press **RETURN** to clear the menu screen.



Notes:

- You also can display the CLOSED CAPTION menu screen by pressing CLOSED CAPTION on the remote control.
- When a digital signal is received, you can choose from CS1, CS2, CS3, CS4, CS5, CS6, C1, C2, C3, C4, T1, T2, T3, T4, and OFF.

Using the CC Advanced feature

This feature is designed to customize Digital Captions only.

1 Press **MENU** in the TV mode, then press **◀** or **▶** to select **TV SETUP** menu.



2 Press **▲** or **▼** to select **"CC ADVANCED"**, then press **▶**.



3 Press **▲** or **▼** to select desired item to adjust, then press **◀** or **▶**. Press **▲** or **▼** to select the desired setting, then press **ENTER**.

You can select from among the following items and parameters.

TEXT SIZE: AUTO, SMALL, STANDARD, LARGE

TEXT TYPE: AUTO, DEFAULT, MONO W. SERIF, PROP W. SERIF, MONO W/O SERIF, PROP W/O SERIF, CASUAL, CURSIVE, SMALL CAPITALS

TEXT COLOR: AUTO, BLACK, WHITE, RED, GREEN, BLUE, YELLOW, MAGENTA, CYAN

TEXT EDGE: AUTO, NONE, RAISED, DEPRESSED, UNIFORM, LEFT DROP SHADOW, RIGHT DROP SHADOW

BACKGROUND COLOR: AUTO, BLACK, WHITE, RED, GREEN, BLUE, YELLOW, MAGENTA, CYAN

4 Press **RETURN** to clear the menu screen.



Note:

Do not set the Closed Caption "Text Color" and "Background Color" as the same color or you will not be able to see the text.

Programming your favorite channels

You can preset up to 12 of your favorite channels using the Favorite Channel Programming feature. Because this feature scans through only your favorite channels, it allows you to skip other channels you do not normally watch.

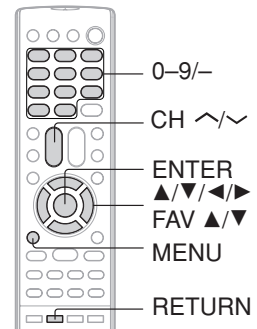

Programming you favorite channels

- 1** Select a channel you want to program as a favorite channel.

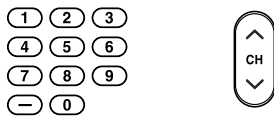

- 2** Press **MENU** in the TV mode, then press **◀** or **▶** to select **OPTION** menu, then press **▲** or **▼** to select "FAVORITE CH".



- 3** Press **◀** or **▶** to display the **FAVORITE CH** menu.

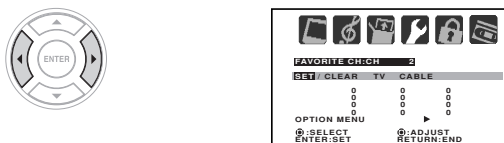

- 4** Press **◀** or **▶** to select "SET", then press **ENTER**.



If you return to **OPTION** menu, select "OPTION MENU" then press **▶**.

- 5** Press **RETURN** to clear the menu screen.



- 6** Repeat steps 1-4 for up to 12 channels.

- 7** Press **FAV ▲/▼** on the remote control to select your favorite channels.



Notes:

- You can still use **CH ^/~/** to scan through all the channels you programmed in the TV's memory.
- The **FAV ▲/▼** will not work until you have programmed your favorite channels.

To clear your favorite channels:

Follow steps 1~3 on the left, then press **◀** or **▶** to select "CLEAR". Press **ENTER** until "0" replaces the channel number you want to erase. Press **RETURN** to clear the menu screen.

Repeat this procedure for the other channels.



Labeling channels/Labeling the video input sources

Channel labels appear above the channel number display each time you watch the TV, select a channel, or press **DISPLAY**. You can choose any four characters to identify a channel. The video label feature allows you to label each input source for your TV.

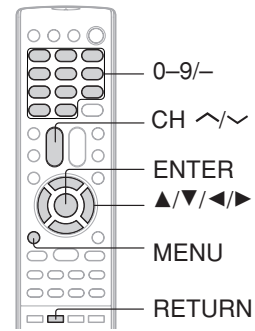

Labeling channels

1 Select a channel you want to label.

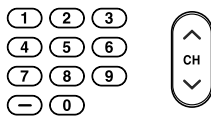

2 Press **MENU** in the TV mode, then press **◀** or **▶** to select **OPTION** menu. Press **▲** or **▼** to select **"CH LABEL"**.



3 Press **◀** or **▶** to display the **CH LABEL** menu. Press **◀** or **▶** to select **"SET"**, then press **ENTER**.



If you return to **OPTION** menu, select **"OPTION MENU"** then press **▶**.

4 Press **▲** or **▼** repeatedly until the character you want appears on the screen. Press **▶**.

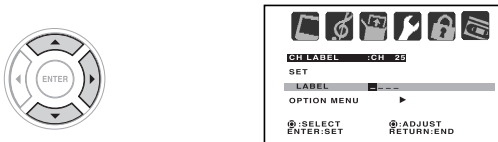

Note:
The character will change as below.

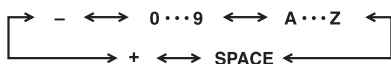

5 Repeat step 4 to enter the rest of the characters. Then press **ENTER**.



If you would like a blank space in the label name, you must choose an empty space from the list of characters; otherwise, a dash will appear in that space.

6 Press **RETURN** to clear the menu screen.



7 Repeat steps 1-6 for other channels. You can assign a label to each channel.

To erase channel labels:

Follow left steps 1-2, then select **"CLEAR"** in the step 3. Then press **ENTER**. Repeat this procedure for all channel labels which you want to erase.

Labeling the video input sources

1 Press **MENU** in the TV mode, then press **◀** or **▶** to select **OPTION** menu. Press **▲** or **▼** to select **"VIDEO LABEL"**.



2 Press **◀** or **▶** to display the **VIDEO LABEL** menu. Press **▲** or **▼** to select the video source you want to label, then press **◀** or **▶** to select label name.



- : Uses the default label name
 VCR : Video cassette recorder
 DVD : DVD video
 DTV : Digital TV set-top box

SAT : Satellite box
 CBL : Cable box
 HD : HDMI device (only in HDMI)

3 Press **RETURN** to clear the menu screen.



TV operation

Setting the V-Chip

An age limitation can be set to forbid children to watch programs according to "TV RATING" and "MOVIE RATING" level set. To use the V-Chip function, you must register a password.

Notes:

- If you forget the password, you cannot set the V-Chip.
- To avoid forgetting the password, write it down and keep in the safe place.

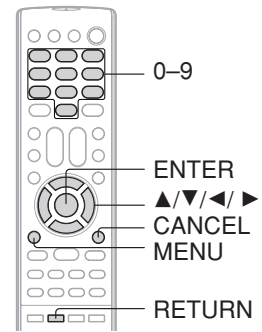

To register password

1 Press MENU in the TV mode, then press ◀ or ▶ to select LOCKS menu.



2 Press ▲ or ▼ to display the password entering mode.



3 Enter the password (4 digits) using Number buttons (0-9), then press ENTER.

- If you input a wrong number, press CANCEL.

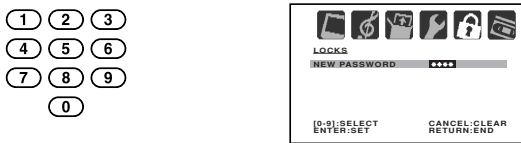

"*" appears instead of the number.



4 Enter the same password again using Number buttons (0-9) for safety, then press ENTER.

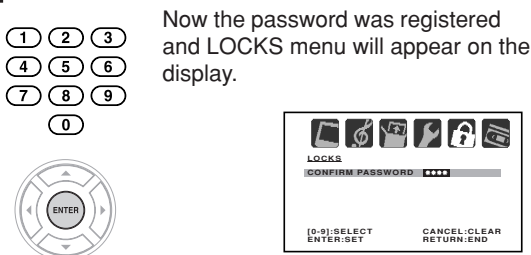

Now the password was registered and LOCKS menu will appear on the display.

To change password

1 In the LOCKS menu, press ▲ or ▼ to select "NEW PASSWORD", then press ▶.



2 Enter the new password using Number buttons (0-9), then press ENTER.

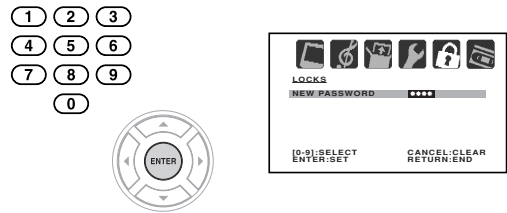

3 Enter the same password again using Number buttons (0-9) for safety, then press ENTER.

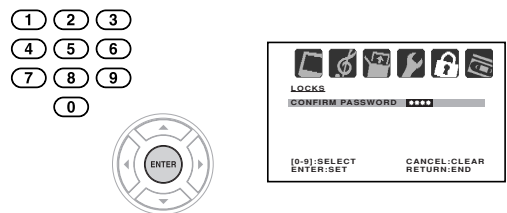

4 Press RETURN to clear the menu screen.



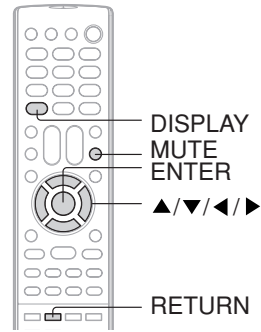

To set the V-Chip

1 In the LOCKS menu, press **▲** or **▼** to select "V-CHIP SET", then press **▶**.

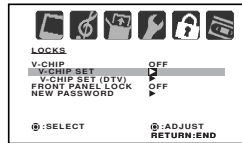

Note:

You can use V-CHIP SET (DTV) function when the digital broadcasting with a new rating system is received on the TV.

2 Press **▲** or **▼** to select "TV RATING", then press **◀** or **▶** to select the desired setting.

- OFF** : TV RATING is not set
- TV-Y** : All children
- TV-Y7** : 7 years old and above
- TV-G** : General audience
- TV-PG** : Parental guidance
- TV-14** : 14 years old and above
- TV-MA** : 17 years old and above

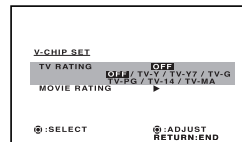

When you select TV-Y7, TV-PG, TV-14 or TV-MA, press **DISPLAY** to show the contained rating. Press **▲/▼/◀/▶** to select the desired item you want.



3 Press **▲** or **▼** to select "MOVIE RATING", then press **▶**.

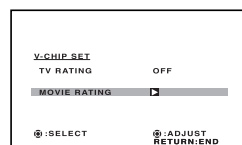

4 Press **▲** or **▼** to select desired rating, then press **◀** or **▶** to select ON or OFF. Press **ENTER** twice.

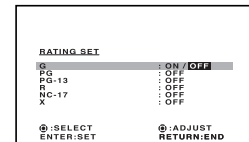

- G** : All ages
- PG** : Parental guidance
- PG-13** : Parental guidance less than 13 years old
- R** : Under 17 years old
Parental guidance suggested
- NC-17** : 17 years old and above
- X** : Adult only

5 Press **▲** or **▼** to select "V-CHIP".



6 Press **◀** or **▶** to select "ON".
Now your settings were set into the memory.

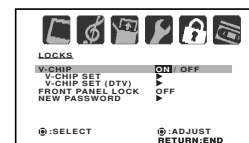

7 Press **RETURN** to clear the menu screen.



To use after the TV is protected

When you try to view a program with a ratings block, a message will appear listing the program's ratings. The program can still be viewed if you press **MUTE** and then enter your password to temporarily bypass the block.

Note:

The V-Chip function is activated only on programs that have the rating signal.

TV operation

Using the front panel lock feature

You can lock the front panel buttons to prevent your settings from being changed accidentally (by children, for example). When the front panel lock is in ON, all control buttons on the unit's front panel (except POWER) do not operate.

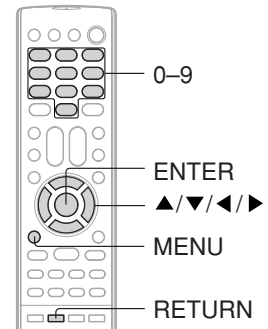

Using the front panel lock feature

- 1** Press MENU in the TV mode, then press ◀ or ▶ to select LOCKS menu. Press ▲ or ▼ to display the password entering mode.



- 2** Use the Number buttons (0-9) to enter your password, then press ENTER. The LOCKS menu appears.

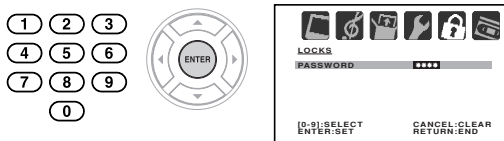

- 3** Press ▲ or ▼ to select "FRONT PANEL LOCK" and press ◀ or ▶ to select "ON".



If a button on the front panel is pressed, the message "NOT AVAILABLE" appears.

- 4** Press RETURN to clear the menu screen.



■ To unlock the front panel:

Press and hold the VOLUME ▼ button on the front panel for about 10 seconds until the message "FRONT PANEL LOCK:OFF" appears on-screen.

You also can unlock the front panel using the menus:
Select "OFF" in the step 3.



To set the on timer

This feature allows you to have the unit automatically turn on at a predetermined time. If you program the ON TIMER once, the unit will turn on the programmed day (once/daily) at the same time to the same channel.

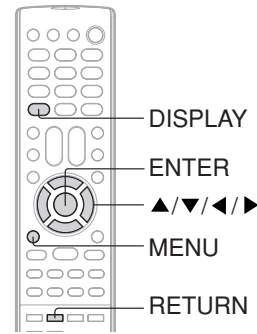

To set the on timer

EXAMPLE: Turning on the TV to channel 12 at 7:00 AM, DAILY.

- 1** Press **MENU** in the TV mode, then press **◀** or **▶** to select **OPTION** menu. Press **▲** or **▼** to select **"ON/OFF TIMER"**. Press **◀** or **▶** to select **"SET"**, then press **ENTER**.



The ON/OFF TIMER menu will appear.

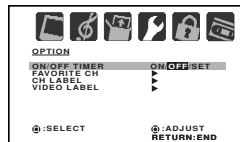

- 2** Press **▲** or **▼** to select **"ON TIMER"**, then press **▶** to select the hour position.

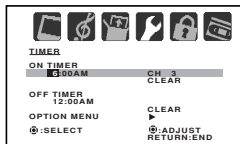

If you return to **OPTION** menu, select **"OPTION MENU"** then press **▶**.

- 3** Press **▲** or **▼** to set the desired hour, then press **▶**.

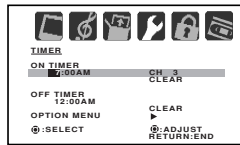

- 4** Set the desired minutes and channel, as in step 3.

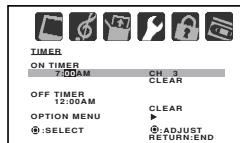

- 5** Press **◀** or **▶** to select **"DAILY"**, then press **ENTER**.

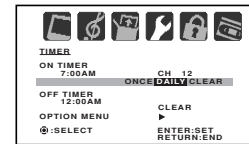

- 6** Press **RETURN** to clear the menu screen.



TV operation

Notes:

- The unit will automatically turn off approximately 1 hour later after the ON TIMER turns on if no OFF TIMER has been set. To continue watching the TV, press any button to cancel the one hour automatic shut off.
- To cancel the ON TIMER, select **"CLEAR"** in step 5 above, then press **RETURN** to clear the menu screen.
- After setting the ON TIMER, if you wish to set the OFF TIMER, press **▲** or **▼** to select **"OFF"** TIMER and press **▶**. Then follow the steps 2~6 on page 36.
- If you want to correct the digits while setting, press **▲** or **▼** until the item you want to correct, then press **◀** or **▶** to correct the desired setting.
- To display the ON/OFF timer settings, press **DISPLAY** (see "TV operation status" on page 24).

To set the off timer

This feature allows you to have the unit turn off automatically at a predetermined time. If you program the OFF TIMER once, the unit will automatically turn off at the same time everyday.

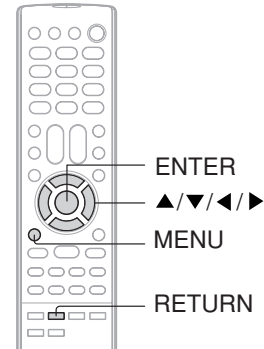

To set the off timer

EXAMPLE: Turning off the TV at 11:30 PM.

- 1** Press **MENU** in the TV mode, then press **◀** or **▶** to select **OPTION** menu. Press **▲** or **▼** to select **"ON/OFF TIMER"**. Press **◀** or **▶** to select **"SET"**, then press **ENTER**.



The ON/OFF TIMER menu will appear.

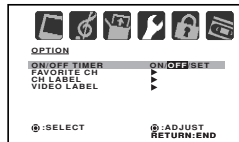

- 2** Press **▲** or **▼** to select **"OFF TIMER"**, then press **▶** to select the hour position.

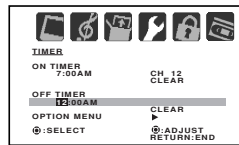

If you return to **OPTION** menu, select **"OPTION MENU"** then press **▶**.

- 3** Press **▲** or **▼** to set the desired hour, then press **▶**.

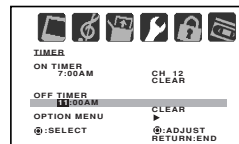

- 4** Set the desired minutes, as in step 3.



- 5** Press **◀** or **▶** to select **"ONCE"** or **"DAILY"**



- 6** Press **MENU** repeatedly until the menu screen is cleared.



Note:

To cancel the OFF TIMER function:

To cancel OFF TIMER, select **"CLEAR"** in step 5 above, then press **RETURN** to clear the menu screen.



Picture control adjustment/ Adjusting the picture preference

Picture controls are factory preset but you can adjust them individually as follows:

And also you can select four picture modes—Standard, Sports, Movie, and Memory—as described in the following table:

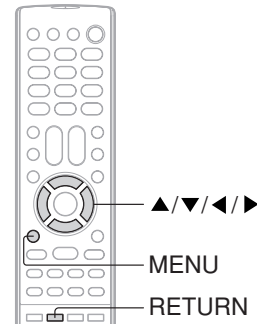

Picture control adjustment

1 Press MENU in the TV mode, then press ◀ or ▶ to select PICTURE menu.

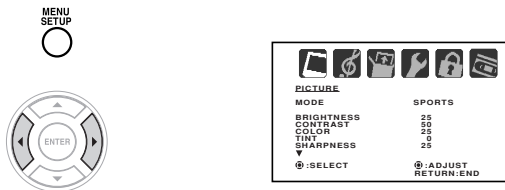

2 Press ▲ or ▼ to select the item you want to adjust, then press ◀ or ▶ to adjust the setting.

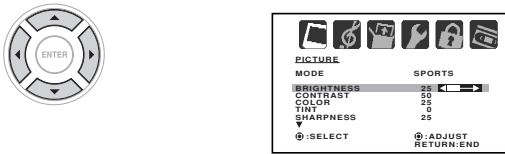

Selection	◀ Pressing	▶
BRIGHTNESS	darker	lighter
CONTRAST	lower	higher
COLOR	paler	deeper
TINT	reddish	greenish
SHARPNESS	softer	sharper

Note:
The CONTRAST default setting is set to maximum (+50) at the factory.

3 After your desired setting, press RETURN to clear the menu screen.



Adjusting the picture preference

1 Press MENU in the TV mode, then press ◀ or ▶ to select PICTURE menu.



2 Press ▲ or ▼ to select "MODE", then press ◀ or ▶ to select the desired picture mode.



Mode	Picture quality
SPORTS	Bright and dynamic picture (factory-set)
STANDARD	Standard picture quality (factory-set)
MOVIE	Movie-like picture setting (factory-set)
MEMORY	Your personal preferences (set by you; see "Picture control adjustment" on left)

3 After your desired setting, press RETURN to clear the menu screen.



TV operation

Using the CableClear® feature/ Selecting the color temperature

CableClear® reduces visible interference in your TV picture. This is useful when receiving a broadcast with a weak signal (especially a Cable channel) or playing a video cassette or disc damaged by repeated use. Change the picture quality by selecting from three preset color temperatures—cool, medium, and warm.

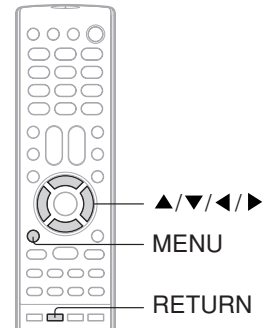

Using the CableClear® feature

1 Press MENU in the TV mode, then press ◀ or ▶ to select PICTURE menu.

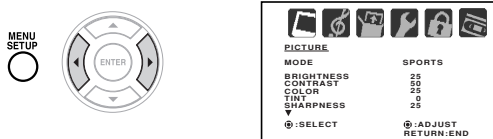

2 Press ▲ or ▼ to select “CableClear”.



3 Press ◀ or ▶ to select “ON” or “OFF”.

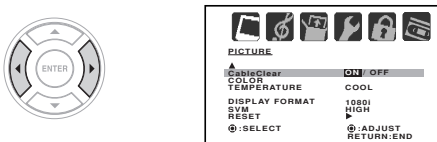

4 Press RETURN to clear the menu screen.



Selecting the color temperature

1 Press MENU in the TV mode, then press ◀ or ▶ to select PICTURE menu.

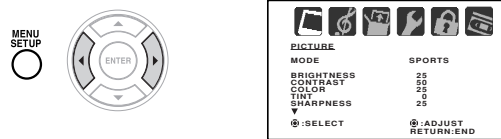

2 Press ▲ or ▼ to select “COLOR TEMPERATURE”.

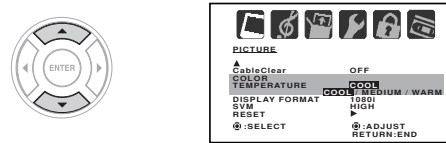

3 Press ◀ or ▶ to select the mode you prefer.



Mode	Picture quality
COOL	Blueish
MEDIUM	Neutral
WARM	Reddish

4 Press RETURN to clear the menu screen.





Selecting the display format/ Selecting the Scan Velocity Modulation (SVM)

Display format feature converts a 480p input signal to 540p or 1080i.
The SVM feature enhances picture contrast and sharpness. This feature has three modes: HIGH, LOW and OFF.

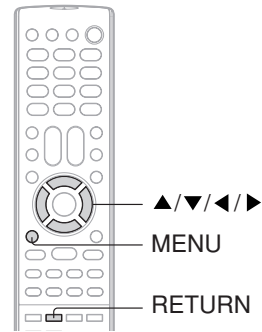

Selecting the display format

- Press MENU in the TV mode, then press ◀ or ▶ to select PICTURE menu.

PICTURE	
MODE	SPORTS
BRIGHTNESS	25
CONTRAST	50
COLOR	25
TINT	0
SHARPNESS	25
Ⓢ:SELECT	Ⓢ:ADJUST RETURN:END
- Press ▲ or ▼ to select "DISPLAY FORMAT".

PICTURE	
▲ CableClear	OFF
▲ COLOR	COOL
▲ TEMPERATURE	COOL
DISPLAY FORMAT	540p 1080i
SVM	HIGH
RESET	▶
Ⓢ:SELECT	Ⓢ:ADJUST RETURN:END
- Press ◀ or ▶ to select "540p" or "1080i".

PICTURE	
▲ CableClear	OFF
▲ COLOR	COOL
▲ TEMPERATURE	COOL
DISPLAY FORMAT	540p 1080i
SVM	HIGH
RESET	▶
Ⓢ:SELECT	Ⓢ:ADJUST RETURN:END
- Press RETURN to clear the menu screen.

Selecting the Scan Velocity Modulation (SVM)

- Press MENU in the TV mode, then press ◀ or ▶ to select PICTURE menu.

PICTURE	
MODE	SPORTS
BRIGHTNESS	25
CONTRAST	50
COLOR	25
TINT	0
SHARPNESS	25
Ⓢ:SELECT	Ⓢ:ADJUST RETURN:END
- Press ▲ or ▼ to select "SVM".

PICTURE	
▲ CableClear	OFF
▲ COLOR	COOL
▲ TEMPERATURE	COOL
DISPLAY FORMAT	1080i
SVM	HIGH LOW OFF
RESET	▶
Ⓢ:SELECT	Ⓢ:ADJUST RETURN:END
- Press ◀ or ▶ to select the mode you prefer.

PICTURE	
▲ CableClear	OFF
▲ COLOR	COOL
▲ TEMPERATURE	COOL
DISPLAY FORMAT	1080i
SVM	HIGH LOW OFF
RESET	▶
Ⓢ:SELECT	Ⓢ:ADJUST RETURN:END
- Press RETURN to clear the menu screen.

TV operation

Notes:

- The DISPLAY FORMAT feature is available only for 480p input. 1080i is always output when a signal other than 480p is input.
- If you notice flickering in a 480p image, try setting the DISPLAY FORMAT to 540p.

Note:

SVM is not required when viewing some high-quality video material. If you are watching high-quality video material, you may want to set SVM to OFF.

Resetting your picture adjustments/ Selecting the picture size

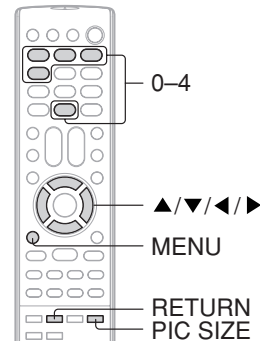

Resetting your picture adjustments

1 Press **MENU** in the TV mode, then press **◀** or **▶** to select **PICTURE** menu.

PICTURE	
MODE	SPORTS
BRIGHTNESS	25
CONTRAST	50
COLOR	25
TINT	0
SHARPNESS	25
⓪:SELECT	⓪:ADJUST RETURN:END

2 Press **▲** or **▼** to select **"RESET"**, and then press **▶**.

PICTURE	
▲ CableClear	OFF
● COLOR TEMPERATURE	COOL
▶ DISPLAY FORMAT	1080i
▼ SVM	HIGH
⓪:RESET	▶
⓪:SELECT	⓪:ADJUST RETURN:END

The RESET function returns your picture quality adjustments to the following factory settings:

Mode sports Tint center (0)
 Brightness center (25) Sharpness center (25)
 Contrast max (50) Color temperature cool
 Color center (25) SVM high

3 Press **RETURN** to clear the menu screen.

Selecting the picture size

1 Press **MENU** in the TV mode, then press **◀** or **▶** to select **TV SETUP** menu. Press **▲** or **▼** to select **"PICTURE SIZE"**, then press **▶**.

TV SETUP	
⓪: ADVANCED	▶
⓪: PICTURE SIZE	▶
⓪: PICTURE SCROLL	▶
⓪: CINEMA MODE	FILM
⓪: SIGNAL METER	▶
⓪:SELECT	⓪:ADJUST RETURN:END

2 The **PICTURE SIZE** menu will appear. Press the corresponding number button (0-4) or **▲/▼** to select the desired picture size, as described on page 41.

PICTURE SIZE	
⓪: NATURAL	▶
1: THEATER WIDE1	▶
2: THEATER WIDE2	▶
3: THEATER WIDE3	▶
4: FULL	▶
⓪:0-4:SELECT	

Notes:

- You also can display the PICTURE SIZE menu screen by pressing **PIC SIZE** on the remote control.
- The PICTURE SIZE feature is not available for some program formats (such as 1080i or 720p.) Such formats will display in Natural picture size.
- If you select TheaterWide 2 or 3, the top and bottom edges of the picture may be hidden. To see the hidden edges, either scroll the picture 42 or try viewing the program in Full picture size.



You can view 480i and 480p format programs in a variety of picture sizes—Natural, TheaterWide 1, TheaterWide 2, TheaterWide 3, and Full. The way the image displays in any of the picture sizes will vary depending on the format of the program you are viewing. Select the picture size that displays the current program the way that looks best to you.

NOTICE OF POSSIBLE ADVERSE EFFECTS ON TV PICTURE DISPLAY

Avoid displaying stationary images on your TV screen for extended periods of time. Fixed (non-moving) patterns or images (including but not limited to PIP/POP windows, closed captions, video game patterns, TV station logos, stock tickers, websites, and special formats that do not use the entire screen) can become permanently ingrained in the cathode ray tube(s) of the TV and cause subtle but permanent ghost images. **This type of damage is NOT COVERED BY YOUR WARRANTY.** See item 34 on page 4.

Natural picture size

- The image is displayed close to its originally formatted proportion. Some program formats will display with side bars and/or bars at the top and bottom.

Natural picture size example: The way the image displays will vary depending on the format of the program you are currently watching.

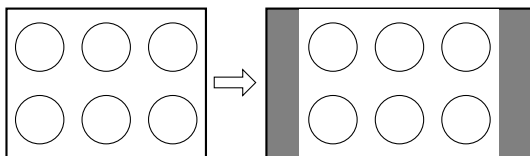

Conventional (4:3) picture on a conventional TV screen

Conventional (4:3) picture in Natural size on your wide-screen TV screen

TheaterWide 1 picture size (for 4:3 format programs)

- The picture is stretched wider to fill the width of the screen, but only slightly stretched taller.
- The top and bottom edges of the picture may be hidden; however, this mode cannot be scrolled.

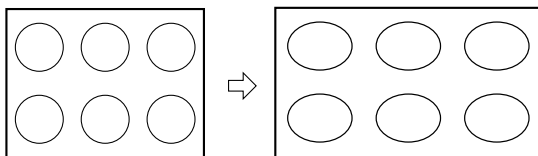

TheaterWide 1 picture size example

Using these functions to change the picture size (i.e., changing the height/width ratio) for any purpose other than your private viewing may be prohibited under the Copyright Laws of the United States and other countries, and may subject you to civil and/or criminal liability.

TheaterWide 2 picture size (for letter box programs)

- The picture is stretched the same amount both wider and taller (retains its original proportion).
- The top and bottom edges of the picture may be hidden. To view the hidden areas, see "Picture scroll" [42](#).

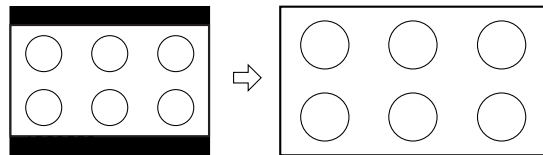

TheaterWide 2 picture size example

TheaterWide 3 picture size (for letter box programs with subtitles)

- The picture is stretched wider to fill the width of the screen, but only slightly stretched taller.
- The top and bottom edges of the picture may be hidden. To view the hidden areas (such as subtitles or captions), see "Picture scroll" [42](#).

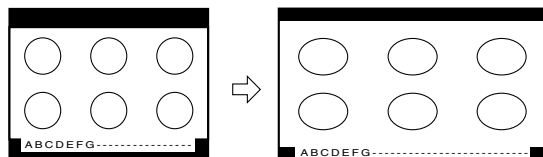

TheaterWide 3 picture size example

Full picture size (for 16:9 source programs)

- If receiving a 16:9 format program, the picture is displayed in its original proportion.
- If receiving a 4:3 format program, the picture is stretched wider to fill the width of the screen, but not stretched taller.
- None of the picture is hidden.

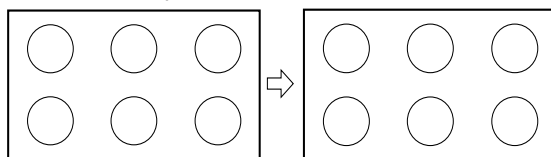

Full picture size example

TV operation

Picture scroll/Selecting the cinema mode

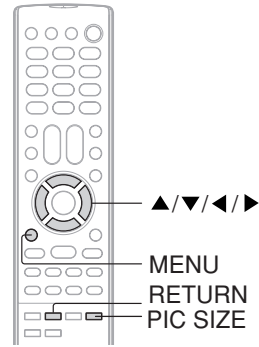

Picture scroll

1 Press PIC SIZE to select the TheaterWide 2 or 3 mode.



2 Press MENU in the TV mode, then press ◀ or ▶ to select TV SETUP menu, then press ▲ or ▼ to select "PICTURE SCROLL".



3 Press ◀ or ▶ to display the Scroll Adjustment mode.

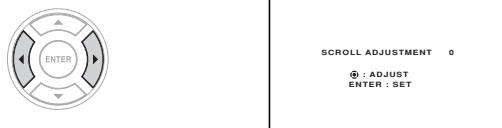

4 Press ▲ or ▼ to display the vertical position of picture.

- Normal (center) position.

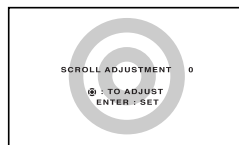

- To raise the picture, press ▲.

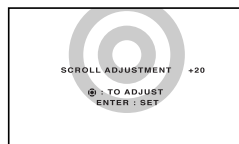

- To lower the picture, press ▼.

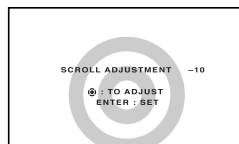

Note:

You can scroll the picture in TheaterWide 2 and TheaterWide 3 only. The scroll amounts are as follows:

- 480i/480p signal source: Wide 1 : Not adjustable
Wide 2 : -10 to +20
Wide 3 : -10 to +10

Selecting the cinema mode

When you view a DVD movie, smoother and more natural motion can be obtained by setting the CINEMA MODE to FILM. This function can be set on the ColorStream HD and HDMI input only.

1 Press MENU in the TV mode, then press ◀ or ▶ to select TV SETUP menu.



2 Press ▲ or ▼ to select "CINEMA MODE".



3 Press ◀ or ▶ to select "FILM" or "VIDEO".



4 Press RETURN to clear the menu screen.





Stereo and Second Audio Program (SAP)/ Sound control adjustment

The unit is equipped with a feature known as multi-channel TV sound or MTS. MTS broadcasts greatly enhance TV viewing by bringing you programs with high fidelity stereo sound. MTS also provides an extra channel called the Second Audio Program or SAP which broadcasters can use to transmit a second language for bilingual transmission or for other purposes.

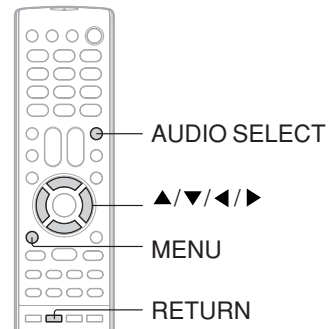

Listening to stereo sound

When the TV is turned on or a channel selection is made, the "STEREO" will appear on the screen. This means that Stereo broadcasting is available. You can enjoy stereo sound from the left and right speakers.

- When mono broadcasting is received, no indication is displayed.
- If the broadcast signal is not strong enough or clear stereo sound is not available, press **AUDIO SELECT** to change to mono sound. The noise should be eliminated. Press it again to return to the stereo sound.

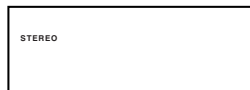

Listening to SAP (Second Audio Program)

When the TV is turned on or a channel selection is made, the "SAP" will appear on the screen. This means that the Second Audio Program broadcasting is available.

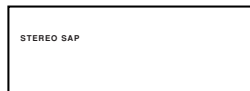

To select desired sound

Press **AUDIO SELECT** to select the desired sound.



Broadcast	SAP setting	Audio display
MONO	OFF	MONO
	ON	MONO
STEREO	OFF	STEREO ↔ MONO
	ON	STEREO ↔ MONO
MONO+SAP	OFF	MONO
	ON	SAP
STEREO+SAP	OFF	STEREO ↔ MONO
	ON	SAP

Sound control adjustment

- 1 Press **MENU** in the TV mode, then press **◀** or **▶** to select **AUDIO** menu.



- 2 Press **▲** or **▼** to select the item you want to adjust, then press **◀** or **▶** to adjust the setting.

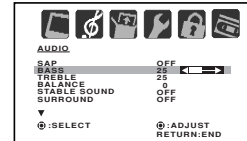

- SAP:** Press **◀** or **▶** to select "ON" or "OFF".
ON: SAP is available.
OFF: SAP is not available.
- BASS:** Press **◀** or **▶** to adjust the bass sound.
TREBLE: Press **◀** or **▶** to adjust the treble sound.
BALANCE: Press **◀** or **▶** to obtain an equal sound level from both speakers.
- STABLE SOUND:** Press **◀** or **▶** to select "ON" or "OFF".
ON: The StableSound® feature limits the highest volume level to prevent extreme changes in volume when the signal source is changed.
OFF: Normal sound.
- SURROUND:** Press **◀** or **▶** to select "ON" or "OFF".
ON: The dynamic presence and sound created offers a thoroughly enjoyable listening experience.
OFF: Normal sound.

- 3 Press **RETURN** to clear the menu screen.



TV operation

Selecting the HDMI audio input source/ Selecting the audio languages

See page 16 for details on connecting an HDMI or a DVI device to the TV's HDMI input. If you connect a DVI device, you must also connect the analog audio cables to the HDMI audio IN jacks to hear audio (see page 16.) Set the HDMI audio input setting to "DVI" with this connection. If you connect an HDMI device and play media with digital audio output, set the HDMI audio input setting to "HDMI" with this connection. If you connect an HDMI device but play media with analog audio output (for example, certain CDVs do not output digital audio), you must connect the analog audio cables to the HDMI audio IN jacks to hear audio (see page 16.) Set the HDMI audio input setting to "DVI" with this connection.

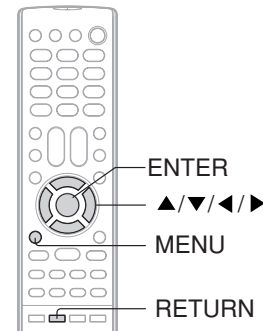

Selecting the HDMI audio input source

- 1 Press MENU in the TV mode, then press ◀ or ▶ to select AUDIO menu.



- 2 Press ▲ or ▼ to select "HDMI".



- 3 Press ◀ or ▶ to select "HDMI" or "DVI".



- 4 Press RETURN to clear the menu screen.



Selecting the audio languages

When two or more audio languages are included in a digital signal, you can select one of the audio language.

- 1 Press MENU in the TV mode, then press ◀ or ▶ to select AUDIO menu.



- 2 Press ▲ or ▼ to select "AUDIO LANGUAGE", then press ▶.



- 3 Press ▲ or ▼ to select your desired language, then press ENTER.

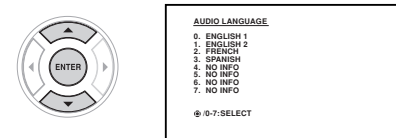

- 4 Press RETURN to clear the menu screen.





Selecting the digital output / Resetting your audio adjustments / Checking the digital signal strength

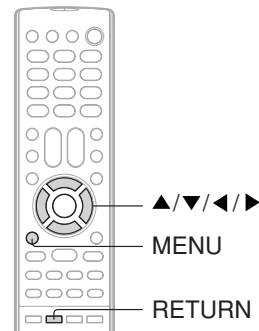

Selecting the digital output

Use this feature to select the digital audio output format when you connect a Dolby Digital decoder or other digital audio system to the coaxial digital audio output on the TV.

- 1** Press MENU in the TV mode, then press ◀ or ▶ to select AUDIO menu.



- 2** Press ▲ or ▼ to select "DIGITAL OUTPUT".

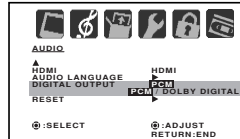

- 3** Press ◀ or ▶ to select "PCM" or "DOLBY DIGITAL".

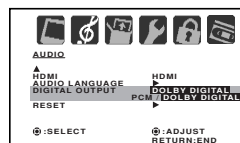

- 4** Press RETURN to clear the menu screen.



Resetting your audio adjustments

- 1** Press MENU in the TV mode, and then press ◀ or ▶ to select AUDIO menu.



- 2** Press ▲ or ▼ to select "RESET", and then press ▶.

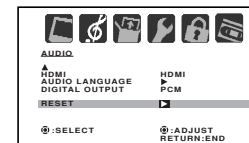

The RESET function returns the audio adjustments to the following factory settings:

- Bass center (25)
- Treble center (25)
- Balance center (0)

- 3** Press RETURN to clear the menu screen.



Checking the digital signal strength

You can check the strength of the digital signal by viewing the digital signal meter.

- Press MENU in the TV mode, then press ◀ or ▶ to select TV SETUP menu. Press ▲ or ▼ to select "SIGNAL METER", then press ▶.

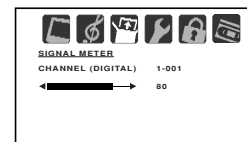

Notes:

- Signal meter feature is not available for analog channels.
- After approximately 4 minutes, SIGNAL METER screen will return to normal TV-operation automatically.
- When you select a vacant channel, the signal meter may react.

TV operation

Loading and unloading a cassette tape

Use only video cassette tapes marked **VHS**.

Loading

Push the center of the tape until it is automatically inserted.



Insert the cassette tape with its labeled side facing up and the erase prevention tab positioned at your left. An inverted cassette tape cannot be inserted.

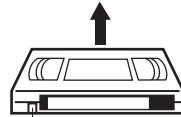

Erase prevention tab

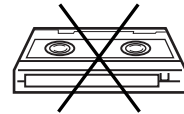

Automatic power ON

When you insert a cassette tape, the unit power will turn ON automatically.

Automatic playback

When loading a cassette tape without an erase prevention tab, playback will start automatically.

Unloading

- 1 Press **STOP/EJECT** on the front panel or **EJECT** on the remote control.



or



- 2 Remove the cassette tape.

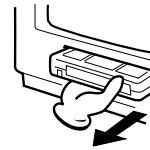

Automatic tape eject

This unit will automatically rewind the tape when the tape has ended. And when the tape is rewinded to its beginning, the cassette tape will be ejected automatically.

Notes:

- Always eject the tape when not in use.
- The cassette tape can be ejected even if the POWER is "OFF".

To prevent accidental erasure

To prevent accidental erasure

Remove the erase prevention tab with a screwdriver.

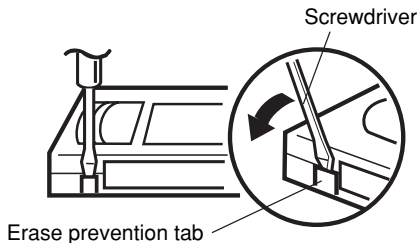

To record again

Cover the hole with a piece of adhesive tape.

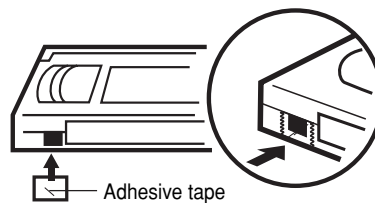

Tape speed and maximum recording time

Tape Speed	Video cassette tape				
	T-160	T-120	T-90	T-60	T-30
SP (Standard Play)	2-2/3 hours	2 hours	1-1/2 hours	1 hour	30 minutes
SLP (Super Long Play)	8 hours	6 hours	4-1/2 hours	3 hours	1-1/2 hours



Cassette tape playback

To play a prerecorded tape.

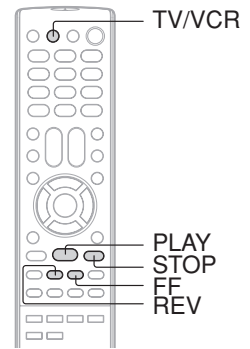
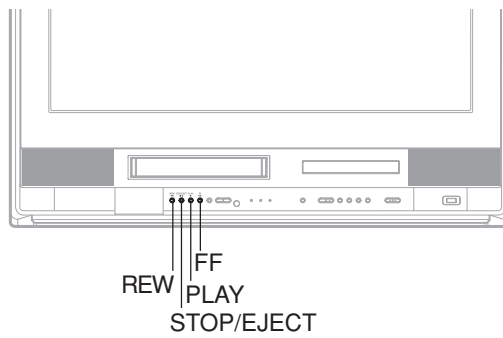

Playback

1 Load a prerecorded tape:
 (When loading a cassette tape without the erase prevention tab, playback will start automatically).



2 To start playback:
 Press **PLAY** on the front panel or on the remote control. Playback will start. "▶" will appear on the screen for about 4 seconds.

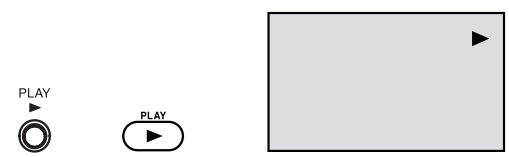

To stop playback:
 Press **STOP/EJECT** once on the front panel or press **STOP** on the remote control. The tape will stop but remain fully loaded and ready to play. "■" will appear on the screen for about 4 seconds.

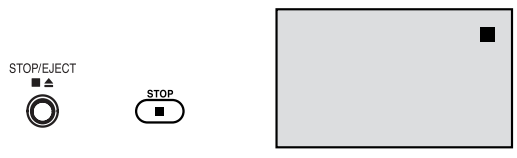

Rewind or forward the tape

Stop the playback or recording with **STOP**.

To rewind the tape:
 Press **REW** on the front panel or press **REV** on the remote control.

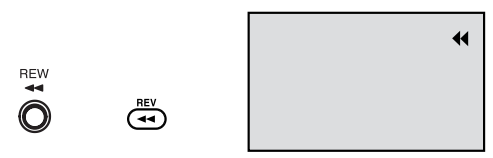

To forward the tape:
 Press **FF** on the front panel or press **FF** on the remote control.

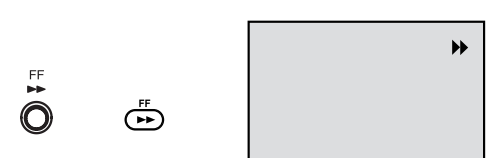

To stop the tape-winding, press **STOP**. To switch to playback directly (without **STOP**), press **PLAY**.

■ **Forward/Reverse picture search mode**
 When the tape is being winded, you can switch to picture search mode (see page 48). To do this, press **REV** or **FF** again and hold it down. The unit will resume the tape winding as soon as the button is released.



Notes:

- If you play a prerecorded tape after the DVD playback, you must set the unit to TV/VCR mode using the TV/VCR button.
- This unit selects the playback tape speed SP or SLP automatically.
- When you select the TV/VCR mode during DVD playback, DVD playback will change to the still mode, and after 5 minutes it will change to the resuming playback mode automatically.

Special playback

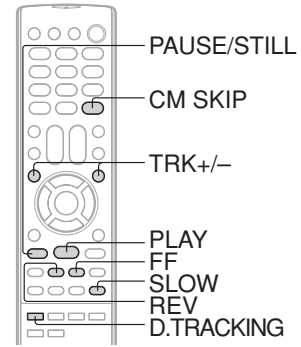

Picture search

Reverse picture search function

Press **REV** once or twice during the playback.

Forward picture search function

Press **FF** once or twice during the playback.

To return to playback, press **PLAY**.

SPEED SEARCH TIMES

TAPE SPEED	PICTURE SEARCH SPEED	
	PRESS ONCE	PRESS TWICE
SP (Standard Play)	3 X	5 X
SLP (Super Long Play)	9 X	15 X

Still picture

Press **PAUSE/STILL** during playback.

To resume normal playback, press **PLAY** or **PAUSE/STILL**.

If the still picture jitters excessively, press **TRK + / -** to stabilize the still picture.

Slow motion

During playback press **SLOW**.

To return to playback, press **PLAY**.

■ Slow tracking and vertical lock adjustment

If noise bars appear in the picture during slow motion, press the **TRK + / -** to reduce the noise bars.

Frame by frame picture

Press **PAUSE/STILL** during playback.

Press **SLOW** one by one. The picture advances frame by frame.

To return to playback, press **PLAY** or **PAUSE/STILL**.

CM skip

Press **CM SKIP** during playback. The unit will search forward through approximately 30 seconds of the tape (e.g. unwanted commercial time) for each press of **CM SKIP** (maximum six presses) and then resume normal playback.

For example : 1 press: 30 seconds of tape
 2 press: 60 seconds of tape
 3 press: 90 seconds of tape

Digital tracking controls

When a tape is played, the Digital Auto Tracking system automatically adjusts the tracking to obtain the best possible picture. If noise bars appear during playback, adjust the tracking manually as follows:

- Press **TRK + / -** to obtain the best possible picture. "MANUAL TRACK" will appear for 4 seconds on the screen. To resume automatic tracking, press **D.TRACKING**. "DIGITAL TRACK" will appear for 4 seconds on the screen.



Notes:

- "SP" is more appropriate as less noise appeared during search and still playback for tape recorded in SP.
- The audio output is muted during PICTURE SEARCH, STILL, FRAME ADVANCE and SLOW MOTION.
- During picture search mode there will be noise bars which are caused by the system.
- The Special Playback will automatically change to playback after approx. 5 minutes to protect the video tape against excessive wear.



Convenient function

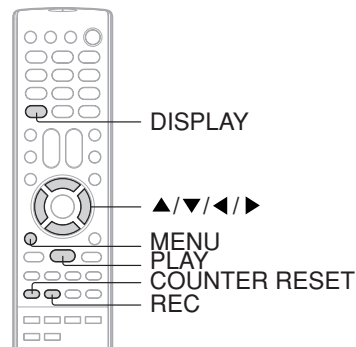

Repeat playback

The entire video tape will be played until its end. The tape will automatically rewind to the beginning and the playback will be repeated.

1 Press MENU, then press ◀ or ▶ to select VCR SETUP menu.



2 Press ▲ or ▼ to select "AUTO REPEAT".

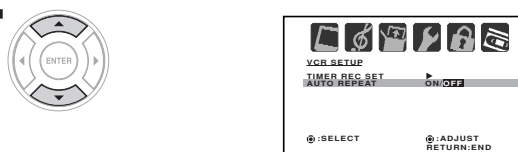

3 Press ◀ or ▶ to select "ON" or "OFF".

If "ON" is selected, the playback will be repeated endlessly.



4 Press MENU repeatedly until the menu screen is cleared.

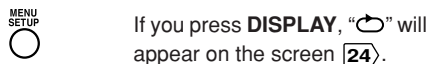

5 To start the playback, press PLAY.

The playback will be repeated endlessly.



Using the real time tape counter

The on-screen real time tape counter shows the tape running time in hours, minutes and seconds. You can easily determine how long the tape has been running or how much time is left on the tape.

1 Press DISPLAY.

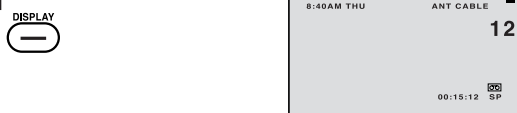

2 Press COUNTER RESET to set the counter to "00:00:00".



3 Begin Playback or Recording to start the tape, the counter will display the elapsed time.



4 When you wish to make the counter disappear, press DISPLAY once again.



Playback (VCR)

■ To cancel repeat mode:

In step 3 above, press ◀ or ▶ to select "OFF" position. Press MENU repeatedly until the menu screen is cleared. The repeat function is canceled automatically when the unit is switched off.

Convenient function (Continued)

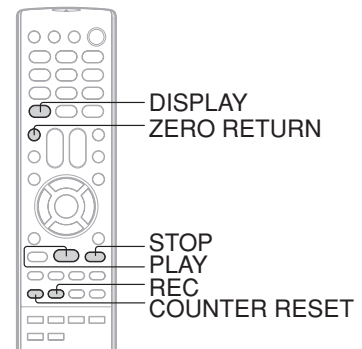

Zero return function

The zero return function provides a convenient method of rapidly returning to the starting point of recording or playback. The starting point can be indexed for any location on the tape by pressing COUNTER RESET and ZERO RETURN.

1 Press DISPLAY.

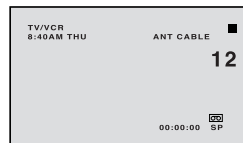

2 Before playback or recording, press COUNTER RESET to set the counter to "00:00:00".

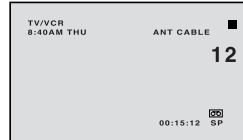

3 Begin playback or recording.



4 Press STOP.



5 Press ZERO RETURN. The tape will rewind and automatically stop at the "00:00:00" position.



Video head cleaning

Video head clogging

The video heads are the means by which the unit reads the picture from the tape during playback. In the unlikely event that the heads become dirty enough to be clogged, no picture will be played back. This can easily be determined if, during playback of a known good tape, there is good sound, but no picture (picture is extremely snowy). If this is the case, the unit need to check and clean by the qualified service personnel.



Good Picture



Snowy Picture

Video head cleaning

Video head cleaning is needed when the playback picture becomes unclear. This signifies that the heads are getting dirty and can occur when playing poor quality or damaged tapes. If the heads require cleaning, use a equivalent high quality chemical non-abrasive (wet) head cleaning tape or have them cleaned professionally. If playing a head cleaning tape in the unit once does not improve the picture, play it several times before requesting service.

Notes:

- DO NOT ATTEMPT TO CLEAN THE VIDEO HEADS OR SERVICE THE UNIT BY REMOVING THE REAR COVER.
- Video heads may eventually wear out and should be replaced when they fail to produce clear pictures.
- To help prevent video head clogging, use only good quality VHS tapes. Discard worn out tapes.



Recording a TV program

Recording and viewing the same TV program.

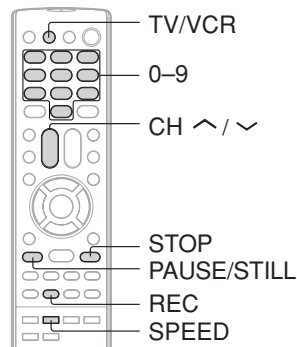

Recording a TV program

- 1 Load a cassette tape with the erase prevention tab intact.**
The unit will automatically turn on.
- 2 Press SPEED to select the desired tape speed SP or SLP.**
The tape counter and SP or SLP will appear on the screen for about 4 seconds.
- 3 Select "TV" or "CABLE" to the appropriate position [27].**
TV - VHF/UHF channels
CABLE - Cable TV channels
- 4 Press Direct channel selection (0-9) or CH ^/v to select the channel to be recorded.**
- 5 Press REC.**
"●" will appear on the screen for about 4 seconds and the REC/OTR indicator on the front panel will light.

Notes:

- If power is switched off during recording, the TV and the DVD sections go off and the VCR continues to record. Press the STOP button to halt the recording and turn off the VCR.
- The unit channel cannot be changed during recording.
- If you record the TV program after the DVD playback, you must set the unit to TV/VCR mode using TV/VCR.

To stop recording

Press STOP to stop recording.
"■" will appear on screen for about 4 seconds.

To stop recording temporarily

Press PAUSE/STILL to avoid recording unwanted material.
"||" will appear on the screen and the REC/OTR indicator will blink on and off. Press PAUSE/STILL or REC to continue the recording.

Note:
The pause function will be released after 5 minutes to prevent damage to the tape or the unit. The unit will change to the STOP mode.

Auto Rewind feature

This VCR will automatically rewind the tape when the tape has ended (except during OTR and timer recording). It will also eject the tape.

Note:

If the erase prevention tab is removed, the tape will eject when REC is pressed for recording.

The unauthorized recording, use, distribution, or revision of television programs, videotapes, DVDs and other materials, is prohibited under the Copyright Laws of the United States and other countries, and may subject you to civil and/or criminal liability.

Recording (VCR)

One-touch Timer Recording (OTR)

The One-touch timer recording feature provides a simple and convenient way to make a timed recording.

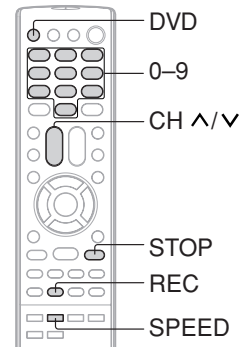

One-touch timer recording (OTR)

Example: One-touch timer recording for 30 minutes.

1 Load a cassette tape with the erase prevention tab intact.



The unit will automatically turn on.

2 Press SPEED to select the desired tape speed SP or SLP.

The tape counter and SP or SLP will appear on the screen for about 4 seconds.

SPEED
RETURN

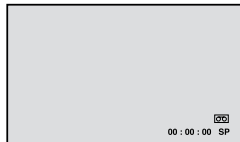

3 Set "TV" or "CABLE" option to the appropriate position 27.

4 Press Direct channel selection (0-9) or CH ^/v to select the channel to be recorded.

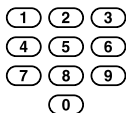

5 Press REC to begin recording. Press the button again to stop recording after 30 minutes. Each additional press of REC will increase recording time as shown below, up to a maximum of 6 hours. "OTR" will appear on the screen.

Press	Recording time	Press	Recording time
once	NORMAL REC	6 times	3:00
twice	0:30	7 times	4:00
3 times	1:00	8 times	5:00
4 times	1:30	9 times	6:00
5 times	2:00	10 times	NORMAL REC



To cancel OTR

Press **STOP**.



"■" will appear on screen for about 4 seconds.

Notes:

- If you wish to watch the DVD playback during the recording or the OTR, press **DVD** to change to DVD mode and perform the DVD playback 47.
- The channel cannot be changed during recording.

The unauthorized recording, use, distribution, or revision of television programs, videotapes, DVDs and other materials, is prohibited under the Copyright Laws of the United States and other countries, and may subject you to civil and/or criminal liability.



Timer recording

Timer recording can be programmed on-screen with the remote control. The built-in timer allows automatic unattended recording of up to 8 programs within 1 month.

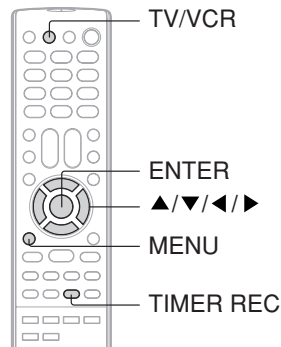

Timer recording

Preparation:

- Press TV/VCR to select the TV/VCR mode.
- Load a cassette tape with the erase prevention tab intact.
- Check the time and date are correct [21].

Example:

Program a timer recording for 23rd day, channel 125 (Cable TV), 7:00 - 9:30 PM (Tape speed : SLP).

1 Press MENU, then press ◀ or ▶ to select VCR SETUP menu.



2 Press ▲ or ▼ to select "TIMER REC SET", then press ▶.



3 Press ▲ or ▼ to select one of the program line, then press ENTER.

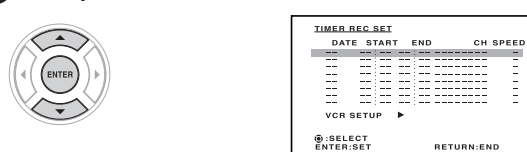

4 Press ◀ or ▶ to select the date, then press ▼.

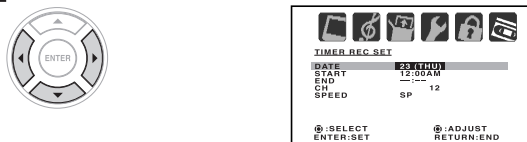

5 Set the start time, end time, channel and tape speed as in step 4. Then press ENTER.



Notes:

- Press ▲ to move cursor backward for correction.
- To record from external source set the channel to "VIDEO1" or "VIDEO2".

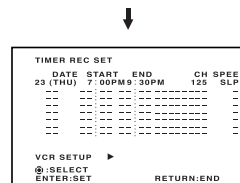

6 To set the timer for another program, repeat steps 3 to 5 to set another program.

7 Press TIMER REC. The TIMER REC indicator will light. The Timer is programmed, when the programmed time is reached, the recording is automatically started.

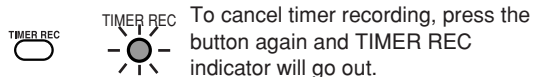

Notes:

- The VCR section cannot be used while the TIMER REC indicator is lit. If you want to use the VCR operation, press **TIMER REC** to deactivate the timer.
- When the clock is not set, you cannot select "TIMER REC". In this case, set the clock [21].
- After a power failure or disconnection of the power plug, all programmed recording setting and time display will be lost upon resumption of power. In this case, reset the clock [21] and reprogram any timer recordings.
- If you want to correct the digits while setting, press ▲ or ▼ until the item you want to correct, then press ◀ or ▶ to correct the desired setting.
- If programming is performed without a tape in the unit, or with a tape without an erase prevention tab, the Timer Recording is not possible. If a tape without an erase prevention tab is in the unit, the tape will be ejected.

The unauthorized recording, use, distribution, or revision of television programs, videotapes, DVDs and other materials, is prohibited under the Copyright Laws of the United States and other countries, and may subject you to civil and/or criminal liability.

Recording (VCR)

Timer recording (Continued)

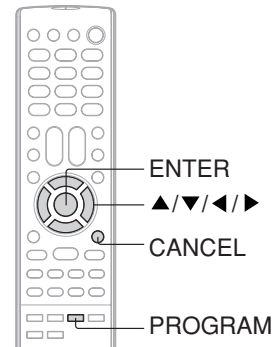

To set daily/weekly timer

Weekly (e.g. WKL-TUE: each Tuesday) or daily (e.g. MON-SAT: Monday to Saturday) Timer recording

Follow the procedure of timer recording on page 53. At picture 4 press ◀ or ▶ repeatedly until the desired setting appears. Then press **ENTER**.

When you press ◀ repeatedly, the indicator at DATE will change as follows, in this case the day is Friday.

The current day (Friday) → SUN-SAT (Sunday to Saturday)

↑
One month later
minus one day

WKL-WED
(Weekly Wednesday)



↓
MON-SAT (Monday to Saturday)
↓
MON-FRI (Monday to Friday)
↓
WKL-THU (Weekly Thursday)

To confirm the settings

Press **PROGRAM** once. The TV screen displays the timer program list. Press **PROGRAM** again. The TV screen displays the ON/OFF timer setting.



Press **PROGRAM** 3 times. The menu screen is cleared.

(once)

TIMER REC SET	DATE	START	END	CH	SPEED
23 (THU)	7:00PM	9:30PM	12S	SLP	
---	---	---	---	---	---
---	---	---	---	---	---
---	---	---	---	---	---
---	---	---	---	---	---
---	---	---	---	---	---
---	---	---	---	---	---
---	---	---	---	---	---
---	---	---	---	---	---
---	---	---	---	---	---

VCR SETUP ▶
⊙:SELECT ENTER:SET RETURN:END

(twice)

TIMER	ON TIMER	CH	CLEAR
12:00AM			
OFF TIMER	12:00AM		CLEAR
OPTION MENU			▶
⊙:SELECT			⊙:ADJUST RETURN:END

To cancel a program

Press **PROGRAM** once. The TV screen displays the timer program list.

Press ▲ or ▼ to select the unnecessary program, and press **CANCEL** to cancel the program.



TIMER REC SET	DATE	START	END	CH	SPEED
23 (THU)	7:00H	9:30H	12S	SLP	
24 (WE)	8:00H	9:00H	12S	SLP	
25 (SA)	10:00H	10:30H	12S	SLP	
26 (SA)	9:00H	9:00H	007	SP-	
27 (SU)	8:30H	9:00H	018	SP-	
28 (MO)	8:00H	6:30H	001	SP-	
29 (TU)	11:00H	11:20H	110	SP-	
31 (WE)	7:30H	9:00H	12S	SLP	

VCR SETUP ▶
⊙:SELECT ENTER:SET RETURN:END

TIMER REC SET	DATE	START	END	CH	SPEED
23 (THU)	7:00H	9:30H	12S	SLP	
24 (WE)	8:00H	9:00H	12S	SLP	
25 (SA)	10:00H	10:30H	12S	SLP	
27 (SU)	8:30H	9:00H	018	SP-	
28 (MO)	8:00H	6:30H	001	SP-	
29 (TU)	11:00H	11:20H	110	SP-	
31 (WE)	7:30H	9:00H	12S	SLP	

VCR SETUP ▶
⊙:SELECT ENTER:SET RETURN:END

If the programs overlap another

Do not overlap timer programs as portions of the conflicting programs will be lost. The first recording time has priority over the next recording time as shown in the diagram below.

If you set up many timer recording programs at the same start time, the priority will be the top program in the timer recording list.

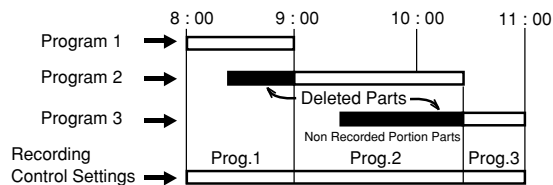

Notes:

- The daily/weekly recording can be made continuously until the recording is canceled or the tape reaches the end.
- During timer recording the automatic rewinding mechanism does not function.
- You can correct or cancel the programmed setting in program confirm mode.

The unauthorized recording, use, distribution, or revision of television programs, videotapes, DVDs and other materials, is prohibited under the Copyright Laws of the United States and other countries, and may subject you to civil and/or criminal liability.

Duplicating a video tape

If you connect the unit to another VCR or Camcorder, you can duplicate a previously recorded tape. Make all connections before turning on the power.

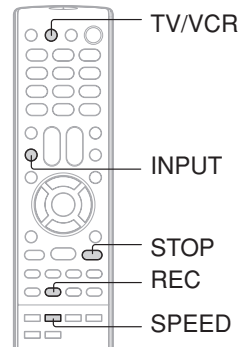

Duplicating a video tape

Preparation:

- Press **TV/VCR** to select the TV/VCR mode.
- Load a cassette tape with the erase prevention tab intact.
- Load a previously recorded tape into the playback VCR or Camcorder.

1 Press **SPEED** to select the desired tape speed **SP** or **SLP**.



It is recommended to set the Speed to the SP mode on the recording VCR for best results.

2 Press **INPUT** repeatedly to select **VIDEO1** or **VIDEO2**.



VIDEO1: on the rear panel
VIDEO2: on the front panel

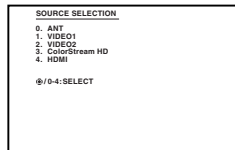

3 Press **REC**.



4 Press **PLAY** on the playback VCR or camcorder.

5 Press **STOP** when you finish after duplicating.



The unauthorized recording, use, distribution, or revision of television programs, videotapes, DVDs and other materials, is prohibited under the Copyright Laws of the United States and other countries, and may subject you to civil and/or criminal liability.

Connection with second video recorder

- Select "VIDEO1" on step 2.

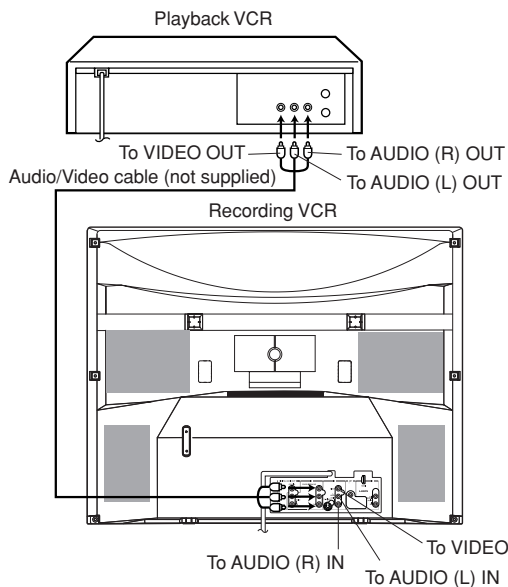

Connection with Camcorder

- Select "VIDEO2" on step 2.

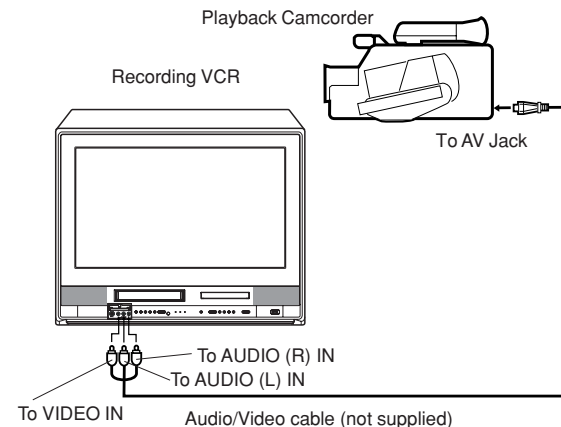

For duplicating a previously recorded tape from a camcorder, follow the camcorder manufacturer's instructions. A typical camcorder dubbing hookup is shown above.

Recording a DVD/CD disc

You can record disc material in DVD, Audio CD, etc. onto a video tape with this unit.

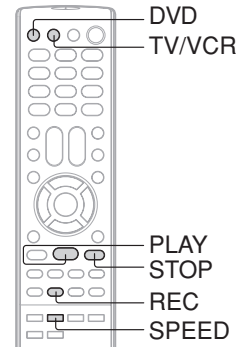

Duplicating a DVD or CD disc

Preparation:

- Press **TV/VCR** to select the TV/VCR mode.
- Load a cassette tape with the erase prevention tab intact.
- Load a DVD/CD disc.

1 Press **SPEED** to select the desired tape speed **SP** or **SLP**.



2 Press **DVD** to select the DVD mode.



3 Press **PLAY** to start playback.



4 Press **REC** to start recording.



The unit will change to the VCR mode automatically and the playback picture or sound will be duplicated on the video cassette tape.

5 Press **STOP** when you finish recording.



If you wish to stop a DVD/CD disc, press **DVD** to change the DVD mode, then press **STOP**.

Notes:

- You may not record the beginning of the disc, so start to playback the disc, then start to record.
- You cannot record the disc with copy guard function. "DISC IS COPY PROTECTED" will show up on the TV screen for approx. 4 seconds.
- Do not insert the media card during the duplicating. In this case, a card material is duplicated onto a video tape.

The unauthorized recording, use, distribution, or revision of television programs, videotapes, DVDs and other materials, is prohibited under the Copyright Laws of the United States and other countries, and may subject you to civil and/or criminal liability.

Playing a disc

This section shows you the basics on how to play a disc.

CAUTION

Keep your fingers well clear of the disc tray as it is closing. Neglecting to do so may cause serious personal injury.

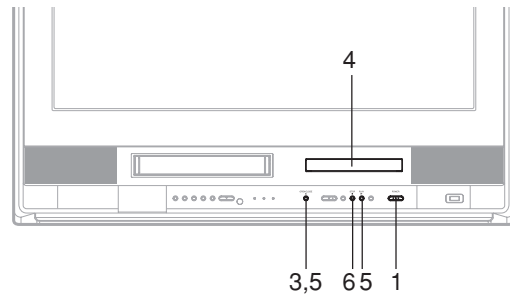

DVD VCD CD Basic playback

Preparations:

- Insert the AC cord plug into a standard 120V 60Hz polarized AC outlet. If the AC cord plug is plugged in for the first time, you need to set "Starting setup" [20].
- When connecting to other equipment, turn power off.

1 Press POWER on the unit or on the remote control to turn on the unit.

The Power indicator will light.

- Every time you press **POWER**, the TV/VCR/DVD starts from TV mode.
- When using an amplifier, switch on the amplifier.



2 Press DVD to select DVD mode.

The DVD startup screen will appear on the screen. "Reading" display will change to "No Disc". (If DVD disc has already loaded, playback will start automatically.)



3 Press OPEN/CLOSE.

The disc tray opens.



4 Place a disc on the disc tray.

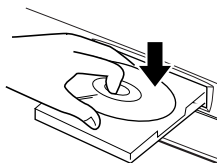

With the playback side down

- There are two different disc sizes. Place the disc in the correct guide on the disc tray. If the disc is out of the guide, it may damage the disc and cause the unit to malfunction.
- Do not place a disc which is unplayable on the disc tray.

5 Press OPEN/CLOSE or PLAY.



The disc tray closes automatically. On the TV-screen, "▲" changes to "Reading" and then playback commences.



- A menu screen will appear on the TV screen if the disc has a menu feature. Press ▲/▼ or ◀/▶ to select title, then press **ENTER**. Title is selected and playback commences.

6 Press STOP to end playback.



■ Resuming facility

- The unit records the stopped point, depending on the disc. "■" appears on the screen. Press **PLAY** to resume playback (from the scene point).
- If you press **STOP** again ("■" appears on the screen.), the unit will clear the stopped point.

■ To start playback in the stop mode

Press **PLAY**.



Note:

If the unit does not operate properly:

Static electricity, etc., may affect the player's operation. Disconnect the AC power cord once, then connect it again.

Playing a disc (Continued)

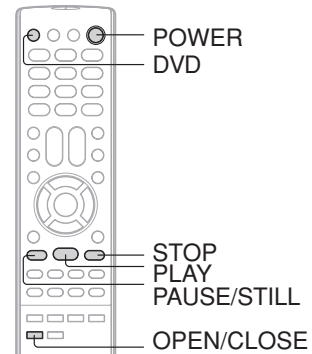

Basic playback

■ To pause playback (still mode)

Press **PAUSE/STILL** during playback.



To resume normal playback, press **PLAY**.



- The sound is muted during still mode.

■ To stop playback

Press **STOP**.



■ To remove the disc

Press **OPEN/CLOSE**.



Remove the disc after the disc tray opens completely.

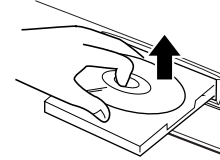

Be sure to press **OPEN/CLOSE** to close the disc tray after you remove the disc.





Notes:

- If a non-compatible disc is loaded, "Incorrect Disc", "Region Code Error" or "Parental Error" will appear on the TV screen according to the type of loaded disc. In this case, check your disc again [\[9\] \[76\]](#).
- Some discs may take a minute or so to start playback.
- When you set a single-faced disc label downwards (ie. the wrong way up) and press **OPEN/CLOSE** or **PLAY** on the unit, "Reading" will appear on the display for a few minutes and then "Incorrect Disc" will continue to be displayed.
- Some discs may not work the resuming facility.
- Resuming cannot function when you play a PBC-featured Video CD while the PBC is on. To turn off the PBC, [\[65\]](#).
- Some playback operations of DVDs may be intentionally fixed by software producers. Since this unit plays DVDs according to the disc contents the software producers designed, some playback features may not be available. Also refer to the instructions supplied with the DVDs.
- Do not move the unit during playback. Doing so may damage the disc.
- Use **OPEN/CLOSE** to open and close the disc tray. Do not push the disc tray while it is moving. Doing so may cause the unit to malfunction.
- Do not push up on the disc tray or put any objects other than discs on the disc tray. Doing so may cause the unit to malfunction.
- In many instances, a menu screen will appear after playback of a movie is completed. Prolonged display of an on-screen menu may damage your television set, permanently etching that image onto its screen. To avoid this, be sure to press **POWER** on your remote control once the movie is completed.
- There may be a slight delay between the button is pressed and the function activates.

■ To obtain a higher quality picture

Occasionally, some picture noise not usually visible on the TV screen during a normal broadcast may appear while playing a DVD video disc. It is because due to high resolution pictures on these discs which include a lot of information. The amount of noise depends on the disc you use with this unit. You should generally reduce the sharpness adjustment on your TV when viewing DVD video discs.

■ About

The     icons on the heading bar show the playable discs for the function described under that heading.

 : You can use this function with DVD video discs.

 : You can use this function with Video CDs.

 : You can use this function with Audio CDs and CD-R/RW CDs.

 : You can use this function with USB Mass Storage.

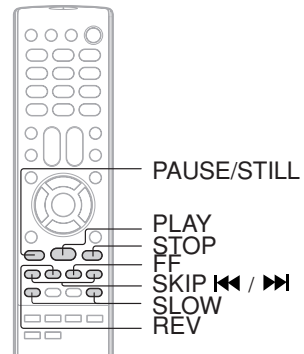

DVD VCD CD Playing in fast reverse or fast forward directions

Press **REV** or **FF** during playback.



REV: Fast reverse playback
FF: Fast forward playback

Each time you press **REV** or **FF**, the playback speed changes.

■ **To resume normal playback**

Press **PLAY**.



Notes:

- The unit mutes sound during reverse and forward scan of DVD/VCD video discs.
- The playback speed may differ depending on the disc.

DVD VCD Playing frame by frame

Press **PAUSE/STILL** during still playback.



Each time you press **PAUSE/STILL**, the picture advances one frame.

■ **To resume normal playback**

Press **PLAY**.



Note:

The sound is muted during frame by frame playback.

DVD VCD Playing in slow-motion

Press **SLOW** ◀ or ▶ during playback.

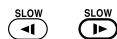

Each time you press the button, the slow-motion speed changes.

■ **To resume normal playback**

Press **PLAY**.



Notes:

- The sound is muted during slow-motion playback.
- The Video CD cannot play Reverse Slow.

DVD VCD CD Locating a chapter or track

Press **SKIP** ◀◀ or ▶▶ repeatedly to display the chapter or track number you want.

Playback starts from the selected chapter or track.



To locate succeeding chapters or tracks.



Playback starts from the beginning of the current chapter or track.

Note:

Press and hold **SKIP** on the unit during playback to play forward or reverse.

Afterwards, each time you press and hold **SKIP**, the playback speed will change.

When you press twice in quick successions, playback starts from the beginning of the preceding chapter or track.

Notes:

- A prohibition symbol "X" may appear at the upper right of the screen. This symbol means either the feature you tried is not available on the disc, or the unit cannot access the feature at this time. This does not indicate a problem with the unit.
- The unit is capable of holding a still video image or On screen display image on your television screen indefinitely. If you leave the still video image or On screen display image displayed on your TV for an extended period of time, you risk permanent damage to your television screen. Projection televisions are very susceptible.

Basic playback (DVD)

Zooming/Locating desired scene

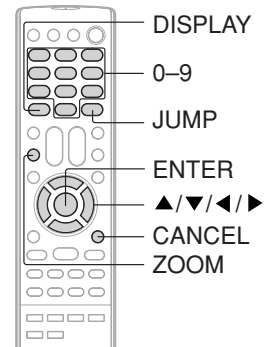

DVD VCD CD Zooming

This unit will allow you to zoom in on the frame image. You can then make selections by switching the position of the frame.

1 Press ZOOM during playback.



The center part of the image will be zoomed in. Each press of **ZOOM** will change the ZOOM Q1 (x 1.3), Q2 (x 1.5) and Q3 (x 2.0).

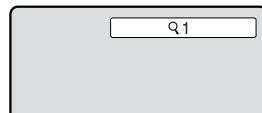

2 Press ▲/▼/◀/▶ to view a different part of the frame.



You may move the frame from the center position to UP, DOWN, LEFT or RIGHT direction.

3 In the zoom mode, press ZOOM repeatedly to return to a 1:1 view (Q Off).



Notes:

- You can select the Pause, Slow or Search playback in the zoom mode.
- Some discs may not respond to zoom feature.

DVD VCD CD Locating desired scene

Use the title, chapter and time recorded on the DVD disc to locate the desired point to playback. In the case of VCD/CD disc, time and track are used to locate the desired point to playback.

To check the title, chapter and time, press **DISPLAY**.

1 Press JUMP during playback or resume stop mode.

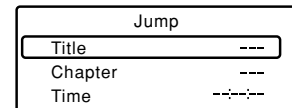

2 Press ▲ or ▼ to select the "Time", "Title/Track" or "Chapter".

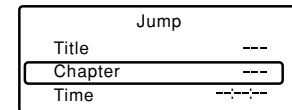

3 Press Number buttons (0-9) to input the number.

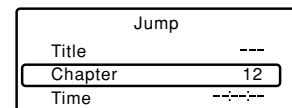
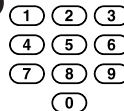

- If you input a wrong number, press **CANCEL**.
- Refer to the package supplied with the disc to check the numbers.

4 Press ENTER. Playback starts.



- When you change the title, playback starts from Chapter 1 of the selected title.
- Some discs may not work in the above operation.

Notes:

- In case of the Audio CD and Video-CD, only Track and Time can be selected.
- In case of the Video-CD playback with PBC, the JUMP does not work. To turn off PBC, see page 65.



Repeat playback/A-B Repeat playback

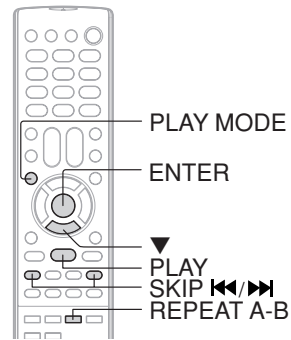

DVD VCD Repeat playback

1 Press **PLAY MODE** during playback or stop mode.



2 [DVD] Press **ENTER** to select "Chapter" or "Title".



The unit automatically starts repeat playback after finishing the current title or chapter.

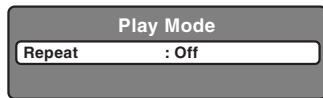

[Video CD] Press **▼** to select "Repeat". Press **ENTER** to select "Track" or "All".



The unit automatically starts repeat playback after finishing the current track.



- If you set the repeat mode during stop mode, press **PLAY** to start Repeat playback.

[Audio CD and MP3/WMA CD] Please see "Repeat playback (CD/USB)" [70].

3 Press **PLAY MODE** again to clear the screen.

To resume normal playback

Select Repeat : "Off" in step 2.

Notes:

- Some discs may not work with the repeat operation.
- In case of Video CD with PBC, Repeat functions are prohibited during playback.
- Chapter/Track repeat function is canceled whenever **SKIP** **◀◀** or **▶▶** is pressed.

DVD VCD A-B Repeat playback

A-B repeat playback allows you to repeat a section between two selected points.

1 Press **REPEAT A-B** during playback. The start point is selected.

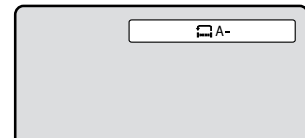

2 Press **REPEAT A-B** again. The end point is selected. Playback starts at the point that you selected. Playback stops at the end point and returns to Point A automatically, then starts again.

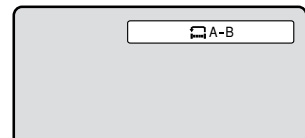

To resume normal playback

Press **REPEAT A-B** again.



"Off" appears on the screen.

Notes:

- In A-B Repeat mode, subtitles near the A or B locations may not be displayed.
- You cannot set the A-B Repeat for the scenes that include multiple angles.
- A-B Repeat playback does not work when Repeat playback is activated.
- You may not be able to set A-B Repeat, during certain scenes of the DVD, MP3/WMA/JPEG CD.
- A-B Repeat does not work with an interactive DVD.
- A-B Repeat is prohibited when PBC is on.

Advanced playback (DVD)

Program playback/Random playback

You can arrange the playback order of tracks or files on the disc. And the unit can also select tracks or files at random and playback them. These feature works for Video CD.

For Audio CD and MP3/WMA CD, please see "Random playback (CD/USB)" [70] and "Program playback (CD/USB)" [71].

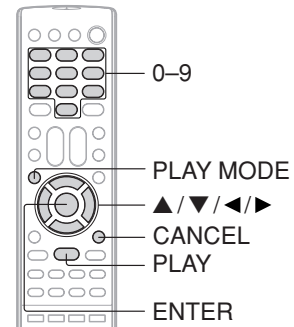

VCD Program playback

1 Press PLAY MODE in the stop mode.



2 Press ▲ or ▼ to select "Mode", then press ENTER to select "Program".



3 Press ◀▶ to select the right column, then use Number buttons (0-9) to input the track numbers. To program others, press ▲/▼ to select the programming position, then use Number buttons (0-9) to input the track numbers.



- To program others, repeat step 3.
- If you input a wrong number, press CANCEL.

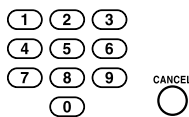

4 Press ◀▶ to return to the left column, then press ▲/▼ to select the "Program Playback" and press ENTER.

The programs you selected will start to playback in order.

- To resume normal playback, select Mode: "Off" in step 2.

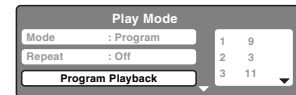

■ To change the program

1. Select Mode to "Program" (as step 2), press ◀▶ to select the right column, then press ▲/▼ to select the track number you want to change, then press CANCEL.
2. Press Number buttons (0-9) to overwrite the new track number.

■ To clear the program one by one

Select Mode to "Program", press ◀▶ to select the right column, then press ▲/▼ to select the track number. Then press CANCEL.

■ To clear all the programs

In the left column, press ▲/▼ to select "Clear Program". Then press ENTER.

Notes:

- In playing back the Video CD with PBC, you cannot set Program playback.
- The program is canceled when you open the disc tray or turn the power off.

VCD Random playback

1 Press PLAY MODE during playback or stop mode.



2 Press ▲/▼ to select "Mode", then press ENTER to select "Random".

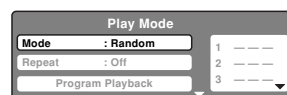

3 Press PLAY.



The Random Playback will start.

- If you set "Random" during playback mode, Random playback will begin after the track/file that is currently being played has ended.
- To resume normal playback, select Mode: "Off" in step 2.

Note:

In case of Video CD with PBC, you cannot set Random function during playback.



Changing angles/Title selection/DVD menu

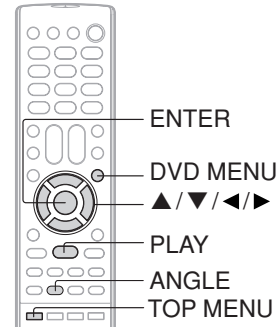

DVD Changing angles

When playing back a disc recorded with multi-angle facility, you can change the angle that you are viewing the scene from.

1 Press ANGLE during playback.
 The current angle will appear.

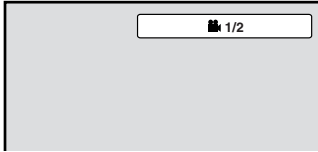

2 Press ANGLE repeatedly until the desired angle is selected.



Note:
Depending on the DVD, you may not be able to change the angles even if multi-angles are recorded on the DVD.

DVD Title selection

Two or more titles are recorded on some discs. If the title menu is recorded on the disc, you can select the desired title.

1 Press TOP MENU during playback.
 Title menu appears on the screen.

2 Press ▲/▼/◀/▶ to select the desired title.



3 Press ENTER or PLAY.
 The playback of the selected title will start.

Note:
Depending on the DVD, you may not be able to select the title. Depending on the DVD, a "title menu" may simply be called a "menu" or "title" in the instructions supplied with the disc.

DVD DVD menu

Some DVDs allow you to select the disc contents using the menu.

When you playback these DVDs, you can select the subtitle language and sound-track language, etc. using the menu.

1 Press DVD MENU during playback.
 The DVD menu appears on the screen.
 • Press **DVD MENU** again to resume playback at the scene when you pressed **DVD MENU**.

2 Press ▲/▼/◀/▶ to select the desired item.

3 Press ENTER.
 The menu continues to another screen. Repeat steps 2 and 3 to set the item completely.

Note:
Depending on the DVD, you may not be able to resume playback from the scene point when you press **DVD MENU**.

Advanced playback (DVD)

Changing soundtrack language/Subtitles

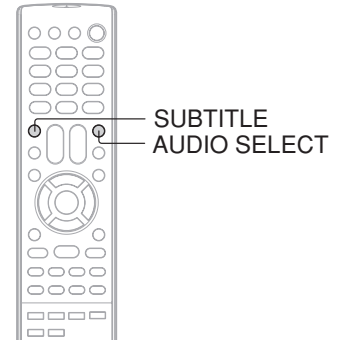

Changing soundtrack language

You can select the language when you play a multilingual disc.

1 Press AUDIO SELECT during playback.



The current soundtrack language will appear.

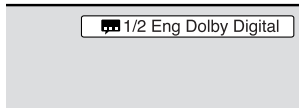

2 Press AUDIO SELECT repeatedly until the desired language is selected.

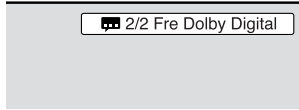

- The on screen display will disappear after a few seconds.

■ In case of Video CD playback

Audio type changes as follows each time you press **AUDIO SELECT**.



Notes:

- If the desired language is not heard after pressing the button several times, the language is not recorded on the disc.
- The selected soundtrack language is canceled when you open the disc tray. The initial default language or available language will be heard if the disc is played back again.
- If you select DTS in playing DTS-encoded disc, no sound will be heard from the unit's speakers.

Subtitles

When playing back a disc recorded with subtitles, you can select the subtitle language or turn the subtitle off.

1 Press SUBTITLE repeatedly during playback until the desired language is selected.

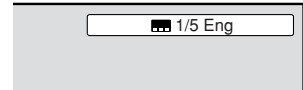

2 To turn off the subtitle, press SUBTITLE until "Off" appears.



- The on screen display will disappear after a few seconds.

Notes:

- Depending on the DVD, you may not be able to change subtitles, or to turn subtitles on or off.
- While playing a DVD, the subtitle may change when you open or close the disc tray.
- In some cases, a selected subtitle language may not be changed immediately.

Disc status/To turn off the PBC

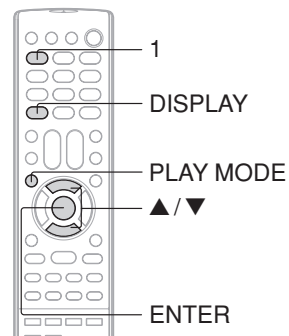

DVD VCD Disc status

With each press of DISPLAY, the status of the disc will appear on the screen and change as follows. To cancel the display, press DISPLAY again.

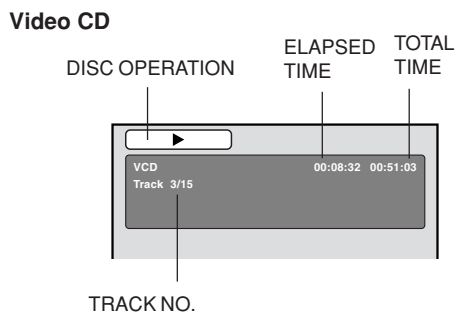
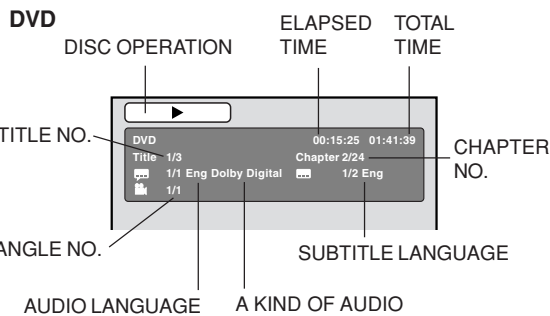

VCD To turn off the PBC (see page 8)

1 Press PLAY MODE in the stop mode.



2 Press ▲/▼ to select "Mode", then press ENTER to select "Off".

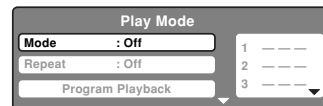

3 Press PLAY MODE again to clear the screen.

■ To turn on the PBC

Follow the above steps 1~2, then press ENTER repeatedly until "PBC" appear.

Note:

You can also turn off the PBC by pressing number button 1 and ENTER in the stop mode.

Advanced playback (DVD)

MP3/WMA/JPEG/DivX® and Audio CD operation

This player can playback the MP3/WMA/JPEG/DivX®-data which has been recorded on CD-R/RW or USB Mass Storage. Audio CD also can be played back. To produce the MP3/WMA/JPEG/DivX®-data, you need a Windows-PC with CD-RW drive or USB memory device and a MP3/WMA/JPEG/DivX®-encoding Software (not supplied). The Apple-HFS-System cannot be played.

This player requires discs/recordings to meet certain technical standards in order to achieve optimal playback quality. There are many different types of recordable disc formats (including CD-R containing MP3/WMA files). Not all recordable discs will produce optimal playback quality. The technical criteria set forth in this owner's manual are meant only as a guide. Use of CD-RW for MP3 files is not recommended.

You must obtain any required permission from copyright owners to download or use copyrighted content. Toshiba cannot and does not grant such permission.

CD MP3/WMA/JPEG/DivX® - data information

Limitations on MP3/WMA/JPEG/DivX® playback

- MP3/WMA/JPEG/DivX® CD/USB Mass Storage are standardized by ISO9660, its file name must include following extensions; “.mp3”, “.wma”, “.jpg”, “.div”, “.divx”, “.avi”.
- MP3/WMA/JPEG/DivX® CD/USB Mass Storage must be correspond to the ISO standardized files.
- This unit can read 600 files per disc. If one directory has more than 600 files, it reads up to 600 files, the remaining files will be omitted. (In case of USB Mass Storage, this limitation becomes 2,000 files).
- The unit is able to recognize up to a maximum of 50 directories per disc or USB Mass Storage.
- MP3/WMA/JPEG/DivX® CDs/USB Mass Storage cannot be used for the purpose of recording on this unit.
- If the CD/USB Mass Storage has both audio tracks and MP3/WMA/JPEG/DivX® files, only audio tracks will be played.
- It may take more than one minute for this unit to read MP3/WMA/JPEG/DivX® files depending on its structure.
- Music recorded by “Joliet Recording Specification” can be played back.
- The music files recorded by “Hierarchical File System” (HFS) cannot be played.

Limitations on displaying of the file name.

- The maximum number for display is 15 characters. Long file names will be condensed.
- Available characters for display are the following:
capital or small alphabets of A through Z, numbers of 0 through 9, and _ (under score).
- Other characters than those above are replaced in hyphen.

To playback MP3/WMA/JPEG/DivX® CD/USB Mass Storage in the recorded order.

1. Use MP3/WMA/JPEG/DivX® software that records data alphabetically or numerically.
2. Insert two or three digit number in the head of file name. (ex. “01” “02” or “001” “002”).
3. Refrain from making too many sub-folders.

CAUTION:

- Some MP3/WMA/JPEG/DivX® CDs/USB Mass Storage cannot be played back depending on the recording conditions.
- The CD-R/RW or USB Mass Storage that has no music data or non MP3/WMA/JPEG/DivX® files cannot be played back.

Standard sampling frequency, and the bit rate:

MP3

MPEG-1 Audio

32kHz, 44.1kHz, 48kHz

32kbps ~ 320kbps (constant bit rate or variable bit rate)

The recommend recording setting for a high-quality sound is 44.1kHz of sampling frequency and 128kbps of constant bit rate.

WMA

WMA version 7 and 8

32kHz/48kbps, 44.1kHz/48kbps~192kbps, 48kHz/128kbps~192kbps

The file recorded by mono, 48kHz, 48 kbps is not available to this unit.

DivX® video

DivX® version: DivX® 3, 4, 5, and 6 (specifically 3.1.1, 4.1.2, 5.0.2, 5.0.5, 5.1.1, 5.2.1, 6.0 at Home Theater profile).

Audio format: MPEG1 Layer2 (MP2), MPEG1 Layer3 (MP3)

Sampling frequencies: 32kHz, 44.1kHz, 48kHz

Bit rate: 32kbps ~ 320kbps

Resolution: Max 720 x 576 (at 25fps), Max 720 x 480 (at 30fps)

Microsoft, Windows Media, and Windows Logo are either registered trademarks or trademarks of Microsoft Corporation in the United States and/or other countries.

DivX, DivX Certified, and associated logos are trademarks of DivX, Inc. and are used under license.

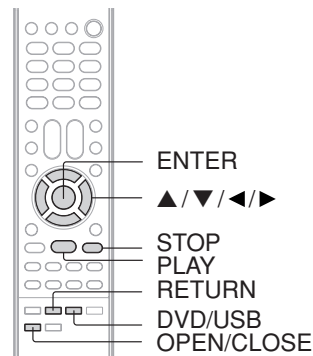

CD USB Loading media

- 1** [MP3/WMA/JPEG/DivX® CD, Audio CD]
Place a MP3/WMA/JPEG/DivX® CD or an Audio CD onto the disc tray, then press OPEN/CLOSE.
[USB Mass Storage]
Connect USB Mass Storage to the USB port on the front of the unit (see page 19).



- 2** Press DVD/USB to display the media selection window. Press ◀ or ▶ to select the DISC mode or the USB mode, then press ENTER.



You cannot select the mode if DISC/USB media is not inserted.

- 3** A file browser screen will appear on the screen.

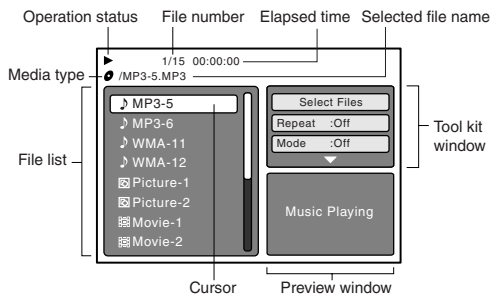

Media type

- : CD-R/RW or Audio CD
- 🔌 : USB Mass Storage

File type

- 🎵 : Indicates Music file (Audio/MP3/WMA)
- 🖼️ : Indicates Picture file (JPEG)
- 🎬 : Indicates Movie file (DivX®/video)

- In case the current directory includes 9 files or more, press ▲ or ▼ to scroll in the file list.
- To see contents in folder, select the folder and then press ENTER. To return to the upstairs directory, select "Go Up ..." then press ENTER.
- In case of a CD/USB Mass Storage containing a mixture of MP3, WMA, JPEG and DivX® files, the files are played back by selecting them from the file browser.

CD USB MP3/WMA and Audio CD playback

- 1** In the file browser, press ▲/▼ to select the desired file.

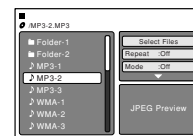

When **PLAY** is pressed after the file browser displayed, or when the disc tray is closed by pressing **PLAY**, playback begins automatically starting from the first file. In this case, if the first file is an MP3/WMA file, only MP3/WMA files are played back in order. If the first file is a JPEG file, the first JPEG file is played back. If the first file is a DivX® file, the first DivX® file is played back. If there is no file at a root directory, playback does not begin automatically.

- 2** Press ENTER.

The selected file starts playing back.



- 3** Press STOP to end playback.



- The unit records the stopped point. "■" appears on the screen. Press **PLAY** to resume playback (from the scene point).
- If you press **STOP** again or unload the disc, the unit will clear the stopped point.

Notes:

- MP3 or WMA file on the Kodak Picture CD is not recognized on this unit.
- During MP3/WMA/JPEG-Playback, you cannot use JUMP and A-B Repeat functions.
- You can use Repeat (Track or All), Random functions and Program playback for MP3/WMA/JPEG/DivX®-Playback (70, 71).
- At USB mode with no disc on the tray, you can move to DISC mode when you press **OPEN/CLOSE** on the remote control.

Select Files

The file type to make it display in the file browser can be chosen.

- Press ◀ or ▶ to highlight "Select Files" at right column in the file browser.
- Press ENTER, then press ▲ or ▼ to select file type from the list (Music, Picture or Movie).
- Press ENTER to add/remove check mark. Checked file type will be displayed in the file browser.
- Press RETURN to save the setting.

Advanced playback (DVD)

MP3/WMA/JPEG/DivX® and Audio CD operation (Continued)

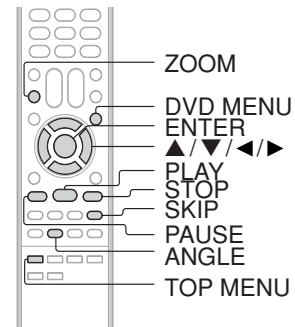

CD/USB JPEG playback

- In the file browser, press ▲/▼ to select the desired JPEG file.**
To display a thumbnail list, press **DVD MENU**. Press ◀/▶ or ▲/▼ to select the desired file. (To return to a file browser, press **TOP MENU**.)

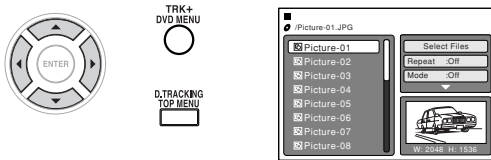

When **PLAY** is pressed after displaying the file browser, or when the disc tray is closed by pressing **PLAY**, playback begins automatically starting from the first file. In this case, if the first file is a JPEG file, the first JPEG file is played back. If the first file is a DivX® file, the first DivX® file is played back. If the first file is an MP3/WMA file, only MP3/WMA files are played back in order. If there is no file at a root directory, playback does not begin automatically.

- Press ENTER. The selected picture appears on the screen.**



Rotating an image

You can rotate an image by 90 degrees. Press **ANGLE** during playback of the image.

“↔”, “↕”, “↔” or “↕” appears on the screen.

Zooming an image

Zoom function also can be used in viewing JPEG files. Press **ZOOM** (See “Zooming” 60).

- Press STOP to end playback.**



The file browser appears on the screen. If you want to watch the other file, repeat steps 1 ~ 2.

CD/USB Slide show playback

The slide show enables you to view pictures (files) one after another automatically.

Preparation:

Set “JPEG Interval” setting to “5 Seconds”, “10 Seconds” or “15 Seconds” (75).

- Select your desired starting file for the slide show in step 1 on the left.**
- Press ENTER or PLAY to start slide show from the selected file.**



- If you press **PAUSE** during the slide show, the slide show stops temporary. “||” appears briefly on the screen. If the picture appears upside down or sideways, press **ANGLE** repeatedly until it's right side up. Press **PLAY** or **SKIP** again to resume the slide show.
- When the slide show playback finished, the file list appears.
- To stop the slide show, press **STOP**. The file list appears.

Note:

During JPEG playback, you cannot use Jump and A-B Repeat functions.

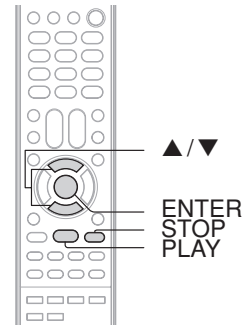

DivX® playback

1 Press ▲/▼ to select desired DivX® file.

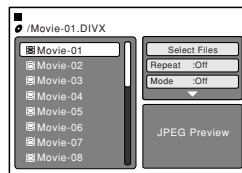

When **PLAY** has been pressed after displaying the file browser, or when the disc tray has been closed after pressing **PLAY**, playback begins automatically starting from the first file. In this case, if the first file is a JPEG file, the first JPEG file is played back. If the first file is a DivX® file, the first DivX® file is played back. If the first file is an MP3/WMA file, only MP3/WMA file are played back in order. If there is no file at a root directory, playback does not begin automatically.

2 Press **ENTER** or **PLAY**. The selected DivX® movie will be played back on the screen.



3 Press **STOP** to end playback.



The file browser appears on the screen. If you want to watch the other file, repeat steps 1 ~ 2.

Playing DivX® VOD content

DivX® VOD content is protected by DRM (Digital Rights Management) system. This restricts playback of content to specific registered devices.

If the incorrect DRM file is loaded, "Authorization Error This player is not authorized to play this video." will appear on the screen.

When you attempt to play DivX® VOD, the number of plays is limited and the right message will appear on the screen. If you wish to play it, select "Yes".

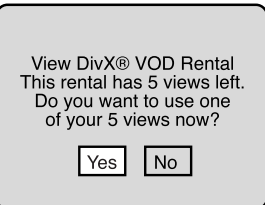

- If the number of plays goes over the limit, then "Rental Expired" will be displayed, in this case the file will not be played.

Notes:

- In order to play DivX® VOD content on this unit, you first need to register the unit with registration code. See page [76](#).
- This unit cannot playback the DivX® VOD content on the USB Mass Storage.

Advanced playback (DVD)



MP3/WMA/JPEG/DivX® and Audio CD operation (Continued)

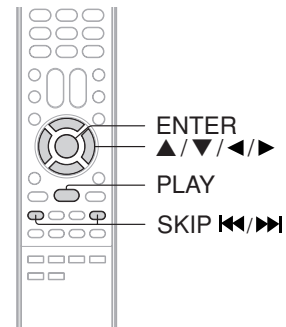

Repeat playback (CD/USB)

- In the file browser, press ◀/▶ or ▲/▼ to select "Repeat" during stop mode.
- Press ENTER to select "Track" or "All".
- Press PLAY.

The unit automatically starts repeat playback after finishing the current track.

Random playback (CD/USB)

- In the file browser, press ◀/▶ or ▲/▼ to select "Mode" during stop mode.
- Press ENTER to select "Random".
- Press PLAY.

The Random playback will start.

■ To resume normal playback
Select Repeat : "Off" in step 2.

■ To resume normal playback
Select Mode : "Off" in step 2.

Notes:

- The program is canceled when you open the disc tray or turn the power off.
- In case of Audio CD, the function of A-B Repeat also can be used. See "A-B Repeat playback" [61].
- Track repeat function is canceled whenever SKIP ◀◀ or ▶▶ is pressed.

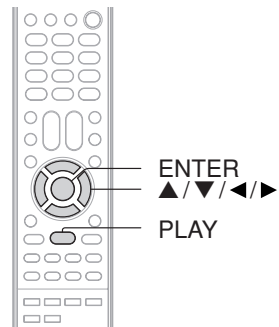

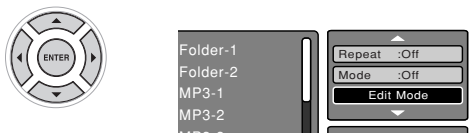

Program playback (CD/USB)

- 1** In the file browser, press  or  to select "Edit Mode", then press ENTER.



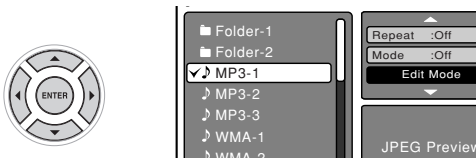

When "Edit Mode" is black color, you can mark the files which you want to add into Program list.

- 2** Press  or  to select the file you want to add into the program list.



Press **ENTER**. Selected file was marked.
Repeat this procedure to select the other files.

- 3** Press  or  to select "Add To Program". Then press ENTER. All marked files are added into the program list.



When you finish storing all the files you want into the Program list, select "Edit Mode" again and press **ENTER** to release edit mode.

- 4** Press  to select "Program View", then press ENTER. Program View shows only the programmed files that you have added in Step 2.



Browser View

Program View

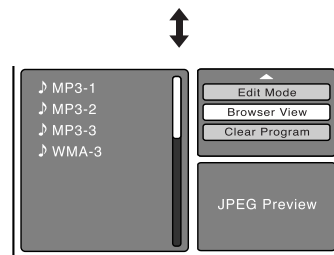

- 5** In the Program View, press **PLAY**. The files start to playback in programmed order that were added by you.



To remove file from program list

In the Edit Mode, switch to Program View. Select the files you want to remove, then press **ENTER**. Select "Clear Program" and press **ENTER**. Marked file is removed from program list.

Customizing the function settings

You can change the default settings to customize performance to your preference.

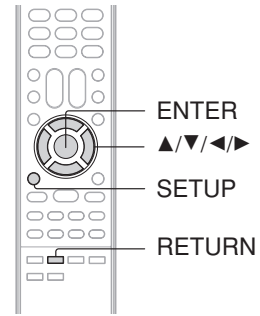

Setting procedure

1 Press **SETUP** during stop mode.



The following on-screen display appears.

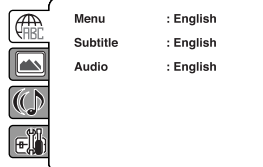

2 Press **▲** or **▼** to select the desired section, then press **◀** or **▶**.

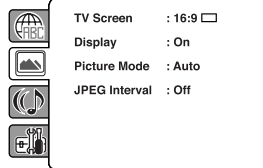

3 First option will be highlighted. Press **▲** or **▼** to select the desired option.

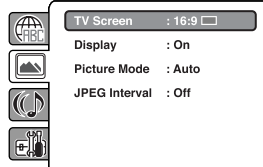

4 Then press **▶** or **ENTER**. The selectable setting will appear.

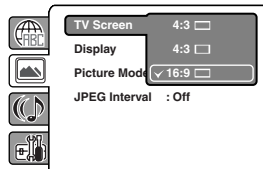

5 Change the selection using **▲** or **▼**, by referring to the corresponding pages 74~76. Press **ENTER** to save the setting.







- Repeat steps 3 and 5 to change other settings.
- To select another operation, go back to step 2 by pressing **◀** repeatedly.

6 To clear **SETUP** screen, press **SETUP** or **RETURN**.





Setting details

Section	Option	Details	Page
	Menu Subtitle Audio	To select the language of "Menu", "Subtitle" and "Audio" if more than one language are available on the disc.	74
	TV Screen	To select a picture size according to the aspect ratio of your TV.	
	Display	To turn On or Off the operational status display on the screen.	75
	Picture Mode	To select a preferred picture mode from "Video", "Film" or "Auto".	
	JPEG Interval	To select a preferred setting for the slide show playback.	
	DRC	To select On or Off for DRC (Dynamic Range Control).	
	Parental	To select a preferred parental level for the parental setting.	76
	Password	Input 4-digit password to set the parental level.	
	DivX(R) VOD	To display your 8-character registration code.	

Function setup (DVD)



Customizing the function settings (Continued)

Setting details



	Menu	: English
	Subtitle	: English
	Audio	: English

■ Menu, Subtitle, Audio

You can select the language of “Menu”, “Subtitle” and “Audio” if more than one languages are recorded onto the disc.

English, Francais, Espanol:

The selected language will be heard or seen.

Other:

Other language can be selected (see “Language code list” on page 78).

Original (Audio):

The unit will select the first-priority language of each disc.

Off (Subtitle):

Subtitles do not appear.

Notes:

- If the selected language is not recorded on the disc, the first-priority language is selected.
- If you want to change the OSD language, you can perform it by TV MENU (see page 23).



	TV Screen	: 16:9 <input type="checkbox"/>
	Display	: On
	Picture Mode	: Auto
	JPEG Interval	: Off

■ TV Screen

You have the following screen sizes to choose from:

4:3 (Letter box):

Select this mode when connecting to a conventional TV. When playing back a wide screen-DVD disc, it displays the wide picture with black bands at the top and bottom of screen.

4:3 (Pan & scan):

It displays the wide picture on the whole screen with left and right edges automatically cut off.

16:9 (Wide):

A wide screen picture is displayed full size.

Press **OPEN/CLOSE** to view in the selected screen size.

Note:

If the DVD disc is not formatted in the Pan & scan style, it will display 4:3 style.

■ Display

On screen display can be switched on or off when you press any buttons.

On: On screen displays appear when you press the buttons (factory setting).

Off: On screen displays do not appear when you press any buttons.



Picture Mode

There are two types of source content in pictures recorded in DVD video discs: film content (pictures recorded from films at 24 frames per second) and video content (video signals recorded at 30 frames per second). Make this selection according to the type of content being viewed.

- Auto:** Select this position normally. The DVD player automatically detects source content, film or video of playback source, and converts that signal in the progressive output format in an appropriate method.
- Film:** The DVD player converts film content pictures in the progressive output format appropriately. Suitable for playback of film content pictures. The progressive output feature will be most effective under this selection.
- Video:** The DVD player filters video signal, and converts it in the progressive output format appropriately. Suitable for playback of video content pictures.

Note: Depending on the disc, pictures may be cut off or doubled. In this case, select "Video".

JPEG Interval

You can continuously playback all JPEG files automatically. After the selection below, the disc will start playback on which JPEG files have been recorded.

- Off:** Plays back one file at a time.
- 5 Seconds:** Plays back images in the form of a slide show at 5 second intervals.
- 10 Seconds:** Plays back images in the form of a slide show at 10 second intervals.
- 15 Seconds:** Plays back images in the form of a slide show in 15 second intervals.



DRC

DRC (Dynamic Range Control) enables you to control the dynamic range so as to achieve a suitable sound for your equipment.

- On:** Loud sound such as explosion is toned down slightly when played back. This is suitable when it is connected to a stereo.
- Off:** It plays back at the recording level on the disc.

Notes:

- This function works only during playback of Dolby Digital recorded discs.
- The level of Dynamic Range Reduction may differ depending on DVD video disc.

Customizing the function settings (Continued)

Setting details

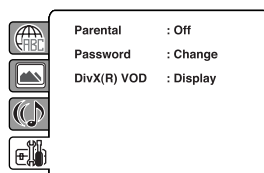

■ Parental control setting

Some discs are specified as not suitable for children. Such discs can be limited not to playback with the unit.

- 1) Press **▲** or **▼** to select "Parental", then press **ENTER**. "Enter Password" screen will appear.
- 2) Press "0000" using **Number buttons (0-9)**. (Please note, this is pre-setting password of this unit). Then press **ENTER**. The parental level list will appear.
 - **Level Off**: The parental control setting does not function.
 - **Level 8**: Virtually all DVD software can be played back.
 - **Level 1**: DVD software for adults cannot be played back.
- 3) Press **▲** or **▼** to select from the level 1 to level 8. The limitation will be more severe as the level number is lower. Then press **ENTER**.
- 4) Press **OPEN/CLOSE** to activate Parental control setting.

Notes:

- The parental control level is equivalent to the following USA movie ratings.

Level 1: G	Level 5:
Level 2:	Level 6: R
Level 3: PG	Level 7: NC-17
Level 4: PG-13	Level 8:

The parental control levels for other countries/area than U.S. are included for future use. Check the appropriate parental control level when you buy a DVD video disc equipped with the parental control feature in the future.

- Depending on the discs, the unit cannot limit playback.
- Some discs may not be encoded with specific rating level information though its disc jacket says "adult." For those discs, the age restriction will not work.
- The password is required every time when you change the parental level.
- If you input a wrong number, press **CANCEL**.

■ Set the new password

- 1) Press **▲** or **▼** to select "Password", then press **ENTER**. "Enter Current Password" screen will appear.
- 2) Press **Number buttons (0-9)** to input the current password (If the password has not been set yet after you purchase this unit, it is "0000").
- 3) Then press **ENTER**. "Enter New Password" screen will appear. Press **Number buttons (0-9)** to input the new password.
- 4) Press **ENTER**. Now your new password has been set. Be sure to remember this number!

If you forget the password.

- 1) Press **OPEN/CLOSE** to open the disc tray.
- 2) Remove the disc.
- 3) Press **OPEN/CLOSE** again to close the disc tray. "No Disc" appears on the screen.
- 4) While holding **7** down on the remote control and at the same time press **STOP** on the front panel. "Password Clear" appears on the screen. Now the password has been returned to the initial value ("0000").

■ DivX® VOD

In order to play DivX® VOD (Video On Demand) content on this unit, you first need to register the unit with your DivX® VOD content provider. You do this by generating a DivX® VOD registration code, which you submit to your provider.

Press **▲** or **▼** to select "DivX(R) VOD". Then press **ENTER**. Your 8-character registration code is displayed. Make a note of the code as you will need it when you register with a DivX® VOD provider. Then press **ENTER**.

Note:

If each setup (pages 74~76) has completed, the unit can always work under the same condition (especially with DVD discs).

Each setup will be retained in the memory even if you turn the power off.



Temporary cancel the rating level by DVD disc

Depending on the DVD disc, the disc may try to temporarily cancel the rating level that you have set. It is up to you to decide whether to cancel the rating level or not.

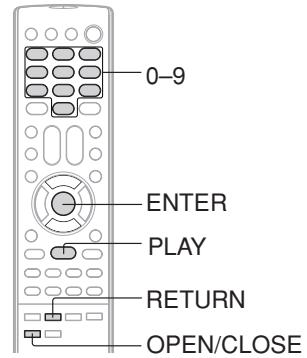

DVD Temporary cancel the rating level by DVD disc

- 1** Load a DVD disc and press **PLAY** or **OPEN/CLOSE** on the unit [47](#).

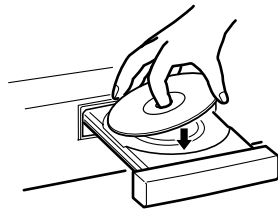

- 2** If the DVD disc has been designed to temporarily cancel the Rating level, the screen which follows the "Reading" screen will change, depending on which disc is played. If you select "YES" with the **ENTER** key, password input screen will then appear.

- 3** Enter the password with Number buttons (0-9). Then press **ENTER**.

To exit from the entry, press **RETURN**.

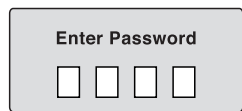
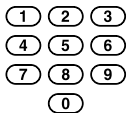

- 4** Playback will commence if the entered password was correct.

Note:

This temporary cancellation of rating level will be kept until the disc is ejected. When the disc is ejected, the original rating level will be set again automatically.

Language code list

Enter the appropriate code number for the initial settings "Menu", "Subtitle" and/or "Audio" **[74]**.

Language Name	Code	Language Name	Code	Language Name	Code	Language Name	Code
Abkhazian	1112	Fiji	1620	Lingala	2224	Singhalese	2919
Afar	1111	Finnish	1619	Lithuanian	2230	Slovak	2921
Afrikaans	1116	French	1628	Macedonian	2321	Slovenian	2922
Albanian	2927	Frisian	1635	Malagasy	2317	Somali	2925
Amharic	1123	Galician	1722	Malay	2329	Spanish	1529
Arabic	1128	Georgian	2111	Malayalam	2322	Sundanese	2931
Armenian	1835	German	1415	Maltese	2330	Swahili	2933
Assamese	1129	Greek	1522	Maori	2319	Swedish	2932
Aymara	1135	Greenlandic	2122	Marathi	2328	Tagalog	3022
Azerbaijani	1136	Guarani	1724	Moldavian	2325	Tajik	3017
Bashkir	1211	Gujarati	1731	Mongolian	2324	Tamil	3011
Basque	1531	Hausa	1811	Nauru	2411	Tatar	3030
Bengali; Bangla	1224	Hebrew	1933	Nepali	2415	Telugu	3015
Bhutani	1436	Hindi	1819	Norwegian	2425	Thai	3018
Bihari	1218	Hungarian	1831	Oriya	2528	Tibetan	1225
Breton	1228	Icelandic	1929	Panjabi	2611	Tigrinya	3019
Bulgarian	1217	Indonesian	1924	Pashto, Pushto	2629	Tonga	3025
Burmese	2335	Interlingua	1911	Persian	1611	Turkish	3028
Byelorussian	1215	Irish	1711	Polish	2622	Turkmen	3021
Cambodian	2123	Italian	1930	Portuguese	2630	Twi	3033
Catalan	1311	Japanese	2011	Quechua	2731	Ukrainian	3121
Chinese	3618	Javanese	2033	Rhaeto-Romance	2823	Urdu	3128
Corsican	1325	Kannada	2124	Romanian	2825	Uzbek	3136
Croatian	1828	Kashmiri	2129	Russian	2831	Vietnamese	3219
Czech	1329	Kazakh	2121	Samoan	2923	Volapük	3225
Danish	1411	Kirghiz	2135	Sanskrit	2911	Welsh	1335
Dutch	2422	Korean	2125	Scots Gaelic	1714	Wolof	3325
English	1524	Kurdish	2131	Serbian	2928	Xhosa	3418
Esperanto	1525	Laothian	2225	Serbo-Croatian	2918	Yiddish	2019
Estonian	1530	Latin	2211	Shona	2924	Yoruba	3525
Faroese	1625	Latvian, Lettish	2232	Sindhi	2914	Zulu	3631



Reception disturbances

Most types of television interference can be remedied by adjusting the height and position of the VHF/UHF antenna. Outdoor antennas are recommended for best results. The most common types of television interference are shown below. If one of these symptoms appear when the unit is connected to a Cable TV system, the disturbance may be caused by the local Cable TV company broadcast.

IGNITION

Black spots or horizontal streaks may appear, the picture may flutter or drift. Usually caused by interference from automobile ignition systems, neon lamps or AC powered tools and appliances such as drills or hair dryers.



GHOSTS

Ghosts are caused by the television signal following two paths. One is the direct path and the other is reflected by tall buildings, hills or other large objects. Changing the direction or position of the antenna may improve the reception.



SNOW

If the unit is located far from the TV station, in a fringe reception area where the signal is weak, small dots may appear in the picture. If the signal is extremely weak, the installation of a larger external antenna may be necessary.



RADIO FREQUENCY INTERFERENCE (RFI)

Caused by two-way radios, this type of interference produces moving ripples or diagonal streaks in the picture. Some cases may cause a loss of contrast in the picture. Changing the direction and position of the antenna or installing an RFI filter may improve the picture.



PICTURE SIZE VARIATION

A slight picture size variation is normal when you adjust the CONTRAST or BRIGHTNESS settings.



Others

CARE AND MAINTENANCE

To prevent fire or shock hazard, disconnect the unit from the power source before cleaning. The finish on the cabinet may be cleaned with mild soap and a soft, damp cloth and cared for as other furniture. Use caution when cleaning or wiping the plastic parts.



Troubleshooting

Check the following guide for the possible cause of a problem before contacting service.

SYMPTOMS	CAUSE	POSSIBLE SOLUTIONS	PAGE
POWER			
No power.	The AC power cord is not connected.	Connect the AC power cord to the AC outlet.	5
Although the power is on, the unit does not operate.	Disc is not inserted.	Insert a disc.	46
TV BROADCAST RECEPTION			
Poor or no picture	TV station experiencing problems.	Try another channel.	24
	Picture control is not adjusted.	Check picture control adjustments.	37
	Possible local interference.	Check for source of reception disturbance.	79
	Antenna (CABLE) connector is not connected or possible local interference.	Check CABLE connection or VHF/UHF antenna, reposition or rotate antenna.	13, 14
Poor or no color.	TV station experiencing problems.	Try another channel.	25
	Picture control is not adjusted.	Check picture control adjustments.	37
	Possible local interference.	Check for source of reception disturbance.	79
	Antenna (CABLE) connector is not connected or possible local interference.	Check CABLE connection or VHF/UHF antenna, reposition or rotate antenna.	13, 14
Picture wobbles or drifts.	TV station experiencing problems.	Try another channel.	25
	Antenna (CABLE) connector is not connected or possible local interference.	Check CABLE connection or VHF/UHF antenna, reposition or rotate antenna.	13, 14
	Cable TV channel is scrambled.	Try another channel.	25
No CATV reception.	CABLE connector is not connected.	Check all CABLE connections.	14
	TV/CABLE selection is set to the TV position.	Set the selection to the CABLE position.	27
	Cable TV service interrupted.	Contact your Cable TV company.	–
No reception above channel 13.	TV/CABLE selection is not set to the appropriate position.	Make sure selection is in the appropriate position.	27
	UHF antenna is not connected.	Check UHF antenna.	13
Poor or no sound.	TV station experiencing problems.	Try another channel.	25
	Antenna (CABLE) connector is not connected or possible local interference.	Check CABLE connection or VHF/UHF antenna, reposition or rotate antenna.	13, 14
	Possible local interference.	Check for source of reception disturbance.	79
	The MUTE button is pressed.	Press MUTE to cancel mute function.	26
TV shuts off.	TV station stopped broadcasting.	Tune new channel.	20
	Sleep timer is set.	Set Sleep Timer to "0h00m".	26
Closed caption is not activated.	TV station experiencing problems or program tuned is not closed captions.	Try another channel.	25
	TV signal is weak.	Check CABLE connection of VHF/UHF antenna, reposition or rotate antenna.	13, 14
	The CLOSED CAPTION button is not pressed.	Press CLOSED CAPTION to turn on the closed caption.	29



SYMPTOMS	CAUSE	POSSIBLE SOLUTIONS	PAGE
VCR			
TV recording does not work.	The video cassette's erase prevention tab is broken off.	Place a piece of adhesive tape over the hole.	46
Timer recording does not work.	The time is not set correctly.	Reset the present time.	23
	The recording start/end time is not set correctly.	Reset the start/end time.	53
	The TIMER REC button is not pressed (the TIMER REC indicator is not lit).	Press TIMER REC (the TIMER REC indicator is lit).	53
Noise bars appear on the screen.	Tape is old or worn.	Replace the tape.	–
	Tracking adjustment is beyond range of automatic tracking circuit.	Adjust tracking manually using TRK +/- on the remote control.	48
	Video heads are dirty.	Clean the video heads.	50
DVD			
The playback picture has occasional distortion.	The disc is dirty.	Eject the disc and clean it.	8
	It is in fast forward or fast reverse playback.	Some times a small amount of picture distortion may appear. This is not a malfunction.	–
The unit does not start playback.	No disc is inserted.	Insert a disc.	47
	An unplayable disc is inserted.	Insert a playable disc (Check the disc type and color system).	9
	The disc is placed upside down.	Place the disc with the playback side down.	47
	The disc is not placed within the guide.	Place the disc correctly inside the guide on the disc tray.	47
	The parental lock function is set.	Cancel the parental lock function or change the parental lock level.	76, 77
Playback does not follow the course of the disc's program.	It is in the mode of repeat playback, memory playback, etc.	These operations may prevent a proper progress of the contents.	–
"X" appears on the screen.	The function is prohibited with the unit or the disc.	–	9
REMOTE CONTROL			
Remote control does not operate.	The remote control is not aimed at the sensor.	Aim the remote control at the remote sensor.	12
	Distance is too far or too much light in the room.	Operate within 5 m or reduce the light of the room.	12
	There is an obstacle in the path of the beam.	Clear the path of the beam.	12
	The batteries are weak.	Replace the batteries.	12
	The batteries are not inserted correctly.	Insert correctly.	12

Others

Specifications

General	
Power supply	AC 120 V 60 Hz
Power consumption	Operation: 188 W, Stand by: 4W
Picture tube	26 Inch* diagonal (656.7 mm diagonal)
Speaker	2 x 3-1/2 inches (50.8 x 88.9 mm), 8 ohm x 2
Audio output power	2.5 W + 2.5 W
Weight	89.3 lbs (40.5 kg)
Dimensions	Width: 27-9/16 inches (700 mm) Height: 21-6/8 inches (553 mm) Depth: 19-13/16 inches (504 mm)
Tuner	181 channel freq. synthesized VHF: 2-13 UHF: 14-69 CATV: 125 Channels
Antenna input	UHF/VHF: 75 W coaxial
Color system	NTSC
Video head	4 Rotary heads
Audio track	Hi-Fi sound - 2 Tracks / MONO sound - 1 Track
Hi-Fi frequency response	20 Hz to 20 kHz
Hi-Fi dynamic range	More than 90 dB
F.FWD/REW at 25°C (77°F)	Approx. 1 minute and 48 seconds (with T-120 cassette tape) time
Applicable disc	DVD (12 cm, 8 cm), CD (12 cm, 8 cm)
Frequency range	DVD: 4 Hz-22 kHz, CD: 4 Hz-20 kHz
Operating conditions	Temperature: 5°C-40°C (41°F-104°F), Operating status: Horizontal
Input/Output	
Video input	1.0 V (p-p), 75 W, negative sync., pin jack x 2
Audio input	-8 dBm, 50 kW, negative sync., pin jack (L/R) x 2
S-Video input C: 0.286 V (p-p) (burst signal), 75 W	Y: 1.0 V (p-p), 75 W, negative sync.
ColorStream® (component video) input	Y: 1.0 V (p-p), 75 W PR: 0.7 V (p-p), 75 W PB: 0.7 V (p-p), 75 W
HDMI input	HDMI compliant (type A connector), HDCP compliant, E-EDID compliant Suggested scan rates: 1080i, 480p, 480i, 720p
HDMI Audio input	2-channel PCM, 32/44.1/48 kHz sampling frequency, 16/20/24 bits per sample
Audio output	COAXIAL DIGITAL : 0.5 V (p-p), 75 W, pin jack x 1 OPTICAL DIGITAL : Optical connector x 1
Supplied accessories	
Remote control (WC-SBH23)	1
Batteries (R03/AAA)	2
300-75 W matching transformer	1

* Screen size is approximate.

- This model complies with the above specifications.
- Designs and specifications are subject to change without notice.
- This model may not be compatible with features and/or specifications that may be added in the future.



Limited United States Warranty

for model MW26H82 ("TV Combination(s)")

Toshiba America Consumer Products, L.L.C. ("TACP") makes the following limited warranties to original consumers in the United States. **THESE LIMITED WARRANTIES EXTEND TO THE ORIGINAL CONSUMER PURCHASER OR ANY PERSON RECEIVING THIS TV COMBINATION AS A GIFT FROM THE ORIGINAL CONSUMER PURCHASER AND TO NO OTHER PURCHASER OR TRANSFEREE.**

TV COMBINATIONS PURCHASED IN THE U.S.A. AND USED ANYWHERE OUTSIDE OF THE U.S.A., INCLUDING, WITHOUT LIMITATION, CANADA AND MEXICO, ARE NOT COVERED BY THESE WARRANTIES. TV COMBINATIONS PURCHASED ANYWHERE OUTSIDE OF THE U.S.A., INCLUDING, WITHOUT LIMITATION, CANADA AND MEXICO, AND USED IN THE U.S.A., ARE NOT COVERED BY THESE WARRANTIES.

Limited Ninety (90) Day Warranty on Labor

TACP warrants this TV Combination and its parts against defects in materials or workmanship for a period of ninety (90) days after the date of original retail purchase. **DURING THIS PERIOD, TACP WILL, AT TACP'S OPTION, REPAIR OR REPLACE A DEFECTIVE PART WITH A NEW OR REFURBISHED PART WITHOUT CHARGE TO YOU FOR PARTS OR LABOR.** During this period, TACP Authorized Service Station personnel will come to your home when warranty service is required. Depending on the type of repair required, the service will either be performed in your home or the TV Combination will be taken to a TACP Authorized Service Station for repair and returned to your home at no cost to you.

Limited One (1) Year Warranty on Parts

TACP further warrants the parts in this TV Combination against defects in materials or workmanship for a period of one (1) year after the date of original retail purchase. **DURING THIS PERIOD, TACP WILL, AT TACP'S OPTION, REPAIR OR REPLACE A DEFECTIVE PART WITH A NEW OR REFURBISHED PART WITHOUT CHARGE TO YOU FOR THE PART, PROVIDED THAT IF A DEFECTIVE PART IS REPAIRED OR REPLACED AFTER NINETY (90) DAYS AFTER THE DATE OF ORIGINAL RETAIL PURCHASE, YOU MUST PAY ALL LABOR CHARGES IN CONNECTION WITH THE REPAIR OR REPLACEMENT THEREOF.** After the date that is ninety (90) days after the date of original retail purchase, you may request in-home service at your expense, or you may deliver the entire TV Combination to a TACP Authorized Service Station. If you elect to deliver the entire TV Combination to a TACP Authorized Service Station, you must pay for all transportation and insurance charges for the TV Combination to and from the TACP Authorized Service Station.

Limited Two (2) Year Warranty on Picture Tube

TACP further warrants the picture tube in this TV Combination against defects in materials or workmanship for a period of two (2) years after the date of original retail purchase. **DURING THIS PERIOD, TACP WILL, AT TACP'S OPTION, REPAIR OR REPLACE A DEFECTIVE PICTURE TUBE WITH A NEW OR REFURBISHED PICTURE TUBE WITHOUT CHARGE TO YOU, PROVIDED THAT IF A DEFECTIVE PICTURE TUBE IS REPAIRED OR REPLACED AFTER NINETY (90) DAYS AFTER THE DATE OF ORIGINAL RETAIL PURCHASE, YOU MUST PAY FOR ALL LABOR CHARGES IN CONNECTION WITH THE REPAIR OR REPLACEMENT THEREOF.** After the date that is ninety (90) days after the date of original retail purchase, you may request in-home service at your expense, or you may deliver the entire TV Combination to a TACP Authorized Service Station. If you elect to deliver the entire TV Combination to a TACP Authorized Service Station, you must pay for all transportation and insurance charges for the TV Combination to and from the TACP Authorized Service Station.

Rental Units

The warranty for TV Combination rental units begins on the date of the first rental or thirty (30) days after the date of shipment to the rental firm, whichever comes first.

Limited Warranty for Commercial Units

TACP warrants TV Combinations that are sold and used for commercial purposes as follows: all parts are warranted against defects in materials or workmanship for a period of ninety (90) after the date of original retail purchase. **DURING THIS PERIOD, TACP WILL, AT TACP'S OPTION, REPAIR OR REPLACE A DEFECTIVE PART WITH A NEW OR REFURBISHED PART WITHOUT CHARGE TO YOU.**

Owner's Manual and Product Registration Card

Read this owner's manual thoroughly before operating this TV Combination. Complete and mail the enclosed product registration card or register your TV Combination online at www.tacp.toshiba.com/service as soon as possible. By registering your TV Combination you will enable TACP to bring you new products specifically designed to meet your needs and help us to contact you in the unlikely event a safety notification is required under the U.S. Consumer Product Safety Act. Failure to complete and return the product registration card does not diminish your warranty rights.

Your Responsibility

THE ABOVE WARRANTIES ARE SUBJECT TO THE FOLLOWING CONDITIONS:

- (1) You must retain your original bill of sale or provide other proof of purchase.
- (2) All warranty servicing of this TV Combination must be performed by an Authorized TACP Service Station.
- (3) The warranties from TACP are effective only if this TV Combination is purchased and operated in the Continental U.S.A. or Puerto Rico.

Others



- (4) Labor service charges for set installation, setup, adjustment of customer controls, and installation or repair of antenna systems are not covered by this warranty. Reception problems caused by inadequate antenna systems, misaligned satellite dishes, cable television distribution, VCRs, DVD players/recorders, personal computer level IEEE-1394 devices, and any other connected signal source device are your responsibility.
- (5) Warranties extend only to defects in materials or workmanship as limited above, and do not extend to any TV Combination or parts that have been lost or discarded by you or to damage to the TV Combination or parts caused by fires, misuse, accident, Acts of God (such as lightning or fluctuations in electric power), improper installation, improper maintenance, or use in violation of instructions furnished by TACP; use or malfunction through simultaneous use of this TV Combination and connected equipment; or to units that have been modified or had the serial number removed, altered, defaced, or rendered illegible.

How to Obtain Warranty Service

If, after following all of the operating instructions in this manual and reviewing the section entitled "Troubleshooting," you find that service is needed:

- (1) To find the nearest TACP Authorized Service Station, visit TACP's website at www.tacp.toshiba.com/service or contact TACP's Consumer Solution Center toll free at 1-800-631-3811.
- (2) You must present your original bill of sale or other proof of purchase to the TACP Authorized Service Station.

For additional information, visit TACP's website:
www.tacp.toshiba.com

ALL WARRANTIES IMPLIED BY THE LAW OF ANY STATE OF THE U.S.A., INCLUDING THE IMPLIED WARRANTIES OF MERCHANTABILITY AND FITNESS FOR A PARTICULAR PURPOSE, ARE EXPRESSLY LIMITED TO THE DURATION OF THE LIMITED WARRANTIES SET FORTH ABOVE. WITH THE EXCEPTION OF ANY WARRANTIES IMPLIED BY THE LAW OF ANY STATE OF THE U.S.A. AS HEREBY LIMITED, THE FOREGOING WARRANTY IS EXCLUSIVE AND IN LIEU OF ALL OTHER WARRANTIES, GUARANTEES, AGREEMENTS, AND SIMILAR OBLIGATIONS OF TACP WITH RESPECT TO THE REPAIR OR REPLACEMENT OF ANY PARTS. IN NO EVENT SHALL TACP BE LIABLE FOR CONSEQUENTIAL OR INCIDENTAL DAMAGES (INCLUDING, BUT NOT LIMITED TO, LOST PROFITS, BUSINESS INTERRUPTION, OR MODIFICATION OR ERASURE OF RECORDED DATA CAUSED BY USE, MISUSE OR INABILITY TO USE THIS TV COMBINATION).

No person, agent, distributor, dealer, or company is authorized to change, modify, or extend the terms of these warranties in any manner whatsoever. The time within which an action must be commenced to enforce any obligation of TACP arising under the warranty or under any statute or law of the United States or any state thereof is hereby limited to ninety (90) days from the date you discover, or should have discovered, the defect. This limitation does not apply to implied warranties arising under the law of any state of the U.S.A.

THIS WARRANTY GIVES YOU SPECIFIC LEGAL RIGHTS AND YOU MAY ALSO HAVE OTHER RIGHTS WHICH MAY VARY FROM STATE TO STATE IN THE U.S.A. SOME STATES OF THE U.S.A. DO NOT ALLOW LIMITATIONS ON THE DURATION OF AN IMPLIED WARRANTY, WHEN AN ACTION MAY BE BROUGHT, OR THE EXCLUSION OR LIMITATION OF INCIDENTAL OR CONSEQUENTIAL DAMAGES. THEREFORE, THE ABOVE PROVISIONS MAY NOT APPLY TO YOU UNDER SUCH CIRCUMSTANCES.

TOSHIBA

TOSHIBA AMERICA CONSUMER PRODUCTS, L.L.C.

CableClear, ColorStream, FST Pure and StableSound are registered trademarks of Toshiba America Consumer Products, L.L.C.



Printed in Thailand



Free Manuals Download Website

<http://myh66.com>

<http://usermanuals.us>

<http://www.somanuals.com>

<http://www.4manuals.cc>

<http://www.manual-lib.com>

<http://www.404manual.com>

<http://www.luxmanual.com>

<http://aubethermostatmanual.com>

Golf course search by state

<http://golfingnear.com>

Email search by domain

<http://emailbydomain.com>

Auto manuals search

<http://auto.somanuals.com>

TV manuals search

<http://tv.somanuals.com>