

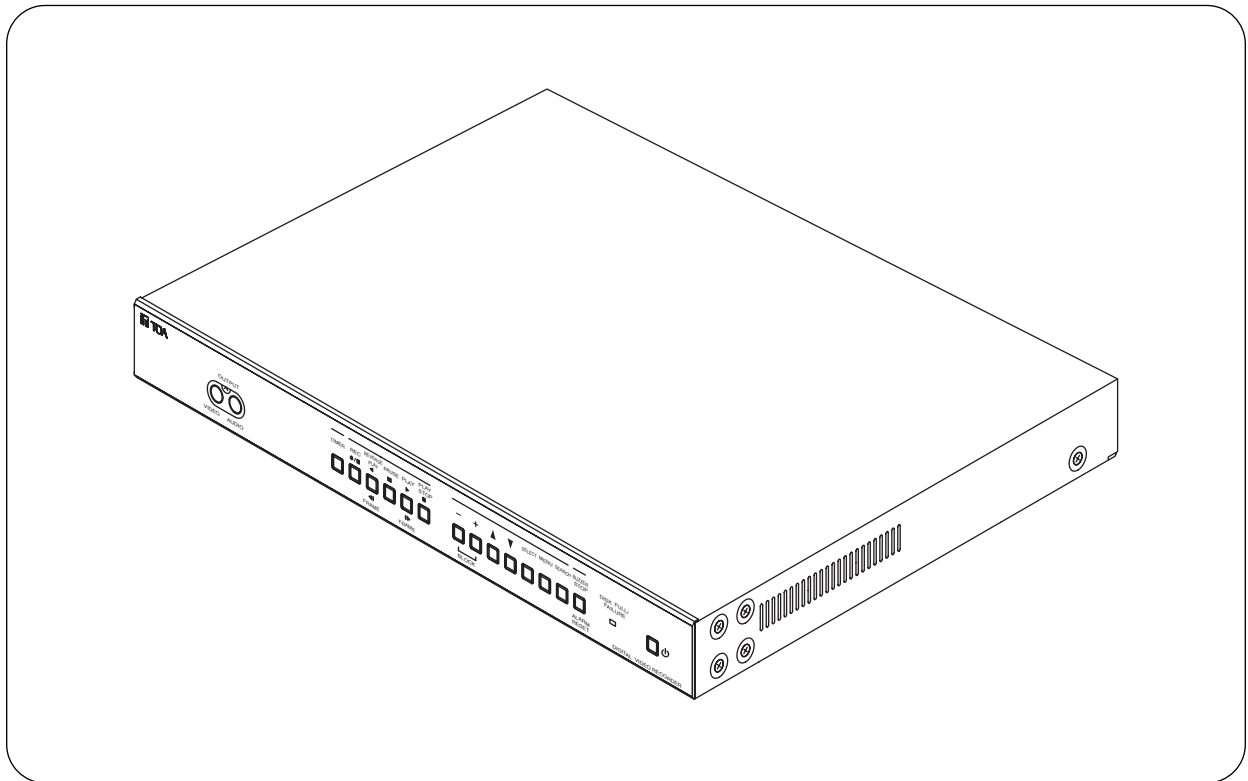

## INSTRUCTION MANUAL

# 1CH DIGITAL VIDEO RECORDER C-DR0100 ( NTSC SYSTEM ) C-DR0101 C-DR0105



Please follow the instructions in this manual to obtain the optimum results from this unit. We also recommend that you keep this manual handy for future reference.

TOA Corporation

# TABLE OF CONTENTS

<b>1. SAFETY PRECAUTIONS</b> .....	5
------------------------------------	---

<b>SUMMARY</b>
----------------

<b>2. GENERAL DESCRIPTION</b> .....	6
-------------------------------------	---

<b>3. FEATURES</b> .....	6
--------------------------	---

<b>4. HANDLING PRECAUTIONS</b> .....	7
--------------------------------------	---

## **5. NOMENCLATURE AND FUNCTIONS**

Front Panel .....	8
-------------------	---

Rear Panel .....	10
------------------	----

<b>SETTING BASICS</b>
-----------------------

## **6. SETTING ITEM CHART AND SETTING PROCEDURES**

6.1. Basic Setting Procedures .....	11
-------------------------------------	----

6.2. Setting Item Chart .....	12
-------------------------------	----

## **7. INDIVIDUAL ITEM SETTINGS**

7.1. Main Menu Screen .....	13
-----------------------------	----

7.2. Playback Settings .....	13
------------------------------	----

7.3. Clock Settings .....	14
---------------------------	----

7.3.1. Summer Time (Daylight Saving Time) Settings .....	15
--	----

7.4. Disk Settings .....	15
--------------------------	----

7.5. Recording Settings .....	16
-------------------------------	----

7.5.1. General Recording Settings .....	17
---	----

7.5.2. Internal Timer Recording Settings .....	17
--	----

7.5.3. Alarm Recording Settings .....	19
---------------------------------------	----

7.5.4. About the Alarm Input Mode .....	20
---	----

7.6. Screen Display Settings .....	21
------------------------------------	----

7.7. Key Lock .....	22
---------------------	----

7.7.1. Key Lock Release .....	22
-------------------------------	----

7.8. Communication Settings .....	23
-----------------------------------	----

7.8.1. Network Settings .....	23
-------------------------------	----

7.9. Log Display .....	24
------------------------	----

7.9.1. General/Timer Recording Logs .....	24
---	----

7.9.2. Alarm Recording Logs .....	24
-----------------------------------	----

7.9.3. Failure Logs .....	25
---------------------------	----

7.10. System Maintenance .....	25
--------------------------------	----

7.10.1. Menu Default Settings .....	25
-------------------------------------	----

7.10.2. Disk Formatting .....	26
-------------------------------	----

## OPERATION

### 8. DIGITAL VIDEO RECORDER ACTIVATION AND TERMINATION

8.1. Recorder's Activation .....	27
8.2. When the Failure Screen Is Displayed .....	28
8.3. Recorder's Termination .....	28

### 9. OPERATION AFTER POWER FAILURE RESTORATION

9.1. When the Power Fails during Recording .....	28
--	----

### 10. RECORDING

10.1. Type of Recording .....	29
10.1.1. Recording Priorities .....	29
10.2. Screen Display During Recording .....	29
10.3. The Keys to Be Used in Recording .....	31
10.4. Performing General Recording .....	31
10.5. Performing Internal Timer Recording .....	31
10.6. Performing Alarm Recording .....	32

### 11. PLAYBACK

11.1. Type of Playback .....	33
11.2. Screen Display During Playback .....	33
11.3. The Keys to Be Used in Playback .....	34
11.4. Performing Playback .....	34
11.5. Performing Various Playback Functions	
11.5.1. Reverse Playback .....	34
11.5.2. Fast Forward Playback And Fast Reverse Playback .....	34
11.5.3. Playback Pause (Still Picture) .....	34
11.5.4. Forward Frame Playback And Reverse Frame Playback .....	35
11.5.5. Forward Block Playback And Reverse Block Playback .....	35
11.6. About the Playback Start Position .....	36

## FUNCTIONS

### 12. SEARCH FUNCTIONS

12.1. The Keys to Be Used in Searching .....	37
12.2. Date/Time and Block Searches .....	37
12.2.1. Basic Date/Time and Block Search Operations .....	37
12.2.2. Date/Time Search Operation .....	37
12.2.3. Block Search Operation .....	38
12.3. Time Shift Search .....	39

## CONNECTIONS

### 13. CONNECTIONS

13.1. Preparations for Connections .....	40
13.1.1. Control Input/Output Terminal Connections .....	40
13.2. When Using the 24 V AC or 12 V DC or AC Mains Camera .....	40
13.3. Connection to The Monitor TV .....	40
13.4. Combination With The Digital Video Recorder/Multi-switchers (C-MS91D, C-MS161D) .....	41
13.4.1. Basic System .....	41
13.4.2. Expansion System (Series Recording) .....	41

## 14. CONNECTION EXAMPLES

14.1. Connection to the 24 V AC or 12 V DC or AC Mains Camera .....	42
14.2. Connection to the Multi-switcher	
14.2.1. Basic System	
(Combined Example with the C-MS91D, Multi-switcher) .....	43
14.2.2. Expansion System	
(Combined Example with the C-MS91D, Multi-switcher) .....	44

## ADDITIONAL INFORMATION

## 15. RECORDING TIME TABLE

15.1. Recording Picture Quality Setting .....	45
15.2. When using the C-DR0100 .....	45
15.3. When using the C-DR0101 .....	45
15.4. When using the C-DR0105 .....	46

## 16. EXTERNAL TERMINAL SPECIFICATIONS

16.1. RS-232C Communication Specifications .....	47
16.1.1. The Rules of Overall Communications .....	47
16.1.2. Communication Protocol .....	47
16.1.3. RS-232C Connector Pin Assignment .....	47
16.1.4. RS-232C Communication Format	
(Controller to Digital Video Recorder) .....	48
16.1.5. RS-232C Communication Command	
(Controller to Digital Video Recorder) .....	48
16.1.6. RS-232C Communication Format	
(Digital Video Recorder to Controller) .....	51
16.1.7. RS-232C Communication Command	
(Digital Video Recorder to Controller) .....	51
16.2. About the Ethernet Terminal .....	53

17. RACK MOUNTING .....	54
-------------------------	----

## WHEN YOU NEED HELP

18. IF YOU THINK THERE IS A FAILURE: (TROUBLESHOOTING) ....	55
---	----

19. SPECIFICATIONS .....	56
--------------------------	----

NTSC version complies with Part 15 of the FCC Rules.

### Note

This equipment has been tested and found to comply with the limits for a Class A digital device, pursuant to Part 15 of the FCC Rules. These limits are designed to provide reasonable protection against harmful interference when the equipment is operated in a commercial environment. This equipment generates, uses, and can radiate radio frequency energy and, if not installed and used in accordance with the instruction manual, may cause harmful interference to radio communications. Operation of this equipment in a residential area is likely to cause harmful interference in which case the user will be required to correct the interference at his own expense.

### Modifications

Any modifications made to this device that are not approved by TOA Corporation may void the authority granted to the user by the FCC to operate this equipment.

# 1. SAFETY PRECAUTIONS

- Be sure to read this safety instructions in this section carefully in prior to use.
- Make sure to observe the instructions in this manual as the conventions of safety symbols and messages regarded as very important precautions are included.
- Keep this instructions handy for future reference.

## Safety Symbol and Message Conventions

Safety messages described below are used to prevent bodily injury and property damage that could result from mishandling. Before operating your product, read this manual first and understand messages so you are thoroughly aware of the potential safety hazards.



### **WARNING**

Indicates a potentially hazardous situation which could result in death or serious personal injury if ignored or mishandled.

#### When installing the Recorder

- This is a class A product. In a domestic environment this product may cause radio interference in which case the user may be required to take adequate measures.
- Do not expose the unit to rain or an environment where it may be splashed by water or other liquids, as doing so may result in fire or electric shock.
- Use the unit only with the voltage specified on the unit. Using a voltage higher than specified one may result in fire or electric shock.
- Do not damage, modify nor put the power supply cord in close to heaters. Never place heavy objects on the power supply cord, as doing so may result in fire or electric shock.
- Do not install nor place the unit in unstable locations, such as on a rickety table or a slanted surface. Doing so may result in the unit falling down or dropping and causing personal injury.

#### When Using the Recorder

- Should the following irregularity be found during use, immediately switch off the main power, disconnect the power supply plug from the AC outlet and contact your nearest TOA dealer. Make no further attempt to operate the unit in this condition as this may cause fire or electric shock.
  - If you detect smoke or a strange smell coming from the unit
  - If water or any metallic object gets into the unit
  - If the unit falls or the unit case breaks
  - If the power supply cord is damaged (exposure of the core, disconnection, etc.)
  - When the Screen is not Displayed
- Do not open the unit case nor modify the unit. As doing so may result in fire or electric shock as there are high voltage components inside the unit. Refer any needed servicing to authorized TOA dealers.
- Do not put containers of liquid or metallic objects on top of the unit. If they accidentally spill into the unit, this may cause a fire or electric shock.
- Do not insert nor drop metallic objects or flammable materials from ventilation slots of the unit, as this may result in fire or electric shock.
- Do not touch power supply plug during thunder and lightning, as this may result in electric shock.



### **CAUTION**

Indicates a potentially hazardous situation which could result in moderate or minor personal injury, and/or property damage if ignored or mishandled.

#### When installing the Recorder

- Do not plug in nor remove the power supply plug with wet hands, as doing so may cause electric shock.
- When unplugging the power supply cord, be sure to grasp the power supply plug; never pull the cord itself, as doing so may result in damage the cord, causing fire or electric shock.
- Moving the unit with the power supply cord connected to the wall outlet may cause damage to the power supply cord, resulting in fire or electric shock.
- Do not block the ventilation slots as this may cause inside of the unit filled with heat, as doing so may result in fire.
- Do not install the unit in humid or dusty locations, in locations exposed to the direct sunlight, near the heaters, nor in locations generating soot or steam as doing so may result in fire or electric shock.

## **CAUTION**

Indicates a potentially hazardous situation which could result in moderate or minor personal injury, and/or property damage if ignored or mishandled.

### **When Using the Recorder**

- Do not place heavy objects on the unit. Such object may fall or the unit may tip over, possibly resulting in personal injury.
- Clean the unit periodically. Contact your TOA dealer regarding the cleaning. If dust is allowed to accumulate in the unit over a long period of time, a fire may result.
- Clean the power supply plug and wall AC outlet periodically. If dust accumulates on them, a fire may result. Insert the power supply plug into the AC outlet securely.
- Switch off the main power and unplug the power supply plug from the AC outlet for the safety purposes when cleaning or leaving the unit unused for long periods of time. Doing otherwise could cause fire or electric shock.

## **2. GENERAL DESCRIPTION**

The TOA C-DR0100 (C-DR0101, C-DR0105) is a single-channel Digital Video Recorder with 1 channel of video input, and permits connected camera images to be recorded onto its large-capacity internal hard disks using a digital compression system. It can simultaneously play back recorded camera images while continuing to record images onto the hard disk. The Digital Video Recorder can also be easily connected to an existing switcher system, replacing previously installed analog time-lapse VCRs. Mounting in EIA-Standard equipment racks can also be easily performed with the addition of optional rack mounting brackets.

## **3. FEATURES**

### **High Picture Quality**

Digital compression system ensures high-quality picture, audio recording, and playback.

### **Extended-Time Recording**

Built-in 120 GB (C-DR0100), 240 GB (C-DR0101) and 500 GB (C-DR0105) large-capacity hard disks permit extended-time recording.

### **Can Be Used In Conjunction With Switchers**

Can be connected to TOA's switcher system and used in place of analog time-lapse VCRs. In systems that use a Multi-switcher (C-MS91D and C-MS161D), the Series Recording function that permits continuous recording with the connection of two Digital Video Recorders can be enabled, and the switcher's motion detection function can be used as an alarm input to provide efficient surveillance by means of Alarm Recording.

### **Simultaneous Recording/Playback**

Recorded images can be played back without interrupting recording.

### **Pre-Alarm Recording**

Pre-Alarm function performs retroactive recording to a maximum of 5 minutes before alarm activation.

### **Search Function**

Three search functions Date/Time Search, Block Search, and Time Shift Search permit desired scenes to be quickly found and viewed.

### **Mirroring Recording (C-DR0101, C-DR0105)**

The C-DR0101 and C-DR0105 has two built-in hard disk drives. Mirroring refers to the simultaneous recording of data onto the two hard disks. Even if one of the disks fails, recording and playback can still be performed using the other disk. The possibility of data loss due to hard disk failure is greatly reduced, increasing reliability.

### **Networking Function**

An RS-232C interface and a 100BASE-TX Ethernet port are standard.

**Note:** The RS-232C control software is not standard.

## 4. HANDLING PRECAUTIONS

- Use the Digital Video Recorder in locations with ambient temperature of between +5°C and +40°C, and humidity levels of less than 80% to ensure that no condensation is formed.
- When moving the Recorder, first switch off the main power and then wait at least 30 seconds before moving.
- Avoid moving the Recorder suddenly from a cold location to a warm location, or installing it in close proximity to an air-conditioner outlet, as internal condensation could result. When condensation occurs, do not switch on the power until the Recorder has sufficiently dried.
- Avoid installing the Recorder in humid or dusty locations, or in locations exposed to direct sunlight, sooty smoke or steam. Note that even in locations which are not particularly dusty, dust may accumulate at the Recorder's ventilation slots. Because this could cause an extreme rise in temperature inside the Recorder, be sure to clean the ventilation slots periodically after switching off the main power and disconnecting the power supply cord from the AC outlet. It is highly recommended that the ventilation slots be cleaned once a year.
- The socket-outlet shall be installed near the equipment and the plug (disconnecting device) shall be easily accessible.
- To clean, be sure to first switch off the main power and then wipe with a dry cloth. If the Recorder is particularly dirty, use a cloth dampened in a neutral detergent. Never use benzene, thinner or chemically-impregnated towels, which may damage the Recorder's surface.
- Do not block the ventilation slots or cooling fan, which could cause the temperature inside the Recorder to rise, possibly resulting in unit failure. Install the Recorder at least 100 mm away from the nearest wall surface.
- Since the Recorder is equipped with a cooling fan, a motor sound is generated.
- Do not install the Recorder in locations influenced by strong electrical or magnetic fields, as monitor screen pictures may become distorted or the Recorder could fail.
- Avoid jarring or striking the Recorder. The Recorder is a piece of precision equipment and accidentally dropping it or subjecting it to strong impacts could cause its failure. When transporting the Recorder, carefully pack it in the supplied carton to protect it from shock.
- Do not use the Recorder in locations exposed to vibration to avoid failure. Avoid installing the Recorder vertically or tilting it at extreme angles, since it is designed to be used in a horizontal position only.
- About the hard disks  
Hard disks other than those specified by TOA cannot be used. Since the hard disks are pieces of precision equipment, take special care in handling not to accidentally drop, bump or jar them, lest they should fail. If a hard disk on which condensation is formed is used, it could fail. Therefore, when brought into a warm room from the cold outdoors, be sure to leave it unused for at least half a day before using it. If the hard disk fails, recorded data cannot be restored.
- TOA takes no responsibility for any incidental damage, such as loss of sales opportunities, that may result from the Digital Video Recorder's failure.
- The standby function is used to enable transportation of the unit from one place to another when circumstances do not permit its main power supply to be turned off. While in standby mode, power continues to be supplied to the unit, but its hard disk and fan are stopped. If the unit is left in standby mode for long periods of time, heat can build-up inside the unit, potentially shortening its operating life. To avoid this, be sure to turn off the main power supply when the unit is not in use.

Underwriters Laboratories Inc. (UL) has not tested the performance or reliability of the security aspects of this product. UL has only tested for fire, shock or casualties as outlined in UL's Standard(s) for Safety. UL Certification does not cover the performance or reliability of the security hardware and security operating software. **UL MAKES NO REPRESENTATIONS, WARRANTIES OR CERTIFICATIONS WHATSOEVER REGARDING THE PERFORMANCE OR RELIABILITY OF ANY SECURITY RELATED FUNCTIONS OF THIS PRODUCT.**

## 5. NOMENCLATURE AND FUNCTIONS

### [Front Panel]

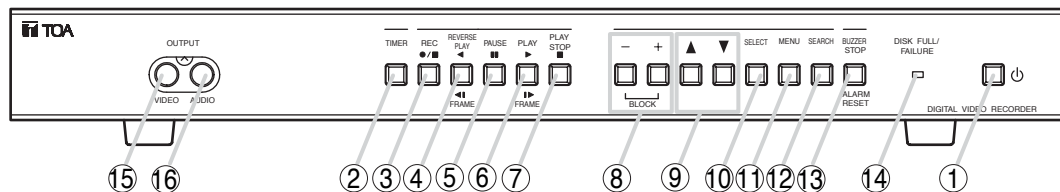

#### ① Standby Key [⏻] Key

Pressing this switch while the main power is supplied initiates a system check (the switch flashes green) and activates the Digital Video Recorder (the switch lights green). Holding down this switch for 1 second or more places the Recorder in standby mode, indicated by the switch flashing every 5 seconds.

##### Note

Some time is required before the Recorder is placed in standby mode after the main power has been switched on. Ensure that the Recorder is in standby mode before operating the standby key.

#### ② Timer Key

This key lights green when pressed, indicating that the Recorder is in Internal Timer Recording standby mode, which permits Internal Timer Recording to be performed at preset times. To cancel Internal Timer Recording, hold down the Timer key for at least 1 second until its light extinguishes.

#### ③ Recording [●/■] Key

This key lights red when pressed, indicating that camera recording is in progress. To stop the recording, hold down the Recording key for at least 1 second until its light extinguishes.

#### ④ Reverse Playback [◀] Key

Plays back recorded images in the reverse direction. This key continuously lights green during reverse playback. The playback speed cycles through x1, x2, x4, and x8 with each depression of this key.

##### Frame Reverse [◀|] Key

Pressing this key while the Recorder is in Playback Pause mode initiates a frame-by-frame reverse playback of the recorded image. Holding down this key performs a continuous frame-by-frame playback in the reverse direction.

#### ⑤ Pause [||] Key

Temporary stops playback. This key continuously lights green while in Playback Pause mode. If pressed again, images are played back in the same direction as before. (Playback speed reverts to normal x1 speed.) When the Pause key flashes green, this indicates that the Recorder is in Time Shift Search mode.

#### ⑥ Playback [▶] Key

Plays back recorded images in the forward direction, and continuously lights green during playback. The playback speed cycles through x1, x2, x4, and x8 with each depression of the Playback key.

##### Frame Advance [▶|] Key

Pressing this key while the Recorder is in Playback Pause mode initiates a frame-by-frame playback of the recorded image. Holding down this key performs a continuous frame-by-frame playback in the forward direction.

#### ⑦ Playback Stop [■] Key

Stops playback operation.

##### Note

Current recording in progress does not stop even if this key is pressed.

#### ⑧ [+ ] and [ - ] Set Keys

Used to change setting values on the menu or search screen.

##### Block Shift Key

Pressing the (+) key during playback shifts the recorded image block to the next block in the forward direction, while the (-) key shifts to the preceding block.

#### ⑨ Up [▲] and Down [▼] Shift Keys

Used to move the cursor on the menu or search screen.

#### ⑩ Select Key

Selects items or choices on the menu or search screen.

#### ⑪ Menu Key

Hold down this key for 1 second or more to display the main menu screen on the monitor. Pressing this key during playback stops playback operation to display the main menu screen. The main menu screen can also be displayed even while recording is in progress, however some items cannot be set during recording. If this key is pressed during item selection, the displayed setting contents are set and confirmed, returning the display to the previous screen.



⑫ **Search Key**

Displays the search screen on the monitor. Pressing this key during playback stops playback operation to display the search screen. If pressed while in Playback Pause mode, the Time Shift Search screen is displayed. To exit the search screen, press this key again.

⑬ **Buzzer Stop Key**

This key flashes red when an alarm is activated, and the Recorder's built-in buzzer is sounded to provide both visual and audio alarm warnings. After Alarm Recording completion, the key changes to steady ON (red). Press this key to stop the buzzer. The buzzer can be disabled by selecting "OFF" for Buzzer in the Alarm Recording Settings. (Refer to p. 19.)

**Alarm Reset Key**

Hold down this key for 1 second or more to reset alarm operation and stop Alarm Recording.

⑭ **Disk Full/Failure Indicator**

**Disk Full Indicator**

When the Recording mode is set to "STOP" or "SERIES" in the Disk Setting, the indicator flashes whenever less than 1 hour of available hard disk time remains, and changes to steady ON if no available time remains.

**Failure Indicator**

This indicator lights red when the Recorder fails, and extinguishes when the cause of the failure is removed. This failure indication takes precedence over the Disk Full indication, should both be enabled at the same time. Possible Failure Causes: Hard disk failure, fan failure, and video loss.

**Note**

If the Recorder should indicate a failure, first check for the cause by switching the power OFF, then contact your TOA dealer if unable to solve the problem.

⑮ **Video Output Terminal**

Used for dubbing recorded video images. This terminal is the same as the Video Output Terminal located on the rear panel.

⑯ **Audio Output Terminal**

Used for dubbing recorded audio signals. This terminal is the same as the Audio Output Terminal located on the rear panel.

## [Rear Panel]

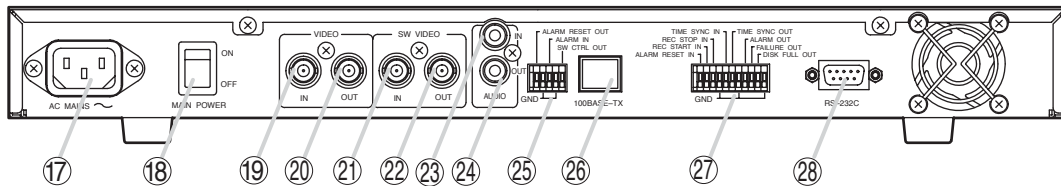

### 17 AC Inlet

Connect the supplied power cord to this socket.

### 18 Main Power Switch

Power switch for the Digital Video Recorder.

### 19 Video Input Terminal

Receives video signals. Connect the Multi-switcher's VCR output to this terminal when connecting the Multi-switcher.

### 20 Video Output Terminal

Sends out video signals. Connect this terminal to the Multi-switcher's VCR input when connecting the Multi-switcher. If the Multi-switcher is not used, connect this terminal to the monitor to transmit video signals to the monitor.

### 21 Switcher Video Input Terminal

Connect the Multi-Switcher's monitor output to this terminal. This terminal is not used if the Multi-switcher is not connected.

### 22 Switcher Video Output Terminal

In the system in which the Multi-switcher is connected, connect this terminal to the monitor to transmit video signals to the monitor. Do not use this terminal if the Multi-switcher is not connected.

### 23 Audio Input Terminal

Receives audio signals from the drive unit, etc.

### 24 Audio Output Terminal

Sends out audio signals to the monitor, etc.

### 25 Control Input/Output Terminal

#### Alarm Reset Output Terminal

Shorts to the ground terminal when the Recorder's alarm is reset.

#### Alarm Input Terminal

Activates an alarm by way of external sensors. Alarm Input mode can be changed by the Recording Setting's Alarm Recording Setting.

#### Ground Terminal

#### Switcher Control Output Terminal

Connect this terminal to the Multi-switcher's switcher control input terminal.

### 26 100BASE-TX Terminal

RJ-45 terminal for Ethernet.

### 27 Control Input/Output Terminal

#### Alarm Reset Input Terminal

Used to permit external equipment to reset the Recorder's alarm operation. This terminal provides the same operation as the front panel-mounted Alarm Reset key.

#### Recording Start Input Terminal

Used to permit external equipment to initiate recording. When the Disk Setting's Disk Mode is set to "SERIES," even if the Recorder's disk is full, the Disk Full status is reset and recording is started.

#### Recording Stop Input Terminal

Used to stop recording at external equipment. This terminal provides the same operation as the front panel-mounted Recording key.

#### Time Sync Input/Output Terminals

Synchronize multiple Digital Video Recorders with that of a specified recorder (master unit) when two or more recorders are used. Connect the master unit's output to the slave unit's input.

#### Alarm Output Terminal

Shorts to the ground terminal when an alarm is activated.

#### System Failure Output Terminal

Shorts to the ground terminal when the hard disk or fan failure or Video Loss occurs.

#### Disk Full Output Terminal

Shorts to the ground terminal when no available hard disk time remains.

### 28 RS-232C Terminal

Connect this terminal to a computer's RS-232C terminal when controlling the Recorder at the computer. Connect this terminal to the Multi-switcher's RS-232C terminal to synchronize the Recorder with the Multi-switcher. (This terminal can be connected to any of the C-MS91D, C-MS161D Multi-switchers.)

\*Ratings and serial numbers are indicated on the bottom surface.

## 6. SETTING ITEM CHART AND SETTING PROCEDURES

### 6.1. Basic Setting Procedures

- The shaded  item in the figure refers to the cursor position.

1. Enter the main menu screen.

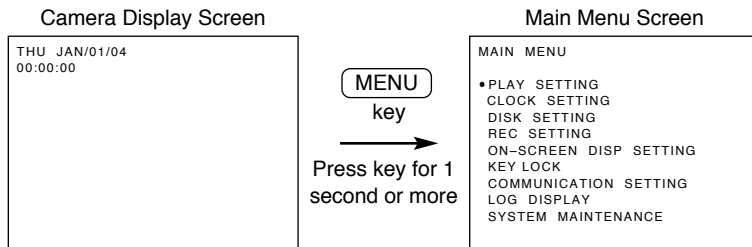

2. Enter the setting screen.

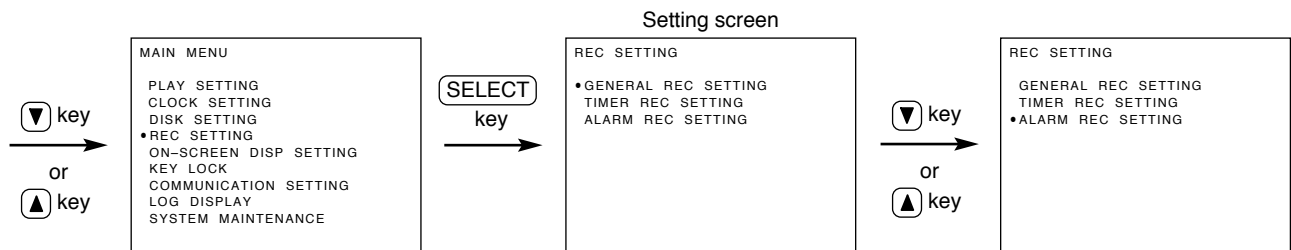

3. Select the setting value.

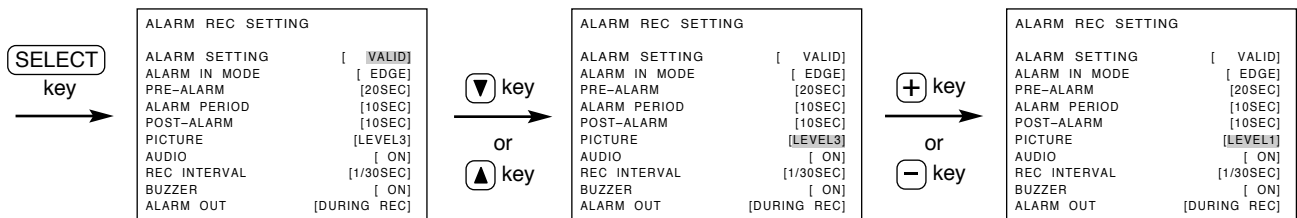

4. Confirm the selected setting value and return to the camera display screen.

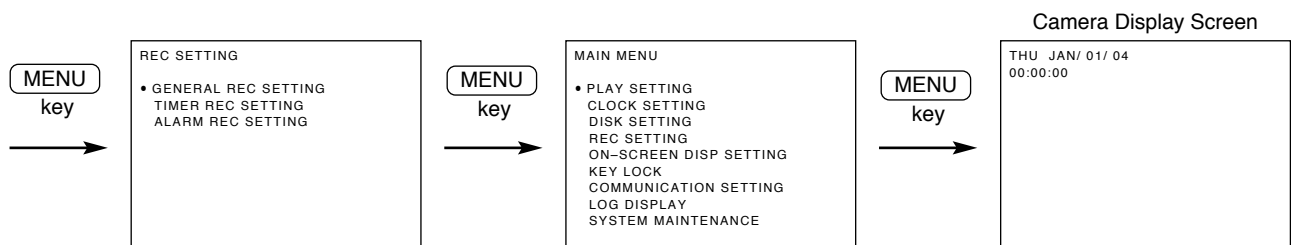

## 6.2. Setting Item Chart

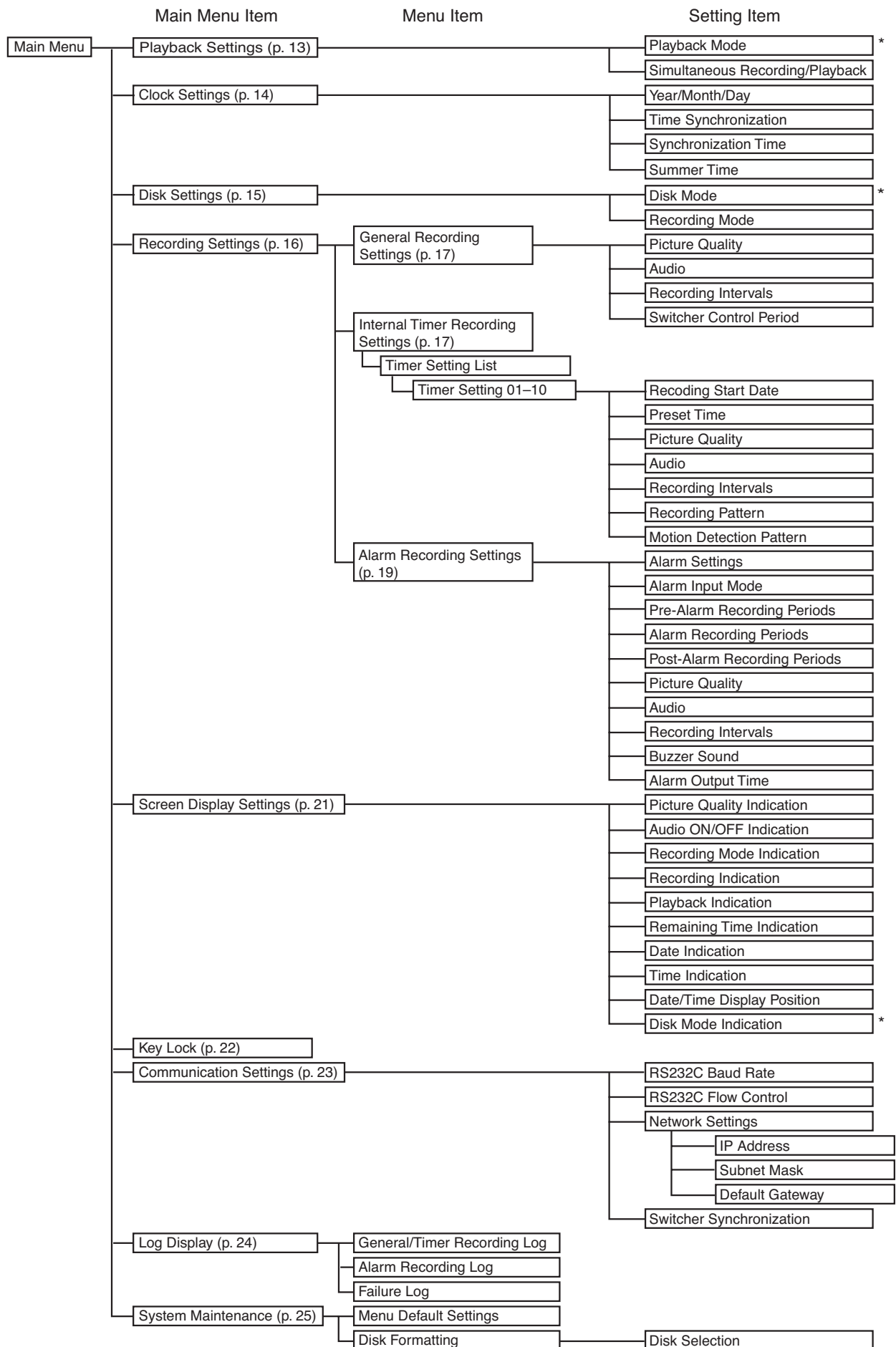

\* This setting item is applicable to the C-DR0101 and C-DR0105 Recorder, and not displayed on the screen when the C-DR0100 Recorder is used.

## 7. INDIVIDUAL ITEM SETTINGS

### 7.1. Main Menu Screen

Hold down the Menu key for 1 second or more on the screen displaying the camera to display the Main Menu screen.

- Select the desired item from 9 main menu items on the main menu screen.
- Move the cursor with the (▲) or (▼) key, and display each setting screen with the Select key.

MAIN MENU	
• PLAY SETTING	Refer to P.13
CLOCK SETTING	Refer to P.14
DISK SETTING	Refer to P.15
REC SETTING	Refer to P.16
ON-SCREEN DISP SETTING	Refer to P.21
KEY LOCK	Refer to P.22
COMMUNICATION SETTING	Refer to P.23
LOG DISPLAY	Refer to P.24
SYSTEM MAINTENANCE	Refer to P.25

#### Note

Be sure to first perform Clock Settings (Refer to p. 14) before performing each setting.

### 7.2. Playback Settings

Playback mode settings are only available to the C-DR0101 and C-DR0105, and not displayed when the C-DR0100 is used.

PLAY MODE : Sets the hard disk to be used for playback and search functions.

SIMUL REC/PLAY : Selects "ALLOW" or "DISALLOW" for simultaneous recording and playback operations.

- Move the cursor with the (▲) or (▼) key, and change setting values with the (–) or (+) key.
- Confirm the setting with the Menu key, and return to the previous screen.
- Each setting item and its setting value and contents are as shown in the table below.

PLAY SETTING	
PLAY MODE	[ <u>ALL</u> ]
SIMUL REC/PLAY	[ <u>ALLOW</u> ]

Setting Item	Setting Value	Contents
PLAY MODE (Playback Mode) (C-DR0101, DR0105)	<u>ALL</u> / HDD-A / HDD-B	ALL : All set hard disks are used for playback. HDD-A : Hard disk drive A is used for playback. HDD-B : Hard disk drive B is used for playback.
SIMUL REC/PLAY (Playback during Recording)	<u>ALLOW</u> / DISALLOW	ALLOW : Allows playback while recording. DISALLOW : Disallows playback while recording.

\* The underlined contents are factory-preset values.

### 7.3. Clock Settings

Set the date and time. Perform this setting when the Recorder is used for the first time or when the date and time indication has been deleted because the power was switched off for a long period of time.

**Note**

- Previously logged data times are not updated even if the Clock Settings are changed during use.
- The data times will be lost if the power was switched off for 30 days or more. Set the date and time again. Memory backup: 720 hours (fully charged)

TIME SYNC : Synchronizes the times of other Recorders (slave units) with that of a specified Recorder (master unit) when multiple Recorders are used.

SYNC TIME : Sets the synchronization time.

**Note**

The Time Sync function cannot be operated during recording.

- Move the cursor with the (▲) or (▼) key, and change setting values with the (–) or (+) key.
- After completing the settings of time (hour, minute, second), confirm the time with the Select key.
- The indication "Clock Setting Completed" is displayed on the screen after setting completion.
- Current time is displayed in the lowest part of the screen.
- Confirm the setting with the Menu key, and return to the previous screen.
- Each setting item and its setting value and contents are as shown in the table below.

```

CLOCK SETTING
THU JAN / 01 / 04      00:00:00
TIME SETTING : SELECT KEY

TIME SYNC              [ SLAVE]
SYNC TIME              [00H]
SUMMER TIME SETTING

<CURRENT TIME>
THU JAN / 01 / 04      00:00:00
    
```

Setting Item	Setting Value	Contents
TIME SYNC (Time Synchronization)	MASTER / <u>SLAVE</u>	MASTER: Designates the master unit. SLAVE: Designates the slave unit.
SYNC TIME (Synch-ronization Time)	<u>00H</u> / 01H / 02H / 03H / 04H / ... up to 23H	Select and set the synchronization time.

\* The underlined contents are factory-preset values.

**Note**

Setting the Time Sync settings to "SLAVE," and the Disk Setting's Disk Mode to "SERIES" places the Recorder in Disk Full mode, causing the Disk Full indicator to light. Perform this setting when using Series Recording. Refer to p. 41; Expansion System (Series Recording).

### 7.3.1. Summer Time (Daylight Saving Time) Setting

Summer Time Setting screen is displayed if Summer Time Setting is selected on the Clock Setting screen.

- Move the cursor with the (▲) or (▼) key, and change setting values with the (–) or (+) key.
- Confirm the setting with the Menu key, and return to the previous screen.
- Each setting item and its setting value and contents are as shown in the table below.

Setting Item	Setting Value	Contents
SUMMER TIME SETTING	ON / <u>OFF</u>	ON : Displays the current date and time by automatically shifting the time from standard local time to summer time and from summer to standard time. OFF : Displays the current date and time having nothing to do with the summer time.
SUMMER TIME FIRST DAY	Month : JAN / FEB / MAR / <u>APR</u> / MAY / JUN / JUL / AUG / SEP / OCT / NOV / DEC Which Sunday : <u>FIRST</u> / SECOND / THIRD / FOURTH / LAST What time : 00H / 01H / <u>02H</u> / 03H / 04H / ... up to 23H	Sets the time to shift to the summer time. Select the "Month" and "Which Sunday" and "What time"
SUMMER TIME LAST DAY	Month : JAN / FEB / MAR / APR / MAY / JUN / JUL / AUG / SEP / <u>OCT</u> / NOV / DEC Which Sunday : FIRST / SECOND / THIRD / FOURTH / <u>LAST</u> What time : 00H / 01H / <u>02H</u> / 03H / 04H / ... up to 23H	Sets the time to shift back to the standard local time. Select the "Month" and "Which Sunday" and "What time"

\*The underlined contents are factory-preset values.

#### Example

- (1) If the FIRST DAY time is set to "02H", then at 2:00 AM on the first day of summer time the clock will be advanced one hour to 3:00 AM.
- (2) If the LAST DAY time is set to "02H", then at 2:00 AM on the first day of summer time the clock will be setback one hour to 1:00 AM.

### 7.4. Disk Settings

Disk Mode Settings are only available to the C-DR0101, and not displayed when the C-DR0100 is used.

DISK MODE : Sets the hard disk recording method.

REC MODE : Selects "RE-REC", "STOP," or "SERIES" for hard disks.

- Move the cursor with the (▲) or (▼) key, and change setting values with the (–) or (+) key.
- Confirm the setting with the Menu key, and return to the previous screen.
- Each setting item and its setting value and contents are as shown in the table below.

DISK SETTING	
DISK MODE	[ <u>NORMAL</u> ]
REC MODE	[ STOP ]
PLAY CHANGED TO " ALL "	

Setting Item	Setting Value	Contents
DISK MODE (C-DR0101, C-DR0105)	<u>NORMAL</u> / MIRRORING	NORMAL : Records continuously on each hard disk. MIRRORING: Recording is performed simultaneously on the 2 hard disks.

Setting Item	Setting Value	Contents
REC MODE (Recording Mode)	RE-REC / <u>STOP</u> / SERIES	<p>RE-REC: Automatically deletes old recordings in chronological order to overwrite the hard disk.</p> <p>STOP: Performs no further recording to save previously recorded data if no available hard disk time remains. The Disk Full indicator flashes red whenever less than 1 hour of available hard disk time remains, and changes to steady ON (Indicator lights red) if no available time remains. Selecting "RE-REC" in the menu resets the Disk Full mode and causes the Disk Full indicator to extinguish.</p> <p>SERIES: The Recorder stops and sends out a signal from its rear panel-mounted Disk Full Output terminal if no available hard disk time remains. If the Recorder receives a signal at its Recording Start input terminal when it is in Disk Full mode, the Disk Full mode is reset, causing the Disk Full indicator to extinguish.</p>

\* The underlined contents are factory-preset values.

### Note

- Avoid mixing both Normal Recordings and Mirroring Recordings on the hard disk. If mixed, block advance during playback or search operations cannot be correctly performed during playback. Be sure to re-format the disk when changing the Disk Mode Setting. Note that all recording data are deleted when formatted. (Refer to p. 26; "Disk Formatting.")
- Setting the Clock Setting's Time Sync to "SLAVE" and the Recording Mode to "SERIES" places the Recorder in Disk Full mode and causes the Disk Full indicator to light. Perform this setting when using the Series Recording function. (Refer to p. 41; "Expansion System (Series Recording).")
- When the Recording mode is set to "SERIES," timer program cannot be performed.
- If the Disk Mode is changed, the Playback Mode changes as follows and the screen indicates that the Playback Mode has changed. (C-DR0101, C-DR0105)

DISK MODE	PLAY MODE
NORMAL	ALL
MIRRORING	HDD-A

The disk to be used is set to HDD-B if "HDD-B" is selected in the Playback Mode settings. To set to the "HDD-A" disk again, set the Disk mode to "MIRRORING."

- About Mirroring Recording. (C-DR0101, C-DR0105)

Setting the Disk Mode to "MIRRORING" permits the same recording to be performed simultaneously on the two built-in hard disks. Should one of the two disks fail, the other disk will continue recording or playing back to ensure automatic backup. Be sure to first format both disks before performing Mirroring Recording to make their available recording times equal.

When a difference in available recording time between the two disk drives exists, recording can continue if one of the two disks becomes full, provided recording time remains available on the other disk. However, this will no longer be Mirroring Recording. The maximum available Mirroring Recording time can be checked by setting the remaining time display to "MIN."

## 7.5. Recording Settings

Set individual recording conditions for General Recording, Internal Timer Recording, and Alarm Recording.

- Move the cursor with the (▲) or (▼) key, and display the selected setting screen with the Select key.
- Confirm the selected setting with the Menu key, and return to the previous screen.

```

REC SETTING
• GENERAL REC SETTING
  TIMER REC SETTING
  ALARM REC SETTING

```



### 7.5.1. General Recording Settings

Set the recording conditions for General Recording.

- Move the cursor with the (▲) or (▼) key, and change setting values with the (–) or (+) key.
- Confirm the setting with the Menu key, and return to the previous screen.
- Each setting item and its setting value and contents are as shown in the table below.

GENERAL REC SETTING	
PICTURE QUALITY	[LEVEL3]
AUDIO	[ ON]
REC INTERVAL	[1/30SEC]
SW CTRL PERIOD	[01]

Setting Item	Setting Value	Contents
PICTURE QUALITY	LEVEL1 / LEVEL2 / <u>LEVEL3</u> / LEVEL4 / LEVEL5	LEVEL1 : Angle of view 720 x 240 file size : 64KB (High Picture Quality ) LEVEL2 : Angle of view 720 x 240 file size : 40KB LEVEL3 : Angle of view 720 x 240 file size : 32KB LEVEL4 : Angle of view 720 x 240 file size : 24KB LEVEL5 : Angle of view 720 x 240 file size : 16KB (Standard Picture Quality)
AUDIO	<u>ON</u> / OFF	ON: Records audio sound simultaneously during recording. OFF: Records no audio sound during recording.
REC INTERVAL (Recording Intervals)	1/60SEC / <u>1/30SEC</u> / 1/15SEC / 1/10SEC / 1/5SEC / 1/3SEC / 1/2SEC / 1SEC / 2SEC / 3SEC / 5SEC / 10SEC / 20SEC / 30SEC / 60SEC	Sets recording intervals. Setting the Disk Setting's Disk Mode to "MIRRORING" limits the maximum recording interval to 1/30 second. Even if set to "1/60 SEC," the actual recording interval is 1/30 second, and the "1/30 SEC" indication is displayed on the screen. (C-DR0101, C-DR0105)
SW CTRL PERIOD (Used for switching cameras by means of the sequential switcher, etc.)	<u>01</u> / 02 / 03 / 04 / 05 / 10 / 15 / 20 / 30 / 60	Set the camera switching signal period. The camera switching signal is provided from the Switcher Control Output at time intervals of recording interval x switching period to switch cameras. This setting is common to all Recording Modes of General Recording, Internal Timer Recording, and Alarm Recording.

\* The underlined contents are factory-preset values.

### 7.5.2. Internal Timer Recording Settings

If Internal Timer Recording Settings is selected, the Timer Setting List screen is displayed.

Up to 10 timer programs can be set individually.

Move the cursor to the desired program and press the Select key. The Timer Schedule screen is then displayed.

- Move the cursor with the (▲) or (▼) key, and press the Select Key. The Timer Schedule Screen is displayed.
- Confirm the setting with the Menu key, and return to the previous screen.

TIMER SETTING LIST	
	START - END
● JAN / 01 / 04	00 : 00 ~ 10 : 00
SM - W - F - 12	34 ~ 23 : 45
---	/ --- / --- : --- ~ --- : ---
---	/ --- / --- : --- ~ --- : ---
---	/ --- / --- : --- ~ --- : ---
---	/ --- / --- : --- ~ --- : ---
---	/ --- / --- : --- ~ --- : ---
---	/ --- / --- : --- ~ --- : ---
---	/ --- / --- : --- ~ --- : ---
---	/ --- / --- : --- ~ --- : ---

## Timer Schedule Screen Settings

Program No

- Move the cursor with the (▲) or (▼) key, and change setting values with the (–) or (+) key.
- Confirm the setting with the Menu key, and return to the previous screen.
- Each setting item and its setting value and contents are as shown in the table below.

TIMER SETTING 01	
DATE	[DAILY] THU JAN / 01 / 04
TIME	00 : 00 – 10 : 00
PICTURE QUALITY	[LEVEL3]
AUDIO	[ON]
REC INTERVAL	[1/30SEC]
REC PATTERN	[1]
MOTION DETECT PTN	[1]

Setting Item	Setting Value	Contents
DATE (Recording Start Date)	<u>DAILY</u> / WEEKLY / CANCEL	DAILY : Designates the Internal Timer Recording date. Timer schedules can be set for any time between the current time to one year ahead. The day of the week is automatically displayed. Programs are automatically deleted after their preset times are reached. WEEKLY: Designates two or more days of the week. If all days from Sunday to Saturday are designated, recording is performed every day. CANCEL : Cancels preprogrammed settings.
TIME (Preset Times)		Designates the timer operating period in minutes. If the same timer preset time is duplicated, the "TIME SETTING ERROR" indication is displayed on the screen to the right side of the program number, invalidating the date setting. In such cases, correctly reset the time. Note that the timer operating period cannot be set unless the complete time (hour and minute) is entered.
PICTURE QUALITY	LEVEL1 / LEVEL2 / <u>LEVEL3</u> / LEVEL4 / LEVEL5	LEVEL1 : Angle of view 720 x 240 file size : 64KB (High Picture Quality) LEVEL2 : Angle of view 720 x 240 file size : 40KB LEVEL3 : Angle of view 720 x 240 file size : 32KB LEVEL4 : Angle of view 720 x 240 file size : 24KB LEVEL5 : Angle of view 720 x 240 file size : 16KB (Standard Picture Quality)
AUDIO	<u>ON</u> / OFF	ON: Records audio sound simultaneously during recording. OFF: Records no audio sound during recording.
REC INTERVAL (Recording Intervals)	1/60SEC / <u>1/30SEC</u> / 1/15SEC / 1/10SEC / 1/5SEC / 1/3SEC / 1/2SEC / 1SEC / 2SEC / 3SEC / 5SEC / 10SEC / 20SEC / 30SEC / 60SEC	Designates the Recording intervals. Setting the Disk Setting's Disk Mode to "MIRRORING" limits the maximum recording interval to 1/30 second. Even if set to "1/60 SEC," the actual recording interval is 1/30 second, and the "1/30 SEC" indication is displayed on the screen (C-DR0101, C-DR0105)
REC PATTERN (Recording Pattern)	<u>1</u> / 2	Transmits a Pattern Selection command from the RS-232C connector when the preset timer operating time is reached.
MOTION DETECT PTN (Motion Detection Pattern)	<u>1</u> / 2	Transmits a Pattern Selection command from the RS-232C connector when the preset timer operating time is reached.

\* The underlined contents are factory-preset values.

### Note

Pattern 1 command of both the Recording Pattern and Motion Detection Pattern is transmitted from the RS-232C connector at times other than timer set times such as power-on, after Internal Timer Recording completion, and during General Recording.

Recording Pattern and Motion Detection Pattern are functions available to the Multi-switcher (C-MS91D, C-MS161D). For more information on these functions, refer to the instruction manual for the Multi-switcher.

### 7.5.3. Alarm Recording Settings

Alarm Recording has two Alarm Input modes "EDGE" and "LEVEL" and valid setting items differ depending on each mode.

Alarm Mode set to "EDGE" : Alarm recording time settings are valid.  
Post-alarm time settings are invalid.

Alarm Mode set to "LEVEL" : Alarm recording time settings are invalid.  
Post-alarm time settings are valid.

(For more information, Refer to p. 20; "About the Alarm Input Mode.")

- Move the cursor with the ( ▲ ) or ( ▼ ) key, and change setting values with the ( - ) or ( + ) key.
- Confirm the setting with the Menu key, and return to the previous screen.
- Each setting item and its setting value and contents are as shown in the table below.

ALARM REC SETTING	
ALARM SETTING	[ <u>VALID</u> ]
ALARM IN MODE	[ LEVEL ]
PRE-ALARM	[ 00SEC ]
ALARM PERIOD	[ 1MIN ]
POST-ALARM	[ 00SEC ]
PICTURE QUALITY	[ LEVEL3 ]
AUDIO	[ ON ]
REC INTERVAL	[ 1/30SEC ]
BUZZER	[ ON ]
ALARM OUT	[ DURING REC ]

Setting Item	Setting Value	Contents
ALARM SETTING	<u>VALID</u> / VAL REC / INVALID	VALID : Validates alarm settings. (Alarm standby mode) VAL REC : Validates alarm settings only during recording. INVALID : Invalidates alarm settings. (Rejects alarm inputs.)
ALARM IN MODE (Alarm Input Mode)	EDGE / <u>LEVEL</u>	EDGE : Performs recording during preset Pre-alarm and Alarm Recording periods LEVEL : Performs recording during preset Pre-alarm Recording, Alarm input, and Post-alarm Recording periods.
PRE-ALARM	<u>00SEC</u> / 10SEC/ 15SEC/ 20SEC / 30SEC/ 1MIN/ 2MIN/ 5MIN	Performs retroactive recording to a preset time period before alarm activation.
ALARM PERIOD	10SEC/ 15SEC/ 20SEC/ 30SEC/ <u>1MIN</u> / 2MIN/ 3MIN/ 4MIN/ 5MIN/ 10MIN	Performs recording during a preset alarm input period following alarm activation when the Alarm Input Mode is set to EDGE. (Refer to p. 20; "About the Alarm Input Mode")
POST-ALARM	<u>00SEC</u> / 10SEC/ 15SEC/ 20SEC/ 30SEC/ 1MIN/ 2MIN/ 5MIN	Performs recording during a preset Post-alarm recording period following the end of alarm activation when the alarm input mode is set to "LEVEL."
PICTURE QUALITY	LEVEL1 / LEVEL2 / <u>LEVEL3</u> / LEVEL4 / LEVEL5	LEVEL1 : Angle of view 720 x 240; file size : 64KB (High Picture Quality) LEVEL2 : Angle of view 720 x 240; file size : 40KB LEVEL3 : Angle of view 720 x 240; file size : 32KB LEVEL4 : Angle of view 720 x 240; file size : 24KB LEVEL5 : Angle of view 720 x 240; file size : 16KB (Standard Picture Quality)
AUDIO	<u>ON</u> / OFF	ON: Records audio sound simultaneously during recording. OFF: Records no audio sound during recording.
REC INTERVAL (Recording Interval)	1/60SEC / <u>1/30SEC</u> / 1/15SEC / 1/10SEC / 1/5SEC / 1/3SEC / 1/2SEC / 1SEC /	Sets the Recording intervals. Setting the Disk Mode of Disk Settings to "MIRRORING" limits the maximum recording interval to 1/30 second. Even if set to "1/60 SEC", the actual recording interval is 1/30 second, and the "1/30 SEC" indication is displayed on the screen (C-DR0101, C-DR0105)
BUZZER	<u>ON</u> / OFF	ON: Sounds a buzzer when an alarm is activated. Pressing the Buzzer Reset key stops buzzer operation. OFF: Sounds no buzzer during alarm activation.
ALARM OUT (Alarm Output Periods )	<u>DURING REC</u> / 1SEC	The Alarm Output terminal shorts to ground during a set period of time following alarm activation.

\* The underlined contents are factory-preset values.

### 7.5.4. About the Alarm Input Mode

The Alarm Input mode for Alarm Recording can be set to "EDGE" or "LEVEL."  
Each input mode operates as follows:

#### [Recording period when input mode is set to "EDGE"]

Performs continuous recording during Pre-alarm Recording and Alarm Recording Periods.

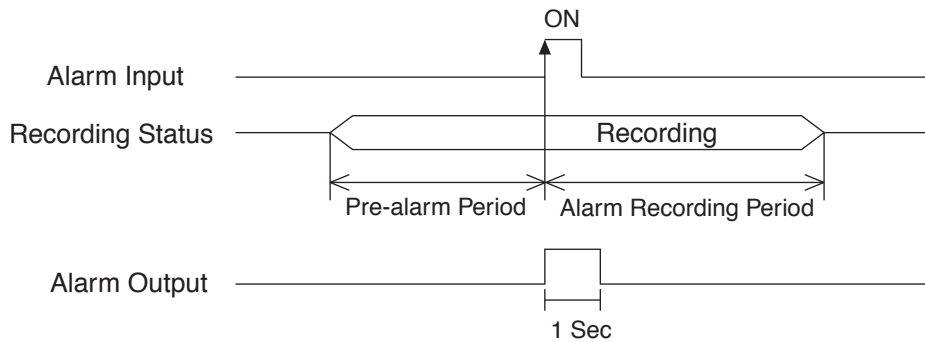

When an alarm output duration is set to 1 second:

#### [Recording period when input mode is set to "LEVEL"]

Provides continuous recording during periods of time of Pre-alarm Recording, alarm activation, and Post-alarm Recording.

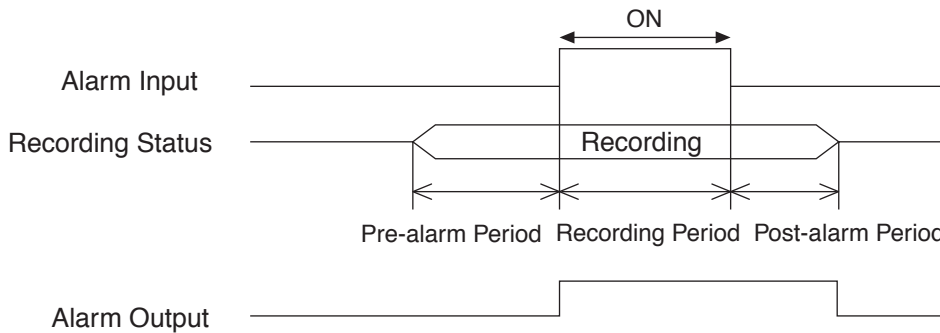

When an alarm output is provided during alarm recording:

#### Note

Pre-alarm recording is operated by the Alarm Recording Setting. It does not operate even if an alarm is activated during General Recording or Internal Timer Recording since they are operated by their own settings.

## 7.6. Screen Display Settings

The Disk Mode Display item is displayed when the C-DR0101 and C-DR0105 is used. Set whether to display or hide on-screen characters during playback or recording.

- Move the cursor with the (▲) or (▼) key, and change setting values with the (–) or (+) key.
- Confirm the setting with the Menu key, and return to the previous screen.
- Each setting item and its setting value and contents are as shown in the table below.

ON-SCREEN DISP SETTING	
PICTURE QUALITY	[DISP]
AUDIO	[DISP]
REC MODE	[DISP]
RECORDING	[DISP]
PLAYING	[DISP]
REMAINING TIME	[ DISP]
DATE	[DISP]
TIME	[DISP]
TIME DISP POS	[UPPER L]
DISK MODE	[DISP]

Setting Item	Setting Value	Contents
PICTURE QUALITY	<u>DISP</u> / HIDE	Displays or hides the picture quality indicator during recording or playback.
AUDIO	<u>DISP</u> / HIDE	Displays or hides the audio indicator when Audio is set to ON during recording.
REC MODE (Recording Mode)	<u>DISP</u> / HIDE	Displays or hides the overwrite recording setting status indicator during recording.
RECORDING (Recording Display)	<u>DISP</u> / HIDE	Displays or hides the recording mode status indicator during recording.
PLAYING (Playing back Display)	<u>DISP</u> / HIDE	Displays or hides the playback speed, playback direction, and pause status during playback.
REMAINING TIME (Remaining Time Display)	Disk Mode set to "NORMAL": <u>DISP</u> / HIDE	Displays or hides Digital Video Recorder's remaining time. The remaining hard disk time is calculated from the currently recorded picture quality and recording interval when the Disk Settings Recording Mode is set to "STOP" or "SERIES."
	Disk Mode set to "MIRRORING": <u>MAX</u> / MIN / HDD-A / HDD-B / HIDE	Displays or hides Digital Video Recorder's remaining time. The remaining hard disk time designated is calculated from the currently recorded picture quality and recording interval when the Disk Settings Recording Mode is set to "STOP" or "SERIES." (C-DR0101, C-DR0105)
DATE (Date Display)	<u>DISP</u> / HIDE	Displays or hides the current date during recording, and the recorded date during playback.
TIME (Time Display)	<u>DISP</u> / HIDE	Displays or hides the current time during recording, and the recorded time during playback.
TIME DISP POS (Date/Time Display Position)	<u>UPPER L</u> / UPPER C / UPPER R / LOWER L / LOWER C / LOWER R	Sets the date/time display position. Other display positions also change depending on the date/time display position.
DISK MODE (Disk Mode Display)	<u>DISP</u> / HIDE	Displays or hides the disk connection status indicator. (C-DR0101, C-DR0105)

\* The underlined contents are factory-preset values.

## 7.7. Key Lock

This function validates key locking.

If validated, any key other than the Menu key is not accepted. Pressing keys other than the Menu key sounds a warning tone.

- The password input screen is displayed if Key Lock is selected on the main menu screen. Press the (←), (+), (▲), and (▼) keys (in that order) as a password. The "\*" indication is displayed on the screen to confirm each key entry as the keys are pressed.



### Note

The password and the key entry order cannot be changed.

- Entering the password correctly displays the following screen and validates key locking.

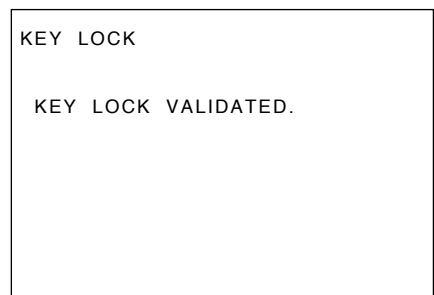

- The following screen is displayed if the wrong password is entered.

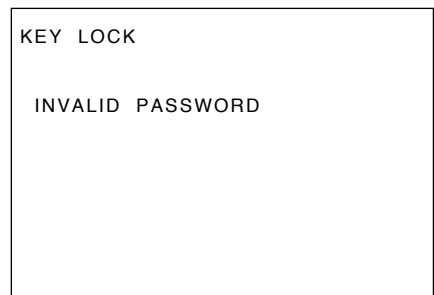

- Pressing the Menu key returns the display to the normal operation screen if the password is entered correctly. If the wrong password is entered, the display returns to the Main Menu screen. In such cases, perform the settings again.

### 7.7.1 Key Lock Release

- Hold down the Menu key for at least 1 second on the normal operation screen.
- The Key Lock Release screen is displayed.



- Entering the password correctly returns the display to the Main Menu screen.
- If the wrong password is entered, the "INVALID PASSWORD" indication is displayed as in the case of the Key Lock setting. Since the display returns to the normal screen if the Menu key is pressed, perform release operation.

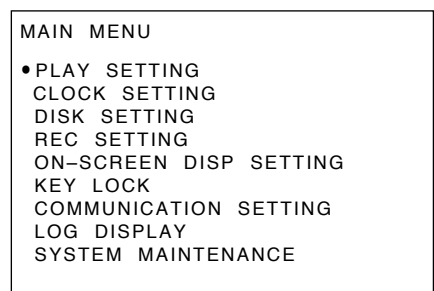

## 7.8. Communication Settings

Set the transmission rate and whether or not to use flow control in RS-232C communications. Also set the IP address, etc. to be used in the Ethernet network.

- Move the cursor with the (▲) or (▼) key, and change setting values with the (–) or (+) key.
- Confirm the setting with the Menu key, and return to the previous screen.

COMMUNICATION SETTING	
RS232C BAUD RATE	[38400]
RS232C FLOW CTRL	[OFF]
NETWORK SETTING	
SWITCHER SYNC	[ OFF]

Setting Item	Setting Value	Contents
RS232C BAUD RATE	9600 / 19200 / <u>38400</u> (bps)	Sets the transmission rate.
RS232C FLOW CTRL	ON / <u>OFF</u>	Sets Flow Control RTS or CTS
SWITCHER SYNC (Switcher Synchronization) *1	ON / <u>OFF</u> / TIME SYNC	ON : Controls the switcher through the RS-232C interface. OFF : Controls no switcher TIME SYNC : Only Time Synchronization can be controlled through the RS-232C interface.

\* The underlined contents are factory-preset values.

### Note

\*1 Recording Pattern, Motion Detection Pattern, Camera/ VCR mode selection, and Time Synchronization switcher functions can all be controlled by the Digital Video Recorder. However, when synchronizing the switcher's clock from the Recorder, set the Recorder's clock Time Synchronization setting to "MASTER." Time synchronization cannot be performed if set to "SLAVE."

### 7.8.1. Network Settings

The Network Setting screen is displayed if Network Settings is selected on the communication setting screen. Perform settings that are appropriate for the network.

- Move the cursor with the (▲) or (▼) key, and change setting values with the (–) or (+) key.

NETWORK SETTING
IP ADDRESS
192.168.000.001
SUBNET MASK
255.255.255.000
DEFAULT GATEWAY
000.000.000.000

- Pressing the Menu key after the setting displays the confirmation message in the lower part of the screen if the entered IP address is different from the current IP address.
- Holding down the Select key for at least 1 second on the confirmation message display screen displays the setting save screen.
- Press the Menu key if performing no setting. The display returns to the normal communication setting screen.

NETWORK SETTING
IP ADDRESS
192.168.000.001
SUBNET MASK
255.255.255.000
DEFAULT GATEWAY
000.000.000.000
SET THIS SETTING. OK?
YES : SELECT KEY 1SEC
NO : MENU KEY

NETWORK SETTING
SAVING SET DATA NOW.
PLEASE WAIT FOR A WHILE.

- The figure at right is displayed after saving completion.
- Pressing the Menu key returns the display to the communication setting menu screen.
- Switch the power OFF and back ON again to validate the network setting. (Turn off and on the rear-panel mounted Main Power switch.)

**Note**

Network camera's settings are not enabled at the front-mounted Standby Key operation.

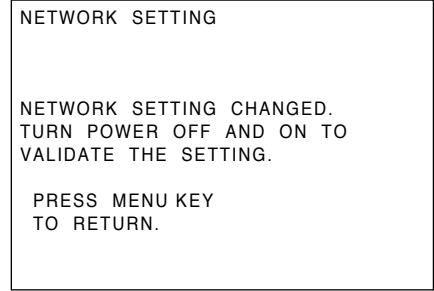

## 7.9. Log Display

Log indications include General Recording Log, Alarm Recording Log, and Failure Log.

- Move the cursor with the (▲) or (▼) key, and display Log Screen with the Select key.
- Return to the previous screen with the Menu key.

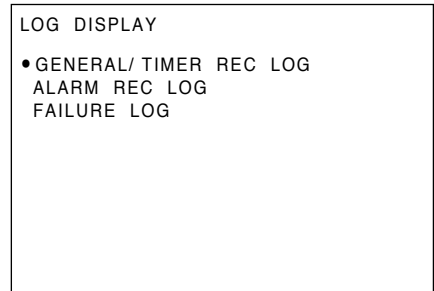

### 7.9.1. General/ Timer Recording Logs (General/ Timer Rec Log)

Logs start and end times of both General and Internal Timer Recordings, and displays from the latest log. Up to 100 logs are saved, and old logs are deleted in chronological order when this limit is exceeded.

- The display scrolls in page units (1 screen units) as the (▲) or (▼) key is pressed.
- Return to the previous screen with the Menu key.

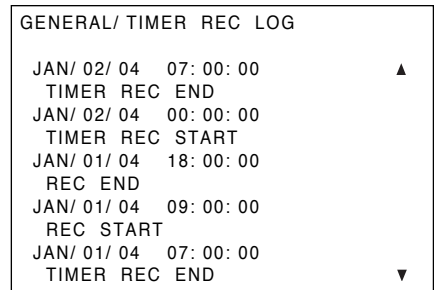

### 7.9.2 Alarm Recording Logs (Alarm Rec Log)

Logs Alarm Recording start and end times, and displays from the latest log. Up to 500 logs are saved and old logs are deleted in chronological order when this limit is exceeded.

- The display scrolls in page units (1 screen units) as the (▲) or (▼) key is pressed.
- Return to the previous screen with the Menu key.

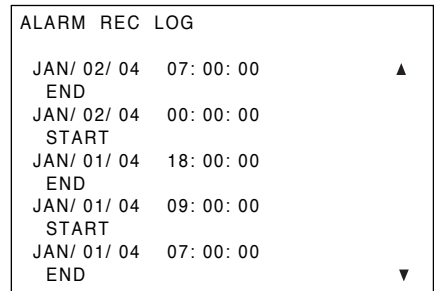



### 7.9.3. Failure Logs

Logs detection times and contents for the various different failure modes that can occur in the Digital Video Recorder, and displays from the latest log. Up to 100 logs are saved and old logs are deleted in chronological order when this limit is exceeded.

- The display scrolls in page units (1 screen units) as the (▲) or (▼) key is pressed.
- Return to the previous screen with the Menu key.

FAILURE LOG	
JAN/02/04 07:00:00	▲
VIDEO FAILURE	
JAN/02/04 00:00:00	
DISK FAILURE	
JAN/01/04 18:00:00	
VIDEO FAILURE	
JAN/01/04 09:00:00	
FAN FAILURE	
JAN/01/04 07:00:00	
DISK FAILURE	▼

Display Item	Contents
VIDEO FAILURE	Displays this indication when a video signal cutoff (Video Loss) is detected during recording.
DISK FAILURE	Displays this indication when a disk error is detected.
FAN FAILURE	Displays this indication when fan operation stops.

#### Note

The current log display does not change even if a new log is added during display.

To confirm the added log, change the page or return to the log item selection screen to display the log again.

All logs are deleted if Menu Default Settings of System Maintenance is performed.

## 7.10. System Maintenance

Performs menu default settings or format the hard disk.

- Move the cursor with the (▲) or (▼) key, and confirm the Item with the Select key.
- Return to the previous screen with the Menu key.

SYSTEM MAINTENANCE
• MENU DEFAULT SETTING
DISK FORMATTING

### 7.10.1. Menu Default Settings

- Holding down the Select key for at least 1 second clears saved menu setting contents and log information, initializing settings to factory-preset status. However, clock settings and network settings are retained.
- Return to the previous screen with the Menu key.

MENU DEFAULT SETTING
SET TO DEFAULT?
YES : SELECT KEY 1SEC
NO : MENU KEY

### 7.10.2. Disk Formatting

This function initializes the hard disk. If initialized, all previously recorded contents are deleted. However, setting contents and logs are retained. Hard disks to be formatted can be selected when the C-DR0101 and C-DR0105 is used.

- Move the cursor with the (▲) or (▼) key, and change setting values with the (−) or (+) key.
- Hold down the Select key for at least 1 second to start formatting.
- Return to the previous screen with the Menu key.

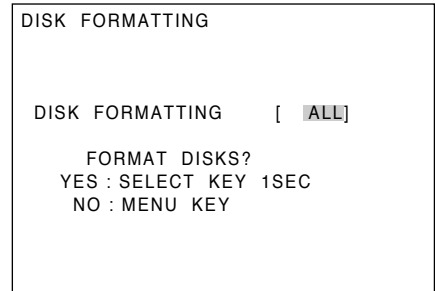

(C-DR0101, C-DR0105)

Setting Items	Contents
HDD-A	Formats Hard Disk A
HDD-B	Formats Hard Disk B
ALL	Formats all set hard disks.

Formatting is started by holding down the Select key for at least 1 second again after the reconfirmation message is displayed. Pressing the Menu key returns the display to the system maintenance screen without formatting.

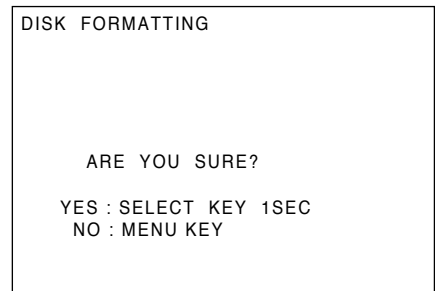

The disk error message is displayed if a disk error occurs during formatting.

## 8. DIGITAL VIDEO RECORDER ACTIVATION AND TERMINATION

### 8.1. Recorder's Activation

The switch and key shown in the following figures are used in operation.

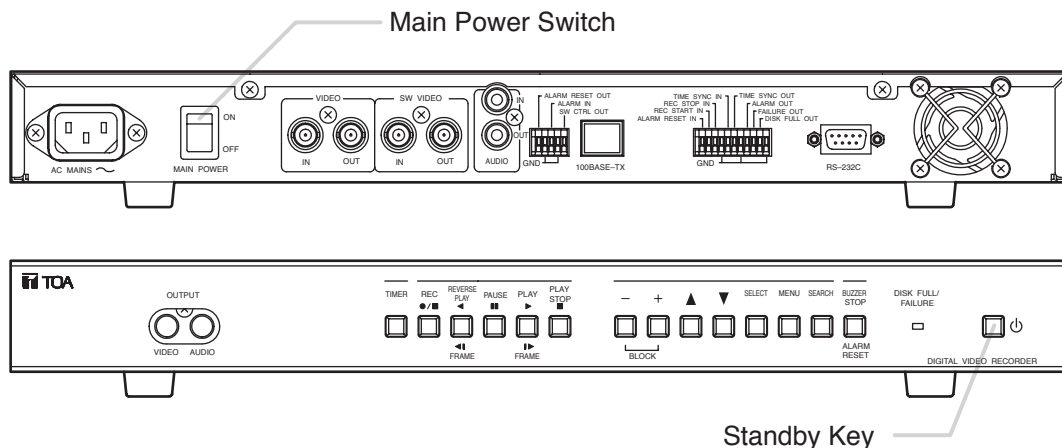

1. Connect each component correctly. (Refer to p. 40; "Connections.")
2. Set the rear-panel mounted Main Power switch to the ON position.  
The Standby key flashes green for 5 seconds while settings are initialized. Thereafter, the Recorder is placed in standby mode. The Standby key flashes every 5 seconds while in standby mode.

#### Note

Do not turn off the Main Power switch while the Standby key is flashing. Ensure that the Recorder is in the standby mode when turning off the Main Power switch.  
Logged data could be damaged or lost if the main power is switched off during initialization (while accessing the hard disk).

3. Press the Standby key while the Recorder is in standby mode.  
The screen automatically changes as shown below.  
The Standby key flashes green during a system check.

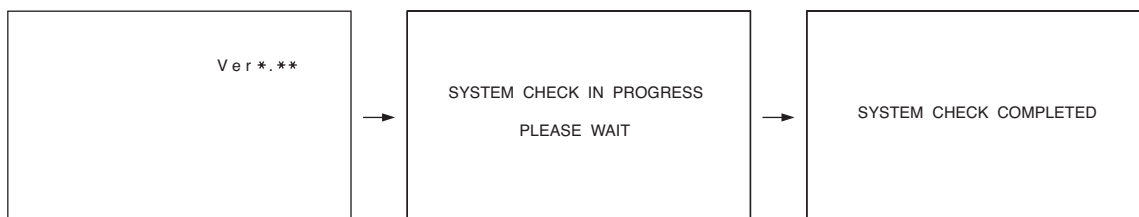

After system check completion, the Standby key changes from flashing to steady ON, allowing camera images to be displayed.

#### Note

When the Recorder is used for the first time or when the power was switched off for a long period of time, the date and time could not be correctly displayed. Perform the clock setting before use. (Refer to p. 14; "Clock Settings.")

## 8.2. When the Failure Screen Is Displayed:

### Note

- Avoid operating any key during a system check after the Standby key has been pressed. The failure indication shown in the figure at right could be displayed. In such cases, switch the power OFF and back ON again.
- If the failure indication is still displayed even though the power is reactivated, format the hard disk. (Refer to p. 26; "Disk Formatting.")
- If the failure indication does not disappear even though the disk is formatted, the disk 's failure may be the cause. Please contact your TOA dealer.

DISKS MAY HAVE FAILED.  
PLEASE TURN POWER SWITCH  
OFF AND ON AGAIN.

## 8.3. Recorder's Termination

1. Hold down the Standby key for at least 1 second.  
All operations stop, placing the Recorder in standby mode.

### Note

The Recorder's operation can be terminated by holding down the Standby key for at least 1 second even while in General Recording mode. However, when the Recorder is next reactivated, the previous recording is not retained and the Recorder is put into Pause mode. Preprogrammed timer times are set revised even if the Recorder is terminated during the timer setting and activated again.

2. Set the Main Power switch to the OFF position.  
The Recorder's power is switched off.

## 9. OPERATION AFTER POWER FAILURE RESTORATION

The Recorder's set contents are never reset by power failures. However, since the date and time are backed up by the built-in battery, if no power is supplied for a long period of time (1 month), they are reset. In such cases, perform the clock setting again.

### 9.1. When the Power Fails during Recording;

- During General Recording  
Recording is restarted when the power is restored.
- During Alarm Recording  
If an alarm input still continues when the power is restored, it is recognized as a new alarm input and recording is restarted. However, if no alarm exists, recording is not performed. Also, even if the power is restored within the set Alarm Recording time period or Post-alarm time period, recording is not restarted because there is no alarm signal.
- During Internal Timer Recording  
Timer operation is restarted if the power is restored within the set time period. If restored during Internal Timer Recording, the recording is restarted.

# 10. RECORDING

## 10.1. Type of Recording

Recording modes include General Recording, Internal Timer Recording, and Alarm Recording. Each recording mode permits the picture quality and recording interval to be set individually. (Refer to p. 17; "General Recording Settings.") In the Digital Video Recorder, recorded data from the start to the end of each recording is handled as a single recorded block.

### 10.1.1. Recording Priorities

The order of Recording Priority is as shown below.

Order of Priority	High ← → Low
Type of Recording	<div style="display: flex; justify-content: space-around; align-items: center;"> <div style="text-align: left;">                     General Recording                      Alarm Recording                 </div> <div style="font-size: 2em;">}</div> <div style="text-align: right;">                     Internal Timer Recording                 </div> </div>

Lower-priority recording stops whenever higher-priority recording is commenced. The following figure shows an example of recording operation that varies whenever recording of different priority levels is commenced.

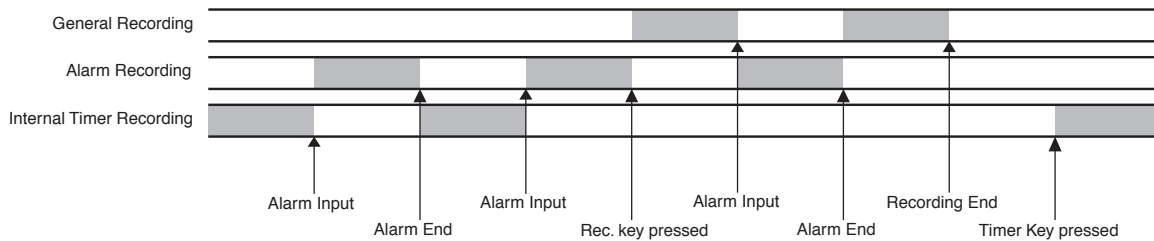

#### Note

Internal Timer Recording does not operate even if the Timer key is pressed during General or Alarm recording. Pressing the Recording (●/■) key during a timer setting cancels the timer setting. To resume the timer setting, first stop recording and press the Timer key.

## 10.2. Screen Display during Recording

The screen display setting is factory-preset to "DISP." (Refer to p. 21; "Screen Display Settings".)

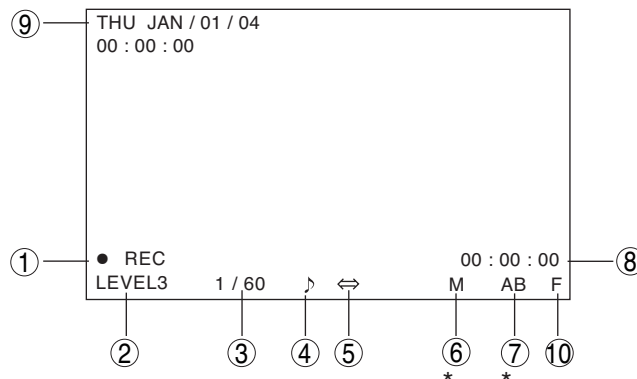

\* C-DR0101, C-DR0105

① Indicates the recording status. (Refer to p. 17; "General Recording Settings".)

- REC: Represents General Recording is in progress.
- TIMER: Represents Internal Timer Recording is in progress.
- ALARM: Represents Alarm Recording is in progress.

② Indicates the recording picture quality.

Can be set to Levels 1 – 5.  
LEVEL 1 provides the highest resolution display.

- ③ Indicates the recording interval.  
 General Recording and Internal Timer Recording : 1/60 – 60 seconds  
 Alarm Recording : 1/60 – 1 seconds

**Note**

- Even if the Recording Setting's Recording Interval is set to "1/60 SEC," Mirroring Recording is performed at the recording interval of 1/30 second. (The on-screen interval indication is also "1/30 SEC" in Mirroring Recording.) (Refer to p. 17; "General Recording Settings.")
- The higher the picture quality (resolution) and the shorter the recording interval, the shorter the possible recording time. Conversely, the lower the picture quality and the longer the recording interval, the longer the possible recording time. (Refer to p. 45; "Recording Time Table.")

- ④ Indicates whether or not to use the Audio recording function.

🎵 : Audio recording ON (enabled)  
 No indication : Audio recording OFF (disabled)

- ⑤ Indicates the hard disk Recording Mode. (Refer to p. 15; "Disk Settings.")

↔ Re-Rec Mode  
 ⇒ Stop Mode  
 ⇒⇒ Series Mode

- Re-Rec Mode : Overwrites old hard disk recordings in chronological order even when no available hard disk time remains.
- Stop Mode : Stops video recording when no available hard disk time remains.
- Series Mode : Stops video recording when no available hard disk time remains, and sends out a signal from the Control Terminal's Disk Full output, allowing other series-connected Digital Video Recorder to start recording. The slave Digital Video Recorder starts recording when it receives a signal at its Recording Start input terminal even if its hard disk becomes full. (Refer to p. 41; "Expansion System (Series Recording).")

- ⑥ Indicates the Disk Mode. (C-DR0101, C-DR0105) (Refer to p. 15, "Disk Settings".)

No indication : Normal Recording  
 M : Mirroring Recording

- About Normal and Mirroring recordings  
 The C-DR0101 and C-DR0105 has two built-in hard disks.  
 Setting the Disk Mode to "NORMAL" permits camera images to be recorded on the second hard disk when the first hard disk becomes full.  
 Setting the Disk Mode to "MIRRORING" permits the same recording to be simultaneously performed on the two hard disks. Even if one of the two disks fails, recording and playback can still be performed using the other disk.

- ⑦ Indicates the hard disk recognition status. (C-DR0101, C-DR0105)

Characters are reversed for the hard disk in recording mode.  
 The "X" indication is displayed when the hard disk fails.

**Note**

Even if the Screen Display Setting's Disk Mode Indication is set to "HIDE," the "X" indication is displayed when the hard disk fails.

- ⑧ Indicates the remaining hard disk recording time calculated from the picture quality and recording interval of current recording.

If the Disk Setting's Recording Mode is set to "RE-REC", the remaining hard disk recording time is not displayed.(Refer to p. 15; "Disk Settings".)

- ⑨ Indicates the current date and time.

- ⑩ The "F" indication flashes when the fan fails.  
 Cannot be set to "HIDE" in Screen Display Settings.

### 10.3. The Keys to Be Used in Recording

The following keys are used in recording:

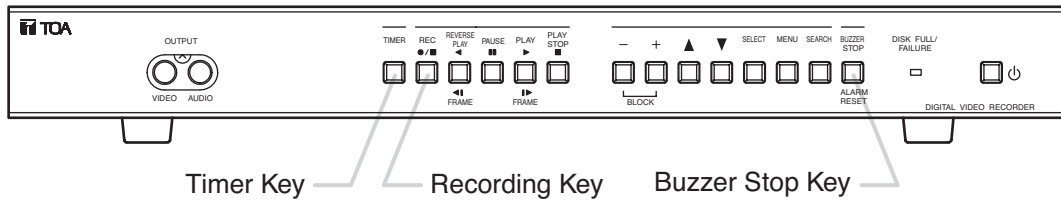

### 10.4. Performing General Recording (Refer to p. 17; "General Recording Settings")

**Note**

Be sure to perform time and date settings before recording. (Refer to p. 14; "Clock Settings")

1. Press the Recording key (●/■) to start General Recording.  
 When recording is started, the Recording key lights red.  
 If "DISP" has been selected in Screen Display Settings, setting data is displayed on the monitor and the Recording indication is displayed for recording status.

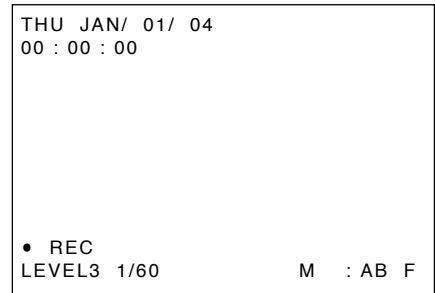

**Note**

When the Disk Setting Recording Mode has been set to "STOP" or "SERIES," the Disk Full indicator flashes if less than 1 hour of available hard disk time remains. If no available hard disk time remains, the Disk Full indicator changes to steady ON and recording stops.

2. Hold down the Recording key (●/■) for at least 1 second to stop recording.  
 The illuminated Recording key extinguishes.

**Note**

If an alarm is activated during General Recording performance while in alarm standby mode, the General Recording is interrupted and switched over to Alarm Recording. The General Recording is automatically restored after Alarm Recording completion.

### 10.5. Performing Internal Timer Recording (Refer to p. 17; "Internal Timer Recording Settings")

**Note**

Be sure to perform date and time settings before recording. (Refer to p. 14; "Clock Settings".)

1. Press the Timer key.  
 The Digital Video Recorder is placed in Internal Timer Recording standby mode, and the Timer key lights green.
2. When the preset time is reached or if the key is pressed within the preset period, the Recording key lights red and recording is started.  
 If "DISP" has been selected in Screen Display Settings, setting data is displayed on the monitor, and the "TIMER" indication is displayed for recording status.

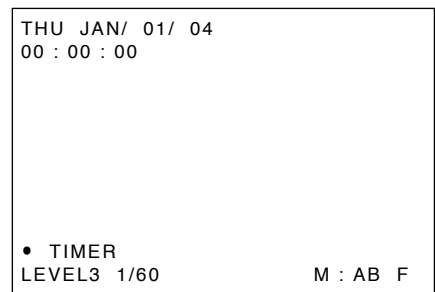

- Recording stops when the end of the preset recording period is reached.  
The illuminated Recording key extinguishes.

**Note**

- When the Disk Setting Recording Mode is set to "STOP," recording stops if no available hard disk time remains.
- When the Recording mode is set to "SERIES," timer program cannot be performed.
- When an alarm is activated during Internal Timer Recording, the Internal Timer Recording is interrupted, and automatically restored after Alarm Recording completion.
- Pressing the Recording key (●/■) during Internal Timer Recording resets Internal Timer Recording, and switches it over to General Recording.

- To cancel Internal Timer Recording, hold down the Timer key for at least 1 second. The illuminated Timer key extinguishes.

## 10.6. Performing Alarm Recording (Refer to p. 19; "Alarm Recording Settings)

**Note**

- Be sure to perform date and time settings before recording. (Refer to p. 14; "Clock Settings".)
- Be sure to set the Alarm Recording Setting's Alarm Setting to "VALID" when performing Alarm Recording. This places the Digital Video Recorder in alarm standby mode.
- The setting is factory-preset to "VALID."

- A buzzer is sounded and the Buzzer stop key flashes red when an alarm signal is received. At the same time, the Recording key lights red and recording is started. The Buzzer stop key continues flashing red during Alarm Recording.
  - If "DISP" has been selected in Screen Display Settings, setting data is displayed on the monitor, and the "ALARM" indication is displayed for recording status.
  - Pressing the Buzzer stop key during buzzer output stops the buzzer. Whether or not to sound a buzzer can be set by selecting ON or OFF in Alarm Recording Settings.
  - Alarm Recording provides an open collector signal from the Alarm Output Terminal. An alarm output duration can be set to "1 SEC" or "DURING REC" in Alarm Recording Settings.

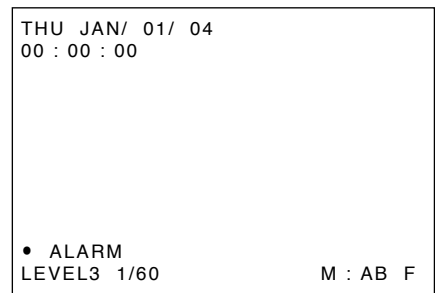

- Recording stops when the end of the Preset Alarm Recording Period is reached. The illuminated Recording key extinguishes, however the Alarm Reset key remains lit. To reset Alarm Recording before the Preset Alarm Recording Period is started, hold down the Alarm Reset key for at least 1 second.

**Note**

- Pressing the Recording key (●/■) during Alarm Recording resets Alarm Recording, and switches it over to General Recording. However, the Alarm Reset key continuously lights red to indicate that an alarm has been activated.
- To extinguish the illuminated Alarm Reset key, hold down the Alarm Reset key for at least 1 second.
- If the Alarm Recording's Alarm Settings is set to "VAL REC," alarm signals are only accepted while recording is in progress. Alarm inputs can be only accepted during the necessary surveillance period by combining both Alarm and Internal Timer recordings.
- If the Alarm Recording's Alarm Settings is set to "INVALID," any alarm input is not accepted.
- If other alarms are activated during Alarm Recording, the preset alarm time is initialized to make the recording period longer. In this case, the number of recorded blocks is one.



# 11. PLAYBACK

## 11.1. Type of Playback

The Digital Video Recorder features the simultaneous recording/playback function that permits recorded images to be played back without stopping recording. The types of playback include Playback, Reverse Playback, Fast Forward Playback, Fast Reverse Playback, Forward Frame Playback, and Reverse Frame Playback.

**Note**

- When the Playback Setting's Simultaneous Recording/Playback is set to "DISALLOW," playback cannot be performed during recording. Only recording or playback can be performed.
- Playback performance could be degraded during simultaneous recording/playback operation.

## 11.2. Screen Display during Playback

Screen Display Settings is factory-preset to "DISP." (Refer to p. 21; "Screen Display Settings.")

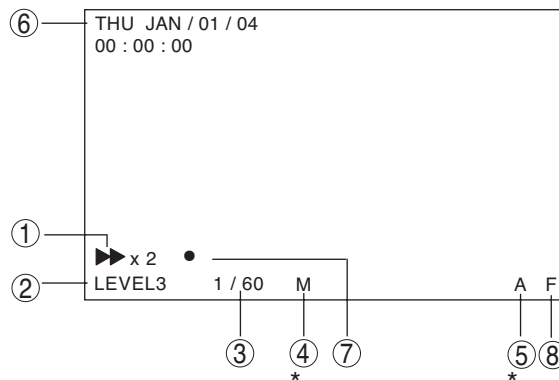

\* C-DR0101, C-DR0105

① Indicates playback mode.

- ◀◀ : Fast Reverse Playback
- ▶▶ : Fast Forward Playback
- ◀ : Reverse Playback
- ▶ : Playback
- : Pause

- Pressing the Playback key (▶) during playback (or the Reverse Playback key (◀) during Reverse playback) changes the mode to Fast Forward playback (Fast Reverse playback during Reverse playback). The "x2", "x4" or "x8" indication is displayed on the screen to indicate the playback speed.
- Pressing the Playback key (▶) or the Reverse Playback key (◀) during still picture playback (while in pause mode) changes the mode to Forward or Reverse Frame playback. Holding down the key performs a continuous frame-by-frame playback of the recorded image.

② Indicates the recording picture quality.  
Can be set to Levels 1 – 5. Quality increases as the number decreases.

③ Indicates the recording interval.  
General Recording, Internal Timer Recording : 1/60 – 60 seconds  
Alarm Recording : 1/60 – 1 seconds

④ Indicates an attribute of Mirroring Recording. (C-DR0101, C-DR0105)  
No indication : Data other than Mirroring Recording data  
M : Mirroring Recording data

⑤ Indicates the currently-used hard disk. (C-DR0101, C-DR0105)  
A : Playback of Hard disk A  
B : Playback of Hard disk B

⑥ Indicates recording dates and times.

⑦ The (●) indication is displayed when recording is also performed simultaneously with playback.

⑧ The "F" indication flashes when the fan fails.  
This indication cannot be set to "HIDE" in Screen Display Settings.

### 11.3. The Keys to Be Used in Playback

The following keys are used in playback.

Reverse Playback key, Pause key, Playback key, Playback Stop key, Block Shift key

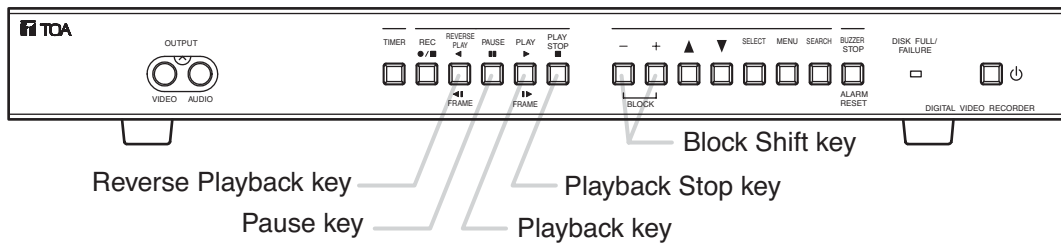

### 11.4. Performing Playback

1. Press the Playback key (▶) to start playback.

The Playback key lights green when playback is started.

If Screen Display Settings has been set to "DISP," setting data is displayed on the monitor, and the "Playback" indication is displayed for playback status.

2. Press the Playback Stop key (■) to stop playback. The illuminated Playback key extinguishes.

### 11.5. Performing Various Playback Functions

#### 11.5.1. Reverse Playback

Press the Reverse Playback key (◀) to perform playback in the reverse direction.

The Reverse Playback key lights green when Reverse playback is started.

If Screen Display Settings has been set to "DISP," setting data is displayed on the monitor, and the "Reverse Playback" indication is displayed for playback status.

#### 11.5.2. Fast Forward Playback and Fast Reverse Playback

Pressing the Playback key (▶) during playback (or the Reverse Playback key (◀) during Reverse playback) changes the playback mode to Fast Forward (or to Fast Reverse playback if pressed during Reverse playback). The playback speed changes as the key is pressed.

Playback speed: Original speed → Twofold speed (x2) → Fourfold speed (x4) → Eightfold speed (x8)

#### Note

Playback may not be performed at the indicated speed depending on the hard disk performance, such as access times.

#### 11.5.3. Playback Pause (Still Picture)

1. Pressing the Pause key (■) during playback or Reverse playback suspends playback operation, causing the Pause key to light green.

If Screen Display Settings has been set to "DISP," setting data is displayed on the monitor, and the "Pause" indication is displayed while in pause mode.

2. Pressing the Pause key (■) again returns the Digital Video Recorder to the playback mode it was last in before playback was suspended.

The illuminated Pause key extinguishes and the Playback key lights.

#### 11.5.4. Forward Frame Playback and Reverse Frame Playback

If the Playback key (▶) or Reverse Playback key (◀) is pressed while in Playback Pause mode, Forward or Reverse Frame playback can be performed.

Pressing the key once performs a single-frame playback per screen, while holding down the key provides a continuous frame-by-frame playback.

#### 11.5.5. Forward Block Playback and Reverse Block Playback

In the Digital Video Recorder, recorded data from the start to the end of each recording is handled as a single recorded block. Since both the Forward Block Playback and Reverse Block Playback functions shift playback images on a block basis, desired scenes can be searched while viewing playback images.

Pressing the (+) Block Shift key during playback shifts the recorded image to the head of the next block, temporarily stopping playback for 1 second before it is restarted. If the (+) Block Shift key is pressed again while in Playback Pause mode, the recorded image is shifted to the next block, providing the same operation.

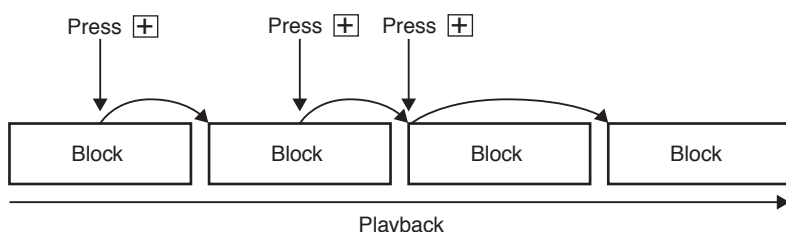

Pressing the (-) Block Shift key during playback shifts the recorded image to the head of the block currently played back, temporarily stopping playback for 1 second before it is restarted. If the (-) Block Shift key is pressed again while in Playback Pause mode, the recorded image is shifted to the head of the preceding block and then it is played back.

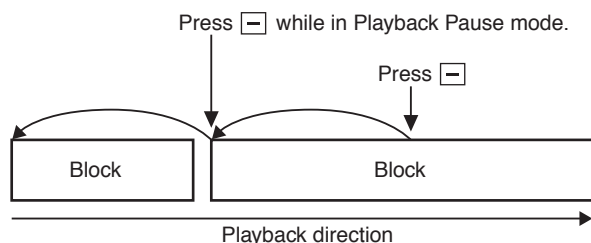

Block shift is also possible during Reverse Playback operation, however playback resumes in the forward direction after the recorded image has been shifted to the head of the desired block.

## 11.6. About the Playback Start Position

- If playback is initiated from the camera display screen, the playback begins from the position at which it was last stopped. When the power is switched on or when the position previously played back has been overwritten, playback is started from the oldest recorded image. During recording, playback is started from the most recent data in the currently recorded block.
- Pressing the Playback key (▶) (or the Reverse Playback key (◀)) while holding down the Playback Stop key (■) while in Stop or Playback mode shifts the recorded image to the following position for playback.

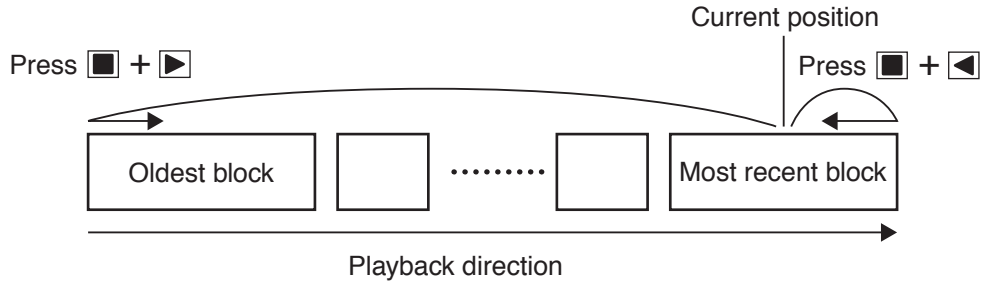

- Pressing the Playback key (▶) (or the Reverse Playback key (◀)) while holding down the Playback Stop key (■) during recording causes playback to be started from the following position.

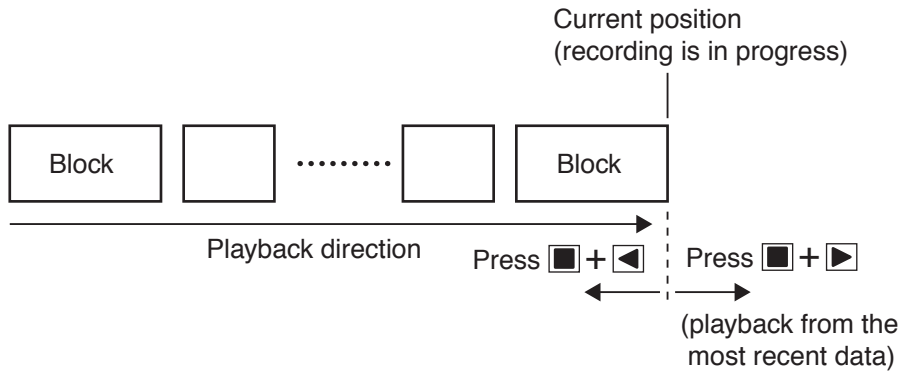

### Note

When playing back in the forward direction, if the Pre-alarm time has been set to 10 second or more and the Digital Video Recorder is in alarm standby mode, playback is started from 10 minutes before the most recent block is played back.

## 12. SEARCH FUNCTIONS

The following three methods are available to search recorded data (images):

1. Date/Time Search : Playback can be initiated by designating the date and time.
  2. Block Search : Playback can be initiated by selecting the recorded block.
  3. Time Shift Search : Playback can be initiated by increasing or decreasing times from the designated time.
- The Digital Video Recorder handles recorded data from the start to the end of each recording as a single recorded block.

The above three search methods differ in operation.

### 12.1. The Keys to Be Used in Searching

The following keys are used in search operation:

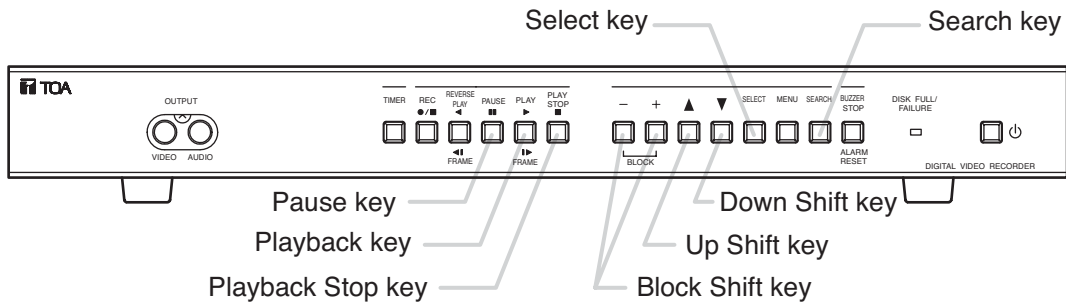

### 12.2. Date/Time and Block Searches

#### 12.2.1. Basic Date/Time Search and Block Search Operations

1. Press the Search key.  
The Search menu screen is displayed.  
Playback stops if the key is pressed during playback.  
Pressing the Search key again returns the display to the camera image screen.
2. Move the cursor to select the desired search function with the (▲) or (▼) key, then confirm the selection with the Select key.

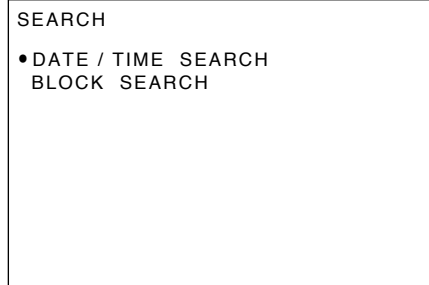

Setting Items	Setting Value	Contents
DATE/TIME SEARCH	Date/ time data entry	Recorded images are searched by directly entering the date and time
BLOCK SEARCH	—	Recorded images are searched by selecting the recorded block.

#### 12.2.2. Date/Time Search Operation

- Move the cursor with the (▲) or (▼) key, and change setting values with the (-) or (+) key.
- Executing searches with the Select key displays the image of the designated time on the still picture mode screen. The Pause key lights green.
- Playback begins if the Pause key (■) is pressed.

#### Note

- When no recording exists at the designated time, the first image of the recorded block following the designated time is displayed.
- Attempting to perform searches beyond the current time results in a display of the "INVALID SEARCH" indication on the Date/Time Search screen.

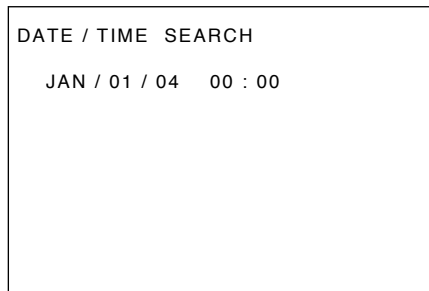

### 12.2.3. Block Search Operation

- Using the (▲) or (▼) key, move the cursor to scroll the screen and select the desired block.  
The (▼) indication is displayed when data exists before the currently displayed search screen, while the (▲) indication is displayed when data exists after the currently-displayed search screen.

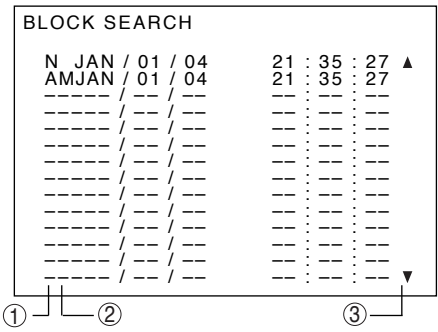

① [Recorded block types]

Recorded block types are classified by characters "N," "T," and "A."

Item	Contents
N	General Recording block
T	Internal Timer Recording block
A	Alarm Recording block

**Note**

The Alarm Recording block time represents the time that an alarm was received. If the Pre-alarm function has been set, Alarm Recording begins from the image recorded before the indicated alarm time.

② [Recorded block attribute]

Character M represents data attribute types.

Item	Contents
No Indication	Normal Recording data
M	Mirroring Recording data

**Note**

Avoid mixing both Normal Recordings and Mirroring Recordings on the hard disk. If mixed, block shift or search operations cannot be correctly performed during playback. (Refer to p. 15; "Disk Settings.")

③ [Hard disk types]

Characters A and B represent built-in hard disk drives.

Item	Contents
A	Data contained in Hard Disk A
B	Data contained in Hard Disk B

- Executing searches with the Select key displays the first image of the block on the still picture screen. The image is played back if the Pause key is pressed. Pressing the (+) or (-) key while in the Pause mode displays the first image of the block, performing playback from one block to another. After the block has switched over to another block, playback can be performed even without pressing the Pause key.
- "Loop" playback is performed for all playback operations after Block Shift search.

**Note**

- "Loop" playback: Repeats playback of each recorded block.
- Pressing the Playback Stop key (■) and the Playback key (▶) again during "Loop" playback resets the "Loop" playback, causing playback to be performed on a time basis.

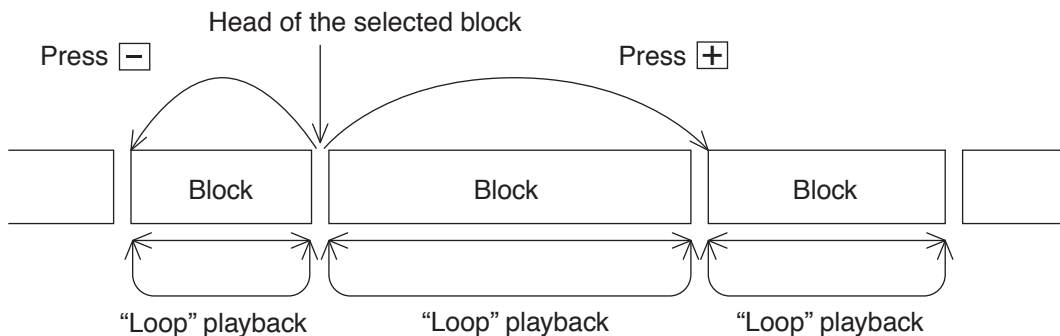



## 13. CONNECTIONS

### 13.1. Preparations for Connections

Switch off the power to the Digital Video Recorder and all connected equipment before performing connections. The Digital Video Recorder has built-in hard disks. To avoid damage to them, when moving the Digital Video Recorder, be sure to leave the Recorder's Main Power switch turned off for at least 30 seconds before moving.

#### 13.1.1. Control Input/Output Terminal Connections

Applicable cables are as follows:

- Solid cable : AWG28 ( $\varnothing$  0.32mm) – AWG22( $\varnothing$  0.65mm)
- Twisted cable: AWG28 (0.08mm<sup>2</sup>) – AWG22(0.32mm<sup>2</sup>)

To connect, remove the cable sheath 10 mm from the cable end, and then insert the cable into the terminal pressing on the tab on the terminal using a screwdriver.

### 13.2. When Using the 24V AC or 12V DC or AC Mains Camera:

Connect the Digital Video Recorder's Video Input terminal to the camera's video output terminal.

### 13.3. Connections to the Monitor TV

The Digital Video Recorder's terminals to be connected to the monitor differ depending on the type of connected equipment.

- When the Digital Video Recorder is not connected to the Multi-switcher:  
Connect the Recorder's Video Output terminal to the monitor's video input terminal, and the Recorder's Audio Output terminal to the monitor's audio input terminal.
- When the Digital Video Recorder is connected to the Multi-switcher:  
Connect the Recorder's Switcher Video Output terminal to the monitor's video input terminal, and the Recorder's Audio Output terminal to the monitor's audio input terminal.



### 13.4. Combination With The Digital Video Recorder/ Multi-switchers (C-MS91D and C-MS161D)

The Digital Video Recorder has been designed with an emphasis on the synchronization with the TOA Multi-switchers (C-MS91D, C-MS161D).

By synchronizing the Digital Video Recorder with the Multi-switcher, the following advantages – unavailable to conventional systems using analog time-lapse VCRs – can be realized.

1. The Multi-switcher does not need to be operated when operating the Digital Video Recorder.
2. The Digital Video Recorder’s main menu screen or search screen can be easily displayed, facilitating settings and search operations.

The combined Digital Video Recorder/Multi-switcher system is called a basic system in this manual. Since the Multi-switcher has 2 VCR output terminals, hard disk space can be doubled by connecting two Digital Video Recorders. This system is called an expansion system. The expansion system does not permit the synchronization between the Digital Video Recorder and the Multi-switcher.

#### 13.4.1. Basic System

Perform connections as shown in connection examples. (Refer to p. 43)

Set the Multi-switcher (C-MS91D and C-MS161D) and the Digital Video Recorder as follows:

• Multi-switcher settings

Perform remote and recording settings as follows:

	Setting Items	Contents
Remote Settings	Recording Pattern Operation	RS-232C
	Motion Detection Pattern Operation	RS-232C
	RS-232C	38.4kbps (Default)
	RS-232C Protocol	1 (Default)
Recording Settings	Recording Device	2
Buzzer/ Character Display Settings	Date/Time (VCR)	OFF*1

• Digital Video Recorder settings

Perform communication settings as follows:

	Setting Items	Contents
Communication Settings	RS-232C Transmission Rate	38400bps (Default)
	RS-232C Flow Control	OFF (Default)
	Switcher Synchronization*2	ON
When performing Internal Timer Recording settings	Recording Pattern	Match the Recorder’s settings to those of the Multi-switcher
	Motion Detection Pattern	

#### Note

\*1 Use the Digital Video Recorder’s date/time display function for date/time display. If set at both the Multi-switcher and Digital Video Recorder, characters overlap and cannot be seen clearly.

\*2 Recording Pattern, Motion Detection Pattern, Camera/ VCR mode selection, and Time Synchronization switcher functions can all be controlled by the Digital Video Recorder. However, when synchronizing the switcher's clock from the Recorder, set the Recorder's clock Time Synchronization setting to "MASTER." Time synchronization cannot be performed if set to "SLAVE."

When only performing time synchronization, set the communication switcher synchronization setting to "TIME SYNC." Please note that in this mode Recording Pattern, Motion Detection Pattern, and Camera/ VCR mode selection functions cannot be controlled.

- For more information on the Multi-switcher’s settings, refer to the instruction manual for the Multi-switcher.

#### 13.4.2. Expansion System (Series Recording)

Perform connections as shown in connection examples. (Refer to p. 44)

The Digital Video Recorder settings are as follows:

Setting Items	First Digital Video Recorder	Second Digital Video Recorder
Recording Mode	SERIES	SERIES
Time Synchronization	MASTER	SLAVE
Disk Full indicator status	OFF	ON

• Operation

If the first Digital Video Recorder’s hard disk space becomes full, a signal is provided from the Disk Full Output terminal. When the signal is received at the second Digital Video Recorder’s Recording Start Input terminal, its Disk Full mode is reset, allowing recording to be started in the second unit.

#### Note

- Recording operation and Internal Timer Recording cannot be performed at the front panel of the Digital Video Recorder set to Disk Full mode.
- Multi-switcher can be synchronized from the unit set to master through the RS-232C interface. Set Communication Setting’s Switcher Synchronization to “TIME SYNC.”

# 14. CONNECTION EXAMPLES

## 14.1. Connection to the 24V AC or 12V DC or AC Mains Camera.

### Note

Power Sync cameras cannot be used.

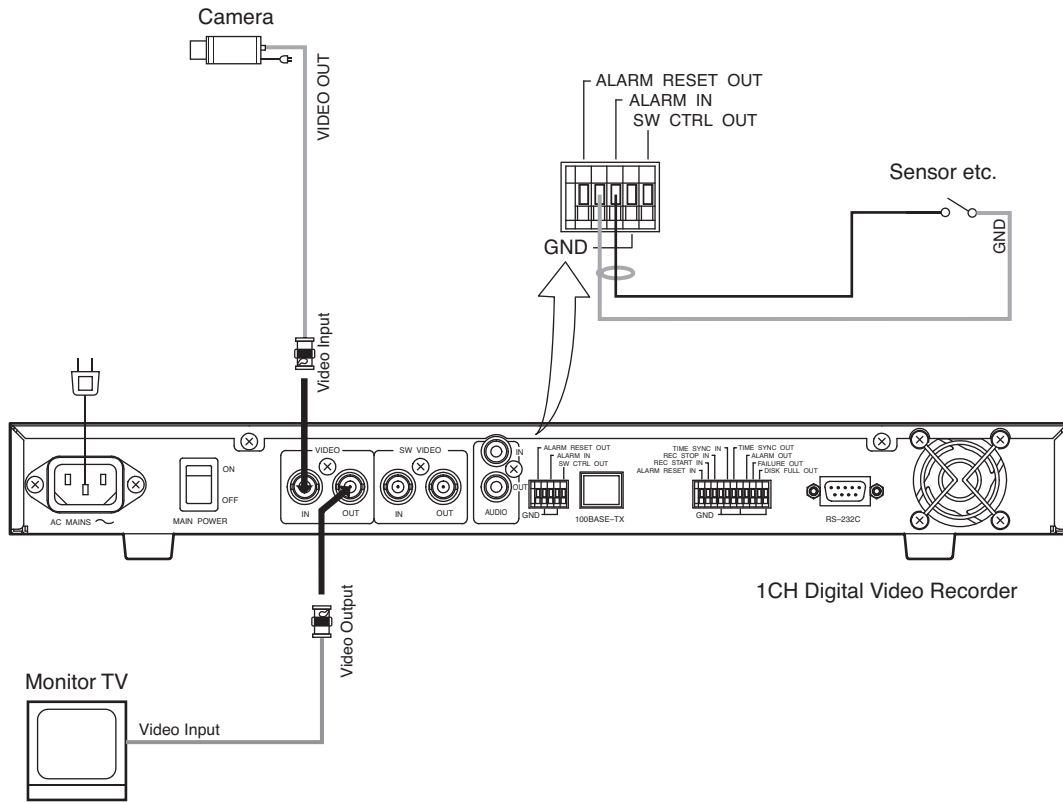

## 14.2. Connection to the Multi-switcher

### 14.2.1. Basic System (Combined with the C-MS91D Multi-switcher)

**Note**

Power Sync cameras cannot be used.

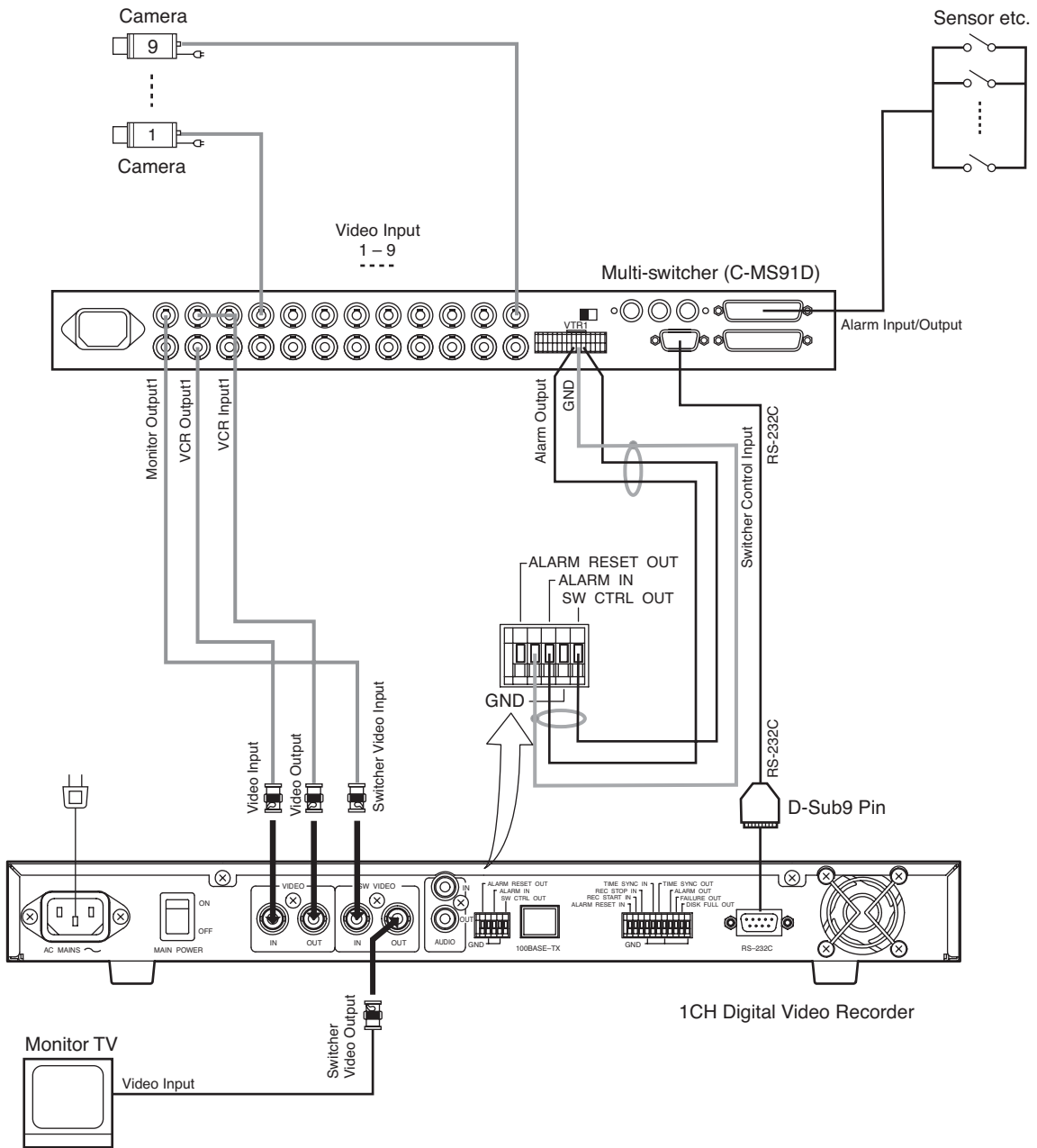

### 14.2.2. Expansion System (Combined with the C-MS91D Multi-switcher)

**Note**

Power Sync cameras cannot be used.

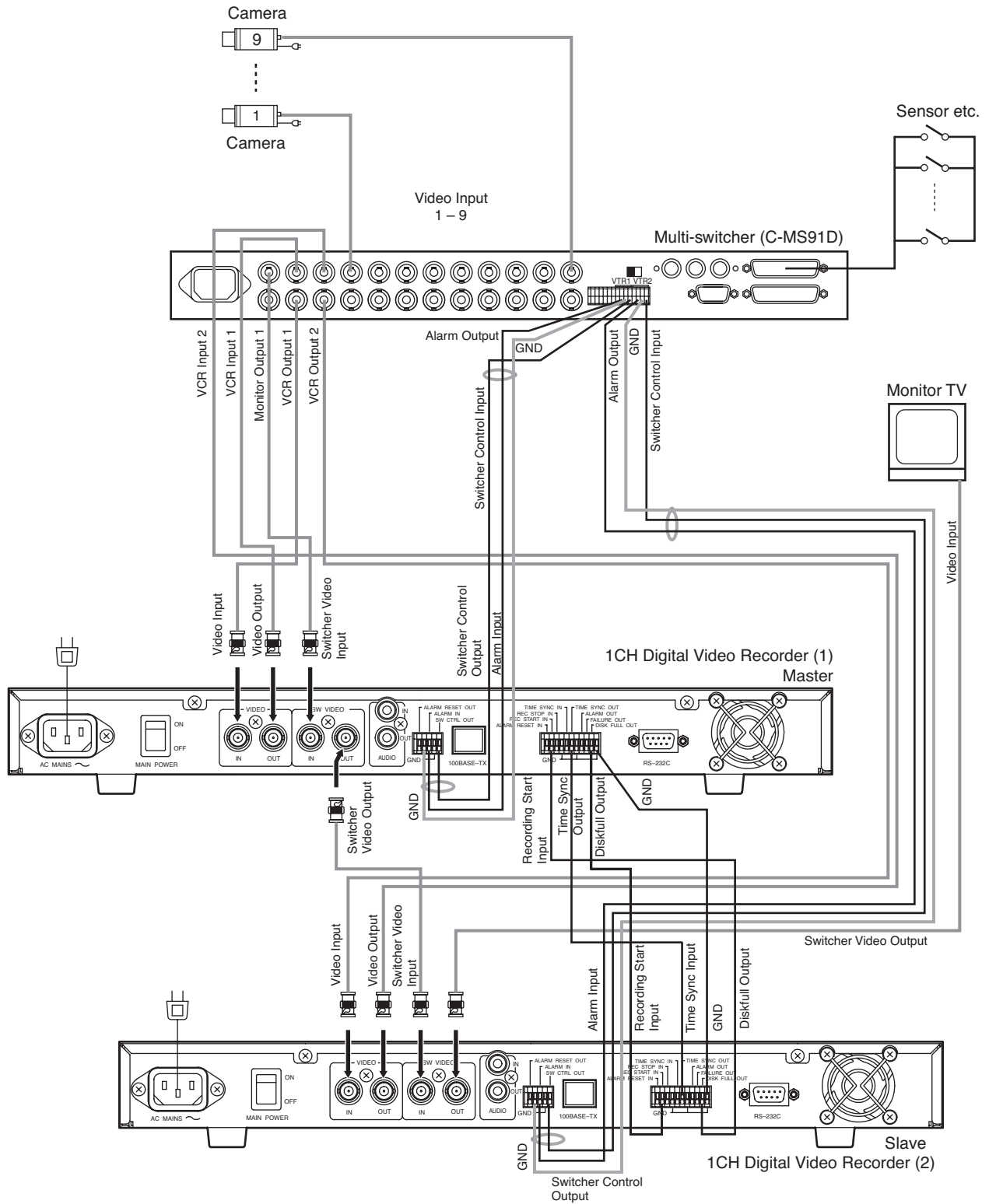

# 15. RECORDING TIME TABLE

## 15.1. Recording Picture Quality Setting

The Digital Video Recorder is designed to be used as a hard disk recorder for surveillance applications, and its picture quality can be set to Levels 1 – 5. Whether emphasis is placed on picture quality or on recording interval can be selected depending on surveillance conditions. When setting the picture quality, carefully consider recording times, recording intervals, recording types and other surveillance conditions, and be sure to carry out test recordings in advance to ensure that the required picture quality is maintained.

**Note:** Recording time is given as a guideline reference.

## 15.2. When using the C-DR0100

Disk Mode : NORMAL      Audio Record : ON

Picture quality	File Size	Recording Time Intervals (Sec), Recording Time Period														
		1/60	1/30	1/15	1/10	1/5	1/3	1/2	1	2	3	5	10	20	30	60
Level 1	64KB	8	17	33	50	97	158	227	409	681	878	1134	1460	1704	1803	1916
Level 2	40KB	13	26	52	78	150	239	337	580	901	1112	1356	1631	1815	1884	1961
Level 3	32KB	17	33	64	95	183	289	402	674	1011	1220	1450	1697	1855	1913	1976
Level 4	24KB	22	43	84	124	234	364	498	804	1150	1352	1558	1769	1898	1943	1992
Level 5	16KB	32	62	120	176	325	494	654	996	1334	1516	1684	1848	1942	1973	2008

Disk Mode : NORMAL      Audio Record : OFF

Picture quality	File Size	Recording Time Intervals (Sec), Recording Time Period														
		1/60	1/30	1/15	1/10	1/5	1/3	1/2	1	2	3	5	10	20	30	60
Level 1	64KB	9	17	34	51	103	171	257	513	1026	1539	2565	5131	10262	15392	30785
Level 2	40KB	14	27	54	81	163	271	407	813	1627	2440	4067	8134	16268	24403	48805
Level 3	32KB	17	34	67	101	202	337	505	1011	2021	3032	5053	10106	20212	30318	60637
Level 4	24KB	22	44	89	133	267	445	667	1334	2668	4002	6670	13340	26680	40020	80041
Level 5	16KB	33	65	131	196	392	654	981	1962	3924	5885	9809	19618	39236	58853	117707

## 15.3. When using the C-DR0101

Disk Mode : NORMAL      Audio Record : ON

Picture quality	File Size	Recording Time Intervals (Sec), Recording Time Period														
		1/60	1/30	1/15	1/10	1/5	1/3	1/2	1	2	3	5	10	20	30	60
Level 1	64KB	17	34	67	100	195	315	454	818	1361	1755	2269	2919	3407	3605	3832
Level 2	40KB	27	53	105	155	300	478	674	1160	1803	2223	2711	3262	3630	3768	3922
Level 3	32KB	33	65	129	191	365	577	804	1347	2021	2440	2900	3394	3711	3826	3953
Level 4	24KB	44	86	168	247	468	729	996	1607	2300	2704	3117	3538	3795	3885	3984
Level 5	16KB	64	124	240	351	651	988	1308	1991	2668	3032	3369	3695	3884	3947	4016

Disk Mode : NORMAL      Audio Record : OFF

Picture quality	File Size	Recording Time Intervals (Sec), Recording Time Period														
		1/60	1/30	1/15	1/10	1/5	1/3	1/2	1	2	3	5	10	20	30	60
Level 1	64KB	17	34	68	103	205	342	513	1026	2052	3078	5131	10262	20523	30785	61570
Level 2	40KB	27	54	108	163	325	542	813	1627	3254	4881	8134	16268	32537	48805	97610
Level 3	32KB	34	67	135	202	404	674	1011	2021	4042	6064	10106	20212	40425	60637	121274
Level 4	24KB	44	89	178	267	534	889	1334	2668	5336	8004	13340	26680	53360	80041	160081
Level 5	16KB	65	131	262	392	785	1308	1962	3924	7847	11771	19618	39236	78471	117707	235413

Disk Mode : MIRRORING      Audio Record : ON

Picture quality	File Size	Recording Time Intervals (Sec), Recording Time Period														
		1/60	1/30	1/15	1/10	1/5	1/3	1/2	1	2	3	5	10	20	30	60
Level 1	64KB	–	17	33	50	97	158	227	409	681	878	1134	1460	1704	1803	1916
Level 2	40KB	–	26	52	78	150	239	337	580	901	1112	1356	1631	1815	1884	1961
Level 3	32KB	–	33	64	95	183	289	402	674	1011	1220	1450	1697	1855	1913	1976
Level 4	24KB	–	43	84	124	234	364	498	804	1150	1352	1558	1769	1898	1943	1992
Level 5	16KB	–	62	120	176	325	494	654	996	1334	1516	1684	1848	1942	1973	2008

Disk Mode : MIRRORING      Audio Record : OFF

Picture quality	File Size	Recording Time Intervals (Sec), Recording Time Period														
		1/60	1/30	1/15	1/10	1/5	1/3	1/2	1	2	3	5	10	20	30	60
Level 1	64KB	–	17	34	51	103	171	257	513	1026	1539	2565	5131	10262	15392	30785
Level 2	40KB	–	27	54	81	163	271	407	813	1627	2440	4067	8134	16268	24403	48805
Level 3	32KB	–	34	67	101	202	337	505	1011	2021	3032	5053	10106	20212	30318	60637
Level 4	24KB	–	44	89	133	267	445	667	1334	2668	4002	6670	13340	26680	40020	80041
Level 5	16KB	–	65	131	196	392	654	981	1962	3924	5885	9809	19618	39236	58853	117707

### 15.4. When using the C-DR0105

Disk Mode : NORMAL      Audio Record : ON

Picture quality	File Size	Recording Time Intervals (Sec), Recording Time Period														
		1/60	1/30	1/15	1/10	1/5	1/3	1/2	1	2	3	5	10	20	30	60
Level 1	64KB	34	68	136	203	397	643	926	1670	2779	3583	4631	5959	6956	7360	7822
Level 2	40KB	54	108	213	316	612	976	1375	2368	3680	4539	5535	6658	7410	7693	8006
Level 3	32KB	67	133	263	389	746	1179	1640	2751	4126	4982	5920	6930	7575	7811	8069
Level 4	24KB	89	174	342	504	955	1488	2032	3281	4695	5520	6363	7224	7748	7932	8133
Level 5	16KB	129	252	490	716	1328	2017	2670	4064	5447	6189	6877	7544	7928	8057	8199

Disk Mode : NORMAL      Audio Record : OFF

Picture quality	File Size	Recording Time Intervals (Sec), Recording Time Period														
		1/60	1/30	1/15	1/10	1/5	1/3	1/2	1	2	3	5	10	20	30	60
Level 1	64KB	34	69	139	209	419	698	1047	2095	4190	6285	10475	20950	41900	62850	125701
Level 2	40KB	55	110	221	332	664	1107	1660	3321	6642	9964	16606	33213	66427	99641	199282
Level 3	32KB	68	137	275	412	825	1375	2063	4126	8253	12379	20632	41265	82531	123796	247593
Level 4	24KB	90	181	363	544	1089	1815	2723	5447	10894	16341	27235	54470	108941	163411	326823
Level 5	16KB	133	267	534	801	1602	2670	4005	8010	16020	24031	40051	80103	160207	240311	480622

Disk Mode : MIRRORING      Audio Record : ON

Picture quality	File Size	Recording Time Intervals (Sec), Recording Time Period														
		1/60	1/30	1/15	1/10	1/5	1/3	1/2	1	2	3	5	10	20	30	60
Level 1	64KB	–	34	68	101	198	321	463	835	1389	1791	2315	2979	3478	3680	3911
Level 2	40KB	–	54	106	158	306	488	687	1184	1840	2269	2767	3329	3705	3846	4003
Level 3	32KB	–	66	131	194	373	589	820	1375	2063	2491	2960	3465	3787	3905	4034
Level 4	24KB	–	87	171	252	477	744	1016	1640	2347	2760	3181	3612	3874	3966	4066
Level 5	16KB	–	126	245	358	664	1008	1335	2032	2723	3094	3438	3772	3964	4028	4099

Disk Mode : MIRRORING      Audio Record : OFF

Picture quality	File Size	Recording Time Intervals (Sec), Recording Time Period														
		1/60	1/30	1/15	1/10	1/5	1/3	1/2	1	2	3	5	10	20	30	60
Level 1	64KB	–	34	69	104	209	349	523	1047	2095	3142	5237	10475	20950	31425	62850
Level 2	40KB	–	55	110	166	332	553	830	1660	3321	4982	8303	16606	33213	49820	99641
Level 3	32KB	–	68	137	206	412	687	1031	2063	4126	6189	10316	20632	41265	61898	123796
Level 4	24KB	–	90	181	272	544	907	1361	2723	5447	8170	13617	27235	54470	81705	163411
Level 5	16KB	–	133	267	400	801	1335	2002	4005	8010	12015	20025	40051	80103	120155	240311

**Note**

Setting the Disk Setting's Disk Mode to "MIRRORING" limits the maximum recording interval to 1/30 second. (Refer to p. 15;"Disk Setting.")

## 16. EXTERNAL TERMINAL SPECIFICATIONS

### 16.1. RS-232C Communication Specifications

The Digital Video Recorder's RS-232C interface permits remote control using a connected PC.

#### Note

- Control software is not supplied as standard.
- Communication specifications are those set when the Switcher Synchronization selection on the Communication Setting Screen is set to "OFF."
- TOA takes no responsibility for any inconvenience or damage to customer hardware or software which may result from the use of control software based on the specifications described in this section.

#### 16.1.1. The Rules of Overall Communications

1. All communications are established by means of a command from the controller.
2. Responses are always present in mutual communications.
3. The response timeout period is 1 second, and the timeout period between continuous data is 100 milliseconds. When the timeout occurs, the corresponding communications are regarded as failed.
4. Data is only updated when a communication setting content update command is received while in Standby mode or in Idle and Recording Pause mode. No setting content update commands are accepted during system activation, error message indication, menu screen display, search screen display, playback, recording (Include Alarm Recording Setting's Alarm is set to "VALID.") or while in timer mode (DEL is returned).
5. When command operation cannot be performed, received data is discarded and any commands are regarded as invalid.

#### 16.1.2. Communication Protocol

Transfer System : Start/stop system (asynchronous system), duplex  
Parity Bit : Even  
Transfer Rate : 9,600, 19,200, 38,400 bps  
Code : Binary code  
Bit Length : 8 bits  
Flow Control : CTS/RTS handshaking, none  
Stop Bit : 1  
Error Control : None

#### 16.1.3. RS-232C Connector Pin Arrangement

The following table shows the signal name of each pin of the RS-232C D-sub 9P connector.

Pin No.	Signal Name
1	Unconnected
2	RXD (Received Data)
3	TXD (Transmitted Data)
4	Unconnected
5	GND
6	Unconnected
7	RTS (Request to send)
8	CTS (Clear to send)
9	Unconnected

**Note:** The plug for the RS-232C connector is not supplied with the Digital Video Recorder.  
Use a cross cable for the RS-232C interface connection.

**16.1.4. RS-232C Communication Format (Controller → Digital Recorder)**

Item	STX	LEN	COMMAND	PARA	DATA	ETX
No. of Byte	1	1	2	2	Variable	1

STX : Fixed to A0H.  
 LEN : The number of bytes from command to DATA  
 COMMAND : BT, MS, MV, LG, SE\*1  
 PARA : Parameter\*1  
 DATA : DATA section (variable depending on a command and parameter)  
 ETX : Fixed to AFH.

\*1 If communication data is transmitted, an ACK, NAK, or DEL signal is returned immediately after the data is received.  
 ACK (06H) : Correct reception  
 NAK (15H) : Reception error  
 DEL (7FH) : Invalid operation

**16.1.5. RS-232C Communication Command (Controller → Digital Recorder)**

Commands are 2 bytes in length. Parameters (PARA) are also 2 bytes. They are followed by the multi-byte DATA section. If DATA LEN is "0," no DATA section follows.

**Key's Commands**

Command	PARA	DATA LEN	Operation
BT	PL	0	Playback Key
	ST	0	Playback Stop Key
	RV	0	Reverse Playback Key
	PS	0	Pause Key
	RD	0	Recording Key
	DC	0	Buzzer Stop Key
	MN	0	Menu Key (Press Menu Key for 1 second or more)
	ON	0	Start Internal Timer Recording (Press Timer key for 1 second or more)
	PO	0	Standby Key ON
	PF	0	Standby Key OFF
	SC	0	Search Key
	QT	0	Periodical Status Inquiry (Response returned)
	AL	0	Alarm Operation
	RS	0	Recording Stop Key (Press Recording Key for 1 second or more)
	KH	0	Recording Start Operation
	UP	0	Up Shift Key
	DW	0	Down Shift Key
	LF	0	- Key
RT	0	+ Key	
SL	0	Select Key	



## Menu Setting Commands

Command	PARA	DATA LEN	Contents	Operation
MS	RQ	1	General Recording Setting Picture Quality	0 – 4 (Level 5 – Level 1)
	RD	1	General Recording Setting Audio	0 : OFF, 1 : ON
	RI	1	General Recording Setting Recording Interval	0:1/60, 1:1/30, 2:1/15, 3:1/10, 4:1/5, 5:1/3, 6:1/2, 7:1, 8:2, 9:3, A:5, B:10, C:20, D:30, E:60
	RC	1	Switcher Control Period	0 – 9 (1,2,3,4,5,10,15,20,30,60)
	TM	1	Setting Frame No.	0 – 9: Setting No.01 – 10
		1	Timer Setting Mode	0:Cancel, 1:Daily, 2:Weekly
		2	Date	First byte MM:1 – C, Second byte DD:1 – 1F
		1	Day of the week	BIT0:Sun, BIT1:Mon, BIT2:Tue, BIT3:Wed, BIT4:Thu, BIT5:Fri, BIT6:Sat
		2	Timer Start Time	First byte HH:0 – 17, Second byte MM:0 – 3B
		2	Timer End Time	First byte HH:0 – 17, Second byte MM:0 – 3B
		1	Internal Timer Recording Setting Picture Quality	0 – 4 (Level 5 – Level 1)
		1	Internal Timer Recording Setting Audio	0:OFF, 1:ON
		1	Internal Timer Recording Setting Recording Interval	0:1/60, 1:1/30, 2:1/15, 3:1/10, 4:1/5, 5:1/3, 6:1/2, 7:1, 8:2, 9:3, A:5, B:10, C:20, D:30, E:60
		1	Recording Pattern	0:1, 1:2
		1	Motion Detection Pattern	0:1, 1:2
	AS	1	Alarm Setting	0: Invalid, 1:Valid, 2:Valid during recording (Val Rec)
	AN	1	Alarm Input Mode	0:Edge, 1:Level
	AP	1	Pre-Alarm Period	0 – 7 (0Sec, 10Sec, 15Sec, 20Sec, 30Sec, 1Min, 2Min, 5Min)
	AT	2	Alarm Recording Period	0 – 9 (10Sec, 15Sec, 20Sec, 30Sec, 1Min, 2Min,, 3Min, 4Min, 5Min, 10Min)
	AF	2	Post-Alarm Period	0 – 7 (0Sec, 10Sec, 15Sec, 20Sec, 30Sec, 1Min, 2Min, 5Min)
	AQ	1	Alarm Recording Picture Quality	0 – 4 (Level 5 – Level 1)
	AD	1	Alarm Recording Audio	0:OFF, 1:ON
	AI	1	Alarm Recording Recording Interval	0:1/60, 1:1/30, 2:1/15, 3:1/10, 4:1/5, 5:1/3, 6:1/2, 7:1
	AB	1	Buzzer Sound Output	0:OFF, 1:ON
	AO	1	Alarm Output Period	0:During Alarm Recording, 1:1Second
	WD	1	Disk Mode (C-DR0101, C-DR0105)	0:Normal, 1:Mirroring
	WM	1	Recording Mode	0:Stop, 1:Re-Rec, 2:Series
	DT	2	Date/Time Setting Year	YYYY:7D0 – 833 (2000 – 2099 Year)
		1	Date/Time Setting Month	MM: 1 – C (Jan – Dec Month)
		1	Date/Time Setting Date	DD: 1 – 1F (1 – 31 Date)
		1	Date/Time Setting Hour	HH: 0 – 17 (00:00 – 23:00 Hour)
		1	Date/Time Setting Minute	MM: 0 – 3B (0 – 59 Minute)
		1	Date/Time Setting Sec	SS: 0 – 3B (0 – 59 Second)
	VQ	1	Picture Quality Display	0: Hide, 1:Display
	VD	1	Audio ON/OFF Display	0: Hide, 1:Display
	VW	1	Re-Recording Mode	0: Hide, 1:Display
	VR	1	Recording Mode Display	0: Hide, 1:Display
	VP	1	Playback Display	0: Hide, 1:Display
	VG	1	Remaining Time Display	Disk Mode set to Normal : 0:Hide, 1:Display Disk Mode set to Mirroring: 0:Hide, 1:Max, 2:Min, 3:HDD-A, 4:HDD-B
	VH	1	Date Display	0: Hide, 1:Display
	VT	1	Time Display	0: Hide, 1:Display
VC	1	Date/Time Display Position	0:Upper Left, 1: Upper Center, 2:Upper Right, 3: Lower Left, 4: Lower Center, 5: Lower Right	
VM	1	Disk Mode Indication (C-DR0101, C-DR0105)	0: Hide, 1:Display	
TR	1	Communication Rate	0: 9600, 1: 19200, 2: 38400 bps	
TF	1	Flow Control	0:OFF, 1:ON	
TS	1	Time Synchronization	0:Master, 1:Slave	
TT	1	Synchronized Time	0 – 23	
TC	1	Switcher Synchronization	0:OFF, 1:ON, 2:Time Sync	
PM	1	Playback Mode	0:All, 1:HDD-A, 2:HDD-B	
PR	1	Simultaneous Recording/Playback	0:Disallow, 1:Allow	
SU	1	Summer Time Setting	0:OFF, 1:ON	
SM	1	Summer Time First day Month	1 – C:Jan – Dec Month	
SW	1	Summer Time First day Sunday	1:Fast, 2:Second, 3:Third, 4:Fourth, 5:Last	
SH	1	Summer Time First day Time	0 – 17:00 – 23 Hour	
EM	1	Summer Time Last day Month	1 – C:Jan – Dec Month	
EW	1	Summer Time Last day Sunday	1:Fast, 2:Second, 3:Third, 4:Fourth, 5:Last	
EH	1	Summer Time Last day Time	0 – 17:00 – 23 Hour	

## Menu Setting Content Request Command

Command	PARA	DATA LEN	Contents	Operation
MV	RQ	0	General Recording Setting Picture Quality	Request to send setting contents
	RD	0	General Recording Setting Audio	Request to send setting contents
	RI	0	General Recording Setting Recording Interval	Request to send setting contents
	RC	0	Switcher Control Period	Request to send setting contents
	TM	1	Timer Setting Data	0 – 9: Setting No., Request to send setting contents
	AS	0	Alarm Setting	Request to send setting contents
	AN	0	Alarm Input Mode	Request to send setting contents
	AP	0	Pre-Alarm Period	Request to send setting contents
	AT	0	Alarm Recording Period	Request to send setting contents
	AF	0	Post-Alarm Period	Request to send setting contents
	AQ	0	Alarm Recording Picture Quality	Request to send setting contents
	AD	0	Alarm Recording Audio	Request to send setting contents
	AI	0	Alarm Recording Recording Interval	Request to send setting contents
	AB	0	Buzzer Sound Output	Request to send setting contents
	AO	0	Alarm Output Period	Request to send setting contents
	WD	0	Disk Mode (C-DR0101, C-DR0105)	Request to send setting contents
	WM	0	Recording Mode	Request to send setting contents
	DT	0	Clock Setting Data	Request to send setting contents (current time)
	VQ	0	Picture Quality Display	Request to send setting contents
	VD	0	Audio Display	Request to send setting contents
	VW	0	Recording Mode Display	Request to send setting contents
	VR	0	Recording Display	Request to send setting contents
	VP	0	Playback Display	Request to send setting contents
	VG	0	Remaining Time Display	Request to send setting contents
	VH	0	Daily Display	Request to send setting contents
	VT	0	Time Display	Request to send setting contents
	VC	0	Date/Time Display Position	Request to send setting contents
	VM	0	Disk Mode Indication (C-DR0101,C-DR0105)	Request to send setting contents
	TR	0	Transmission Rate	Request to send setting contents
	TF	0	Flow Control	Request to send setting contents
	TS	0	Time Synchronization	Request to send setting contents
	TT	0	Synchronized Time	Request to send setting contents
	TC	0	Switcher Synchronization	Request to send setting contents
	PM	0	Playback Mode	Request to send setting contents
	PR	0	Playback during Recording	Request to send setting contents
	SU	0	Summer Time Setting	Request to send setting contents
	SM	0	Summer Time First day Month	Request to send setting contents
	SW	0	Summer Time First day Sunday	Request to send setting contents
	SH	0	Summer Time First day Time	Request to send setting contents
	EM	0	Summer Time Last day Month	Request to send setting contents
EW	0	Summer Time Last day Sunday	Request to send setting contents	
EH	0	Summer Time Last day Time	Request to send setting contents	

## Log Request Command

Command	PARA	DATA LEN	Contents	Operation
LG	RD	0	Request for Recording Log	Request for sending from the head of the most recent data
	RQ	0	Next Request for Recording Log	Request for continued data
	AL	0	Request for Alarm Recording Log	Request for sending from the head of the most recent data
	AQ	0	Next Request for Alarm Recording Log	Request for continued data
	TR	0	Request for Failure Logs	Request for sending from the head of the most recent data
	TQ	0	Next Request for Failure Logs	Request for continued data

## Search Menu Execution Command

Command	PARA	DATA LEN	Contents	Operation
SE	SD	2	Date/Time Search Year	YYYY: 7D0 – 833 (2000 – 2099 Year)
		1	Date/Time Search Month	MM: 1 – C (Jan – Dec Month)
		1	Date/Time Search Date	DD: 1 – 1F (1 – 31 Date)
		1	Date/Time Search Hour	HH: 0 – 17 (00:00 – 23:00 Hour)
		1	Date/Time Search Minute	MM: 0 – 3B (0 – 59 Minute)

**Note:** Date/Time search is performed using setting data.

### 16.1.6. RS-232C Communication Format (Digital Recorder → Controller)

Item	STX	LEN	COMMAND	PARA	DATA	ETX
No. of Byte	1	1	2	2	Variable	1

STX : Fixed to A0H.  
 LEN : The number of bytes from command to DATA  
 COMMAND : BT, MV, LG  
 PARA : Parameter  
 DATA : DATA section (variable depending on a command and parameter)  
 ETX : Fixed to AFH.

### 16.1.7. RS-232C Communication Command (Digital Recorder → Controller)

Commands are 2 bytes in length. Parameters (PARA) are also 2 bytes. They are followed by the multi-byte DATA section.

#### Key response command

Command	PARA	DATA LEN	Contents	Operation	
BT	QT	1	Operation Status	0:Power OFF, 1:Power ON	
		1	Status	0:Standby or Stop 1:Pause 2:Playback 3:Fast Forward Playback 4 Reverse Playback 5:Rewind 6.Menu or Search Screen Display 7:Disk Error or disk operation such as disk recognition	
		1	Recording Status	0:Standby or Stop 1:Recording 2:Alarm Recording 3:Internal Timer Recording	
		1	Failure	0: No failure 1: Hard disk failure 2: Video loss failure 3: Fan failure	

## Menu Setting Content Response Command

Command	PARA	DATA LEN	Contents	Operation	
MV	RQ	1	General Recording Setting Picture Quality	0 – 4 (Level 5 – Level 1)	
	RD	1	General Recording Setting Audio	0 : OFF, 1 : ON	
	RI	1	General Recording Setting Recording Interval	0:1/60, 1:1/30, 2:1/15, 3:1/10, 4:1/5, 5:1/3, 6:1/2, 7:1, 8:2, 9:3, A:5, B:10, C:20, D:30, E:60	
	RC	1	Switcher Control Period	0 – 9 (1,2,3,4,5,10,15,20,30,60)	
	TM	1	Setting Frame No.	0 – 9: Setting No.01 – 10	
		1	Timer Setting Mode	0:Cancel, 1:Daily, 2:Weekly	
		2	Date	First byte MM:1 – C, Second byte DD:1 – 1F	
		1	Day of the week	BIT0:Sun, BIT1:Mon, BIT2:Tue, BIT3:Wed, BIT4:Thu, BIT5:Fri, BIT6:Sat	
		2	Timer Start Time	First byte HH:0 – 17, Second byte MM:0 – 3B	
		2	Timer End Time	First byte HH:0 – 17, Second byte MM:0 – 3B	
		1	Internal Timer Recording Setting Picture Quality	0 – 4 (Level 5 – Level 1)	
		1	Internal Timer Recording Setting Audio	0:OFF, 1:ON	
		1	Internal Timer Recording Setting Recording Interval	0:1/60, 1:1/30, 2:1/15, 3:1/10, 4:1/5, 5:1/3, 6:1/2, 7:1, 8:2, 9:3, A:5, B:10, C:20, D:30, E:60	
		1	Recording Pattern	0:1, 1:2	
		1	Motion Detection Pattern	0:1, 1:2	
		AS	1	Alarm Setting	0:Invalid, 1:Valid, 2:Valid during recording (Val Rec)
		AN	1	Alarm Input Mode	0:Edge, 1:Level
	AP	1	Pre-Alarm Period	0 – 7 (0Sec, 10Sec, 15Sec, 20Sec, 30Sec, 1Min, 2Min, 5Min)	
	AT	2	Alarm Recording Period	0 – 9 (10Sec, 15Sec, 20Sec, 30Sec, 1Min, 2Min,, 3Min, 4Min, 5Min, 10Min)	
	AF	2	Post-Alarm Period	0 – 7 (0Sec, 10Sec, 15Sec, 20Sec, 30Sec, 1Min, 2Min, 5Min)	
	AQ	1	Alarm Recording Picture Quality	0 – 4 (Level 5 – Level 1)	
	AD	1	Alarm Recording Audio	0:OFF, 1:ON	
	AI	1	Alarm Recording Recording Interval	0:1/60, 1:1/30, 2:1/15, 3:1/10, 4:1/5, 5:1/3, 6:1/2, 7:1	
	AB	1	Buzzer Sound Output	0:OFF, 1:ON	
	AO	1	Alarm Output Period	0:During Alarm Recording, 1:1Second	
	WD	1	Disk Mode (C-DR0101, C-DR0105)	0:Nomal, 1:Mirroring	
	WM	1	Recording Mode	0:Stop, 1:Re-Rec, 2:Series	
	DT	2	Date/Time Setting Year	YYYY:7D0 – 833 (2000 – 2099 Year)	
		1	Date/Time Setting Month	MM: 1 – C (Jan – Dec Month)	
		1	Date/Time Setting Date	DD: 1 – 1F (1 – 31 Date)	
		1	Date/Time Setting Hour	HH: 0 – 17 (00:00 – 23:00 Hour)	
		1	Date/Time Setting Minute	MM: 0 – 3B (0 – 59 Minute)	
		1	Date/Time Setting Sec	SS: 0 – 3B (0 – 59 Second)	
	VQ	1	Picture Quality Display	0: Hide, 1:Display	
	VD	1	Audio ON/OFF Display	0: Hide, 1:Display	
	VW	1	Re-Recording Mode	0: Hide, 1:Display	
	VR	1	Recording Mode Display	0: Hide, 1:Display	
	VP	1	Playback Display	0: Hide, 1:Display	
	VG	1	Remaining Time Display	Disk Mode set to Nomal : 0:Hide, 1:Display Disk Mode set to Mirroring: 0:Hide, 1:Max, 2:Min, 3:HDD-A, 4:HDD-B	
	VH	1	Date Display	0: Hide, 1:Display	
	VT	1	Time Display	0: Hide, 1:Display	
	VC	1	Date/Time Display Position	0:Upper Left, 1: Upper Center, 2:Upper Right, 3: Lower Left, 4: Lower Center, 5: Lower Right	
	VM	1	Disk Mode Indication (C-DR0101, C-DR0105)	0: Hide, 1:Display	
	TR	1	Communication Rate	0: 9600, 1: 19200, 2: 38400 bps	
	TF	1	Flow Control	0:OFF, 1:ON	
	TS	1	Time Synchronization	0:Master, 1:Slave	
	TT	1	Synchronized Time	0 – 23	
TC	1	Switcher Synchronization	0:OFF, 1:ON, 2:Time Sync		
PM	1	Playback Mode	0:All, 1:HDD-A, 2:HDD-B		
PR	1	Simultaneous Recording/Playback	0:Disallow, 1:Allow		
SU	1	Summer Time Setting	0:OFF, 1:ON		
SM	1	Summer Time First day Month	1 – C:Jan – Dec Month		
SW	1	Summer Time First day Sunday	1:Fast, 2:Second, 3:Third, 4:Fourth, 5:Last		
SH	1	Summer Time First day Time	0 – 17:00 – 23 Hour		
EM	1	Summer Time Last day Month	1 – C:Jan – Dec Month		
EW	1	Summer Time Last day Sunday	1:Fast, 2:Second, 3:Third, 4:Fourth, 5:Last		
EH	1	Summer Time Last day Time	0 – 17:00 – 23 Hour		

## Log Content Response Command

Command	PARA	DATA LEN	Contents	Operation
LG	RD	13	Request for Recording Log	Request for sending from the head of the most recent data
	RQ	13	Next Request for Recording Log	Request for continued data
	AL	13	Request for Alarm Recording Log	Request for sending from the head of the most recent data
	AQ	13	Next Request for Alarm Recording Log	Request for continued data
	TR	13	Request for Failure Logs	Request for sending from the head of the most recent data
	TQ	13	Next Request for Failure Logs	Request for continued data

Shown below are log information DATA section (13 bytes) formats.

DATA LEN	Contents	Description of Data
1	Data valid/invalid	0: Invalid, 1: Valid
2	Year	YYYY: 7D0 – 833 (2000 – 2099 Year)
1	Month	MM: 1 – C (Jan – Dec Month)
1	Date	DD: 1 – 1F (1 – 31 Date)
1	Time	HH: 0 – 17 (00:00 – 23:00 Hour)
1	Minute	MM: 0 – 3B (0 – 59 Minute)
1	Second	SS: 0 – 3B (0 – 59 Second)
4	Detailed Code	RD/RQ mode: 0: Recording Start, 1:Recording End, 2:Internal Timer Recording Start, 3: Internal Timer Recording End AL/AQ mode: 0: Alarm Recording Start, 1: Alarm Recording End TR/TQ mode: 65 – C8 Video Failure, C9 – 12C: HDD Failure, 12D: Fan Failure
1	Continuation sign	FE:DATA follows, FF: No DATA follows

When transmitting log data, DATA contained in LEN (up to 255 bytes) is set in 13-byte units. If DATA's 13th byte is a continuation sign (0xFE), DATA follows. If last DATA is a continuation sign, a continued log acquisition command becomes valid. Transmission format and transmitting/receiving sequence are as follows:

Item	STX	LEN	COMMAND	PARA	DATA	DATA .....	DATA	ETX
No. of Byte	1	1	2	2	13	13 .....	13	1

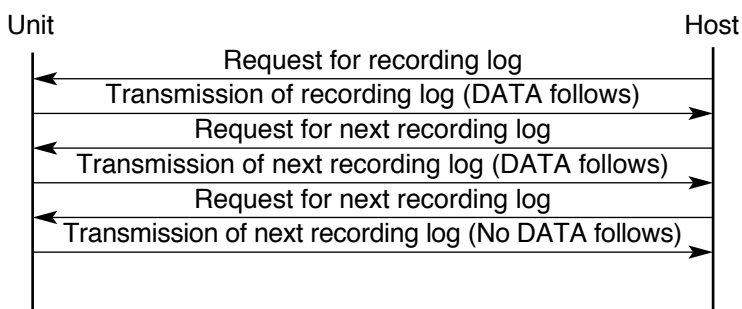

## Search menu result command

Command	PARA	DATA LEN	Contents	Operation
SV	SD	1	Time Search Execution Result	0 : No corresponding Data is present. 1 : Corresponding Data is present.

### Note

This response is transmitted to a controller when an ACK signal has been returned in response to a SE command.

## 16.2. About the Ethernet Terminal

The Digital Video Recorder is equipped the Ethernet terminal (100BASE-TX). Use the LAN (crossing) cable to connect the Ethernet terminal to the PC.

## 17. RACK MOUNTING

Use the optional MB-15B Rack Mounting Bracket when mounting the Digital Video Recorder in an equipment rack. Remove 4 rubber feet on the bottom surface by loosening their respective fixing screws with a standard screwdriver.

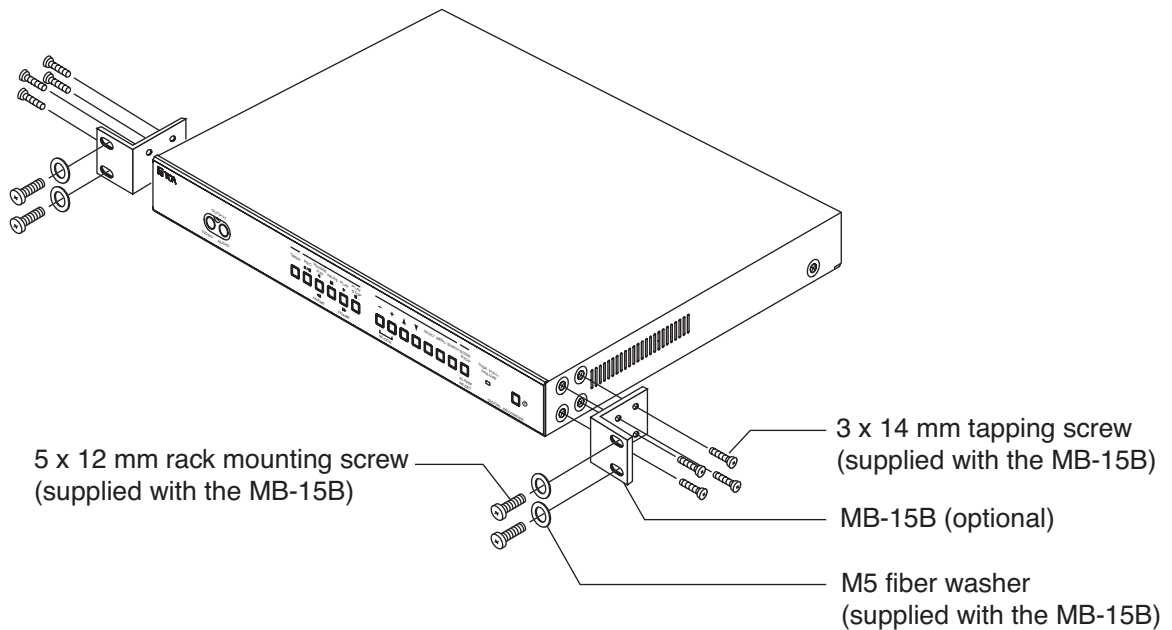

### Note

- Use the Digital Video Recorder in locations with ambient temperature of between +5°C and +40°C
- Be sure to mount the Digital Video Recorder below the heat generating components, and mount the perforated panel between the Recorder and such a heat generating component as required.
- The Digital Video Recorder has a built-in cooling fan. Never block the Recorder's ventilation slot.
- Avoid installing the Digital Video Recorder in locations exposed to vibration.

## 18. IF YOU THINK THERE IS A FAILURE: (TROUBLESHOOTING)

Symptom	Possible Cause	Remedy
Cannot switch on the power.	<ul style="list-style-type: none"> <li>The supplied power cord is not connected to the Digital Video Recorder's Power inlet and wall AC outlet.</li> </ul>	<ul style="list-style-type: none"> <li>Connect the power cord.</li> </ul>
Cannot operate the front panel-mounted keys.	<ul style="list-style-type: none"> <li>Keys are locked.</li> </ul>	<ul style="list-style-type: none"> <li>Release Key Lock.</li> </ul>
No picture is displayed.	<ul style="list-style-type: none"> <li>Power is not switched on.</li> <li>Cables are not correctly connected.</li> </ul>	<ul style="list-style-type: none"> <li>Switch on the power.</li> <li>Connect the cable correctly.</li> </ul>
The Recorder is not activated even if the Standby key is pressed.	<ul style="list-style-type: none"> <li>Main power is not switched on.</li> </ul>	<ul style="list-style-type: none"> <li>Switch on the main power.</li> </ul>
The Recorder is not terminated even if the Standby key is pressed.	<ul style="list-style-type: none"> <li>The Standby key is not continuously pressed for 1 second or more.</li> </ul>	<ul style="list-style-type: none"> <li>Hold down the Standby key for 1 second or more.</li> </ul>
Cannot record.	<ul style="list-style-type: none"> <li>Recording mode is set to "STOP" and no available hard disk time remains.</li> </ul>	<ul style="list-style-type: none"> <li>Change the Overwrite Recording setting to "RE-REC" or "SERIES."</li> </ul>
Cannot stop recording.	<ul style="list-style-type: none"> <li>Key Lock is set to ON.</li> </ul>	<ul style="list-style-type: none"> <li>Reset Key Lock</li> </ul>
Cannot perform Internal Timer recording.	<ul style="list-style-type: none"> <li>The Recorder is in General recording mode.</li> <li>Incorrect timer setting.</li> <li>Recording mode is set to "SERIES."</li> </ul>	<ul style="list-style-type: none"> <li>Stop General recording and press the Timer key.</li> <li>Set timer operating times correctly.</li> <li>Change the Recording mode to "STOP" or "RE-REC."</li> </ul>
Cannot perform Alarm recording.	<ul style="list-style-type: none"> <li>Alarm input cord not correctly connected.</li> <li>Alarm not set to "VALID."</li> </ul>	<ul style="list-style-type: none"> <li>Connect cords correctly.</li> <li>Set the Alarm setting to "VALID."</li> </ul>
No voice or sound recorded.	<ul style="list-style-type: none"> <li>Each Recording Mode Audio Setting selection not set to ON.</li> </ul>	<ul style="list-style-type: none"> <li>Set Audio setting to "ON."</li> </ul>
Cannot perform search and playback.	<ul style="list-style-type: none"> <li>Hard disk is initialized.</li> <li>Not recorded on the hard disk.</li> <li>Playback during Recording is set to "OFF."</li> </ul>	<ul style="list-style-type: none"> <li>Search and playback cannot be performed without recording data. Perform recording.</li> <li>Playback cannot be performed during recording. Set the Playback during Recording selection to "ON"</li> </ul>
No screen indication displayed.	<ul style="list-style-type: none"> <li>Display setting set to "HIDE."</li> </ul>	<ul style="list-style-type: none"> <li>Set Display setting to "DISP."</li> </ul>
On-screen time is not accurate.	<ul style="list-style-type: none"> <li>Time not adjusted.</li> <li>Power was switched off for a long period of time.</li> </ul>	<ul style="list-style-type: none"> <li>Adjust times.</li> <li>If no main power is supplied continuously for 30 days or more, clock data will be lost. In such cases, update times again.</li> </ul>
System failure indicator does not extinguish.	<ul style="list-style-type: none"> <li>Check to confirm the contents of failure log (refer to p. 25).</li> </ul>	<ul style="list-style-type: none"> <li>Remove the cause of the failure.</li> </ul>
The indication "Disk may have failed" is displayed on the screen.	<ul style="list-style-type: none"> <li>Hard disk format data may have been damaged.</li> <li>Hard disk may have failed. Referring to p. 28; "When the Failure Screen is displayed," check the symptom.</li> </ul>	<ul style="list-style-type: none"> <li>If the situation cannot be improved, contact your TOA dealer.</li> </ul>

## 19. SPECIFICATIONS

\* 0dB = 1V

Model	C-DR0100	C-DR0101	C-DR0105
Power Source	110 – 120 V AC 50/60 Hz		
Power Consumption	24 W (450 mA)	35 W (640 mA)	37 W (670 mA)
Image Compression System	Motion JPEG		
Recording Medium	E-IDE Hard Disk 120 GB (120 GB x 1)	E-IDE Hard Disk 240 GB (120 GB x 2)	E-IDE Hard Disk 500 GB (250 GB x 2)
Video Input	1 Input VBS1.0 V(p-p), 75Ω, BNC		
Video Output	Front: 1 Output VBS1.0V(p-p), 75Ω, RCA pin jack Rear: 1 Output VBS1.0V(p-p), 75Ω, BNC		
Switcher Video Input	1 Input VBS1.0V(p-p), 75Ω, BNC		
Switcher Video Output	1 Output VBS1.0V(p-p), 75Ω, BNC		
Audio Recording System	8 bits, Linear PCM, sampling frequency: 16 KHz		
Audio Input	1 Input, -10 dB*, 10 kΩ, RCA pin jack		
Audio Output	Front: 1 Output, -10 dB*, 600 Ω, RCA pin jack Rear: 1 Output, -10 dB*, 600 Ω, RCA pin jack		
Frequency Response	300 – 6,000 Hz		
Alarm Input	1 Input (EDGE, LEVEL), no-voltage make contact input, open voltage: 2 VDC, short-circuit current: 0.5 mA, loop resistance: under 100Ω, screwless connector		
Alarm Output	1 output, open collector output, withstand voltage: 30 VDC, control current : 20 mA, screwless connector		
Picture Quality	Changeable in 5 steps, File size: 64 KB (LEVEL1), 40 KB (LEVEL2), 32 KB (LEVEL3), 24 KB (LEVEL4), 16 KB (LEVEL5)		
Pixels	720 x 240 (fixed)		
Recording Intervals	15 steps (1/60, 1/30, 1/15, 1/10, 1/5, 1/3, 1/2, 1, 2, 3, 5, 10, 20, 30, 60 sec)		
Pre-Alarm Recording	0 sec, 10 sec, 15 sec, 20 sec, 30 sec, 1 min, 2 min, 5 min		
Alarm Recording	10 sec, 15 sec, 20 sec, 30 sec, 1 min, 2 min, 3 min, 4 min, 5 min, 10 min (Edge mode)		
Post Alarm Recording	0 sec, 10 sec, 15 sec, 20 sec, 30 sec, 1 min, 2 min, 5 min (Level mode)		
Date/Time	Year/ month/ date/ hour/ minute/ sec, 24-hours format display, monthly deviation of within ±30 seconds (25°C), can be operated until the leap year 2099, summer time settings		
Internal Timer Recording	10 independent programs (date, daily, weekly, designated day-of-the-week) recording interval, start and end times, picture quality, and audio on-off can be set.		
Search Function	Date/Time search, Block search, Time Shift search		
System Failure Output	1 output (HDD failure, Video loss, Fan failure) open collector output withstand voltage: 30 VDC, control current: 20 mA, screwless connector		
Control Input Terminal	alarm reset, recording start, recording stop, clock synchronization no-voltage make contact input, open voltage: 2 VDC, short-circuit current: 0.5 mA, loop resistance: under 100 Ω, screwless connector		
Control Output Terminal	alarm reset, clock synchronization, disk full : open collector output, withstand voltage: 30 VDC, control current: 20 mA, screwless connector switcher control: TTL level negative logic pulse, pulse width over 17 ms, screwless connector		
Communication Function	RS-232C (External control function) D-sub connector (9 pin, male) 100 BASE-TX Ethernet terminal		
Memory Backup	720 hours (fully charged), clock data retention		
Operating Temperature	+5°C to +40°C		
Operating Humidity	Under 80% RH (no dew condensation)		
Finish	Panel: Aluminum extrusion, black, 30% gloss Case: Surface treated steel plate, black, 30% gloss		
Dimensions	420 (W) x 53.8 (H) x 331 (D) mm		
Weight	4.5 kg	5.3 kg	5.3 kg
Accessories	Power supply cord (2 m) ... 1		
Optional Equipment	Rack mounting bracket: MB-15B		

**Note:** The Digital Video Recorder's specifications and external designs are subject to change without notice.



## Free Manuals Download Website

<http://myh66.com>

<http://usermanuals.us>

<http://www.somanuals.com>

<http://www.4manuals.cc>

<http://www.manual-lib.com>

<http://www.404manual.com>

<http://www.luxmanual.com>

<http://aubethermostatmanual.com>

Golf course search by state

<http://golfingnear.com>

Email search by domain

<http://emailbydomain.com>

Auto manuals search

<http://auto.somanuals.com>

TV manuals search

<http://tv.somanuals.com>