



B/W CCD Camera

CS3950D

Specification

Contents

1. Product Description	1
2. Features	1
3. Configuration	2
4. Option Unit	2
5. Operation Mode	2
6. Specifications	7
7. Timing Chart	14
8. External View Drawing	16

TOSHIBA TELI CORPORATION

BEFORE USE - GENERAL SAFETY INSTRUCTIONS



This instruction manual contains important information for the operator (user) and/or people around him/her to avoid personal injuries, or property damages against him/her or people around him/her by using this product correctly.

- Prior to use, read this operation manual carefully to fully understand its instructions for correct use.
- After reading, keep this manual by the side of your equipment for your future reference.

WARNINGS & CAUTIONS

[Definition of markings]





The meaning of each mark used in this instruction manual is given below.

 DANGER	This mark warns the user that improper use, indicated with this mark, may cause death or severe personal injuries against the user or people around him/her.
 CAUTION	This mark warns the user that improper use, indicated with this mark, may cause personal injuries (*1) or material damages (*2) against the user or people around him/her.









Notes

*1 : Personal injuries mean wounds, burns, electric shocks, and others for which the person injured need not to be hospitalized nor to be cared for the long term.



*2 : Material damages mean any direct or consequential damages related to property or material loss.

	This mark indicates what the user SHOULD NOT DO . The details of things which the user should not do are described next to this mark.
	This mark indicates what the user MUST DO . The details of things which the user must do are described next to this mark.
	This mark indicates that the user must be alert against a possible DANGER . The details of the danger which the user must be aware of are described next to this mark.
	This mark indicates that the user are given a CAUTION against possible hazards. The details of the caution which the user must be aware of are described next to this mark.









⚠ DANGER

 Unplug	<p><u>If any overheating sign is observed, discontinue the use immediately.</u></p> <p>In the event that smoke, smell, or any other overheating sign is observed, turn its power switch OFF immediately, and remove your plug from outlet. Do NOT try to continue to use this device. To do so in spite of clear signs of malfunction invites a fire, an electric shock hazard, or a serious damage. In such case, contact us or our dealer /distributor from which you purchased this device for repair service.</p>
 Unplug	<p><u>If any malfunctioning sign is observed, discontinue the use immediately.</u></p> <p>Do NOT try to use this device when it is obviously malfunctioning. (Example: No images on the monitor) In the event of malfunction, turn its power switch OFF immediately, and remove the plug from the outlet. In such case, contact us or our dealer/distributor from which you purchased this device for repair service.</p>
 Unplug	<p><u>If any liquid gets into the device, discontinue the use immediately.</u></p> <p>In the event that water, or any other type of liquid gets into the body, do NOT try to continue to use the device. To do so invites a fire or an electric shock hazard. In that case, turn its power switch OFF immediately, and then remove the plug from the outlet. After that, contact us or our dealer/distributor from which you purchased this device for repair service/technical advice.</p>
 Unplug	<p><u>If any foreign object gets into the body, discontinue the use immediately.</u></p> <p>In the event that grits, small particles, or any other foreign objects get inside, do NOT try to continue to use the device. To do so invites a fire or an electric shock hazard. In that case, turn its power switch OFF immediately, and then remove the plug from the outlet. After that, contact us or our dealer/distributor from which you purchased this device for repair service/technical advice.</p>
 Unplug	<p><u>If any outer strong impact is given to this device, discontinue the use immediately.</u></p> <p>In the event that this device is dropped onto the ground, or its cabinet is damaged, turn its power switch OFF immediately, and remove the plug from the outlet. Do NOT try to continue to use the device. To do so invites a fire or an electric shock hazard. In such case, contact us or our dealer/distributor from which you purchased this device for repair service.</p>
 NEVER pull apart	<p><u>Do NOT disassemble this device.</u></p> <p>Do NOT attempt to pull apart, repair, or modify the device on your own. To do so might lead to a fire or an electric shock accident. Contact us or the dealer/distributor from which you purchased the device for repair/modification.</p>
 Avoid	<p><u>Do NOT supply any power other than specified.</u></p> <p>This device is designed to work only under specified voltage. Do NOT attempt to supply the device with power other than specified. Supplying the device with unspecified power invites a fire or an electric shock hazard.</p>
 Avoid	<p><u>Do NOT place the device unstably.</u></p> <p>Do NOT place the device on an unstable table, sloped ground, etc.. Make sure that the device do not fall nor roll over to prevent an accident.</p>
 Avoid	<p><u>Do NOT remove the protective cover</u></p> <p><u>Avoid removing its protective cover. If you touch the inner high-voltage part, you might get an electric shock. For inner part/circuit checkup, maintenance, or repair, contact us or the dealer/distributor from which you purchased this device.</u></p>

DANGER

 Avoid	<p><u>Do NOT place any potentially-hazardous things on this device.</u></p> <p>Do NOT place any things on the device which may, if it gets into the inside of the body, damage the inner parts of the device (such as a flower pot, glass, cosmetics, a container filled with liquids or chemicals, as well as small metal parts, etc.). If tumbled, the liquids inside the bottle, etc. may get into the chassis, causing a fire or an electric shock accident.</p>
 Avoid	<p><u>Do NOT damage the power cord.</u></p> <p>Do NOT damage, break, re-process, nor bend forcefully the power cord. Pulling forcefully/Twisting/Placing a heavy object on/Applying heat on the cord should also be avoided. Otherwise, the cord may be damaged, causing a fire or an electric shock accident. If the cord is damaged, contact us or our dealer/distributor from which you purchased this device for repair service.</p>

CAUTION

 Unplug	<p><u>Unplug the power-plug when the your device is not in use.</u></p> <p>For safety, make sure to unplug the power-plug before you give your device a cleanup, or when it is not used. Keeping the power-cord connected might invite a fire or an electric shock hazard.</p>
 Avoid	<p><u>Do NOT expose your device to direct sunlight, nor intensive heat.</u></p> <p>Do NOT place this device where it is exposed to direct sunlight, or in a high temperature condition. To do so may cause the inner temperature of the device to go up, resulting in burning-down of inner parts, circuits or a fire accident.</p>
 Avoid	<p><u>Do NOT connect/disconnect connectors before turning power off.</u></p> <p>Make sure to check the camera power is OFF before connecting/disconnecting connectors. Otherwise, you might get an electric shock, or your camera might break down.</p>
 Avoid	<p><u>Do NOT attempt to make connection before turning power off</u></p> <p>Make sure to check the camera power is OFF before connection. Otherwise, you might get an electric shock.</p>
 Avoid	<p><u>Do NOT pull the cord itself</u></p> <p>When disconnecting the power-plug out of the outlet, make sure to hold the plug, and then pull it out. Do NEVER try to pull the cord itself. Otherwise, the cord may be damaged or broken, leading to a fire or an electric shock accident.</p>
 Avoid	<p><u>Do NOT place your device too close to a heater.</u></p> <p>Do NOT place your device or its power cord too close to any heating appliance. Otherwise, the coating of its switch and/or power-cord may melt, leading to a fire or an electric shock accident.</p>
 Avoid	<p><u>Do NOT use chemical solvent for cleanup.</u></p> <p>When giving your camera a cleanup, avoid using a benzene, alcohol, and thinner. These chemicals might cause its coating or markings to come off or become degraded.</p>
 Avoid	<p><u>Do NOT handle the power cord with your hand in an wet condition.</u></p> <p>Do NOT plug in/out the power cord with an wet hand. Otherwise, it may cause an electric shock accident.</p>

This device complies with Part15 of the FCC rules. Operation is subject to the following two conditions: (1) This device may not cause harmful interference, and (2) This device must accept any interference received, including interference that may cause undesired operation.

RESTRICTION FOR USE

Avoid irregular signal interface.

Do not attempt irregular signal interface other than specified. Under signal interface other than recommended/specified in this instruction manual, the device might fail to exert the maximum performance. In much worse case, if you continue to use your device under incorrect signal interface, part(s) of inner circuits might burn down.

DISCRAMER (RIMITED WARRANTY)

We disclaim any responsibility and shall be held harmless for damages or losses incurred by user(s) in either of the following cases.

- 1.In case damages or losses are caused by fire, earthquake, or other acts of Gods, the act by third party, misuse by the user deliberately or erroneously, use under extreme operating conditions.
- 2.In case any indirect, additional, consequential damages (loss of expected interest, suspension of business activities) are incurred as results of malfunction or non-function of this device, we shall be exempted from assuming responsibility for such damages.
- 3.In case damages or losses are caused by incorrect use which is not in line with the instructions given in this instruction manual.
- 4.In case damages or losses are caused by malfunction resulting from bad connection with other equipment.
- 5.In case damages or losses are caused by repair or modification done by the user.

OTHER INSTRUCTIONS

Do NOT use power other than specified

Be sure to use DC12V power supply. The camera is designed to work only under the specified voltage. Do NOT attempt to drive the camera with the power other than DC12V. Operating the camera under power other than DC12V invites a fire or an electric shock hazard.

Avoid intensive light

Do NOT expose the camera's image-pickup-plane to sunlight or other intense light directly. If the part of CCD is exposed to spot-intensive light, you might get a picture problem like blooming and/or smear. Under the comparison at the same video output level, the faster the electronic shutter speed setting, the more smear is generated.

Use under right operation condition

This equipment is designed and guaranteed to work under the temperature range of 0 to 40 degrees C and 30 through 90% humidity range. Avoid using the equipment beyond that limits.

Handle with care

Take care not to drop the equipment, nor give strong impact, as this may cause breakdown.

Do NOT tamper with switches

Read this operation guide thoroughly before you touch switches and adjusters on the rear panel. Do NEVER attempt to disassemble the camera and/or tamper with any inner switches, potentiometers, etc.

Avoid liquid

Avoid placing the camera where it is likely to be splashed with water or any other fluids. Operating the camera with its inner parts/circuits in an wet condition might cause a damage or an electric shock accident.

Avoid placing near TV/radio

This camera might cause an interference (e.g. noise) if used around radio / TV set. In such a case, change the location of your camera (or radio / TV).

Abnormal operation

In the event that any abnormal condition is observed, turn the power switch OFF immediately. Do NOT try to continue to use the camera. To do so reckless of visible signs of malfunction invites a fire, an electric shock hazard, or any other serious damage to the camera. In such case, contact us or our dealer/distributor from which you purchased the camera for repair service.

Camera installation

For mounting this camera, use screws having inner depth (the portion which go inside the camera chassis side) shorter than 3.5mm for M3.0, 4 places or 3.0mm for M2.0, 4 places. Longer screws contact and might damage inner boards/parts.

Waste treatment

Wastes of this product should be separated and discarded in compliance with the various national and local ordinances.

1. PRODUCT DESCRIPTION

Model CS3950D is an integrated type B/W CCD camera with a XGA format all-pixel-data readout CCD. The model is suited for high-speed, high-resolution image processing use. Its compact, light-weight body is ideal for system integration.

2. FEATURES

- (1) All pixel's data readout
With its built-in all-pixel-data-readout CCD, this model can read out image-data just in approximately 1/30 sec. A frame-shutter reads out all data even under RTS (Random Trigger Shutter) mode.
- (2) High resolution
XGA (1024 x 768 pixels) 800k CCD
- (3) Square grid pattern CCD
Pixel's in CCD are aligned in square grid pattern. This makes it easier to perform computation correctly for image processing use.
- (4) External Sync.
The camera is switched over to external synchronization operation automatically when external HD signal is input.
- (5) Random trigger shutter function
With a built-in RTS, the camera's CCD starts light-exposure in synchronization with external trigger signals. This function enables the camera to capture fast-moving subjects at constant position for precise image processing.
- (6) Restart / Reset
Under the restart / reset mode, this model can capture images at an arbitrary timing cued by external VD signal.
- (7) Partial-scan
Under the partial scan mode, only 1/2 or 1/4 screen center portion of image information is read out, resulting in a faster operation.
- (8) Compact & light-weight camera
The model features its compact and light-weight camera, freeing you from your integration-space-problem. In addition, it has an excellent shock and vibration resistance.

3. CONFIGURATION

- (1) Camera body..... 1
- (2) Accessory
Operation Manual(English)..... 1

4. OPTION UNIT

- (1) DC SYNC IN cableModel name : CPRC3700 [2m,3m,5m,10m]
- (2) Camera adapterModel name : CA170
- (3) Camera-mounting kit.....Model name : CPT

*Contact your dealer / distributor for details of option units.

*Conformity of an option part and EMC conditions

About the conformity of EMC standard of this machine, it has guaranteed in the conditions combined with the above-mentioned option part.

When used combined parts other than specification of our company, I ask you to have final EMC conformity checked of a visitor with a machine and the whole equipment.

5. OPERATION MODE

- (1) GAIN selection (Camera rear-panel SW)

Switches sensitivity setting

(1-1) FIX -----Factory-prefixed gain

(1-2) MANU -----Gain is adjustable via the manual gain potentiometer (M.GAIN)

- (2) TRIG selection (Camera rear-panel DIP SW)

Switches TRIG input signal polarity used under RTS mode

(2-1) POSI----- Positive polarity (rising edge detection)

(2-2) NEGA----- Negative polarity (falling edge detection)

- (3) RTS (Random Trigger Shutter) exposure selection (Camera rear-panel DIP SW)

Switches light exposure mode under RTS mode

(3-1) FIX mode----- Rear DIP SW

Exposure-time control via rear-panel DIP switch

(3-2) PULSE W mode---- TRIG signal pulse width control

Exposure-time control via TRIG signal pulse width

- (4) Shutter mode selection (Camera rear-panel DIP SW or TRIG signal IN [Automatic])

Switches shutter mode

(4-1) NOR mode -----Normal electronic shutter

Exposure control via internal sync signal

High-speed shutter: From 1/100,000s through OFF (12 position)

(4-2) RTS mode -----Random trigger shutter

Exposure control via ext. trigger or ext. sync input

Timing charts are shown below. (TRIG timing: Positive)

Notes: * RTS selection is automatic with TRIG status

** Neither under FIX nor PULSE W mode, RTS doesn't work if Electronic shutter speed SW is set in OFF position.

- (a) Non-reset mode (Under internal sync / external sync --- Consecutive VD IN)
 Exposure starts at the timing of TRIG signal IN. After each exposure is completed, the camera outputs video at each next VD IN timing.

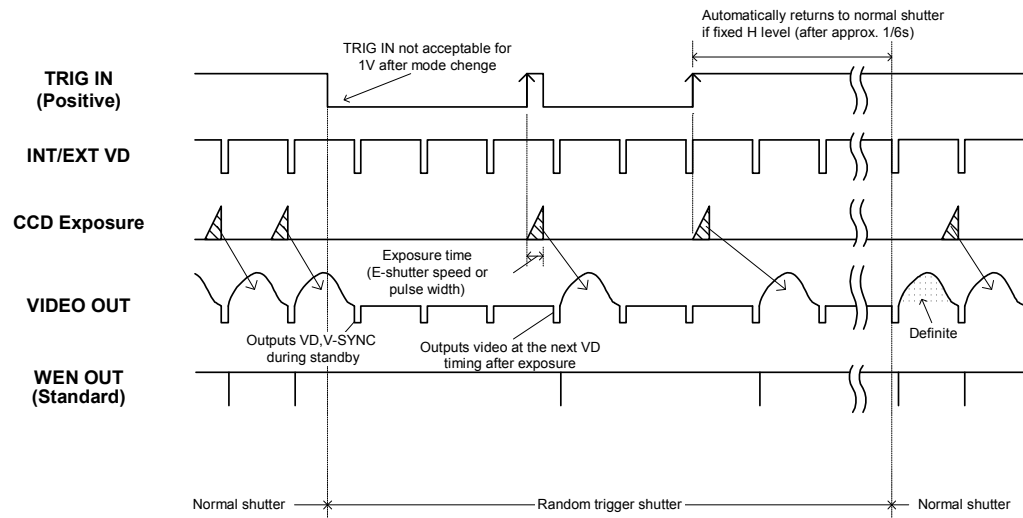

- (b) Non-reset mode (Under external sync --- Single VD IN)
 After TRIG IN and exposure, the camera goes into standby until next ext. VD IN.

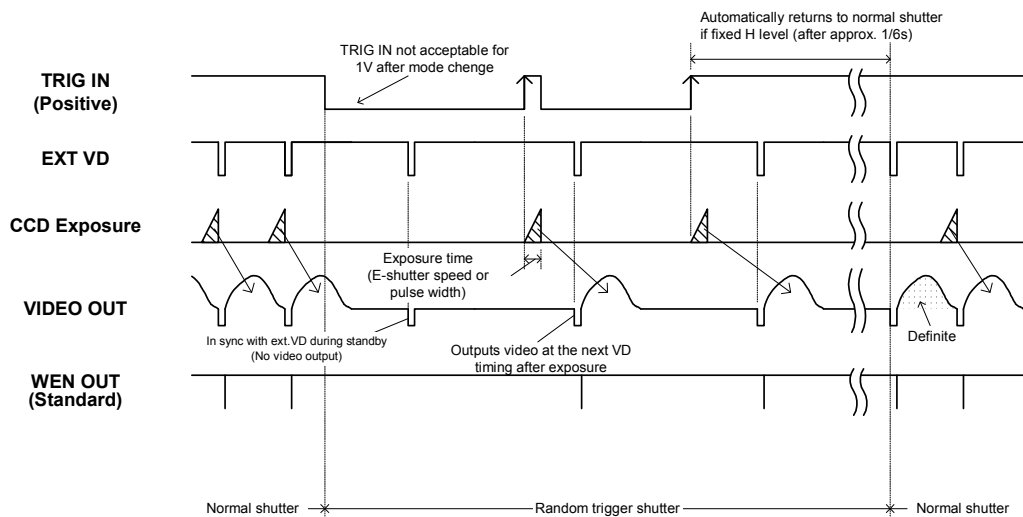

*Don't provide ext. VD IN during exposure.
 ** After automatic return, fix ext. VD IN at Hi.

- (c) V-reset mode (Under internal sync / external sync --- No VD IN)
 Exposure starts at the timing of TRIG signal IN. After each exposure is completed, the camera outputs video immediately by resetting VD. (HD is not reset)

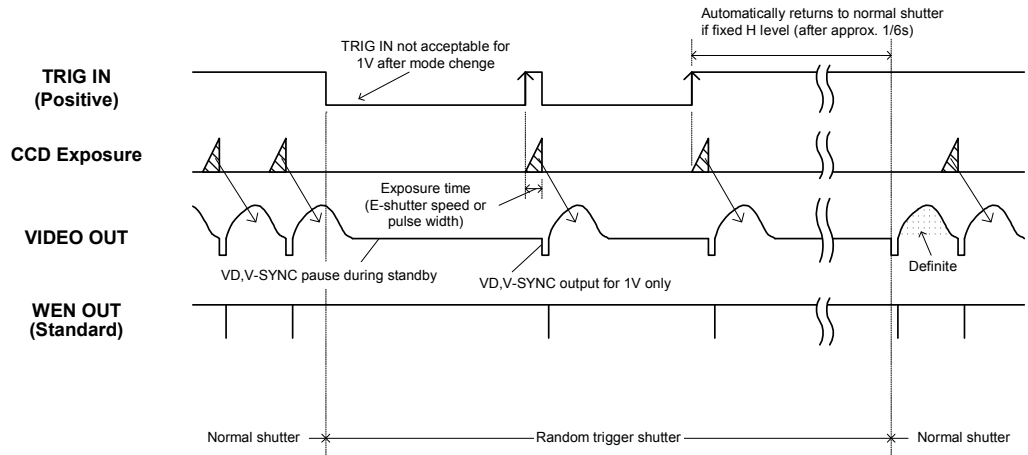

■ Exposure time delay under RTS

When the RTS is active, both in FIX mode and PULSE W mode, there is a time delay of approximately 1.4 micro s until the start of exposure after the rising edge of TRIG signal (positive).

■ Exposure time under pulse width mode

Under RTS pulse mode, the exposure time is determined by the pulse width. More exactly, the actual time is the pulse width plus approximately 8.0 micro s.

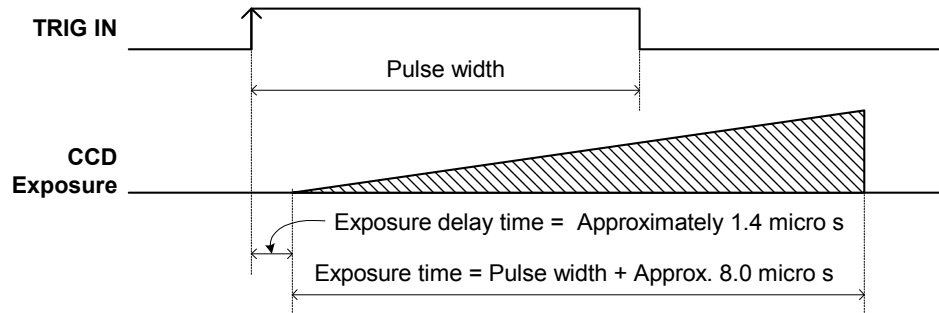

(4-3) Restart / Reset

The restart / reset function is available with the ext.VD signal. You can get an arbitrary slower shutter speed than normal shutter and random trigger shutter.

Here are some notes;

- * The shutter speed (exposure time) is determined by ext. VD signal interval.
- ** This function is enabled when the rear-panel shutter speed DIP SW is OFF.
- *** Supply consecutive HD.

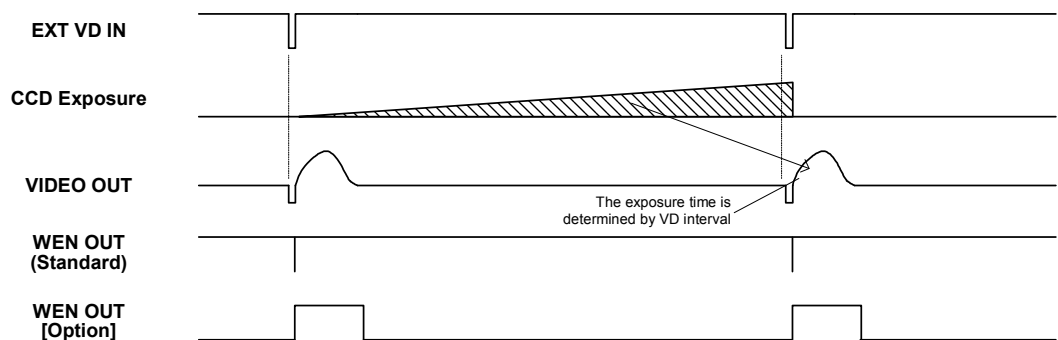

(5) Partial-scan mode selection (Camera rear-panel DIP SW)
Switches partial-scan mode

Note: Sometimes phenomenon called as “whiteout” occurs at the top of the screen when there is strong incident light entering in the wide area of a CCD, however, this is not a malfunction. If this occurs, reduce the amount of incoming rays.

(5-1)1/2 Partial-scan --- Screen center 1/2 readout

Only the center portion of 344H out of the total effective lines 768H (excluding BLK time) is read out. Available both under external / internal mode.

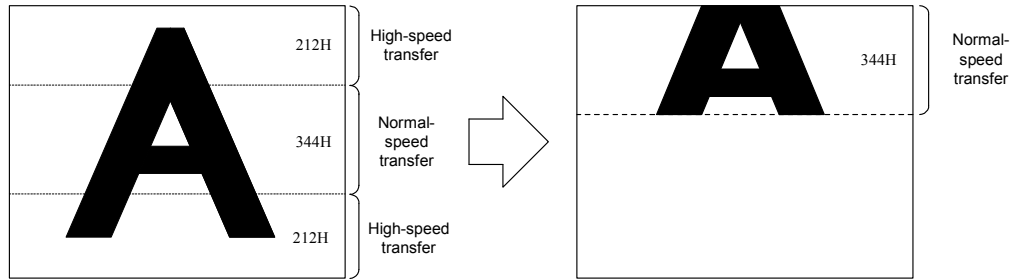

■ Under normal shutter (Electronic shutter OFF)

Notes: * Under ext. sync, the ext. VD should be 1V = 387H.

** Under normal shutter, set the rear-panel DIP SW #5, #6 in OFF.

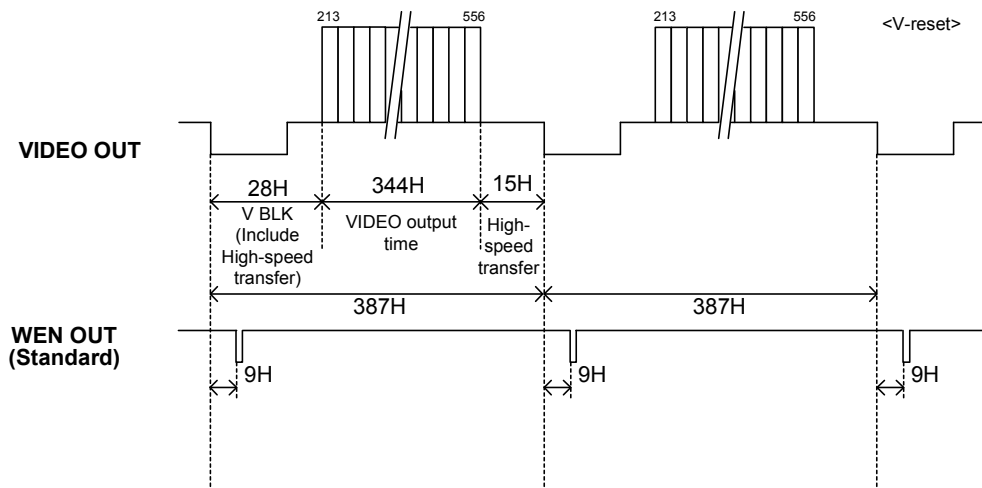

■ Under other shutter modes

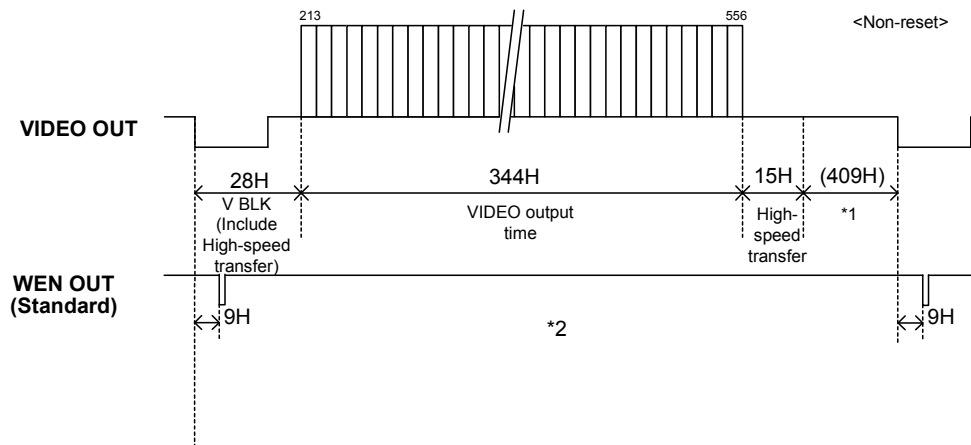

*1:Arbitrary under ext.sync

*2:See "7.TIMING CHART (4)WEN timing".

(5-2)1/4 Partial-scan --- Screen center 1/4 readout

Only the center portion of 137H out of the total effective lines 768H (excluding BLK time) is read out. Available both under external / internal mode.

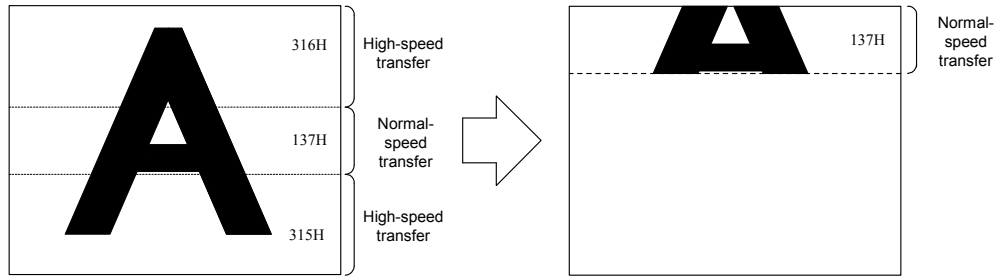

■ Under normal shutter (Electronic shutter OFF)

Notes: * Under ext. sync, the ext. VD should be $1V = 193H$.

** Under normal shutter, set the rear-panel DIP SW #5, #6 in OFF.

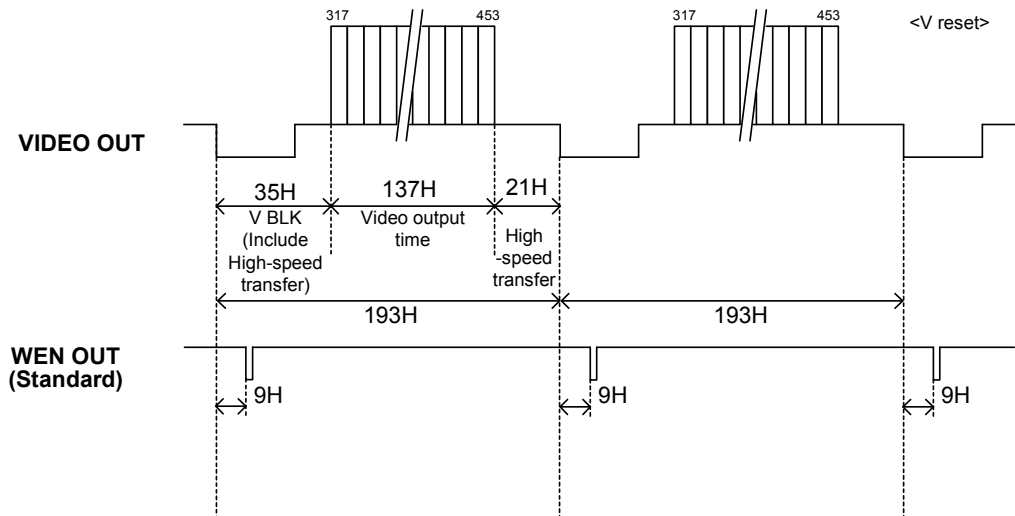

■ Under other shutter modes

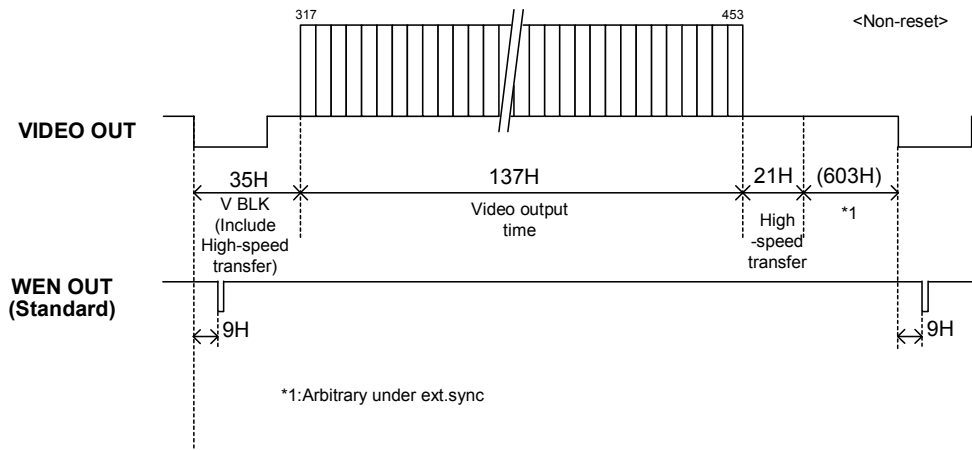

6. SPECIFICATIONS

[Basic spec]

(1) Image sensor	All Pixel's Data Read-out Interline CCD
Total pixels	1077(H) x 788(V)
Active pixel	1034(H) x 779(V)
Video output pixels	1024(H) x 768(V)
Scanning area	4.81(H) x 3.62(V) mm (=Equivalent to 1/3 type CCD size)
Unit cell size	4.65(H) x 4.65(V) micro m (Square-grid array)
(2) TV system	Special format (Non-conforming to EIA)
(3) Scanning lines	796 lines
(4) Interlace	Non-interlace mode
(5) Sync system	Internal/External automatic switch-over
(6) Video output	VS 1.0V(p-p) / 75 Ω , DC coupled, 1 line
(7) Resolution	770 TV lines(H) 768 TV lines(V)
(8) S/N	Standard: 50dB(p-p)/rms (Initial factory setting)
(9) Illumination	Standard 400 lx (F5.6) Minimum 4 lx (F1.4) (GAIN MAX, Approx. 50% video output)
(10) Gain	FIX (Fixed) gain: Factory-shipped preset level MANU (Manual) gain: Setting through GAIN VR FIX / MANU switching via rear-panel SW
(11) Gamma	Gamma = 1 (Fixed)
(12) White-clip level	Approx. 840mV(p-p) (Excluding SYNC)
(13) Power source	DC12V +/-10% Ripple voltage: 50mV(p-p) or less
(14) Power consumption	Approx. 2.0W

[Internal sync spec]

(1) Base clock frequency	29.5MHz (1CLK)
(2) H sync frequency	23.23kHz
(3) V sync frequency	29.2Hz (Under non-interlace)

[External sync spec]

(1) Ext. sync input signal	HD/VD
(2) Input level	From 2 through 4V (p-p)
(3) Input impedance	75-ohm / High impedance 10k-ohm (switching via rear-panel SW) (Initial factory setting: High)
(4) Interlace	Non-interlace
(5) Polarity	Negative
(6) Pulse width	HD: 3.46 +/- 1 micro s (LOW) VD: From 125 through 400 micro s (LOW)
(7) Repeating frequency	$f_H = 23.23\text{kHz} \pm 1\%$ $f_V = f_H/796$
(8) Phase difference	HD/VD: 0 +/- 5.0 micro s

[Shutter trigger spec]

- (1) Input level Exposure-starting-cue signal in random trigger shutter mode
 LOW level: From 0 through 0.5V
 HIGH level: From 4 through 5V
- (2) Input impedance High impedance (10k-ohm)
- (3) Capture timing Rising edge detection (Positive) / Falling edge detection (Negative)
 (Switching via rear-panel DIP SW)
 (Initial factory setting: Rising edge)
- (4) Pulse width Minimum 2 micro s
 Maximum 1/8s

[Sync signal spec]

- (1) Readout signal WEN readout timing pulse
- (2) Polarity Negative
- (3) Pulse width 1H output
- (4) Output circuit

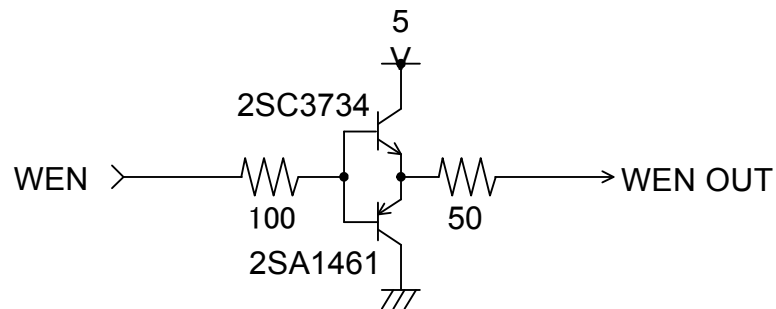

[Electronic shutter spec]

- (1) Normal shutter Shutter-speed setting via rear-panel SW (Initial: OFF)
 12 steps switch-able (= OFF, 1/60s, 1/125s, 1/250s, 1/500s, 1/1000s, 1/2000s, 1/5000s, 1/10000, 1/20000, 1/50000, 1/100000)

(2) RTS

(a) Operation mode

No.	Reset	Exposure	Sync
1	Non-reset	Rear SW (FIX mode)	Internal
2			Consecutive HD / Consecutive VD IN
3			Consecutive HD / Single VD IN
4		TRIG pulse width (PULSE width mode)	Internal
5			Consecutive HD / Consecutive VD IN
6			Consecutive HD / Single VD IN
7	V-reset	Rear SW (FIX mode)	Internal
8			Consecutive HD IN
9		TRIG pulse width (PULSE width mode)	Internal
10			Consecutive HD IN

Notes : * RTS mode automatically switches over through TRIG IN
 **RTS disabled under Electronic shutter OFF

(b) Multiple shutter

Multiple shutter via ext. trigger signal and ext. VD signal
 Notes : * Operation like No.3, 6 above

(3)Restart / Reset

Restart / reset available via ext. VD signal

(Switching via rear panel DIP SW, Initial OFF)

Notes : * The exposure-time (shutter-speed) is determined by ext. VD interval.

** Enabled when rear-panel DIP SW OFF.

***Provide Consecutive HD.

[Partial scan]

(1)Operation mode

No	Scan mode	Sync	Reset	E-shutter Normal	E-shutter RTS
1	1/2 partial	Internal	Non-reset	Enabled [Option]	Enabled
2			V-reset	Disabled	
3		Consecutive HD VD IN	Non-reset	Enabled [Option]	Enabled
4		Consecutive HD (VD) IN	V-reset	Disabled	
5	1/4 partial	Internal	Non-reset	Enabled [Option]	Enabled
6			V-reset	Disabled	
7		Consecutive HD VD IN	Non-reset	Enabled [Option]	Enabled
8		Consecutive HD (VD) IN	V-reset	Disabled	

Note: Items shown as [Option] in this document is not included in your purchase as standard components. Contact our dealer / distributor for details.

(2) Reset mode

As shown in (1) above, non-reset and V-reset is available.

[Option]: Doesn't come as standard. Contact our dealer / distributor for details)

(a) non-reset (Electronic shutter enabled)

VD doesn't get reset after video readout. The interval of VD signal is as follows.

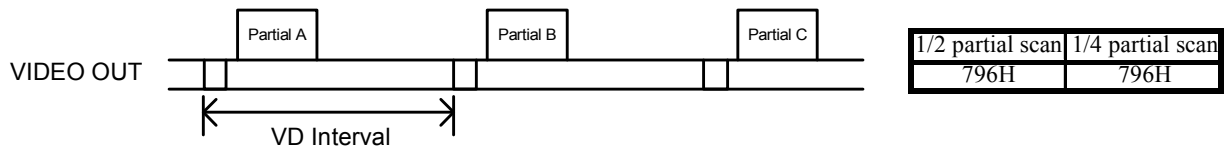

*Note: Under normal shutter mode, when non-reset is selected on partial scan, electronic shutter is valid.

Please note that the exposure time is shortened than the setting value when the external VD is input at shorter than the above VD interval.

(b) V-reset (Electronic shutter disabled)

VD does get reset after video readout. Under internal sync, the interval of VD signal is as follows.

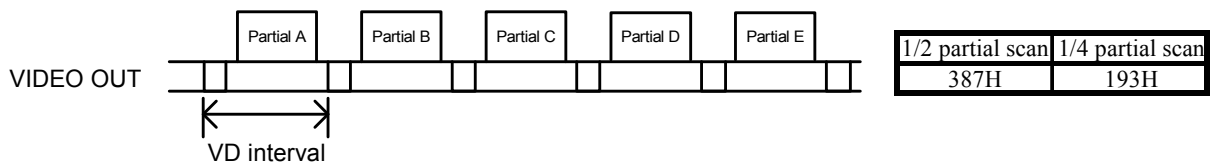

Note: Items shown as [Option] in this document is not included in your purchase as standard components. Contact our dealer / distributor for details.

[Mechanical spec]

- | | |
|------------------------|--|
| (1) External dimension | 44 x 29 x 78(D) mm (Not including protrusion)
Refer to the attached external view drawing |
| (2) Weight | Approximately 130g |
| (3) Lens mount | C mount |
| (4) GND / insulation | Circuit GND - Chassis electrically conducted |

* Combination of C-mount lens

As for the C-mount lens used combining this camera, the projection distance from bottom of the screw should use 8.3mm or less.

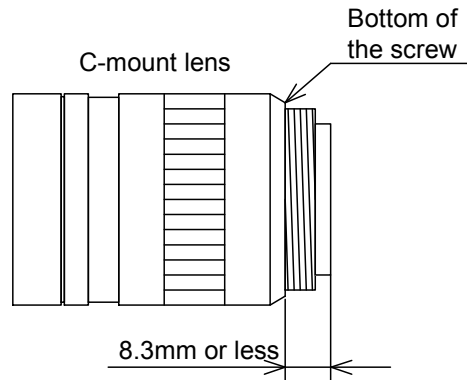

[Ambient condition]

(1) Environment condition

- | | |
|------------------------|---|
| Performance guaranteed | Temperature: From 0 through 40 °C
Humidity: From 30 through 90 % (No condensing) |
| Operation guaranteed | Temperature: From -5 through 50 °C
Humidity: From 10 through 90 % (No condensing) |
| Storage | Temperature: From -20 through 60 °C
Humidity: From 10 through 90 % (No condensing) |

(2) EMC conditions (Electro-Magnetic Compatibility)

EMI (Electro-Magnetic Interference)

EN61000-6-4 (Examination level EN55011-A) Conformity

EMS (Electro-Magnetic Susceptibility)

EN61000-6-2 Conformity

*Conformity of EMC conditions

About the conformity of the EMC standard of this machines, it has guaranteed in the conditions combined with the option part of 4th clause.

When used combining parts other than specification of our company, I ask you to have final EMC conformity checked of a visitor with a machine and the whole equipment.

[Connector pin assignment]

(1) Compatible connector HR10A-10P-12S (Supplied by HIROSE ELEC.)

(2) Pin assignment

Pin No.	Signal (Standard)
1	DC12V GND
2	DC12V
3	VIDEO GND
4	VIDEO OUT
5	HD GND
6	HD IN
7	VD IN
8	TRIG GND
9	NC
10	WEN OUT
11	TRIG IN
12	VD GND

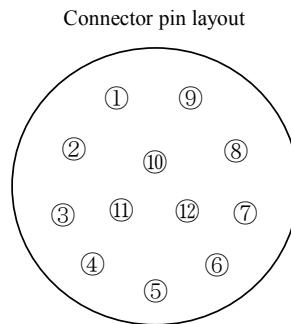

12 pin male

Picture Rear-panel camera connector
(Rear-view)

Notes : *Before connecting / disconnecting the connector, make sure the camera power is OFF.

**For board connection, check compatibility.

[Switch setting]

(1) CCU rear-panel DIP SW

No.	Function	OFF	ON
1	E-shutter-speed (SHUT)	See shutter-speed table (Table 1)	
2			
3			
4			
5	Shutter mode (SMODE)	See shutter-mode table (Table 3)	
6			
7	Partial scan (PART)	See partial-scan table (Table 2)	
8			
9	TRIG polarity	Positive (Rising edge)	Negative (Falling edge)

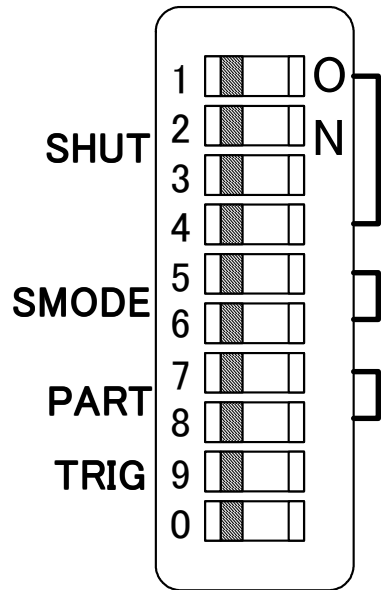

Notes: *Initial factory setting: All OFF

**Set No.9 OFF when TRIG IN OPEN.

(Table 1) Electronic shutter-speed

Shutter-speed	No.1	No.2	No.3	No.4
OFF	OFF	OFF	OFF	OFF
1/60s	ON	OFF	OFF	OFF
1/125s	OFF	ON	OFF	OFF
1/250s	ON	ON	OFF	OFF
1/500s	OFF	OFF	ON	OFF
1/1,000s	ON	OFF	ON	OFF
1/2,000s	OFF	ON	ON	OFF
1/5,000s	ON	ON	ON	OFF
1/10,000s	OFF	OFF	OFF	ON
1/20,000s	ON	OFF	OFF	ON
1/50,000s	OFF	ON	OFF	ON
1/100,000s	ON	ON	OFF	ON
Not acceptable	OFF	OFF	ON	ON
Not acceptable	ON	OFF	ON	ON
1/100s(FL)	OFF	ON	ON	ON
Pulse width	ON	ON	ON	ON

(Table 2) Partial-scan

Partial scan	No.7	No.8
OFF	OFF	OFF
1/2 partial	ON	OFF
1/4 partial	OFF	ON
Not acceptable	ON	ON

Notes : *Don't set Electronic shutter-speed in OFF under RTS mode.

(Table 3) Shutter-mode

Shutter mode		No.5	No.6	SYNC	
Random trigger	V reset	OFF	OFF	Internal sync	
	Not acceptable	ON	OFF		
	Non-reset	OFF	ON		
Not acceptable		ON	ON		
Random trigger	Non-reset (Multiple shutter)	OFF	OFF	Single VD	Ext. sync HD IN
	Non-reset	ON	OFF	Consecutive VD	
	V reset	OFF	ON	No VD	
Restart / Reset		ON	ON	Single VD	

Notes : * Under normal shutter mode partial-scan, set No.5, 6 in OFF.

**Under PULSE W mode, SYNC reset is disabled.

(2)CCU rear-panel SW

Function	SW	Selected Function
Ext. SYNC IN impedance (HD/VD)	HIGH	HIGH impedance (Initial factory setting)
	75Ω	75Ω
GAIN selection (GAIN)	F	Factory-set GAIN
	M	Manual GAIN adjustable via GAIN potentiometer

[Relative Spectrum Response]

*Including lens characteristics, Excluding light source characteristics

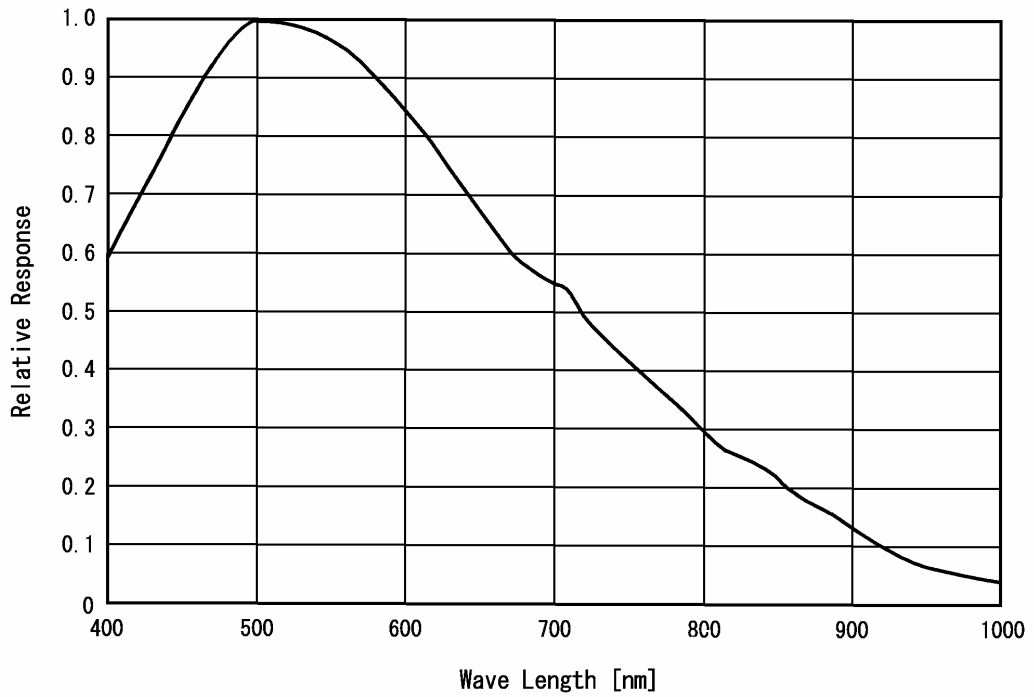

[Optical black characteristics]

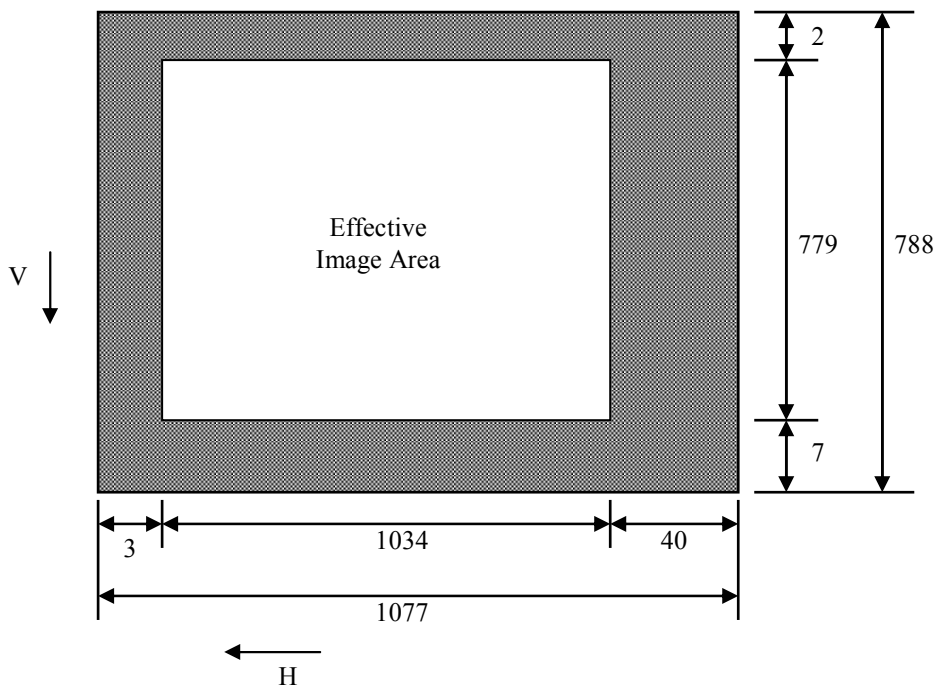

Total pixels : 1077(H) x 788(V)
 Effective pixels : 1034(H) x 779(V)
 Optical black
 Horizontal : 3pixels --- 40pixels
 Vertical : 7pixels --- 2pixels

7. TIMING CHART

(1) H rate timing

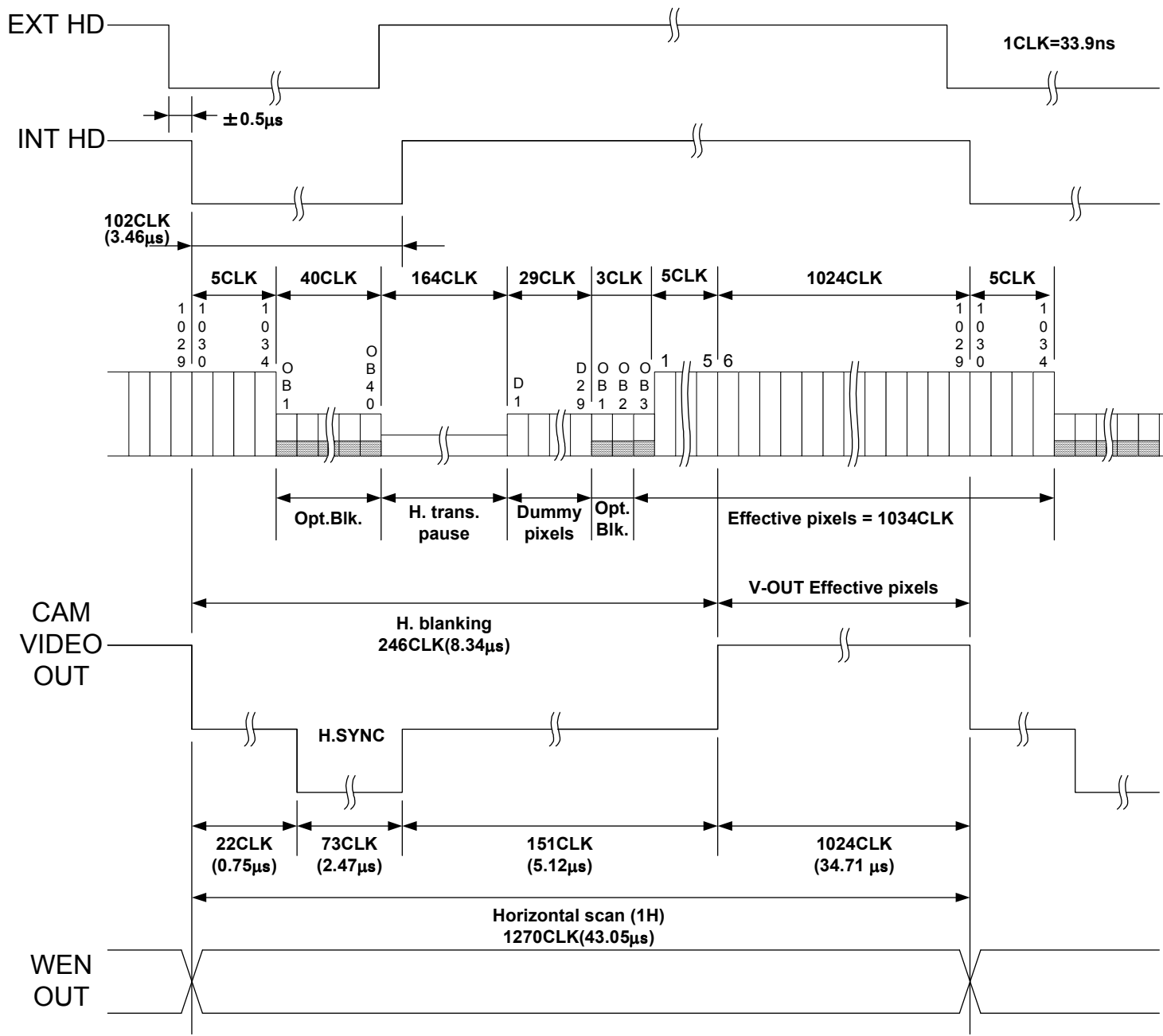

(2) V rate timing

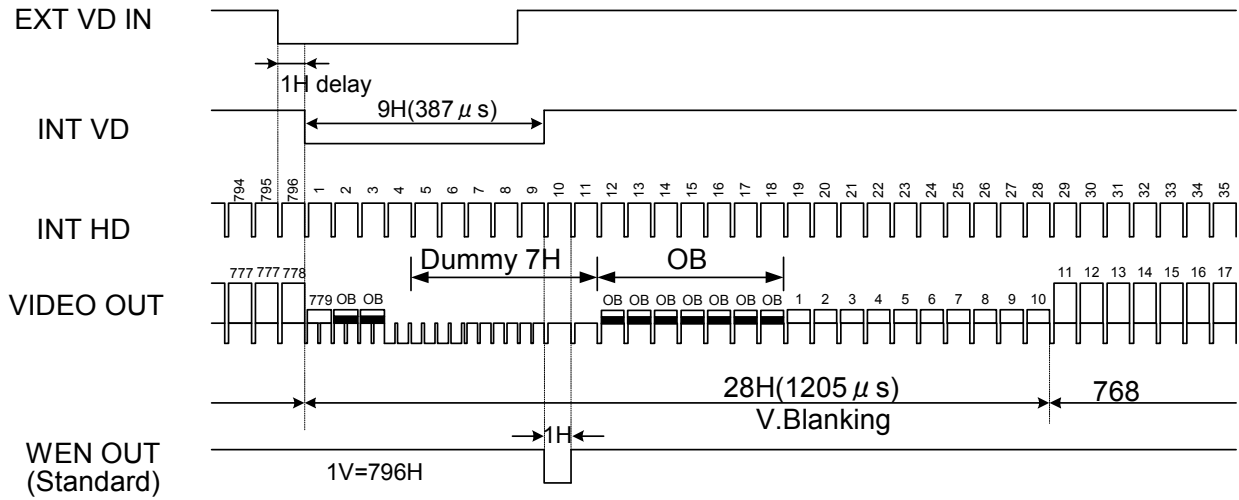

Ext. VD – Ext. HD phase difference

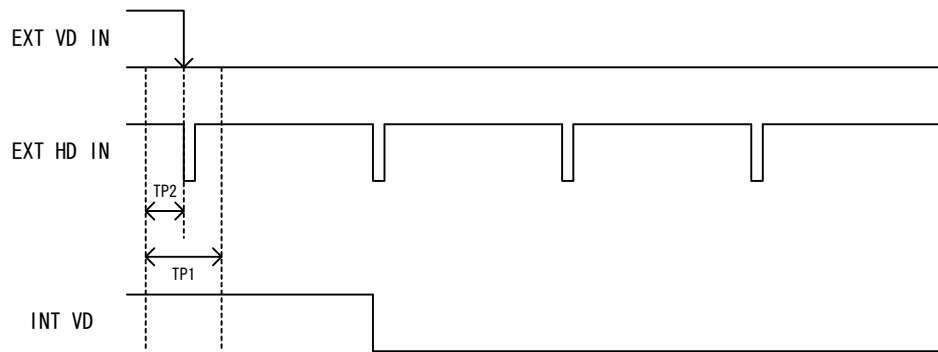

TP1 : 10.0 us
TP2 : 5.0 us

8. EXTERNAL-VIEW DRAWING

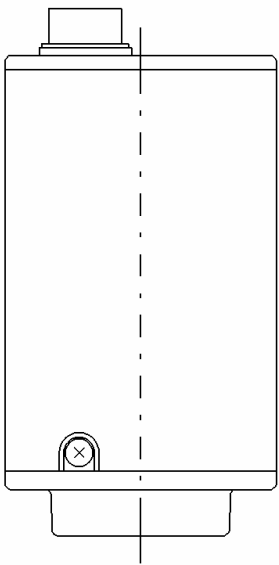

Lens screw
all-in depth 8.3

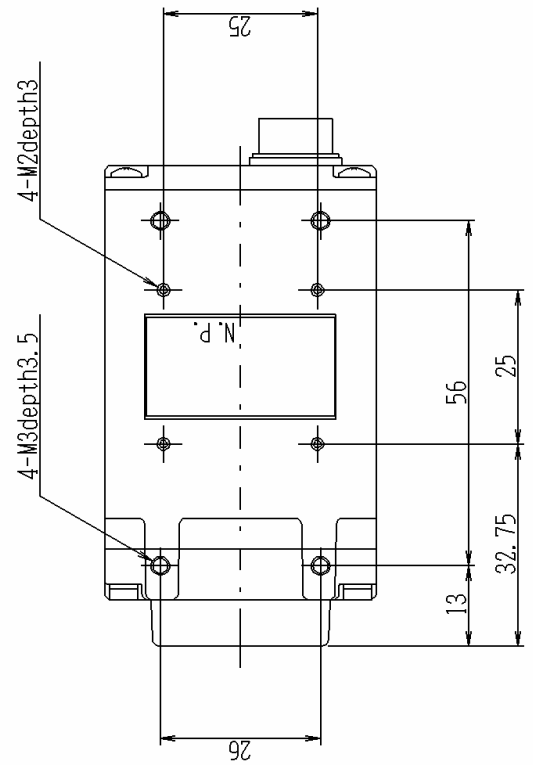
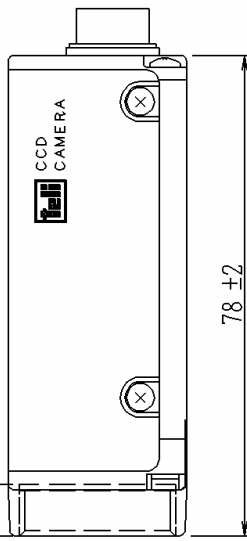
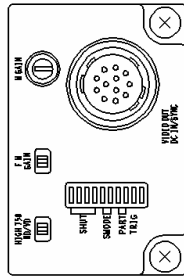
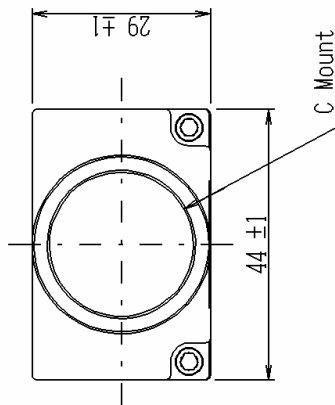



TOSHIBA TELI CORPORATION

Head Office: 7-1, 4 chome, Asahigaoka, Hino-shi, Tokyo, 191-0065, Japan
(Overseas Sales Department)

Phone: +81-42-589-8771 Fax: +81-42-589-8774

URL: <http://www.toshiba-teli.co.jp>

The design and specification is subject to change without notice.

Free Manuals Download Website

<http://myh66.com>

<http://usermanuals.us>

<http://www.somanuals.com>

<http://www.4manuals.cc>

<http://www.manual-lib.com>

<http://www.404manual.com>

<http://www.luxmanual.com>

<http://aubethermostatmanual.com>

Golf course search by state

<http://golfingnear.com>

Email search by domain

<http://emailbydomain.com>

Auto manuals search

<http://auto.somanuals.com>

TV manuals search

<http://tv.somanuals.com>