

TOSHIBA

E: ENGLISH
F: FRANÇAIS
S: ESPAÑOL

Introduction

Connecting
your TV

Using the
Remote Control

Setting up
your TV

Using the TV's
Features

Appendix

Index

OWNER'S MANUAL

LCD Color Television



COLORSTREAM®

15DL15 20DL15

Owner's Record

The model number and serial number are on the back of your TV. Record these numbers in the spaces below. Refer to these numbers whenever you communicate with your Toshiba dealer about this TV.

Model number:

Serial number:

Dear Customer,

Thank you for purchasing this Toshiba LCD TV. This manual will help you use the many exciting features of your new LCD TV. **Before operating the TV, please read this manual completely**, and keep it nearby for future reference.

Safety Precautions

WARNING: TO REDUCE THE RISK OF FIRE OR ELECTRIC SHOCK, DO NOT EXPOSE THIS APPLIANCE TO RAIN OR MOISTURE.

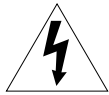

WARNING
RISK OF ELECTRIC SHOCK
DO NOT OPEN



WARNING: TO REDUCE THE RISK OF ELECTRIC SHOCK, DO NOT REMOVE COVER (OR BACK). NO USER-SERVICEABLE PARTS INSIDE. REFER SERVICING TO QUALIFIED SERVICE PERSONNEL.

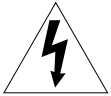

The lightning symbol in the triangle tells you that the voltage inside this product may be strong enough to cause an electric shock. **DO NOT TRY TO SERVICE THIS PRODUCT YOURSELF.**



The exclamation mark in the triangle tells you that important operating and maintenance instructions follow this symbol.

WARNING

To prevent injury, this apparatus must be securely attached to the floor/wall in accordance with the installation instructions. (See item 20 on page 4.)

NOTE TO CATV INSTALLERS

This is a reminder to call the CATV system installer's attention to Article 820-40 of the NEC, which provides guidelines for proper grounding and, in particular, specifies that the cable ground shall be connected to the grounding system of the building, as close to the point of cable entry as practical. For additional antenna grounding information, see items 25 and 26 on page 4.

FCC Declaration of Conformity Compliance Statement (Part 15):

The **Toshiba 15DL15/20DL15 LCD Color Televisions** comply with Part 15 of the FCC rules.

Operation is subject to the following two conditions: (1) this device may not cause harmful interference, and (2) this device must accept any interference that may cause undesired operation.

The party responsible for compliance to these rules is: Toshiba America Consumer Products, L.L.C.
82 Totowa Rd. Wayne, NJ 07470.
Ph: (973) 628-8000

Note: This equipment has been tested and found to comply with the limits for a Class B digital device, pursuant to Part 15 of the FCC rules. These limits are designed to provide reasonable protection against harmful interference in a residential installation. This equipment generates, uses, and can radiate radio frequency energy and, if not installed and used in accordance with the instructions, may cause harmful interference to radio communications. However, there is no guarantee that interference will not occur in a particular installation. If this equipment does cause harmful interference to radio or television reception, which can be determined by removing and applying power to the equipment, the user is encouraged to try to correct the interference by one or more of the following measures:

- Reorient or relocate the receiving antenna.
- Increase the separation between the equipment and the receiver.
- Connect the equipment into an outlet on a circuit different from that to which the receiver is connected.
- Consult the dealer or an experienced radio/TV technician for help.

CAUTION: Changes or modifications to this equipment not expressly approved by Toshiba could void the user's authority to operate this equipment.

Child Safety

It Makes A Difference Where Your TV Stands



Congratulations on your purchase! As you enjoy your new TV, keep these safety tips in mind:

The Issue

- If you are like most consumers, you have a TV in your home. Many homes, in fact, have more than one TV.
- The home theater entertainment experience is a growing trend, and larger TVs are popular purchases; however, they are not always supported on the proper TV stands.
- Sometimes TVs are improperly secured or inappropriately situated on dressers, bookcases, shelves, desks, audio speakers, chests, or carts. As a result, TVs may fall over, causing unnecessary injury.

Toshiba Cares!

- The consumer electronics industry is committed to making home entertainment enjoyable and safe.
- The Consumer Electronics Association formed the Home Entertainment Support Safety Committee, comprised of TV and consumer electronics furniture manufacturers, to advocate children's safety and educate consumers and their families about television safety.

Tune Into Safety

- One size does NOT fit all! Use appropriate furniture large enough to support the weight of your TV (and other electronic components).
- Use appropriate angle braces, straps, and anchors to secure your furniture to the wall (but never screw anything directly into the TV).
- Carefully read and understand the other enclosed instructions for proper use of this product.
- Do not allow children to climb on or play with furniture and TVs.
- Avoid placing any item on top of your TV (such as a VCR, remote control, or toy) that a curious child may reach for.
- Remember that children can become excited while watching a program and can potentially push or pull a TV over.
- Share our safety message about this hidden hazard of the home with your family and friends. Thank you!



2500 Wilson Blvd.
Arlington, VA 22201 U.S.A.
Tel. 703-907-7600 Fax 703-907-7690
www.CE.org

CEA is the Sponsor, Producer and Manager of the International CES®

Important Safety Instructions

- 1) **Read these instructions.**
- 2) **Keep these instructions.**
- 3) **Heed all warnings.**
- 4) **Follow all instructions.**



- 5) **Do not use this apparatus near water.**
- 6) **Clean only with dry cloth.**
- 7) **Do not block any ventilation openings.** Install in accordance with the manufacturer's instructions.

- 8) **Do not install near any heat sources** such as radiators, heat registers, stoves, or other apparatus (including amplifiers) that produce heat.

- 9) **Do not defeat the safety purpose of the polarized or grounding type plug.** A polarized plug has two blades with one wider than the other. A grounding type plug has two blades and a third grounding prong. The wide blade or the third prong are provided for your safety. If the provided plug does not fit into your outlet, consult an electrician for replacement of the obsolete outlet.

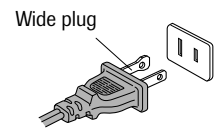

- 10) **Protect the power cord** from being walked on or pinched, particularly at plugs, convenience receptacles, and the point where they exit from the apparatus.

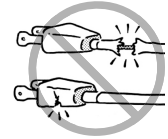

- 11) **Only use attachments/accessories specified by the manufacturer.**

- 12) **Use only with the cart, stand, tripod, bracket, or table specified by the manufacturer, or sold with the apparatus.** When a cart is used, use caution when moving the cart/apparatus combination to avoid injury from tip-over.



- 13) **Unplug this apparatus during lightning storms or when unused for long periods of time.**

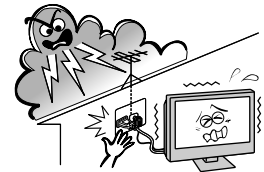

- 14) **Refer all servicing to qualified service personnel.** Servicing is required when the apparatus has been damaged in any way, such as power-supply cord or plug is damaged, liquid has been spilled or objects have fallen into the apparatus, the apparatus has been exposed to rain or moisture, does not operate normally, or has been dropped.

- 15) The apparatus shall not be exposed to dripping or splashing and that no objects filled with liquids, such as vases, shall be placed on the apparatus.



- 16) **CAUTION:** To reduce the risk of electric shock, do not use the polarized plug with an extension cord, receptacle, or other outlet unless the blades can be inserted completely to prevent blade exposure.

Installation, Care, and Service

Installation

Follow these recommendations and precautions and heed all warnings when installing your TV:

- 17) Never modify this equipment. Changes or modifications may void: a) the warranty, and b) the user's authority to operate this equipment under the rules of the Federal Communications Commission.

- 18)  **DANGER: RISK OF SERIOUS PERSONAL INJURY, DEATH, OR EQUIPMENT DAMAGE!** Never place the TV on an unstable cart, stand, or table. The TV may fall, causing serious personal injury, death, or serious damage to the TV. 

- 19) Never place or store the TV in direct sunlight; hot, humid areas; or areas subject to excessive dust or vibration.

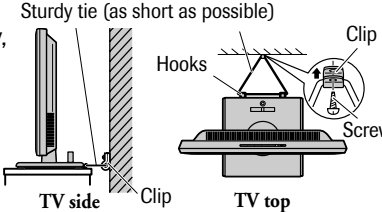
- 20) Always place the TV on the floor or a sturdy, level, stable surface that can support the weight of the unit. To secure the TV, use a sturdy tie from the hooks on the rear of the TV pedestal to a wall, pillar, or other immovable structure. Make sure the tie is tight, secure, and parallel to the floor. Leave a space of at least 4 inches around the TV.
- 

- 21) Never expose the apparatus to dripping or splashing liquid or place items such as vases, aquariums, any other item filled with liquid, or candles on top of the TV.

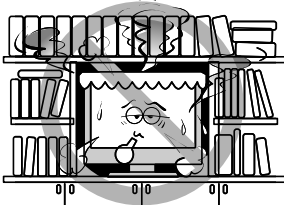
- 22) Never block or cover the slots or openings in the TV cabinet back, bottom, and sides. Never place the TV:
- on a bed, sofa, rug, or similar surface;
 - too close to drapes, curtains, or walls; or
 - in a confined space such as a bookcase, built-in cabinet, or any other place with poor ventilation.
- 

The slots and openings are provided to protect the TV from overheating and to help maintain reliable operation of the TV.

- 23) Never allow anything to rest on or roll over the power cord, and never place the TV where the power cord is subject to wear or abuse.

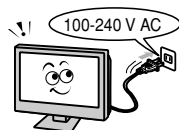

- 24) Never overload wall outlets and extension cords.

- 25) Always operate the TV with a 100-240 V AC, 60Hz power source only.

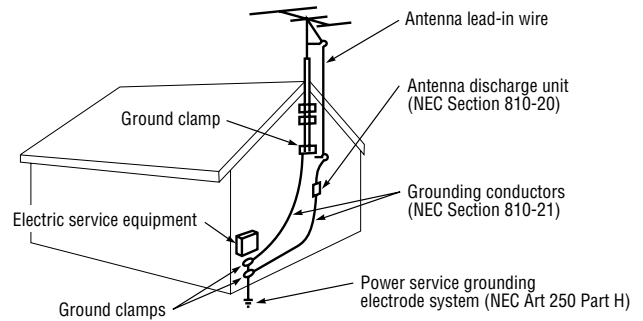

- 26) Always make sure the antenna system is properly grounded to provide adequate protection against voltage surges and built-up static charges (see Section 810 of the National Electric Code).





- 27)  **DANGER: RISK OF SERIOUS PERSONAL INJURY OR DEATH!**
- Use extreme care to make sure you are never in a position where your body (or any item you are in contact with, such as a ladder or screwdriver) can accidentally touch overhead power lines. Never locate the antenna near overhead power lines or other electrical circuits.
 - Never attempt to install any of the following during lightning activity:
 - a) an antenna system; or
 - b) cables, wires, or any home theater component connected to an antenna or phone system.
- 

Care

For better performance and safer operation of your TOSHIBA TV, follow these recommendations and precautions:

- 28) If you use the TV in a room whose temperature is 32 °F (0 °C) or below, the picture brightness may vary until the LCD warms up. This is not a sign of malfunction.

- 29) Always unplug the TV before cleaning. Wipe the display panel surface gently using only a soft cloth (cotton, flannel, etc.). A hard cloth may damage the surface of the panel. Avoid contact with alcohol, thinner, benzene, acidic or alkaline solvent cleaners, abrasive cleaners, or chemical cloths, which may damage the surface. Do not spray volatile compounds such as insecticide on the cabinet. This may cause a discoloration or damage the cabinet.
- 

- 30)  **WARNING: RISK OF ELECTRIC SHOCK!** Never spill liquids or push objects of any kind into the TV cabinet slots.

31) While it is thundering, do not touch the connecting cables or apparatus. Failure to follow this instruction may result in electric shock.

32) For added protection of your TV from lightning and power surges, always unplug the power cord and disconnect the antenna from the TV if you leave the TV unattended or unused for long periods of time.

33) During normal use, the TV may make occasional snapping or popping sounds. This is normal, especially when the unit is being turned on or off. If these sounds become frequent or continuous, unplug the power cord and contact a Toshiba Authorized Service Center.

34)  **WARNING: RISK OF SERIOUS PERSONAL INJURY OR EQUIPMENT DAMAGE !**

Never strike the screen with a sharp or heavy object.



35) • The LCD screen of this product can be damaged by Ultraviolet Radiation from the sun. When selecting a location for the television, avoid locations where the screen may be exposed to direct sunlight, such as in front of a window.

- Never touch, press, or place anything on the LCD screen. These actions will damage the LCD screen. If you need to clean the LCD screen, follow the instructions in item 29 on page 4.

Service

36)  **WARNING: RISK OF ELECTRIC SHOCK !**
Never attempt to service the TV yourself. Opening and removing the covers may expose you to dangerous voltage or other hazards. Refer all servicing to a Toshiba Authorized Service Center.

37) If you have the TV serviced:

- Ask the service technician to use only replacement parts specified by the manufacturer.
 - Upon completion of service, ask the service technician to perform routine safety checks to determine that the TV is in safe operating condition.
-

38) The cold cathode fluorescent lamp in the LCD panel contains a small amount of mercury. When the TV reaches the end of its useful life, dispose of the used TV by the approved method for your area, or ask a qualified service technician to properly dispose of the TV.

 **Note:** The lamp unit contains mercury, the disposal of which may be regulated due to environmental considerations. For disposal or recycling information, contact your local authorities or the Electronics Industries Alliance (www.eiae.org).

Important notes about your LCD TV

The following symptoms are technical limitations of LCD Display technology and are not an indication of malfunction. Therefore, TACP/TCL is not responsible for perceived defects resulting from these symptoms.

- 1) An afterimage (ghost) may appear on the screen if a fixed, non-moving image is displayed for a long period of time. The afterimage is not permanent and will disappear in a short period of time.
- 2) The LCD panel contained in this TV is manufactured using an extremely high level of precision technology; however, there may be an occasional pixel (dot of light) that does not operate properly (that does not light, that remains constantly lit, etc.). This is a structural property of LCD technology, is not a sign of malfunction, and is not covered under your warranty. Such pixels are not visible when the picture is viewed from a normal viewing distance.

Note: Interactive video games that involve shooting a "gun" type of joystick at an on-screen target may not work on this TV.

Introduction.....	7	Using the TV's features.....	20
Welcome to Toshiba	7	Switching between two channels using Channel	
Supplied accessories	7	Return	20
Connecting the power cord	7	Using the Blue screen feature	20
Exploring your new TV	8	Selecting the video input source	20
Rear terminal cover	9	Using the V-Chip menu	21
Cable clamper	9	V-Chip rating and categories	21
Adjusting the TV viewing angle	9	V-Chip (Parental menu) setup	22
Connecting your TV	10	Adjusting the picture	23
Connecting an antenna or cable TV	10	Selecting the picture mode	23
Connecting a VCR	11	Adjusting the picture quality	23
Connecting a cable converter box	11	Using the closed caption feature	24
Connecting a cable converter box and a VCR	11	To turn on or off the Closed Caption feature	25
Connecting a DVD player with ColorStream®		Using the Panel lock feature	25
(component video) and a VCR	12	Setting the sleep timer	25
Connecting a DTV receiver/set-top box with		Adjusting the sound	26
ColorStream® (component video) and a VCR	13	Muting the sound	26
Connecting an audio system	14	Selecting stereo/SAP broadcasts	26
Connecting a camcorder	14	Using the WOW™ surround sound feature	27
Connecting a personal computer (PC)	15	Selecting the sound mode	27
Using the remote control	16	Adjusting the sound quality	28
Learning about the remote control	16	Using the StableSound® feature	28
Installing the remote control batteries	16	Using the PC setting feature	29
Remote control effective range	16	Using the Auto off feature	30
Setting up your TV	17	Displaying on-screen information	30
Learning about the menu system	17	Understanding the last mode memory feature	30
Changing the on-screen display language	18	Appendix.....	31
Adding channels to the TV's memory	18	Specifications	31
Programming channels automatically	18	Troubleshooting.....	32
Adding and erasing channels manually	19	Limited United States Warranty	33
Changing channels	19	Limited Canada Warranty	34
Programming your favorite channels	19	Index.....	35

Introduction

Welcome to Toshiba

Thank you for purchasing this Toshiba LCD TV. The goal of this manual is to guide you through setting up and operating your Toshiba TV as quickly as possible.

The model and serial numbers are on the back of your TV. Write these numbers in the space provided on the front cover of this manual for your records.

Instructions in this manual are based on using the remote control. You also can use the controls on the TV if they have the same name as those referred to on the remote control.

Please read all the safety and operating instructions carefully, and keep this manual for future reference.

Supplied accessories

Check that you have the accessories and items shown.

Owner's Manual
(This book)

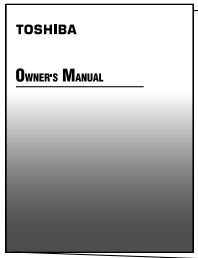

Remote control
Batteries R6 (AA) × 2

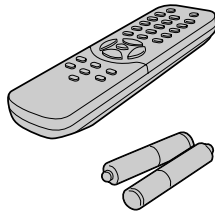

Power cord



Clip



Use this clip to attach the TV to a wall, pillar, or other immovable structure. See item 20 on page 4.

Connecting the power cord

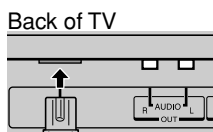

NOTE: RISK OF EQUIPMENT DAMAGE!

Never plug in any power cords until you have finished connecting all equipment (see page 10).

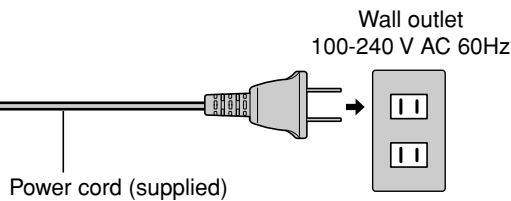

* The power cord supplied with this product is to be used in the United States and Canada only.

Exploring your new TV

You can operate your TV by using the buttons on the top panel or the remote control. The A/V terminals for connecting other equipment to your TV are on the back panel and side panel (see illustrations below). Also see "Connecting your TV" on pages 10-15. Model 20DL15 is used in this manual for illustration purposes.

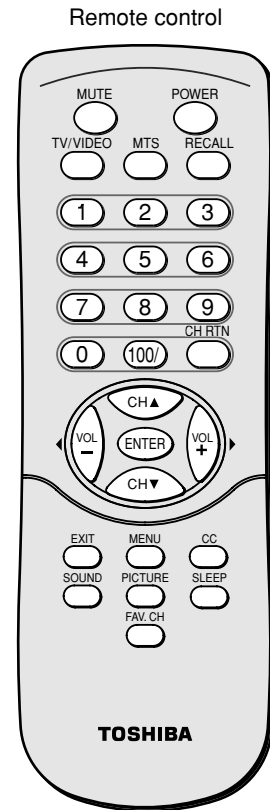
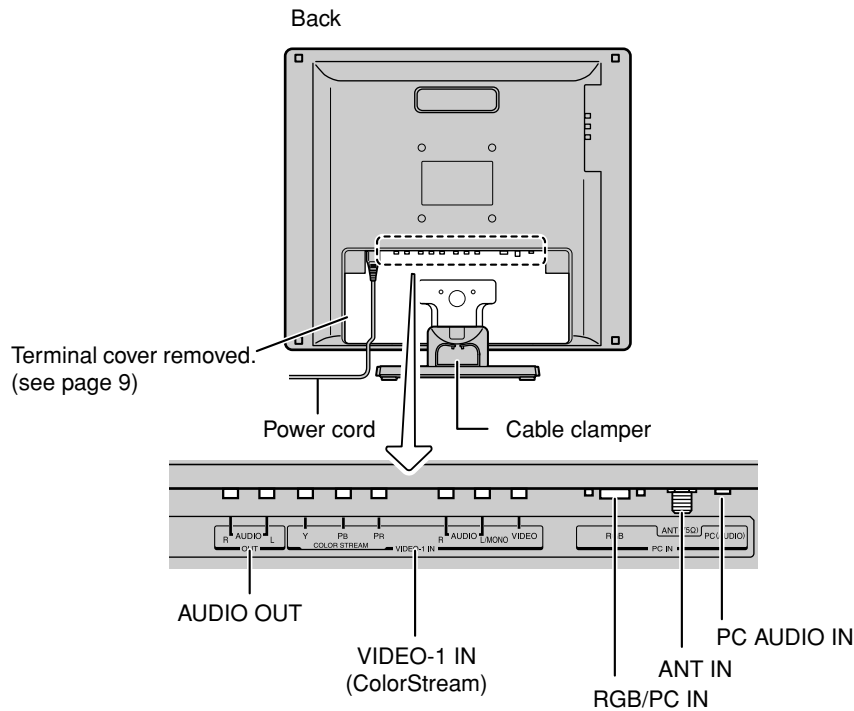
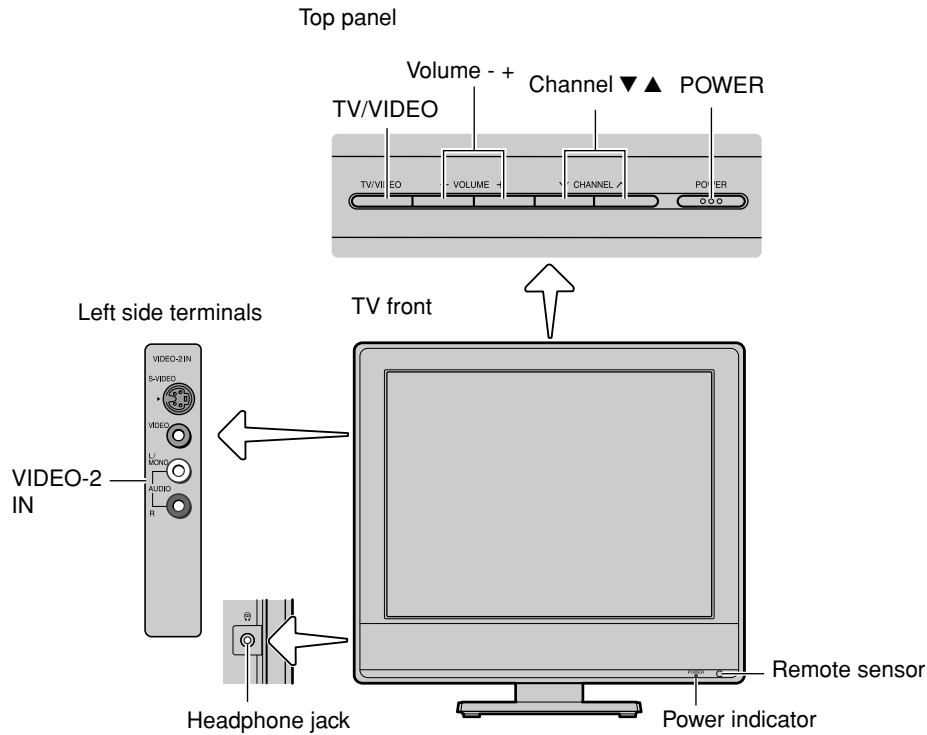

Rear terminal cover

The connection panel is hidden behind the terminal cover.

1. Remove the cover. Release the two hooks on the bottom of the cover.
2. Install cables as necessary.
3. Reinstall the cover. Align the holes on the TV back with the three tabs on the rear terminal cover as shown.
4. Close the cover.

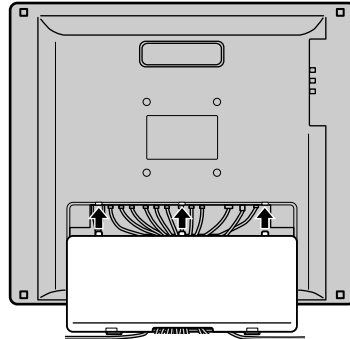
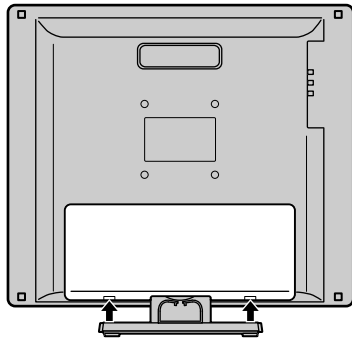

Cable clammer

The cable clammer can be used to bundle the connection cables (see page 10).

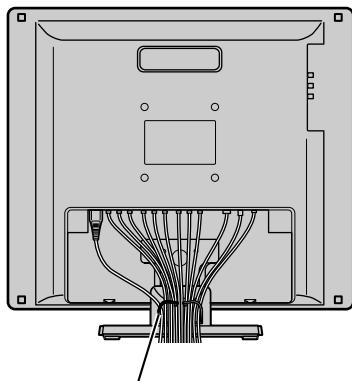

Cable clammer



WARNING: RISK OF SERIOUS PERSONAL INJURY OR EQUIPMENT DAMAGE!

Never grasp the cable clammer when moving or lifting the TV. The cable clammer could break, causing the TV to fall.

Adjusting the TV viewing angle

You can adjust the angle of the TV screen.

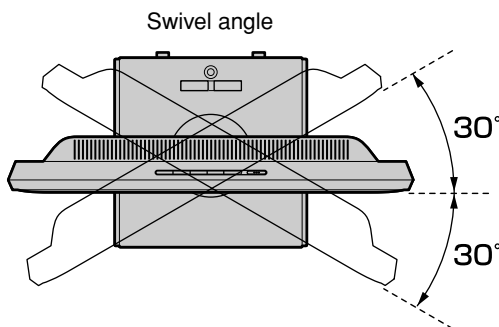

Tilt angle

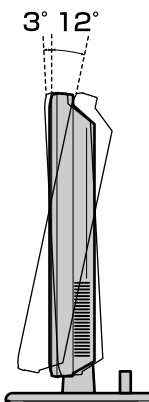

Connecting your TV

Note: All required cables, if not provided with your other devices, can be purchased at many electronics accessory suppliers.

- **Coaxial (F-type) cable** is used for connecting your antenna, cable TV service, and/or cable converter box to the ANT 75 Ω RF input on your TV.
- **Standard A/V cables (composite video)** usually come in sets of three, and are for use with video devices with standard audio and standard (composite) video output. These cables (and the related inputs on your TV) are typically color-coded according to use: yellow for video, red for stereo right audio, and white for stereo left (or mono) audio.
- **S-video cable** is for use with video devices with S-video output. Separate audio cables are required for a complete connection.

Note: An S-video cable provides better picture performance than a standard (composite) video cable.

- **Component video cables** come in sets of three and are for use with video devices with component video output. These cables are typically color-coded red, green, and blue. (ColorStream® is Toshiba's brand of component video.) Separate audio cables are required for a complete connection.

Note: Component video cables provide better picture performance than a standard (composite) video or S-video cable.

- **Mini D-sub 15-pin cable** is for use with a personal computer with an analog RGB (15-pin) output. A separate audio cable is required for a complete connection.

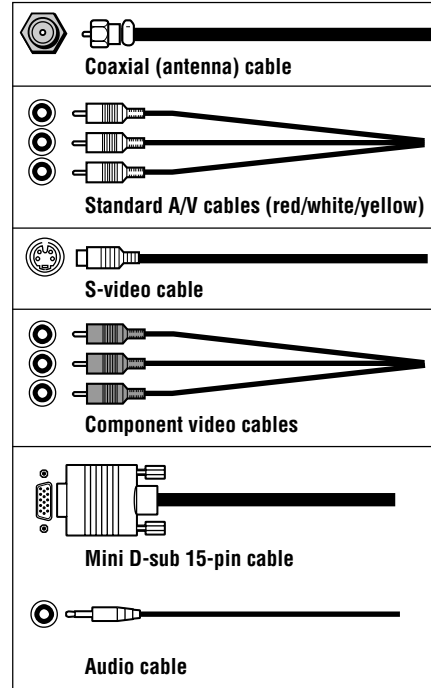

Connecting an antenna or cable TV

This connection allows you to watch TV programs or basic cable channels.

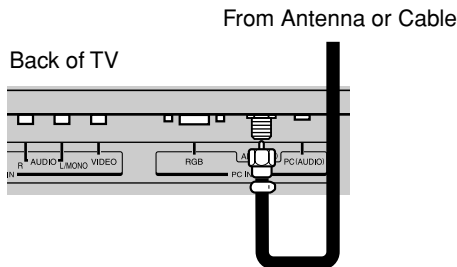

NOTE: RISK OF EQUIPMENT DAMAGE!

Never plug in any power cords until you have finished connecting all equipment.

Connecting a VCR

This connection allows you to watch local channels and video programs, play or record on the VCR while watching TV, and record from one channel while watching another channel.

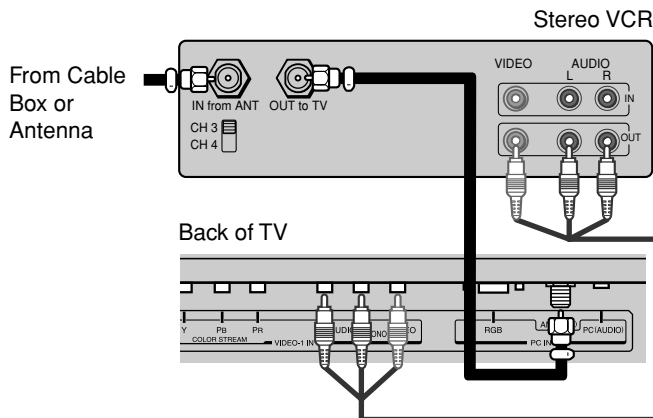

Note:

If you have a mono VCR, connect L/Mono to VCR Audio OUT using only one audio cable.

If you have a VCR with S-video, use an S-video cable (in the S-video jacks) instead of a standard video cable.

The TV side panel can be used to connect a VCR with S-video.

Connecting a cable converter box

This connection allows you to watch basic and premium cable channels. Tune the TV to channel 3 or 4 (whichever channel is vacant in your area), and use the converter box to change channels.

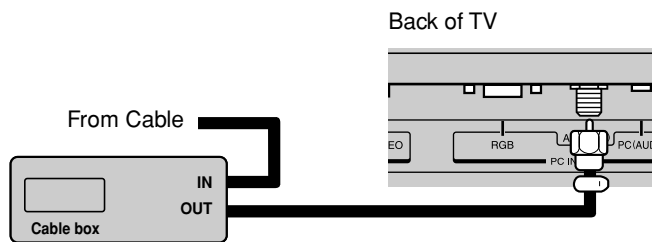

Note:

When you use a converter box with your TV, the remote control will not operate some features, such as favorite channel programming or channel return.

Connecting a cable converter box and a VCR

This connection allows you to watch and record basic and premium cable channels, as well as watch videotapes. Set the TV signal source to Video1 (page 20). Tune the VCR to channel 3 or 4 (the same channel as the converter box output switch), and use the cable converter box to change channels.

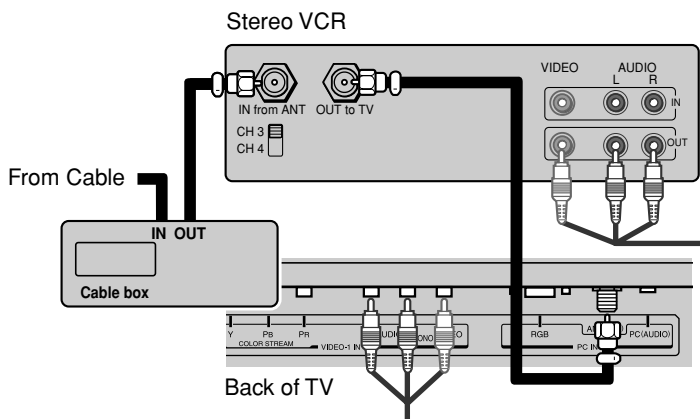

Note:

When you use a converter box with your TV, the remote control will not operate some features, such as favorite channel programming or channel return.

If you have a mono VCR, connect L/Mono to VCR Audio OUT using only one audio cable.

If you have a VCR with S-video, use an S-video cable (in the S-video jacks) instead of a standard video cable.

The TV side panel can be used to connect a VCR with S-video.

The unauthorized recording, use, distribution, or revision of television programs, videotapes, DVDs, and other materials is prohibited under the Copyright Laws of the United States and other countries, and may subject you to civil and criminal liability.

Connecting a DVD player with ColorStream® (component video) and a VCR

This connection allows you to watch DVD, VCR, and TV programs, and record TV programs.

Your TV has ColorStream® (component video) inputs. Connecting your TV to a DVD player with component video can greatly enhance picture quality and realism.

- To record one TV program while watching another TV program, tune the VCR to the channel to record, and tune the TV to the channel to watch.
- To record a TV program while watching a DVD, tune the VCR to the channel to record, and select Video1 on the TV (see “Selecting the video input source” on page 20).

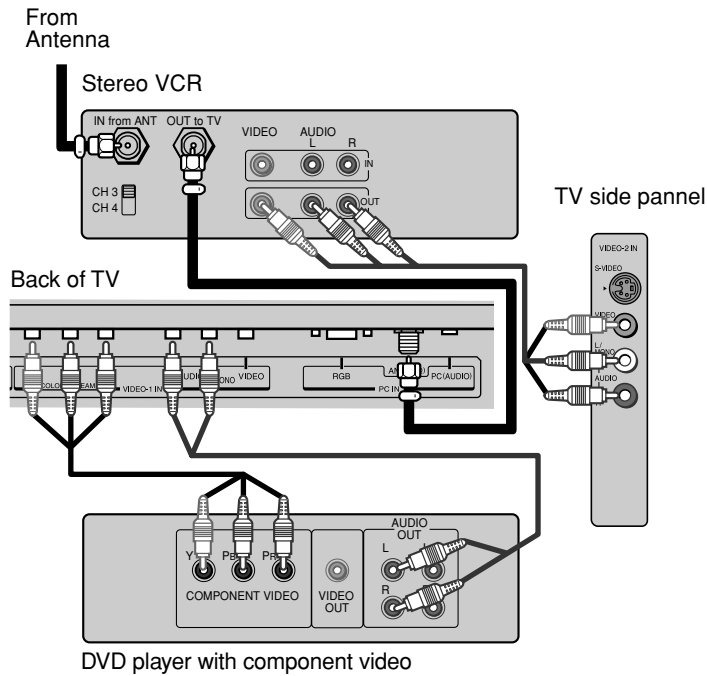

Note:

For the highest possible picture quality, use component video cables between the TV and DVD player.

The ColorStream jacks can be used with 480i, 480p, 720p, and 1080i scan system.

The TV side panel can be used to connect a VCR with S-video.

The unauthorized recording, use, distribution, or revision of television programs, videotapes, DVDs, and other materials is prohibited under the Copyright Laws of the United States and other countries, and may subject you to civil and criminal liability.

Connecting a DTV receiver/set-top box with ColorStream® (component video) and a VCR

This connection allows you to watch DTV (digital TV), VCR, and TV programs, and record DTV (composite video only) and TV programs.

Your TV has ColorStream® (component video) inputs. Connecting your TV to a DTV receiver with component video can greatly enhance picture quality and realism.

- To record and watch a DTV program, select LINE IN on the VCR, and select Video1 on the TV (see "Selecting the video input source" on page 20).
- To record a TV program while watching a DTV program, tune the VCR to the channel to record, and select Video1 on the TV.
- To record and watch the same TV program, tune the VCR to the channel to record, and select Video2 on the TV.
- To record one TV program while watching another TV program, tune the VCR to the channel to record, and tune the TV to the channel to watch.

Note:

For the highest possible picture quality, use component video cables between the TV and DTV receiver/set-top box.

The TV side panel can be used to connect a VCR with S-video.

The unauthorized recording, use, distribution, or revision of television programs, videotapes, DVDs, and other materials is prohibited under the Copyright Laws of the United States and other countries, and may subject you to civil and criminal liability.

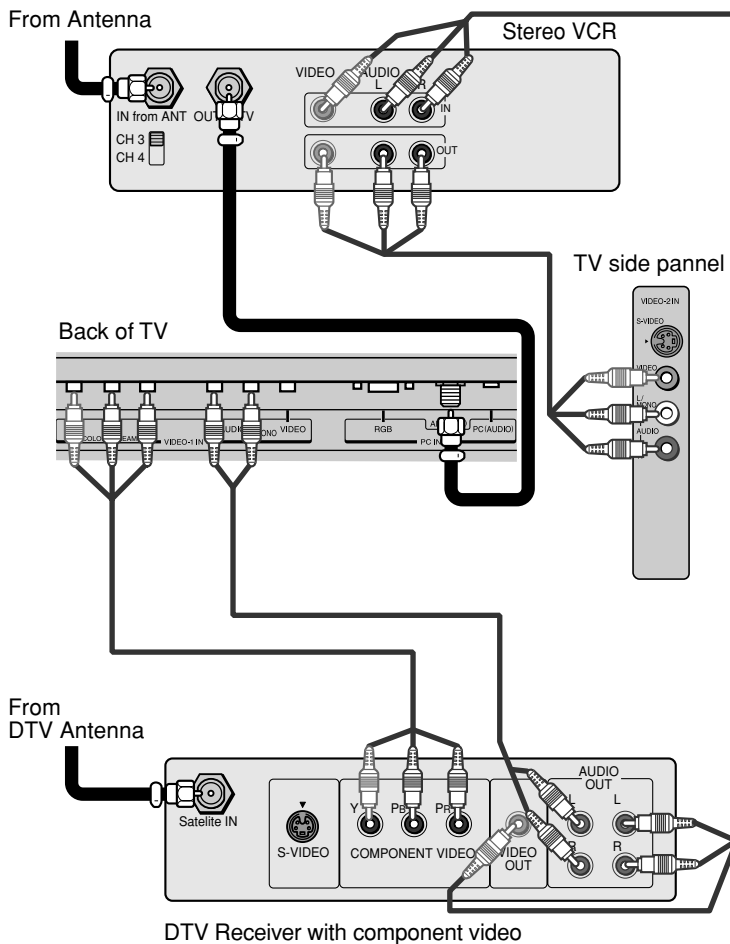

Connecting an audio system

This connection allows you to hear the TV sound through external speakers connected to an audio amplifier. The audio signal level (fixed) is not affected by pressing the volume buttons on the TV or the TV's remote control. To control the audio through the amplifier, use the audio system's remote control.

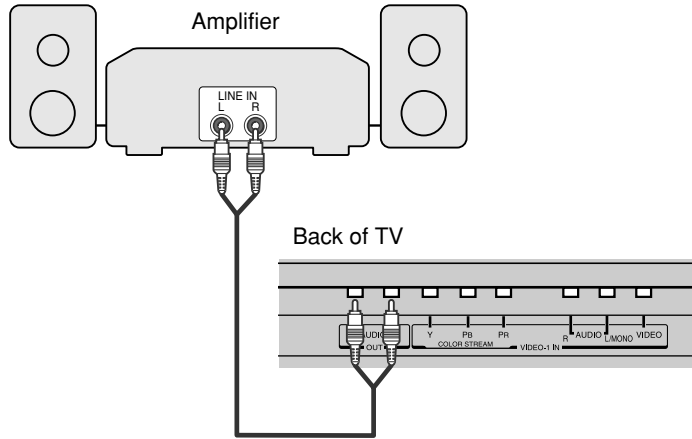

Note:

Set the TV's volume to the minimum level if necessary.

Connecting a camcorder

This connection allows you to watch video materials recorded on a camcorder.

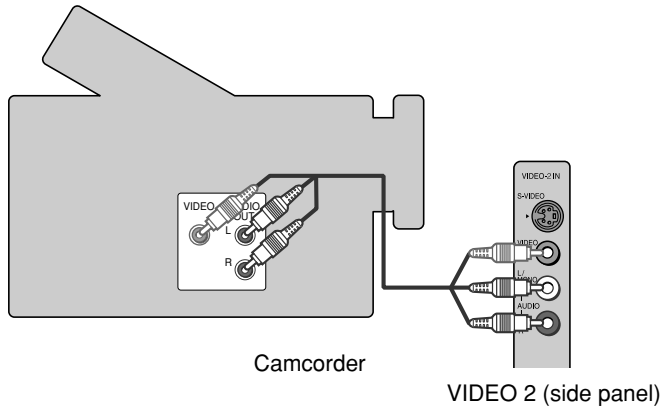

Note:

If you have a camcorder with S-video, use an S-video cable instead of a standard video cable for better picture performance.

Connecting a personal computer (PC)

This connection allows you to view the image of a personal computer (PC) on the TV screen. When connecting a PC to the TV, use an analog RGB (15-pin) computer cable and a PC audio cable.

- To use a PC, set the monitor output resolution on the PC before connecting it to the TV. The following signals can be displayed.
 - VGA: VESA 640 × 480 @ 60Hz (20DL15)
 - XGA: VESA 1024 × 768 @ 60Hz (15DL15)

Other formats or non-standard signals may not be displayed correctly.

- To display the optimum picture, use the PC setting feature. (see “Using the PC setting feature” on page 29).

Note:

- Some PC models cannot be connected to this TV.
- An adapter is not needed for computers with a DOS/V compatible mini D-sub 15-pin terminal.
- Depending on the DVD's title and the specifications of the PC on which you are playing the DVD-Video, some scenes may be skipped or you may not be able to pause during multi-angle scenes.

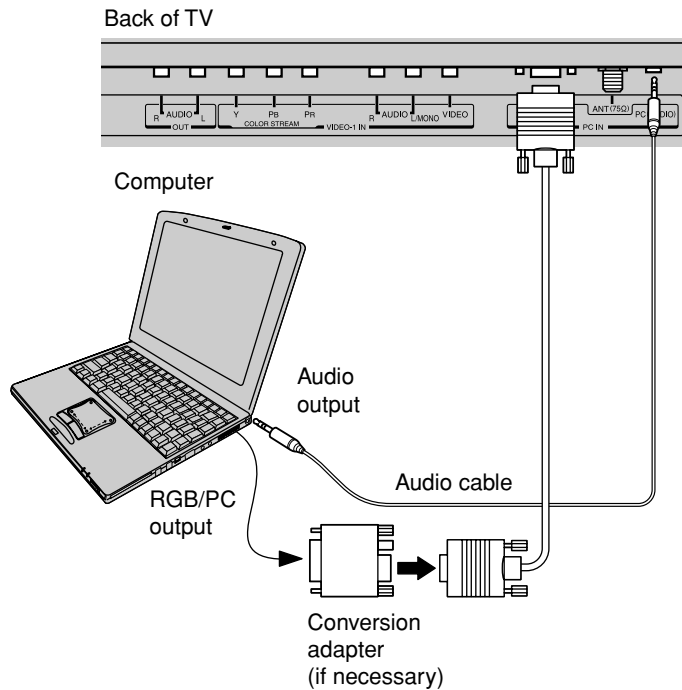

Using the remote control

Learning about the remote control

POWER turns the TV on and off (standby mode*)

MUTE turns off the sound (page 26)

RECALL displays TV settings on-screen (page 30)

MTS selects stereo or SAP sound (page 26)

TV/VIDEO selects the video input source (page 20)

Channel Numbers (0-9, 100) allow direct access to channels (page 19)

CH RTN switches between the last two viewed channels (page 20)

ENTER saves your menu settings (page 17)

▲▼ ◀▶ select or adjust menu items (page 17)

CH ▲▼ cycles through programmed channels (page 18)

VOL - + adjusts the volume level

CC selects the Caption or Text mode (page 25)

MENU opens the menu system (page 17)

EXIT exits the menu system (page 17)

SLEEP accesses to the automatic TV shut-off function (page 25)

PICTURE selects the picture mode (page 23)

SOUND selects the sound mode (page 27)

FAV. CH cycles through favorite channels (page 19)

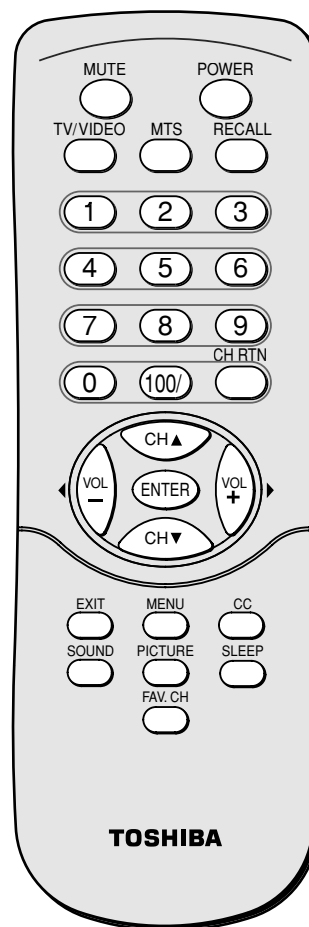

Installing the remote control batteries

To install the batteries:

1. Open the battery cover on the back of the remote control.
2. Install two batteries (R6 size "AA"). Match the + and - signs on the batteries to the signs on the battery compartment.

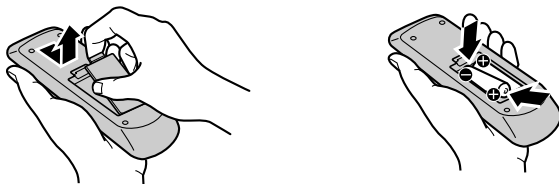

3. Replace the battery cover on the remote control until the lock snaps.

Remote control effective range

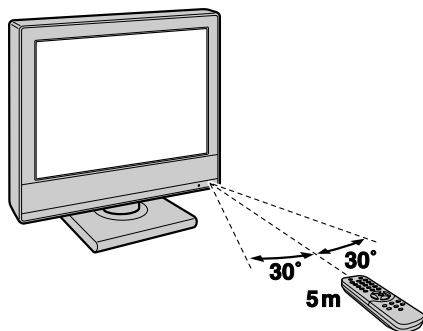

* The TV is in standby mode when the power is OFF but the power cord is still plugged into an outlet.

Caution:

Never throw batteries into a fire.

Note:

- Be sure to use AA size batteries.
- Dispose of batteries in a designated disposal area.
- Batteries should always be disposed of with the environment in mind. Always dispose of batteries in accordance with applicable laws and regulations.
- If the remote control does not operate correctly, or if the operating range becomes reduced, replace batteries with new ones.
- When necessary to replace batteries in the remote control, always replace both batteries with new ones. Never mix battery types or use new and used batteries in combination.
- Always remove batteries from remote control if they are dead or if the remote control is not to be used for an extended period of time. This will prevent battery acid from leaking into the battery compartment.

Setting up your TV

Learning about the menu system

After you have installed the batteries, you will need to set some preferences on the TV by using the menu system. You can access the menu system using the buttons on the TV or remote control.

1. Press MENU to display the menu system.
2. Press ◀ or ▶ to select a menu.
3. Press ENTER, and then press ▲ or ▼ to select an item.
4. Press ENTER, and then press ▲ or ▼ to select or adjust a setting.
5. Press ENTER to save your menu settings.

To return to the previous menu, press EXIT.

To close the menu system, press MENU.

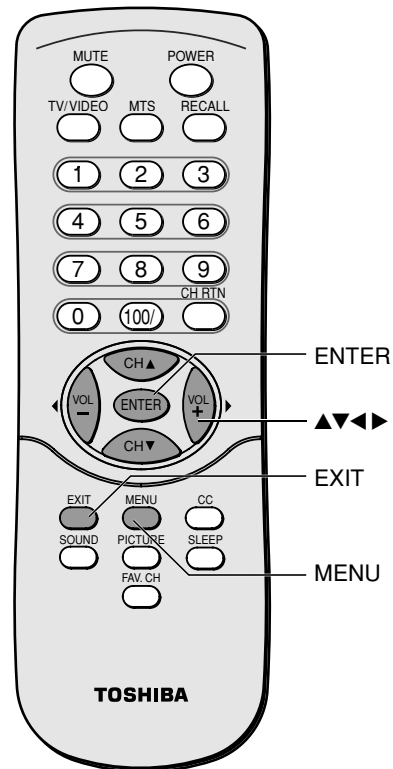
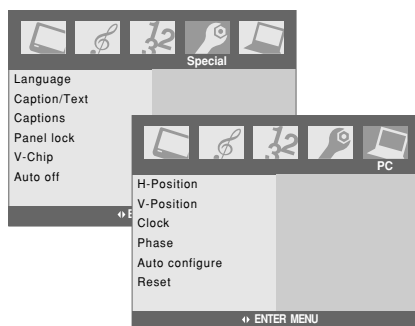
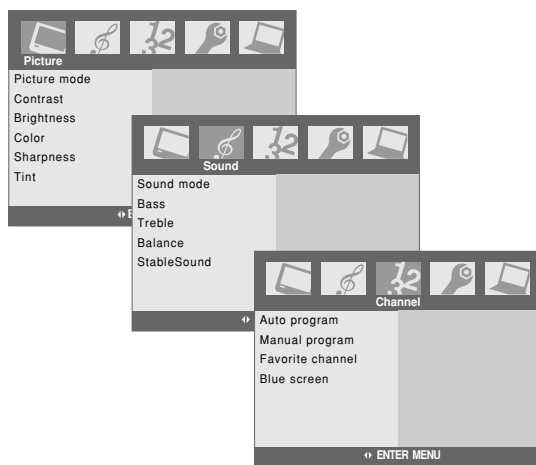

Note:

The PC mode is selectable only when the TV is in PC input mode and active picture is on-screen (see "Selecting the video input source" on page 20).

Changing the on-screen display language

You can choose from three different languages (English, Spanish and French) for the on-screen display of adjustment menus and messages.

To select a language:

1. Press MENU, and then press ◀ or ▶ until the Special menu appears.
2. Press ENTER, and then press ▲ or ▼ to highlight Language.
3. Press ENTER, and then press ▲ or ▼ to select your desired language.

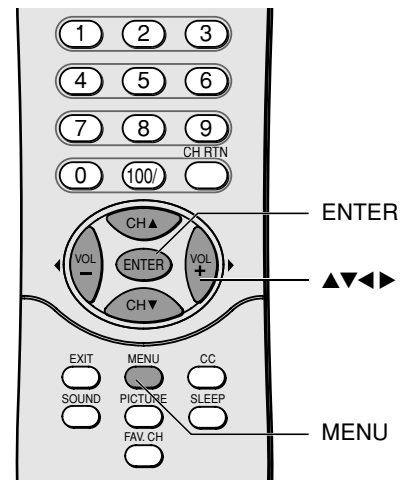

Adding channels to the TV's memory

When you press CH ▲ or CH ▼, your TV will stop only on the channels you program into the TV's channel memory.

Follow the steps below and on the next page to program all active channels into the TV's memory.

Programming channels automatically

Your TV can automatically detect all active channels in your area and store them in the channel memory. After the channels are programmed automatically, you can manually add or erase individual channels (see page 19).

To program channels automatically:

1. Press MENU, and then press ◀ or ▶ until the Channel menu appears.
2. Press ENTER, and then press ▲ or ▼ to highlight Auto program.



3. Press ENTER to start auto-programming. The TV will automatically cycle through all the TV and Cable channels, and store all active channels in the channel memory.

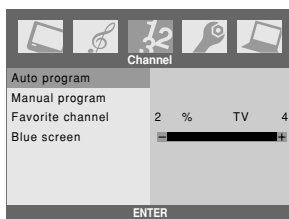

4. Press CH ▲ or CH ▼ to view the programmed channels.

Note:

- To tune the TV to a channel not programmed in the channel memory, you must use the Channel Number buttons on the remote control.
- If you press the ENTER button during auto-programming, the function will stop and only the channels programmed up to that time will be stored in the channel memory.

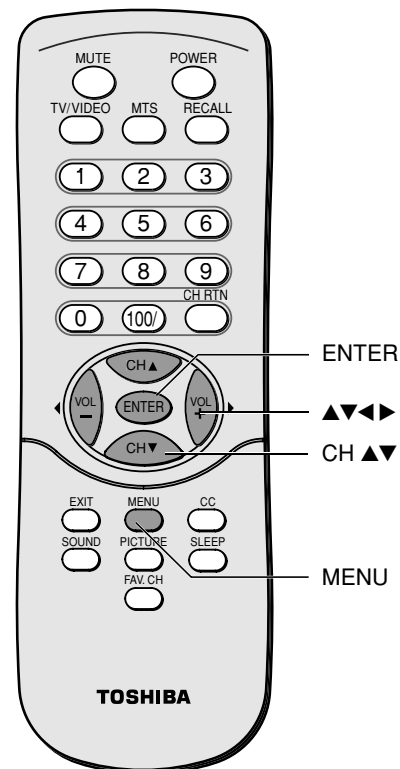

Adding and erasing channels manually

After you have automatically programmed the active channels into the TV's channel memory, you can manually add or erase specific channels.

To add or erase channels:

1. Press MENU, and then press ◀ or ▶ until the Channel menu appears.
2. Press ENTER, and then press ▲ or ▼ to highlight Manual program.
3. Press ENTER, and then press ◀ or ▶ to select a channel you want to add or erase.



4. Press ▼, and then press ◀ or ▶ to select Memory (add) or Erase. The current channel is added to Memory or erased from the channel list.

Changing channels

To change to a specific channel (programmed or unprogrammed):

Press the Channel Number buttons (0–9 and 100).

For channels 100 and higher, press the 100 button, and then the next two numbers. For example, to select channel 125, press 100, 2, 5.

To change to the next programmed channel:

Press CH ▲ or CH ▼ on the TV or remote control.

Programming your favorite channels

You can preset up to 8 of your favorite channels using the Favorite Channel Programming feature. Because this feature scans through only your favorite channels, it allows you to skip other channels you do not normally watch.

To program your favorite channels:

1. Press MENU, and then press ◀ or ▶ until the Channel menu appears.
2. Press ENTER, and then press ▲ or ▼ to highlight Favorite channel.
3. Press ENTER to display the Favorite Ch. menu.

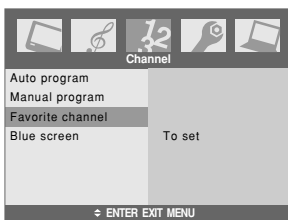

4. Press ▲ or ▼ to select the first favorite channel position.
5. Press ◀ or ▶ to set the desired channel number for the first favorite channel position.
6. Repeat steps 4 and 5 to program other channels.

To select your favorite channels:

Repeatedly press FAV. CH on the remote control.

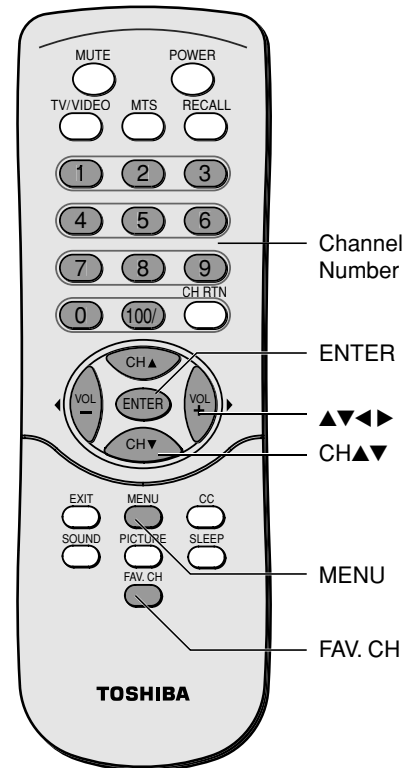
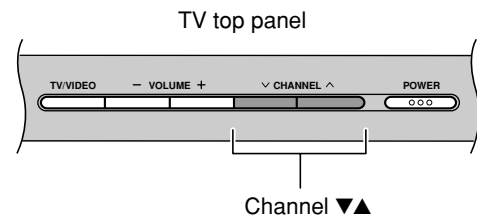

Using the TV's features

Switching between two channels using Channel Return

The Channel Return feature allows you to switch between two channels without entering an actual channel number each time.

To switch between two channels:

1. Select the first channel you want to view.
2. Select a second channel using the Channel Number buttons (0–9, 100).
3. Press CH RTN. The previous channel will be displayed.

Each time you press CH RTN, the TV will switch back and forth between the last two channels that were selected.

Using the Blue screen feature

With the Blue screen function On, the screen will automatically turn blue and the sound will be muted when no signal is received.

To turn on the Blue screen feature:

1. Press MENU, and then press ◀ or ▶ until the Channel menu appears.
2. Press ENTER, and then press ▲ or ▼ to highlight Blue screen.
3. Press ENTER, and then press ▲ or ▼ to select On.

Note: If the Blue screen appears repeatedly because of poor signal strength, select Off in step 3.

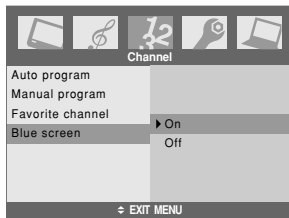

Selecting the video input source

Press TV/VIDEO to view a signal from another device connected to your TV, such as a VCR or DVD player. You can select Video1 (including ColorStream), Video2, or PC depending on which input jacks are used for connecting the devices (see “Connecting your TV” on page 10).

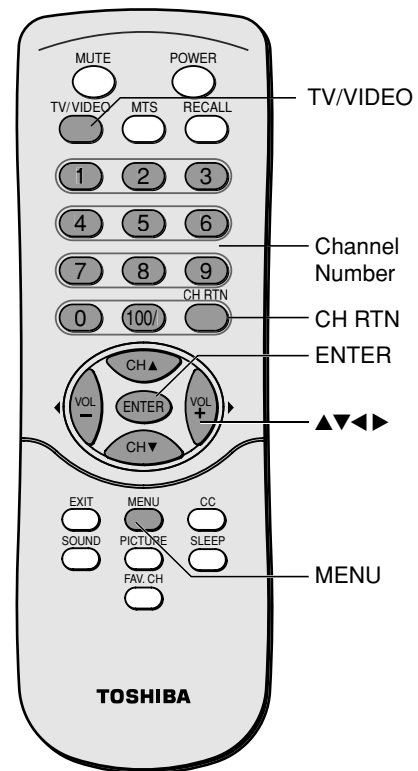
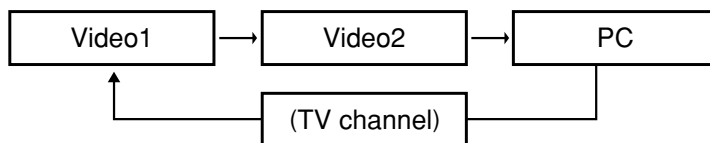

TV top panel

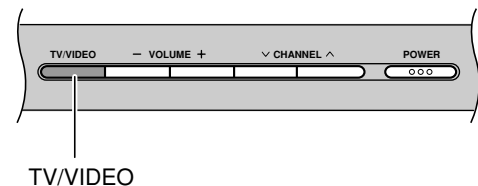

Using the V-Chip menu

Some TV programs and movies include signals that classify the content of the program (violence, sex, dialog, language). The V-Chip control feature in this TV detects the signals and blocks the programs according to your selections. To use this feature, perform the following setup.

1. Enable the Lock.
2. Set a four-digit password.
3. Select the ratings and categories you want to block.

V-Chip rating and categories

Rating guidelines are provided by broadcast stations. Most television programs and television movies can be blocked by TV rating and/or category. Movies that have been shown at the theaters and direct-to-video movies use the MPAA movie rating system instead.

For Movies previously shown in theaters :

Movie Ratings :

- Unblocked
- G & above (general audience)
- PG & above (parental guidance suggested)
- PG-13 & above (13 years and older)
- R & above (restricted)
- NC-17 & above (18 years and older)
- X (adult)

If you select "PG-13 & above," all G and PG rated movies will be available, and all PG-13, R, NC-17 and X rated movies will be blocked.

For Television programs including made-for-TV movies:

General TV Ratings:

- Unblocked
- TV-G & above (general audience)
(individual categories do not apply)
- TV-PG & above (parental guidance suggested)
- TV-14 & above (14 years and older)
- TV-MA (mature audience)

Children TV Ratings:

- Unblocked
- TV-Y & above (youth)
(individual content categories do not apply)
- TV-Y7 (youth, 7 years and up)

Content Categories:

- Dialog - sexual dialogue (applies to TV-PG & above, TV-14)
- Language - adult language (applies to TV-PG & above, TV-14 & above, TV-MA)
- Sex - sexual situations (applies to TV-PG & above, TV-14 & above, TV-MA)
- Violence (applies to TV-PG & above, TV-14 & above, TV-MA)
- F. Violence - fantasy violence (applies only to TV-Y7)
- No Rating (blocks all viewing)

Note:

The V-Chip function is available for the U.S. V-Chip system only. The Canadian V-Chip system is not supported.

V-Chip blocking (Parental control) setup

1. Press MENU, and then press ◀ or ▶ until the Special menu appears.
2. Press ENTER, and then press ▲ or ▼ to highlight V-Chip. Press ENTER.

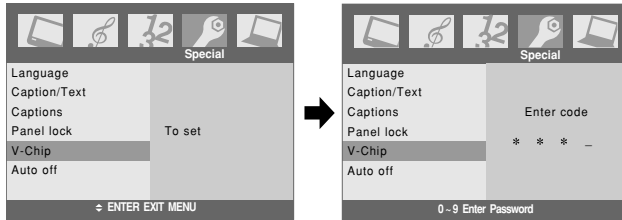

- If you already set a password, enter your four-digit password.
- If you have not created a password, the TV is initially set up with the password "0-0-0-0".
- If you cannot remember your password, press "7-7-7-7."

3. Enabling the Lock:

Press ▲ or ▼ to highlight Lock.
Press ENTER, and then press ▲ or ▼ to select On (Lock) or Off (Unlock).

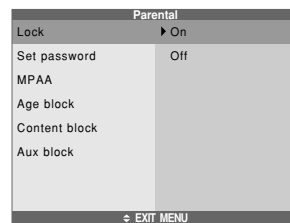

4. Set a password:

Press ▲ or ▼ to highlight Set password.
Press ENTER, and then enter a four-digit password.
Enter it again when requested.

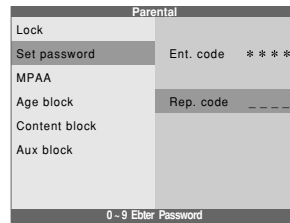

5. Press ▲ or ▼ to highlight the type of blocking to be set.
6. Press ENTER, and then press ▲ or ▼ to select the type of ratings to block.

- The age block and Content block menus also have sub-menus; therefore, you will need to repeat steps 5 and 6 to set the types of blocking and ratings in the sub-menus.

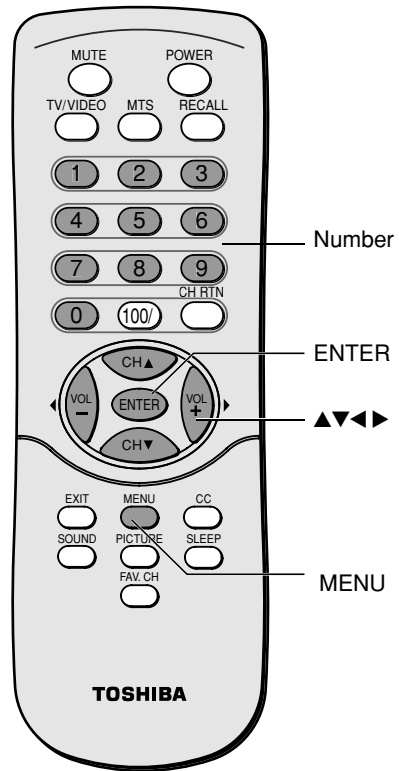
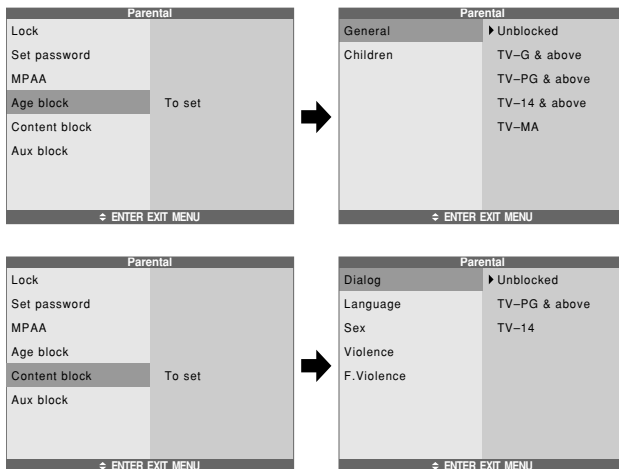

If you try to watch a TV program that exceeds the rating limits you set, the TV enters program lock mode.

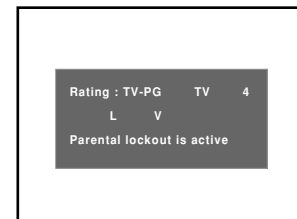

Adjusting the picture

Selecting the picture mode

You can select your desired picture type from four picture modes: Dynamic, Standard, Movie, or Memory.

Mode	Picture Quality
Dynamic	Bright and dynamic picture (factory setting)
Standard	Standard picture setting (factory setting)
Movie	Movie-like picture setting (factory setting)
Memory	Your personal preference

To select the picture mode:

Press PICTURE repeatedly to select the mode you prefer.

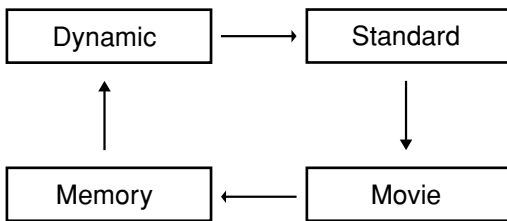

You can also select the picture mode by using the Picture menu:

1. Press MENU, and then press ◀ or ▶ until the Picture menu appears.
2. Press ENTER, and then press ▼ or ▲ to highlight Picture mode.
3. Press ENTER, and then press ▼ or ▲ to select the mode you prefer.

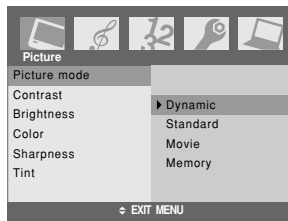

Adjusting the picture quality

You can adjust the picture quality to your personal preferences, including the contrast, brightness, color, sharpness, and tint.

Selection	◀ Pressing	▶
Contrast	lower	higher
Brightness	darker	lighter
Color	paler	deeper
Sharpness	softer	sharper
Tint	reddish	greenish

To adjust the picture quality:

1. Press MENU, and then press ◀ or ▶ until the Picture menu appears.
2. Press ENTER, and then press ▲ or ▼ until the item you want to adjust is highlighted.
3. Press ENTER.
4. Press ◀ or ▶ to adjust the level.

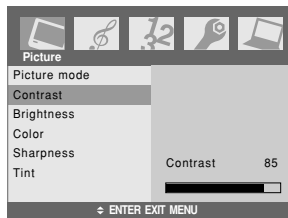

The Picture qualities you adjusted can be saved in the TV's Memory.

Note:

If you select one of the factory-set picture modes (Dynamic, Standard, or Movie) and then adjust a picture quality setting (for example, increase the contrast), the picture mode automatically changes to Memory in the Picture menu.

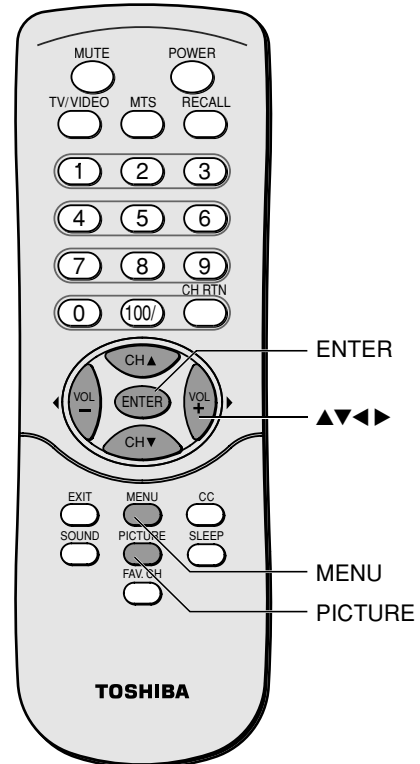

Using the closed caption feature

The closed caption feature has two options:

- Captions—An on-screen display of the dialogue, narration, and sound effects of TV programs and videos that are closed captioned (usually marked as “CC” in TV listings).
- Text—An on-screen display of information not related to the current program, such as weather or stock data (when provided by individual stations).

To select captions or text:

1. Tune the TV to the desired program.
2. Press MENU, and then press ◀ or ▶ to display the Special menu.
3. Press ENTER, and then press ▲ or ▼ to highlight Caption/Text.

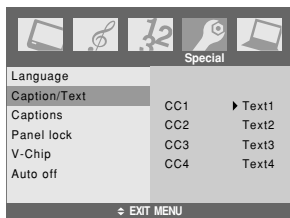

4. Press ENTER, and then press ▲ or ▼ to select the Caption or Text mode you prefer.

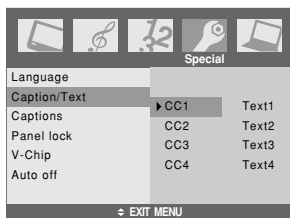

- To view captions, select CC1, CC2, CC3, or CC4 (CC1 displays captions in the primary language in your area).

Note: If the program or video you selected is not closed captioned, the captions will not display on the screen.



- To view text, select Text1, Text2, Text3, or Text4.

Note: If text is not available in your area, a black rectangle may appear on your screen. If this happens, turn the Closed Caption feature Off.

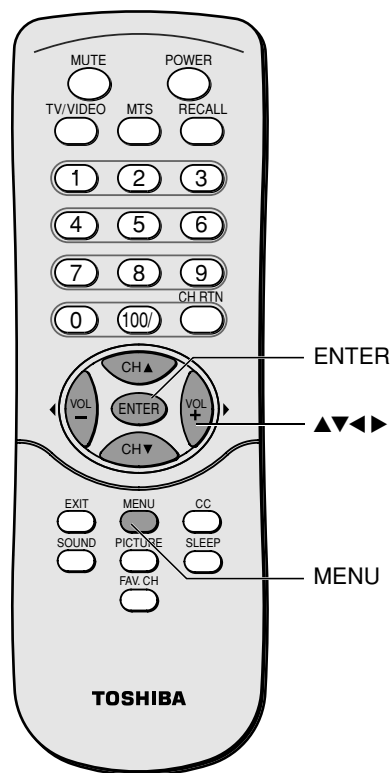
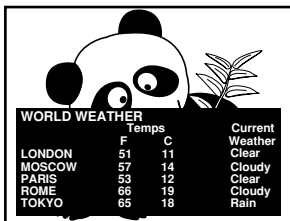

Note:

A closed caption signal may not display in the following situations:

- When a videotape has been dubbed
- When the signal reception is weak
- When the signal reception is nonstandard

To turn on or off the Closed Caption feature

1. Press MENU, and then press ◀ or ▶ to display the Special menu.
2. Press ENTER, and then press ▲ or ▼ to highlight Captions.
3. Press ENTER, and then press ▲ or ▼ to select On, Advanced mute or Off.
 - Advanced mute activates the selected Caption or Text mode when the TV sound is muted.

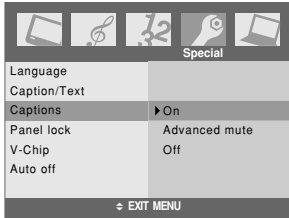

The CC button on the remote control can also be used to select On, Advanced mute (see page 30), or Off.

Using the Panel lock feature

You can lock the control buttons on the TV to prevent your settings from being changed accidentally (by children, for example).

When the Panel lock is On, no control buttons on the TV top panel will operate except POWER.

To lock the top panel:

1. Press MENU, and then press ◀ or ▶ to display the Special menu.
2. Press ENTER, and then press ▲ or ▼ to highlight Panel lock.
3. Press ENTER, and then press ▲ or ▼ to select On.

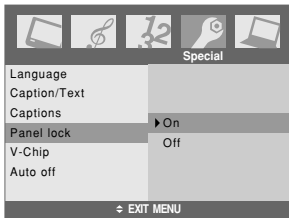

To unlock the top panel:
Select Off in step 3 above.

Setting the sleep timer

To set the sleep timer to turn off the TV automatically:

Repeatedly press SLEEP to set the length of time until the TV turns off.

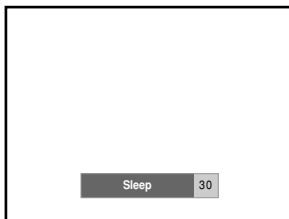

Every time you press SLEEP, the time display will increase by 30 minutes, up to 120 minutes.

30 → 60 → 90 → 120 → ---

To cancel the sleep timer:

Press SLEEP until "Sleep ---" appears.

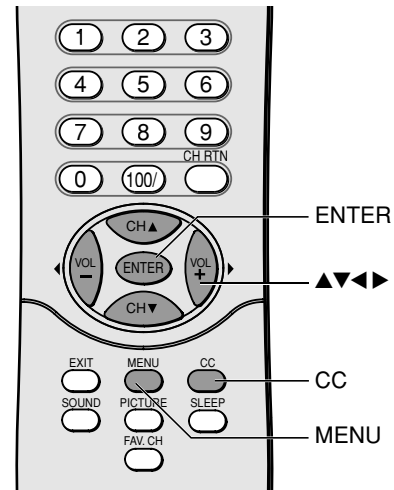

TV top panel

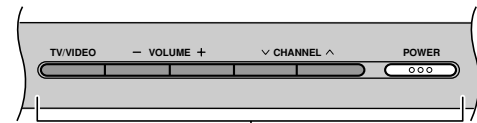

Control buttons

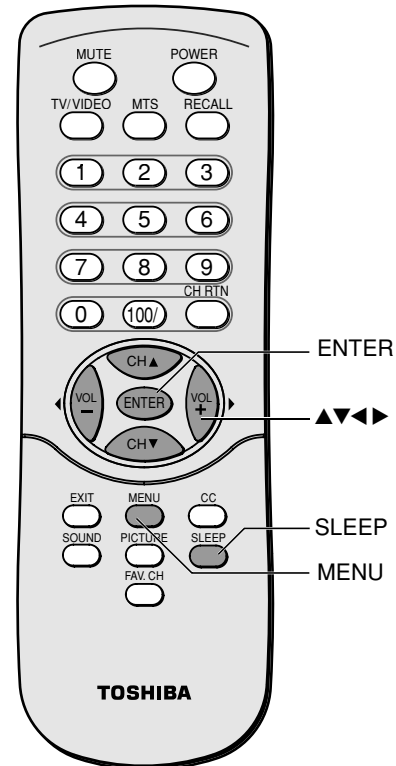

Note :

- When an instant power failure occurs, the sleep timer settings may be cleared.
- To display the amount of time left until the TV turns off automatically, press SLEEP once.

Adjusting the sound

Muting the sound

Press MUTE to temporarily turn off the sound. While the sound is off, the screen will display “Mute” in the lower left corner.

When you select “MUTE” mode, the closed caption feature is automatically activated. To deactivate this feature, deactivate MUTE. This feature works only when the closed caption mode is set to Advanced mute. See “Using the closed caption feature” on page 24 for more information.

Selecting stereo/SAP broadcasts

The multi-channel TV sound (MTS) feature allows you to listen to high-fidelity stereo sound while watching TV. MTS can also transmit a second audio program (SAP) containing a second language, music, or other audio information (when provided by individual stations).

When the TV receives a stereo or SAP broadcast, the word “ST.SAP”, “Stereo” or “SAP” appears on-screen every time the TV is turned on, the channel is changed, or the RECALL button is pressed.

The MTS feature is not available when the TV is in Video mode.

To listen to stereo sound:

Repeatedly press MTS to select Stereo.



You can leave your TV in Stereo mode because it will automatically output the type of sound being broadcast (stereo or monaural).

If the stereo sound is noisy, select Mono to reduce the noise.

To listen to SAP (if available):

Press MTS repeatedly to select SAP.

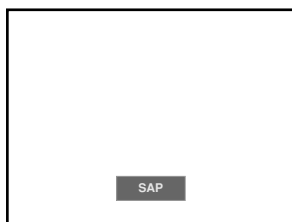

You will hear the station's second audio program (if available) from the speakers, while viewing the original program's picture.

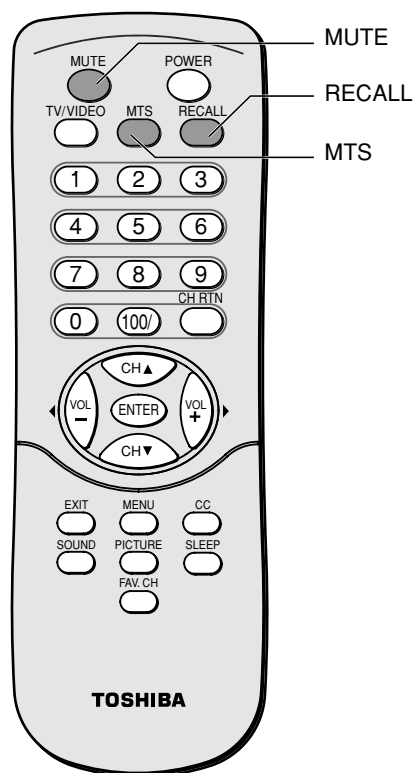

Using the WOW™ surround sound feature

WOW surround widens and deepens audio listening field to deliver exceptional sound from the TV's speakers. The feature uses stereo signals from a TV broadcast or video input.

To activate the WOW feature:

1. Select Stereo mode (see "Selecting stereo/SAP broadcasts" on page 26).
2. Press MENU, and then press ◀ or ▶ until the Sound menu appears.
3. Press ENTER, and then press ▲ or ▼ to highlight Sound mode.
4. Press ENTER, and then press ▲ or ▼ to select WOW.

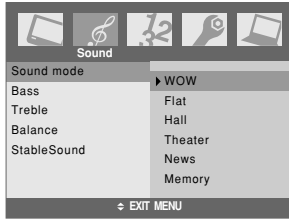

Selecting the sound mode

You can select your desired sound type from six sound modes: WOW, Flat, Hall, Theater, News, or Memory.

Press SOUND repeatedly to select the appropriate sound mode as shown:

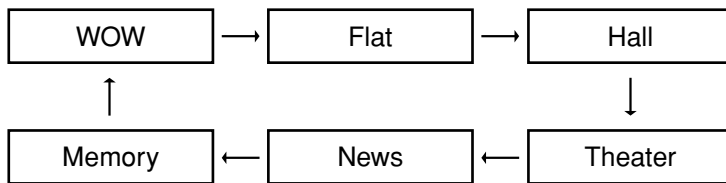

Mode	Sound Quality
WOW	see above
Flat	flat sound (factory setting)
Hall	a concert hall filled with a rich warm sound (factory setting)
Theater	a movie theater filled with a dynamic sound (factory setting)
News	news/dialogue (factory setting)
Memory	your personal preference

You can also select the desired sound mode by using the Sound menu.

Note:

If the broadcast is monaural, the WOW sound effect will not work.

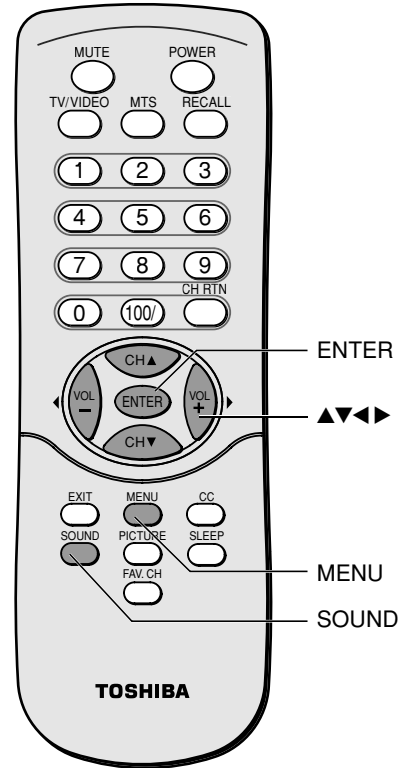

Note:

If you select one of the factory-set audio modes (WOW, Flat, Hall, Theater, or News) and then change a sound quality setting (for example, increase the bass), the sound mode automatically change to Memory mode.

WOW, SRS, and ● symbol are trademarks of SRS Labs, Inc.
WOW technology is incorporated under license from SRS Labs, Inc.

Adjusting the sound quality

You can change the quality of your TV's sound by adjusting the bass, treble, and balance.

To adjust the sound quality:

1. Press MENU, and then press ◀ or ▶ until the Sound menu appears.
2. Press ENTER, and then press ▲ or ▼ to highlight the item you want to adjust.

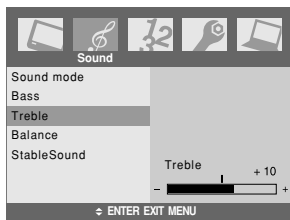

3. Press ENTER.
4. Press ◀ or ▶ to adjust the level.

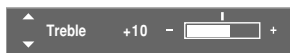

- ◀ makes the sound quality weaker or increases the balance in the left channel, depending on the item selected.
- ▶ makes the sound quality stronger or increases the balance in the right channel, depending on the item selected.

Note:

To continue adjusting the other items, press ▲ or ▼ in step 4.

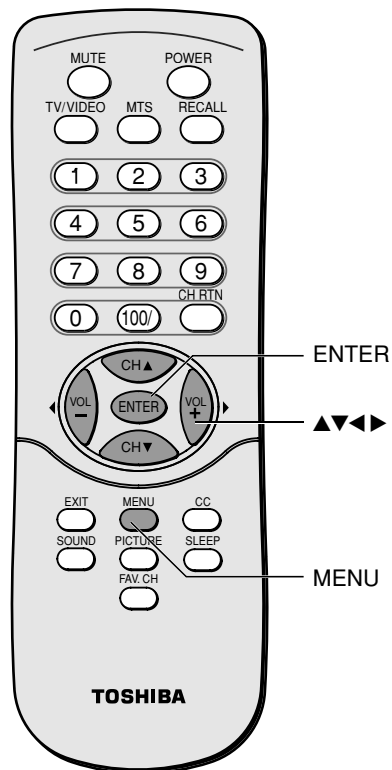

Using the StableSound® feature

When the signal source is changed, the StableSound feature limits the highest volume level to prevent extreme changes in volume (for example, to prevent the sudden increase in volume that often happens when a TV program switches to a commercial).

To turn on the StableSound feature:

1. Press MENU, and then press ◀ or ▶ until the Sound menu appears.
2. Press ENTER, and then press ▲ or ▼ to highlight StableSound.
3. Press ENTER, and then press ▲ or ▼ to select On.

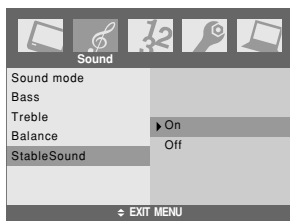

To turn off the StableSound feature:
Select Off in step 3 above.

Using the PC setting feature

You can adjust the horizontal/vertical picture position, clock (to minimize vertical stripes on the screen), and phase (to remove horizontal noise and sharpen the picture).

You can auto-configure and reset these settings.

1. Confirm a PC is connected (see “Connecting a personal computer (PC)” on page 15).
2. Repeatedly press TV/VIDEO to select PC input mode. (See “Selecting the video input source” on page 20.)
3. Press MENU, and then press ◀ or ▶ until the PC menu appears.
4. Press ENTER, and then press ▲ or ▼ to select an item.

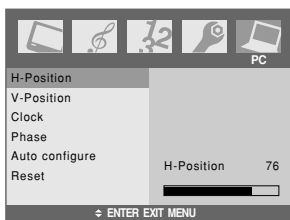

5. Press Enter.
6. Press ◀ or ▶ to make the appropriate adjustments.
 - H-position/V-position
Adjusts picture left/right and up/down. The adjustment range is 0–100. (The adjustable range may vary depending on the input mode.)
 - Clock
Minimizes any vertical bars or stripes appearing on the screen background. The adjustment range is 0–100. (The adjustable range may vary depending on the input mode.)
 - Phase
Reduces (or minimizes) any horizontal noise and clears up or sharpens the character images. The range adjustment is 0–100. (The adjustable range may vary depending on the input mode.)
 - Auto configure
Automatically adjusts the screen position, clock, and phase. (The displayed image will disappear for a few seconds while auto-configuration is in progress.)
 - Reset
Returns to the default settings programmed at the factory. The values in the Reset function cannot be modified.

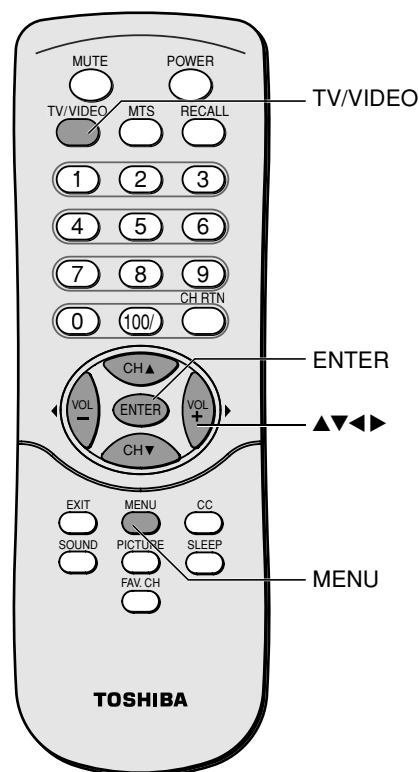
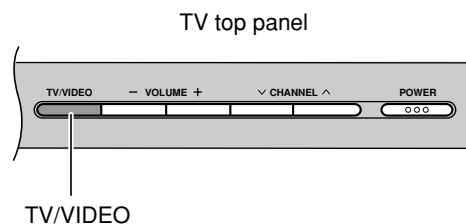

Using the Auto off feature

When the Auto off feature is set to On, the TV will automatically turn itself off after approximately 15 minutes if it is tuned to a vacant channel or a station that completes its broadcast for the day. This feature does not work when the Blue screen mode is set to Off.

To activate the Auto off feature:

1. Press MENU, and then press ◀ or ▶ until the Special menu appears.
2. Press ENTER, and then press ▲ or ▼ to highlight Auto off.
3. Press ENTER, and then press ▲ or ▼ to Select On.



To deactivate the Auto off feature:
Select Off in step 3 above.

Displaying on-screen information

Press RECALL to display the following information on-screen:

- Channel number or Video mode selected
- Stereo or SAP audio status

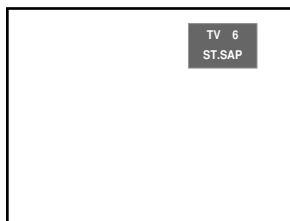

Understanding the last mode memory feature

If the power is cut off while you are viewing the TV, the Last Mode Memory feature turns on the TV automatically when the power is resupplied.

If the power is going to be off for a long time and you are going to be away from your TV, unplug the power cord to prevent the TV from turning on in your absence.

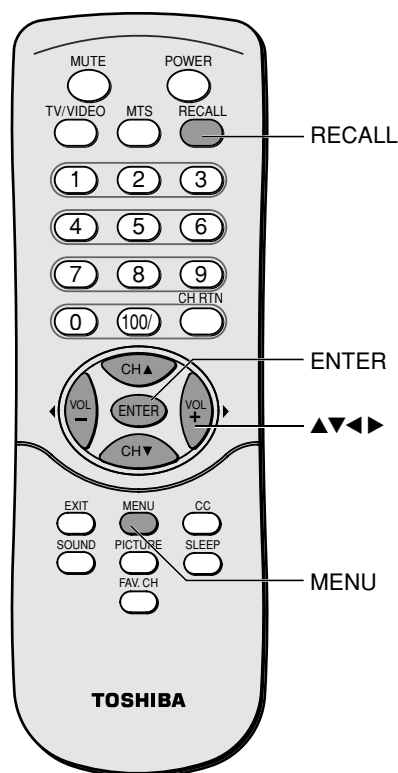

Appendix

Specifications

- This model complies with the specifications listed below.
- Designs and specifications are subject to change without notice.



WARNING: RISK OF ELECTRIC SHOCK !

Never attempt to service the TV yourself. Opening and removing the covers may expose you to dangerous voltage or other hazards. Refer all servicing to a Toshiba Authorized Service Center.

Television System NTSC standard	Dimensions (Including TV stand) 15DL15: Width : 15 inches (379 mm) Height : 15-3/8 inches (388 mm) Depth : 8 inches (203 mm) 20DL15: Width : 19-3/8 inches (491 mm) Height : 18-1/2 inches (469 mm) Depth : 9 inches (228 mm)
Channel Coverage VHF: 2 through 13 UHF: 14 through 69 Cable TV: Mid band (A-8 through A-1, A through I) Super band (J through W) Hyper band (AA through ZZ, AAA, BBB) Ultra band (65 through 94, 100 through 125)	Mass (weight) 15DL15: 12.4 lbs (5.6 kg) 20DL15: 20.9 lbs (9.1 kg)
Power Source 100-240 V AC, 60 Hz	Operating conditions Temperature: 32°F – 95°F (0°C – 35°C) Humidity: 20 – 80% (no moisture condensation)
Power Consumption 15DL15: 50 W 20DL15: 65 W 0.8 W in standby mode	
Audio Power 5 W + 5 W	
Video/Audio Terminals S-VIDEO INPUT Y : 1 V(p-p), 75 ohms, negative sync. C : 0.286 V(p-p) (burst signal), 75 ohms VIDEO/AUDIO INPUT VIDEO: 1 V(p-p), 75 ohms, negative sync. AUDIO: 400 mV(rms) (30% modulation equivalent, 22k ohms or greater) ColorStream® (Component video) INPUT Y : 1V(p-p), 75 ohms PR: 0.7 V(p-p), 75 ohms PB: 0.7 V(p-p), 75 ohms AUDIO: 400 mV(rms), 22k ohms or greater Suggested resolutions: 480i, 480p AUDIO OUTPUT 400 mV(rms) (30% modulation equivalent, 2.2k ohms or less) HEADPHONE jack 3.5 mm stereo mini jack PC INPUT 15-pin D-sub Analog RGB PC AUDIO INPUT 3.5 mm stereo mini jack	

Troubleshooting

Before calling a service technician, please check the following table for a possible cause of the symptom and some solutions.

Symptom	Solution
TV will not turn on	<ul style="list-style-type: none">• Make sure the power cord is plugged in, then press POWER.• The remote control batteries may be dead. Replace the batteries.
No picture, no sound	<ul style="list-style-type: none">• Check the antenna/cable connections.
No sound, picture OK	<ul style="list-style-type: none">• The sound may be muted. Press VOLUME.• The station may have broadcast difficulties. Try another channel.• Make sure the MTS feature is set properly.
Poor picture, sound OK	<ul style="list-style-type: none">• Check the antenna connections.• The station may have broadcast difficulties. Try another channel.• Adjust the Picture menu.
Poor reception of broadcast channels	<ul style="list-style-type: none">• The station may have broadcast difficulties. Try another channel.• Check the antenna connections.
Black box appears on the screen	<ul style="list-style-type: none">• The closed caption feature may be set to one of the Text modes (Text1, Text2, Text3, or Text4). Turn closed captioning Off.
Unable to select a certain channel	<ul style="list-style-type: none">• The channel may be erased with the Manual programming feature.
Multiple images	<ul style="list-style-type: none">• The station may have broadcast difficulties. Try another channel.• Antenna reception may be poor. Use a highly directional outdoor antenna.
Poor color or no color	<ul style="list-style-type: none">• The station may have broadcast difficulties. Try another channel.• Adjust the Tint and/or Color in the Picture menu.
No stereo or SAP sound from a known MTS broadcast	<ul style="list-style-type: none">• Make sure the MTS feature is set properly.
The top panel buttons do not operate	<ul style="list-style-type: none">• Check the Panel lock feature.
The remote control does not operate	<ul style="list-style-type: none">• Remove all obstructions between the remote control and the remote control sensor in the TV.• The remote control batteries may be dead. Replace the batteries.

Limited United States Warranty for LCD Televisions, 20" and smaller

Toshiba America Consumer Products, L.L.C. ("TACP") makes the following limited warranties to original consumers in the United States. THESE LIMITED WARRANTIES EXTEND TO THE ORIGINAL CONSUMER PURCHASER OR ANY PERSON RECEIVING THIS LCD TELEVISION AS A GIFT FROM THE ORIGINAL CONSUMER PURCHASER AND TO NO OTHER PURCHASER OR TRANSFEREE.

LCD TELEVISIONS PURCHASED IN THE U.S.A. AND USED ANYWHERE OUTSIDE OF THE U.S.A., INCLUDING, WITHOUT LIMITATION, CANADA AND MEXICO, ARE NOT COVERED BY THESE WARRANTIES.

LCD TELEVISIONS PURCHASED ANYWHERE OUTSIDE OF THE U.S.A., INCLUDING, WITHOUT LIMITATION, CANADA AND MEXICO, AND USED IN THE U.S.A., ARE NOT COVERED BY THESE WARRANTIES.

Limited One (1) Year Warranty on Parts and Labor

TACP warrants this LCD Television and its parts against defects in materials or workmanship for a period of one (1) year after the date of original retail purchase. DURING THIS PERIOD, TACP WILL, AT TACP'S OPTION, REPAIR OR REPLACE A DEFECTIVE PART WITH A NEW OR REFURBISHED PART WITHOUT CHARGE TO YOU.

Rental Units

The warranty for LCD Television rental units begins on the date of the first rental or thirty (30) days after the date of shipment to the rental firm, whichever comes first.

Limited Warranty for Commercial Units

TACP warrants LCD Televisions that are sold and used for commercial purposes as follows: all parts are warranted against defects in materials or workmanship for a period of ninety (90) days after the date of original retail purchase. DURING THIS PERIOD, TACP WILL, AT TACP'S OPTION, REPAIR OR REPLACE A DEFECTIVE PART WITH A NEW OR REFURBISHED PART WITHOUT CHARGE TO YOU.

Owner's Manual and Product Registration Card

Read this owner's manual thoroughly before operating this LCD Television.

Complete and mail the enclosed product registration card or register your LCD Television online at www.tacp.toshiba.com/service as soon as possible. By registering your LCD Television you will enable TACP to bring you new products specifically designed to meet your needs and help us to contact you in the unlikely event a safety notification is required under the U.S. Consumer Product Safety Act. Failure to complete and return the product registration card does not diminish your warranty rights.

Your Responsibility

THE ABOVE WARRANTIES ARE SUBJECT TO THE FOLLOWING CONDITIONS:

- (1) You must retain your original bill of sale or provide other proof of purchase.
- (2) All warranty servicing of this LCD Television must be made by the Depot Warranty Repair Center specified by the TACP Consumer Solutions Center.
- (3) The warranties from TACP are effective only if this LCD Television is purchased and operated in the Continental U.S.A. or Puerto Rico.
- (4) Labor service charges for set installation, setup, adjustment of customer controls, and installation or repair of antenna systems are not covered by this warranty. Reception problems caused by inadequate antenna systems, misaligned satellite dishes, cable television distribution, VCRs, DVD players/recorders, personal computer level IEEE-1394 devices, and any other connected signal source device are your responsibility.

- (5) Warranties extend only to defects in materials or workmanship as limited above, and do not extend to any LCD Television or parts that have been lost or discarded by you or to damage to the LCD Television or parts caused by fires, misuse, accident, Acts of God (such as lightning or fluctuations in electric power), improper installation, improper maintenance, or use in violation of instructions furnished by TACP; use or malfunction through simultaneous use of this LCD Television and connected equipment; or to units that have been modified or had the serial number removed, altered, defaced, or rendered illegible.

How to Obtain Warranty Service

If, after following all of the operating instructions in this manual and reviewing the section entitled "Troubleshooting," you find that service is needed:

- (1) For instructions on how to obtain warranty service for your LCD Television, contact TACP's Consumer Solution Center toll free at 1-800-631-3811.
- (2) You must include the original bill of sale (or a copy thereof) or other proof of purchase along with the entire LCD Television to the Depot Warranty Repair Center specified by the TACP Consumer Solutions Center. You are responsible for all inbound transportation and insurance charges for the LCD Television to the Depot Warranty Repair Center specified by the TACP Consumer Solutions Center.

**For additional information, visit TACP's website:
www.tacp.toshiba.com**

ALL WARRANTIES IMPLIED BY THE LAW OF ANY STATE OF THE U.S.A., INCLUDING THE IMPLIED WARRANTIES OF MERCHANTABILITY AND FITNESS FOR A PARTICULAR PURPOSE, ARE EXPRESSLY LIMITED TO THE DURATION OF THE LIMITED WARRANTIES SET FORTH ABOVE. WITH THE EXCEPTION OF ANY WARRANTIES IMPLIED BY THE LAW OF ANY STATE OF THE U.S.A. AS HEREBY LIMITED, THE FOREGOING WARRANTY IS EXCLUSIVE AND IN LIEU OF ALL OTHER WARRANTIES, GUARANTEES, AGREEMENTS, AND SIMILAR OBLIGATIONS OF TACP WITH RESPECT TO THE REPAIR OR REPLACEMENT OF ANY PARTS. IN NO EVENT SHALL TACP BE LIABLE FOR CONSEQUENTIAL OR INCIDENTAL DAMAGES (INCLUDING, BUT NOT LIMITED TO, LOST PROFITS, BUSINESS INTERRUPTION, OR MODIFICATION OR ERASURE OF RECORDED DATA CAUSED BY USE, MISUSE OR INABILITY TO USE THIS LCD TELEVISION).

No person, agent, distributor, dealer, or company is authorized to change, modify, or extend the terms of these warranties in any manner whatsoever. The time within which an action must be commenced to enforce any obligation of TACP arising under the warranty or under any statute or law of the United States or any state thereof is hereby limited to ninety (90) days from the date you discover, or should have discovered, the defect. This limitation does not apply to implied warranties arising under the law of any state of the U.S.A.

THIS WARRANTY GIVES YOU SPECIFIC LEGAL RIGHTS AND YOU MAY ALSO HAVE OTHER RIGHTS WHICH MAY VARY FROM STATE TO STATE IN THE U.S.A. SOME STATES OF THE U.S.A. DO NOT ALLOW LIMITATIONS ON THE DURATION OF AN IMPLIED WARRANTY, WHEN AN ACTION MAY BE BROUGHT, OR THE EXCLUSION OR LIMITATION OF INCIDENTAL OR CONSEQUENTIAL DAMAGES. THEREFORE, THE ABOVE PROVISIONS MAY NOT APPLY TO YOU UNDER SUCH CIRCUMSTANCES.

Limited Canada Warranty for LCD Televisions, 20" and smaller

Toshiba Canada Limited, ("TCL") makes the following limited warranties to original consumers in Canada. THESE LIMITED WARRANTIES EXTEND TO THE ORIGINAL CONSUMER PURCHASER OR ANY PERSON RECEIVING THIS LCD TELEVISION AS A GIFT FROM THE ORIGINAL CONSUMER PURCHASER AND TO NO OTHER PURCHASER OR TRANSFEREE.

LCD TELEVISIONS PURCHASED IN CANADA AND USED ANYWHERE OUTSIDE OF CANADA, INCLUDING, WITHOUT LIMITATION, THE U.S.A. AND MEXICO, ARE NOT COVERED BY THESE WARRANTIES.

LCD TELEVISIONS PURCHASED ANYWHERE OUTSIDE OF CANADA, INCLUDING, WITHOUT LIMITATION, THE U.S.A. AND MEXICO, AND USED IN CANADA ARE NOT COVERED BY THESE WARRANTIES.

Limited One (1) Year Warranty on Parts and Labour

TCL warrants this LCD Television and its parts against defects in materials or workmanship for a period of one (1) year after the date of original retail purchase. DURING THIS PERIOD, TCL WILL, AT TCL'S OPTION, REPAIR OR REPLACE A DEFECTIVE PART WITH A NEW OR REFURBISHED PART WITHOUT CHARGE TO YOU. YOU MUST DELIVER THE ENTIRE TELEVISION TO AN AUTHORIZED TCL SERVICE DEPOT. YOU MUST PAY FOR ALL TRANSPORTATION AND INSURANCE CHARGES FOR THE TELEVISION TO AND FROM THE SERVICE DEPOT.

Rental Units

The warranty for LCD Television rental units begins on the date of the first rental or thirty (30) days after the date of shipment to the rental firm, whichever comes first.

Limited Warranty for Commercial Units

TCL warrants LCD Televisions that are sold and used for commercial purposes as follows: all parts are warranted against defects in materials or workmanship for a period of ninety (90) days after the date of original retail purchase. DURING THIS PERIOD, TCL WILL, AT TCL'S OPTION, REPAIR OR REPLACE A DEFECTIVE PART WITH A NEW OR REFURBISHED PART WITHOUT CHARGE TO YOU. YOU MUST DELIVER THE ENTIRE TELEVISION TO AN AUTHORIZED TCL SERVICE DEPOT. YOU MUST PAY FOR ALL TRANSPORTATION AND INSURANCE CHARGES FOR THE TELEVISION TO AND FROM THE SERVICE DEPOT.

Owner's Manual and Product Registration

Read this owner's manual thoroughly before operating this LCD Television.

Register your LCD Television online at www.toshiba.ca as soon as possible. By registering your LCD Television you will enable TCL to bring you new products specifically designed to meet your needs and help us to contact you in the unlikely event a safety notification is required. Failure to register your LCD Television does not diminish your warranty rights.

Your Responsibility

THE ABOVE WARRANTIES ARE SUBJECT TO THE FOLLOWING CONDITIONS:

- (1) You must retain your original bill of sale or provide other proof of purchase.
- (2) All warranty servicing of this LCD TV must be made by an Authorized TCL Service Depot.
- (3) The warranties from TCL are effective only if this LCD Television is purchased in Canada from an authorized TCL dealer and operated in Canada.
- (4) Labour service charges for set installation, setup, adjustment of customer controls, and installation or repair of antenna

systems are not covered by this warranty. Reception problems caused by inadequate antenna systems, misaligned satellite dishes, cable television distribution, VCRs, DVD players/recorders, personal computer level IEEE-1394 devices, and any other connected signal source device are your responsibility.

- (5) Warranties extend only to defects in materials or workmanship as limited above, and do not extend to any LCD Television or parts that have been lost or discarded by you or to damage to the LCD Television or parts caused by fires, misuse, accident, Acts of God (such as lightning or fluctuations in electric power), improper installation, improper maintenance, or use in violation of instructions furnished by TCL; use or malfunction through simultaneous use of this LCD Television and connected equipment; or to units that have been modified or had the serial number removed, altered, defaced, or rendered illegible.

How to Obtain Warranty Service

If, after following all of the operating instructions in this manual and reviewing the section entitled "Troubleshooting," you find that service is needed:

- (1) To find the nearest TCL Authorized Service Depot, visit TCL's web site at www.toshiba.ca.
- (2) You must include the original bill of sale (or a copy thereof) or other proof of purchase along with the entire LCD Television to the Authorized Service Depot. You are responsible for all inbound transportation and insurance charges for the LCD Television to the Authorized Service Depot.

**For additional information, visit TCL's website:
www.toshiba.ca**

ALL WARRANTIES IMPLIED BY THE LAW OF ANY PROVINCE OF CANADA, INCLUDING THE IMPLIED WARRANTIES OF MERCHANTABILITY AND FITNESS FOR A PARTICULAR PURPOSE, ARE EXPRESSLY LIMITED TO THE DURATION OF THE LIMITED WARRANTIES SET FORTH ABOVE. WITH THE EXCEPTION OF ANY WARRANTIES IMPLIED BY THE LAW OF ANY PROVINCE OF CANADA AS HEREBY LIMITED, THE FOREGOING WARRANTY IS EXCLUSIVE AND IN LIEU OF ALL OTHER WARRANTIES, GUARANTEES, AGREEMENTS, AND SIMILAR OBLIGATIONS OF TCL WITH RESPECT TO THE REPAIR OR REPLACEMENT OF ANY PARTS. IN NO EVENT SHALL TCL BE LIABLE FOR CONSEQUENTIAL OR INCIDENTAL DAMAGES (INCLUDING, BUT NOT LIMITED TO, LOST PROFITS, BUSINESS INTERRUPTION, OR MODIFICATION OR ERASURE OF RECORDED DATA CAUSED BY USE, MISUSE, OR INABILITY TO USE THIS LCD TELEVISION).

No person, agent, distributor, dealer, or company is authorized to change, modify, or extend the terms of these warranties in any manner whatsoever. The time within which an action must be commenced to enforce any obligation of TCL arising under the warranty or under any law of Canada or any province thereof is hereby limited to ninety (90) days from the date you discover, or should have discovered, the defect. This limitation does not apply to implied warranties arising under the law of any province of Canada.

THIS WARRANTY GIVES YOU SPECIFIC LEGAL RIGHTS AND YOU MAY ALSO HAVE OTHER RIGHTS WHICH MAY VARY FROM PROVINCE TO PROVINCE IN CANADA. SOME PROVINCES OF CANADA DO NOT ALLOW LIMITATIONS ON THE DURATION OF AN IMPLIED WARRANTY, WHEN AN ACTION MAY BE BROUGHT, OR THE EXCLUSION OR LIMITATION OF INCIDENTAL OR CONSEQUENTIAL DAMAGES. THEREFORE, THE ABOVE PROVISIONS MAY NOT APPLY TO YOU UNDER SUCH CIRCUMSTANCES. [0305]

Index

A B

Antenna cables	10
Audio system connection	14
Auto off	30
A/V cables	10
Back of the TV	8

C

Cable converter box connection	11
Camcorder connection	14
CH ▲▼ buttons	18
CH RTN button	20
Channel Number buttons	20
Channel programming	
Automatic programming	18
Memory/ERASE	19
Closed caption	25
Component video cables	10

D E

DTV receiver connection	13
DVD connection	12

F G H I K

FAV. CH button	19
Favorite channels	19
Front of the TV	8

L M

Language selection	18
Last mode memory	30
Menu system	17
MTS	26
MUTE button	26

O P Q

Panel lock	25
PC connection	15
PC setting	29
Picture adjustments	
Picture mode	23
Picture quality	23
POWER button	16

R

RECALL button	30
Remote control	
Battery installation	16
Learning about the buttons	16

S

S-video cables	10
SAP sound	26
Set-top box	13
Sleep timer	25
Sound mode selection	27
Sound quality adjustments	28
Specifications	31
StableSound®	28
Stereo sound	26

T

Troubleshooting	32
TV/VIDEO button	20

V

V-Chip	
Age block	22
Aux block	22
Content block	22
MPAA	22
Password	22
VCR connection	11-13
VOL button	16

W

Warranty	33, 34
WOW™ surround	27

TOSHIBA AMERICA CONSUMER PRODUCTS, L.L.C.

HEAD OFFICE:82 TOTOWA ROAD, WAYNE, NEW JERSEY 07470, U.S.A.
NATIONAL SERVICE DIVISION:1420B TOSHIBA DRIVE, LEBANON, TN. 37087, U.S.A.

TOSHIBA OF CANADA LTD.

HEAD OFFICE/191 McNABB STREET MARKHAM, ONTARIO L3R 8H2, CANADA TEL: (905) 470-5400

SERVICE CENTERS:

TORONTO: 191 McNABB STREET MARKHAM, ONTARIO L3R 8H2, CANADA TEL: (905) 470-5400

MONTREAL: 18050 TRANS CANADA, KIRKLAND, QUEBEC, H9J-4A1, CANADA TEL:(514)390-7766

VANCOUVER: 22171 FRASERWOOD WAY, RICHMOND, B.C. V6W 1J5, CANADA TEL: (604) 303-2500

ColorStream and StableSound are registered trademarks of Toshiba America Consumer Products, L.L.C.

TOSHIBA

YC/L 72742101

Free Manuals Download Website

<http://myh66.com>

<http://usermanuals.us>

<http://www.somanuals.com>

<http://www.4manuals.cc>

<http://www.manual-lib.com>

<http://www.404manual.com>

<http://www.luxmanual.com>

<http://aubethermostatmanual.com>

Golf course search by state

<http://golfingnear.com>

Email search by domain

<http://emailbydomain.com>

Auto manuals search

<http://auto.somanuals.com>

TV manuals search

<http://tv.somanuals.com>