



TOSHIBA



15-inch* Diagonal LCD TV/DVD COMBINATION

15DLV16

OWNER'S MANUAL

Introduction 2

Connections 14

Basic setup 21

TV operation 23

Basic playback 31

Advanced playback 34

Function setup 46

Others 53

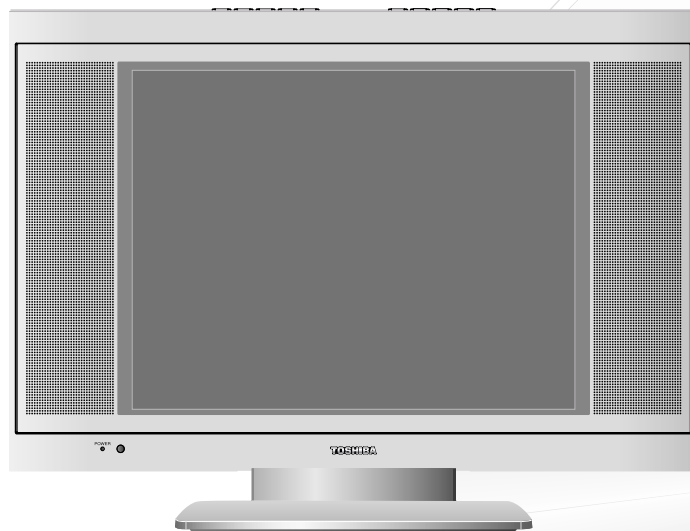

©2006 Toshiba Corporation
Before operating the unit, please read this manual thoroughly.
*Screen size is approximate.

 **CAUTION**
RISK OF ELECTRIC SHOCK
DO NOT OPEN 

CAUTION: TO REDUCE THE RISK OF ELECTRIC SHOCK, DO NOT REMOVE COVER (OR BACK). NO USER-SERVICEABLE PARTS INSIDE. REFER SERVICING TO QUALIFIED SERVICE PERSONNEL.



The lightning flash with arrowhead symbol, within an equilateral triangle is intended to alert the user to the presence of uninsulated dangerous voltage within the product's enclosure that may be of sufficient magnitude to constitute a risk of electric shock.



The exclamation point within an equilateral triangle is intended to alert the user to the presence of important operating and maintenance (servicing) instructions in the literature accompanying the appliance.

WARNING: TO PREVENT FIRE OR SHOCK HAZARD, DO NOT EXPOSE THIS APPLIANCE TO RAIN OR MOISTURE.

CAUTION : TO PREVENT ELECTRIC SHOCK DO NOT USE THIS POLARIZED PLUG WITH AN EXTENSION CORD, RECEPTACLE OR OTHER OUTLET UNLESS THE BLADES CAN BE FULLY INSERTED TO PREVENT BLADE EXPOSURE.

FCC NOTICE :

This equipment has been tested and found to comply with the limits for a Class B digital device, pursuant to Part 15 of the FCC Rules. These limits are designed to provide reasonable protection against harmful interference in a residential installation. This equipment generates, uses and can radiate radio frequency energy and, if not installed and used in accordance with the instructions, may cause harmful interference to radio communications. However, there is no guarantee that interference will not occur in a particular installation. If this equipment does cause harmful interference to radio or television reception, which can be determined by turning the equipment off and on, the user is encouraged to try to correct the interference by one or more of the following measures:

- Reorient or relocate the receiving antenna.
- Increase the distance between the equipment and receiver.
- Connect the equipment into an outlet on a circuit different from that to which the receiver is connected.
- Consult the dealer or an experienced radio/TV technician for help.

CAUTION: Changes or modifications not expressly approved by the party responsible for compliance with the FCC (Federal Communications Commission) Rules could void the user's authority to operate this equipment.

WARNING: Handling the cord on this product or cords associated with accessories sold with this product will expose you to lead, a chemical known to the State of California to cause birth defects or other reproductive harm. ***Wash hands after handling.***

CAUTION:
THIS DIGITAL VIDEO PLAYER EMPLOYS A LASER SYSTEM.

TO ENSURE PROPER USE OF THIS PRODUCT, PLEASE READ THIS OWNER'S MANUAL CAREFULLY AND RETAIN FOR FUTURE REFERENCE. SHOULD THE UNIT REQUIRE MAINTENANCE, CONTACT AN AUTHORIZED SERVICE LOCATION.

USE OF CONTROLS, ADJUSTMENTS OR THE PERFORMANCE OF PROCEDURES OTHER THAN THOSE SPECIFIED HEREIN MAY RESULT IN HAZARDOUS RADIATION EXPOSURE.

TO PREVENT DIRECT EXPOSURE TO LASER BEAM, DO NOT TRY TO OPEN THE ENCLOSURE. VISIBLE LASER RADIATION MAY BE PRESENT WHEN THE ENCLOSURE IS OPENED. DO NOT STARE INTO BEAM.

Location of the required Marking

The rating sheet and the safety caution are on the rear of the unit.

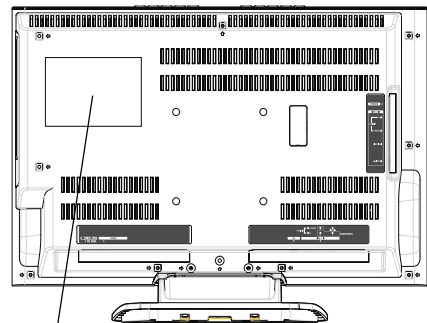

CERTIFICATION: COMPLIES WITH FDA RADIATION PERFORMANCE STANDARDS, 21 CFR SUBCHAPTER J.

IMPORTANT SAFEGUARDS

1. READ INSTRUCTIONS

All the safety and operating instructions should be read before the unit is operated.

2. RETAIN INSTRUCTIONS

The safety and operating instructions should be retained for future reference.

3. HEED WARNINGS

All warnings on the unit and in the operating instructions should be adhered to.

4. FOLLOW INSTRUCTIONS

All operating and use instructions should be followed.

5. CLEANING

Unplug this unit from the wall outlet before cleaning. Do not use liquid cleaners or aerosol cleaners.

Use a soft dry cloth for cleaning the exterior cabinet only.

6. ATTACHMENTS

The manufacturer of this unit does not make any recommendations for attachments, as they may cause hazards.

7. WATER AND MOISTURE

Do not use this unit near water. For example, near a bathtub, washbowl, kitchen sink, laundry tub, in a wet basement, or near a swimming pool.

8. ACCESSORIES

Do not place this unit on an unstable cart, stand, tripod, bracket, or table.

The unit may fall, causing serious injury, and serious damage to the unit.

- 8A.** An appliance and cart combination should be moved with care. Quick stops, excessive force, and uneven surfaces may cause the appliance and cart combination to overturn.

9. VENTILATION

Slots and openings in the cabinet back or bottom are provided for ventilation, and to ensure reliable operation of the unit, and to protect it from overheating.

These openings must not be blocked or covered. The openings should never be blocked by placing the unit on a bed, sofa, rug, or other similar surface. This unit should never be placed near or over a radiator or heat source. This unit should not be placed in a built-in installation such as a bookcase or rack unless proper ventilation is provided or the manufacturer's instructions have been adhered to.

10. POWER SOURCE

This unit should be operated only from the type of power source indicated on the rating plate. If you are not sure of the type of power supply to your home, consult your appliance dealer or local power company.

11. GROUNDING OR POLARIZATION

This unit is equipped with a polarized alternating-current line plug (a plug having one blade wider than the other). This plug will fit into the power outlet only one way. This is a safety feature. If you are unable to insert the plug fully into the outlet, try reversing the plug. Do not defeat the safety purpose of the grounding-type plug.

12. POWER-CORD PROTECTION

Power-supply cords should be routed so that they are not likely to be walked on or pinched by items placed upon or against them, paying particular attention to cords at plugs, convenience receptacles, and the point where they exit from the appliance.

PORTABLE CART WARNING
(symbol provided by RETAC)



S3125A

IMPORTANT SAFEGUARDS

(continued)

13. LIGHTNING

To protect your unit from a lightning storm, or when it is left unattended and unused for long periods of time, unplug it from the wall outlet and disconnect the antenna or cable system. This will prevent damage to the unit due to lightning and power line surges. However, if there is thunder or lightning now, do not touch the unit and any connected cable.

This will for you not to receive the electric shock by the serge of thunder.

14. POWER LINES

An outside antenna system should not be located in the vicinity of overhead power lines or other electric light or power circuits, or where it can fall onto or against such power lines or circuits. When installing an outside antenna system, extreme care should be taken to keep from touching such power lines or circuits, as contact with them might be fatal.

15. OVERLOADING

Do not overload wall outlets and extension cords, as this can result in a risk of fire or electric shock.

16. OBJECT AND LIQUID ENTRY

Do not push objects through any openings in this unit, as they may touch dangerous voltage points or short out parts that could result in fire or electric shock. Never spill or spray any type of liquid into the unit.

17. OUTDOOR ANTENNA GROUNDING

If an outside antenna or cable system is connected to the unit, be sure the antenna or cable system is grounded to provide some protection against voltage surges and built-up static charges, Section 810 of the National Electrical Code (NEC), ANSI/NFPA 70, provides information with respect to proper grounding of the mast and supporting structure, grounding of the lead-in wire to an antenna discharge unit, size of grounding conductors, location of antenna discharge unit, connection to grounding electrodes, and requirements for the grounding electrode.

EXAMPLE OF ANTENNA GROUNDING AS PER THE NATIONAL ELECTRICAL CODE

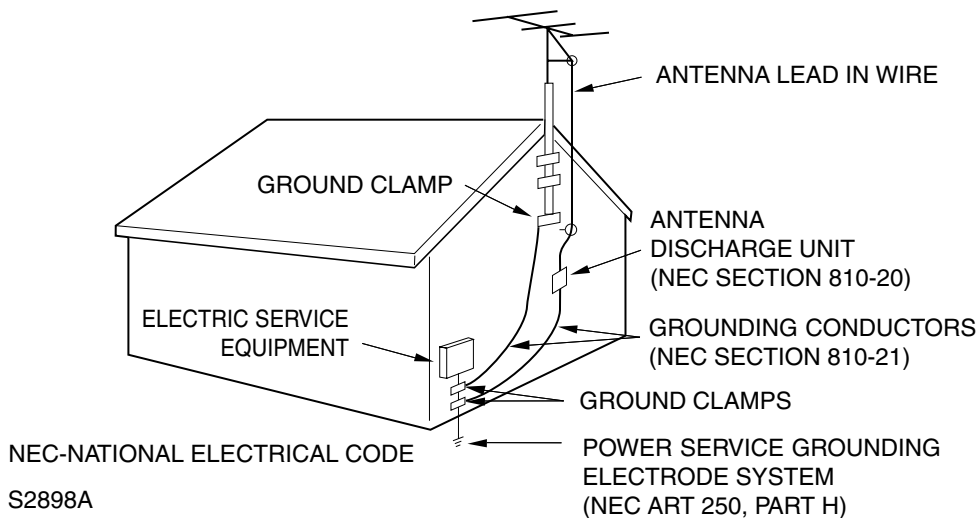

18. SERVICING

Do not attempt to service this unit yourself as opening or removing covers may expose you to dangerous voltage or other hazards. Refer all servicing to qualified service personnel.

For example:

- a. When the power-supply cord or plug is damaged.
- b. If liquid has been spilled, or objects have fallen into the unit.
- c. If the unit has been exposed to rain or water.
- d. If the unit does not operate normally by following the operating instructions. Adjust only those controls that are covered by the operating instructions, as an improper adjustment of other controls may result in damage and will often require extensive work by a qualified technician to restore the unit to its normal operation.
- e. If the unit has been dropped or the cabinet has been damaged.
- f. When the unit exhibits a distinct change in performance, this indicates a need for service.

19. REPLACEMENT PARTS

When replacement parts are required, be sure the service technician uses replacement parts specified by the manufacturer or those that have the same characteristics as the original part.

Unauthorized substitutions may result in fire, electric shock or other hazards.

20. SAFETY CHECK

Upon completion of any service or repairs to this unit, ask the service technician to perform safety checks to determine that the unit is in proper operating condition.

21. HEAT

The product should be situated away from heat sources such as radiators, heat registers, stoves, or other products (including amplifiers) that produce heat.

22. DISC SLOT

Keep your fingers well clear of the disc slot as it is closing. It may cause serious personal injury.

23. CONNECTING

When you connect the product to other equipment, turn off the power and unplug all of the equipment from the wall outlet. Failure to do so may cause a product damage. Read the owner's manual of the other equipment carefully and follow the instructions when making any connections.

24. HEADPHONES

When you use the headphones, keep the volume at a moderate level. If you use the headphones continuously with high volume sound, it may cause hearing damage.

25. LASER BEAM

Do not look into the opening of the disc slot or ventilation opening of the product to see the source of the laser beam. It may cause sight damage.

26. DISC

Do not use a cracked, deformed, or repaired disc. These discs are easily broken and may cause serious personal injury and product malfunction.

27. LCD

Do not press hard or jolt the LCD panel. It may cause the LCD panel glass to break and injury may occur. Should the LCD panel be broken and liquid leaks out, do not inhale or swallow it. Doing so may cause poisoning. If you have got it into your mouth, wash it out and consult your doctor. If your hands or clothes have touched it, wipe them with alcohol and a cleaning cloth and then wash them well.

28. NOTE TO CABLE TV SYSTEM INSTALLER

This reminder is provided to call the Cable TV system installer's attention to Article 820-40 of the NEC that provides guidelines for proper grounding and, in particular, specifies that the cable ground shall be connected to the grounding system of the building, as close to the point of cable entry as practical.

ON DISPOSAL

This product contains mercury. Disposal of mercury may be regulated due to environmental considerations. For disposal or recycling information, please contact your local authorities or the Electronic Industrial Alliance : www.eiae.org.

Precautions

Notes on handling

- Do not shock the LCD panel. It may cause unit damage and malfunction.
- When shipping the unit, the original shipping carton and packing materials come in handy. For fully protection, repack the unit as it was originally packed at the factory.
- Do not use volatile liquids, such as insect spray, near the unit. Do not leave rubber or plastic products to contact the unit for prolonged period. They will leave marks on the finish.
- The top and rear panels of the unit may become warm after a long period of use. This is not a malfunction.
- When the unit is not in use, be sure to remove the disc and turn off the power.
- If you do not use the unit for a long period, the unit may not function properly in the future. Turn on and use the unit occasionally.

Notes on LCD

- The color LCD is manufactured using extremely high precision technology, but even so may include certain pixels that do not operate properly (that do not light, that remain lit constantly, etc.). We do our best to keep the number of these defective pixels to a minimum, but please understand that they cannot be completely eliminated even with the most advanced manufacturing technologies available today.
- The fluorescent tube which illuminates the panel from the inside will deteriorate with use. When the LCD becomes dim, flickers, or does not illuminate, contact your dealer for replacement.
- The brightness of the LCD monitor differs slightly depending on the viewing angles. Adjust the angle to obtain the best viewing. (The recommended angle is 90 degrees to the monitor.)

Notes on locating

- When you place this unit near a TV, radio, or VCR, the playback picture may become poor and the sound may be distorted. In this case, place the unit away from the TV, radio, or VCR.
- To avoid damage to this product, never place or store the unit in direct sunlight; hot, humid areas; or areas subject to excessive dust or vibration.
- Always place the TV on the floor or a sturdy, level, stable surface that can support the weight of the unit. Use a sturdy tie between the TV's rear hook and the rear wall, pillar, etc., to secure the TV. If you use a TV stand, fix the TV by using the attached band.

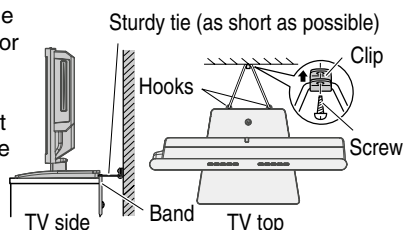

Notes on moisture condensation

Moisture condensation damages the unit. Please read the following carefully.

Moisture condensation occurs, for example, when you pour a cold drink into a glass on a warm day. Drops of water form on the outside of the glass. In the same way, moisture may condense on the optical pick-up lens inside this unit, one of the most crucial internal parts of the unit.

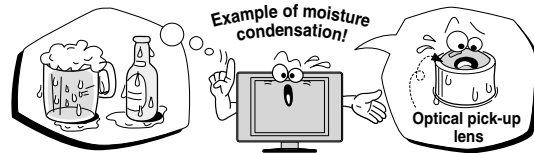

Moisture condensation occurs during the following cases.

- When you bring the unit directly from a cold place to a warm place.
- When you use the unit in a room where you just turned on the heater, or a place where the cold wind from the air conditioner directly hits the unit.
- In summer, when you use the unit in a hot and humid place just after you move the unit from an air conditioned room.
- When you use the unit in a humid place.

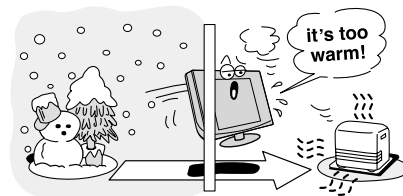

Do not use the unit when moisture condensation may occur.

If you use the unit in such a situation, it may damage discs and internal parts. Remove the disc, connect the power cord of the unit to the wall outlet, turn on the unit, and leave it for two or three hours. After two or three hours, the unit will have warmed up and evaporated any moisture. Keep the unit connected to the wall outlet and moisture condensation will seldom occur.

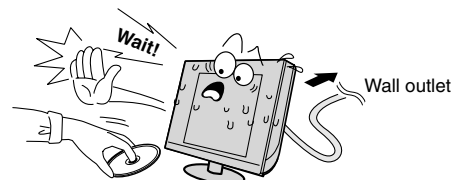

Notes on cleaning

Use a soft, dry cloth for cleaning.

- Do not use any type of solvent, such as thinner and benzene, as they may damage the surface of the unit.



Notes on discs

On handling discs

- Do not touch the playback side of the disc. For example, handle the disc so that it is shown in figure below.

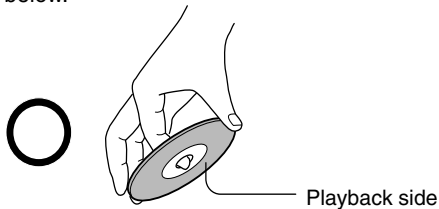

- Do not attach paper or tape to discs.

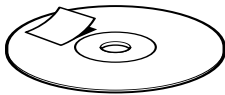

On cleaning discs

- Fingerprints and dust on the disc cause picture and sound deterioration. Wipe the disc from the center outwards with a soft cloth. Always keep the disc clean.



- Do not use any type of solvent such as thinner, benzene, commercially available cleaners or antistatic spray for vinyl LPs. It may damage the disc.

On storing discs

- Do not store discs in a place subject to direct sunlight or near heat sources.
- Do not store discs in places subject to moisture and dust such as a bathroom or near a humidifier.
- Store discs vertically in a case. Stacking or placing objects on discs outside of their case may cause warping.

Structure of disc contents

Normally, DVD video discs are divided into titles, and the titles are sub-divided into chapters. Video CDs and Audio CDs are divided into tracks.

DVD video disc

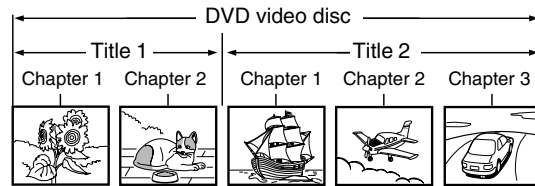

Video CD/Audio CD

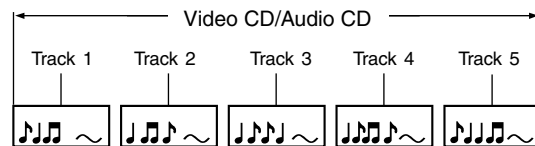

Each title, chapter or track is assigned a number, which is called "title number", "chapter number" or "track number" respectively.

There may be discs that do not have these numbers.

Notes on copyright

The unauthorized recording, use, distribution, or revision of copyrighted materials including, without limitation, television programs, videotapes, and DVDs, is prohibited under the Copyright Laws of the United States and other countries, and may subject you to civil and criminal liability.

This product incorporates copyright protection technology that is protected by method claims of certain U.S. patents and other intellectual property rights owned by Macrovision Corporation and other rights owners. Use of this copyright protection technology must be authorized by Macrovision Corporation, and is intended for home and other limited viewing uses only unless otherwise authorized by Macrovision Corporation. Reverse engineering or disassembly is prohibited.

Notes on discs (Continued)

About this owner's manual

This owner's manual explains the basic instructions of this unit. Some DVD video discs are produced in a manner that allows specific or limited operation during playback. As such, the unit may not respond to all operating command. This is not a defect in the unit. Refer to instruction notes of discs.

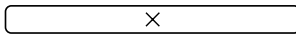

The following symbol may appear on the TV screen during operation.



It means that the operation is not permitted by the TV/DVD or the disc.

For example, sometimes it is unable to stop the playback of copyright message of the disc when the STOP (■) button is pressed. Alternatively, this symbol may also indicate that the feature is not available for the disc.

Notes on region numbers

The region number of this unit is 1. If region numbers, which stand for their playable area, are printed on your DVD video disc and you do not find  or , disc playback will not be allowed by the player. (In this case, the unit will display a message on-screen.) Some DVDs that have no region code label may still be subject to area restrictions and therefore not playable.

On Video CDs

This DVD supports Video CDs equipped with the PBC (Version 2.0) function. (PBC is the abbreviation of Playback Control.) You can enjoy two playback variations depending on types of discs.

- **Video CD not equipped with PBC function (Version 1.1)**

Sound and movie can be played on this DVD in the same way as an audio CD.

- **Video CD equipped with PBC function (Version 2.0)**

In addition to operation of a Video CD not equipped with the PBC function, you can enjoy playback of interactive software with search function by using the menu displayed on the TV screen (Menu Playback). Some of the functions described in this owner's manual may not work with some discs.

Playable discs

This unit can play the following discs.

	Disc Mark	Contents	Disc Size	Maximum playback time
DVD video discs		Audio + Video (moving pictures)	12 cm	Approx. 4 hours (single sided disc)
				Approx. 8 hours (double sided disc)
			8 cm	Approx. 80 minutes (single sided disc)
				Approx. 160 minutes (double sided disc)
Video CDs		Audio + Video (moving pictures)	12 cm	Approx. 74 minutes (single sided disc)
			8 cm	Approx. 20 minutes (single sided disc)
Audio CDs		Audio	12 cm	Approx. 74 minutes (single sided disc)
			8 cm	Approx. 20 minutes (single sided disc)

The following discs are also available.

- DVD-R/RW discs of DVD video format
 - CD-R/CD-RW discs of CD-DA, Video CD, MP3, WMA, JPEG or DivX® format
 - Kodak Picture CD and FUJICOLOR CD format
- Some of these discs may be incompatible.

- You cannot play discs other than those listed above.
- You cannot play discs of DVD-RAM, DVD-ROM, Photo CD, etc., or non standardized discs even if they may be labeled as above.
- Some CD-R/RWs cannot be played back depending on the recording conditions.
- This unit uses the NTSC color system, and cannot play DVD video discs recorded in any other color system (PAL, SECAM, etc.).
- This unit can play an 8cm disc. Please do not use a disc adapter. It may cause trouble.
- Please do not insert any disc of an irregular shape into the unit, as it may interfere with the function of the unit. You may not be able to remove it.
- Please do not use after market accessories, such as a ring protector, as this may cause trouble with the operation of the unit.

Because of problems and errors that can occur during the creation of DVD and CD Software and/or the manufacture of DVD and CD discs, Toshiba cannot assure that the DVD player contained in this TV will successfully play every disc bearing the DVD and CD logos. If you happen to experience any difficulty playing a DVD and/or CD disc on the DVD player contained in this TV, please contact Toshiba Customer Service.

DVD is a trademark of DVD Format/Logo Licensing Corporation.



Contents

Introduction

IMPORTANT SAFEGUARDS	3
Precautions	6
Notes on discs	7
Contents	9
Identification of controls	10

Connections

Antenna connections	14
Cable TV connections	15
Connecting to optional equipment	16
Power source	20

Basic setup

Setting the language	21
To memorize channels	22

TV operation

TV operation	23
Closed captions	25
Setting the V-Chip	26
Picture control adjustment	28
Adjusting the picture mode	28
Selecting the color temperature	29
Sound control adjustment	30
Stereo and Second Audio Program (SAP)	30

Basic playback

Playing a disc	31
----------------------	----

Advanced playback

Zooming	34
Locating desired scene	34
Repeat playback	35
A-B Repeat playback	35
Program playback	36
Random playback	36
Changing angles	37
Title selection	37
DVD menu	37
Changing soundtrack language	38
Subtitles	38
Disc status	39
To turn off the PBC	39
MP3/WMA/JPEG/DivX® and Audio CD operation	40
Repeat and program playback using file browser	44

Function setup

Customizing the function settings	46
Temporary cancel the rating level by DVD disc	52

Others

Language code list	53
Troubleshooting	54
Reception disturbances	56
Specifications	57
Limited United States Warranty	58

Introduction

Identification of controls

See the page in  for details.

Top

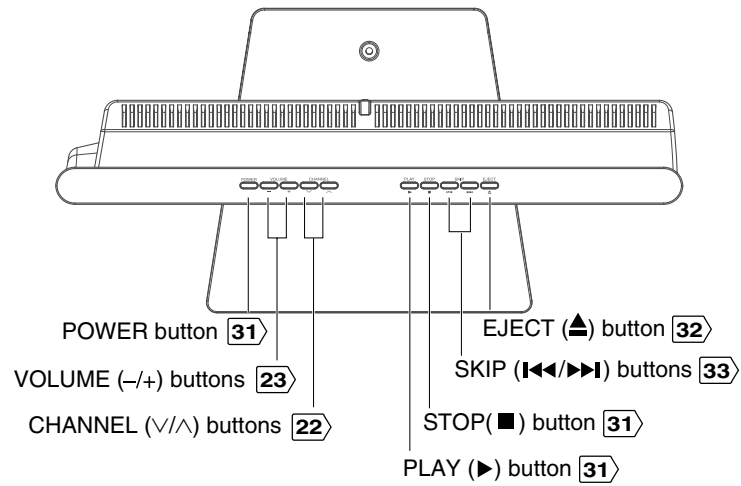

Front

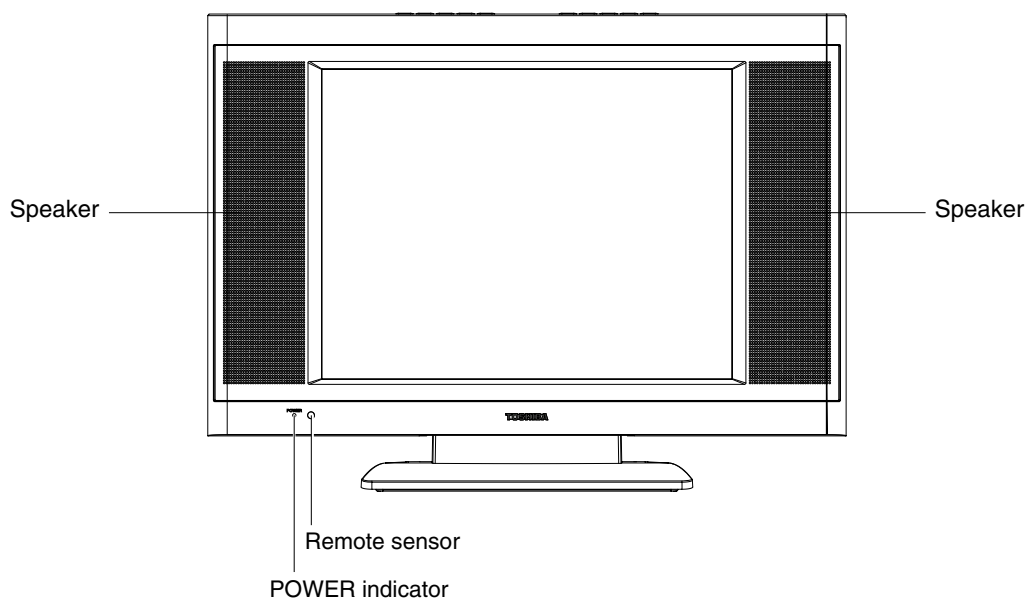



Side

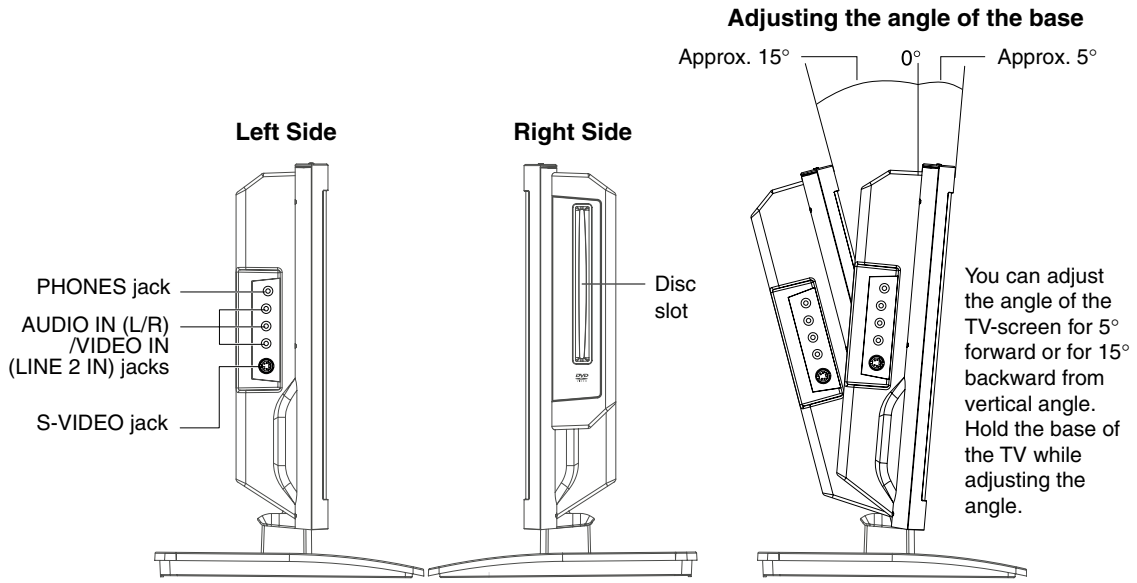

Rear

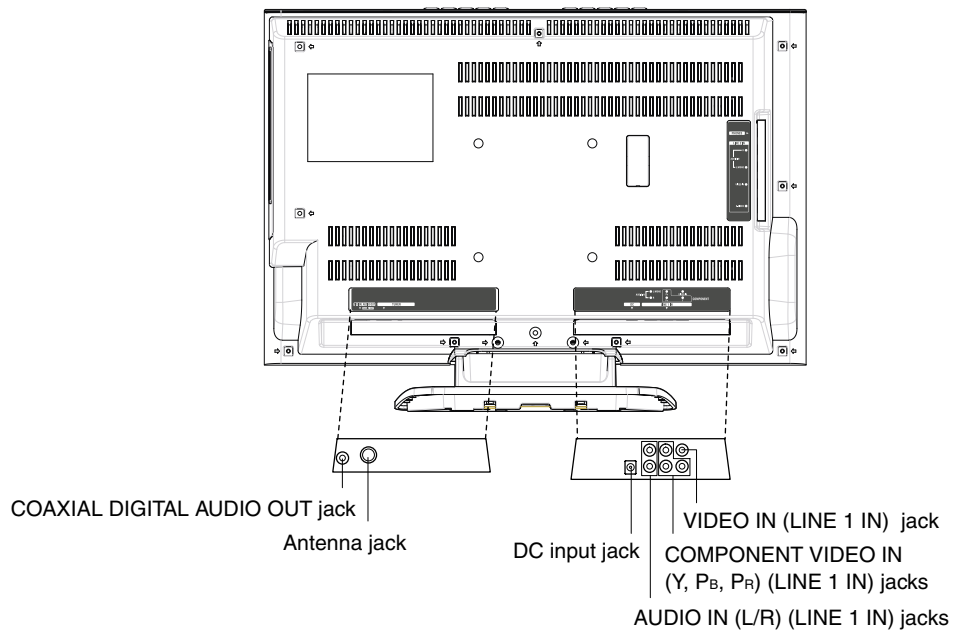

Identification of controls (Continued)

Remote control

The instructions in this manual describe the function on the remote control. See the page in  for details.

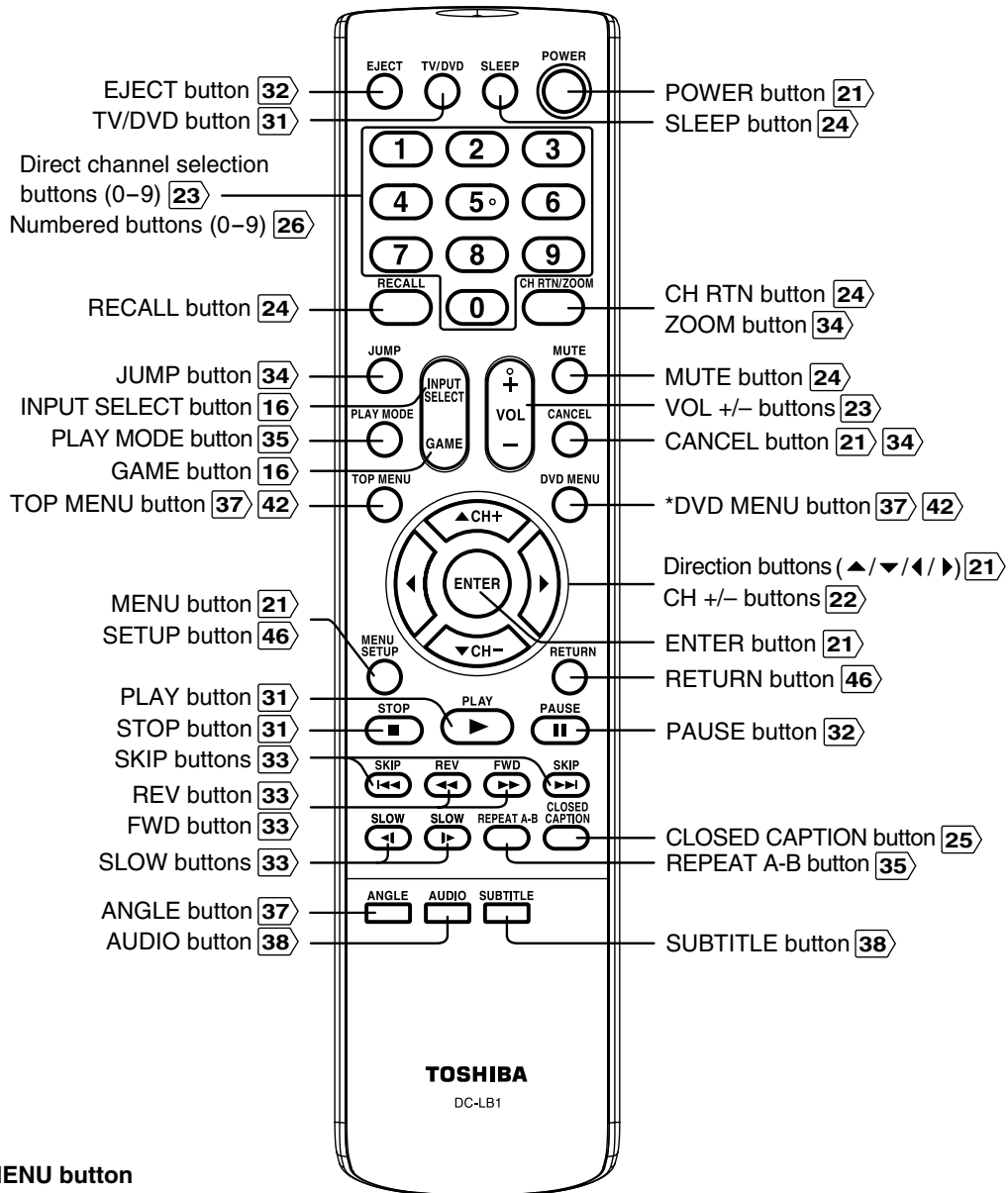

*DVD MENU button

Use the DVD MENU button to display the menu included on many DVD video discs.

To operate a menu, follow the instructions in "DVD menu." **37**



Inserting batteries

- 1 Open the battery compartment cover in the direction of the arrow.
- 2 Install two "R03/AAA" batteries (supplied), paying attention to the polarity indicated in the battery compartment.
- 3 Replace the compartment cover.

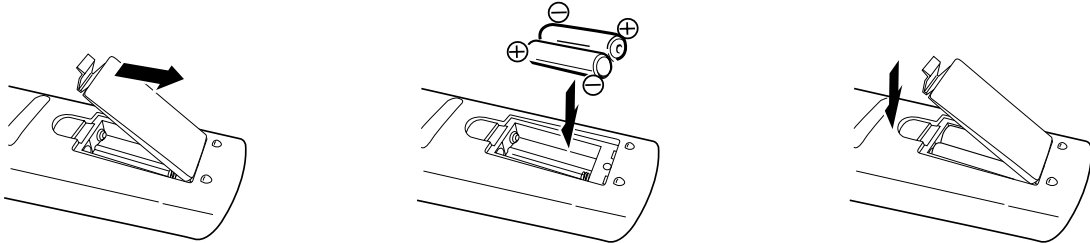

Operation

- Aim the remote control at the remote sensor and press control buttons to operate.
- Operate the remote control within 30° angle on either side of the remote sensor, up to a distance of approx. 5 meters.

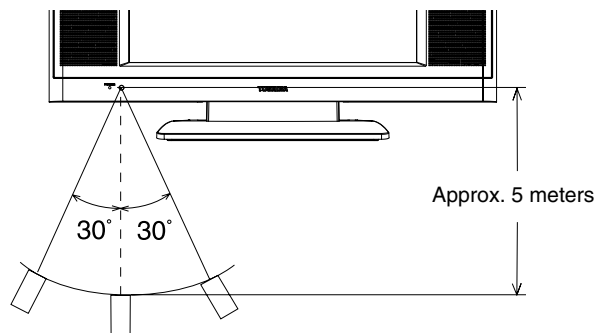

Caution:

- Never throw batteries into a fire.

Notes:

- Be sure to use AAA size batteries.
- Dispose of batteries in a designated disposal area.
- Batteries should always be disposed of with the environment in mind. Always dispose of batteries in accordance with applicable laws and regulations.
- If the remote control does not operate correctly, or if the operating range becomes reduced, replace batteries with new ones.
- When necessary to replace batteries in the remote control, always replace both batteries with new ones. Never mix battery types or use new and used batteries in combination.
- Always remove batteries from remote control if they are dead or if the remote control is not to be used for an extended period of time. This will prevent battery acid from leaking into the battery compartment.



Antenna connections

If you are using an indoor or outdoor antenna, follow the instructions below that correspond to your antenna system.
If you are using a cable TV service (CABLE), see page 15 for Cable TV connections.

Combination VHF/UHF antenna (Single 75 ohm cable or 300 ohm twin-lead wire)

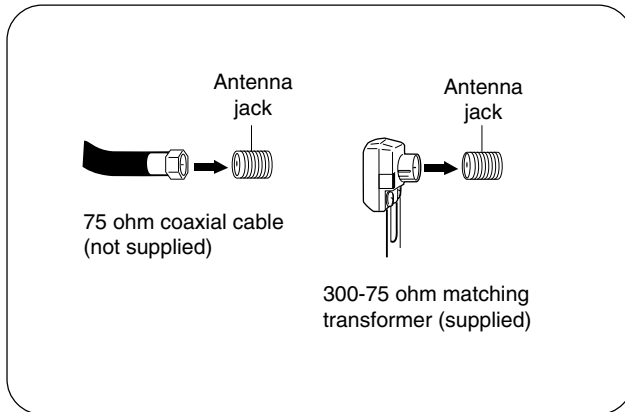

Connect the 75 ohm cable from the combination VHF/UHF antenna to the antenna jack on the back of the TV/DVD.

If your combination VHF/UHF antenna has a 300 ohm twin-lead wire, use the 300-75 ohm matching transformer.

Combination VHF/UHF antenna (Separate VHF and UHF 300 ohm twin-lead wires)

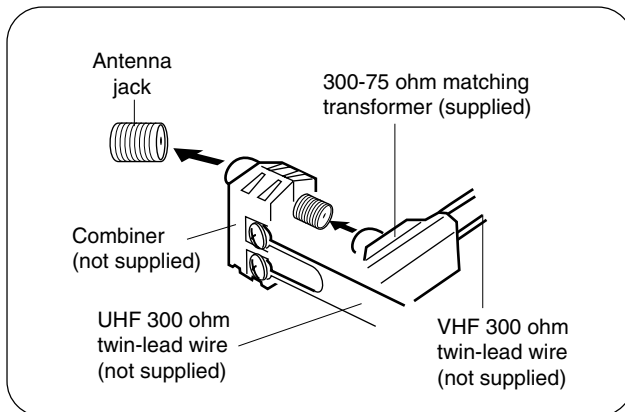

Connect the UHF 300 ohm twin-lead wire to the combiner (not supplied). Connect the VHF 300 ohm twin-lead wire to the 300-75 ohm matching transformer. Attach the transformer to the combiner, then attach the combiner to the antenna jack on the back of the TV/DVD.

Separate VHF/UHF antennas (75 ohm VHF cable and 300 ohm UHF twin-lead wires)

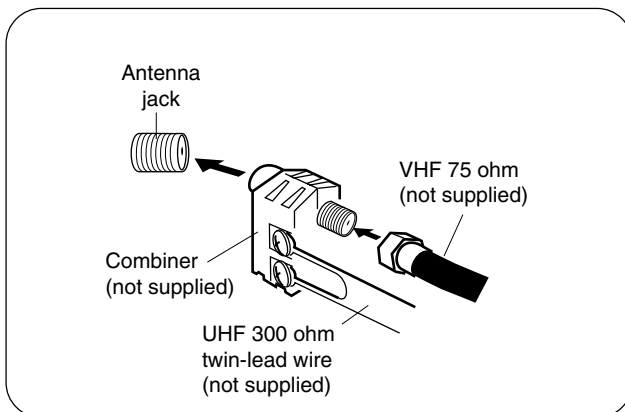

Connect the VHF 75 ohm cable and UHF 300 ohm twin-lead wire to the combiner (not supplied). Attach the combiner to the antenna jack on the back of the TV/DVD.



Cable TV connections

This TV/DVD has an extended tuning range and can tune most cable channels without using a Cable TV converter box. Some cable companies offer "premium pay channels" in which the signal is scrambled. Descrambling these signals for normal viewing requires the use of a descrambler device which is generally provided by the cable company.

For subscribers to basic cable TV service

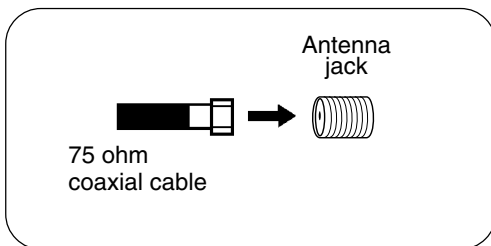

For basic cable service not requiring a converter/descrambler box, connect the Cable TV 75 ohm coaxial cable directly to the Antenna jack on the back of the TV/DVD.

Connections

For subscribers to scrambled cable TV service

If you subscribe to a cable TV service which requires the use of a converter/descrambler box, connect the incoming 75 ohm coaxial cable to the converter/descrambler box. Using another 75 ohm coaxial cable, connect the output jack of the converter/descrambler box to the antenna jack on the TV/DVD. Follow the connections shown below. Set the TV/DVD to the output channel of the converter/descrambler box (usually channel 3 or 4) and use the converter/descrambler box to select channels.

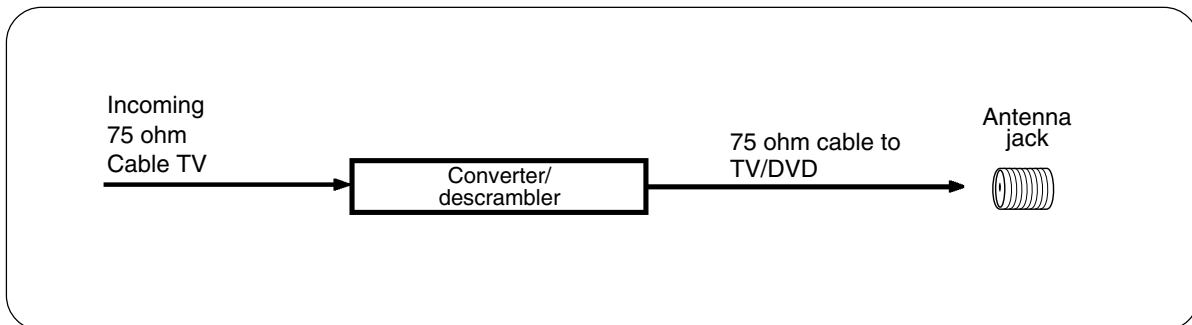

For subscribers to unscrambled basic cable TV service with scrambled premium channels

If you subscribe to a cable TV service in which basic channels are unscrambled and premium channels require the use of a converter/descrambler box, you may wish to use a signal splitter and an A/B Switch box (available from the cable company or an electronics supply store). Follow the connections shown below. With the switch in the "B" position, you can directly tune any unscrambled channels on your TV/DVD. With the switch in the "A" position, tune your TV/DVD to the output of the converter/descrambler box (usually channel 3 or 4) and use the converter/descrambler box to tune scrambled channels.

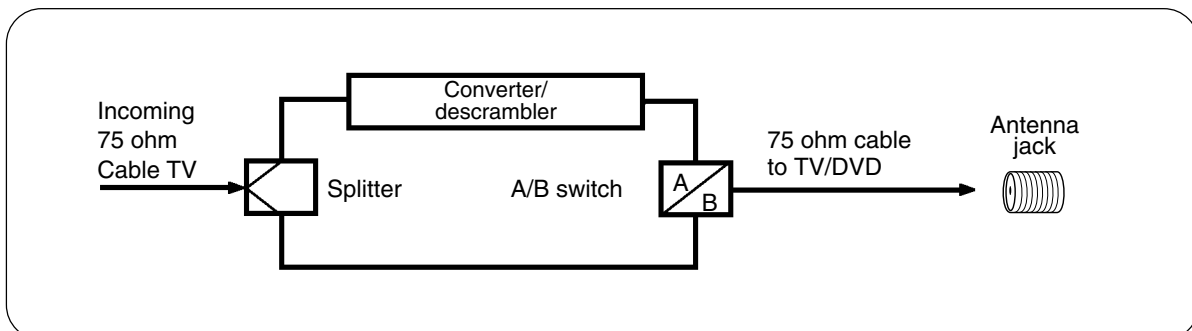

Connecting to optional equipment

You can enjoy VCR, camcorder or TV game with connection to external input.

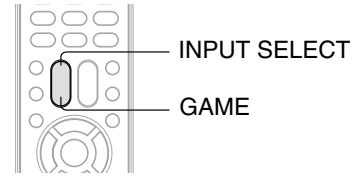

Using the audio/video inputs

Press **INPUT SELECT** repeatedly to select the desired mode. "VIDEO1", "VIDEO2", "ColorStream" or TV channel will display on the screen for 4 seconds.

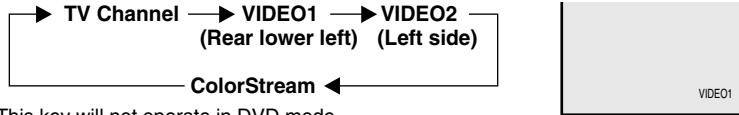

Note: This key will not operate in DVD mode.

Connecting to a VCR

To playback from the VCR, connect the VCR to the TV/DVD as shown. Select the "VIDEO2" by pressing **INPUT SELECT** repeatedly.

➔ : Signal flow

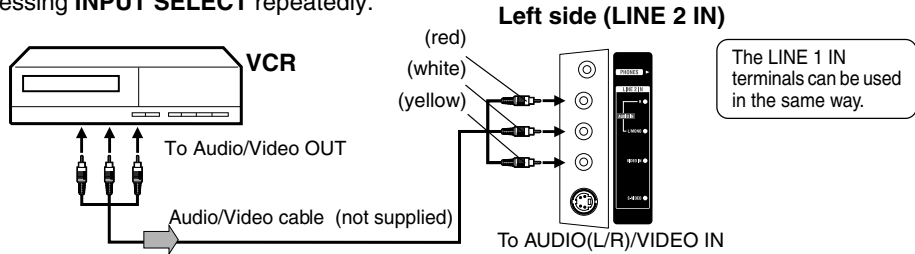

Note: Picture might be muted for some VCR playback. This is not a malfunction of this unit.

Connecting to a camcorder

To playback from the camcorder, connect the camcorder to the TV/DVD as shown. Select the "VIDEO2" by pressing **INPUT SELECT** repeatedly.

➔ : Signal flow

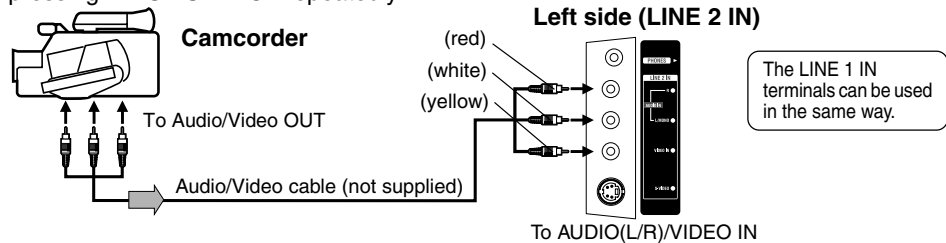

Connecting to a TV Game

You can enjoy playing a TV game on the screen by adjusting to suitable brightness for your eyes.

1. Connect a TV Game to the TV/DVD.
2. Select the "GAME" by pressing **GAME**.
The GAME mode screen appears.
 - This TV/DVD has the GAME mode function (see page 24).

➔ : Signal flow

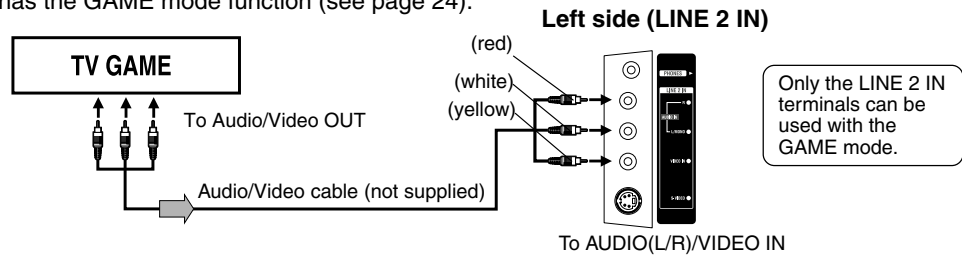

Notes:

- You can also change the TV screen to the desired mode by pressing the CH +/- buttons.
- The TV/DVD can also be used as a display device for many video games. However, due to the wide variety of different types of signal generated by these devices and subsequent hook-up variations required, they have not all been included in the suggested connection diagrams. You'll need to consult each component's Owner's Manual for additional information.
- Interactive video games that involve shooting a "gun" type of joystick at on-screen target may not work on this TV/DVD.



Connecting to an optional equipment with S-video output

If you connect a VCR with an S-VIDEO cable to the S-VIDEO IN jack on the left side of the TV/DVD, you must also connect the audio cables to the AUDIO IN (LINE 2 IN) jacks on the left side of the TV/DVD. The S-VIDEO cable only carries the video signal. The audio signal is separate. Select the "VIDEO2" by pressing **INPUT SELECT** repeatedly.

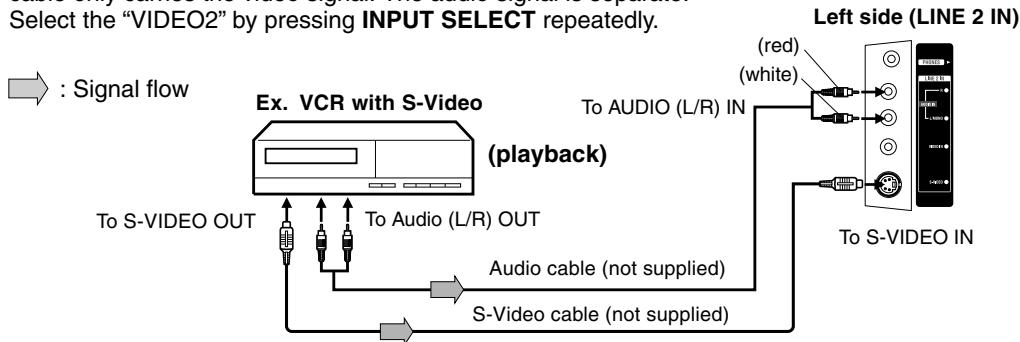

Note: When the S-VIDEO cable and the standard video cable are connected at the same time, the S-video cable takes precedence.

Connecting an optional equipment with ColorStream® (Component video) output

Your TV/DVD is capable of using ColorStream® (component video). Connecting your TV/DVD to a component video compatible DVD player, such as a Toshiba DVD player with ColorStream® can greatly enhance picture quality and performance.

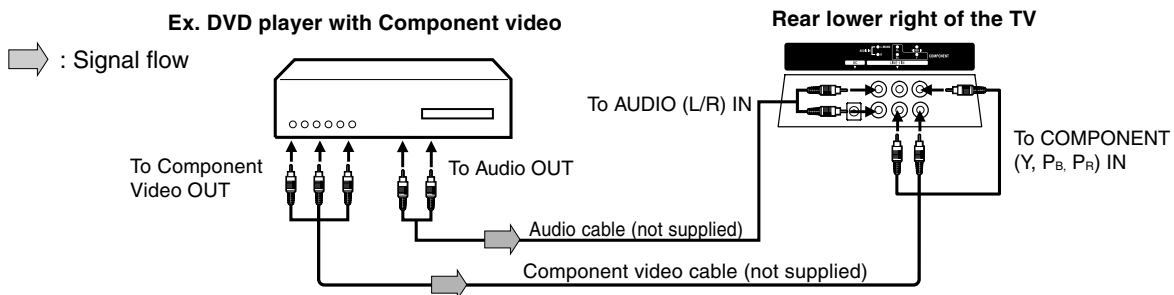

■ Selecting Component input mode

Press **INPUT SELECT** repeatedly to select "ColorStream" mode.



When using the Component video cable, an Audio cable must be connected to AUDIO IN (L/R) (LINE 1 IN) jacks.

The ColorStream® inputs on this unit are for use with devices that output 480i interlaced signals and 480p progressive signals. This unit will not accept or display 720p progressive scan signals or 1080i interlaced high-definition signals. If you connect a high-definition set-top receiver, 720p progressive scan DVD player, or other similar device to the unit's ColorStream® inputs, YOU MUST SWITCH THE DEVICE'S OUTPUT TO 480i INTERLACED OR 480p PROGRESSIVE MODE FIRST. Failure to do this will cause a poor or no picture to display.





Notes:

- Refer to the owner's manual of the connected equipment as well.
- When you connect the unit to other equipment, be sure to turn off the power and unplug all of the equipment from the wall outlet before making any connections.
- If you place the unit near a tuner or radio, the radio broadcast sound might be distorted. In this case, place the unit away from the tuner and radio.

Connecting to optional equipment (Continued)

You can enjoy high quality dynamic sounds by connecting the TV/DVD to optional audio equipment.

* This section uses the following reference mark.

	: Front speaker		: Center speaker
	: Rear speaker		: Signal flow
	: Sub woofer		

Connecting to an amplifier equipped with a Dolby® Digital decoder

Dolby Digital

Dolby Digital is the surround sound technology used in theaters showing the latest movies, and is now available to reproduce this realistic effect in the home. You can enjoy motion picture and live concert DVD video discs encoded via the Dolby Digital recording system with this dynamic realistic sound by connecting the TV/DVD to a 6 channel amplifier equipped with a Dolby Digital decoder or Dolby Digital processor. If you have a Dolby Surround Pro Logic decoder, you will obtain the full benefit of Pro Logic from the same DVD movies that provide full 5.1-channel Dolby Digital soundtracks, as well as from titles with the Dolby Surround mark.

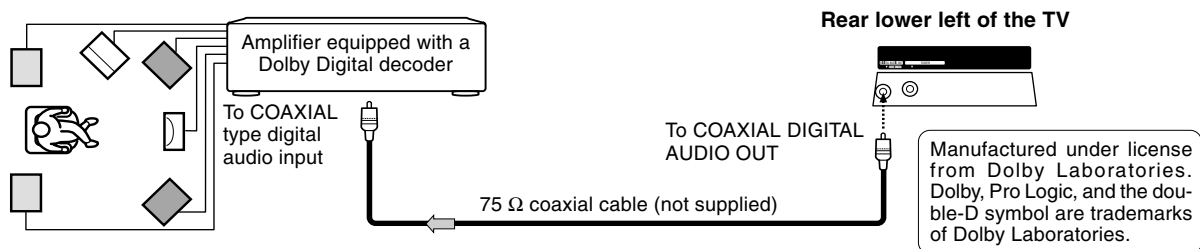

Connecting to an amplifier equipped with a Dolby Surround Pro Logic

Dolby Surround Pro Logic

You can enjoy the dynamic realistic sound of Dolby Surround Pro Logic by connecting an amplifier and speaker system (right and left front speakers, a center speaker, and one or two rear speakers).

- With an amplifier equipped with a Dolby Digital
Connect the equipment the same way as described in "Connecting to an amplifier equipped with a Dolby Digital decoder." Refer to that amplifier's owner's manual and set the amplifier so that you can enjoy Dolby Surround Pro Logic sound.
- With an amplifier not equipped with a Dolby Digital
Connect the equipment as follows.
 - This connection is only suitable for Video CDs and Audio CDs.

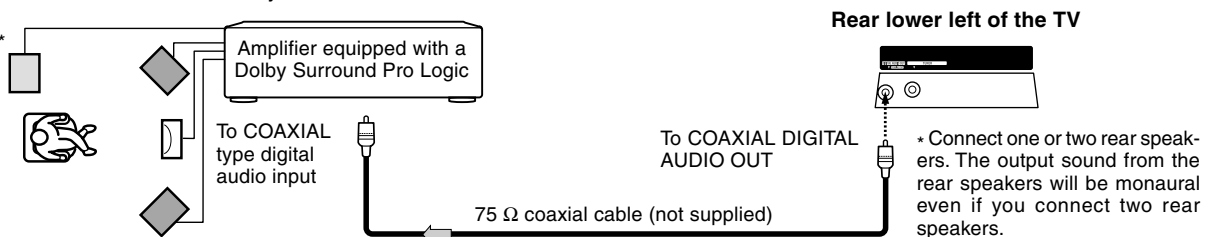

Connecting to an amplifier equipped with a DTS decoder

Digital Theater Systems (DTS)

DTS is a high quality surround technology used in theaters and now available for home use, on DVD video discs or audio CDs. If you have a DTS decoder or processor, you can obtain the full benefit of 5.1 channel DTS encoded sound tracks on DVD video discs or audio CDs.

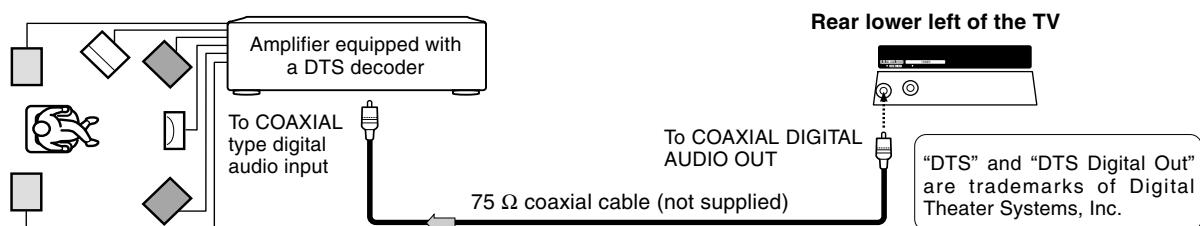



Connecting to an amplifier equipped with an MPEG audio decoder

MPEG2 sound

You can enjoy motion picture and live concert DVD video discs encoded via the MPEG2 recording system with dynamic realistic sound by connecting an amplifier equipped with an MPEG2 audio decoder or MPEG2 audio processor.

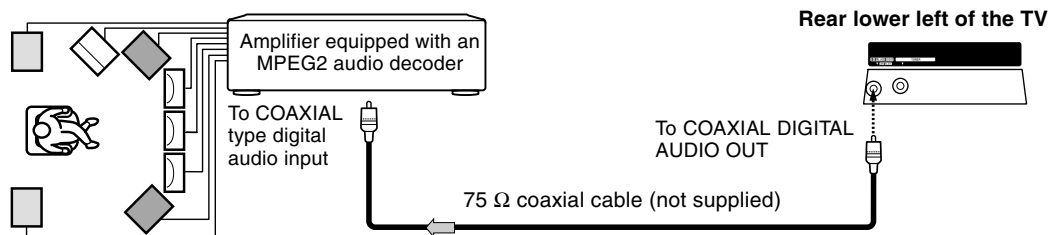

Connecting to an amplifier equipped with a digital audio input

2 channel digital stereo

You can enjoy the dynamic sound of 2 channel digital stereo by connecting an amplifier equipped with a digital audio input and speaker system (right and left front speakers).

Note: PCM audio is limited to DVD or CD playback.

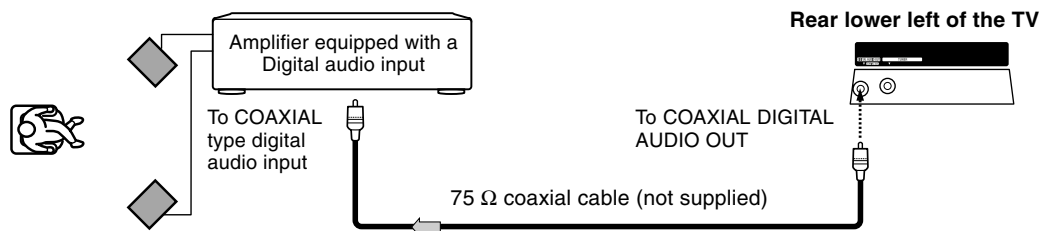

Notes:

- DO NOT connect the COAXIAL DIGITAL AUDIO OUT jack of the TV/DVD to the AC-3 RF input of a Dolby Digital Receiver. This input on your A/V Receiver is reserved for Laserdisc use only and is incompatible with the COAXIAL DIGITAL AUDIO OUT jack of the TV/DVD.
- Connect the COAXIAL DIGITAL AUDIO OUT jack of the TV/DVD to the "COAXIAL" input of a Receiver or Processor.
- Refer to the owner's manual of the connected equipment as well.
- When you connect the TV/DVD to other equipment, be sure to turn off the power and unplug all of the equipment from the wall outlet before making any connections.
- The output sound of the TV/DVD has a wide dynamic range. Be sure to adjust the receiver's volume to a moderate listening level. Otherwise, the speakers and your hearing may be damaged by a sudden high volume sound.
- Turn off the amplifier before you connect or disconnect the TV/DVD's power cord. If you leave the amplifier's power on, the speakers may be damaged.

Power source

Power connection

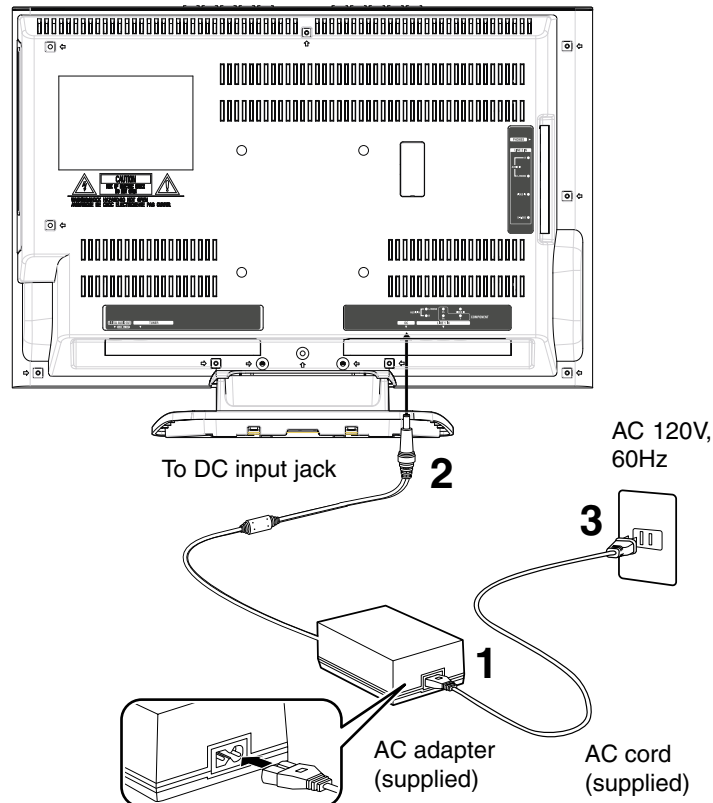

TO USE AC POWER

1. Connect the AC cord to the AC adapter.
2. Connect the AC adapter plug into the TV/DVD's DC input jack.
3. Connect the AC cord into a wall outlet.

Notes:

- Make sure to insert the plug of each cord securely.
- During use the AC adapter becomes warm. This is not a malfunction.

WARNING:

- DO NOT CONNECT THIS UNIT TO THE POWER USING ANY DEVICE OTHER THAN THE SUPPLIED AC ADAPTER OR POWER CORD. THIS COULD CAUSE FIRE, ELECTRIC SHOCK, OR DAMAGE.
- DO NOT USE WITH A VOLTAGE OTHER THAN THE POWER VOLTAGE DISPLAYED. THIS COULD CAUSE FIRE, ELECTRIC SHOCK, OR DAMAGE.

CAUTION:

- DO NOT USE THE AC ADAPTER IF IT IS COVERED BY A CLOTH ETC., OR PRESSED INTO A NARROW AREA. THIS RESULTS IN POOR DISSIPATION OF HEAT AND MAY CAUSE FIRE, ELECTRIC SHOCK, OR DAMAGE.
- WHEN THIS UNIT IS NOT USED FOR AN EXTENDED PERIOD OF TIME, (E.G., AWAY ON A TRIP) IN THE INTEREST OF SAFETY, BE SURE TO UNPLUG IT FROM THE WALL OUTLET.
- DO NOT PLUG/UNPLUG THE PLUG WHEN YOUR HANDS ARE WET. THIS MAY CAUSE ELECTRIC SHOCK.
- IF YOU NEED TO REPLACE THE SUPPLIED AC ADAPTER OR AC CORD, THE SPECIFIED AC ADAPTER AND AC CORD MUST BE USED. CONTACT THE DEALER THAT YOU PURCHASED THE UNIT FROM.

Setting the language

This TV/DVD can display the on screen language in English, Spanish or French in the TV mode.

Select the language you prefer first, then proceed with the other menu options.

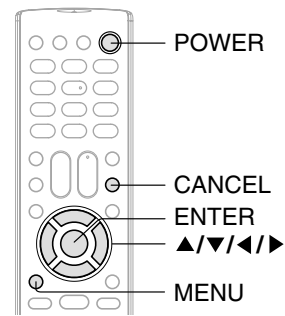

Setting the language

- 1** To turn on the TV/DVD, press **POWER**.
The Power indicator on the front of the main unit will light.



- 2** Press **MENU** and then press **◀** or **▶** to select **"SETUP"**.

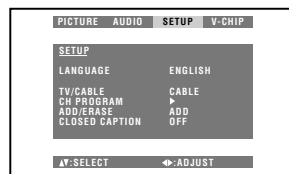

- 3** Press **▲** or **▼** to select **"LANGUAGE"**, then press **◀** or **▶** to select the desired language: English (**ENGLISH**), Spanish (**ESPAÑOL**) or French (**FRANÇAIS**), then press **ENTER**.

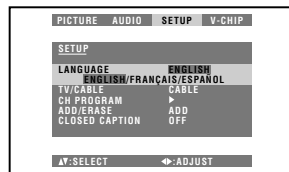
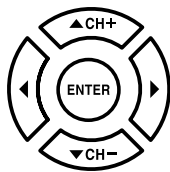

- 4** Press **CANCEL** to clear the menu screen.



Notes:

- If the unit does not operate properly, or No key operation (by the unit and/or the remote control): Static electricity, etc., may affect the TV/DVD's operation. In such case, disconnect the AC cord once, then connect it again.
- The TV section has its own menu and also DVD section has its own menu **46**).

To memorize channels

This TV/DVD is equipped with a channel memory feature which allows channels to skip up or down to the next channel set into memory, skipping over unwanted channels. Before selecting channels, they must be programmed into the TV/DVD's memory. In addition to normal VHF and UHF channels, this TV/DVD can receive up to 113 Cable TV channels. To use this TV/DVD with an antenna, set the TV/CABLE selection to the TV position. When shipped from the factory, this selection is in the CABLE position.

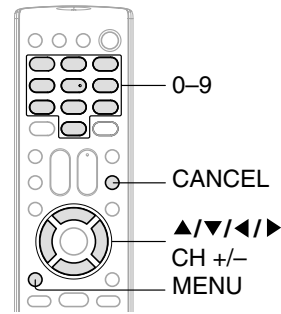

TV/CABLE selection

1 Press MENU in the TV mode, then press ◀ or ▶ to select SETUP.

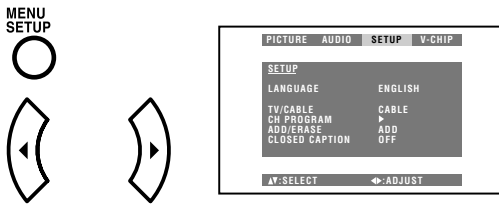

2 Press ▲ or ▼ to select "TV/CABLE".

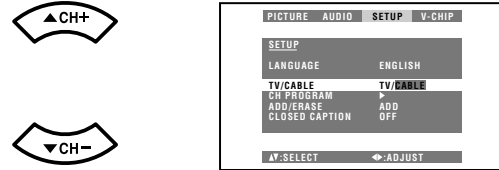

3 Press ◀ or ▶ to select "TV" or "CABLE".

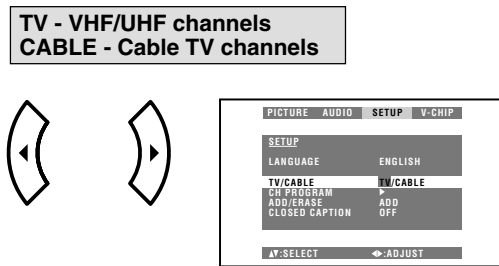

4 Press CANCEL to clear the menu screen.



Cable TV chart

The chart below is typical of many cable system channel allocations.

Number on this TV	Corresponding Cable TV channel	14	15	16	17	18	19	20	21	22
23	24	25	26	27	28	29	30	31	32	33
J	K	L	M	N	O	P	Q	R	S	T
41	42	43	44	45	46	47	48	49	50	51
EE	FF	GG	HH	II	JJ	KK	LL	MM	NN	OO
59	60	61	62	63	64	65	66	67	68	69
WW	AA	BB	CC	DD	EE	FF	GG	HH	II	JJ
77	78	79	80	81	82	83	84	85	86	87
RRR	SSS	TTT	UUU	VVV	WWW	XXX	YYY	ZZZ	86	87
95	96	97	98	99	100	101	102	103	104	105
A-5	A-4	A-3	A-2	A-1	100	101	102	103	104	105
113	114	115	116	117	118	119	120	121	122	123
113	114	115	116	117	118	119	120	121	122	123

Automatic memory tuning

Press MENU, then press ◀ or ▶ to select SETUP. Press ▲ or ▼ to select the "CH PROGRAM", then press ▶. The TV will begin memorizing all the channels available in your area.

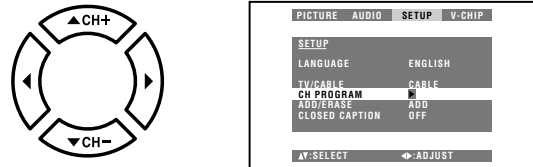

To ADD/ERASE channels

1 Select the desired channel to be added or deleted using Direct channel selection (0-9) or CH +/-.

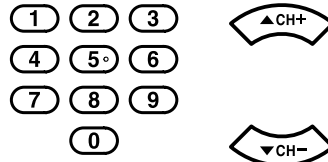

2 Press MENU, then press ◀ or ▶ to select SETUP. Press ▲ or ▼ to select "ADD/ERASE".

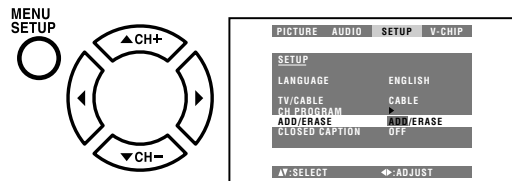

3 Press ◀ or ▶ to select "ADD" or "ERASE".

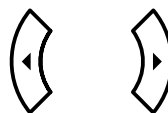

4 Press CANCEL to clear the menu screen. Repeat steps 1 ~ 3 to add or erase other channel.



TV operation

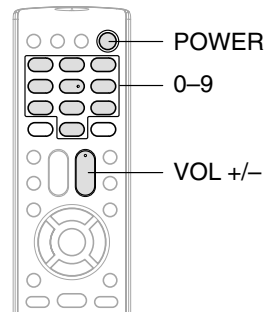

TV operation

1 To turn on the TV/DVD, press **POWER**. The Power indicator on the front of the main unit will light.



2 Adjust the volume level by pressing **VOL +** or **-**. The volume level will be indicated on the screen by white bars. As the volume level increases, so do the number of bars. If the volume decreases, the number of white bars also decreases.

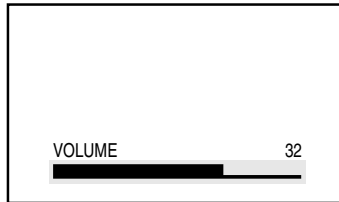

3 Set the TV/CABLE selection to the appropriate position. [22](#)

TV - VHF/UHF channels
CABLE - Cable TV channels

Auto power off

If a station being viewed stops broadcasting, the TV will automatically shut itself off after 15 minutes.

4 Press direct channel selection (0-9) to select the channel.

TV mode direct channel selection

When the TV/CABLE selection is in the TV position, all channels can be instantly selected by using two buttons. (for example, to select channel 2, press "0", then "2". If you press only "2", channel selection will be delayed for a few seconds.) For channels 10 and above, press the 2 digits in order.



CABLE mode direct channel selection

When the TV/CABLE selection is in the CABLE position, channels can be selected as follows:
TO SELECT CABLE TV CHANNELS:

- 1-9: Press "0" twice, then 1-9 as needed. Example, to select channel 2, press "002".
- 10-12: Press "0", then the remaining 2 digits. Example, to select channel 12, press "012".
- 13-99: Press the 2 digits in order. Example, to select channel 36, press "36".
- 100-125: Press the 3 digits in order. Example, to select channel 120, press "120".

NOTE FOR CHANNELS 1-12:

If only 1 or 2 buttons are pressed, the corresponding channel will be selected in 2 seconds.

TV	CATV
VHF 2-13	VHF 2-13
UHF 14-69	STD/HRC/IRC 14-36 (A) (W) 37-59 (AA) (WW) 60-85 (AAA) (ZZZ) 86-94 (86) (94) 95-99 (A-5) (A-1) 100-125 (100) (125) 01 (5A)

Note:

If a channel with no broadcast is selected, the sound will automatically be muted.

TV operation

TV operation (Continued)

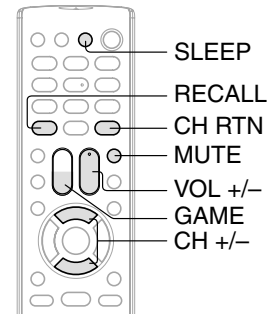

TV operation

■ CHANNEL UP/DOWN

Press and release **CH +** or **-**. The channel automatically stops at the next channel set into memory.

For proper operation, before selecting channels, they should be set into the memory. See page 22 "To memorize channels".

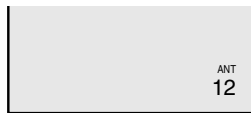
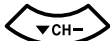

■ RECALL

Press **RECALL** to display the current informations on the screen. Press **RECALL** again to clear the display.

- Channel number or external input mode
- Stereo or SAP (Second Audio Program) audio status

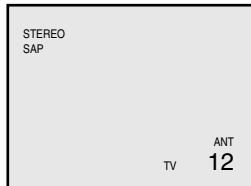

■ CH RETURN

This button allows you to go back to the last channel selected by pressing **CH RTN**. Press **CH RTN** again to return to the last channel you were watching.

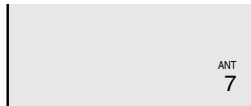

■ MUTE

Press **MUTE** to switch off the sound. The TV/DVD's sound will be silenced and "MUTE" will appear briefly on the screen. The sound can be switched back on by pressing this button again or one of **VOL +/-**.

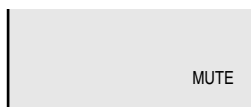

■ SLEEP

To set the TV/DVD to turn off after a preset amount of time, press **SLEEP** on the remote control. The clock will count up 10 minutes for each press of **SLEEP** (0h00m, 0h10m,... 1h50m, 2h00m). After the sleep time is programmed, the display will appear briefly every ten minutes to remind you that the sleep timer is operating. To confirm the sleep timer setting, press **SLEEP** and the remaining time will be displayed for a few seconds. To cancel the sleep timer, press **SLEEP** repeatedly until the display turns to 0h00m.

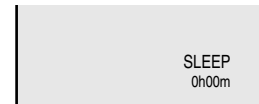

■ GAME MODE

After connecting a TV Game to the unit (see page 16), press **GAME**. The TV screen changes to the Game mode.

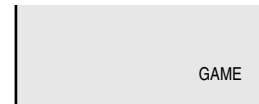

- The Game mode screen is adjusted to the suitable brightness for your eyes.
- If **GAME** is pressed during standby mode, the unit turns on automatically and the Game mode screen appears on the screen.
- Interactive video games that involve shooting a "gun" type of joy-stick at an on-screen target may not work on this TV/DVD.

■ HEADPHONES

Insert a stereo headphones (not supplied) with a 1/8" mini plug into the PHONES jack on the front panel. If you connect headphones, the sound from TV speakers is muted.

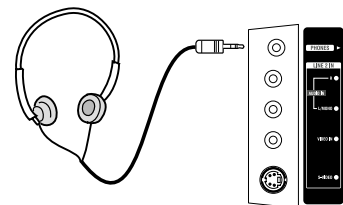



Closed captions

WHAT IS CLOSED CAPTIONING?

This television has the capability to decode and display closed captioned television programs. Closed captioning will display text on the screen for hearing impaired viewers or it will translate and display text in another language.

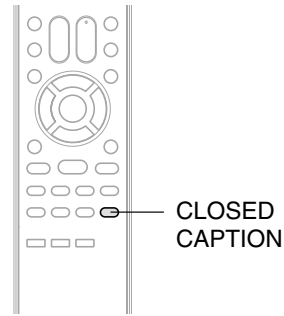

Closed captions

Captions: This closed caption mode will display text on the screen in English or another language (depending on the setting of the closed captions CH 1/2).

Generally, closed captions in English are transmitted on captions channel 1 and closed captions in other languages are transmitted on captions channel 2.

Text: The text closed caption mode will usually fill the screen with a programming schedule or other information. After selecting a closed caption mode, it will stay in effect until it is changed, even if the channel is changed. If the captions signal is lost due to a commercial or a break in the signal, the captions will reappear when the signal is received again. If the channels are changed, the captions will be delayed approximately 10 seconds. The captions will appear in places on the screen where they will least interfere with the picture, usually on the bottom of the screen. News programs will usually show three-line closed captions which scroll onto the screen. Most other shows provide two or three lined captions placed near the character who is speaking so the viewer can follow the dialogue. Words in italics or underlined describe titles, words in foreign languages or words requiring emphasis. Words that are sung usually appear enclosed by musical notes.

For television programs broadcasting with closed captions, look in your TV guide for the closed captions symbol (CC).

TO VIEW CLOSED CAPTIONS

Press **CLOSED CAPTION** to switch between normal TV and the two closed caption modes (captions and full screen text). Closed captioning will display text on the screen for hearing impaired viewers.

- You can also select the closed captions in SETUP menu in the TV mode.

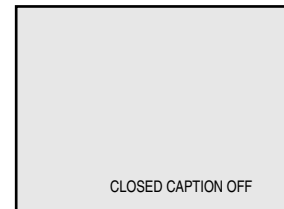

Notes:

- When selecting closed captions, the captioning will be delayed approximately 10 seconds.
- If no caption signal is received, no captions will appear, but the television will remain in the caption mode.
- Misspellings or unusual characters may occasionally appear during closed captioning. This is normal with closed captioning, especially with live programs. This is because during live programs, captions are also entered live. These transmissions do not allow time for editing.
- When captions are being displayed, on-screen displays, such as volume and mute may not be seen or may interfere with closed captions.
- Some cable systems and copy protection systems may interfere with the closed captioned signal.
- If using an indoor antenna or if TV reception is very poor, the closed caption decoder may not appear or may appear with strange characters or misspelled words. In this case, adjust the antenna for better reception or use an outdoor antenna.

TV operation

Setting the V-Chip

An age limitation can be set to forbid children to see and hear violent scenes or pictures for adults, etc. The TV/DVD corresponds to "TV RATING" and "MOVIE RATING". To use the V-Chip function, you must register a password.

Notes:

- If you forget the password, you cannot set the V-Chip.
- To avoid forgetting the password, write it down and keep in the safe place.

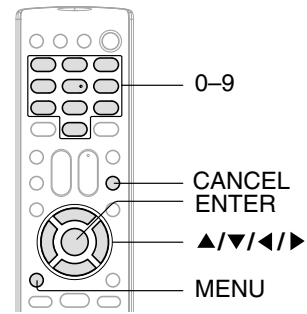

To register password

1 Press MENU and then press ◀ or ▶ to select V-CHIP.

MENU
SETUP

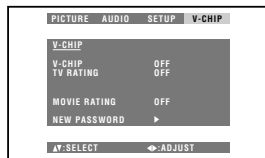
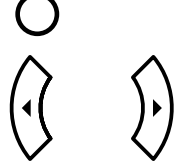

2 Press ▲ or ▼. New password entering screen appears.

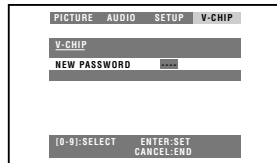

3 Enter the password (4 digits) using Number buttons (0-9), then press ENTER.

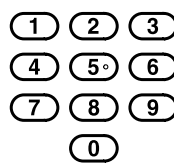

"*" appears instead of the number.

4 Enter the same password again for the safety, then press ENTER.

Now the password was registered and V-Chip setting menu will appear on the display.

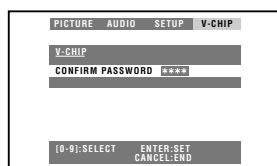

To change password

1 Repeat steps 1 ~ 3 in "To register password" on left, then press ▲ or ▼ to select "NEW PASSWORD", then press ▶.

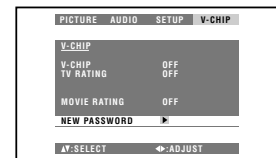
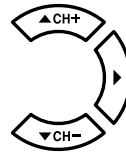

2 Enter the new password using Number buttons (0-9), then press ENTER.

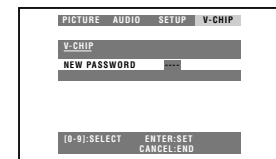
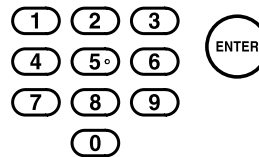

3 Enter the same password again using Number buttons (0-9) for safety, then press ENTER.

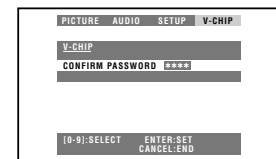
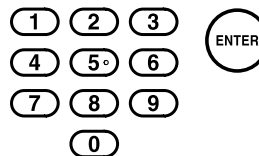

4 Press CANCEL to clear the menu screen.



Note:

The V-Chip feature is available only for the U.S. V-Chip system. The Canadian V-Chip system is not supported.

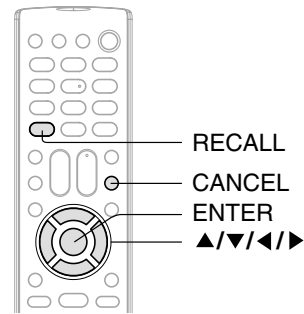

To set the V-Chip

1 Repeat steps 1 ~ 3 in “To register password” on page 26, then press ▲ or ▼ to select “TV RATING”.

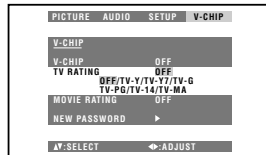
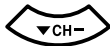

2 Press ◀ or ▶ to select the desired rating.

- OFF : TV RATING is not set
- TV-Y : All children
- TV-Y7 : 7 years old and above
- TV-G : General audience
- TV-PG : Parental guidance
- TV-14 : 14 years old and above
- TV-MA : 17 years old and above

When you select TV-Y7, TV-PG, TV-14 or TV-MA, press **RECALL** to show the contained rating. Press ▲/▼ or ◀/▶ to select the desired item you want.

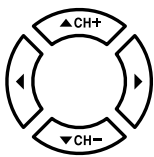
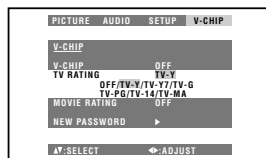

3 Press ▲ or ▼ to select “MOVIE RATING”.

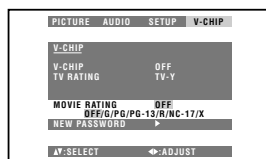

4 Press ◀ or ▶ to select the desired rating.

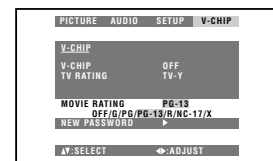
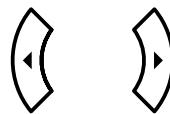

- OFF : MOVIE RATING is not set
- G : All ages
- PG : Parental guidance
- PG-13 : Parental guidance less than 13 years old
- R : Under 17 years old
- NC-17 : 17 years old and above
- X : Adult only

5 Press ▲ or ▼ to select “V-CHIP”.

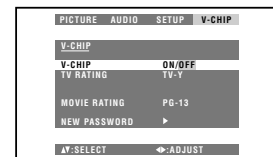
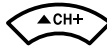

6 Press ◀ or ▶ to display “ON”.
Now your settings were set into the memory.

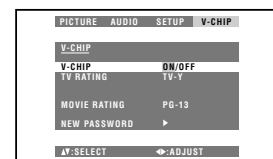
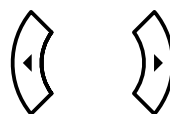

7 Press CANCEL to clear the menu screen.

CANCEL



To use after the TV is protected

When you try to view a program with a ratings block, a message will appear listing the program's ratings. The program can still be viewed if you press MUTE and then enter your password to temporarily bypass the block.

Note:

The V-Chip function is activated only on programs that have the rating signal.



TV operation

Picture control adjustment/ Adjusting the picture mode

Picture controls are factory preset but you can adjust them individually as follows: And also you can select four picture modes—Standard, Sports, Movie, and Memory—as described in the following table:

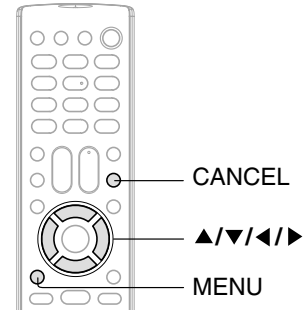

Picture control adjustment

1 Press MENU and then press ◀ or ▶ to select “PICTURE”.

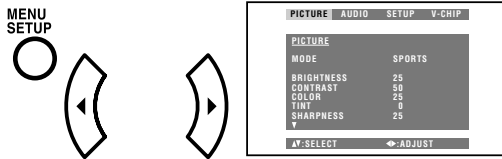

2 Press ▲ or ▼ to select the item you want to adjust, then press ◀ or ▶ to adjust the setting.

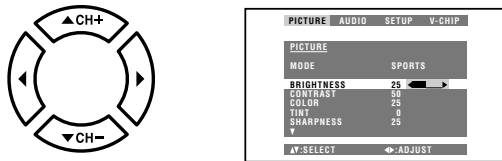

Selection	◀ Pressing ▶	
BRIGHTNESS	darker	lighter
CONTRAST	lower	higher
COLOR	paler	deeper
TINT	reddish	greenish
SHARPNESS	softer	sharper

Note:
The CONTRAST default setting is set to maximum (+50) at the factory.

3 Press CANCEL to clear the menu screen.



Adjusting the picture mode

1 Press MENU and then press ◀ or ▶ to select “PICTURE”.

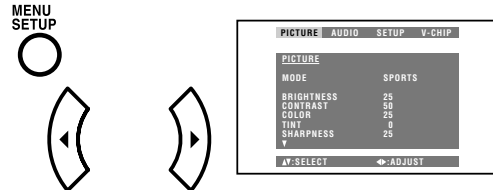

2 Press ▲ or ▼ to select “MODE”, then press ◀ or ▶ to select the desired picture mode.

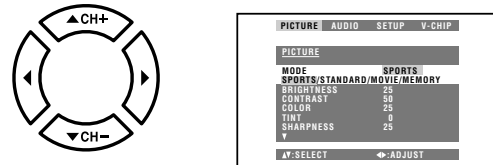

Mode	Picture quality
SPORTS	Bright and dynamic picture (factory-set)
STANDARD	Standard picture quality (factory-set)
MOVIE	Movie-like picture setting (factory-set)
MEMORY	Your personal preferences (set by you; see “Picture control adjustment” as left)

3 Press CANCEL to clear the menu screen.



■ To return all adjustments to the factory preset levels
Press ▲ or ▼ to select “RESET”, then press ▶.

Note:
You cannot select “MODE” in the Game mode.



Selecting the color temperature

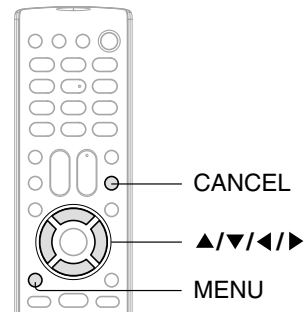

Selecting the color temperature

1 Press MENU and then press ◀ or ▶ to select "PICTURE"

MENU
SETUP

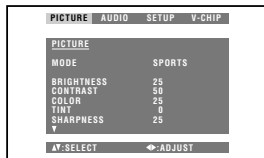
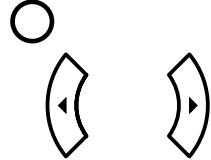

2 Press ▲ or ▼ to select "COLORTEMPERATURE".

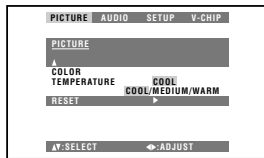

3 Press ◀ or ▶ to select the desired color mode.

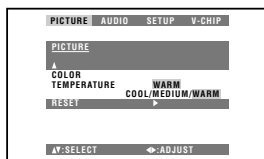
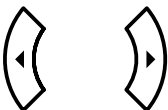

Mode	Picture quality
COOL	Bluish
MEDIUM	Neutral
WARM	Reddish

4 Press CANCEL to clear the menu screen.



TV operation

Note:

You cannot select "COLOR TEMPERATURE" in the Game mode.

Sound control adjustment/ Stereo and Second Audio Program (SAP)

Sound controls are factory preset but you can adjust them individually as follows:

The TV/DVD is equipped with a feature known as multi-channel TV sound or MTS. MTS broadcasts greatly enhance TV viewing by bringing you programs with high fidelity stereo sound.

MTS also provides an extra channel called the Second Audio Program or SAP which broadcasters can use to transmit a second language for bilingual transmission or for other purposes.

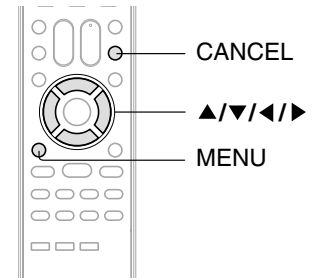

Sound control adjustment

1 Press MENU and then press ◀ or ▶ to select "AUDIO"

MENU
SETUP

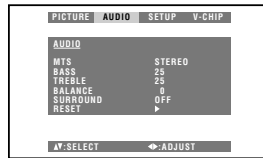

2 Press ▲ or ▼ to select the item you want to adjust, then press ◀ or ▶ to adjust the setting.

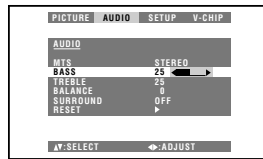
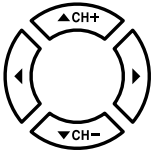

MTS

Press ◀ or ▶ to select "STR" (STEREO), "SAP" or "MONO".

BASS:

Press ◀ or ▶ to adjust the bass sound.

TREBLE:

Press ◀ or ▶ to adjust the treble sound.

BALANCE:

Press ◀ or ▶ to obtain an equal sound level from both speakers.

SURROUND:

Press ◀ or ▶ to select "ON" or "OFF".

ON: The dynamic presence and sound created offers a thoroughly enjoyable listening experience.

OFF: Normal sound.

3 Press CANCEL to clear the menu screen.

CANCEL



Listening to stereo sound

Repeat step 1 in "Sound control adjustment" on left, then press ▲ or ▼ to select "MTS". Then press ◀ or ▶ to select "STR". When the TV is turned on or a channel selection is made, the "STEREO" will appear on the screen. This means that Stereo broadcasting is available. You can enjoy stereo sound from the left and right speakers.

- When mono broadcasting is received, no indication is displayed.
- If the broadcast signal is not strong enough or clear stereo sound is not available, select "MONO". The noise may be eliminated.

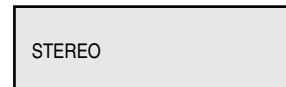
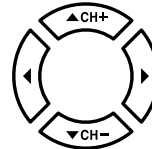

Listening to SAP (Second Audio Program)

Repeat step 1 in "Sound control adjustment" on left, then press ▲ or ▼ to select "MTS". Then press ◀ or ▶ to select "SAP". When the TV is turned on or a channel selection is made, the "SAP" will appear on the screen. This means that the Second Audio Program broadcasting is available.

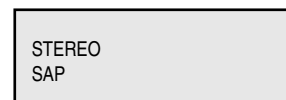
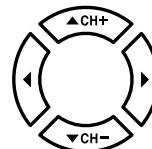

■ To return BASS/TREBLE/BALANCE control adjustments to the factory preset levels

Press ▲ or ▼ to select "RESET", then press ▶.

Playing a disc

This section shows you the basics on how to play a disc.

CAUTION

Keep your fingers well clear of the disc slot when disc is loading or unloading. Neglecting to do so may cause serious personal injury.

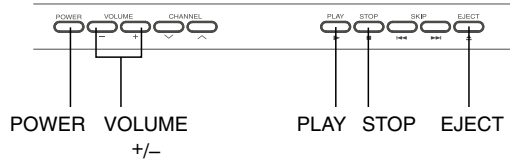

DVD VCD CD Basic playback

Preparations:

- When connecting to other equipment, turn the power off.

1 Press POWER on the unit or on the remote control to turn on the unit.

The Power indicator on the front of the main unit will light.

- Every time you press **POWER**, the TV/DVD starts from TV mode.
- When using an amplifier, switch on the amplifier.



2 Press TV/DVD on the remote control to select DVD mode.

The DVD startup screen will appear on the screen.



3 Load a disc in the disc slot.

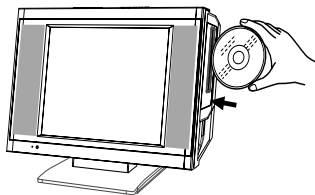

Load the disc in the disc slot with the label side facing forward. (If the disc has a label.) Hold the disc without touching either of its surfaces, align it with the guides, and place it in position.

4 On the TV-screen, "▲" changes to "Reading" and then playback commences.



- A menu screen will appear on the TV screen if the disc has a menu feature. Press ▲/▼ or ◀/▶ to select title, then press **ENTER**. Title is selected and play commences.

5 Press VOLUME + or - to adjust the volume.

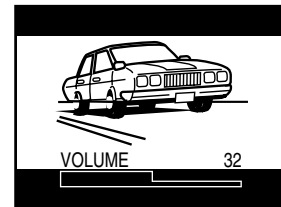

6 Press STOP to end playback.



■ **Resuming facility**

- The unit records the stopped point, depending on the disc. "■" appears on the screen. Press **PLAY** to resume playback (from the scene point).
- If you press **STOP** again ("■" appears on the screen.), the unit will clear the stopped point.

■ **To start playback in the stop mode**

Press **PLAY**.



Note:

If the unit does not operate properly:

Static electricity, etc., may affect the TV/DVD's operation. In such case, disconnect the AC cord, then connect it again.



Basic playback

Playing a disc (Continued)

■ To obtain a higher quality picture

Occasionally, some picture noise may appear on the TV screen while playing a DVD video disc because the high resolution pictures on these discs include a lot of information. In such case, you may reduce the SHARPNESS with the Picture control adjustment menu (see page 28).

■ About

The    icons on the heading bar show the playable discs for the function described under that heading.

 : You can use this function with DVD video discs.

 : You can use this function with Video CDs.

 : You can use this function with Audio CDs and CD-R/RW CDs.

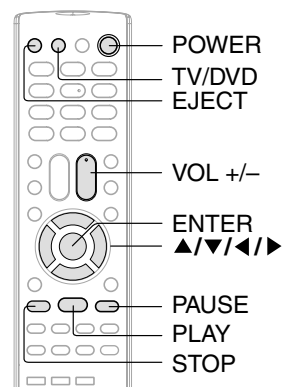

Basic playback

■ To pause playback (still mode)

Press **PAUSE** during playback.

PAUSE



To resume normal playback, press **PLAY**.

- The sound is muted during still mode.



■ To stop playback

Press **STOP**.

STOP



■ To remove the disc

Press **EJECT**.

EJECT



Remove the disc after the disc comes out.

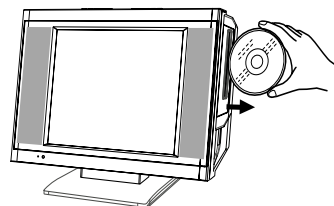

Notes:

- If a non-compatible disc is loaded, "Incorrect Disc", "Region Code Error" or "Parental Error" will appear on the TV screen according to the type of loaded disc. In this case, check your disc again (see pages 8 and 50).
- Some discs may take a minute or so to start playback.
- When you set a single-faced disc label downwards (ie. the wrong way up), "Reading" will appear on the display for a few minutes and then "Incorrect Disc" will continue to be displayed.
- Some discs may not work the resuming facility.
- Resuming cannot function when you play a PBC-featured Video CD while the PBC is on. To turn off the PBC, see page 39.
- Some playback operations of DVDs may be intentionally fixed by software producers. Since this unit plays DVDs according to the disc contents the software producers designed, some playback features may not be available. Also refer to the instructions supplied with the DVDs.
- Do not move the unit during playback. Doing so may damage the disc.
- Use the EJECT button to unload and eject the disc.
- Do not put any objects other than discs on the disc slot. Doing so may cause the unit to malfunction.
- There may be a slight delay between the button is pressed and the function activates.

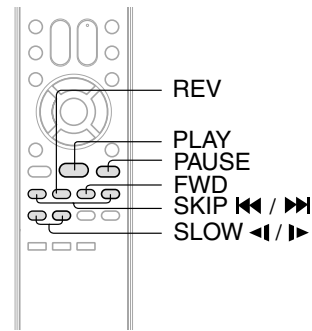

Playing in fast reverse or fast forward directions

Press **REV** or **FWD** during playback.



REV: Fast reverse playback
FWD: Fast forward playback

Each time you press **REV** or **FWD** button, the playback speed changes.

■ To resume normal playback

Press **PLAY**.



Notes:

- The TV/DVD mutes sound during reverse and forward scan of DVD and Video CD discs. However, the TV/DVD plays sound during fast forward or fast reverse play of audio CDs.
- The playback speed may differ depending on the disc.

Playing frame by frame

Press **PAUSE** during still playback.



Each time you press **PAUSE**, the picture advances one frame.

■ To resume normal playback

Press **PLAY**.



Note:

The sound is muted during frame by frame playback.

Playing in slow-motion

Press **SLOW <|** (REVERSE) or **|>** (FORWARD) during playback.



Each time you press the button, the slow-motion speed changes.

■ To resume normal playback

Press **PLAY**.



Notes:

- The sound is muted during slow-motion playback.
- The Video CD cannot play Reverse Slow.

Locating a chapter or track

Press **SKIP <<<** or **>>>** repeatedly to display the chapter or track number you want.

Playback starts from the selected chapter or track.



To locate succeeding chapters or tracks.



Playback starts from the beginning of the current chapter or track. When you press twice in quick successions, playback starts from the beginning of the preceding chapter or track.

Note:

A "Prohibition" symbol "X" may appear at the upper right of the screen. This symbol means either the feature you tried is not available on the disc, or the TV/DVD cannot access the feature at this time. This does not indicate a problem with the TV/DVD.

Zooming/Locating desired scene

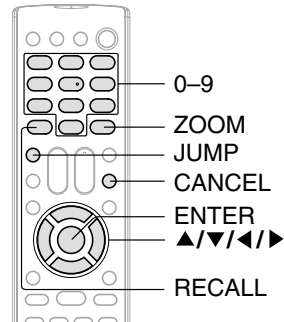

Zooming

This unit will allow you to zoom in on the frame image. You can then make selections by switching the position of the frame.

1 Press ZOOM during playback.



The center part of the image will be zoomed in. Each press of **ZOOM** will change the ZOOM Q1 (x 1.3), Q2 (x 1.5) and Q3 (x 2.0).

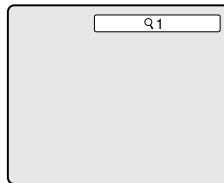

2 Press ▲/▼/◀/▶ to view a different part of the frame.



You may move the frame from the center position to UP, DOWN, LEFT or RIGHT direction.

3 In the zoom mode, press ZOOM repeatedly to return to a 1:1 view (Q Off).



Notes:

- You can select the Pause, Slow or Search playback in the zoom mode.
- Some discs may not respond to zoom feature.

Locating desired scene

Use the title, chapter and time recorded on the DVD disc to locate the desired point to playback. In the case of VCD/CD discs, time and track are used to locate the desired point to playback.

To check the title, chapter and time, press **RECALL**.

1 Press JUMP during playback or resume stop mode.

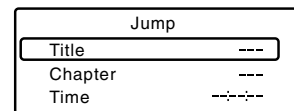

2 Press ▲ or ▼ to select the "Time", "Title/Track" or "Chapter".

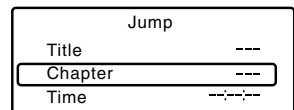

3 Press Number buttons (0-9) to input the number.

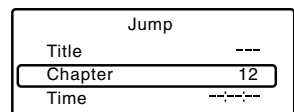
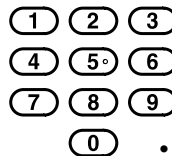

- If you input a wrong number, press **CANCEL**.
- Refer to the package supplied with the disc to check the numbers.

4 Press ENTER. Playback starts.



- When you change the title, playback starts from Chapter 1 of the selected title.
- Some discs may not work in the above operation.

Note:

In case of the Video-CD playback with PBC, the JUMP does not work. To turn off PBC, see page 39.

Repeat playback/A-B Repeat playback

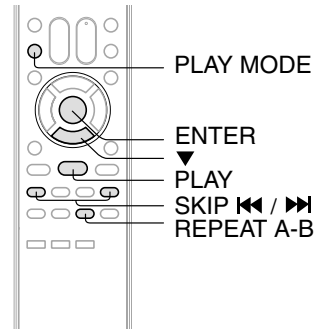

DVD VCD Repeat playback

1 Press **PLAY MODE** during playback or stop mode.



2 [DVD]
Press **ENTER** to select "Chapter" or "Title".



The unit automatically starts repeat playback after finishing the current title or chapter.

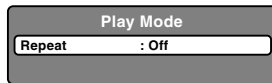

[Video CD]

Press **▼** to select "Repeat".

Press **ENTER** to select "Track" or "All".



The unit automatically starts repeat playback after finishing the current track.

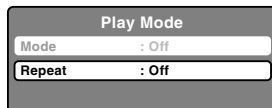

- If you set the repeat mode during stop mode, press **PLAY** to start Repeat playback.

[Audio CD and MP3/WMA CD]
Please "Repeat playback (CD)" [44].

3 Press **PLAY MODE** again to clear the screen.

■ To resume normal playback

Select Repeat : "Off" in step 2.

Notes:

- Some discs may not work with the repeat operation.
- In case of Video CD with PBC, Repeat functions are prohibited during playback.
- Chapter/Track repeat function is canceled whenever **SKIP** ◀◀ or ▶▶ is pressed.

DVD VCD A-B Repeat playback

A-B repeat playback allows you to repeat a section between two selected points.

1 Press **REPEAT A-B** during playback.



The start point is selected.

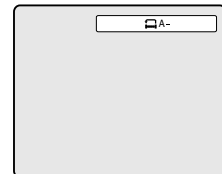

2 Press **REPEAT A-B** again.



The end point is selected. Playback starts at the point that you selected. Playback stops at the end point and returns to Point A automatically, then starts again.

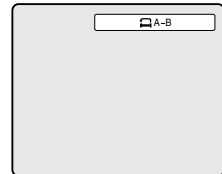

■ To resume normal playback

Press **REPEAT A-B** again.



"Off" appears on the screen.

Notes:

- In A-B Repeat mode, subtitles near the A or B locations may not be displayed.
- You cannot set the A-B Repeat for the scenes that include multiple angles.
- A-B Repeat playback does not work when Repeat playback is activated.
- You may not be able to set A-B Repeat, during certain scenes of the DVD.
- A-B Repeat does not work with an interactive DVD, MP3/WMA/JPEG CD.
- A-B Repeat is prohibited when PBC is on.

Advanced playback

Program playback/Random playback

You can arrange the playback order of tracks or files on the disc. And the unit can also select tracks or files at random and playback them. These feature works for Video CD.

For Audio CD and MP3/WMA CD, please see "Random playback (CD)" [44](#) and "Program playback (CD)" [45](#).

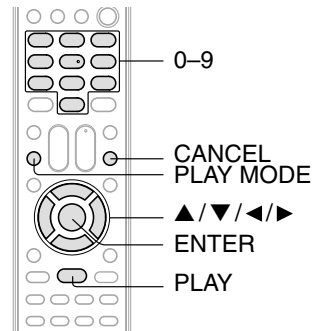

VCD Program playback

1 Press **PLAY MODE** in the stop mode.

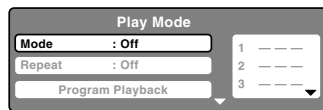

2 Press **▲** or **▼** to select "Mode", then press **ENTER** to select "Program".



3 Press **◀/▶** to select the programming position. Use Number buttons (0-9) to input the Track on sequentially.

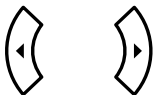

- To program others, repeat step 3.
- If you input a wrong number, press **CANCEL**.

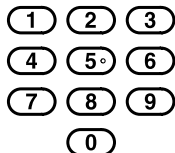

4 Press **◀/▶** to return to the left column, then press **▲/▼** to select the "Program Playback" and press **ENTER**.

The programs you selected will start to playback in order.

- To resume normal playback, select Mode: "Off" in step 2.

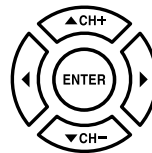

■ To change the program

1. Select Mode to "Program" (as step 2), press **▲/▼/◀/▶** to select the track/file number you want to change, then press **CANCEL**.
2. Press **Number buttons (0-9)** to overwrite the new track/file number.

■ To clear the program one by one

Select Mode to "Program", press **▲/▼/◀/▶** to select the track number. Then press **CANCEL**.

■ To clear all the programs

In the left column, press **▲/▼** to select "Clear Program". Then press **ENTER**.

Notes:

- In playing back the Video CD with PBC, you cannot set Program playback.
- The program is canceled when you eject the disc or turn the power off.

VCD Random playback

1 Press **PLAY MODE** during playback or stop mode.



2 Press **▲/▼** to select "Mode", then press **ENTER** to select "Random".

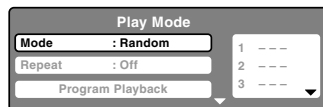

3 Press **PLAY**.



The Random Playback will start.

- If you set "Random" during playback mode, Random playback will begin after the track/file that is currently being played has ended.
- To resume normal playback, select Mode: "Off" in step 2.

Note:

In case of Video CD with PBC, you cannot set Random function during playback.



Changing angles/Title selection/DVD menu

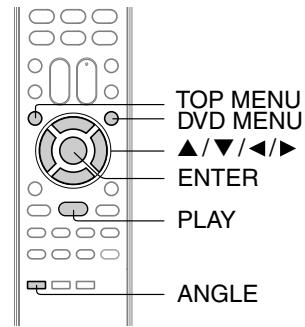

DVD Changing angles

When playing back a disc recorded with multi-angle facility, you can change the angle that you are viewing the scene from.

1 Press ANGLE during playback.
 ANGLE The current angle will appear.

2 Press ANGLE repeatedly until the desired angle is selected.

Note: Depending on the DVD, you may not be able to change the angles even if multi-angles are recorded on the DVD.

DVD Title selection

Two or more titles are recorded on some discs. If the title menu is recorded on the disc, you can select the desired title.

1 Press TOP MENU during playback.
 TOP MENU Title menu appears on the screen.

2 Press ▲/▼/◀/▶ to select the desired title.

3 Press ENTER or PLAY.
 The playback of the selected title will start.

Note: Depending on the DVD, you may not be able to select the title. Depending on the DVD, a "title menu" may simply be called a "menu" or "title" in the instructions supplied with the disc.

DVD menu

Some DVDs allow you to select the disc contents using the menu. When you playback these DVDs, you can select the subtitle language and sound-track language, etc. using the menu.

1 Press DVD MENU during playback.
 DVD MENU The DVD menu appears on the screen.
 • Press **DVD MENU** again to resume playback at the scene when you pressed **DVD MENU**.

2 Press ▲/▼/◀/▶ to select the desired item.

3 Press ENTER.
 The menu continues to another screen. Repeat steps 2 and 3 to set the item completely.

Note: Depending on the DVD, you may not be able to resume playback from the scene point when you press the DVD MENU button.

Advanced playback

Changing soundtrack language/ Subtitles

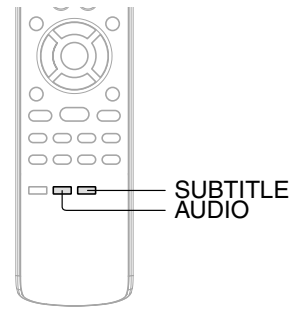

Changing soundtrack language

You can select the language when you play a multilingual disc.

1 Press AUDIO during playback.

 The current soundtrack language will appear.

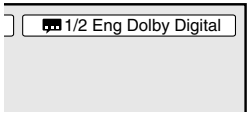

2 Press AUDIO repeatedly until the desired language is selected.

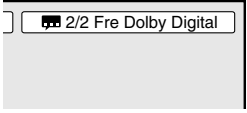
- The on screen display will disappear after a few seconds.

■ In case of Video CD playback

Audio type changes as follows each time you press **AUDIO**.



Notes:

- If the desired language is not heard after pressing the button several times, the language is not recorded on the disc.
- The selected soundtrack language is canceled when you eject the disc. The initial default language or available language will be heard if the disc is played back again.
- If you select DTS in playing DTS-encoded disc, no sound will be heard from the TV/DVD's speakers.



Subtitles

When playing back a disc recorded with subtitles, you can select the subtitle language or turn the subtitle off.

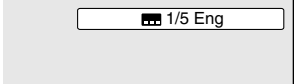
1 Press SUBTITLE repeatedly during playback until the desired language is selected.

2 To turn off the subtitle, press SUBTITLE until "Off" appears.

 

- The on screen display will disappear after a few seconds.

Notes:

- Depending on the DVD, you may not be able to change subtitles, or to turn subtitles on or off.
- While playing a DVD, the subtitle may change when you loaded or eject the disc.
- In some cases, a selected subtitle language may not be changed immediately.

Disc status/To turn off the PBC

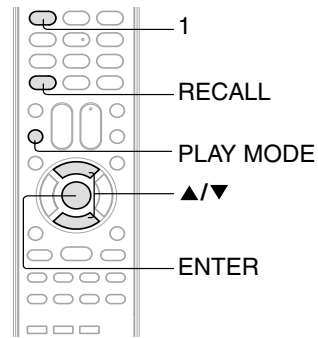

Disc status

With each press of **RECALL**, the status of the disc will appear on the screen and change as follows.
To cancel the display, press **RECALL** again.



DVD

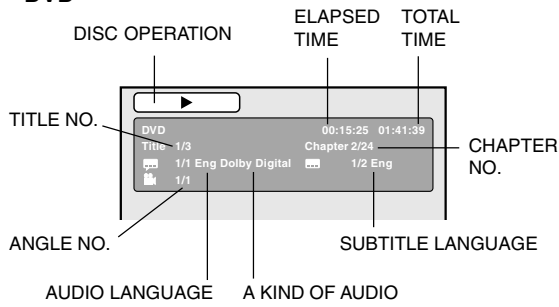

Video CD

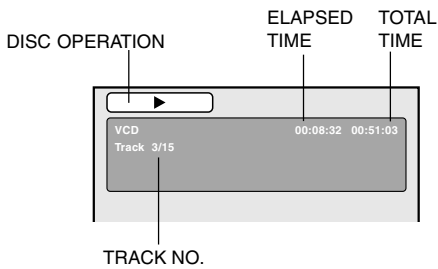

To turn off the PBC (see page 8)

1 Press **PLAY MODE** in the stop mode.



2 Press **▲/▼** to select "Mode", then press **ENTER** repeatedly until "Off" appear.

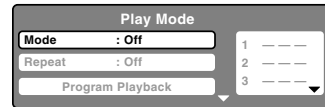

3 Press **PLAY MODE** again to clear the screen.

■ To turn on the PBC

Follow the above steps 1~2, then press **ENTER** repeatedly until "PBC" appear.

Note:

You can also turn off the PBC by pressing number button **1** and **ENTER** in the stop mode.

Advanced playback

MP3/WMA/JPEG/DivX® and Audio CD operation

This player can playback the MP3/WMA/JPEG/DivX®-data which has been recorded on CD-R or CD-RW. To produce the MP3/WMA/JPEG/DivX®-data, you need a Windows-PC with CD-RW drive and a MP3/WMA/JPEG/DivX®-encoding Software (not supplied). The Apple-HFS-System cannot be played.

This player requires discs/recordings to meet certain technical standards in order to achieve optimal playback quality. There are many different types of recordable disc formats (including CD-R containing MP3/WMA files). Not all recordable discs will produce optimal playback quality. The technical criteria set forth in this owner's manual are meant only as a guide. Use of CD-RW for MP3 files is not recommended.

You must obtain any required permission from copyright owners to download or use copyrighted content. Toshiba cannot and does not grant such permission.

CD/MP3/WMA/JPEG/DivX® CD information

Limitations on MP3/WMA/JPEG/DivX® CD playback

- MP3/WMA/JPEG/DivX® CD is the disc that is standardized by ISO9660, its file name must include 3-digits extension letters, ".mp3", ".wma", ".jpg", ".div", ".divx", ".avi".
- MP3/WMA/JPEG/DivX® CD must be correspond to the ISO standardized files.
- This unit can read 600 files per disc. If one directory has more than 600 files, the remaining files will be omitted.
- The unit is able to recognize up to a maximum of 50 directories per disc.
- MP3/WMA/JPEG/DivX® CDs cannot be used for the purpose of recording.
- If the CD has both CDA audio tracks and MP3/WMA/JPEG/DivX® files, only the CDA audio tracks will be played.
- It may take more than one minute for this unit to read MP3/WMA/JPEG/DivX® files depending on its structure.
- Music recorded by "Joliet Recording Specification" can be played back, the file name is displayed (within 15 letters) on the screen. Long file names will be condensed.
- The music files recorded by "Hierarchical File System" (HFS) cannot be played.

Limitations on display

- The maximum number for display is 15 letters.
Available letters for display are the following:
capital or small alphabets of A through Z, numbers of 0 through 9, and _ (under score).
- Other letters than those above are replaced in hyphen.

Notes on MP3/WMA/JPEG/DivX® files

To playback MP3/WMA/JPEG/DivX® CD in the recorded order,

1. Use MP3/WMA/JPEG/DivX® software that records data alphabetically or numerically.
2. Name each file including two-digit or three-digit number (ex. "01" "02" or "001" "002").
3. Refrain from making too many sub-folders.

CAUTION:

- Some MP3/WMA/JPEG/DivX® CDs cannot be played back depending on the recording conditions.
- The CD-R/RW that has no music data or non MP3/WMA/JPEG/DivX® files cannot be played back.

Standard, sampling frequency, and the bit rate:

MP3 CD

MPEG-1 Audio

32kHz, 44.1kHz, 48kHz

32kbps ~ 320kbps (constant bit rate or variable bit rate)

The recommend recording setting for a high-quality sound is 44.1kHz of sampling frequency and 128kbps of constant bit rate.

WMA CD

WMA version 7, and 8

32kHz/48kbps, 44.1kHz/48kbps~192kbps, 48kHz/128kbps~192kbps

The file recorded by mono, 48kHz, 48 kbps is not available to this unit.

DivX® video

DivX® version: DivX® 3, 4, 5, and 6 (specifically 3.1.1, 4.1.2, 5.0.2, 5.0.5, 5.1.1, 5.2.1, 6.0 at Home Theater profile).

Audio format: MPEG1 Layer2 (MP2), MPEG1 Layer3 (MP3)

Sampling frequencies: 32kHz, 44.1kHz, 48kHz

Bit rate: 32kbps ~ 320kbps

Resolution: Max 720 x 576 (at 25fps), Max 720 x 480 (at 30fps)

Microsoft, Windows Media, and Windows Logo are either registered trademarks or trademarks of Microsoft Corporation in the United States and/or other countries.

DivX, DivX Certified, and associated logos are trademarks of DivX, Inc. and are used under license.

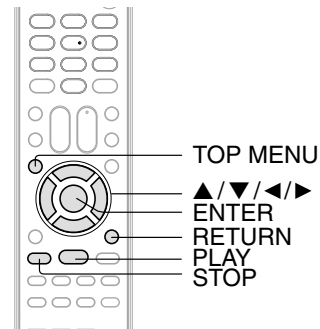

CD MP3/WMA CD playback

1 Load a disc on which MP3 or WMA files have been recorded in the disc slot.

2 A file browser screen will appear on the screen.

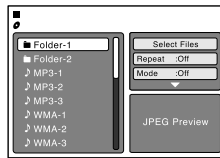

3 Press ▲/▼ to select file.

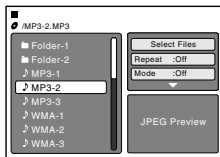

- In case the current directory includes more than 8 files, press ▲ or ▼ to scroll in the file list.
- To see contents in folder, select the folder and then press **ENTER**. To return to the upstairs directory, select "Go Up ..." then press **ENTER**.
- When **PLAY** is pressed after the file browser displayed, playback begins automatically starting from the first file. In this case, if the first file is an MP3/WMA file, only MP3/WMA files are played back in order. If the first file is a JPEG file, the first JPEG file is played back. If the first file is a DivX® file, the first DivX® file is played back. If there is no file at a root directory, playback does not begin automatically.

4 Press **ENTER**.
The selected file starts playing back.



5 Press **STOP** to end playback.



- The unit records the stopped point. "■" appears on the screen. Press **PLAY** to resume playback (from the scene point).
- If you press **STOP** again or unload the disc, the unit will clear the stopped point.

About file menu

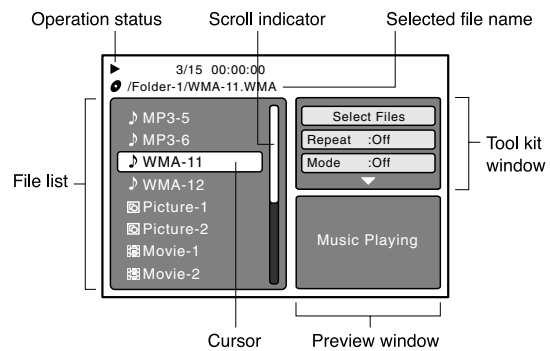

- ♪ : Indicates Music file (Audio/MP3/WMA)
- 🖼️ : Indicates Picture file (JPEG)
- 🎬 : Indicates Movie file (DivX® video)

Notes:

- The thumbnail list is displayed when the FUJICOLOR CD or the Kodak Picture CD are played. To display the file browser, press **TOP MENU**.
- In the case of a CD containing a mixture of MP3, WMA, JPEG and DivX® files, the files are played back by selecting them from the file browser.
- MP3 or WMA file on the Kodak Picture CD is not recognized on this unit.

Notes:

- During MP3/WMA/JPEG Playback, you cannot use JUMP and A-B Repeat functions.
- You can use Repeat (Track or All), Random functions and Program playback for MP3/WMA/JPEG/DivX® CD Playback **44**, **45**.

Select Files

The file type to make it display in the file browser can be chosen.

1. Press ◀ or ▶ to highlight "Select Files" at right column in the file browser.
2. Press **ENTER**, then press ▲ or ▼ to select file type from the list (Music, Picture or Movie).
3. Press **ENTER** to add/remove check mark. Checked file type will be displayed in the file browser.
4. Press **RETURN** to save the setting.

Advanced playback

MP3/WMA/JPEG/DivX® and Audio CD operation (Continued)

You can select your desired JPEG file on the file menu and picture menu. The selected JPEG file is automatically adjusted to the TV screen. (When the aspect ratio of the JPEG file is different to the TV screen, the black bar will appear at the top and bottom, or the both sides of the TV screen.)

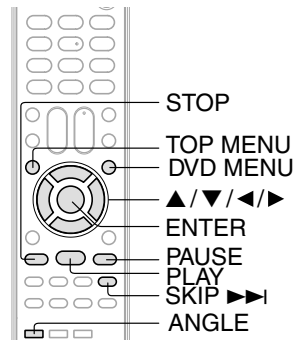

CD JPEG CD playback

- 1 Load a JPEG disc in the slot.**
- 2 A file browser screen will appear on the screen.**
- 3 Press ▲/▼ to select the file.**
 To display a thumbnail list, press **DVD MENU**. Press ◀/▶ or ▲/▼ to select the desired file. (To return to a file browser, press **TOP MENU**.)
 - When **PLAY** is pressed after displaying the file browser, playback begins automatically starting from the first file. In this case, if the first file is a JPEG file, the first JPEG file is played back. If the first file is a DivX® file, the first DivX® file is played back. If the first file is an MP3/WMA file, only MP3/WMA files are played back in order. If there is no file at a root directory, playback does not begin automatically.
- 4 Press ENTER or PLAY. The selected picture appears on the screen.**

Rotating an image
 You can rotate an image by 90 degrees. Press **ANGLE** during playback of the image.

“◀▶”, “▲▼”, “◀▶” or “▲▼” appears on the screen.
- 5 Press STOP to end playback.**
 The file browser appears on the screen. If you want to watch the other file, repeat steps 3 ~ 4.

CD Slide show playback

- The slide show enables you to view pictures (files) one after another automatically.
- Preparation:**
- Set “JPEG Interval” setting to “5 Seconds”, “10 Seconds” or “15 Seconds” [49].
- 1 Select your desired starting file for the slide show in the step 3 on left.**
 - 2 Press ENTER or PLAY to start slide show from the selected file.**
 - If you press **PAUSE** during the slide show, the slide show stops temporary. “IF” appears briefly on the screen. If the picture appears upside down or sideways, press **ANGLE** repeatedly until it's right side up.
 - “◀▶”, “▲▼”, “◀▶” or “▲▼” appears on the screen.
 - Press **PLAY** or **SKIP ►►** again to resume the slide show.
 - When the slide show playback finished, the file list appears.
 - To stop the slide show, press **STOP**. The file list appears.

- Notes:**
- Zoom function also can be used in viewing JPEG files. See “Zooming” [34].
 - During JPEG playback, you cannot use Jump and A-B Repeat functions.

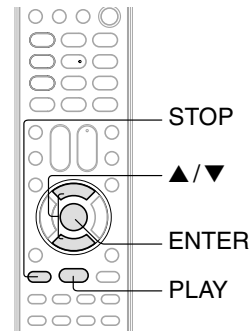

CD DivX® CD playback

1 Load a disc on which DivX® files have been recorded in the slot.

2 A file browser screen will appear on the screen.

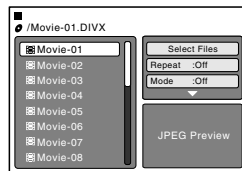

3 Press ▲/▼ to select file.

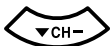

- When **PLAY** has been pressed after displaying the file browser, playback begins automatically starting from the first file. In this case, if the first file is a JPEG file, the first JPEG file is played back. If the first file is a DivX® file, the first DivX® file is played back. If the first file is an MP3/WMA file, only MP3/WMA file are played back in order. If there is no file at a root directory, playback does not begin automatically.

4 Press **ENTER** or **PLAY**. The selected DivX® movie will be played back on the screen.



5 Press **STOP** to end playback.



The file browser appears on the screen. If you want to watch the other file, repeat steps 3 ~ 4.

CD Playing DivX® VOD content

DivX® VOD content is protected by DRM (Digital Rights Management) system. This restricts playback of content to specific registered devices.

If the incorrect DRM file is loaded, "Authorization Error This player is not authorized to play this video." will appear on the screen.

When you attempt to play DivX® VOD, the number of plays is limited and the right message will appear on the screen. If you wish to play it, select "YES".

View DivX® VOD Rental
This rental has 5 views left.
Do you want to use one
of your 5 views now?

Yes No

- If the number of plays goes over the limit, then "Rental Expired" will be displayed, in this case the file will not be played.

Note:

In order to play DivX® VOD content on this unit, you first need to register the unit with registration code. See page 51.

Advanced playback

Repeat and program playback using file browser

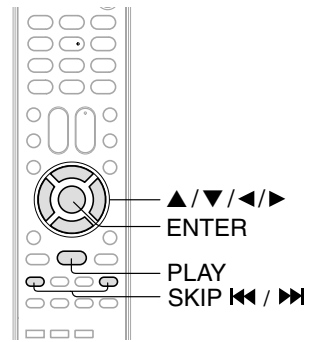

Repeat playback (CD)

1 In the file browser, press ◀/▶ or ▲/▼ to select "Repeat" during stop mode.



2 Press ENTER to select "Track" or "All".



3 Press PLAY.

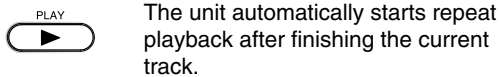

■ **To resume normal playback**
Select Repeat : "Off" in step 2.

Notes:

- The program is canceled when you eject the disc or turn the power off.
- In case of Audio CD, the function of A-B Repeat can be used. See "A-B Repeat playback" [47](#).
- Track repeat function is canceled whenever SKIP ◀◀ or ▶▶ is pressed.

Random playback (CD)

1 In the file browser, press ◀/▶ or ▲/▼ to select "Mode" during stop mode.

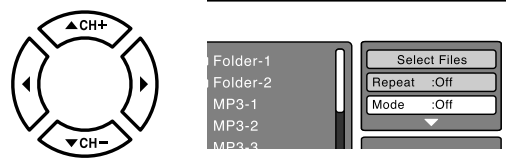

2 Press ENTER to select "Random".



3 Press PLAY.



■ **To resume normal playback**
Select Mode : "Off" in step 2.

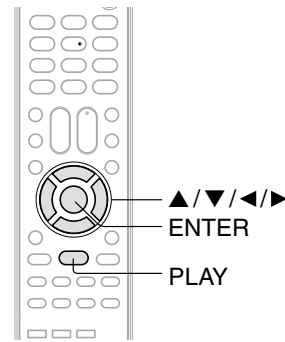

CD Program playback (CD)

- 1** In the file browser, press **◀/▶** or **▲/▼** to select “Edit Mode”, then press **ENTER**.

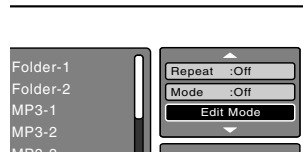
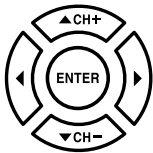

When “Edit Mode” is black color, you can mark the files which you want to add into Program list.

- 2** Press **◀/▶** or **▲/▼** to select file you want to add into the program list.

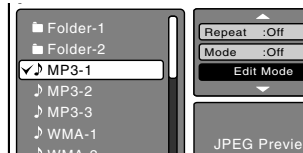
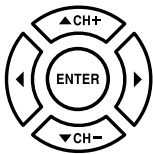

Press **ENTER**. Selected file was marked.
Repeat this procedure to select the other files.

- 3** Press **◀/▶** or **▲/▼** to select “Add To Program”. Then press **ENTER**. All marked files are added into the program list.

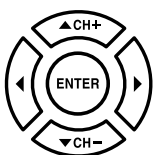

•When you finish store all files which you want into the Program list, select “Edit Mode” and press **ENTER** to release edit mode.

- 4** Press **◀/▶** or **▲/▼** to select “Program View”, then press **ENTER**. Program View shows only the programmed files that you have added in step 2.

Program View



Browser View

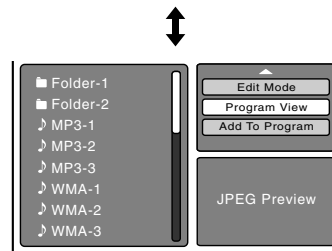

- 5** In the Program View, press **PLAY**. The files start to playback in programmed order that were added by you.

To remove file from program list

In the Edit Mode, switch to Program View. Select file you want to remove, then press **ENTER**. Select “Clear Program” and press **ENTER**. Marked file is removed from program list.

Advanced playback

Customizing the function settings

You can change the default settings of the DVD mode to customize performance to your preference.

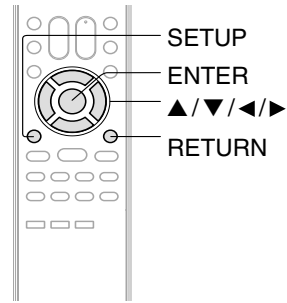

DVD VCD CD Setting procedure

1 Press SETUP during stop mode.

The following on-screen display appears.

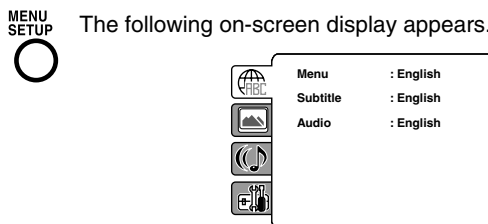

2 Press ▲ or ▼ to select the desired section, then press ►.

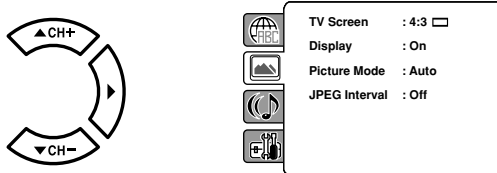

3 First option will be highlighted. Press ▲ or ▼ to select the desired option.

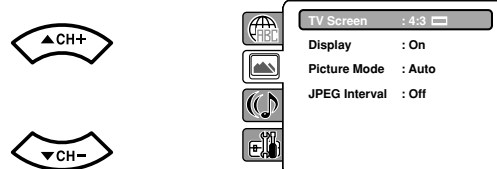

4 Then press ► or ENTER. The selectable settings will appear.

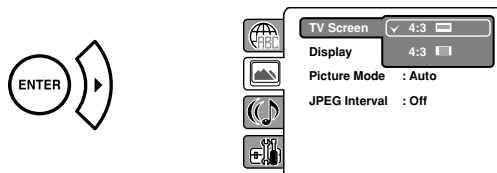

5 Change the selection using ▲ or ▼, by referring to the corresponding pages 48 ~ 51. Press ENTER to save the setting.

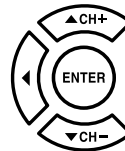

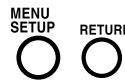

- Repeat steps 3 and 5 to change other option.
- To select another section, go back to step 2 by pressing ◀ repeatedly.

6 To clear SETUP screen, press SETUP or RETURN.



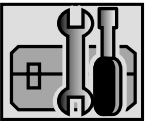

Setting details

Section	Option	Details	Page
	Menu Subtitle Audio	To select the language of "Menu", "Subtitle" and "Audio" if more than one language are available on the disc.	48
	TV Screen	To select a picture size according to the aspect ratio of your TV.	48
	Display	To turn On or Off the operational status display on the screen.	
	Picture Mode	To select a preferred picture mode from "Video", "Film" or "Auto".	49
	JPEG Interval	To select a preferred setting for the slide show playback.	
	DRC	To select On or Off for DRC (Dynamic Range Control).	50
	Parental	To select a preferred parental level for the parental setting.	50
	Password	Input 4-digit password to set the parental level.	
	DivX(R) VOD	To display your 8-character registration code.	51

Function setup

Customizing the function settings (Continued)

Setting details



	Menu	: English
	Subtitle	: English
	Audio	: English

■ Menu, Subtitle, Audio

You can select the language of “Menu”, “Subtitle” and “Audio” if more than one languages are recorded onto the disc.

English, Francais, Espanol:

The selected language will be heard or seen.

Other:

Other language can be selected (see “Language code list” [53](#)).

Original (Audio):

The unit will select the first priority language of each disc.

Off (Subtitle):

Subtitles do not appear.

Notes:

- If the selected language is not recorded on the disc, the first-priority language is selected.
- If you want to change the OSD language, you can perform it by TV SETUP MENU [21](#).



	TV Screen	: 4:3 <input type="checkbox"/>
	Display	: On
	Picture Mode	: Auto
	JPEG Interval	: Off

■ TV Screen

You have the following screen sizes to choose from:

4:3 (Letter box):

Select this mode when connecting to a conventional TV. When playing back a wide screen-DVD disc, it displays the wide picture with black bands at the top and bottom of screen.

4:3 (Pan & scan):

It displays the wide picture on the whole screen with left and right edges automatically cut off.

Note:

If the DVD disc is not formatted in the Pan & scan style, it will display 4:3 style.

■ Display

On screen display can be switched on or off when you press any buttons.

On: On screen displays appear when you press the buttons (factory setting).

Off: On screen displays do not appear when you press any buttons.



■ Picture Mode

There are two types of source content in pictures recorded in DVD video discs: film content (pictures recorded from films at 24 frames per second) and video content (video signals recorded at 30 frames per second). Make this selection according to the type of content being viewed.

Auto: Select this position normally. The DVD player automatically detects source content, film or video of playback source, and converts that signal in the progressive output format in an appropriate method.

Film: The DVD player converts film content pictures in the progressive output format appropriately. Suitable for playback of film content pictures. The progressive output feature will be most effective under this selection.

Video: The DVD player filters video signal and converts it in the progressive output format appropriately. Suitable for playback of video content pictures.

Note:

Depending on the disc, pictures may be cut off or doubled. In this case, select "Video".

■ JPEG Interval

You can continuously playback all JPEG files automatically. After the selection below, the disc will start playback on which JPEG files have been recorded.

Off:
Plays back one file at a time.

5 Seconds:
Plays back images in the form of a slide show at 5 second intervals.

10 Seconds:
Plays back images in the form of a slide show at 10 second intervals.

15 Seconds:
Plays back images in the form of a slide show at 15 second intervals.



Function setup



Customizing the function settings (Continued)

Setting details

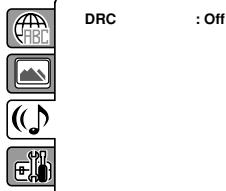

■ DRC

DRC (Dynamic Range Control) enables you to control the dynamic range so as to achieve a suitable sound for your equipment.

Off:

It plays back at the recording level on the disc.

On:

Loud sound such as explosion is toned down slightly when played back. This is suitable when it is connected to a stereo.

Notes:

- This function works only during playback of Dolby Digital recorded discs.
- The level of Dynamic Range Reduction may differ depending on DVD video disc.

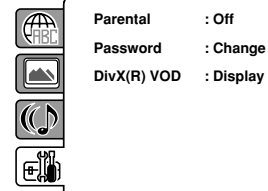
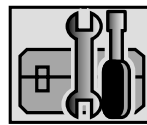

■ Parental control setting

Some discs are specified as not suitable for children. Such discs can be limited not to playback with the unit.

- 1) Press **▲** or **▼** to select "Parental", then press **ENTER**. "Enter Password" screen will appear.
- 2) Press "0000" using **Number buttons (0–9)**. (Please note, this is pre-setting password of this unit). Then press **ENTER**. The parental level list will appear.
 - **Level Off:** The parental control setting does not function.
 - **Level 8:** All DVD software can be played back.
 - **Level 1:** DVD software for adults cannot be played back.
- 3) Press **▲** or **▼** to select from the level 1 to level 8. The limitation will be more severe as the level number is lower. Then press **ENTER**.

Notes:

- Depending on the discs, the unit cannot limit playback.
- Some discs may not be encoded with specific rating level information though its disc jacket says "adult." For those discs, the age restriction will not work.
- The password is required every time when you change the parental level.
- If you input a wrong number, press **CANCEL**.



■ Set the new password

- 1) Press **▲** or **▼** to select "Password", then press **ENTER**. "Enter Current Password" screen will appear.
- 2) Press **Number buttons (0–9)** to input the current password (If the password has not been set yet after you purchase this unit, it is "0000").
- 3) Then press **ENTER**. "Enter New Password" screen will appear. Press **Number buttons (0–9)** to input the new password.
- 4) Press **ENTER**. Now your new password has been set. Be sure to remember this number!

If you forget the password.

- 1) Press **EJECT** to remove the disc.
- 2) While holding **7** down on the remote control and then press **STOP** on the front panel. "Password Clear" appears on the screen. Now the password has been returned to the initial value ("0000").

■ DivX® VOD

In order to play DivX® VOD (Video On Demand) content on this unit, you first need to register the unit with your DivX® VOD content provider. You do this by generating a DivX® VOD registration code, which you submit to your provider.

Press **▲** or **▼** to select "DivX(R) VOD". Then press **ENTER**. Your 8-character registration code is displayed. Make a note of the code as you will need it when you register with a DivX® VOD provider. Then press **ENTER** to select Done.

Note:

If each setup (pages 48 ~ 51) has completed, the unit can always work under the same condition (especially with DVD discs).

Each setup will be retained in the memory even if you turn the power off.

Temporary cancel the rating level by DVD disc

Depending on the DVD disc, the disc may try to temporarily cancel the rating level that you have set. It is up to you to decide whether to cancel the rating level or not.

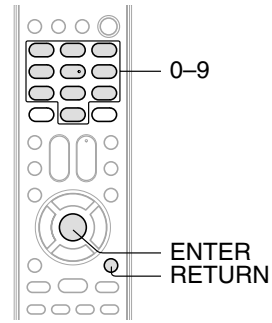

DVD Temporary cancel the rating level by DVD disc

1 Load a DVD disc.

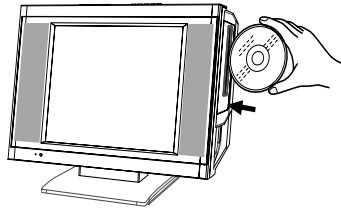

Note:

This temporary cancellation of rating level will be kept until the disc is ejected. When the disc is ejected, the original rating level will be set again automatically.

2 If the DVD disc has been designed to temporarily cancel the Rating level, the screen which follows the "Reading" screen will change, depending on which disc is played. If you select "YES" with the ENTER key, password input screen will then appear.

- If "NO" is selected, press EJECT to remove the disc.

3 Enter the password with Number buttons (0-9). Then press ENTER.

To exit from the entry, press RETURN.

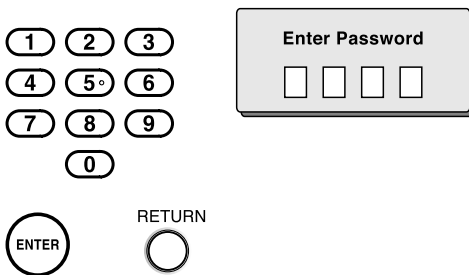

4 Playback will commence if the entered password is correct.

Language code list

Enter the appropriate code number for the initial settings "Menu", "Subtitle" and/or "Audio" **48**.

Language Name	Code	Language Name	Code	Language Name	Code	Language Name	Code
Abkhazian	1112	Fiji	1620	Lingala	2224	Singhalese	2919
Afar	1111	Finnish	1619	Lithuanian	2230	Slovak	2921
Afrikaans	1116	French	1628	Macedonian	2321	Slovenian	2922
Albanian	2927	Frisian	1635	Malagasy	2317	Somali	2925
Amharic	1123	Galician	1722	Malay	2329	Spanish	1529
Arabic	1128	Georgian	2111	Malayalam	2322	Sundanese	2931
Armenian	1835	German	1415	Maltese	2330	Swahili	2933
Assamese	1129	Greek	1522	Maori	2319	Swedish	2932
Aymara	1135	Greenlandic	2122	Marathi	2328	Tagalog	3022
Azerbaijani	1136	Guarani	1724	Moldavian	2325	Tajik	3017
Bashkir	1211	Gujarati	1731	Mongolian	2324	Tamil	3011
Basque	1531	Hausa	1811	Nauru	2411	Tatar	3030
Bengali; Bangla	1224	Hebrew	1933	Nepali	2415	Telugu	3015
Bhutani	1436	Hindi	1819	Norwegian	2425	Thai	3018
Bihari	1218	Hungarian	1831	Oriya	2528	Tibetan	1225
Breton	1228	Icelandic	1929	Panjabi	2611	Tigrinya	3019
Bulgarian	1217	Indonesian	1924	Pashto, Pushto	2629	Tonga	3025
Burmese	2335	Interlingua	1911	Persian	1611	Turkish	3028
Byelorussian	1215	Irish	1711	Polish	2622	Turkmen	3021
Cambodian	2123	Italian	1930	Portuguese	2630	Twi	3033
Catalan	1311	Japanese	2011	Quechua	2731	Ukrainian	3121
Chinese	3618	Javanese	2033	Rhaeto-Romance	2823	Urdu	3128
Corsican	1325	Kannada	2124	Romanian	2825	Uzbek	3136
Croatian	1828	Kashmiri	2129	Russian	2831	Vietnamese	3219
Czech	1329	Kazakh	2121	Samoan	2923	Volapük	3225
Danish	1411	Kirghiz	2135	Sanskrit	2911	Welsh	1335
Dutch	2422	Korean	2125	Scots Gaelic	1714	Wolof	3325
English	1524	Kurdish	2131	Serbian	2928	Xhosa	3418
Esperanto	1525	Laothian	2225	Serbo-Croatian	2918	Yiddish	2019
Estonian	1530	Latin	2211	Shona	2924	Yoruba	3525
Faroese	1625	Latvian, Lettish	2232	Sindhi	2914	Zulu	3631

Troubleshooting

Use the following check list for troubleshooting when you have problems with your unit. Consult your local dealer or service outlet if problems persist.

Be sure all connections are properly made when using with other units.

SYMPTOMS	POSSIBLE SOLUTIONS	PAGE
POWER		
TV/DVD does not operate.	<ul style="list-style-type: none"> • Make sure the connection of the AC adapter and AC cord. • Try another AC outlet. • Unplug unit, then plug it back in. 	20
TV BROADCAST RECEPTION		
Poor sound or No sound.	<ul style="list-style-type: none"> • Station or Cable TV may have problems, try another station. • Check Volume adjustments. • Check for sources of possible interference. 	23 23 56
Poor picture or No picture.	<ul style="list-style-type: none"> • Station or Cable TV may have problems, try another station. • Check antenna or Cable TV connections, reorient antenna. • Check for sources of possible interference. • Check picture control adjustments. 	23 14,15 56 28
Poor reception on some channels.	<ul style="list-style-type: none"> • Station or Cable TV may have problems, try another station. • Station signal is weak, reorient antenna to receive weaker station. • Check for sources of possible interference. 	23 14 56
Poor color or no color.	<ul style="list-style-type: none"> • Station or Cable TV may have problems, try another station. • Make sure channels are set into memory. • Check picture control adjustments. • Check antenna or Cable TV connections, reorient antenna. • Check for sources of possible interference. 	23 22 28 14,15 56
Picture wobbles or drifts.	<ul style="list-style-type: none"> • Station or Cable TV may have problems, try another station. • Make sure channels are set into memory. • Cable TV company is scrambling signal. • Check antenna or Cable TV connections, reorient antenna. 	23 22 – 14,15
No CATV reception.	<ul style="list-style-type: none"> • Check all Cable TV connections. • Set TV/CABLE selection to the CABLE position. • Station or Cable TV system problems, try another station. 	15 22 23
Horizontal or diagonal bars on screen.	<ul style="list-style-type: none"> • Check antenna or Cable TV connections, reorient antenna. • Check for sources of possible interference. 	14,15 56
No reception above channel 13.	<ul style="list-style-type: none"> • Make sure TV/CABLE selection is in the appropriate position. • If using antenna, check UHF antenna connections. 	22 14
TV shuts off.	<ul style="list-style-type: none"> • No broadcast on station tuned. • Auto power off feature worked. • Sleep Timer is set. • Power interrupted. 	22 23 24 –
Closed - Caption is not activated.	<ul style="list-style-type: none"> • TV station experiencing problems or program tuned is not closed captioned. Try another channel. • Check Cable TV connection or VHF/UHF antenna, reposition or rotate antenna. • Press CLOSED CAPTION button to turn on the closed caption decoder. 	23 14,15 25
Display is not shown in your language.	<ul style="list-style-type: none"> • Select proper language in the menu options. 	21



SYMPTOMS	POSSIBLE SOLUTIONS	PAGE
DVD		
Playback doesn't start.	<ul style="list-style-type: none"> No disc is loaded. The disc may be dirty. Clean up the disc. The unit cannot play CD-ROMs, etc. 	31 7 8
No picture.	<ul style="list-style-type: none"> TV/DVD selector is not set correctly. 	31
No sound.	<ul style="list-style-type: none"> Check the input selector of the amplifier is set properly. The unit is in the special playback mode. Select the correct Audio Input/Output position on AV amplifier. 	– 33 18
Picture is distorted during fast reverse/forward playback.	<ul style="list-style-type: none"> The picture will be distorted occasionally. 	–
Stopping playback, search, slow-motion play, repeat play, or program play, etc. cannot be performed.	<ul style="list-style-type: none"> Some discs may not do some of the functions. 	–
No on-screen display.	<ul style="list-style-type: none"> Set Display to On. 	48
The unit or remote operation key is not functioning.	<ul style="list-style-type: none"> Turn off the unit and unplug the AC power cord for several minutes, then replug it. 	–
Playback does not start when the title is selected.	<ul style="list-style-type: none"> Check the RATING LEVEL setup. 	50
Audio soundtrack and/or subtitle language is not changed when you playback a DVD.	<ul style="list-style-type: none"> Multilingual language is not recorded on the DVD disc. 	38
No subtitle.	<ul style="list-style-type: none"> Some discs have no subtitles. Subtitles are cleared. Press the SUBTITLE button. 	38
Angle cannot be changed.	<ul style="list-style-type: none"> Multi-angles are not recorded on the DVD disc. 	37
"X" appears on the screen.	<ul style="list-style-type: none"> The function is prohibited with the unit or the disc. 	33
REMOTE CONTROL		
The remote control does not function.	<ul style="list-style-type: none"> Aim the remote control at the remote sensor. Operate within approx. 5 meters or reduce the light in the room. Clear the path of the beam. The batteries are weak. Replace the batteries. Check the batteries are inserted correctly. 	13

Others





Reception disturbances

Most types of television interference can be remedied by adjusting the height and position of the VHF/UHF antenna. Outdoor antennas are recommended for best results. The most common types of television interference are shown below. If one of these symptoms appear when the TV/DVD is connected to a Cable TV system, the disturbance may be caused by the local Cable TV company broadcast.

IGNITION

Black spots or horizontal streaks may appear, the picture may flutter or drift. Usually caused by interference from automobile ignition systems, neon lamps or AC powered tools and appliances such as drills or hair dryers.



GHOSTS

Ghosts are caused by the television signal following two paths. One is the direct path and the other is reflected by tall buildings, hills or other large objects. Changing the direction or position of the antenna may improve the reception.



SNOW

If the TV/DVD is located far from the TV station, in a fringe reception area where the signal is weak, small dots may appear in the picture. If the signal is extremely weak, the installation of a larger external antenna may be necessary.



RADIO FREQUENCY INTERFERENCE (RFI)

Caused by two-way radios, this type of interference produces moving ripples or diagonal streaks in the picture. Some cases may cause a loss of contrast in the picture. Changing the direction and position of the antenna or installing an RFI filter may improve the picture.



CARE AND MAINTENANCE

To prevent fire or shock hazard, disconnect the TV/DVD from the power source before cleaning. Use caution when cleaning or wiping the plastic parts.



Specifications

General

Power supply	AC 120V 60Hz (with supplied AC adapter)
Power consumption	Operation: 50 W, Stand by: 1 W (with supplied AC adapter)
Weight	13.2 lbs (6.0 kg)
Dimensions	Width: 18-3/4 inches (476 mm) Height: 13-15/16 inches (353.5 mm) Depth: 9-1/16 inches (230 mm)
Operating temperature	5°C-40°C (41°F-104°F)
Operating humidity	Less than 80% RH (No condensation)

Television

LCD panel	15-inch diagonal (Screen size is approximate.)
Display method	Color TFT LCD
Number of pixels	1024 (Horizontal) x 768 (Vertical)
Tuner type	F-Synth
Receiving channels	VHF: 2-13 UHF: 14-69 CATV: 1-125 (4A, A5~A1, A~I, J~W, W+1~W+84)
Antenna input	VHF/UHF 75 Ω
Speaker	1-1/2 x 2-11/16 inches (38.1 x 68.6 mm), 8 Ω x 2
Audio output power	1.5W + 1.5W

DVD/CD Player

Signal system	NTSC
Applicable disc	1. DVD (12cm, 8cm) 2. CD (12cm, 8cm)
Pickup	1-Lens, 2-Beams System

Input/Output

S-Video input	(Y) 1.0 V (p-p), 75 Ω, negative sync., Mini DIN 4-pin x 1 (C) 1.0 V (p-p), 75 Ω
Component video input	(Y) 1.0 V (p-p), 75 Ω, negative sync., pin jack x 1 (P _B , P _R) 0.7V (p-p), 75 Ω, pin jack x 2
Video input	1.0 V (p-p), 75 Ω, negative sync., pin jack x 2
Audio input	-8dBm, 50 kΩ, negative sync., pin jack (L/R) x 2
Digital audio output (Coaxial)	0.5 V (p-p), 75 Ω, pin jack x 1
Headphone	ø3.5mm stereo mini jack x 1

Accessories

Remote control (DC-LB1)	1
Batteries (R03/AAA)	2
AC adapter	1
AC cord (for AC adapter)	1
300-75 Ω matching transformer	1
Owner's manual (this booklet)	1

- This model complies with the above specifications.
- Designs and specifications are subject to change without notice.
- This model may not be compatible with features and/or specifications that may be added in the future.

Others



Limited United States Warranty LCD TV/DVD Combination - Depot Repair Warranty

Toshiba America Consumer Products, L.L.C. ("TACP") makes the following limited warranties to original consumers in the United States. THESE LIMITED WARRANTIES EXTEND TO THE ORIGINAL CONSUMER PURCHASER OR ANY PERSON RECEIVING THIS LCD TV/DVD COMBINATION AS A GIFT FROM THE ORIGINAL CONSUMER PURCHASER AND TO NO OTHER PURCHASER OR TRANSFEREE.

LCD TV/DVD COMBINATIONS PURCHASED IN THE U.S.A. AND USED ANYWHERE OUTSIDE OF THE U.S.A., INCLUDING, WITHOUT LIMITATION, CANADA AND MEXICO, ARE NOT COVERED BY THESE WARRANTIES.

LCD TV/DVD COMBINATIONS PURCHASED ANYWHERE OUTSIDE OF THE U.S.A., INCLUDING, WITHOUT LIMITATION, CANADA AND MEXICO, AND USED IN THE U.S.A., ARE NOT COVERED BY THESE WARRANTIES.

Limited One (1) Year Warranty on Parts and Labor

TACP warrants this LCD TV/DVD Combination and its parts against defects in materials or workmanship for a period of one (1) year after the date of original retail purchase. DURING THIS PERIOD, TACP WILL, AT TACP'S OPTION, REPAIR OR REPLACE A DEFECTIVE PART WITH A NEW OR REFURBISHED PART WITHOUT CHARGE TO YOU.

Rental Units

The warranty for LCD TV/DVD Combination rental units begins on the date of the first rental or thirty (30) days after the date of shipment to the rental firm, whichever comes first.

Commercial Units

LCD TV/DVD Combinations sold and used for commercial purposes have a limited warranty for all parts and labor, which warranty begins on the date of original retail purchase and ends on the date that is ninety (90) days thereafter.

Owner's Manual and Product Registration Card

Read this owner's manual thoroughly before operating this LCD TV/DVD Combination.

Complete and mail the enclosed product registration card or register your LCD TV/DVD Combination online at www.tacp.toshiba.com/service as soon as possible. By registering your LCD TV/DVD Combination you will enable TACP to bring you new products specifically designed to meet your needs and help us to contact you in the unlikely event a safety notification is required under the U.S. Consumer Product Safety Act. Failure to complete and return the product registration card does not diminish your warranty rights.

Your Responsibility

THE ABOVE WARRANTIES ARE SUBJECT TO THE FOLLOWING CONDITIONS:

- (1) You must retain your bill of sale or provide other proof of purchase.
- (2) All warranty servicing of this LCD TV/DVD Combination must be made by the Depot Warranty Repair Center specified by the TACP Consumer Solutions Center.
- (3) The warranties from TACP are effective only if the LCD TV/DVD Combination is purchased and operated in the Continental U.S.A. or Puerto Rico.
- (4) Labor service charges for set installation, setup, adjustment of customer controls, and installation or repair of antenna systems are not covered by this warranty. Reception problems caused by inadequate antenna systems are your responsibility.
- (5) Warranties extend only to defects in materials or workmanship as limited above, and do not extend to any LCD TV/DVD Combination or parts that have been lost or discarded by you or to damage to the LCD TV/DVD Combination or parts caused by fires, misuse, accident, Acts of God (such as lightning or fluctuations in electric power), improper installation, improper maintenance, or use in violation of instructions furnished by TACP; use or malfunction through simultaneous use of this LCD TV/DVD Combination and connected equipment; or to units that have been modified or had the serial number removed, altered, defaced, or rendered illegible.



How to Obtain Warranty Services

If, after following all of the operating instructions in this manual and checking the section "Troubleshooting," you find that service is needed:

- (1) For instructions on how to obtain warranty service for your LCD TV/DVD Combination, contact TACP's Consumer Solution Center toll free at 1-800-631-3811.
- (2) You must include a copy or original bill of sale or other proof of purchase along with the entire LCD TV/DVD Combination to the Depot Warranty Repair Center specified by the TACP Consumer Solutions Center. You are responsible for all inbound transportation and insurance charges for the LCD TV/DVD Combination to the Depot Warranty Repair Center specified by the TACP Consumer Solutions Center.

For additional information, visit TACP's website:
www.tacp.toshiba.com

ALL WARRANTIES IMPLIED BY THE LAW OF ANY STATE OF THE U.S.A., INCLUDING THE IMPLIED WARRANTIES OF MERCHANTABILITY AND FITNESS FOR A PARTICULAR PURPOSE, ARE EXPRESSLY LIMITED TO THE DURATION OF THE LIMITED WARRANTIES SET FORTH ABOVE. WITH THE EXCEPTION OF ANY WARRANTIES IMPLIED BY THE LAW OF ANY STATE OF THE U.S.A. AS HEREBY LIMITED, THE FOREGOING WARRANTY IS EXCLUSIVE AND IN LIEU OF ALL OTHER WARRANTIES, GUARANTEES, AGREEMENTS, AND SIMILAR OBLIGATIONS OF TACP WITH RESPECT TO THE REPAIR OR REPLACEMENT OF ANY PARTS. IN NO EVENT SHALL TACP BE LIABLE FOR CONSEQUENTIAL OR INCIDENTAL DAMAGES (INCLUDING, BUT NOT LIMITED TO, LOST PROFITS, BUSINESS INTERRUPTION, OR MODIFICATION OR ERASURE OF RECORDED DATA CAUSED BY USE, MISUSE OR INABILITY TO USE THIS LCD TV/DVD COMBINATION).

No person, agent, distributor, dealer, or company is authorized to change, modify, or extend the terms of these warranties in any manner whatsoever. The time within which an action must be commenced to enforce any obligation of TACP arising under the warranty or under any statute or law of the United States or any state thereof is hereby limited to ninety (90) days from the date you discover, or should have discovered, the defect. This limitation does not apply to implied warranties arising under state law.

THIS WARRANTY GIVES YOU SPECIFIC LEGAL RIGHTS AND YOU MAY ALSO HAVE OTHER RIGHTS WHICH MAY VARY FROM STATE TO STATE IN THE U.S.A. SOME STATES OF THE U.S.A. DO NOT ALLOW LIMITATIONS ON HOW LONG AN IMPLIED WARRANTY LASTS, WHEN AN ACTION MAY BE BROUGHT, OR THE EXCLUSION OR LIMITATION OF INCIDENTAL OR CONSEQUENTIAL DAMAGES, SO THE ABOVE PROVISIONS MAY NOT APPLY TO YOU UNDER SUCH CIRCUMSTANCES.

Others



TOSHIBA

ColorStream® is a registered trademark of Toshiba America Consumer Products, L.L.C.

LC)VD™ is a trademark of Toshiba America Consumer Products, L.L.C.



J5X00301A SH 06/04

Printed in Thailand

Free Manuals Download Website

<http://myh66.com>

<http://usermanuals.us>

<http://www.somanuals.com>

<http://www.4manuals.cc>

<http://www.manual-lib.com>

<http://www.404manual.com>

<http://www.luxmanual.com>

<http://aubethermostatmanual.com>

Golf course search by state

<http://golfingnear.com>

Email search by domain

<http://emailbydomain.com>

Auto manuals search

<http://auto.somanuals.com>

TV manuals search

<http://tv.somanuals.com>