

TOSHIBA

OWNER'S MANUAL

LCD Colour TV



15VL56B
15VL56G
20VL56B
20VL56G

Owner's Record

You will find the model number and serial number on the back of the TV. Record these numbers in the spaces provided below. Refer to them whenever you call upon your TOSHIBA dealer regarding this product.

Model number:

Serial number:

Introduction

Getting started

Basic operation

Using the TV's features

Viewing teletext

Equipment connections

Reference section

© 2005 TOSHIBA CORPORATION
All Rights Reserved

Welcome to Toshiba

Thank you for purchasing this Toshiba LCD Colour Television. This manual will help you use the exciting features of your new TV.

Instructions in this manual are based on using the remote control.

You can also use the controls on the TV if they have the same name as those on the remote control.

Please read all the safety and operating instructions carefully, and keep the manual for future reference.

Contents

Introduction

Important Safety Instructions	3
Installation	3
Use	5
Service	6
Cleaning	7
Important information	7
Important information	7
Installation	8
Connecting an aerial	8

Getting started

Exploring your new TV	9
TV top/TV side	9
TV front	9
TV back	10
Learning about the remote control	11
Location of controls/	
Installing the remote control batteries	11
Watching TV programmes	12
Turning the TV on or off/Volume/	
Sound mute/Programme positions	12
Switching programme return/	
On-screen information	13
Learning about the menu system	13
Selecting a language	13
Menu overview	14
Programming channel memory	15
System selection/Auto programme	15
Manual programme	16
MFT/AFT	18

Basic operation

Picture quality adjustment	19
Picture quality adjustment	19
Sound adjustment	20
Sound quality adjustment	20
WOW surround setting	21
Using the AVL function	
(Auto Volume Leveler)	21
Stereo/Bilingual selection	22

Using the TV's features

Panel lock, Input selection, Sleep Timer	23
Panel lock	23
Input selection	23
Sleep Timer	23
Blue screen function,	
Activating the Auto off function	24
Blue screen function	24
Activating the Auto off function	24

Viewing teletext

Teletext - Control buttons	25
To view normal text	25
Teletext buttons on the remote control	25
Teletext - Auto and List modes	27
Using Auto mode	27
Using List mode	28

Equipment connections

Side panel connections	29
Connection example	29
Back panel connections	30
Connection example	30
Connecting a computer	31
To connect a computer	31
PC Setting	32
Picture position/Clock/Phase adjustments	32
Auto-configure/To reset	33

Reference section

Troubleshooting	34
Symptom and solution	34
Specifications	35
LCD colour television specifications	35

Exemptions

- Toshiba is not liable for any damage caused by fires, natural disaster (such as thunder, earthquake, etc.), acts by third parties, accidents, owner's misuse, or uses in other improper conditions.
- Toshiba is not liable for incidental damages (such as profit loss or interruption in business, modification or erasure of record data, etc.) caused by use or inability to use of product.
- Toshiba is not liable for any damage caused by neglect of the instructions described in the owner's manual.
- Toshiba is not liable for any damage caused by misuse or malfunction through simultaneous use of this product and the connected equipment.

Important Safety Instructions

- Be sure to observe the following instructions and precautions to ensure safe use of this TV.
- The exact power cord will vary according to the country or region.
- The mains plug is used as a disconnecting device and therefore should be readily operable.

Installation

Always connect the power plug to an electrical outlet equipped with 100 – 240V AC 50/60 Hz.

Never use the TV outside the specified voltage range. It may cause a fire or an electric shock.

Check!

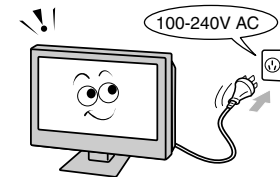

About the fuse

In a three-pin plug type, the fuse fitted in this plug is approved by ASTA or BSI to BS1362. It should only be replaced by a correctly rated and approved type and the fuse cover must be refitted.

Never insert or remove the power plug with wet hands.

This may cause electric shock.

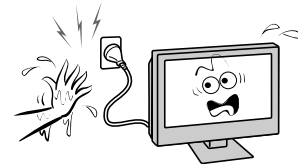

Never place the TV in an unstable location, such as on a shaky table or incline or in a location subject to vibration.

The TV may drop or fall down, which may cause injury or damage.

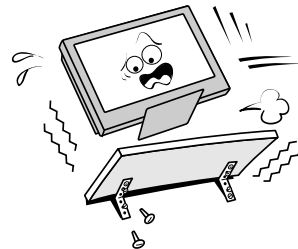

Never block or cover the slots and openings in the cabinet.

- Never place the TV so that it is facing upward or on its side.
- Never place the TV in a closet, bookcase or other similar area where the ventilation is poor.
- Never drape a newspaper, tablecloth or curtain on the TV.
- When installing the TV near a wall, always keep the TV at least 10 cm away from the wall.
- Never place the TV on a soft, unstable surface, such as carpet or a cushion.

The inside of this TV will overheat if the ventilation holes are covered, blocked or sealed, which may result in a fire.

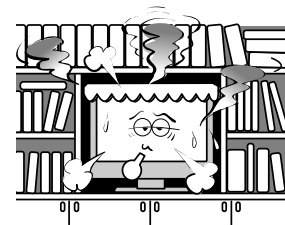

Never place the TV near a heater or in direct sunlight.

The surface of the cabinet or power cord may melt and result in fire or electric shock.



Important Safety Instructions (continued)

Installation (continued)

Never place the TV in an area exposed to high humidity levels, such as in a bathroom or close to a humidifier.

This may cause a fire or an electric shock.

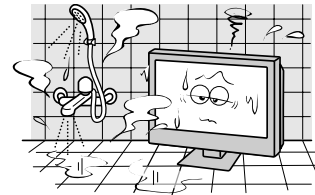

Never place the TV next to a stove where it will be exposed to oil, smoke, or steam, or in a location where there is a large quantity of dust.

This may cause a fire or an electric shock.



Install the TV in a horizontal, stable location. Connect between the two clips on the back of the TV and a wall, pillar, etc., with a sturdy tie and clip of supplied accessories (see page 36).

- Use as short a tie as possible to ensure the TV is stable.
- If the TV is not installed securely, it may lean or fall over and cause an injury.

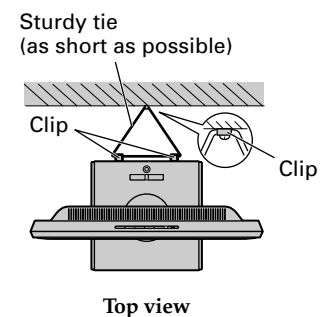
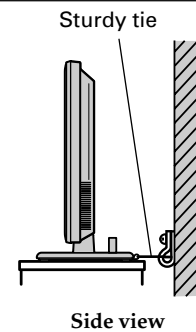

Precautions for moving the TV

- When moving the TV, be sure to remove the power plug from the wall outlet and disconnect the aerial cable, audio/video cables, and any ties. Fire or electric shock may result if the power cord is damaged.
- Never carry the TV with the screen facing up or down.



Precautions for installing an outdoor aerial

An outside aerial system should not be located in the vicinity of overhead power lines or other electric light or power circuits. If the aerial falls down or drops, it may cause injury or electric shock.



Use

Never place hot objects or open flame sources, such as lighted candles or nightlights, on or close to the TV.

High temperatures can melt plastic and lead to fires.

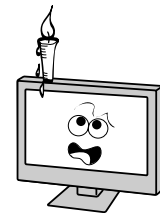

Getting started

Basic operation

The apparatus shall not be exposed to dripping or splashing and that no objects filled with liquids, such as vases, shall be placed on the apparatus.

When liquids are spilled or small items are dropped inside the TV, this may cause a fire or an electric shock. If small objects drop inside the TV, turn off the TV and remove the power plug from the outlet immediately and contact a service technician.

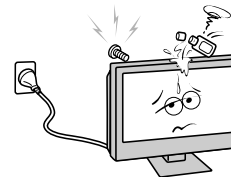

Using the TV's features

Never insert objects (metal or paper) or pour water inside the TV through ventilation holes or other openings.

These items may cause a fire or an electric shock.

If these objects are inserted inside the TV, turn off the TV, remove the power plug from the outlet immediately and contact a service technician. Be especially careful that children do not insert objects in the TV.



Viewing teletext

Never stand or climb on the TV.

Be especially careful in households with children to prevent them from climbing on top of the TV.

It may move, fall over, break, become damaged or cause an injury.



Equipment connections

When the TV will not be used for a long period of time, such as during vacation or travel, remove the power plug from the wall outlet for safety.

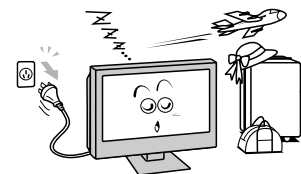

Reference section

Important Safety Instructions (continued)

Use (continued)

Never pull on the power cord when removing the plug from the wall outlet.

Always hold the plug firmly when removing it. If the power cord is yanked, the cord may become damaged and fire or electric shock may occur.

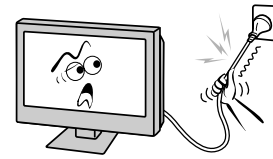

Never cut, break, modify, twist, bunch up or bend the power cord or apply excessive force or tension to it.

Never place heavy objects on the cord or allow it to overheat as this may cause damage, fire or electric shock. Contact a service technician if the power cord is damaged.

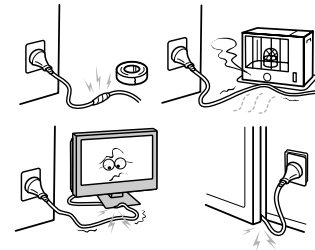

If there is thunder or lightning, never touch the aerial cable or other connected cables.

You may suffer an electric shock.

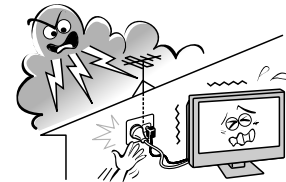

Service

Never repair, modify or disassemble the TV by yourself.

If it may cause a fire or an electric shock. Consult a service technician for inspection and repairs.

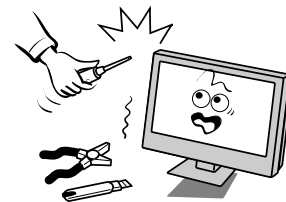

When a malfunction occurs, or if smoke or an unusual odor comes from the TV, turn off the TV and remove the power plug from the outlet immediately.

Make sure that the smoke or smell has stopped, then contact a service technician. If the TV is still used in this condition, it may cause a fire or an electric shock.

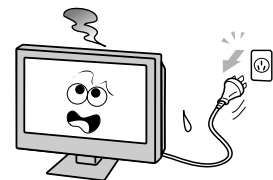

Important Safety Instructions (continued), Important information

Service (continued)

If the TV is dropped or the cabinet is broken, turn off the TV and remove the power plug from the outlet immediately.
If the TV is powered on in this condition, it may cause a fire or an electric shock or an injury. Contact a service technician for inspection.

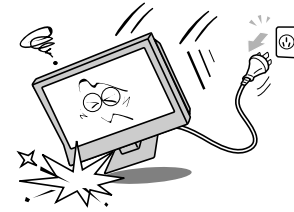

Cleaning

Always remove the power plug before cleaning.
Never use solvents such as benzine or thinner to clean the TV.
– These solvents may warp the cabinet or damage its finish.
– If rubber or vinyl products remain in contact with the TV for a long time, a stain may result.
If the cabinet becomes dirty, clean it with a soft, dry cloth.
When cleaning the surface of the LCD display, wipe the panel surface gently with a soft, dry cloth.

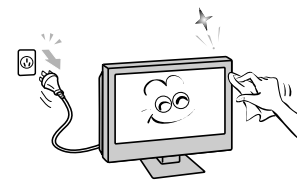

Periodically disconnect the power plug from the outlet and check it. If dust has collected on the power plug connectors, clean off the dust.
This dust may cause a fire due to reduced insulation on the plug.



Important information

Disposal...

Following information is only for EU-member states:
The use of the symbol indicates that this product may not be treated as household waste. By ensuring this product is disposed of correctly, you will help prevent potential negative consequences for the environment and human health, which could otherwise be caused by inappropriate waste handling of this product. For more detailed information about recycling of this product, please contact your local city office, your household waste disposal service or the shop where you purchased the product.



Important information (continued), Installation

Important information (continued)

About the LCD screen

- If you have the LCD screen facing to the sun, the LCD screen will be damaged. Be aware of locating the TV in the place such as window side or outside of the room.
- Do not press the LCD screen strongly or scratch it, and do not put anything on it. These actions will damage the LCD screen.

About the cabinet

Do not spray volatile compounds such as insecticide on the cabinet.
This may cause a discolouration or damage the cabinet.

Some pixels of the screen do not light up

The LCD display panel is manufactured using an extremely high level of precision technology, however sometimes some pixels of the screen may be missing picture elements or have luminous spots. This is not a sign of a malfunction.

About Interference

The LCD display may cause interference in image, sound, etc. of other electronic equipment that receives electromagnetic waves (e.g. AM radios and video equipment).

About using the TV in low-temperature conditions

If you use the TV in a room of 0°C or less, the picture brightness may vary until the LCD monitor warms up. This is not a sign of a malfunction.

About after-image

If a still picture is displayed, an after-image (ghost) may remain on the screen; however, it will disappear. This is not a sign of malfunction.

Connecting an aerial

Your new Toshiba television is designed to automatically tune in and store all available terrestrial transmissions and to allocate a satellite position.

The following describes the initial set-up procedure in order to operate the features of your TV.

Before connecting the aerial cable, remove the back terminal cover (see page 10).

Connect the aerial cable to the socket on the rear of the TV. If you use a satellite receiver and/or a VCR, it is essential that the aerial cable is connected through the satellite receiver and/or through the VCR to the TV.

DO NOT CONNECT SCART LEADS UNTIL THE TELEVISION IS FULLY TUNED IN.
(See page 29-31 for various equipment connections.)

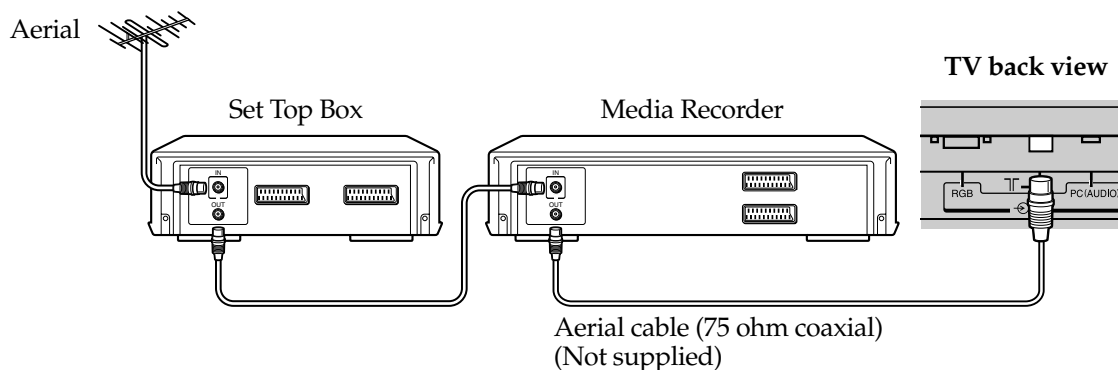

8

Exploring your new TV

- You can operate your TV using the buttons on the tops panel or remote control. The back and side panels provide the terminal connections to connect other equipment to your TV. See "Equipment connections" on pages 29 - 33.
- Model 20VL56 series is used in this manual for illustration purposes.

TV top/TV side

For the use of each control, see the pages in brackets.

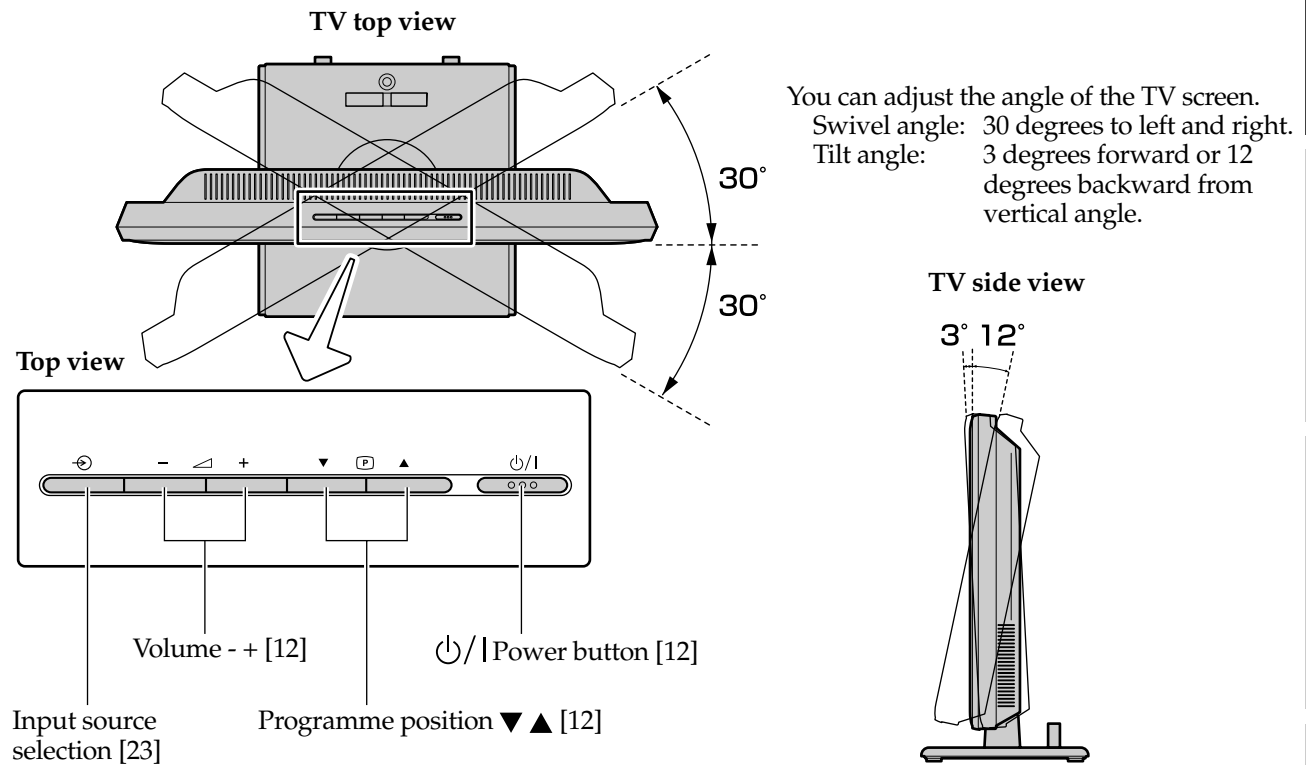

TV front

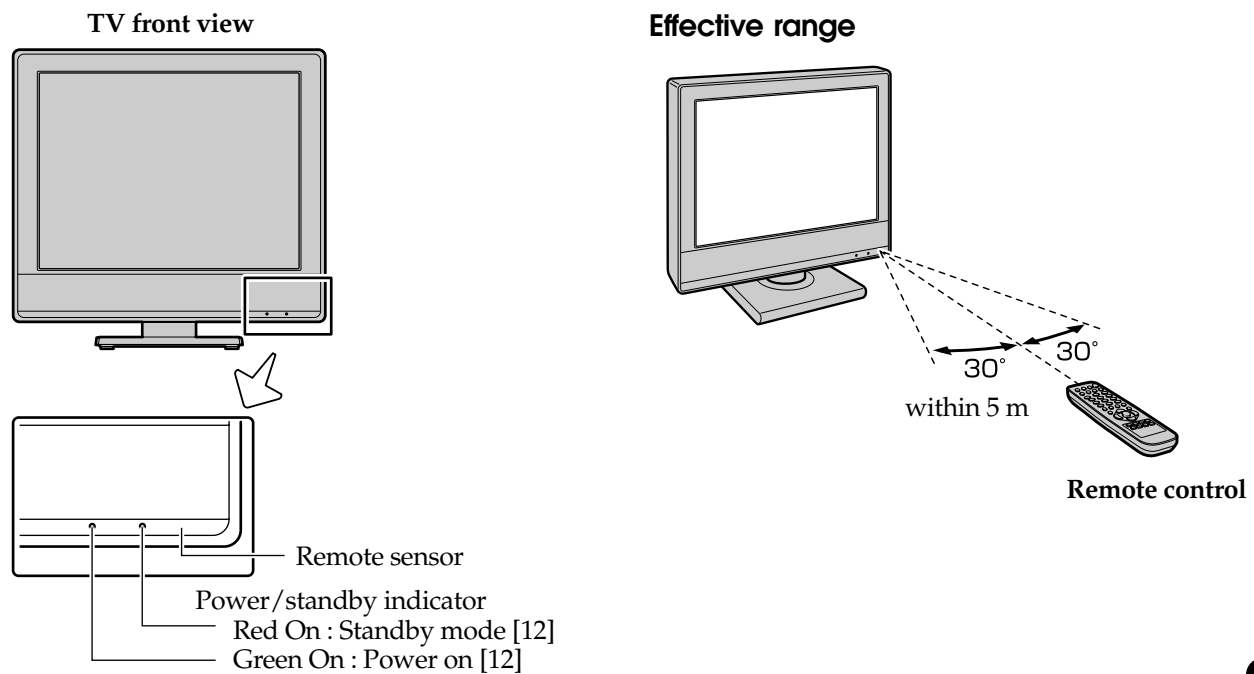

Exploring your new TV (continued)

TV back

Before connecting the aerial and audio/video cables, remove the terminal panel cover (see "Rear terminal cover" below).

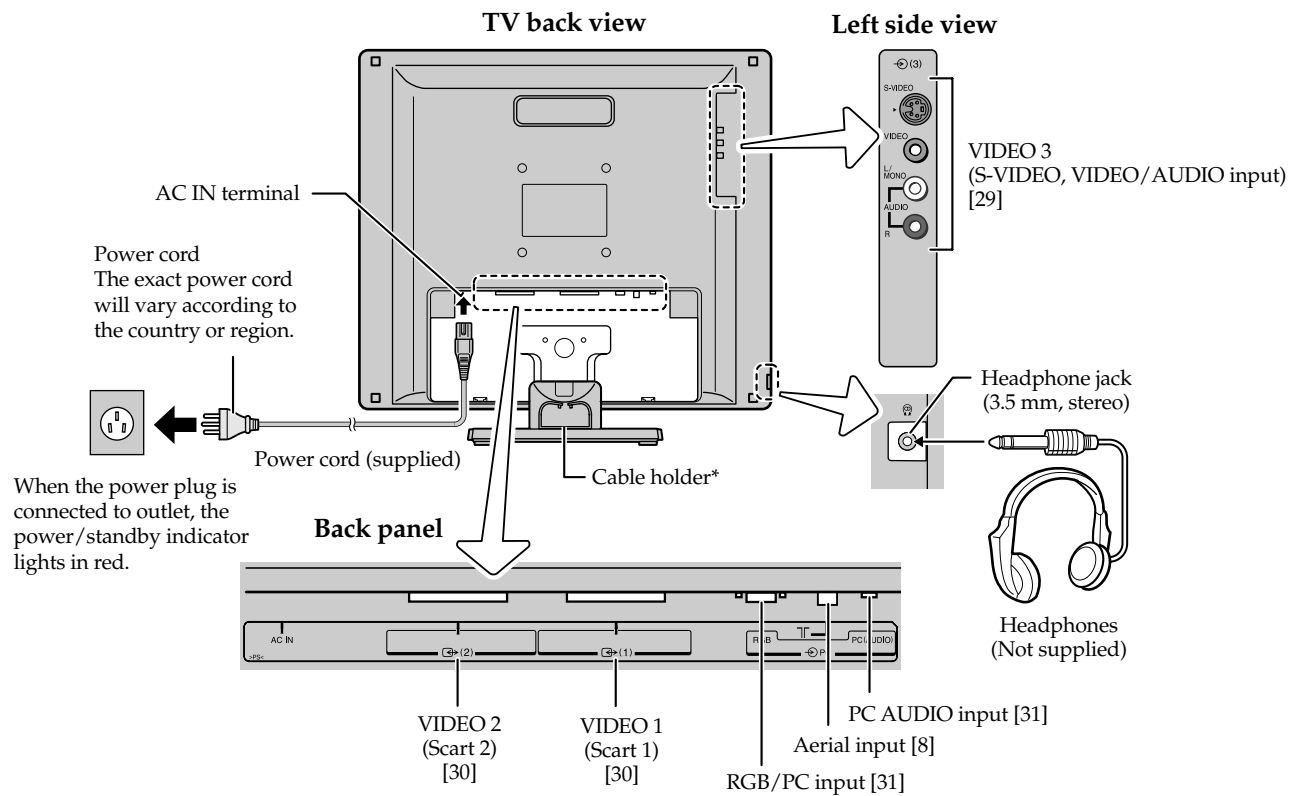

* You can use the cable holder to hold the aerial and audio/video cables. **Never use the cable holder to carry the TV when moving it.**

Note:

Inserting a headphone plug into the Headphone jack will mute the sound from all speakers and deliver normal stereo left and right sounds to the headphones.

Rear terminal cover

The connection panel is hidden behind the terminal cover.

1. To remove the cover, release the two catches on the bottom of the cover.
2. Connect cables as necessary.
3. To reinstall the cover, align the holes on the TV back with the three tabs on the rear terminal cover as shown and close the cover.

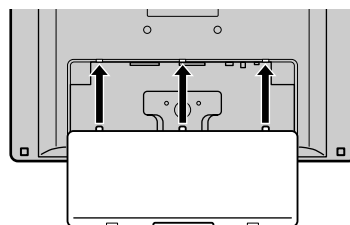
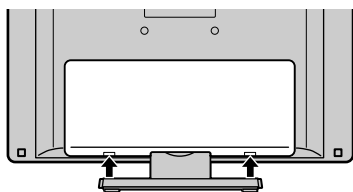

Learning about the remote control

Location of controls/Installing the remote control batteries

For the use of each control, see the pages in brackets.

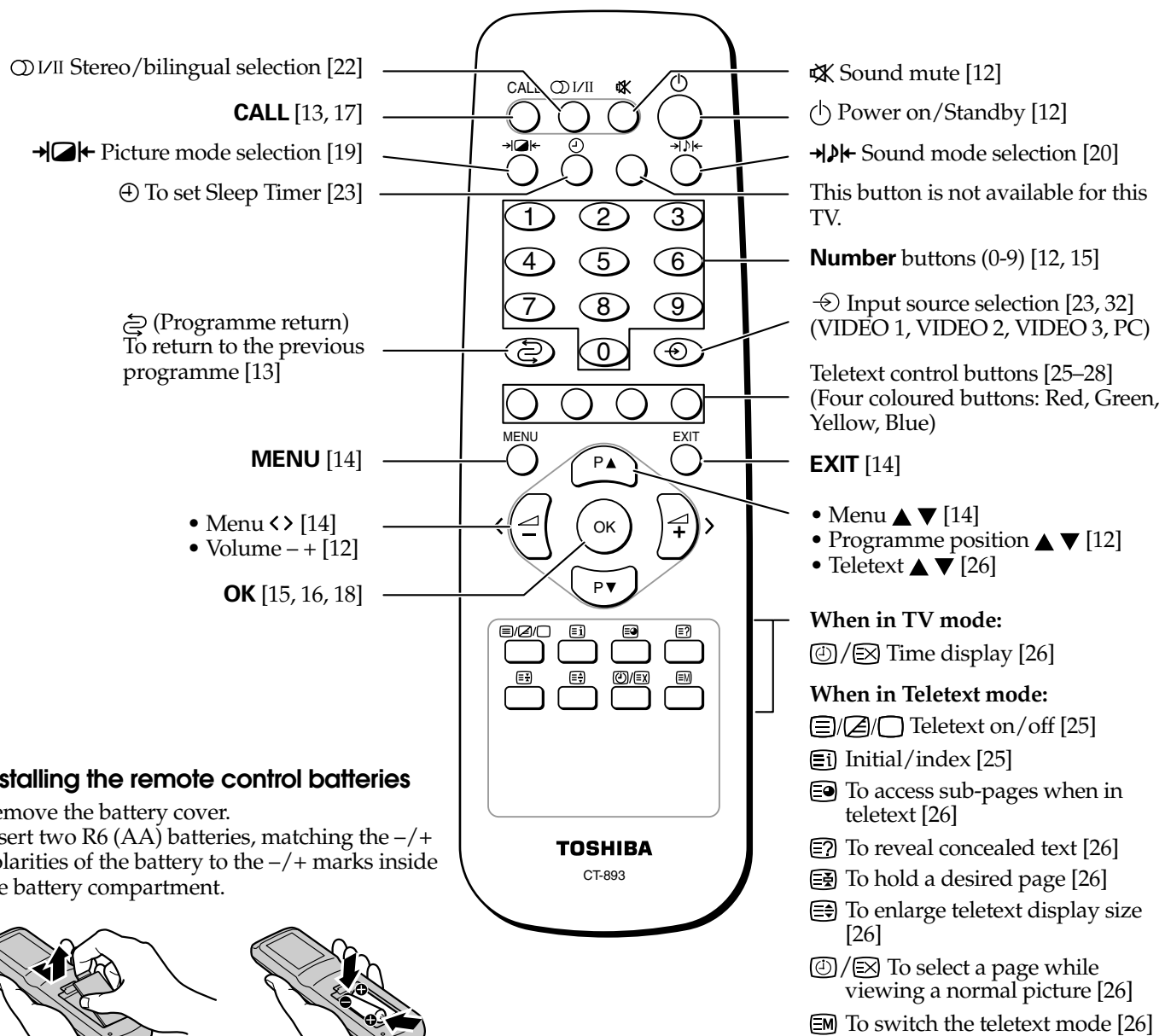

Installing the remote control batteries

Remove the battery cover.
Insert two R6 (AA) batteries, matching the -/+ polarities of the battery to the -/+ marks inside the battery compartment.

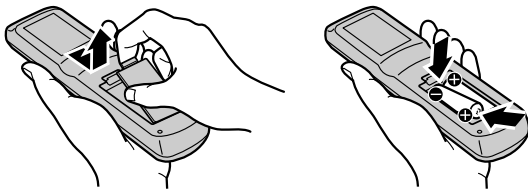

Cautions:

- Dispose of batteries in a designated disposal area. Do not throw batteries into a fire.
- Attention should be drawn to the environmental aspects of battery disposal.
- Do not mix battery types or combine a used battery with a new one.

Notes:

- If the remote control does not operate correctly, or if the operating range becomes reduced, replace both batteries with new ones.
- If the batteries are dead or if you will not use the remote control for a long time, remove the batteries to prevent battery acid from leaking into the battery compartment.

Watching TV programmes

Plug the power cord to a wall outlet.

Turning the TV on or off/Volume/Sound mute/Programme positions

TV top view

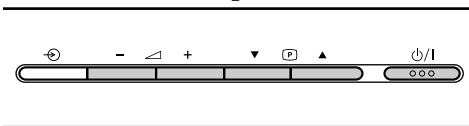

TV front view

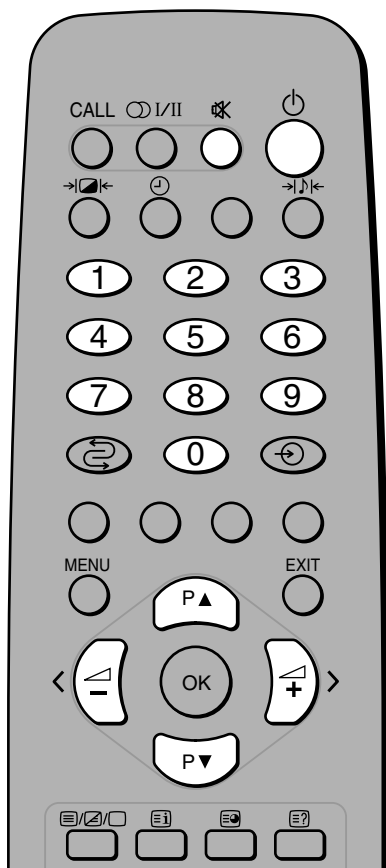
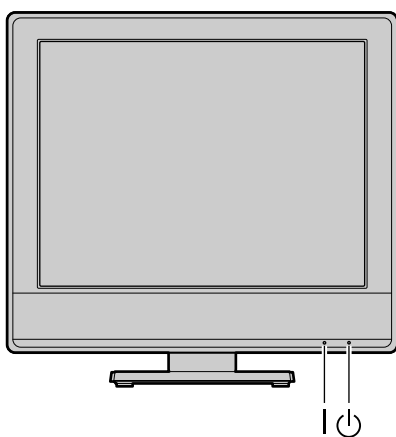

Switching on the TV:

Press the power button on the TV or press the button on the remote control.

The power on indicator lights in green.

Switching off the TV (standby mode):

Press the power button on the TV or press the button on the remote control.

The standby indicator lights in red.

Notes:

- When the TV is turned off but remains plugged into the electrical outlet, a minute amount of current is still consumed.
- When the TV will not be used for a long period of time, such as during a vacation or a travel, remove the power plug from the electrical outlet.
- When Auto off is set to On, the TV will automatically turn itself off after approximately 15 minutes if it is tuned to a vacant channel or one whose station has finished its broadcasts for the day (see page 24).
- If power is cut off while you are viewing the TV, the Last Mode Memory feature turns on the TV automatically when power is applied again. If power is going to be off for a long time and you are going to be away from your TV, unplug the power cord to prevent the TV from turning on in your absence.

To adjust the volume:

Press the + or - button to increase or decrease the volume.



To mute the sound:

1 Press the button. appears on the screen.

2 Press the button again to restore the sound.



To change programme position:

Enter the desired programme position number using the Number buttons on the remote control. You can also change the programme position by using the or button.



For programme positions below 10, use 0 and the required number (e.g., for programme position 1, press 0, 1). The position number will be displayed in the top right of the screen.

Watching TV programmes (continued), Learning about the menu system

Switching Programme return/On-screen information

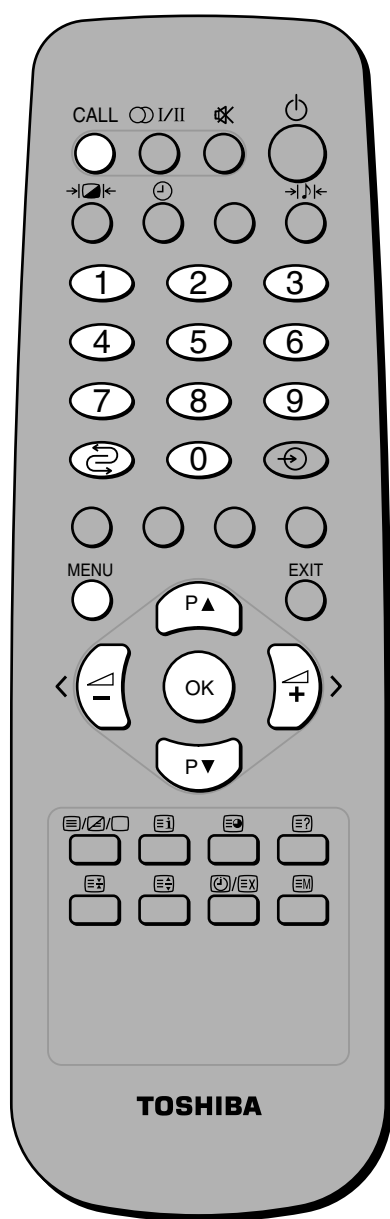

To switch between two programme positions:

You can switch between two programme positions without entering the actual position number each time.

- 1 Select the first programme position you want to view.
- 2 Select the second programme position using the **Number** buttons (0-9).
- 3 Press the  button. The previous channel will be displayed.

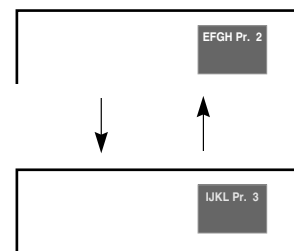

Each time you press the  button, the TV will switch back and forth between the two programme positions.

To display the on-screen information:

- Press the **CALL** button to display the following on-screen information. The information will disappear in 4 seconds.
 - Selected programme position or external input mode
 - Programme skip on information
 - Station name (if set)
 - Mono/Stereo/Dual audio status



Selecting a language

Choose from seventeen different languages for the on-screen display.

- 1 Press the **MENU** button, then press the < or > button to display the Setup menu.
- 2 Press the **OK** button, then the ▼ or ▲ button to select Language.



- 3 Press the **OK** button, then press the ▼ or ▲ button to select the desired language.

English, Deutsch, Français, Svenska, Norsk, Dansk, Suomi, Português, Romaneste, Polski, Magyar, Chesky, Русский, Slovensky



Learning about the menu system (continued)

To use the menu system:

Press the **MENU** button to open the menu system, then press the < or > button to select a main menu.

Press the **OK** button, then press the ▼ or ▲ button to select an item in the main menu.

Press the **OK** button, and then press the ▼ or ▲ button to select or adjust a setting in the item.

Press the **OK** button to display the next menu.

Menu overview

Picture menu

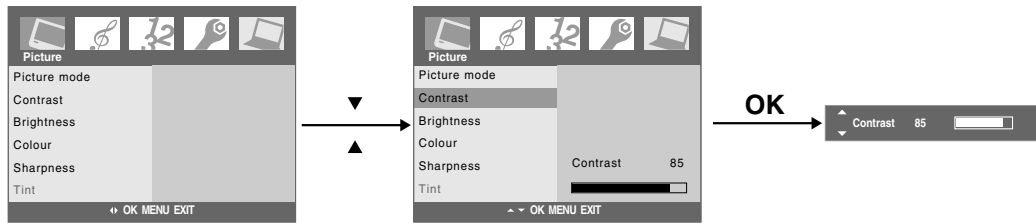

Sound menu

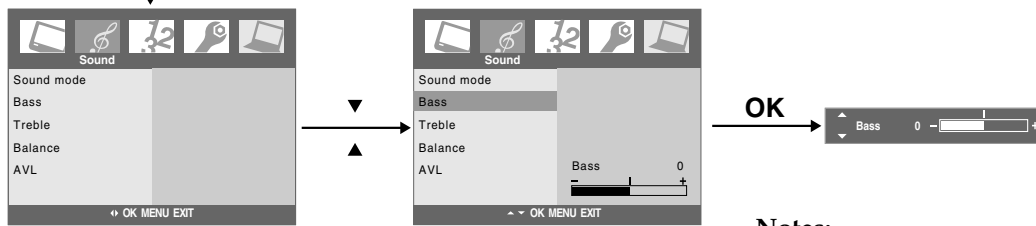

Channel menu

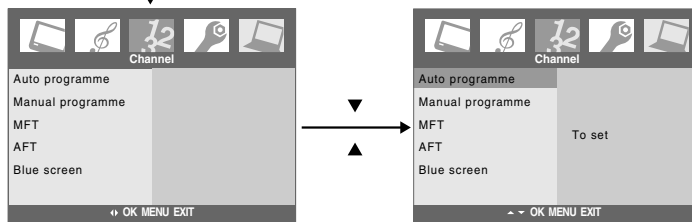

Setup menu



PC menu

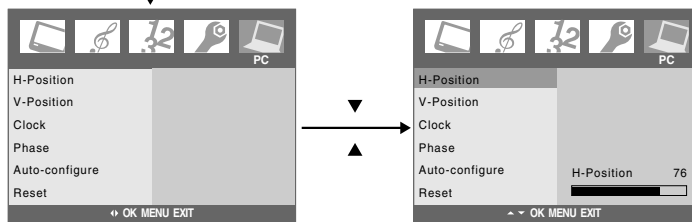

Notes:

- If you do not make a selection for a while, the menu display closes automatically.
- If you want to close the on-screen display instantly, press the **MENU** button.
- To return to the previous menu, press the **EXIT** button.
- In TV or video mode, the PC menu will not appear.
- In the NTSC signal mode, you can select Tint on the Picture menu (see page 19).

Programming channel memory

- First, use the Auto Programme function to preset all the active channels in your area automatically. Then, arrange the preset channels with the Manual Programme function so that you can tune into only desired channels.
- Up to 100 TV stations can be stored by programme numbers (0 to 99). Once you have preset the stations, you will be able to use the < or > buttons to scan the stations you have programmed. Stations can be tuned using automatic or manual modes.

System selection/Auto programme

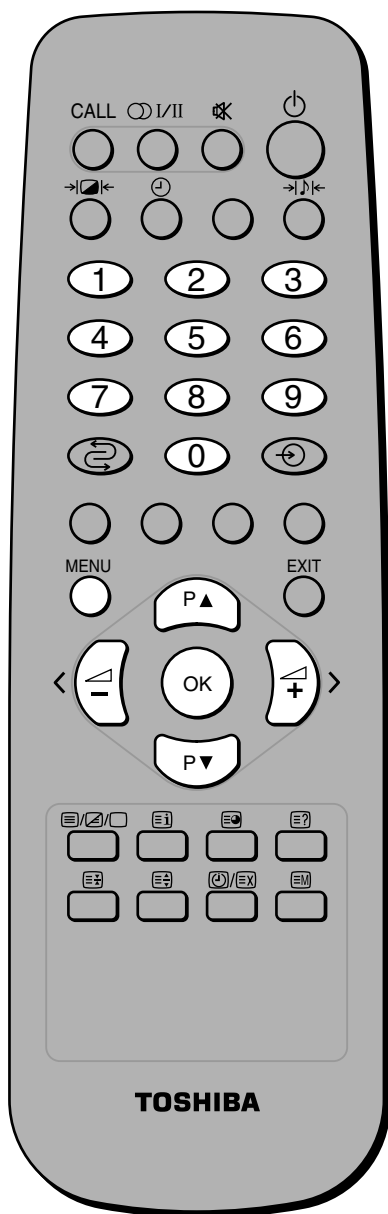

1 Press the **MENU** button, then press the < or > button to display the Channel menu.

2 Press the **OK** button, then press the ▼ or ▲ button to select Auto programme.

3 Press the **OK** button to display the Auto programme menu. Continue to set each item following the steps described below.



System:

1 Press the ▼ or ▲ button to select System, then press the **OK** button.

2 Select a TV system with the ▼ or ▲ button on the System menu;

B/G : PAL B/G, SECAM B/G (Europe/East Europe)

I : PAL I/II (U.K./Ireland)

D/K : PAL D/K, SECAM D/K (East Europe)

L : SECAM L/L' (France)

M : NTSC

3 Press the **OK** button.

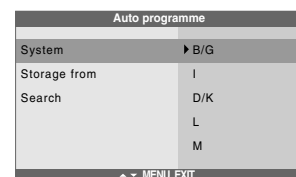

Storage from:

1 Press the ▼ or ▲ button to select Storage from, then press the **OK** button.

2 Select the beginning programme position with the < or > button or **Number** button. Any number under 10 is entered with a numeric "0" in front of it, i.e. "05" for 5.

3 Press the **OK** button.

Search:

1 Press the ▼ or ▲ button to select Search.

2 Press the **OK** button to begin auto programming.

All receivable stations are stored.

To stop auto programming, press the **MENU** button.

3 When auto programming is completed, the Channel menu appears on the screen automatically.

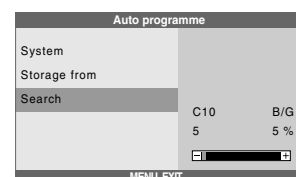

Programming channel memory (continued)

Manual programme

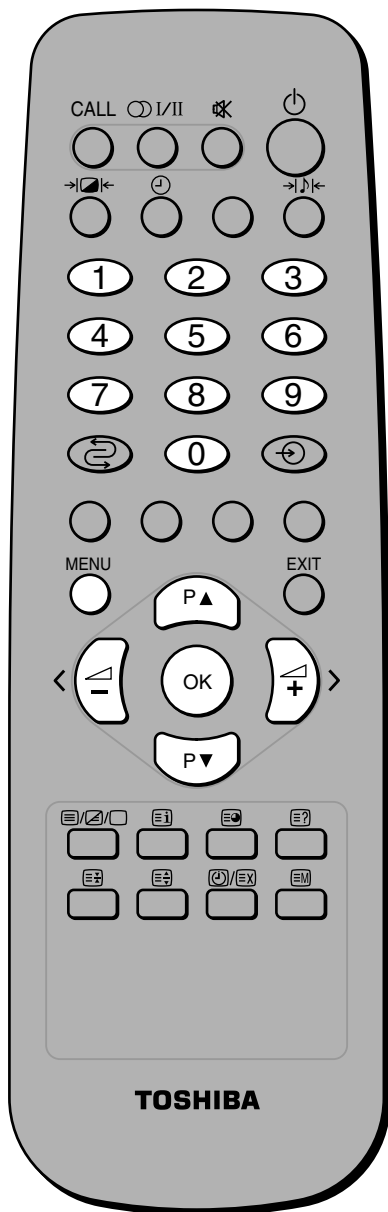

- 1 Select the programme position you want to arrange by using the **P▲** or **P▼** button or Number buttons.
- 2 Press the **MENU** button, then press the **<** or **>** button to display the Channel menu.
- 3 Press the **OK** button, then press the **▼** or **▲** button to select Manual programme.
 
- 4 Press the **OK** button to display the Manual programme menu. Continue to set each item following the steps described below.

Storage (Storing channel):

With this function, a specific channel can be stored to another programme position of your choice.

- 1 Press the **▼** or **▲** button to select Storage, then press the **OK** button.
- 2 Select the desired programme number (0 to 99) with the **<** or **>** button or **Number** buttons on the Storage menu.
- 3 Press the **OK** button.

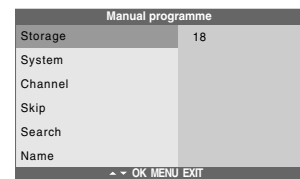

System (Selecting the Colour system):

- 1 Press the **▼** or **▲** button to select System, then press the **OK** button.
- 2 Select a TV system with the **▼** or **▲** button on the System menu;
 - B/G : PAL B/G, SECAM B/G (Europe/East Europe)
 - I : PAL I/II (U.K./Ireland)
 - D/K : PAL D/K, SECAM D/K (East Europe)
 - L : SECAM L/L' (France)
 - M : NTSC
- 3 Press the **OK** button.

Channel (Selecting channel):

- 1 Press the **▼** or **▲** button to select Channel, then press the **OK** button.
- 2 Press the **▼** or **▲** button to select VHF/UHF or Cable on the Channel menu. If possible, select the channel number directly with the **Number** buttons.
- 3 Press the **OK** button.

Manual programme (continued)

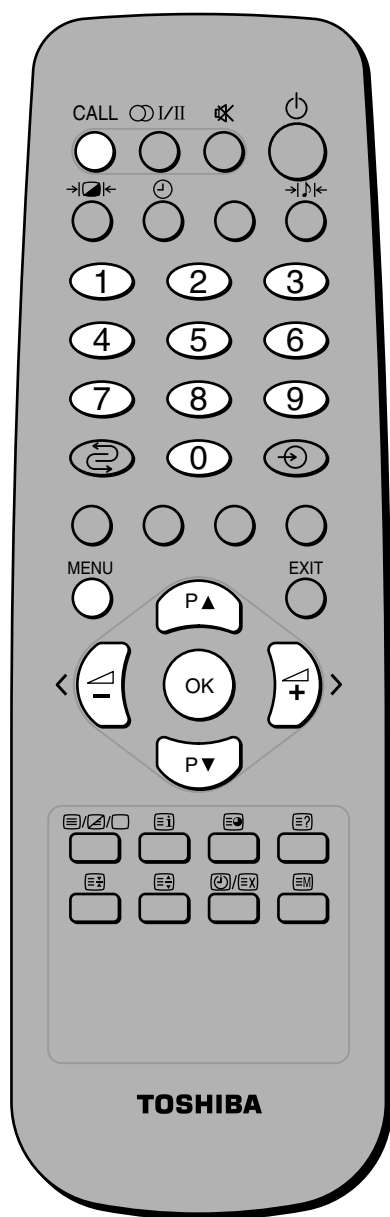

Skip (Skipping a programme position):

- 1 Press the ▼ or ▲ button to select Skip, then press the **OK** button.
- 2 Press the ▼ or ▲ button to turn the programme position's skip option On or Off. The programme position will then be skipped when you select channels with the **P▲** or **P▼** button. The "↔" mark will appear beside a programme position number when you use the **Number** button.
- 3 Press the **OK** button.

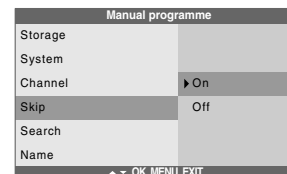

Search (Searching for a channel):

- 1 Press the ▼ or ▲ button to select Search, then press the **OK** button.
- 2 Press the < or > button to begin searching. If a station is found, the search will stop.
- 3 Press the **OK** button.

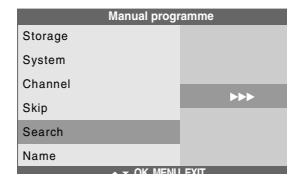

When a station/satellite is found, it will be displayed.

Name:

Station names appear with the programme position display each time you turn on the TV, select a channel, or press the **CALL** button.

To change or create station labels:

- 1 Press the ▼ or ▲ button to select Name, then press the **OK** button.
- 2 Press the ▼ or ▲ button repeatedly to select a character for the first space, then press the > button.

A ↔ Z ↔ a ↔ z ↔ ◻ ↔ - ↔ + ↔ 0 ↔ 9

*(blank space)
- 3 Repeat step 2 to enter the rest of the characters. If you would like a blank space in the label name, you must choose a blank space from the list of characters.
- 4 Press the **OK** button.

Programming channel memory (continued)

MFT/AFT

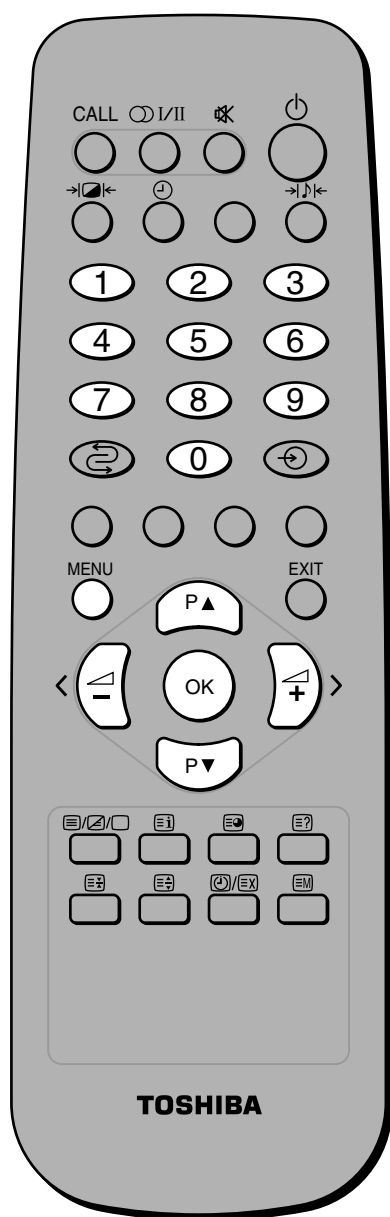

MFT (Manual Fine Tuning):

The adjustments below are not necessary under normal receiving conditions. However, in areas of inferior broadcast conditions where adjustment is necessary for a better picture, perform the MFT function.

- 1 Select the programme position you want to fine-tune with the **P▲** or **P▼** button or **Number** buttons.
- 2 Press the **MENU** button, then press the **<** or **>** button to display the Channel menu.
- 3 Press the **OK** button, then press the **▼** or **▲** button to select MFT.
- 4 Press the **OK** button, then press the **<** or **>** button to obtain better picture and sound.



AFT (Automatic Fine Tuning):

The AFT function automatically corrects slight fluctuations when receiving signals.

- 1 Select the programme position you want to fine-tune with the **P▲** or **P▼** button or **Number** buttons.
- 2 Press the **MENU** button, then press the **<** or **>** button to display the Channel menu.
- 3 Press the **OK** button, then press the **▼** or **▲** button to select AFT.
- 4 Press the **OK** button, then press the **▼** or **▲** button to select On.

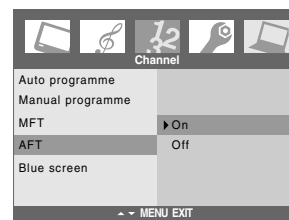

Note:
When operating the MFT function, the AFT status is automatically set to Off.

Picture quality adjustment

Picture quality adjustment

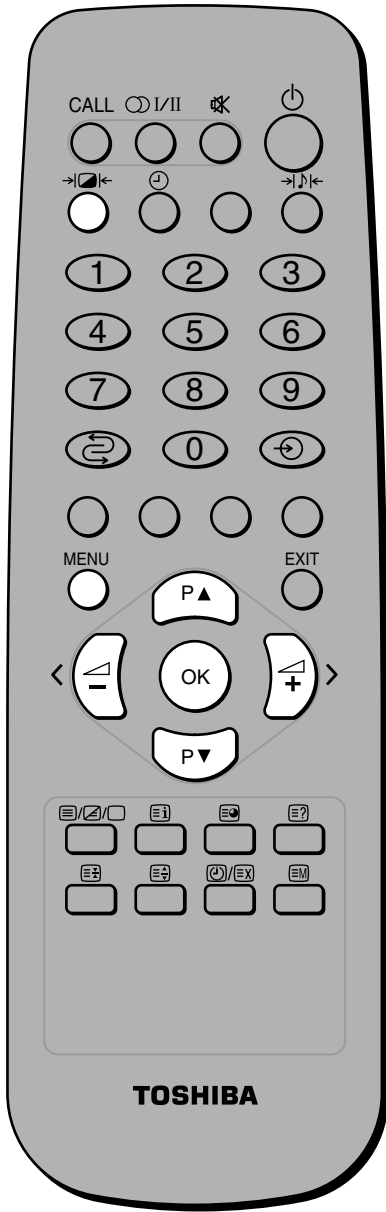

Note:
To continue adjusting the other picture qualities, press the ▼ or ▲ button in step 3.

To select the picture mode using the remote control:
You can select the picture quality instantly among three preset modes and one user-set mode.

- Repeatedly press the button to select one of the following picture qualities:

Dynamic, Standard, Movie and Memory (user-set).



Mode	Picture quality
Dynamic	bright and dynamic picture
Standard	standard picture
Movie	softer picture suitable for viewing movies
Memory	the picture qualities you set

To select the picture mode through the Picture menu:

- Press the **MENU** button, then press the < or > button to display the Picture menu.
- Press the **OK** button, then press the ▼ or ▲ button to select Picture mode.
- Press the **OK** button, then press the ▼ or ▲ button to select the mode you prefer.

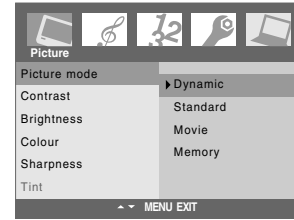

To adjust the picture quality:

The adjusted level is stored in the picture Memory.

- Press the **MENU** button, then press the < or > button to display the Picture menu.
- Press the **OK** button, then press the ▼ or ▲ button to select Contrast, Brightness, Colour, Sharpness or Tint.
- Press the **OK** button, then press the < or > button to adjust the level.

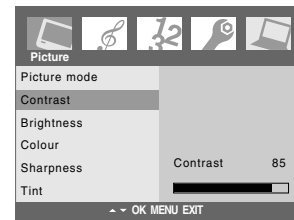

Selection	< Pressing >	
Contrast	lower	higher
Brightness	darker	lighter
Colour	paler	deeper
Sharpness	softer	sharper
Tint*	reddish	greenish

* for NTSC system only

Sound adjustment

Sound quality adjustment

Basic operation

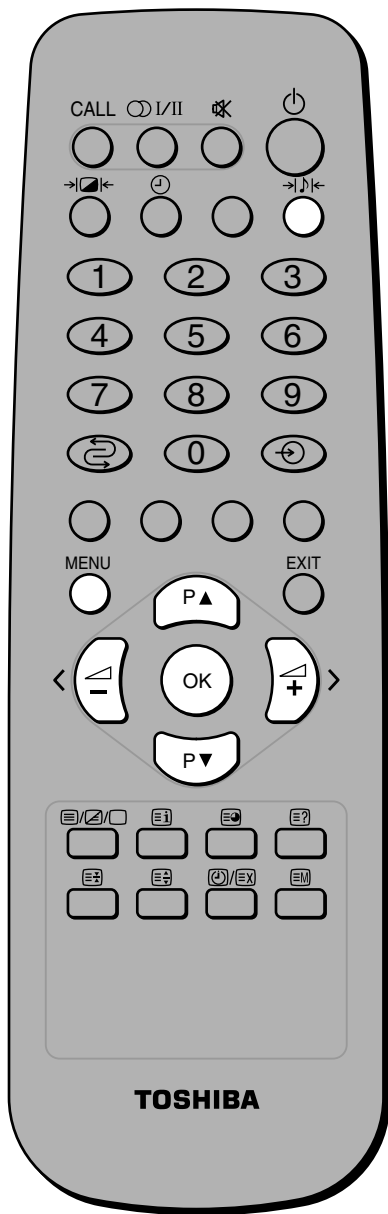

Note:
To continue adjusting the other sound qualities, press the ▼ or ▲ button in step 3.

To select the sound mode using the remote control:

You can select the sound quality instantly among five preset modes and one user-set mode.

- Repeatedly press the button to select one of the following sound qualities:

WOW, Flat, Hall, Theater, News and Memory (user-set).



Mode	Sound quality
WOW	see page 21
Flat	flat sound
Hall	a concert hall filled with a rich, warm sound
Theater	a movie theater filled with a dynamic sound
News	news/dialogue
Memory	the sound qualities you set

To select the sound mode through the Sound menu:

- Press the **MENU** button, then press the < or > button to display the Sound menu.
- Press the **OK** button, then press the ▼ or ▲ button to select Sound mode.
- Press the **OK** button, then press the ▼ or ▲ button to select the mode you prefer.

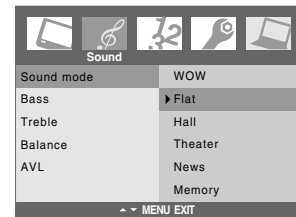

To adjust the sound quality:

The adjusted level is stored in the sound Memory.

- Press the **MENU** button, then press the < or > button to display the Sound menu.
- Press the **OK** button, then press the ▼ or ▲ button to select Bass, Treble or Balance.
- Press the **OK** button, then press the < or > button to adjust the level.

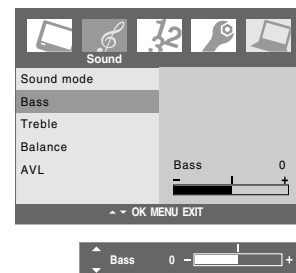

Selection	Pressing	
	<	>
Bass	weaker	stronger
Treble	weaker	stronger
Balance	decreases the right channel	decreases the left channel

WOW surround setting

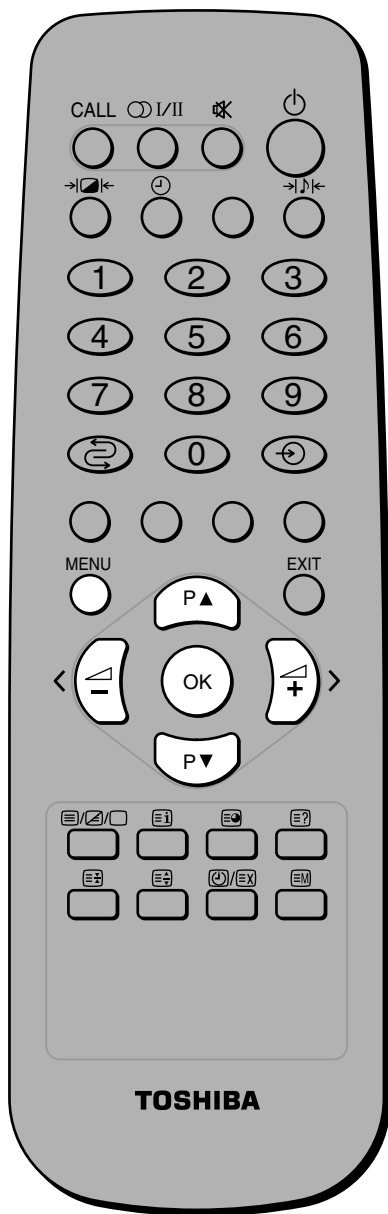

Notes:

- If the broadcast is monaural, the WOW effect does not work.
- WOW, SRS and  symbol are trademarks of SRS Labs, Inc.
- WOW technology is incorporated under license from SRS Labs, Inc.

To turn on the WOW surround:

WOW widens and deepens the audio listening field to deliver exceptional sound from the TV's speakers. The function uses stereo signals from a TV broadcast or video input.

- 1 Press the **MENU** button, then press the < or > button to display the Sound menu.
- 2 Press the **OK** button, then press the ▼ or ▲ button to select Sound mode.
- 3 Press the **OK** button, then press the ▼ or ▲ button to select WOW.

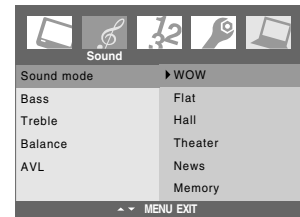

Using the AVL function (Auto Volume Leveler)

AVL maintains an equal volume level automatically, even if the channel is changed.

To activate the AVL:

- 1 Press the **MENU** button, then press the < or > button to display the Sound menu.
- 2 Press the **OK** button, then press the ▼ or ▲ button to select AVL.
- 3 Press the **OK** button, then press the ▼ or ▲ button to select On.

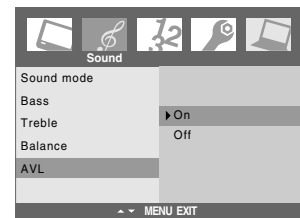

To deactivate the AVL:

Select Off in step 3 above.

Sound adjustment (continued)

Stereo/Bilingual selection

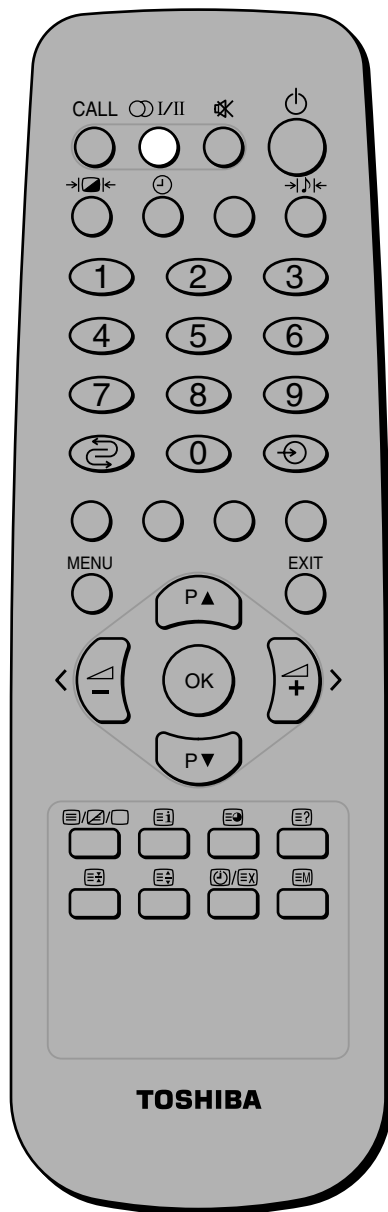

To select sounds in stereo programmes:

- 1 When a stereo programme is received, \odot STEREO appears.
- 2 Repeatedly press the \odot /I/II button to toggle between stereo and monaural modes.



Display	Reception mode
\odot STEREO	Stereo
∇ MONO	Monaural

To select different bilingual programmes:

- 1 When a bilingual programme is received, DUAL I appears.
- 2 Repeatedly press the \odot /I/II button to select the sound to be heard. The sound differs according to the transmission system: NICAM or German stereo/bilingual broadcast. You can toggle among DUAL I, DUAL II and DUAL I/II modes.



Display	Sound to be heard	
	NICAM	German stereo/ bilingual broadcast
DUAL I	Sub I sound	Main sound
DUAL II	Sub II sound	Sub sound
DUAL I/II	Sub I + Sub II sound	Main and Sub sound
∇ MONO	Main sound	-

Note:

These settings are not stored in the TV memory.

Panel lock, Input selection, Sleep Timer

Panel lock

TV top view

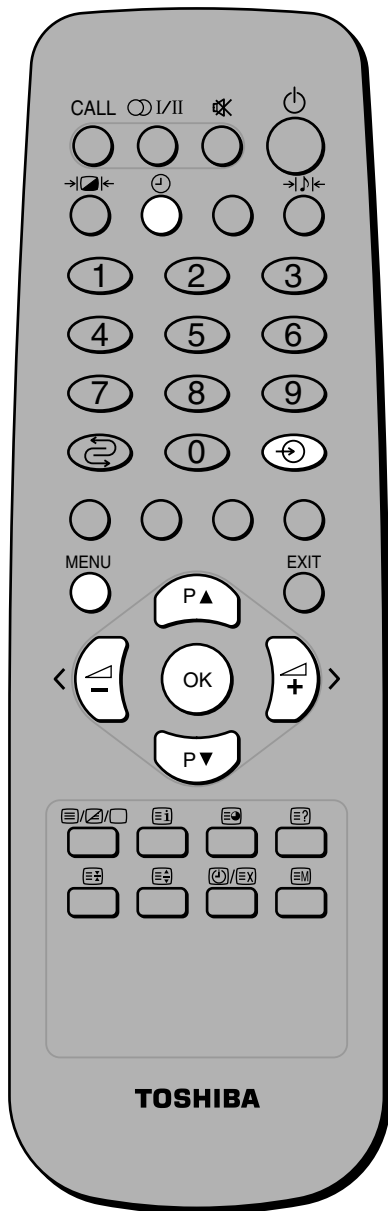
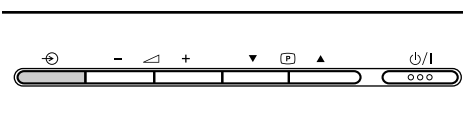

Panel lock allows you to disable the buttons on the top of the TV. You can still use all of the buttons on the remote control.

To set the Panel lock on:

- 1 Press the **MENU** button, then press the < or > button to display the Setup menu.
- 2 Press the **OK** button, then press the ▼ or ▲ button to select Panel lock.
- 3 Press the **OK** button, then press the ▼ or ▲ button to select On.

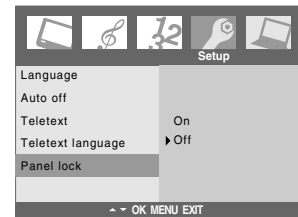

If Panel lock feature is set to On, the top panel buttons on the TV except for the ⏻/⏻ Power button are disabled. If a button is pressed, the word "Panel lock on" will appear.

Input selection

To select the input source:

Repeatedly press the ⏻ button on the TV or the remote control until you see the appropriate input indicator on the screen:

VIDEO 1 (↶ (1), VIDEO 1 input),
 VIDEO 2 (↷ (2), VIDEO 2 input),
 VIDEO 3 (↸ (3), VIDEO 3 input),
 PC (Ⓜ RGB/PC, PC input)

Note:

If no PC input signal is present, the PC menu will not appear.



Sleep Timer

To set the Sleep Timer:

You don't have to remember to switch the TV off before you go to sleep. The Sleep timer automatically switches the TV to standby after the preset time has elapsed.

Repeatedly press the ⏻ button to select the period of time. "⌚ 30" will appear on the screen, followed by, 60, 90, 120 and Off.

The timer begins to count down from the period of minutes selected.

Notes:

- To view the remaining preset time, press the ⏻ button once.
- To cancel the Sleep timer, repeatedly press the ⏻ button until the display "⌚ Off" appears.
- When you switch the TV off, the preset Sleep timer is cancelled.

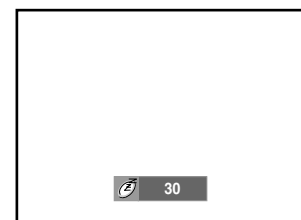

Blue screen function, Activating the Auto off function

Blue screen function

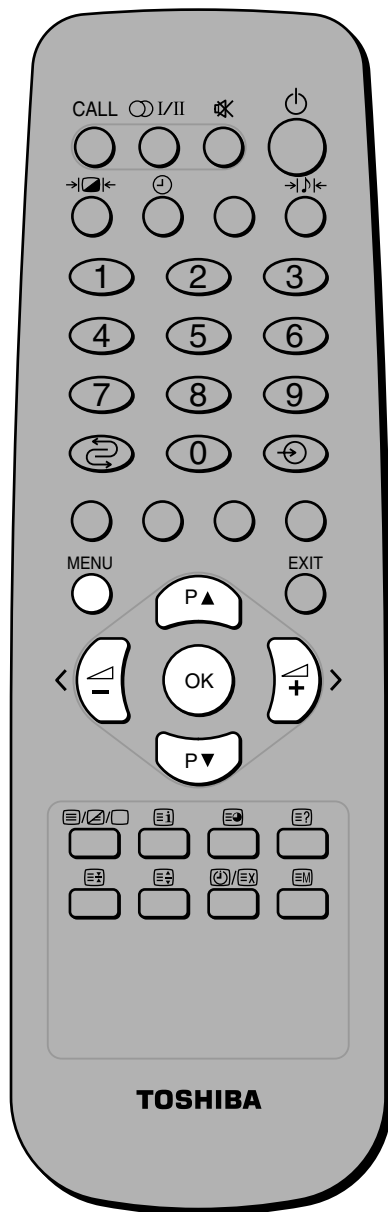

Using the TV's features

With the Blue screen function On, if the TV does not receive a signal, the screen will automatically turn blue and the sound will be muted.

To turn on the Blue screen:

- 1 Press the **MENU** button, then press the < or > button to display the Channel menu.
- 2 Press the **OK** button, then press the ▼ or ▲ button to select Blue screen.
- 3 Press the **OK** button, then press the ▼ or ▲ button to select On.

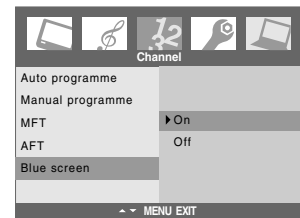

Notes:

- If the Blue screen function does not operate properly due to unstable signal strength or frequency, select Off in step 3.
- In the PC input mode, the blue screen function is not available.

Activating the Auto off function

With the Auto off function On, the TV automatically turns off if no signal is received for approximately 15 minutes.

- 1 Press the **MENU** button, then press the < or > button to display the Setup menu.
- 2 Press the **OK** button, then press the ▼ or ▲ button to select Auto off.
- 3 Press the **OK** button, then press the ▼ or ▲ button to select On.

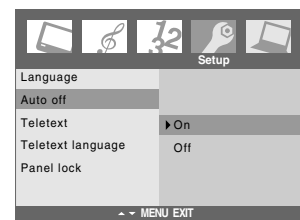

To turn off the Blue screen or the Auto off function:
Select Off in step 3 of each instruction above.

Teletext - Control buttons

- The TV is capable of showing both normal text and the text information selected by Auto mode and List mode.
- The Teletext buttons on the remote control have the same function for both text information types.
- The teletext language option enables the display of different language when using Teletext.

To view normal text

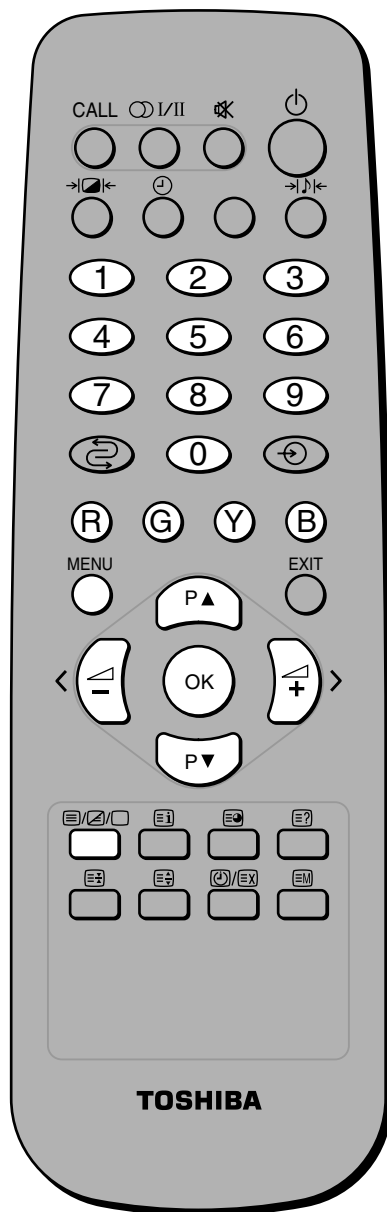

Note:
It will not be possible to change programme position while in Teletext mode. You will have to cancel the teletext first by pressing the button to return to a normal TV mode.

To select a language for Teletext:

- 1 Press the **MENU** button, and then press the < or > button to display the Setup menu.
- 2 Press the **OK** button, then press the ▼ or ▲ button to select Teletext language.
- 3 Press the **OK** button, then press the ▼ or ▲ button to select the required language.

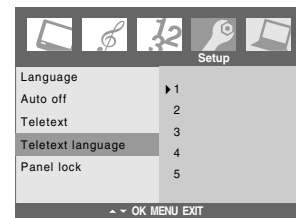

- Language 1: English, French, Scandian, Turkish, German, Spanish, Italian, Greek
- Language 2: Polish, French, Scandian, Czech, German, Serbian, Italian, Romanian
- Language 3: English, Russian, Estonian, Czech, German, Ukrainian, Lettish
- Language 4: English, French, Arabic, Hebrew
- Language 5: English, French, Turkish, Farsi

To display a page of text (/ /):

- 1 Select a desired TV station with a text service. Press the button to display the index page.
- 2 Enter the 3-digit page number using the **Number** buttons (0 - 9). **Ex.** Page 100: Press 1, 0 and 0.
- 3 Press the button again to superimpose the teletext over a normal broadcast picture.
- 4 Press the button again to return to normal TV mode.

Teletext buttons on the remote control

/ / To display a page of teletext:

Press the button to display teletext. Press again to superimpose the teletext over a normal broadcast picture. Press the button again to return to normal TV mode. You need to return to normal viewing if you wish to change channels.

When you first press the button to access the text service, the first page you see will be the initial page.

In **Auto** mode, this displays the main subjects available and their relevant page numbers.

In **List** mode, you will see whichever page number is currently stored on **each coloured** button.

Teletext - Control buttons (continued)

Teletext buttons on the remote control (continued)

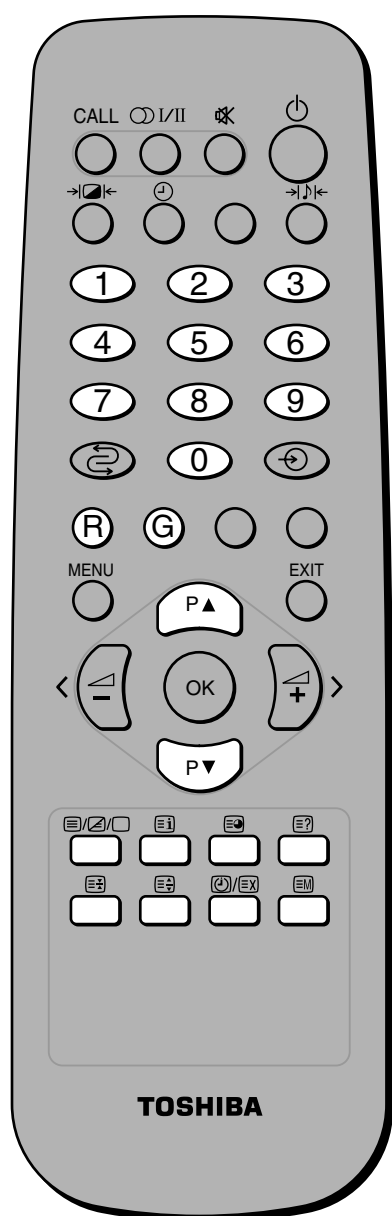

Viewing teletext

To display an index/initial page:

In Auto-mode

Press the  button to display the index page of a particular broadcaster.

In List-mode

Press the  button to return to your page currently stored on each coloured button.

To reveal concealed text:

Some pages cover topics such as quizzes and jokes. To discover the solutions, press the  button.



To hold a desired page:

When a page is divided into sub pages, it is convenient to hold it. Press the  button to hold the page. "EH" will appear in the top left of the screen. Press again to release the hold mode.

To enlarge the teletext display size:

Press the  button once to enlarge the top half of the page. Press again to enlarge the bottom half of the page. With the third press of the button, the page will return to normal size.

To select a page while viewing a normal picture:

When in teletext mode, if a page selection is made and then the  button is pressed, a normal picture will be displayed. The TV will indicate when the page is present by displaying the number of the text page at the top of the screen. Press the  button to view the page.

To switch the teletext mode:

When in teletext mode, press the  button to switch between List mode and another mode.

To select the time display (with the Teletext service only):

If you press the  button while watching a normal TV broadcast, you will see a time display from the broadcaster.



To erase the display, press the  button again.

9:56 and 25 seconds p.m.

21:56:25

Sub-pages:

If there are sub-pages, you can access the sub-pages by using the  button.

Press the  button to select a sub-page number. The sub-page number is displayed at the bottom of the screen. To change the sub-page, press the **R**, **G**, **▲**, **▼** or **Number** buttons. Press the  button again to exit this function.

Teletext - Auto and List modes

Auto mode

Auto mode is a method of viewing Teletext pages by related subjects grouped by the broadcast station. You can access any given topic shown on the screen simply by pressing the corresponding coloured text select button on the remote control.

Using Auto mode

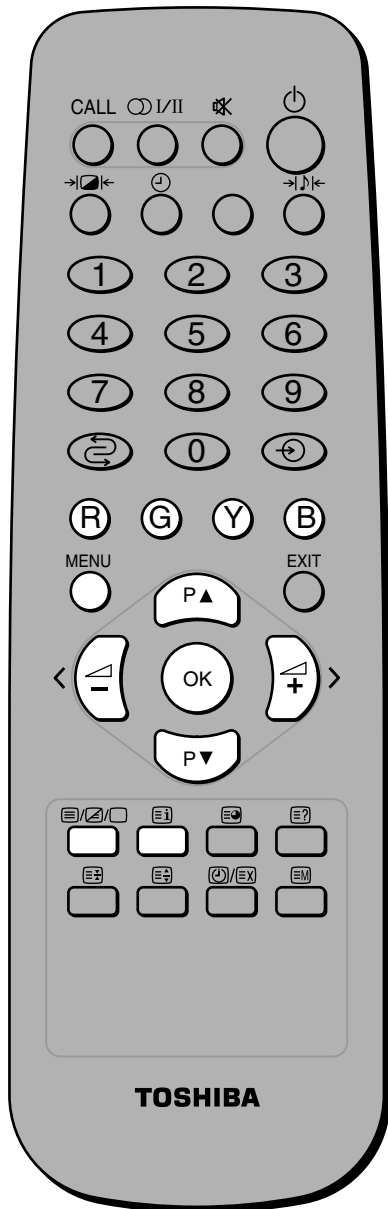

To select the Auto mode (Fastext mode):

When you select the Auto mode, four coloured prompts appear at the bottom of the screen. The colours correspond to those of the text select buttons on the remote control. Press the corresponding coloured button to go to the desired topic page instantly.

- 1 Select a TV channel with the desired FASTEXT service.
- 2 Press the **MENU** button, then press the < or > button to display the Setup menu.
- 3 Press the **OK** button, then press the ▼ or ▲ button to select Teletext.
- 4 Press the **OK** button, then press the ▼ or ▲ button to select Auto (Fastext mode).

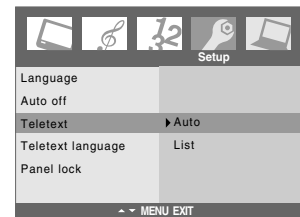

To view Fastext:

- 1 Press the button to select the text mode. Four coloured prompts will appear at the bottom of the screen.
- 2 Press the coloured button that corresponds to your desired topic. The display will switch to the selected page.
- 3 Repeat step 2 to switch to the next topic you want to view.

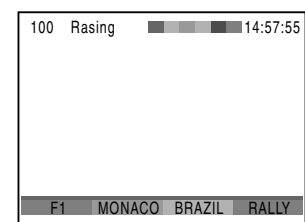
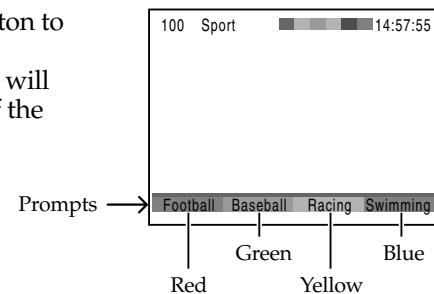

To return to the normal TV mode:

Press the button twice.
Press the button to display an index page.

Teletext - Auto and List modes (continued)

List mode

You can preset up to four of the most frequently used text pages to select these pages easily.

Using List mode

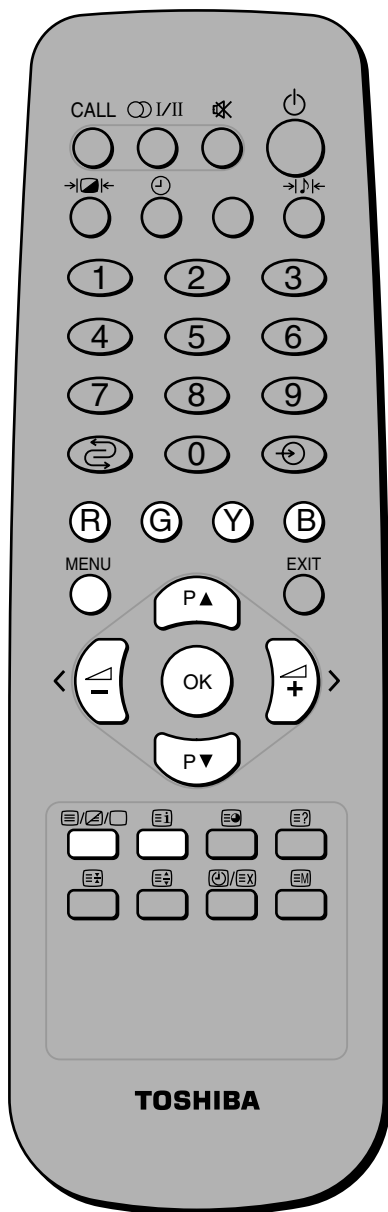

Viewing teletext

To select the List mode:

- 1 Press the **MENU** button, then press the < or > button to display the Setup menu.
- 2 Press the **OK** button, then press the ▼ or ▲ button to select Teletext.
- 3 Press the **OK** button, then press the ▼ or ▲ button to select List (List mode).
- 4 Select a TV channel with the normal text service.

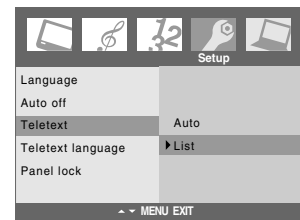

To preset desired pages:

- 1 Press the button to select the text mode.
- 2 Press the **R** button to select the red page.
- 3 Press the **Number** buttons to enter the 3-digit page number that you want to preset the red page.
Ex. page 120 : Press 1, 2 and 0.
The preset page is displayed on the screen.
- 4 Press the **OK** button to store your choice.
- 5 Repeat steps 2 - 4 to preset the other three pages using the **G**, **Y**, and **B** buttons.

EX. Factory presetting

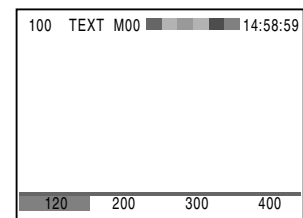
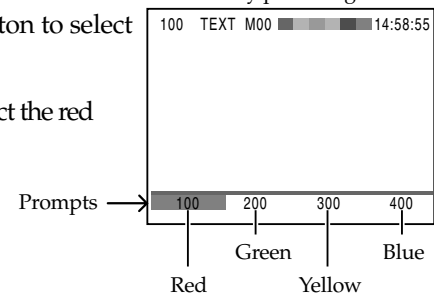

To display a desired page:

Press the desired coloured button according to the four coloured prompts on the screen.

To display an initial page:

Press the button.

Side panel connections

- You can connect one of a wide variety of auxiliary equipments via the inputs located on the TV's side panel.
- The side panel connections are referred to as "VIDEO 3."

Connection example

Always refer to the owner's manual of the equipment for full details of its connection.

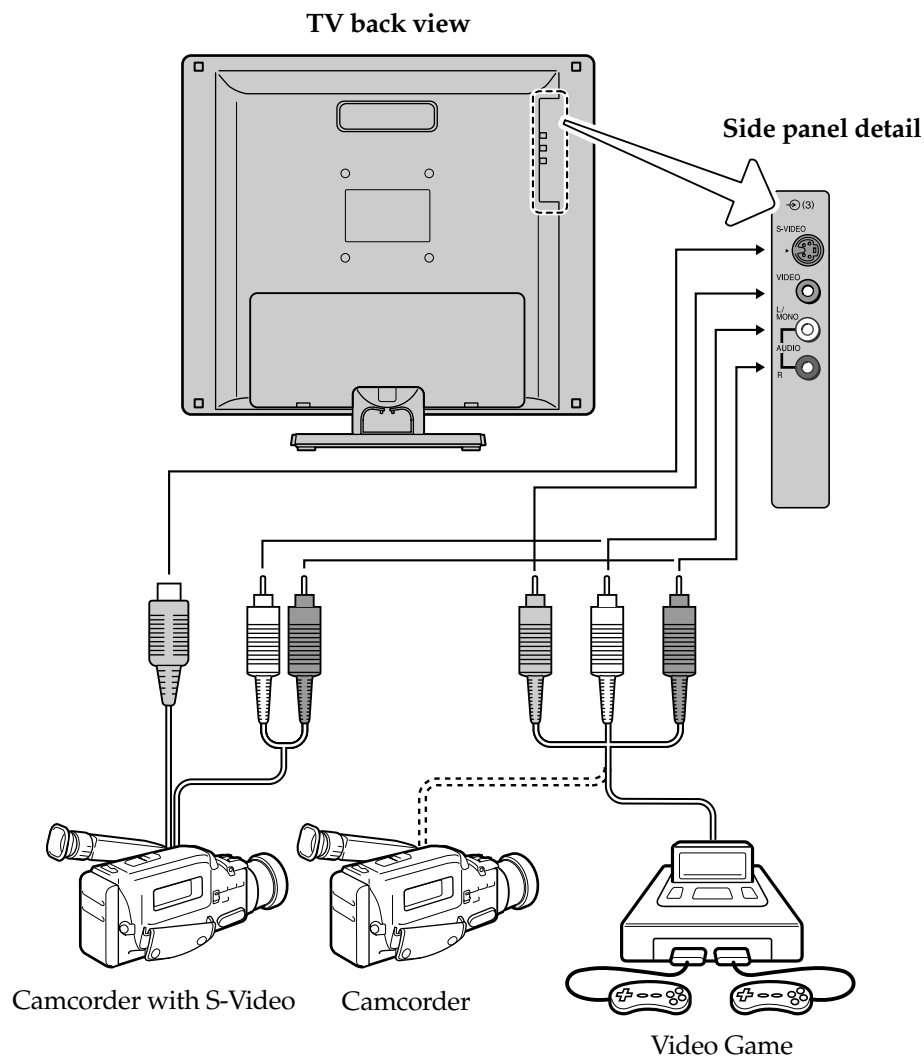

- To select the side input, press the button repeatedly to select VIDEO 3 (see page 23).
- Never plug in any power cords until you have finished connecting all equipments.
- Connect either the S-VIDEO input terminal or VIDEO input terminal, whichever terminal is used. Do not connect to both of these terminals at the same time.
- When connecting a mono sound equipment to VIDEO 3, connect the audio output of the equipment to the L/MONO jack on the TV.
- You can enjoy video games with this TV; however, games that involve shooting at a target on the TV screen with a light gun may not work because of the LCD colour TV properties.

Back panel connections

Connection example

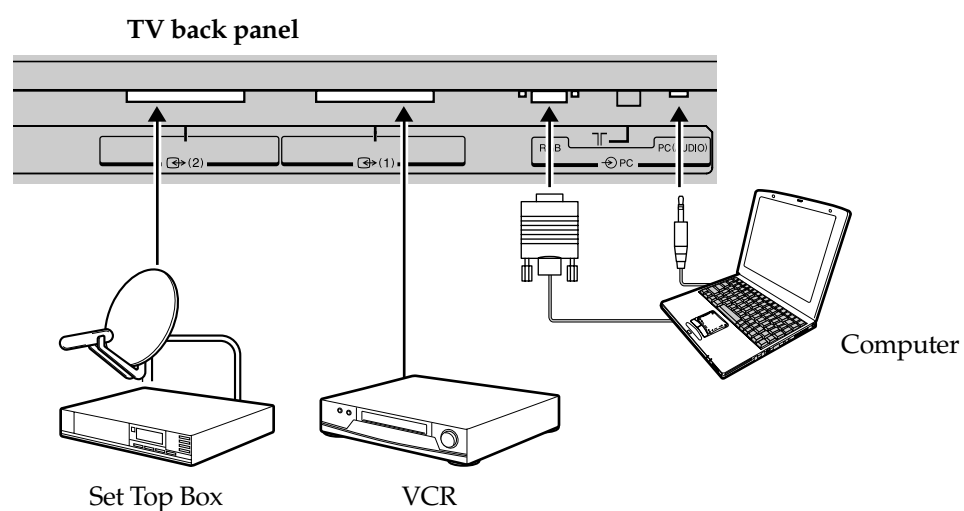

- Do not plug in any power cords until you have finished connecting all equipments.
- Before connecting any external equipment, remove the TV back terminal panel cover (see page 10).
- The unauthorized recording of television programmes, video tapes and other materials may infringe upon the provisions of copyright laws.
- Additional equipments and cables shown here are not supplied with this TV.

Connecting a computer

- Before connecting PC and audio cables, remove the back terminal panel cover (see page 10).
- An analogue RGB (15-pin) computer cable can be connected.

To connect a computer

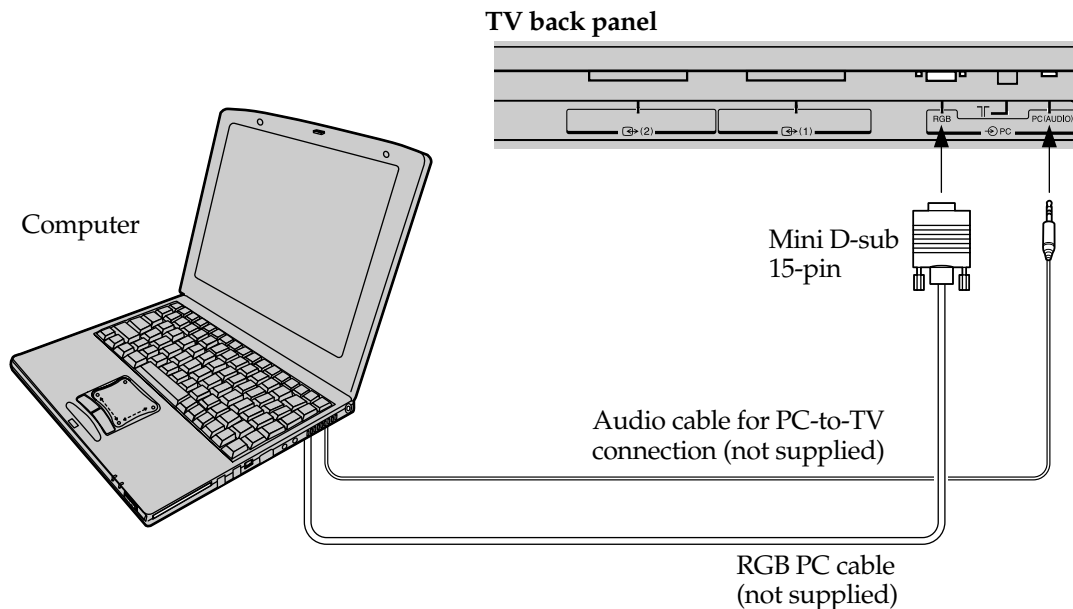

Connect a PC cable from the computer to the RGB/PC input terminal on the back of the TV.

The following signal can be displayed:

- VGA: VESA 640 x 480 @ 60 Hz (20VL56B/G)
- XGA: VESA 1024 x 768 @ 60Hz (15VL56B/G)

Other formats or non-standard signals may not be displayed correctly.

Notes:

- Some PC models cannot be connected to this TV.
- Computers with a DOS/V compatible mini D-sub 15-pin terminal do not require an adapter.
- Some input signals may cause a bar to appear in the upper, lower, right, or left side of the screen, or may obscure parts of the picture. This is not a malfunction.
- If the edges of the picture are stretched, readjust the picture position through the PC's menu.
- Depending on the DVD's title and the specification of the PC on which you are playing the DVD-Video, some scenes may be skipped or you may not be able to pause during multi-angle scenes. This is not a malfunction.

Signal names for mini D-sub 15 pin connector

Pin No.	Signal name	Pin No.	Signal name
1	R	9	NC
2	G	10	Ground
3	B	11	NC
4	NC (not connected)	12	NC
5	Ground	13	H-sync
6	Ground	14	V-sync
7	Ground	15	NC
8	Ground		

Pin assignment for RGB/PC terminal

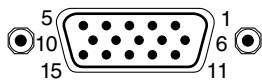

PC Setting

- You can adjust the horizontal/vertical picture position, clock (to minimize vertical stripes on the screen), and phase (to remove horizontal noise and sharpen the picture).
- You can auto-configure and reset these settings.

Picture position/Clock/Phase adjustments

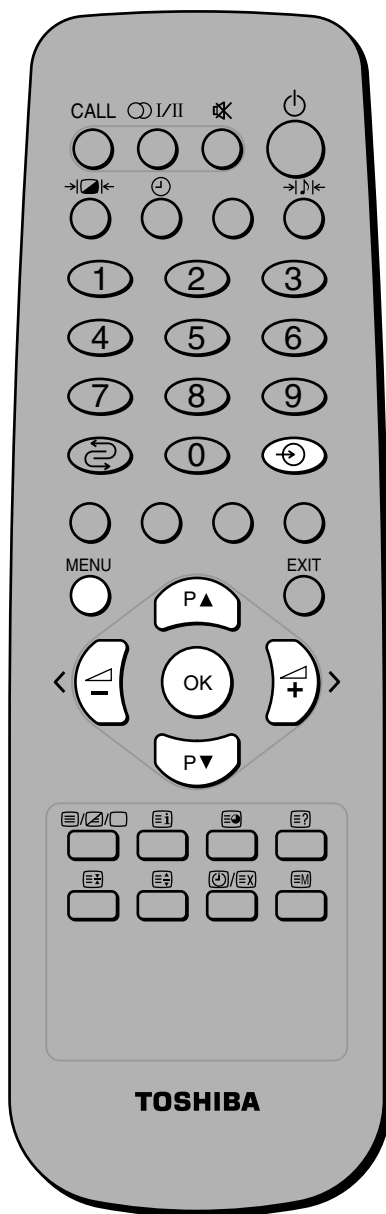

Note:
The optimum points of the clock and phase adjustments will vary according to input signals.

First press the button repeatedly to select the PC input mode (see page 23).

- 1 Press the **MENU** button, then press the **<** or **>** button to display the PC menu.

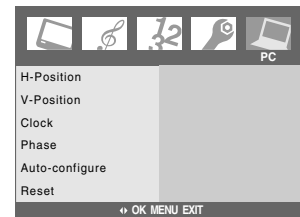

- 2 Press the **OK** button, then press the **▼** or **▲** button to select the desired item.

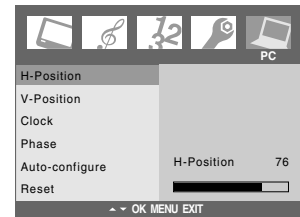

- 3 Press the **OK** button, then press the **<** or **>** button to make appropriate adjustments.

- H-Position / V-Position

Use this function to adjust the picture to the left/right and up/down as you prefer.

- Clock

Use this function to minimize any vertical bars or stripes visible on the screen background. The horizontal screen size will also change.

- Phase

Use this function to remove any horizontal noise and sharpen the image of characters.

- The Auto-configure function allows you to automatically adjust the screen position, clock, and phase.
- The reset function allows you to return to the picture settings programmed at the factory.

Auto-configure/To reset

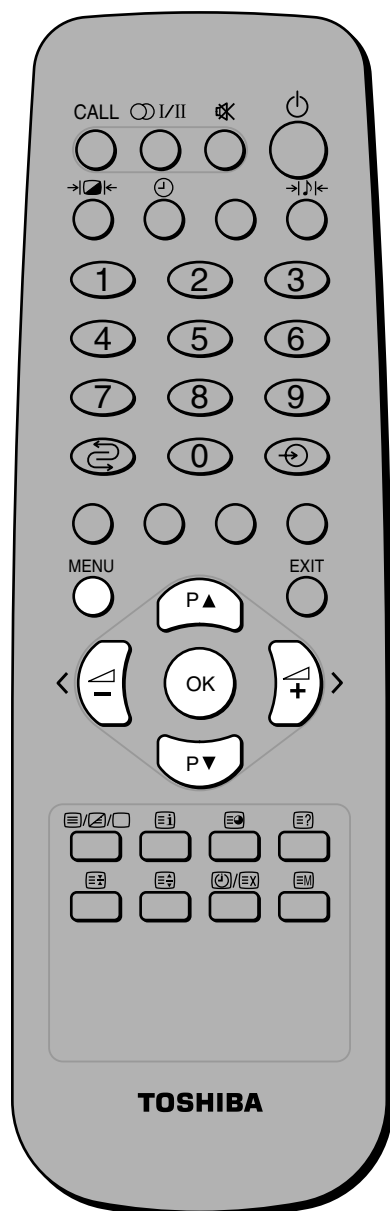

Note:
Some graphic boards' signals may not display properly. If the results are unsatisfactory, adjust your monitor's position, clock and phase manually.

To configure automatically:

- 1 Press the **MENU** button, then press the < or > button to display the PC menu.
- 2 Press the **OK** button, then press the ▼ or ▲ button to select Auto-configure.

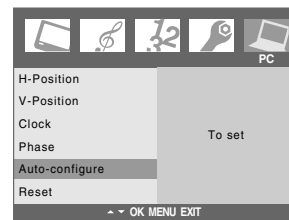

- 3 Press the **OK** button. The automatic adjustment will start.

Note:
The displayed image will disappear for a few seconds while Auto configuration is in progress.

To reset the PC setting:

- 1 Press the **MENU** button, then press the < or > button to display the PC menu.
- 2 Press the **OK** button, then press the ▼ or ▲ button to select Reset.

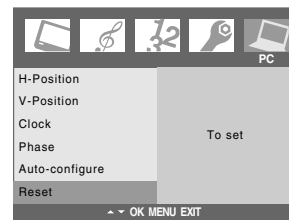

- 3 Press the **OK** button.

Troubleshooting

Before calling a service technician, please check the following table for a possible cause of the symptom and some solutions.

Symptom and solution

Symptom	Solution
TV will not turn on	<ul style="list-style-type: none"> • Make sure the power cord is plugged in, then press \odot/I. • The remote control batteries may be dead. Replace the batteries.
No picture, no sound	<ul style="list-style-type: none"> • Check the aerial connections.
No sound, picture OK	<ul style="list-style-type: none"> • The sound may be muted. Press \triangle +, \triangle - or \otimes. • The station may have broadcast difficulties. Try another channel.
Poor sound, picture OK	<ul style="list-style-type: none"> • The station may have broadcast difficulties. Try another channel.
Poor picture, sound OK	<ul style="list-style-type: none"> • Check the aerial connections. • The station may have broadcast difficulties. Try another channel. • Adjust the Picture menu.
Poor reception of broadcast channels	<ul style="list-style-type: none"> • Check the aerial connections. • The station may have broadcast difficulties. Try another channel.
Teletext problems	<ul style="list-style-type: none"> • Check the aerial connections. <p>Good performance of text depends on a clear, strong broadcast signal.</p>
Multiple images	<ul style="list-style-type: none"> • The station may have broadcast difficulties. Try another channel. • Aerial reception may be poor. Use a highly directional outdoor aerial. • Check if the direction of the aerial has changed.
Poor colour or no colour	<ul style="list-style-type: none"> • The station may have broadcast difficulties. Try another channel. • Adjust the Tint and/or Colour in the Picture menu.
The top panel buttons do not operate	<ul style="list-style-type: none"> • Check the Panel lock feature.
The remote control does not operate	<ul style="list-style-type: none"> • Remove all obstructions between the remote control and the remote control sensor in the TV. • The remote control batteries may be dead. Replace them with new ones.
Some pixels of the screen do not light up	<ul style="list-style-type: none"> • The LCD display panel is manufactured with an extremely high level of precision technology. However, some pixels of the screen may have missing picture elements or luminous spots. This is not a sign of a malfunction.
The picture brightness is reduced, the screen flickers, or some parts of the screen do not light up	<ul style="list-style-type: none"> • When you first buy and start to use this TV, the screen may flicker. If this happens, turn off the TV, then turn it on again. • The cold cathode fluorescent lamp used for the back light on this TV has a limited service life. When the picture brightness fades, the screen flickers, or some parts of the screen do not light up, the lamp may be at the end of its useful life. Contact a service technician.
The picture brightness varies when you turn on the TV	<ul style="list-style-type: none"> • If you turn on the TV in an area with a temperature of 0°C or lower, wait until the display warms up.

Specifications

LCD colour television specifications

- Design and specifications are subject to change without notice.
- Never service or remodel the TV by yourself. It may expose you to a fire hazard or dangerous voltages.

Model	15VL56B/G, 20VL56B/G		
Power source	100 - 240V AC, 50/60 Hz		
Power consumption	15VL56B/G: 50 W, 0.8 W (standby mode) 20VL56B/G: 65 W, 0.8 W (standby mode)		
Dimensions (Including TV stand)	15VL56B/G: 379 mm (W)	388 mm (H)	203 mm (D)
	20VL56B/G: 491 mm (W)	469 mm (H)	228 mm (D)
Mass (Weight)	15VL56B/G: 5.6 kg 20VL56B/G: 9.1 kg		
Television system (Aerial input)	Channel coverage:		
	PAL B/G (CCIR)	VHF 2 - 12 UHF 21 - 69 CATV X - Z+2, S1 - S41	
	PAL I (UK)	VHF - UHF 21 - 69 CATV -	
	PAL D/K (CHINA)	VHF 1 - 12 UHF 13 - 57 CATV Z1 - Z38	
	SECAM B/G (CCIR)	VHF 2 - 12 UHF 21 - 69 CATV X - Z+2, S1 - S41	
	SECAM D/K (OIRT)	VHF 1 - 12 UHF 21 - 69 CATV X1 - X19	
	SECAM L (FRANCE)	VHF 2 - 10 UHF 21 - 69 CATV B - Q	
	NTSC M (US)	VHF 2 - 13 UHF 14 - 69 CATV A6 - A1, A - W, AA - ZZ, AAA, BBB	
	NTSC M (JAPAN)	VHF 1 - 12 UHF 13 - 62 CATV M1 - M10, S1 - S41	
	Special RF signal:		
	NTSC 4.43 colour system 5.5/6.0/6.5 MHz sound system		
	PAL 60 Hz colour system 5.5/6.0/6.5 MHz sound system		

Introduction

Getting started

Basic operation

Using the TV's features

Viewing teletext

Equipment connections

Reference section

LCD colour television specifications (continued)

Colour system	PAL, SECAM, NTSC 3.58/4.43		
Aspect ratio	4 : 3		
Visible size (diagonal)	15VL56B/G: 38.0 cm 20VL56B/G: 51.0 cm		
Number of pixels	15VL56B/G: 1024 (H) dots × 768 (V) dots 20VL56B/G: 640 (H) dots × 480 (V) dots		
Audio power	5 W + 5 W (10% THD)		
Speakers	40 × 70 mm 2pcs.		
Input/Output terminals	VIDEO 1 Input/Output	21 pin Scart	RGB, A/V
	VIDEO 2 Input/Output	21 pin Scart	A/V
	VIDEO 3 Input	4 pin	S-video
		Phono jacks	A/V
	PC Input	Analogue RGB (Mini D-sub 15-pin)	
		Audio (3.5 mm stereo mini)	
	Headphone jack	3.5 mm stereo mini	
Operating condition	Temperature	0°C - 35°C	
	Humidity	20% - 80% (No moisture condensation)	
Supplied accessories	Owner's manual (1), Power cord (1), Remote control (1), Batteries (2), Clip (1)		



This is used to fix the TV to a wall, pillar, etc. (see page 4)

TOSHIBA CORPORATION

YC/L 72742088

Free Manuals Download Website

<http://myh66.com>

<http://usermanuals.us>

<http://www.somanuals.com>

<http://www.4manuals.cc>

<http://www.manual-lib.com>

<http://www.404manual.com>

<http://www.luxmanual.com>

<http://aubethermostatmanual.com>

Golf course search by state

<http://golfingnear.com>

Email search by domain

<http://emailbydomain.com>

Auto manuals search

<http://auto.somanuals.com>

TV manuals search

<http://tv.somanuals.com>