

**TOSHIBA**



## LCD TV/DVD COMBINATION

19DV615Y

22DV615Y

26DV615Y

---

### OWNER'S MANUAL



©2009 Toshiba Corporation  
Before operating the unit, please read this manual thoroughly.

#### Owner's Record

The model number and serial number are on the back of your TV/DVD. Record these numbers in the spaces below. Refer to these numbers whenever you communicate with your Toshiba dealer about this TV/DVD.

Model number: \_\_\_\_\_

Serial number: \_\_\_\_\_

# Precautions

## CAUTION:

THIS UNIT IS A CLASS 1 LASER PRODUCT. HOWEVER THIS UNIT USES A VISIBLE LASER BEAM WHICH COULD CAUSE HAZARDOUS RADIATION EXPOSURE IF DIRECTED. BE SURE TO OPERATE THE PLAYER CORRECTLY AS INSTRUCTED.

THE FOLLOWING CAUTION LABEL IS LOCATED ON THE REAR PANEL OF THE UNIT.



WHEN THIS UNIT IS PLUGGED INTO THE WALL OUTLET, DO NOT PLACE YOUR EYES CLOSE TO THE OPENINGS TO LOOK INTO THE INSIDE OF THIS UNIT.

USE OF CONTROLS OR ADJUSTMENTS OR PERFORMANCE OF PROCEDURES OTHER THAN THOSE SPECIFIED HEREIN MAY RESULT IN HAZARDOUS RADIATION EXPOSURE.

DO NOT OPEN COVERS AND DO NOT REPAIR YOURSELF. REFER SERVICING TO QUALIFIED PERSONNEL.

## Headphone Warning

Loud music can damage your hearing irreversibly, therefore do not set the volume to a high level when listening through headphones, particularly for extended listening periods.

## Information for the DVB-T function

- Any function relative to the digital television (with the DVB logo) is available only within the country or area where such signals are transmitted. Verify with the salesman if it is possible to receive a DVB-T signal in the zone where you live.
- Even if the television conforms to the DVB-T specifications, the compatibility to future digital DVB-T transmissions is not guaranteed.
- Some digital television functions may not be available in some countries.
- The DVB-T system present in this device is FTA (Free to air).
- \* DVB is a registered trademark of the DVB Project. This logo indicates that the product is compliant with European Digital Broadcasting.

**Possible Adverse Effects on LCD Screen:** If a fixed (non-moving) pattern remains on the LCD screen for long periods of time, the image can become permanently engrained in the LCD TV panel and cause subtle but permanent ghost images. This type of damage is NOT COVERED BY YOUR WARRANTY. Never leave your TV on for long periods of time while it is displaying the following formats or images:

- Fixed Images, such as stock tickers, video game patterns, TV station logos, and websites.
- Special Formats that do not use the entire screen. For example, viewing letterbox style (16:9) media on a normal (4:3) display (Black bars at top and bottom of screen); or viewing normal style (4:3) media on a widescreen (16:9) display (Black bars on left and right sides of screen).

The examples used throughout this manual are based on the 26DV615Y model.

### IMPORTANT INFORMATION

If a television is not positioned in a sufficiently stable location, it can be potentially hazardous due to falling. Many injuries, particularly to children, can be avoided by taking simple precautions such as:

- Using stands recommended by the manufacturer of the television.
- Only using furniture that can safely support the television.
- Ensuring the television is not overhanging the edge of the supporting furniture.
- Not placing the television on tall furniture (for example, cupboards or bookcases) without anchoring both the furniture and the television to a suitable support.
- Not standing the televisions on cloth or other materials placed between the television and supporting furniture.
- Educating children about the dangers of climbing on furniture to reach the television or its controls.

Place the TV on a stable, level surface that can support the weight of the TV. In order to maintain stability and prevent it falling over, secure the TV to the level surface using the strap located under the table top stand, or, to a wall using a sturdy tie to the clip on the back of the table top stand.

# Contents

Precautions .....	2
Important safety information .....	4
Location of controls .....	6
Remote control .....	7
I/O connections .....	9
Auto setup .....	10
Quick guide for menu operation .....	12
Selecting the video input source/On-screen language selection .....	13
Automatic station presetting with the built-in Tuner .....	14
Manual TV station presetting .....	16
Basic operation .....	17
Teletext .....	19
Stereo reception with the built-in analog tuner .....	20
Picture format .....	21
Other convenience functions .....	22
Display setup/Timer setting (DTV mode only) .....	24
Password setup (Parental lock) (DTV mode only) .....	25
Version .....	26
Multi audio/DVB-Subtitle (DTV mode only) .....	27
EPG (Electronic Program Guide) (DTV mode only) .....	28
EPG Timer (DTV mode only) .....	29
Disc .....	30
Playing a disc .....	31
Zooming/Locating desired scene .....	34
Marking desired scenes .....	35
Repeat playback/A-B Repeat playback .....	36
Changing angles/Title selection/DVD menu .....	37
Changing soundtrack language/Subtitles/Disc status .....	38
MP3/JPEG/DivX® and Audio CD operation .....	39
Program playback/Random playback .....	45
Customizing the function settings .....	46
Temporary cancel the rating level by DVD disc .....	52
PC connection .....	53
Connecting TV to other equipment .....	54
Status message .....	56
Troubleshooting table .....	57
Specifications .....	58
The GNU General Public License (GPL) .....	59
LIMITED WARRANTY STATEMENT .....	62

# Important safety information

This unit has been produced according to all current safety regulations. The following safety tips should safeguard users against careless use and the dangers connected with such use.

- Although this appliance has been carefully manufactured and rigorously checked prior to leaving the factory, as with all electrical appliances it is possible for problems to develop. If you notice smoke, an excessive build-up of heat or any other unexpected phenomena, you should disconnect the plug from the mains power socket immediately.
- Ensure that the unit is sufficiently ventilated! Never place next to or underneath curtains!
- This set should be only be connected to an AC 220 ~ 240V / 50Hz mains power supply - do not attempt to connect it to any other type of supply.
- The socket-outlet must be installed near the equipment and easily accessible.
- Any repairs must be carried out by qualified service personnel only.
- Do not open this unit. A non-expert attempting to repair the unit could be dangerous and potentially cause a fire hazard.
- Keep away from rodents. Rodents (and also cockatiels) enjoy biting into electric flexes.
- The animal can cause a short cut (fire hazard!) and receive a fatal electric shock.
- Always hold plug when pulling out plug from power mains supply system. Do not pull on flex. The flex can become overloaded and cause a short cut.
- Never wet clean. Only use a damp cloth, the same as when cleaning furniture.
- Set up unit so that no one is able to trip over the flex.
- This unit is recommended to be installed on shock-free benches in order to avoid any danger from falling.
- Take note that toddlers can pull the unit down from the table or cupboard by means of its flex. Children can hurt themselves when doing this.
- Do not use the unit near heat sources. The casing and flex could be damaged by the impact of heat.
- The screen is made of glass and can break if damage is done to it. Be careful when collecting sharp edged glass splitters.
- You could be hurt or the unit could be damaged.
- If the unit is mounted on the wall, contact the shop where you purchased the unit for advice, and leave the installation work to experts. Incomplete installation work can cause you injuries.
- When installing the set on a wall, allow at least 10 cm clearance between the rear of the set and the wall.
- Clearance of less than 10 cm will obstruct the vents and cause the interior of the set to overheat, resulting in faults or damage to the set.
- Taking fall-prevention measures
  - If these measures are not taken, the unit can fall and you could be injured.
  - Contact the shop where you purchased the unit to obtain full details of the measures.
- When a TV stand is used,
  - Ensure the unit is fully on the stand and placed in the centre.
  - Do not leave the stand doors open.
  - You could be hurt as a result of the unit falling or breaking, or your fingers being caught or jammed. Take extra precautions if you have children.
- Avoid placing the unit on any surfaces that may be subject to vibrations or shocks.
- To protect the unit during a thunder storm unplug the AC power cord and disconnect the aerial. Caution:
- Do not touch the aerial connector.
- When you leave your home for a long period of time, unplug the AC power cord for safety reasons.
- The unit becomes warm when in operation. Do not place any covers or blankets on the unit in order to prevent overheating. The ventilation holes are not to be blocked. Do not set up near radiators. Do not place in direct sunshine. When placing on a shelf leave 10 cm free space around the whole unit.
- Make some space around TV (Correct shelf assembly).
- The apparatus shall not be exposed to dripping or splashing and that no objects filled with liquids, such as vases, shall be placed on the apparatus.
- Liquids spilled into the unit can cause serious damage. Switch the set OFF and disconnect the mains power supply, then consult a qualified service person before attempting to use the unit again.
- Moisture condensation occurs, for example, when you pour a cold drink into a glass on a warm day. Drops of water form on the outside of the glass. In the same way, moisture may condense on the optical pick-up lens inside this unit, one of the most crucial internal parts of the unit.
- Moisture condensation occurs during the following cases.
  - When you bring the unit directly from a cold place to a warm place.
  - When you use the unit in a room where you just turned on the heater, or a place where the cold wind from the air conditioner directly hits the unit.
  - In summer, when you use the unit in a hot and humid place just after you move the unit from an air conditioned room.
  - When you use the unit in a humid place.
- Do not use the unit when moisture condensation may occur.
- If you use the unit in such a situation, it may damage discs and internal parts. Remove the disc, connect the mains lead of the unit to the mains power outlet, turn on the unit, and leave it for two or three hours. After two or three hours, the unit will have warmed up and evaporated any moisture. Keep the unit connected to the mains power outlet and moisture condensation will seldom occur.
- Never place hot objects of open flame sources, such as lighted candles or nightlights, on or close to the TV
- High temperatures can melt plastic and lead to fires.

## Important safety information (continued)

### Where to install

Locate the television away from direct sunlight and strong lights, soft, indirect lighting is recommended for comfortable viewing. Use curtains or blinds to prevent direct sunlight falling on the screen.

Place on a sturdy platform, the mounting surface should be flat and steady. It should then be secured to the wall with a sturdy tie using the clip on the back of the stand, or secured to the platform using the fixing strap located underneath the table top stand, this will prevent it from falling over.

The LCD display panels are manufactured using an extremely high level of precision technology, however sometimes some parts of the screen may be missing picture elements or have luminous spots. This is not a sign of a malfunction.

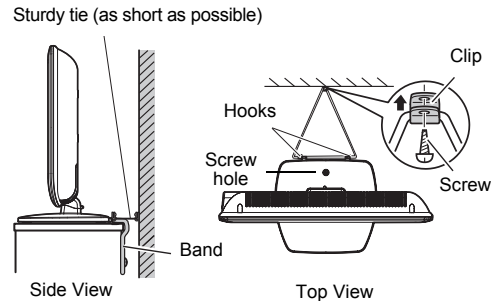

Make sure the television is located in a position where it cannot be pushed or hit by objects, as pressure will break or damage the screen, and that small items cannot be inserted into slots or openings in the case.

### Retractable pedestal stand and locating the LCD TV

Observe the following safety precautions:

- (1) Ensure that unpacking and transfer of the unit is carried out by two or more people.
- (2) Put the LCD TV on a large level area in a recumbent posture.
- (3) Grab the pedestal stand and lift the display up. Confirm the pivot is locked.
- (4) Place the TV on a sturdy, level surface that can support the weight of the TV.
- (5) Be sure to secure the TV to a wall stud, pillar, surface, or other immovable structure. To secure the TV in this manner: (1) attach a clip to an immovable structure, then (2) pass a sturdy strap through the clip and attach each end to the hooks located at the back of the TV. Be sure to leave at least 10 cm between the TV and the wall or similar structure for ventilation.

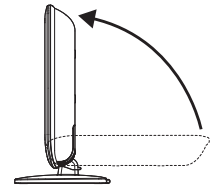

### To fold the pedestal stand

- (1) Slide the lever on the back side of the pedestal stand to the left.
- (2) Lay the display down.

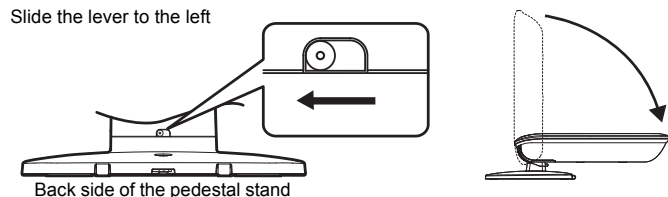

**Note: Do not operate the LCD TV when the pedestal stand is folded. The pedestal stand should not be folded at any time except for packing purposes.**

### Please take note

#### EXCLUSION CLAUSE

Toshiba shall under no circumstances be liable for loss and/or damage to the product caused by:

- i) fire;
- ii) earthquake;
- iii) accidental damage;
- iv) intentional misuse of the product;
- v) use of the product in improper conditions;
- vi) loss and/or damage caused to the product whilst in the possession of a third party;
- vii) any damage or loss caused as a result of the owner's failure and/or neglect to follow the instructions set out in the owner's manual;
- viii) any loss or damage caused directly as a result of misuse or malfunction of the product when used simultaneously with associated equipment;

Furthermore, under no circumstances shall Toshiba be liable for any consequential loss and/or damage including but not limited to the following, loss of profit, interruption of business, the loss of recorded data whether caused during normal operation or misuse of the product.

If stationary images generated by text services, channel identification logos, computer displays, video games, on screen menus, etc. are left on the television screen for any length of time they could become conspicuous, it is always advisable to reduce both the brightness and contrast settings.

# Location of controls

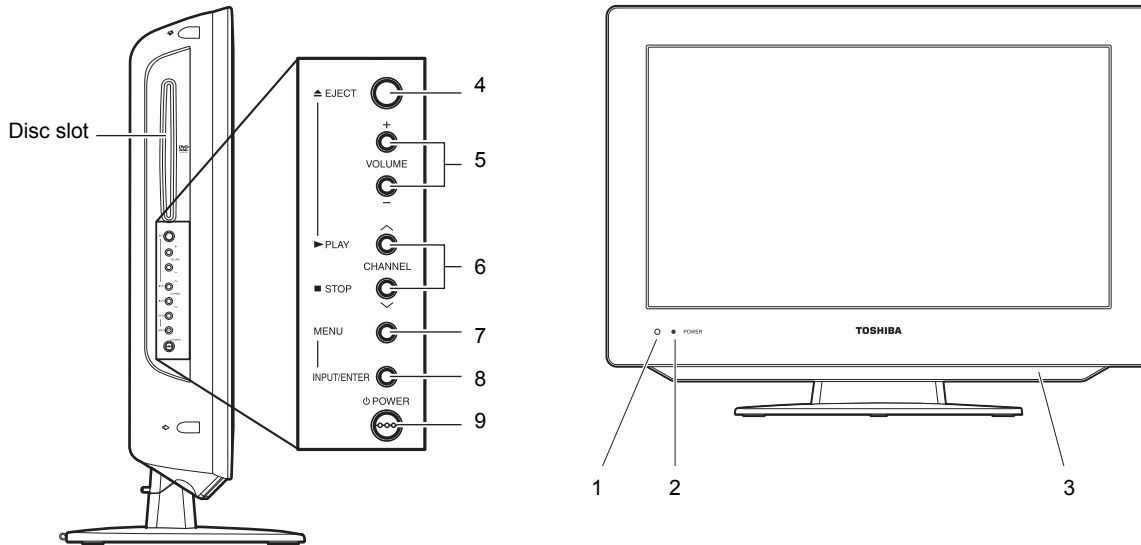

## Adjusting the screen angle

You can adjust the angle of the TV-screen for 2° forward or for 10° backward from vertical angle. Hold the base of the TV while adjusting the angle.

Applicable to the following models only:  
19DV615Y and 22DV615Y

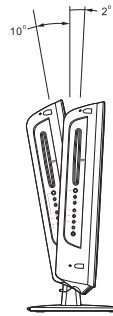

## Description of indicators and controls

1. **Remote sensor**
2. **POWER indicator:** The POWER indicator indicator lights up red in standby mode and green when TV is powered on.
3. **Loudspeakers**
4. **(EJECT) button:** Ejects a disc.
5. **(VOLUME) + / - buttons:** Adjust the volume level. In Menu: Setting.
6. **(PLAY) button** / **(CHANNEL) ^ button:** Press ^ to change to a higher numbered channel set into memory. In DVD mode: Playback. In Menu: Setting. In Standby mode: Turns the TV on.
7. **(STOP) button** / **(CHANNEL) v button:** Press v to change to a lower numbered channel set into memory. In DVD mode: Stop. In Menu: Setting. In Standby mode: Turns the TV on.
7. **MENU button:** Displays the Main Menu screen.
8. **INPUT/ENTER button:** Select video input source. In Menu: Use as an **ENTER** button to confirm selection.
9. **POWER button:** Preparation: Connect the power cable to 240V/50Hz AC outlet. Press the **POWER** button to turn on the TV.
  - a) If the standby indicator is on, you can turn off the TV by pressing the **POWER** button once, then release the button. The red standby indicator turns off.
  - b) If the standby indicator is off, you can turn on the TV by pressing the **POWER** button once, then release the button. The standby indicator lights red and after 1 second turns to green.
  - c) If the TV is currently working, you can turn off the TV by pressing the the **POWER** button once, then release the button. The indicator turns off.

When the TV is not turned on, pressing on the remote control will not turn the TV on.  
When the TV is not turned on, the TV's power consumption is approx. 1 watt. If total disconnection from the mains power is required, unplug the mains lead.

# Remote control

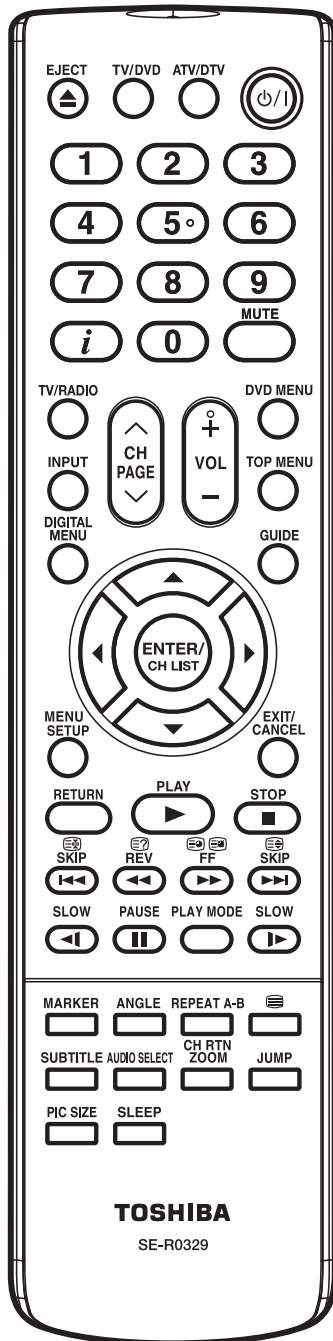

	Function	Page
EJECT	Eject a disc	32
TV/DVD	Select to operate TV/DVD	12, 31
ATV/DTV	Switches between the analog TV and the digital TV	12
(Power)	Enter standby mode or turn on the power	10
0 ~ 9	Select channel Select Teletext page Enter password	17 19 25, 51
i	Display source information and Teletext time	18
MUTE	Turn the sound on/off	17
TV/RADIO	Toggle between the TV, Radio, and Data mode	17
INPUT	Select an input source	13
CH PAGE	Change the TV channel or Teletext page up or down In Standby: Turn on the power	17, 19 12
VOL	Volume	17
DVD MENU	Select menu of a DVD disc	37
TOP MENU	Select title of a DVD disc	37
DIGITAL MENU	Activate the Digital Main Menu	12
GUIDE	Display the EPG (Electronic Program Guide)	28
ENTER/CH LIST	Cursor buttons	10
ENTER/CH LIST	Memorize Teletext page 100 CH LIST	10 19 17
MENU SETUP	Call the DVD Setup menu Activate the Analog Main Menu	46 12
EXIT/CANCEL	Exit the Analog or Digital Main Menu screen Cancel marking	13 35
RETURN	Remove DVD set up menu	46, 52
PLAY	Play	31
STOP	Stop	31
SKIP	Hold the text page Skip chapter to reverse direction	19 33
REV	Reveal quiz page answers Review playback	19 33
FF	Sub page selection Forward playback	19 33
SKIP	Teletext enlargement Skip chapter to forward direction	19 33
FAST	Fasttext/TOPTtext buttons DVD control buttons	19 33, 36
MARKER	Marking desired scene	35
ANGLE	Change playback angle of a DVD disc	37
REPEAT A-B	Repeat playback between A and B (DVD/CD)	36
TELETEXT	Teletext ON/OFF	19
SUBTITLE	Display the subtitle	27, 38
AUDIO SELECT	Select between the available broadcast audio Change sound track language of DVD Display the multi audio menu	20 38 27
CH RTN	Switches between the present channel and the last selected channel Zoom (for DVD playback)	17 34
JUMP	Locating desired scene	34
PIC SIZE	Select picture format	21
SLEEP	Sleep Timer	18

# Remote control (continued)

## Install the batteries

Use batteries type UM4/R03 (AAA-Size).

### Notes:

- Exhausted batteries can leak corrosive electrolyte, which may cause damage to the remote control — therefore remove exhausted batteries immediately.
- Do not use old or weak batteries. The remote control may not work properly with a weak voltage from such batteries. Replace exhausted batteries with new ones. Never try to recharge normal batteries - this could cause an explosion.
- Dispose of batteries in a designated disposal area.

### Warnings:

- Never throw batteries into a fire.
- Never expose batteries to excessive heat such as sunshine, fire or the like.

1 Open the battery compartment cover in the direction of the arrow.

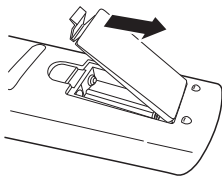

2 Install the batteries as shown below, ensuring the correct polarity.

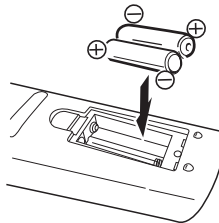

3 Close the battery compartment.

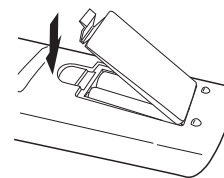

## Distance of Remote Control Operation

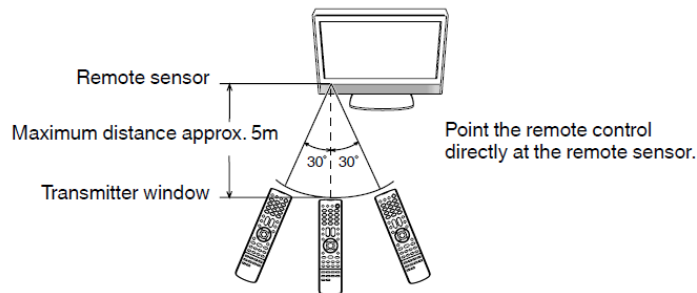

The remote control handset will not work properly in the following cases:

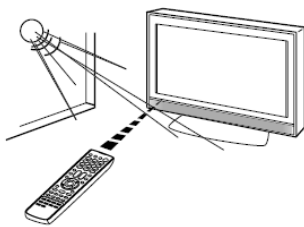

If bright sunlight directly beams onto the unit front.

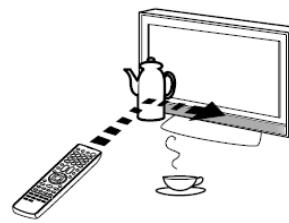

If an obstacle is placed between the unit and the handset.

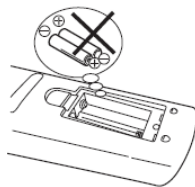

If the batteries have not been installed according to their polarities.

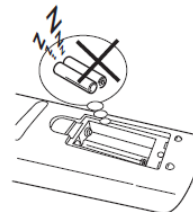

If the batteries are weak.



# I/O connections

**Note:**

Before you connect other appliances:

- To avoid potentially damaging your set, make sure all items are switched off and disconnected from the mains power when you make the connections.
- Arrange the desired connection.
- When you have finished making the connections, reconnect the mains power to the unit and switch it back on.

Connect your aerial as shown below. Connections to other equipment is explained further on pages 53 ~ 55.  
If you have problems with reception, consult a TV antenna installer.

Illustration of 26DV615Y

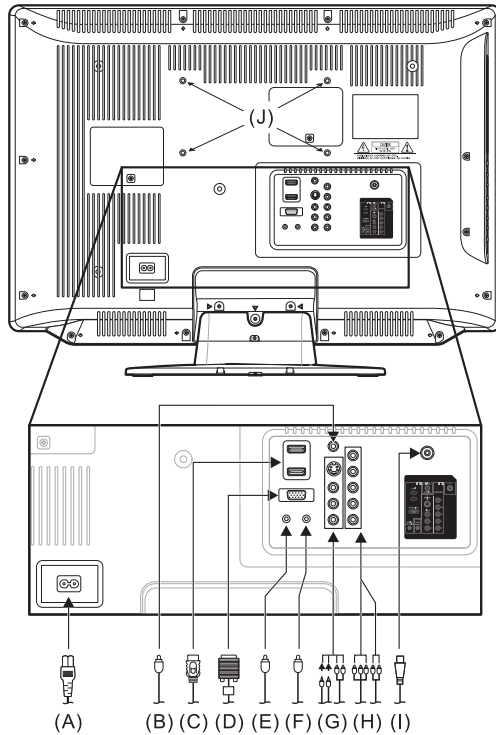
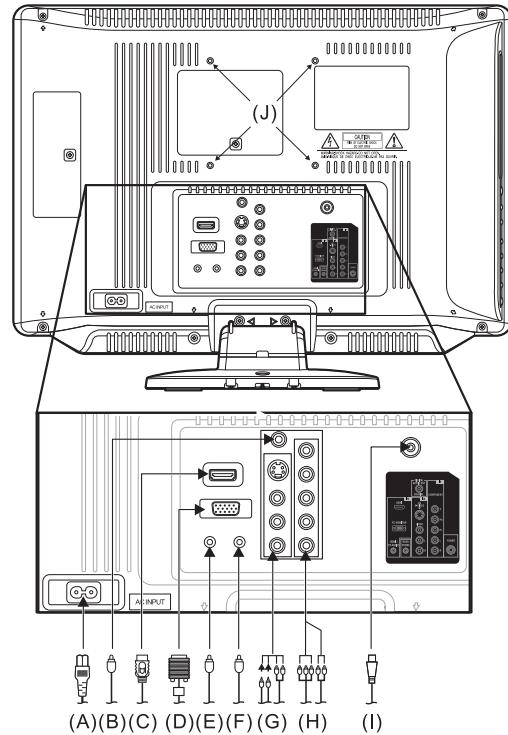

Illustration of 19DV615Y/22DV615Y



- (A) **AC input:** Connect the supplied power cable to an AC 220 ~ 240V/50Hz mains power supply only - do not attempt to connect it to any other type of supply. Never try to repair a damaged AC power cord with isolation-tape - this should be repaired by a specialist or replaced. Do not let your pet loose near the cable. Animals biting into the cable could receive a fatal electric shock, and could cause a hazard to others.
- (B) **COAXIAL DIGITAL AUDIO OUT:** Digital output for CD/DVD & DVB-T (see page 54).
- (C) **HDMI1/HDMI2 input:** Connects to digital audio or video sources, such as set-top boxes, video game consoles or AV receivers.
- (D) **PC MONITOR input (PC):** See page 53.
- (E) **HDMI/PC AUDIO input:** See pages 53.
- (F) **HEADPHONE jack:** Plug headphones with a mini plug (3.5 mm) into this jack.
- (G) **AV (S-VIDEO, VIDEO, Audio L/R) input:** Input for analog A/V-Signal (S-Video or Composite). See page 55.
- (H) **COMPONENT input:** See page 55.
- (I) **Aerial input socket:** Connect the outdoor aerial to the aerial input socket (see page 54).
- (J) **Bracket holes:** Fix a wall mounting bracket (not supplied) here.

# Auto setup

Your unit has an Automatic installation routine which makes installation in your unit easy. When you turn on the unit for the first time, the Automatic installation routine is activated. Using this routine, you can select the on-screen language and automatically search for and store all the receivable analog and digital (DVB) channels.

The Automatic station presetting feature is for the set's built-in tuner only. If you have a device such as a digital decoder (eg. Satellite or Digital Terrestrial) connected (see page 54), you would need to tune it in separately according to its own instructions.

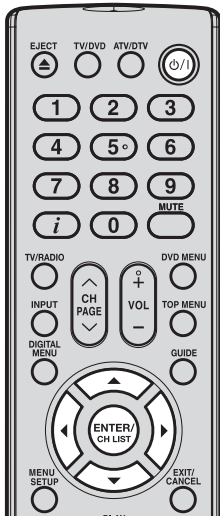

**Note:**

- To cancel Auto Tuning, press **EXIT/CANCEL** during the process.

The Automatic tuning process is only available the first time you turn on the TV/ DVD. However you can restart this process using the Main Menu screen (see page 14).

**Preparation:**

- Press **POWER** on the unit or **⏻** on the remote control. The Auto Installation menu will appear.
- Press **▲/▼** to select "Menu Language", then press **ENTER/CH LIST**. Press **◀/▶** to select desired language.
- Press **▲/▼** to select "Province/State", then press **ENTER/CH LIST**. Press **◀/▶** to select your province/state.
- Press **▲/▼** to select "Energy Saving Mode", then press **ENTER/CH LIST**. Press **◀/▶** to select your mode.

**Notes:**

- To ensure your TV is operating at optimal energy efficiency, select "Home" mode during initial activation.
- "Home" mode is recommended for normal home use. The factory default setting of this TV meets the Energy Saving requirement. Changing the Picture Setting may increase energy consumption, possibly beyond the limits required for Energy Saving qualification.
- When you select the "Home" mode setting, the corresponding picture preference is in "Standard" mode.
- When you select the "Retail" mode setting, the corresponding picture preference is in "Sports" mode.
- "Standard" picture preference is used to achieve published average power values, and this mode is recommended for normal home use.
- If you want to change the current energy saving mode setting, perform the Reset procedure (see page 14) and run the auto installation routine to select a different mode.

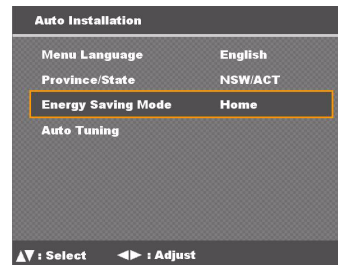
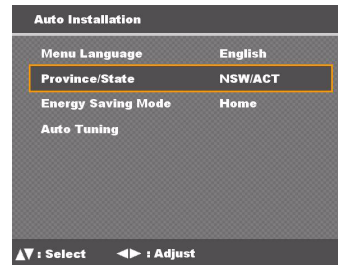
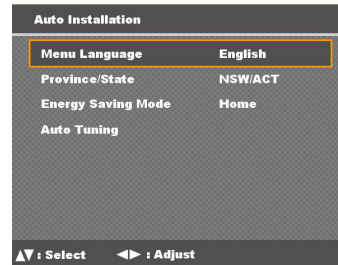

## Auto setup (continued)

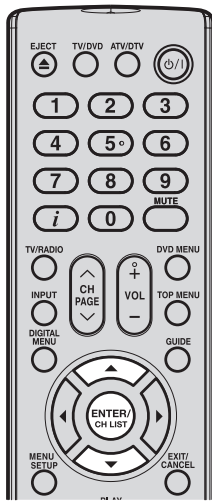

**Note:**

- To cancel Auto Tuning, press **EXIT/CANCEL** during the process.

- 5 Press **▲/▼** to select "Auto Tuning", then press **ENTER/CH LIST**.
- 6 Press **ENTER/CH LIST** again to begin the programme search.

Your TV will now scan or auto-tune for all available channels.

Your TV will tune analog channels first, then tune the digital channels.

**Note:**

- Please be patient - the Auto Tuning process can take several minutes to complete.

Once the auto channel search is completed the programme on the screen stops changing and the sound comes on, the search process is complete.

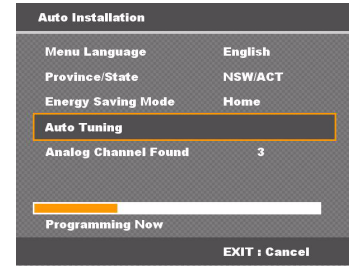

(Analog)

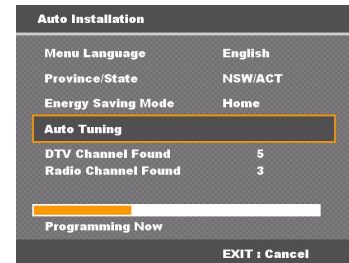

(Digital)

# Quick guide for menu operation

Make sure the aerial connection and power supply are connected as per the description on page 9.

## Preparations:

- Turn on the unit using **POWER** on the unit. The Power indicator will light up in green.

To change the unit to standby mode, press **STANDBY** on the remote control.

Power indicator will change from green to red. To turn on the unit from standby mode, press **POWER** on the remote control again.

In standby mode, you can also turn the unit on with (Channel) **UP/DOWN** on the unit or (PAGE) **UP/DOWN** on the remote control.

To turn off the unit press **POWER** on the unit - to completely switch it off, disconnect the mains power supply.

- Press **TV/DVD** to select the TV mode.
- Press **ATV/DTV** to toggle from analog TV or digital TV mode.

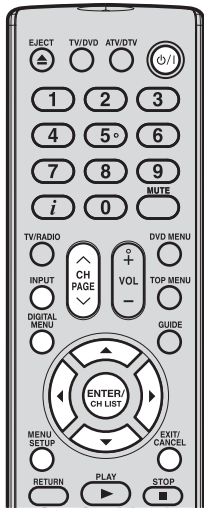

## Note:

- If no buttons are pressed after approximately 60 seconds, the Main Menu screen disappears.

## Quick guide for menu operation

Example: When the **DIGITAL MENU** is pressed in ATV mode, it will automatically switch to DTV mode. However, it is possible to use the **MENU SETUP** in the digital TV mode.

Launch the Main Menu screen by selecting Auto Tuning.

- Press **INPUT**.  
Select "ATV" or "DTV", then press **ENTER/CH LIST**.
- Press **MENU SETUP** in analog TV mode or press **DIGITAL MENU** in digital TV mode to display the Main Menu screen.

- Press **UP/DOWN** to select "Channel", then press **ENTER/CH LIST**.

- Press **UP/DOWN** to select "Auto Tuning", then press **ENTER/CH LIST** to enter the Auto Tuning menu.

- Press **LEFT/RIGHT** to select your province/state, then press **ENTER/CH LIST**.

- Press **UP/DOWN** to select "Start", then press **ENTER/CH LIST**.  
A message prompt will appear with option to delete previously stored channels.

- Press **LEFT/RIGHT** to select "Yes" or "No", then press **ENTER/CH LIST**.

The Auto Scan process will now begin. A progress bar appears to indicate scanning progress.

## Note:

- ...on the following pages the Menu can be called in the same way as here.

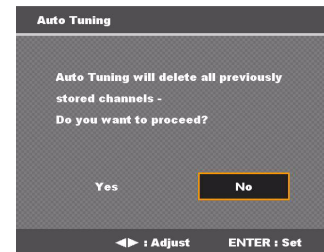
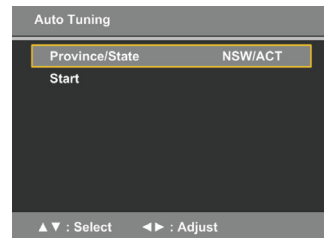
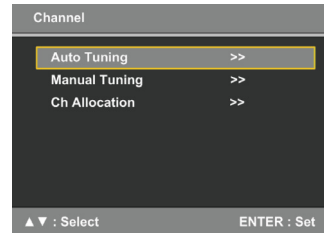
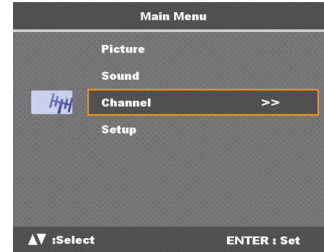

(Digital)



# Selecting the video input source/On-screen language selection



## Notes:

- Menu languages supported are English, French, Spanish, and Italian.
- If no buttons are pressed after approximately 60 seconds, the Main Menu screen disappears.
- All the channels will be deleted before the scanning process begins.
- You can cancel the scan process at any time by pressing **EXIT/CANCEL**. The carriers and the services stored before **EXIT/CANCEL** is pressed will be stored.
- When the signal from the broadcasting station is being updated and you are watching a digital broadcast, the channel will be automatically updated.

## Selecting the video input source

- 1 Press **INPUT**  to view a signal from another device connected to your TV, such as a VCR or DVD player. You can select each input source depending on the input jack used to connect your devices.
- 2 Press **▲ / ▼** to select a video input source, then press **ENTER/CH LIST**  within 6 seconds.

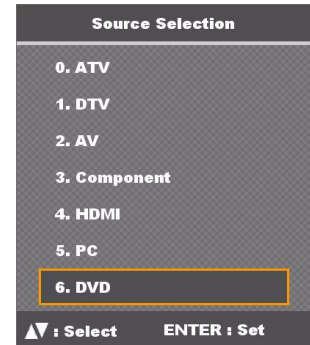







## On-screen language selection

### Preparation:

Switch on appliance.

Press **TV/DVD**  to select the TV mode.

Press **ATV/DTV**  to toggle from analog TV or digital TV mode.

- 1 Press **MENU SETUP**  or **DIGITAL MENU**  to display the Main Menu screen.
- 2 Select "Setup", then press **ENTER/CH LIST** .
- 3 Press **▲ / ▼** to select "Language Setup" (unless you have already selected when the set was first switched on), then press **ENTER/CH LIST** .
- 4 Press **▲ / ▼** to select "Menu Language", then press **▶** to display the language menu.
- 5 Press **▲ / ▼** to select your desired language, then press **ENTER/CH LIST** .

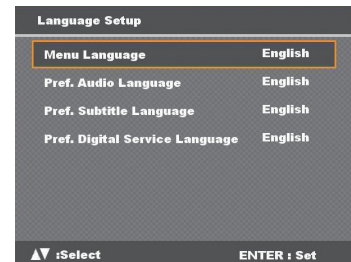
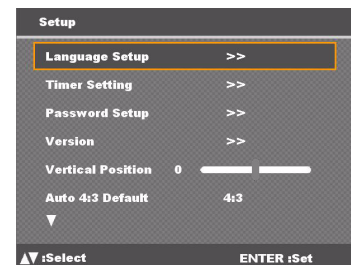

- 6 Press **EXIT/CANCEL**  to return to the normal screen.

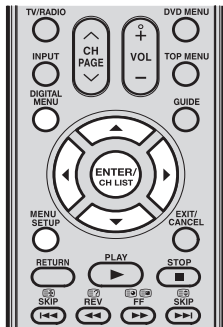

# Automatic station presetting with the built-in Tuner





## Automatic station presetting with the built-in Tuner

Perform this feature to search for and store new analog and digital TV programmes after the Automatic installation (see page 10).

### Preparation:

Make sure your antenna is connected to the aerial input (see page 9). Select ATV or DTV (see page 12), then press **MENU SETUP**  or **DIGITAL MENU** .

- 1 Press **▲ / ▼** to select "Channel", then press **ENTER/CH LIST** .
- 2 Select "Auto Tuning", then press **ENTER/CH LIST** .
- 3 Select "Province/State", then press **◀ / ▶** to select your province/state.
- 4 Select "Start", then press **ENTER/CH LIST** .  
The automatic tuning will search for available broadcasts and should store the channels in the correct order. During the search the sound is muted. When all programmes have been stored, the normal TV screen will appear.

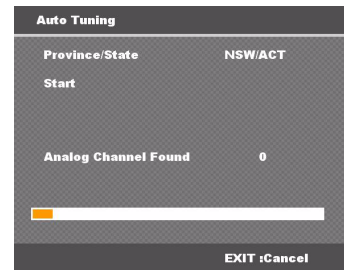

(Analog)

# Changing the order of stored channels

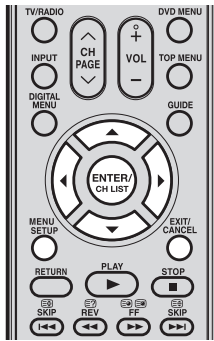

## Note:

- When changing the order of the channels, it is best to start with Ch1.

## Changing the order of stored channels

The Automatic station presetting stores the stations in a specific order. However, this order can be changed if you wish.

- 1 Press **▲ / ▼** to select "Ch Allocation", then press **ENTER/CH LIST**.

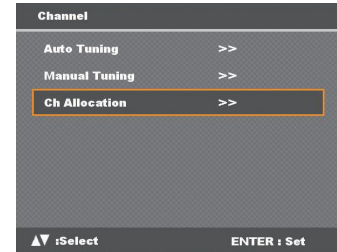

- 2 Select the desired option, then press **ENTER/CH LIST**.

- 3 After setting each option, press **MENU SETUP** to return to Ch Allocation menu.

- 4 Press **EXIT/CANCEL** to return to the normal screen.

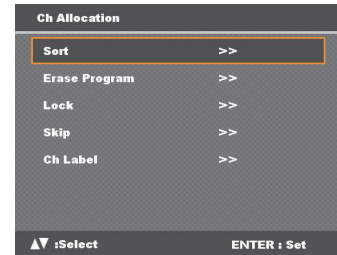

## Description about each setting option:

- Sort:** Press **▲ / ▼** to select the channel that you want to move, then press **ENTER/CH LIST**. Press **▲ / ▼** to select the position that you want to move the channel to, then press **ENTER/CH LIST**.
- Erase Program:** Press **▲ / ▼** to select the channel that you want to erase, then press **ENTER/CH LIST**.
- Lock:** This feature enables you to lock any channel you choose by pressing **ENTER/CH LIST**, then enter the parental lock password. If you have not set the parental lock password, you can use the initial password '0000'.
- Skip:** Press **▲ / ▼** to select the channel that you want to skip, then press **ENTER/CH LIST**. A \* mark will appear.
- Ch Label:** Press **◀ / ▶** to enter a suitable label for a selected channel, then press **▼**. Press **◀ / ▶** to select character, then press **ENTER/CH LIST**. The cursor will move to the next position. Press **ENTER/CH LIST** to set the channel label.

# Manual TV station presetting

If you like, you may manually tune a certain station into a selected programme position, without deleting or modifying program position's contents. The presetting applies to both analog and digital TV. Press the **ATV/DTV** <sup>ATV/DTV</sup> button to enter ATV or DTV mode then follow the steps to set the TV stations manually.

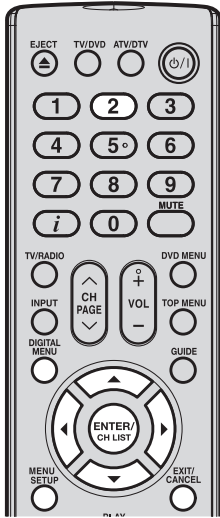

## Preparation:

Connect the aerial cable. Select programme position "2". Press **2**. OSD will indicate '2' in left upper corner. Eventually recently stored TV-channel's name might also appear.

- 1 Press **MENU SETUP** <sup>MENU SETUP</sup> or **DIGITAL MENU** <sup>DIGITAL MENU</sup> to display the Main Menu screen
- 2 Press **▲ / ▼** to select the "Channel" menu, then press **ENTER/CH LIST** <sup>ENTER/CH LIST</sup>.
- 3 Press **▲ / ▼** to select "Manual Tuning", then press **ENTER/CH LIST** <sup>ENTER/CH LIST</sup>.

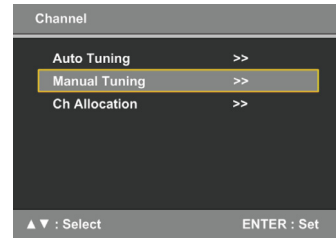

## 4 In ATV mode:

Press **▲ / ▼** to select "Search", then press **◀ / ▶** to start tuning. Tuning will stop automatically at next received station.

If you like to use fine-tuning, select "Fine". Press **◀ / ▶** to fine tune. See the note on this page.

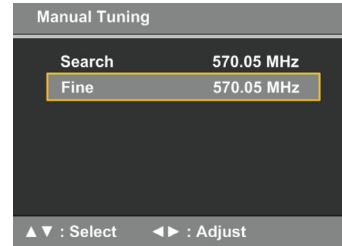
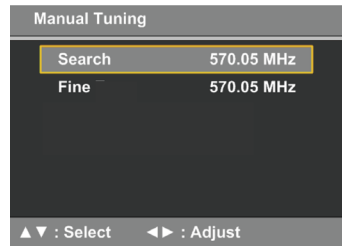

## Note:

- Usually fine tuning is not necessary, due to tuning's automatically stopping at the very best position. If you fine-tune anyway, proper working of teletext-reception with built-in tuner is no longer guaranteed.

## In DTV mode:

You can select a channel number for the Channel List by pressing **◀ / ▶**. The corresponding tuning frequency for the channel will be set. Or, you can enter a frequency value to start tuning.

After setting the channel, press **ENTER/CH LIST** <sup>ENTER/CH LIST</sup> to start scanning for channels.

A progress bar appears to indicate scanning progress and a list of the services (TV/radio) collected from the channel will be listed.





# Basic operation

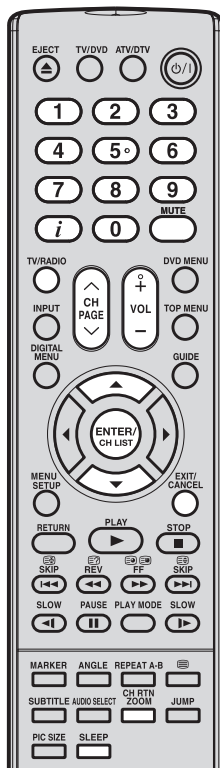

## Channel selection

Use the **0-9** numbered buttons.

Example:

- No. 2: Press **0** and within 2 seconds, press **2**.
- No. 29: Press **2** and within 2 seconds, press **9**.

- (1) Press **CH**  $\wedge$  /  $\vee$  to select a channel. This takes approx. 2 seconds. If the auto search only stored 5 stations, only these 5 will appear. Skipped channels will not appear (see page 15). The Channel List shows a list of all receivable programmes. They are located in channels 1 to 99 for ATV mode and 1 to 999 for DTV mode.
- (2) Press **CH LIST**  $\text{\textcircled{ENTER/CH LIST}}$  to display the Channel List.

Channel List - ATV	
01. Channel	
02. Channel	
03. Channel	
04. Channel	
05.	*
06.	*
07.	*
08.	*
09.	*
10.	*
11.	*

Analog Channel List

Channel List		Radio
S.No	Service	
007.	SBS 6	
008.	SBS 7	
009.	SBS 8	
010.	SBS 9	
011.	SBS 10	
012.	SBS 11	

DTV Channel List

- (3) Press  $\blacktriangle$  /  $\blacktriangledown$  to select the desired channel, then press **ENTER/CH LIST**  $\text{\textcircled{ENTER/CH LIST}}$  to display the selected channel.
- (4) Press **EXIT/CANCEL**  $\text{\textcircled{EXIT/CANCEL}}$  to exit.

## Toggle between the list of TV, Radio and Data services

- (1) Press **TV/RADIO**  $\text{\textcircled{TV/RADIO}}$  to switch between the TV, Radio and Data mode.
- (2) If you press **ENTER/CH LIST**  $\text{\textcircled{ENTER/CH LIST}}$  when you are in Radio mode the channel list menu will display the list of Radio services. If you wish to view the list of Data services without exiting the current menu, press **TV/RADIO**  $\text{\textcircled{TV/RADIO}}$  once. If you wish to view the list of TV services without exiting the current menu, press **TV/RADIO**  $\text{\textcircled{TV/RADIO}}$  twice.

## QuickView

Press **CH RTN**  $\text{\textcircled{CH RTN ZOOM}}$  to go back to the last selected channel.

## Volume adjustment

Press **VOL + / -** to adjust the volume level. The volume level indicator shows the current volume level. The indicator will disappear after 4 seconds of inactivity.

## Mute

Press **MUTE**  $\text{\textcircled{MUTE}}$  to switch off the sound. The TV/DVD's sound will be turned off and "Mute" will appear on-screen. Press **MUTE**  $\text{\textcircled{MUTE}}$  again or **VOL + / -** to turn the sound on.

## Notes:

- If the built-in tuner does not receive anything (e.g. if no antenna is connected) during TV-operation, then the TV-unit will change to standby after approx. 15 minutes.
- This unit only support NorDig Version 2.0 data service.
- Press **TV/RADIO**  $\text{\textcircled{TV/RADIO}}$  to switch to TV, Radio and Data three service categories according to NorDig 2.0 specifications.

# Basic operation (continued)

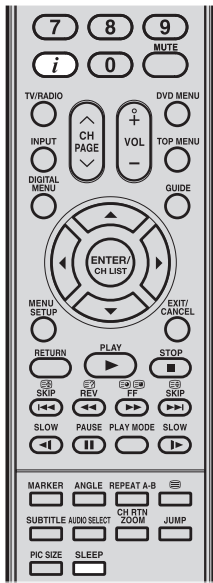

## Information display

### In ATV mode:

Press **i** to display the Channel number and sleep timer settings information on the screen. Current settings for the sound mode, picture size and resolution (if in use) are also displayed. The information will appear for approx. 5 seconds.



### In DTV mode:

When you switch channels, a channel banner is displayed for a few seconds. The channel banner shows information such as current date and time, DTV channel number, station and messages from the DTV service providers, etc.

- (1) While watching a programme, press **i** to display the Channel banner. The channel banner will disappear after a set time. You can change how long the channel banner is displayed, see page 24 for details.

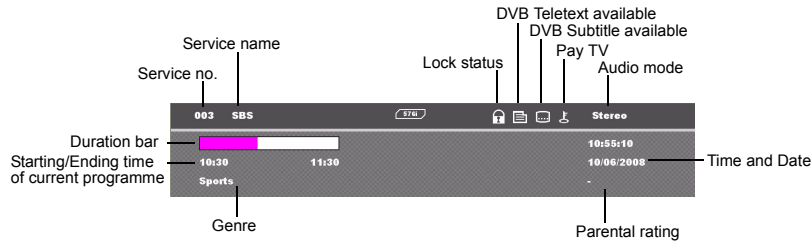

### Notes:

- In the Basic Service Information screen, the Channel/Service names, appear in full not abbreviated.
- Subtitles are displayed on the channel banner. Some broadcasts may not provide this service.

- (2) Press **i** again to display the Basic Service Information screen. You can verify the signal strength and quality of the selected service here. If necessary, adjust the direction of the antenna to obtain the maximum signal strength. A short event description of an event can also be viewed here. For an extended description of an event, you can view it in the EPG menu (see page 28).



- (3) Press **i** to remove the channel banner.

## Sleep timer

Press **SLEEP**  to set the TV/DVD to turn off at a preset amount of time. The clock will count up 10 minutes for each press of the **SLEEP** button (Off, 0h 10m, 0h 20m, ..., 2h 0m). After the sleep setting is programmed, the display will begin 30 seconds in advance to remind you that the sleep timer is enabled.

To confirm the sleep timer setting, press **SLEEP** and the time remaining time will be displayed for a few seconds. To cancel the sleep timer, press **SLEEP**  repeatedly until 'Off' appears.

# Teletext

Teletext is sent page by page. This unit is able to automatically store up to 256 pages, but they can only be accessed once they have been stored. This can take a few moments.

## Fastext/TOPText

The Fastext/TOPText is teletext with a special directory.

On the lower part of the screen there are four different coloured fields (red, green, yellow and blue). These fields lead directly to the pages shown within. The coloured buttons on the remote control correspond to the coloured fields. Press the appropriate coloured button in order to activate the desired colour field.

## Switch Teletext on/off

Teletext is not transmitted by all channels.

- (1) Select a channel that shows teletext.
- (2) Press . You will now see a teletext page. (If '100' is shown without any text information, it may mean that the channel you have selected does not support teletext.)
- (3) Press again to switch to split TV-teletext display mode. You will now see both the teletext page and the TV program.
- (4) Press once more to close the teletext screen.
- (5) Press again in order to switch on teletext again. The last page which was stored is now shown.

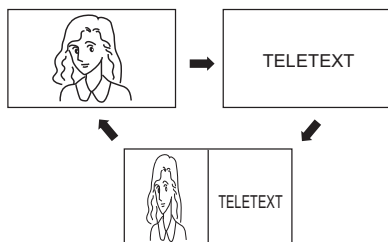

### Note:

- You cannot select any other channels as long as teletext is switched on. Switch teletext off when you want to switch over to another channel.

## Select Page

Press **CH** / until the page you desire appears. Or ... use the **10 Number Buttons** to enter the page number.

If you mistyped something, just enter the complete 3-digit wrong page number then enter the desired number again. Or ... press one of the coloured teletext buttons so the page from Fastext/TOPText will be shown.

## Hold Pages

Some pages are divided up into subpages by the channel.

Subpages are automatically shown in turn, as they are transmitted. In order to hold the page, press .

Press again in order to display the next subpage.

## Directly Select Subpages

Subpage numbers are displayed below the coloured bar.

Press / to select a subpage. Or, highlight the '' option to display subpages as they are transmitted. You can directly select the subpages if required.

Example:

On the screen below, page 197 offers the subpages service. At the bottom of the screen the subpages (01/02/03), available for page 197, are displayed.

To select a subpage:

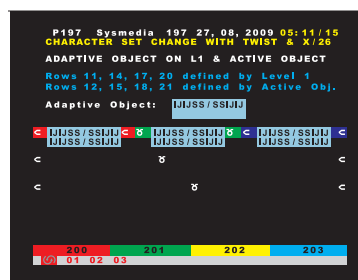

- (1) Press in order to select 01 subpage.
- (2) Press again in order to switch to the 02 subpage.
- (3) Press one more time to switch to the 03 subpage

## Enlargement

Press to enlarge the display.

Either the upper or lower half of the screen is enlarged.

Each time you press to toggle between half screen or full screen display.

## Answering Quiz Questions

Some pages contain quiz questions with concealed answers.

Press in order to show the answers.

## Page 100

Press **ENTER/CH LIST** in order to show page 100.

# Stereo reception with the built-in analog tuner

The built-in Tuner can detect and receive NICAM stereo broadcasts automatically.

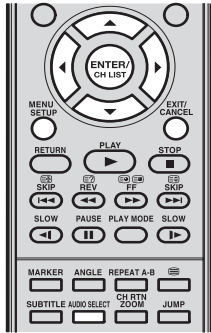

## Note:

- In case of bad reception, the stereo sound also can be disturbed.

## NICAM stereo sound reception:

- Press **MENU SETUP** to display the Main Menu screen. Press **▲ / ▼** to select "Sound", then press **ENTER/CH LIST** .
- Select "NICAM", then press **◀ / ▶** to select "Auto" or "Off". Select "Off" if you do not want to receive NICAM sound.
- Press **EXIT/CANCEL** to return to the normal screen.

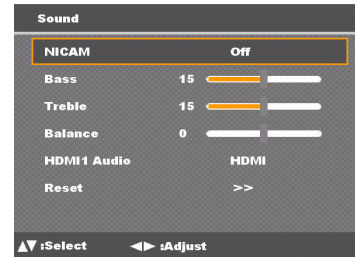

## The following types of broadcast are possible with NICAM transmissions

- 'NICAM ST' illuminates for approx. 4 seconds when a NICAM STEREO broadcast signal is received.
- 'NICAM M1' illuminates for approx. 4 seconds when a NICAM MONO A broadcast signal is received.
- 'NICAM M1/M2' illuminates for approx. 4 seconds when a NICAM MONO A and MONO B broadcast signal is received.
- This will be displayed for approx. 4 seconds if a NICAM signal is received when the 'NICAM Off' option is selected.

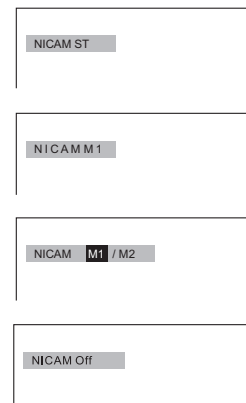

## Stereo reception

'STEREO' illuminates for approx. 4 seconds when a STEREO broadcast signal is received.



When 2-channel sound reception is available, you can select your preferred audio with the **AUDIO SELECT** button.

Each time you press **AUDIO SELECT** , the sound channel will switch to the alternative channel available.

## NICAM 2-channel sound reception



## 2-channel sound reception



# Picture format

The broadcaster may transmit a Wide Screen Signalling (WSS) signal which can determine the correct picture width and set it automatically when the 'Auto' setting is used. If you want to change this setting, you can select from the formats listed below.

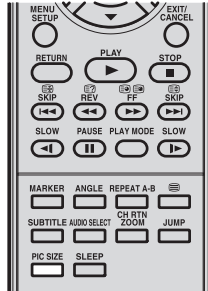

## Auto picture size

Press **PIC SIZE**  repeatedly until 'Auto' appears on-screen.

## Picture format setting

Press **PIC SIZE**  repeatedly to scroll through the following options.

### 4:3

This mode shows a picture in the standard 4:3 size with black side bars.

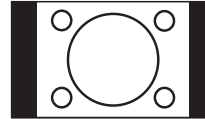

### Notes:

- When the picture size is set to Auto mode, the aspect ratio will automatically change according to the Wide Screen Signalling (WSS) signal, if it is available. This may either be transmitted by the broadcasting TV channel, or via a recording from a VCR etc. Any WSS signal received will only be effective in Auto mode. In any case if you want to change to a different aspect ratio to the one selected automatically, you can change it by pressing **PIC SIZE**.
- In PC mode, the picture size settings is available only for 16:9 or 4:3 format.
- In HDMI or Component mode of scanning rate: 720p and 1080i, the picture size settings is available only for 16:9.
- Using the special functions to change the size of the displayed image (i.e. changing the height/width ratio) for the purposes of public display or commercial gain may infringe on copyright laws.

### Full screen

Stretches the left and right hand sides of a 4:3 picture horizontally to fill the screen, while leaving the centre of the picture unstretched.

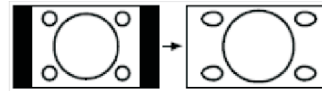

### 16:9

This mode is used with 16:9 signals from a Digital decoder, DVD player or other external source. The picture is uniformly stretched — a 4:3 image is horizontally stretched to fill the screen (For example, a 16:9 image is often stored 'anamorphically' on a DVD, where the 16:9 image is stored as a horizontally compressed 4:3 image - this mode restores the image to its correct 16:9 proportions).

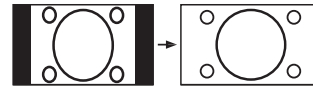

### Cinema

This mode is used to zoom-in on (expand) 4:3 'letterbox' format pictures (with black side bars on the top and bottom of the picture) so that they fill more of the screen.

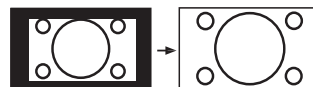

### Note:

- In the Cinema mode, part of the picture may be slightly cut off due to the expansion. However, it is possible to scroll the picture up or down to view the top or bottom part of the picture (see page 22).



### 14:9

This mode enlarges a standard 4:3 picture to the 14:9 format.



# Other convenience functions





You can change the default settings to convenience use.

Main menu	Selected items		Setup hint
Picture 	Picture Setting	Brightness/ Contrast/ Sharpness/ Colour/ Tint	You can adjust the picture to your preference. The 'Tint' option can be selected if an NTSC 3.58MHz or NTSC 4.43MHz signal is input through one of the AV inputs, and NTSC or AUTO has been selected for the AV COLOUR option.
		Colour Temperature	Bluish (Cool)/Neutral (Standard)/Reddish (Warm)
		Backlight	You can use the Backlight feature to adjust the screen brightness for improved picture clarity.
	Picture Preference	Sports	Bright and dynamic picture (factory-set)
		Standard	Standard picture quality (factory-set)
		Movie	Movie-like picture setting (factory-set)
		Memory	Your personal preferences
	Picture size	Auto/ 4:3/ Full Screen/ 16:9/ Cinema/ 14:9	You can choose from six picture formats to view programmes.
	Blue Back	On/Off	You can set the TV to automatically change to a blue screen and mute the sound if the signal is weak or absent.
	PC Setting* <sup>1</sup>	Hor Position	Adjust the image position horizontally.
		Ver Position	Adjust the image position vertically.
		Clock	Minimize any vertical bars or stripes visible on the screen background.
		Phase	This must be adjusted if the PC mode frequency has been set to 60 Hz. This will optimize picture quality.
Auto Adjust		Adjust all the PC settings automatically.	
DNR* <sup>2</sup>	On/Off	Sometimes it is not possible to input a high-quality HD signal. The actual signal input is too small and noisy, e.g. a video film in letterbox format, or a noisy analog cable TV signal. DNR can slightly reduce interferences caused by the faulty input signal.	
Reset		Select "Reset" to reset Picture Setting to the factory preset values.	
Sound 	NICAM	Auto/Off	See page 20.
	Bass/Treble/Balance		You can adjust the sound quality to your preference.
	HDMI Audio (19DV615Y/22DV615Y)/ HDMI1 Audio (26DV615Y)		You can choose the appropriate HDMI audio input setting for the digital audio or video device.
	Reset		Select "Reset" to reset Sound settings to the factory preset values.
Channel 	Auto Tuning		See page 14.
	Manual Tuning		See page 16.
	Ch Allocation		See page 14.

\*1 The PC Setting option can be configured only when the TV tuner input is set to PC mode.

\*2 In HDMI or Component (except 480i/576i) mode, the DNR option cannot be selected.

## Other convenience functions (continued)

Main menu	Selected items	Setup hint
Setup 	Language	See page 13.
	Timer Setting* <sup>1</sup>	View the current time settings. See page 24.
	Password Setup* <sup>2</sup>	Set password for TV programmes and movies.
	Version	View the hardware and software version information.
	Vertical Position	When the Cinema mode is selected (see page 21), you can adjust the vertical picture position. Press ◀/▶ to adjust the vertical position of the picture by up to +10 and downwards by up to -10.
	Auto 4:3 Default* <sup>3</sup>	4:3/16:9 This option selects the default way that a 4:3 signal is shown - either as normal "4:3" or expanded in the "16:9" mode, according to your preferences.
	Display Setup* <sup>2</sup>	See page 24.
	Auto Shut Off	On/Off This option automatically shuts the TV off after 15 minutes of non-operation when the last viewed TV channel stops broadcasting.
	AV Colour* <sup>4</sup>	Auto/ PAL/ SECAM/ NTSC4.43/ NTSC3.58/ PAL60 The AV Colour setting only applies when viewing devices connected to the AV inputs.
	Reset	Select "Reset" to reset TV settings to the factory preset values.  (1) Press <b>ENTER/CH LIST</b>  to enter the Reset TV setting screen. (2) Press ◀/▶ to select "Yes", then press <b>ENTER/CH LIST</b>  . (3) Reset the TV function will now begin, and this unit will automatically turn off. As the power is not automatically turned on, press  to watch TV.

\*1 Timer Setting option can be configured only when the TV tuner input is set to DTV mode.

\*2 The Password Setup and Display Setup option can be configured only when the TV tuner input is set to DTV mode.

\*3 Auto 4:3 Default is available only for AUTO picture size setting.



In Component mode, AUTO 4:3 Default is available only for 480i/576i mode.

\*4 PAL is the colour system used in Australia. NTSC 3.58 is used in the USA, PAL 60 used in Germany handled video recorders, which play NTSC video tape recording. If the picture shows horizontal stripes, set to Auto.

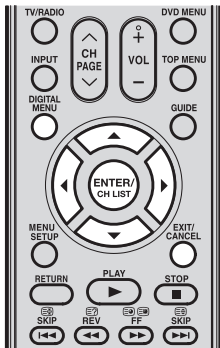
# Display setup/Timer setting (DTV mode only)



## Display Setup

- 1 Press **DIGITAL MENU**  to display the Main Menu screen.
- 2 Press **▲ / ▼** to select "Setup" menu, then press **ENTER/CH LIST** .
- 3 Press **▲ / ▼** to select "Display Setup", then press **ENTER/CH LIST** . The Display Setup menu appears.





- 4 Press **▲ / ▼** to select an item, then press **◀ / ▶** to change each setting.

Banner timeout	1 sec, 2 sec... 7 sec.	Select how long the service banner information appears on the screen.
Banner position	Top Bottom	Select whether the service banner information appears on the top or bottom of the screen.

- 5 After all the changes are made, press **EXIT/CANCEL**  to return to the normal screen.

## Timer Setting

If the time displayed on the Channel banner differs from the actual time, it can be corrected.

- 1 Press **DIGITAL MENU**  to display the Main Menu screen.
- 2 Press **▲ / ▼** to select the "Setup" menu, then press **ENTER/CH LIST** .
- 3 Press **▲ / ▼** to select "Timer Setting", then press **ENTER/CH LIST** .

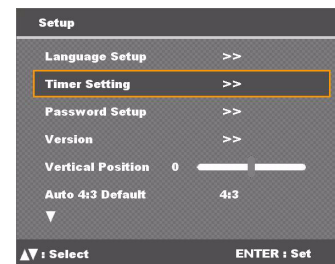

- 4 If the time displayed on the Channel banner differs from the actual time, adjust the time offset with the **◀ / ▶** button until the correct time is shown.

### Note:

- Normally, this would be done by selecting "Auto".



- 5 After all the changes are made, press **EXIT/CANCEL**  to return to the normal screen.





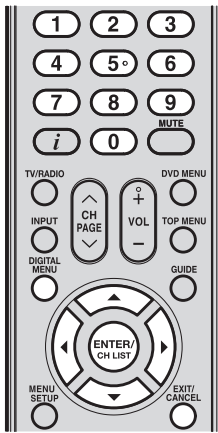

# Password setup (Parental lock) (DTV mode only)





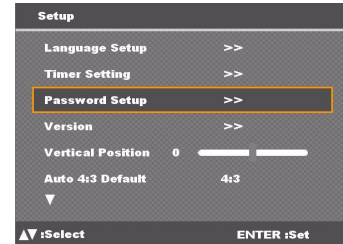

## Password Setup (Parental lock)

This feature allows you to have a parental control of the service viewing as per your preference. Once a service is protected with a password, it cannot be viewed unless the correct password is provided.

- 1 Press **DIGITAL MENU**  or **MENU SETUP**  to display the Main Menu screen.
- 2 Press **▲ / ▼** to select the "Setup" menu, then press **ENTER/CH LIST** .  
Press **▲ / ▼** to select "Password Setup", then press **ENTER/CH LIST** .  
The Enter Password window appears.



- 3 Use the **Number buttons (0–9)** to key in "0000". This is the factory default password.
- 4 Press **▲ / ▼** to select "Parental Lock", then press **ENTER/CH LIST** .  
Press **▲ / ▼** to select a desired parental rating, then press **ENTER/CH LIST** .  
See Notes.  
Press **EXIT/CANCEL**  to return to the normal screen.
- 5 You can also change the password using the Change Password option.  
Press **▲ / ▼** to select "Change Password", then enter a new password (0 to 9).  
Make sure to remember this password.  
Re-enter the same password again for confirmation.  
Press **EXIT/CANCEL**  to return to the normal screen.

### Notes:

- The rating level is based on the viewer's age.
  - C: Children can watch
  - G: Suitable for all ages
  - PG: Parental guidance for pre-teen viewers
  - M: Mature audience 15+
  - MA: Mature Adult Audience 15+
  - AV: Adult audience, Strong violence 15+
  - R: Suitable for adults only
- You will be prompted to enter the password, when you set new parental rating.  
You can set the new parental rating only when you enter the password correctly, otherwise the old parental code will be retained.

**IMPORTANT NOTE ON RESETTING THE PASSWORD**  
We suggest that you remove the following instruction from the operating instructions to prevent children from reading it.

If you forget your password, follow instruction below to reset the password.

Press **i** 4 times within 5 seconds while the TV is in password input mode. This allows you to reset your password.

# Version

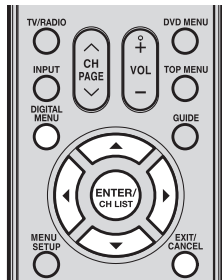





## Note:

- Version check also applies to ATV mode.

## Version

You can check the software version information.

- 1 Press **DIGITAL MENU**  or **MENU SETUP**  to display the Main Menu screen.
- 2 Press **▲ / ▼** to select the "Setup" menu, then press **ENTER/CH LIST** .
- 3 Press **▲ / ▼** to select "Version", then press **ENTER/CH LIST** .

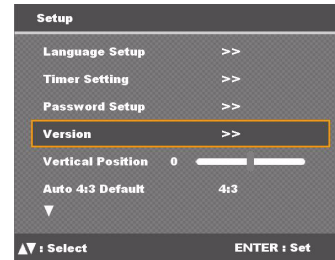

The software version is displayed.



- 4 Press **EXIT/CANCEL**  to return to the normal screen.

# Multi audio/DVB-Subtitle (DTV mode only)

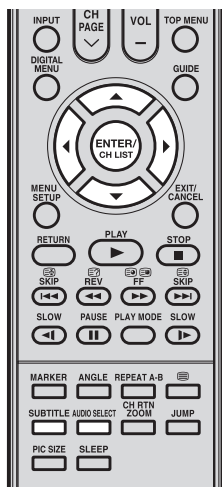

## Note:

- DVB-Subtitle can also be changed by pressing **SUBTITLE** repeatedly.

## Multi audio

You can select your preferred Audio mode and DVB (digital TV) subtitle language. The Multi audio menu will display the Audio mode and Language options available with the current broadcast.

- 1 Press **AUDIO SELECT**  to display the Multi audio menu.  
The Audio mode and Language code will be displayed if available.



- 2 Press **◀ / ▶** to select Audio mode.  
The Audio mode options include: Stereo, Left, Right and L + R.



- 3 Press **▲ / ▼** to select a Language Code in the Language code list.
- 4 When different audio tracks are being broadcast from the left and right channels, select "Left" or "Right" in the Audio mode option.
- 5 Press **EXIT/CANCEL**  to return to the normal screen.

## DVB-Subtitle

DVB-Subtitle is a feature supported in DVB (Digital Video Broadcasting) applications in which the service shown can be accompanied by a text display on the screen in parallel with the corresponding audio service. The DVB-Subtitle feature can be enabled or disabled at anytime.

- 1 Press **SUBTITLE**  to display the Subtitle menu.

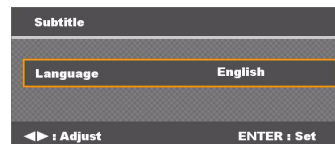

- 2 Press **◀ / ▶** to select your desired subtitle language from the available languages.
- 3 To disable DVB-Subtitle, press **◀ / ▶** repeatedly until 'Off' appears in the Subtitle menu.



- 4 Press **EXIT/CANCEL**  to save the subtitle language.

# EPG (Electronic Program Guide) (DTV mode only)

The Guide menu shows the available programme listings for the next 8 days only, including today. However, the guide menu will show 'No Event Name' for programmes which are more than 8 days ahead, or for programmes within the 8 days when no programme information is available.

- 1 Press **GUIDE**  to display the EPG menu.

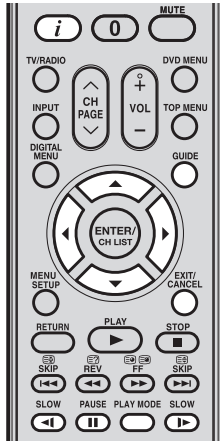
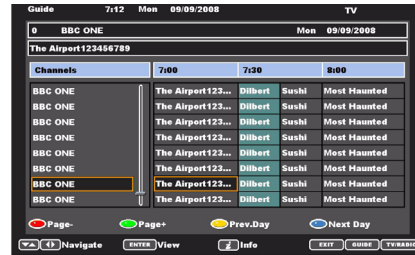

- **Service List**  
Displays all the available services.  
As you scroll through the service list by pressing **▲ / ▼**, the Event list will be refreshed accordingly, and you will see the programme information for the currently highlighted programme.  
To scroll through the service list from page to page, press the **Red/SLOW ◀** or **Green/PAUSE** button.
- **Events list**  
Displays events in a grid of rows and columns.  
Each row shows the list of events that are available, for the corresponding service in the service list. Within each row, you can press to navigate through the rest of the events.  
You can easily move to the Previous day or Next day in the Events List by pressing the **Yellow/PLAY MODE** or **Blue/SLOW ▶** button (the date of the programme information you are currently viewing is shown in the top right hand corner).  
The full event name will be displayed in the bar above. Event title will be displayed only if available otherwise 'No Description' message will be displayed.

- 2 From within the Guide menu, you can open the Description menu for the currently highlighted programme by pressing **(i)**.

The Guide/Description menu shows the extended event description of an event. You can scroll and view the complete event description of the event using **▲ / ▼**.

To return to the Guide menu, press **(i)**.

To clear the menu screen, press **EXIT/CANCEL** .

# EPG Timer (DTV mode only)

If you try to switch to another channel while a timer event is in progress, the following message will appear: 'Warning: Changing the channel will interrupt your event timer. Are you sure you want to proceed? Yes/No'. Select "Yes" or "No" according to your wishes.

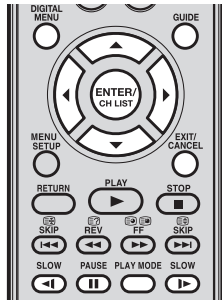

1 Press **GUIDE**  to display the EPG menu.

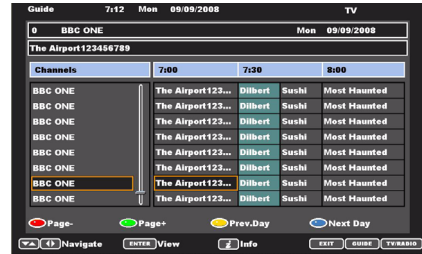

2 Press **▲/▼/◀/▶** to highlight the programme you want to set as a timer event, then press **ENTER/CH LIST** .

### Notes:

#### Notes:

- When the EPG Timer starts, the message 'Event Timer Started' will appear.
- If the EPG Timer starts when it is already switched on, it will start at the exact time that is set. If it starts from the standby mode, it will begin 20 seconds in advance of the stated time.
- You cannot hasten the start time from the original start time of the Event.
- You cannot set with the same date and time of another Event.
- Press the **Yellow/PLAY MODE** button to change the start time of the event.
- Press the **Blue/SLOW**  button to change the time duration of the event.
- When in power-off-condition, EPG Timer cannot be activated.

- If you select an event which has already started, the selected programme will be displayed on the screen, as you cannot set the timer for a programme which has already started.
- To display the stored timer events, press **GUIDE** twice. The Event Timer menu (see step 3 below) will appear. You can also delete or change the frequency (Once / Daily /Weekly) of the stored timer events (but please note that you cannot edit the time details that have been set from the EPG).

3 A confirmation banner will be displayed. Press **◀/▶** to select 'Yes' or 'No', then press **ENTER/CH LIST**  (the selected option is shown in blue).

4 The Event Timer menu will appear. Press the **Red/SLOW**  button to set the Timer mode for a selected event.





5 The Timer mode specifies the frequency of Timer wake-up which can be set as Once, Daily or Weekly. Press **ENTER/CH LIST**  to save the selected Timer mode.

### Note:

To delete a timer event, select the specified event, then press the **Green/PAUSE** button.



6 To return to the EPG menu, press **ENTER/CH LIST** . To clear the menu screen, press **EXIT/CANCEL** .

# Disc

DVD discs must be Region 4 or Region ALL type to play on this unit.

The suitable disc formats are: DVD-Video, DVD-R/-RW (Video format only), Audio CD, CD-R/CD-RW and Video CD.

Some CD-R/RW discs may be incompatible.

- This unit can play an 8cm disc. Please do not use a disc adapter. It may cause trouble.
- Please do not insert any disc of an irregular shape into the unit, as it may interfere with the function of the unit. You may not be able to remove it.
- Please do not use after market accessories, such as a ring protector, as this may cause trouble with the operation of the unit.

Do not play DVD-ROM, DVD-Audio, CD-G, Photo CD or SVCD to prevent accidental erasure of prerecorded material.

## Title

When two or more movies are recorded on a disc, the disc is divided into two or more sections. Each section is called a TITLE.

## Chapter

The titles can be subdivided into many sections. Each section is called a CHAPTER.

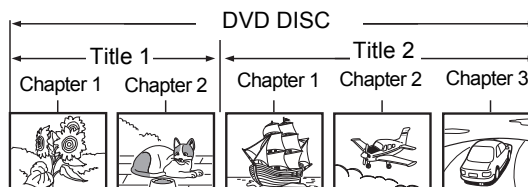

## Track

Video CD/Audio CD can contain several items.

These are assigned to tracks.

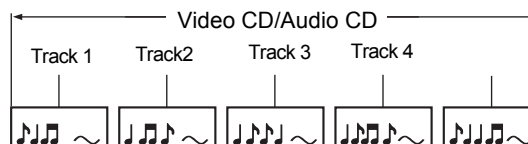

## Removing disc from case

Be sure to hold the edge of disc. Do not touch the surface of the disc.

Pick up the disc gently from the case.

- Do not scratch the disc.
- Do not get dirt on the surface of the disc.
- Do not stick a label or adhesive tape on the disc.
- Do not drop or bend the disc.

## Storing disc

- Store the disc in the case to avoid risk of scratches, dirt or damage.
- Do not leave disc exposed to direct sunlight or in hot or humid places.

## Cleaning disc

Wipe the disc with a clean, dry cloth from center to edge.



- Do not wipe in circular direction.
- Do not use liquid or aerosol cleaners.

## On Video CDs

This unit supports Video CDs equipped with the PBC (Version 2.0) function. (PBC is the abbreviation of Playback Control.) You can enjoy two playback variations depending on types of discs.

- Video CD not equipped with PBC function (Version 1.1) Sound and movie can be played on this TV/DVD in the same way as an audio CD.
- Video CD equipped with PBC function (Version 2.0) In addition to operation of a Video CD not equipped with the PBC function, you can enjoy playback of interactive software with search function by using the menu displayed on the TV screen (Menu Playback). Some of the functions described in this owner's manual may not work with some discs.

## To turn off the PBC

- (1) Press **PLAY MODE**  in the Stop mode.
- (2) Press **▲ / ▼** to select "Mode", then press **ENTER/CH LIST**  repeatedly until 'Normal' appears.
- (3) Press **PLAY MODE**  again to clear the screen.

## To turn on the PBC

Follow the above step 1 ~ 2, then press **ENTER/CH LIST**  repeatedly until 'PBC' appear.

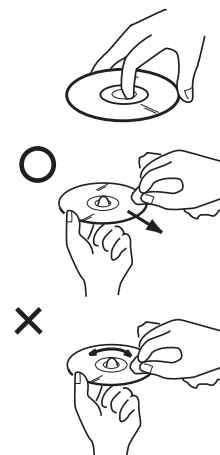

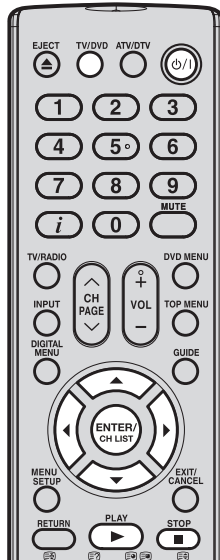

# Playing a disc

This section shows you the basics on how to play a disc



## Basic playback (DVD/VCD/Audio CD)

### Preparation:

- 1 Press **POWER** on the unit or  on the remote control.
- 2 Press **TV/DVD**  on the remote control to select the DVD mode.  
The DVD startup screen appears on-screen.



- 3 Load the disc in the disc slot with the label side facing forward.  
(If the disc has a label.)

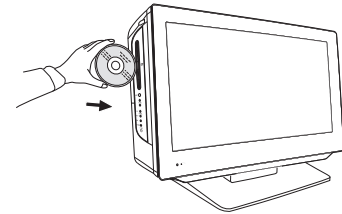





### Note:

- Do not place a disc which is unplayable in this unit.

- 4 On the TV-screen, **▲** changes to 'Reading' and then playback commences.
  - A menu screen will appear on the TV screen if the disc has a menu feature.
  - Press **▲ / ▼ / ◀ / ▶** to select title, then press **ENTER/CH LIST** . Title is selected and play commences.



- 5 To stop playback, press **STOP** .
  - The unit records the stopped point, depending on the disc.  appears on the screen. Press **PLAY**  to resume playback (from the scene point).
  - If you press **STOP**  twice (' Stop' appears on the screen.), the unit will clear the stopped point.

### Notes:

- **If the unit does not operate properly:** Static electricity, etc., may affect the player's operation. Disconnect the AC power cord once, then connect it again.
- If a disc is inserted during some modes other than DVD mode, it may switch to DVD mode and then playback may be begun automatically.
- **About inserting disc:** If the unit is slanted or moved while inserting disc, the disc may get damage.

## Playing a disc (continued)

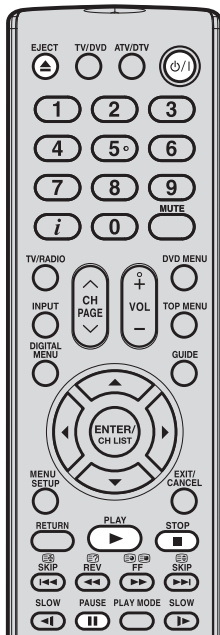

### To start playback in stop mode

Press **PLAY** ►.

### To pause playback (still mode)

Press **PAUSE** ■■ during playback.

### To continue playback from still mode

Press **PLAY** ►.

### To stop playback

Press **STOP** ■.

### To remove the disc

- 1 Press **EJECT** ▲.
- 2 Wait for the disc drive to eject the disc, then remove the disc from the slot.

#### Notes:

- If a non-compatible disc is loaded, 'Incorrect Disc', 'Disc region incorrect' or 'Enter Password' will appear on the TV screen according to the type of loaded disc. In this case, check your disc again (see pages 30 and 50).
- Some discs may take a minute or so to start playback.
- When you load a disc with the playback side facing backward, 'Reading' appears on-screen but it will be replaced by 'Incorrect Disc'. Eject the disc and load again making sure the playback side is now facing forward.
- Some discs may not work the resuming facility.
- Some playback operations of DVDs may be intentionally fixed by software producers. Since this unit plays DVDs according to the disc contents the software producers designed, some playback features may not be available. Also refer to the instructions supplied with the DVDs.
- Do not move the unit during playback. Doing so may damage the disc.
- In many instances, a menu screen will appear after playback of a movie is completed. Prolonged display of an on-screen menu may damage your television set, permanently etching that image onto its screen. To avoid this, be sure to press  on your remote control once the movie is completed.
- There may be a slight delay between the button is pressed and the function activates.



## Playing a disc (continued)

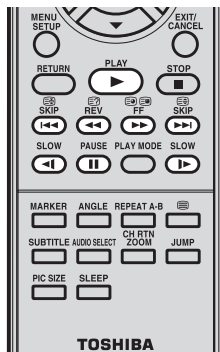

### Note:

- The prohibition symbol "X" appears on the upper right corner of the screen when you try to employ a playback function that is not available on the disc, or that is not yet accessible at this time. This does not indicate a problem with the TV/DVD.

You can play discs at various speeds.

### Playing in fast reverse or fast forward direction (DVD/VCD/Audio CD)

- 1 Press **REV** ◀◀ / **FF** ▶▶ during playback.
  - **REV** ◀◀: Fast reverse playback
  - **FF** ▶▶: Fast forward playbackEach time you press **REV** ◀◀ / **FF** ▶▶, the playback speed changes.
- 2 To resume normal playback, press **PLAY** ▶.

#### Notes:

- The sound is muted during reverse and forward scan of DVD/VCD discs.
  - The playback speed may differ depending on the disc.
- You can use fast reverse/fast forward playback for MP3/DivX<sup>®</sup> CD.

### Playing frame by frame (DVD/VCD)

- 1 Press **PAUSE** || during playback.  
Each time you press **PAUSE** ||, the picture advances one frame.
- 2 To resume normal playback, press **PLAY** ▶.

#### Notes:

- You can use frame by frame playback for DivX<sup>®</sup> CD.
- The sound is muted during frame by frame playback.

### Playing in slow motion (DVD/VCD)

- 1 Press **SLOW** ◀| / **SLOW** |▶ during playback.
  - **SLOW** ◀|: Slow reverse playback
  - **SLOW** |▶: Slow forward playback
- 2 Each time you press **SLOW** ◀| / **SLOW** |▶, the slow motion speed changes.
- 3 To resume normal playback, press **PLAY** ▶.

#### Notes:

- The sound is muted during slow-motion playback.
- You can use slow forward playback for DivX<sup>®</sup> CD.
- The slow reverse playback function is not available for DivX<sup>®</sup> CD.

### Locating a chapter or track (DVD/VCD/Audio CD)

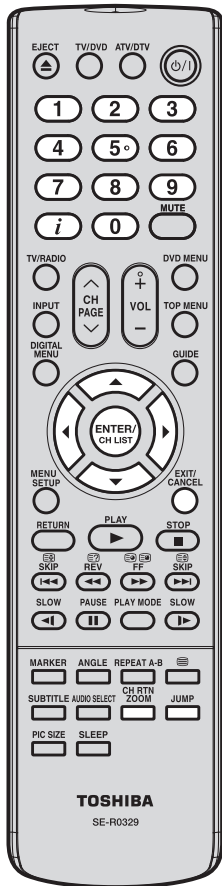

- 1 Press **SKIP** |◀◀ / ▶▶| repeatedly to access the chapter or track number you want to play. Playback starts from the current chapter or track.
- 2 To locate succeeding chapters or tracks, press **SKIP** ▶▶|. Playback starts from the beginning of the selected chapter or track.
- 3 To locate the preceding chapter or track, press **SKIP** |◀◀ twice in quick succession. Playback starts from the beginning of the preceding chapter or track.

# Zooming/Locating desired scene



## Zooming (DVD/VCD)

This unit will allow you to zoom in the frame image. You can then make selections by switching the position of the frame.





- 1 Press **CH RTN ZOOM**  during playback. The view will zoom into the center of the image. Each press of the button will increase the scale value: Q1(x 1.3), Q2 (x 1.5) and Q3 (x 2.0). 
- 2 Press **▲ / ▼ / ◀ / ▶** to pan the scene and view different sections of the picture.
- 3 To return to normal view, in zoom mode, press **CH RTN ZOOM**  repeatedly until 'Q Off' appears.

### Notes:

- You can use the Pause or Slow functions in Zoom mode.
- Some discs may not respond to zoom feature.
- You can use the Zoom function for DivX® CD.

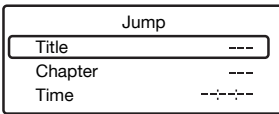
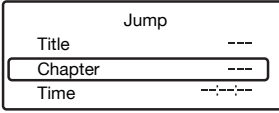
## Locating a desired scene (DVD/VCD/Audio CD)

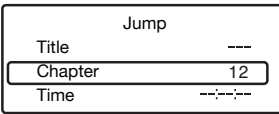
Use the title, chapter and time recorded on the DVD disc to locate the desired point to playback. In the case of VCD/Audio CD discs, time and track are used to locate the desired point to playback. To check the title, chapter/track and time, press **i**.

- 1 Press **JUMP**  during playback or stop mode. 
- 2 Press **▲ / ▼** to select the "Title/Track", "Chapter" or "Time" option. 
- 3 Use the **Number buttons (0-9)** to input the number. If you input a wrong number, press **EXIT/CANCEL** . Refer to the package supplied with the disc to check the numbers. 
- 4 Press **ENTER/CH LIST**  to start playback.
  - When you change the title, playback starts from Chapter 1 of the selected title.
  - Some discs may not work in the above operation.

### Notes:

- In case of the Audio CD and Video-CD, only Track and Time can be selected.
- In case of the Video-CD playback with PBC, the JUMP does not work. Turn off the PBC (see page 30).
- Only Time search function can be used for DivX® CD.

# Marking desired scenes

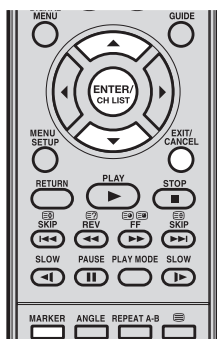

## Marking the scenes (DVD/VCD/Audio CD)

Scene bookmarks refers to specific points in the playback range that has been marked for later access. You can create up to three markers per disc.

- 1 Press **MARKER**  at the scene where you would like to place the bookmark.

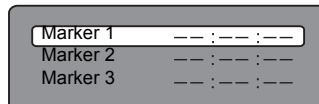

- 2 Press **▲ / ▼** to select a blank marker, then press **ENTER/CH LIST**  to bookmark the selected scene.

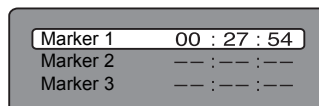

### Notes:

- Some discs may not work with the marking operation.
- The saved scene bookmarks are only accessible during the current session. Once you eject the disc or turned off the TV/DVD, all bookmarks will be cleared.
- In some cases, subtitles for the marked scene may not appear.
- Bookmark function does not work with MP3/JPEG CD/DivX® CD.

- 3 Press **MARKER**  to close the Bookmark window.

- 4 To save two more bookmarks, repeat steps 1 to 3.

## Returning to the scenes (DVD/VCD/Audio CD)

- 1 Press **MARKER**  during playback or stop mode.

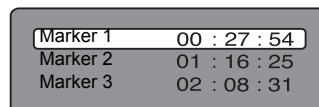

- 2 Press **▲ / ▼** to select the saved marker.

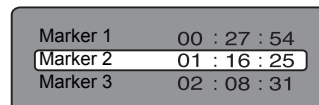

- 3 Press **ENTER/CH LIST**  to start playback on the scene saved in the selected bookmark.

- 4 To delete a scene bookmark, perform steps 1 ~ 2, then press **EXIT/CANCEL** .

# Repeat playback/A-B Repeat playback

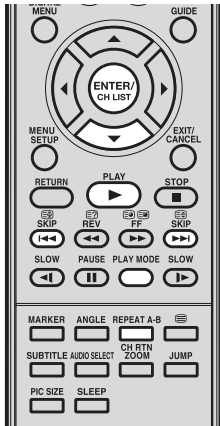

## Repeat playback (DVD/VCD)

- 1 Press **PLAY MODE**  during playback or stop mode.
- 2 Press **ENTER/CH LIST**  repeatedly to select "Chapter" or "Title".

### [Video CD]

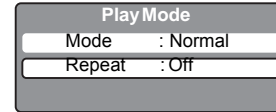

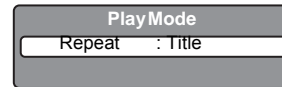

- 3 Press **▲ / ▼** to select "Repeat", then press **ENTER/CH LIST**  repeatedly to select a repeat mode. Playback automatically applies after the current track is finished.

### [DVD]





#### Note:

- If you set the repeat mode during stop mode, press **PLAY**  to start playback.

- 4 Press **PLAY MODE**  again to close the Play Mode window. To resume normal playback, select "Off" in step 2.

#### Notes:

- Some discs may not work with the repeat operation.
- The repeat playback function is cancelled when the **SKIP**  / **SKIP**  buttons are pressed.

## A-B Repeat playback (DVD/VCD/Audio CD)

The A-B repeat function lets you repeat a specific section between two set points.

- 1 Press **REPEAT A-B**  at the point where you would like the playback loop to begin. This sets your 'A' point.



- 2 When the playback reaches the point where you would like the playback loop to stop, press **REPEAT A-B**  again. This sets your 'B' point.

This section between points A and B will be played repeatedly in a loop until you turned off the Repeat A-B mode.



- 3 To resume normal playback, press **REPEAT A-B**  until 'Off' appears on the screen.

#### Notes:

- In A-B Repeat mode, subtitles near the A or B locations may not be displayed.
- You may not be able to set A-B Repeat during certain scenes of the DVD.
- A-B Repeat does not work with an interactive DVD and JPEG CD.

# Changing angles/Title selection/DVD menu

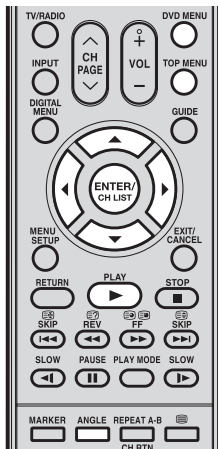

## Changing angles (DVD)

When playing back a disc recorded with multi-angle scenes, you can select the scene angle that you prefer.

- 1 Press **ANGLE**  during playback. The current angle will appear.





- 2 Press **ANGLE**  repeatedly until the desired angle is displayed.

### Note:

- Depending on the DVD, you may not be able to change the scene angle even if multi-angle data are recorded on the DVD.

## Title selection (DVD)

Some DVDs contain two or more titles. If this is the case, you can select a particular title for playback.



- 1 Press **TOP MENU**  during playback. Title menu appears on the screen.
- 2 Press **▲ / ▼ / ◀ / ▶** to select the desired title.
- 3 Press **ENTER/CH LIST**  or **PLAY**  to start playback.

### Notes:

- Depending on the DVD, you may not be able to select the title.
- Depending on the DVD, a "title menu" may simply be called a "menu" or "title" in the instructions supplied with the disc.

## DVD menu (DVD)

Some DVDs have an encoded menu that allows you to select a specific disc content, enable a particular DVD feature (e.g. subtitle or soundtrack language), or choose a particular title (for multi-title DVDs).

- 1 Press **DVD MENU**  during playback. The DVD menu appears on the screen.
- 2 Press **▲ / ▼ / ◀ / ▶** to select a menu item, then press **ENTER/CH LIST** . Use the same keys to enable an option for the selected item. Repeat this step to configure other menu options.
- 3 Press **DVD MENU**  again to resume playback on the scene that was playing when you pressed **DVD MENU**.

### Note:

- Depending on the DVD, you may not be able to resume playback from the same scene that was playing when you pressed **DVD MENU**.

# Changing soundtrack language/Subtitles/Disc status

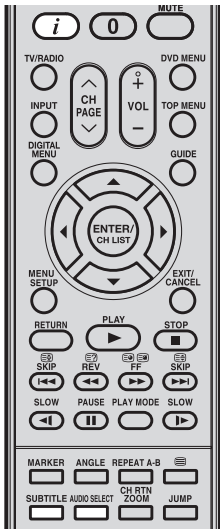

## Changing soundtrack language (DVD/VCD)

You can select the soundtrack language when you play a multilingual disc.

- 1 Press **AUDIO SELECT** during playback. The current soundtrack language will appear.
- 2 Press **AUDIO SELECT** repeatedly until the desired language is selected. The on screen display will disappear after a few seconds.

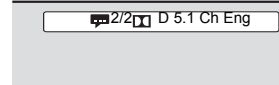

### In case of Video CD playback

Audio type changes are as follows each time you press **AUDIO SELECT** .



## Subtitles (DVD)

When playing back a disc recorded with subtitles, you can select the subtitle language or turn the subtitle off.

- 1 Press **SUBTITLE** repeatedly during playback until the desired language is selected.
- 2 To turn off the subtitle, press **SUBTITLE** until 'Off' appears. The on screen display will disappear after a few seconds.

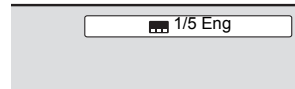

### Notes:

- If the desired language is not heard after pressing the button several times, that language is not recorded on the disc.
- The soundtrack language selected is cancelled when you eject the disc. The initial default language or available language will be heard if the disc is played back again.
- Depending on the DVD, you may not be able to change subtitles, or to turn subtitles on or off.
- While playing a DVD, the subtitle may change when you loaded or eject the disc.
- In some cases, a selected subtitle language may not be changed immediately.

## Disc status (DVD/VCD)

Press to display the status of the disc.

To close the display panel, press .

### VCD mode



Press again.

### DVD mode

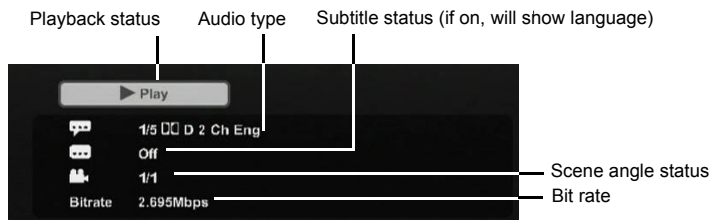
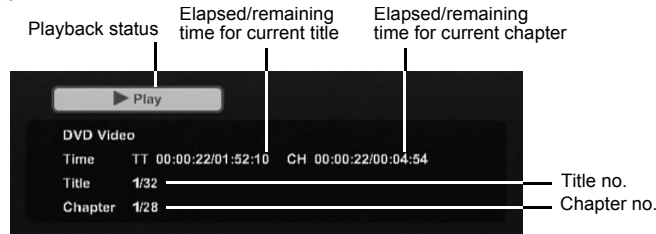

# MP3/JPEG/DivX<sup>®</sup> and Audio CD operation

This unit can playback the MP3/JPEG/DivX<sup>®</sup>-data which has been recorded on CD-R/RW. Audio CD also can be played back. To produce the MP3/JPEG/DivX<sup>®</sup>-data, you need a Windows-PC with CD-RW drive and a MP3/JPEG/DivX<sup>®</sup>-encoding Software (not supplied). The Apple-HFS-System cannot be played. This unit requires discs/recordings to meet certain technical standards in order to achieve optimal playback quality.

There are many different types of recordable disc formats (including CD-R containing MP3 files). Not all recordable discs will produce optimal playback quality. The technical criteria set forth in this instruction manual are meant only as a guide. Use of CD-RW for MP3 files is not recommended.

## MP3/JPEG/DivX<sup>®</sup> - data information

### Limitations on MP3/JPEG/DivX<sup>®</sup> playback

- MP3/JPEG/DivX<sup>®</sup> CD are standardized by ISO9660, its file name must include following extensions; “.mp3”, “.jpg”, “.div”, “.divx”, “.avi”.
- MP3/JPEG/DivX<sup>®</sup> CD must be corresponded to the ISO standardized files.
- This unit can read 2000 files per disc. If one disc has more than 2000 files, it reads up to 2000 files, the remaining files will be omitted.
- MP3/JPEG/DivX<sup>®</sup> CDs cannot be used for the purpose of recording on this unit.
- It may take more than one minute for this unit to read MP3/JPEG/DivX<sup>®</sup> files depending on its structure.
- Music recorded by “Joliet Recording Specification” can be played back.
- The music files recorded by “Hierarchical File System” (HFS) cannot be played.

### Limitations on displaying of the file name

- The maximum number for display is 15 characters. Long file names will be condensed.

### To playback MP3/JPEG/DivX<sup>®</sup> CD in the recorded order

- (1) Use MP3/JPEG/DivX<sup>®</sup> software that records data alphabetically or numerically.
- (2) Insert two or three digit number in the head of file name. (ex. “01” “02” or “001” “002”).
- (3) Refrain from making too many sub-folders.

### Caution:

- Some MP3/JPEG/DivX<sup>®</sup> CDs cannot be played back depending on the recording conditions.
- The CD-R/RW that has no music data or non MP3/JPEG/DivX<sup>®</sup> files cannot be played back.

## Standard sampling frequency and the bit rate

### MP3

- File format: MPEG-1 Audio
  - Sampling frequency: 32kHz, 44.1kHz, 48kHz
  - Bit rate: 32kbps ~ 320kbps (constant bit rate or variable bit rate)
- The recommend recording setting for a high-quality sound is 44.1kHz of sampling frequency and 128kbps of constant bit rate.

### DivX<sup>®</sup>

- Version: DivX<sup>®</sup> 3, 4, 5, and 6 (specifically 3.1.1, 4.1.2, 5.0.2, 5.0.5, 5.1.1, 5.2.1, 6.0 at Home Theater profile).
- File format: MPEG1 Layer2 (MP2), MPEG1 Layer3 (MP3)
- Sampling frequencies: 32kHz, 44.1kHz, 48kHz
- Bit rate: 32kbps ~ 320kbps
- Resolution: Max 720 x 576 (at 25fps), Max 720 x 480 (at 30fps)

### Notes:

- DivX<sup>®</sup> is a registered trademark of DivX, Inc., and is used under license.
- MPEG Layer-3 audio coding technology licensed from Fraunhofer IIS and Thomson.

# MP3/JPEG/DivX<sup>®</sup> and Audio CD operation (continued)

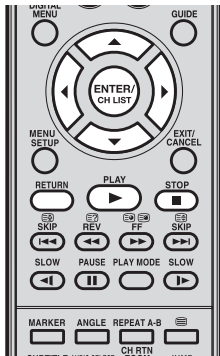

**Note:**

- The Repeat and Random/Programmed playback modes can be enabled during MP3 playback (See pages 43, 44).

## Loading CD

- 1 Load a MP3/JPEG/DivX<sup>®</sup> CD or an Audio CD into the disc slot.
- 2 A file browser screen will appear on the screen.
  - If the current directory has more than 8 files, press ▲ / ▼ to scroll the file list.
  - To see folder contents, select a folder and then press **ENTER/CH LIST**.
  - To return to the root directory, select “Go Up ...” then press **ENTER/CH LIST**.
  - If a CD contains a mixture of MP3, JPEG and DivX<sup>®</sup> files, and **PLAY** is pressed without selecting the file, playback automatically begins starting from the first file in the list. If there is no file on the root directory, playback does not start automatically.

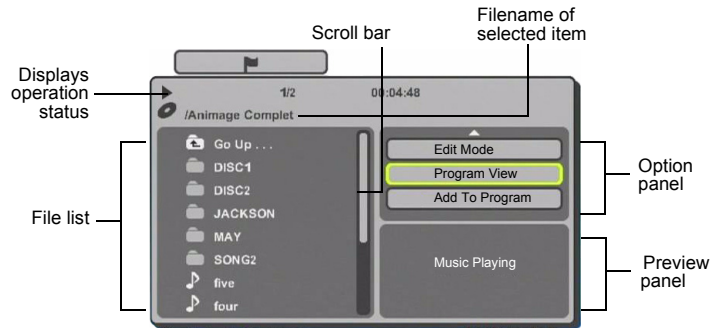

## MP3 and Audio CD playback

- 1 In the file browser screen, press ▲ / ▼ to select the desired file.
- 2 Press **ENTER/CH LIST** to start playback.
- 3 To stop playback, press **STOP**. The unit records the stopped point. '■' appears on the screen. Press **PLAY** to resume playback. If you press **STOP** again or unload the disc, the unit will clear the stopped point.



## Select files

You can choose the type of file listed in the file browser.

- 1 Press ◀ / ▶ to move the selection highlight to the Option panel.
- 2 Press ▲ / ▼ to highlight “Select files”, then press **ENTER/CH LIST**.
- 3 Press ▲ / ▼ to select a file type from the list (Audio, Photo or Video).



- 4 Press **ENTER/CH LIST** to add/remove check mark. Checked file type will be displayed in the file browser.
- 5 Press ◀ twice to move the selection highlight to the file list.

**Note:**

- Select files is not applicable to Audio CD.



# MP3/JPEG/DivX<sup>®</sup> and Audio CD operation (continued)

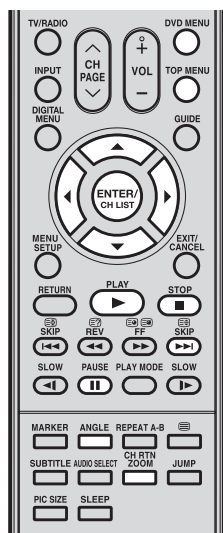

## Notes:

- The Jump and A-B Repeat modes are not available during JPEG-playback.
- When an image exceeds 5760 x 3840 pixels, the image display (preview window or thumbnail list) can appear cropped.
- It may have a longer interval period due to the size of data.

## JPEG playback

- 1 In the file browser screen, press **▲ / ▼** to select an image file for viewing.

A preview of the selected file displayed in the Preview panel.

To display a thumbnail list, press **DVD MENU** .

Press **▲ / ▼ / ◀ / ▶** to select the image file. (To return to the file browser, press **TOP MENU** .

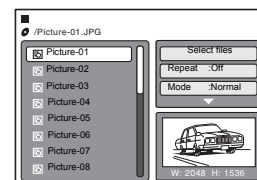

When **PLAY**  is pressed without selecting the file, playback automatically begins starting from the first file in the list.

- 2 Press **ENTER/CH LIST** .

The selected image is displayed in fullscreen mode.



## Rotating an image

You can rotate an image by 90°.

Press **ANGLE**  during playback of the image. Options include 90°, 180°, 270° or No rotation.

## Zooming an image

Zoom function also can be used in viewing JPEG files.

Press **ZOOM**  repeatedly until the preferred scale is displayed. The current zoom setting is indicated by the following icons: Q1 (x 1.3), Q2 (x 1.5) and Q3 (x 2.0).

To return to normal view, press **ZOOM**  repeatedly until 'Q Off' appears.

- 3 Press **STOP**  to end playback.









The file browser screen appears on the screen.

## Slide show playback

The slide show enables you to view multiple JPEG files one after another automatically.

### Preparation

Set "JPEG Interval" setting to "Off", "5 seconds", "10 seconds" or "15 seconds" (See page 49).

- 1 Select your desired starting file for the slide show in step 1 above.
- 2 Press **ENTER/CH LIST**  or **PLAY**  to start slide show. When the slide show is completed, the file browser screen appears.
  - To view the previous or next image in the slide show, press **SKIP**  / .
  - To temporarily stop the slide show, press **PAUSE** . '  ' appears on-screen. Press **PLAY**  or **SKIP**  again to resume the slide show.
  - To stop the slide show, press **STOP** . The file browser screen appears.

# MP3/JPEG/DivX<sup>®</sup> and Audio CD operation (continued)

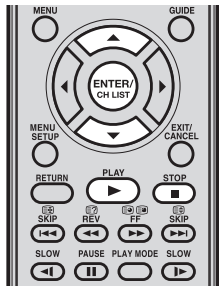

## DivX<sup>®</sup> playback

1 In the file browser screen, press ▲ / ▼ to select the desired file.  
When **PLAY** ► is pressed without selecting the file, playback automatically begins starting from the first file in the list.

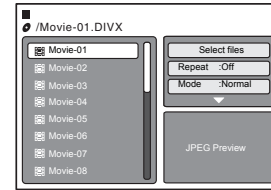

2 Press **ENTER/CH LIST** (ENTER/CH LIST) or **PLAY** ► to start movie playback.

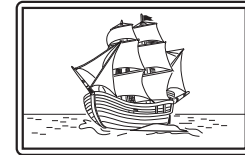

### Note:

- Depending on the recording conditions of DivX<sup>®</sup> file, you may not be able to use the Fast Reverse and Fast Forward playback and Jump functions. (See pages 33, 34.)

3 To stop playback, press **STOP** ■.  
The unit records the stopped point. '■' appears on the screen. Press **PLAY** ► to resume playback. If you press **STOP** ■ again or unload the disc, the unit will clear the stopped point.

## Playing DivX<sup>®</sup> VOD content

**ABOUT DivX<sup>®</sup> VIDEO:** DivX<sup>®</sup> is a digital video format created by DivX, Inc. This is an official DivX certified device that plays DivX video. Visit [www.divx.com](http://www.divx.com) for more information and software tools to convert your files into DivX video.

**ABOUT DivX<sup>®</sup> VIDEO-ON-DEMAND:** This DivX Certified<sup>®</sup> device must be registered in order to play DivX Video-On-Demand (VOD) content. To generate the registration code, locate the DivX VOD section in the device setup menu. Go to [vod.divx.com](http://vod.divx.com) with this code to complete the registration process and learn more about DivX VOD. (See page 51).

# MP3/JPEG/DivX<sup>®</sup> and Audio CD operation (continued)

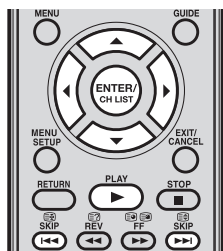

## Repeat playback (Audio CD/MP3/JPEG/DivX<sup>®</sup>)

- 1 In the file browser screen, press ► to move the selection highlight to the Option panel.
- 2 Press ▲ / ▼ to select "Repeat".

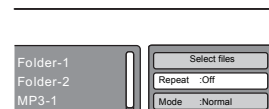

- 3 Press **ENTER/CH LIST** repeatedly to select a repeat mode, "Track" or "All".

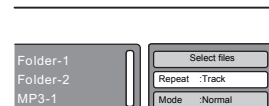

### Notes:

- The repeat or random function is cancelled when you eject the disc or turn the power off.
- In case of Audio CD, the function of A-B Repeat also can be used. See "A-B Repeat playback" (page 36).

- 4 Press **PLAY** ►.  
The unit automatically starts repeat playback after finishing the current track.
- 5 To resume normal playback, select "Off" in step 3.

## Random playback (Audio CD/MP3/JPEG/DivX<sup>®</sup>)

- 1 In the file browser screen, press ▲ / ▼ to select "Mode".
- 2 Press **ENTER/CH LIST** to select "Shuffle".
- 3 Press **PLAY** ►.  
The Random playback automatically starts.

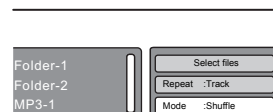

- 4 To resume normal playback, select "Normal" in step 2.

## Music Intro (Audio CD/MP3)

The Music Intro function plays the first 10 seconds of all the files on the current folder or all tracks on the disc.

- 1 In the file browser screen, press ▲ / ▼ to select "Mode".
- 2 Press **ENTER/CH LIST** to select "Music Intro".
- 3 Press **PLAY** ►.  
The unit starts to play each track on the disc for 10 seconds.
- 4 To resume normal playback, select "Normal" in step 2.

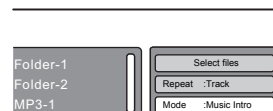

# MP3/JPEG/DivX<sup>®</sup> and Audio CD operation (continued)

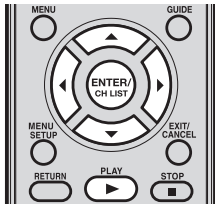

## Programme playback (Audio CD/MP3/JPEG/DivX<sup>®</sup>)

- 1 In the file browser screen, press ► to move the selection highlight to the Option panel.
- 2 Press ▲ / ▼ to select "Edit Mode", then press ENTER/CH LIST (ENTER/CH LIST) to enable it.



- 3 Press ◀ to move the selection highlight to the file list, then press ▲ / ▼ to select a file.  
Press ENTER/CH LIST (ENTER/CH LIST) to mark it for inclusion in the programme playlist. Repeat this step to mark any other files you want to add to the programme playlist.

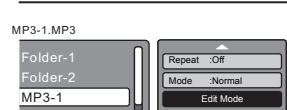

- 4 Press ▲ / ▼ | ◀ / ▶ to select "Add To Program", then press ENTER/CH LIST (ENTER/CH LIST) to add all marked files in the programme list. (The maximum number of files can be added is 30.)

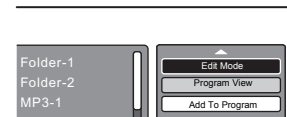

- After storing the files in the programme list, press ▲ / ▼ to select "Edit Mode", then press ENTER/CH LIST (ENTER/CH LIST) to disable it.
- 5 Press ▲ / ▼ to select "Program View", then press ENTER/CH LIST (ENTER/CH LIST). Program View shows only the programmed files that you have added in Step 4.

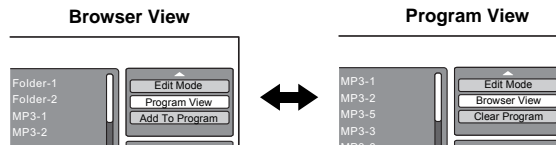

- 6 In the Program View, press PLAY ► to start playback via order the files were added.

### To remove file from the programme list in stop mode:

- 1 In Program View, press ▲ / ▼ to select "Edit Mode", then press ENTER/CH LIST (ENTER/CH LIST).
- 2 Press ◀ to go to the programme list.
- 3 Press ▲ / ▼ to select the file you want to remove, then press ENTER/CH LIST (ENTER/CH LIST).
- 4 Press ▲ / ▼ / ▶ to select "Clear Program", then press ENTER/CH LIST (ENTER/CH LIST).

#### Note:

- The program function is disabled when you eject the disc or turn the power off.

# Program playback/Random playback

You can arrange the playback order of tracks or files on the disc. And the unit can also select tracks or files at random and playback them. These feature works for Video CD. For Audio CD and MP3/JPEG/DivX® CD, please see "Random playback (Audio CD/MP3/JPEG/DivX®)" on page 43 and "Program playback (Audio CD/MP3/JPEG/DivX®)" on page 44.

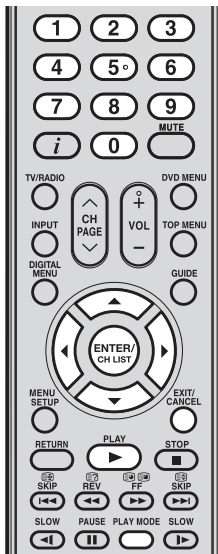

## Notes:

- In case of Video CD with PBC, you cannot set Program playback.
- The program is cancelled when you eject the disc or turn the power off.
- In case of Video CD with PBC, you cannot set Random function during playback.

## Program playback (VCD)

1 Press **PLAY MODE** during stop mode.



2 Press **▲ / ▼** to select "Mode", then press **ENTER/CH LIST** to select "Program".

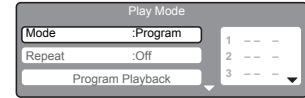

3 Press **◀ / ▶** to select the programming position. Use **Number buttons (0-9)** to input the track numbers sequentially. If you input a wrong number, press **EXIT/CANCEL** .

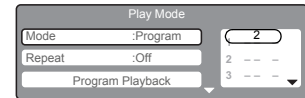

4 Press **◀ / ▶** to return to the left column, then press **▲ / ▼** to select the "Program Playback" and press **ENTER/CH LIST** . The programmes you selected will start to playback in order.

5 To resume normal playback, select "Normal" in step 2.

6 To change the programme:

- (1) Select "Program" in step 2, then press **▲ / ▼ / ▶ / ◀** to select the track number you want to change, and press **EXIT/CANCEL** .
- (2) Use the **Number buttons (0-9)** to enter the new track number.

7 To clear programmes:

- To clear a single programme, select "Program" in step 2. Press **▲ / ▼ / ▶ / ◀** to select the track number, then press **EXIT/CANCEL** .
- To clear all the programmes, select "Clear Program", then press **ENTER/CH LIST** .

## Random playback (VCD)

1 Press **PLAY MODE** during playback or stop mode.

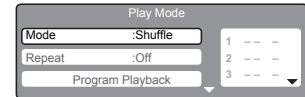

2 Press **▲ / ▼** to select "Mode", then press **ENTER/CH LIST** to select "Shuffle".

3 Press **PLAY** to start random playback.

- If you set 'Shuffle' during playback mode, Random playback will begin after the track that is currently being played has ended.
- To resume normal playback, select "Normal" in step 2.

# Customizing the function settings

You can change the default settings to customize performance to your preference.

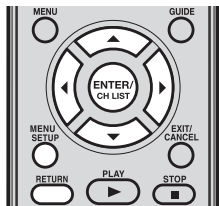

## Setting procedure

1 In DVD mode, press **MENU SETUP**  in stop mode.

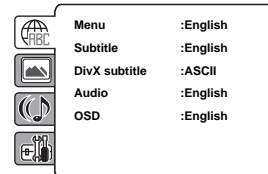

2 Press **▲ / ▼** to select a setup tab, then press **▶**.

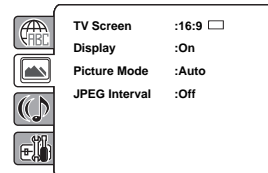

3 First option will be highlighted. Press **▲ / ▼** to select the desired option.

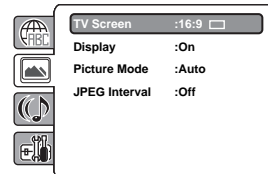

4 Press **ENTER/CH LIST**  to display a list of available option settings.

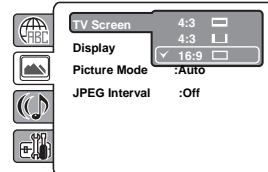

5 Press **▲ / ▼** to select an option setting, then press **ENTER/CH LIST**  to save the setting.





Refer to pages 46 ~ 51 for a list of description for each option setting.

6 To configure another option on the same setup, repeat steps 3 ~ 5.  
To select another section, go back to step 2 by pressing **◀** repeatedly.

7 To close the SETUP screen, press **MENU SETUP**  or press **RETURN** .

## Customizing the function settings (continued)

### Settings details

Section	Option	Details	Page
	Menu	Select the language for the DVD menu display.	48
	Subtitle	Select the subtitle language for disc playback.	
	DivX subtitle	Select the subtitle language for DivX VOD playback.	
	Audio	Select the audio language for disc playback.	
	OSD	Select a preferred language for on screen display.	
	TV Screen	Select a picture size according to the aspect ratio of your TV.	48
	Display	Turn the operation status display on the screen on or off.	
	Picture Mode	Select a preferred picture mode from "Video", "Film", or "Auto"	
	JPEG Interval	Select the interval time between images in a slide show.	49
	Night Mode	Toggle the night mode on or off.	49
	Digital Out	Select the format for digital audio output corresponding to your audio connection.	
	Parental	Set the restriction level for allowable disc content.	50
	Password	Change the access password for the parental control setting.	51
	DivX (R) VOD	Display the 8-character registration code for viewing DivX VOD content.	
	DivX Deregistration	Display the 8-character deregistration code.	

**Note:** These setup settings are retained in the unit's memory. It remains active even if the power is turned off.

# Customizing the function settings (continued)

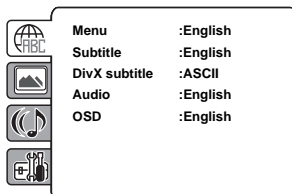

## Menu and OSD

Select the language for the DVD and Setup menu display. Options include: English, French, Spanish, and Italian

## Subtitle and Audio

Select the language for the subtitle display and audio track output during disc playback.

- **English/French/Spanish/Italian:** The selected language will be heard or seen.
- **Auto (Subtitle):** The unit will display the subtitle in the disc's default language.
- **Off (Subtitle):** There will be no subtitle display.

### Note:

- If the selected language is not available or recorded on the disc, the default disc language will be used.

## DivX subtitle

Select the subtitle encoding format to use during DivX<sup>®</sup> content playback. Options include: ASCII, Unicode, Turkish, Hebrew, Arabic

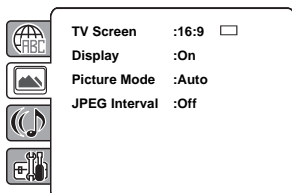

## TV Screen

Select the picture size during disc playback.

- **4:3 (Letterbox):** When playing back a wide screen-DVD disc, it displays the wide picture with black bands at the top and bottom of screen.
- **4:3 (Panscan):** It displays the wide picture on the whole screen with left and right edges automatically cut off.
- **16:9 (Wide screen):** A wide screen picture is displayed full size, although the image on the screen may be geometrically distorted in this mode because the TV screen has an aspect ratio of 4:3 not 16:9.

### Note:

- If the DVD disc is not formatted in the pan & scan style, it will be displayed in the standard 4:3 proportion.

## Display

Choose whether to show a status display whenever a button is pressed.

- **Off:** On screen displays do not appear when you press any buttons except **PLAY MODE**, **MARKER**, **i** and **JUMP**.
- **On:** On screen displays appear when you press the buttons (factory setting).

## Picture Mode

The source content of a DVD video disc can either be recorded in film format (images are recorded at 24 frames per second) or video format (video signals are recorded at 30 frames per second). Make this selection according to the type of content being viewed.

- **Auto:** The DVD player automatically detects the type of source content, film or video of playback source, and converts that signal in an appropriate method.
- **Film:** The DVD player converts film content pictures appropriately. Suitable for playback of film content pictures.
- **Video:** The DVD player filters video signal, and converts it appropriately. Suitable for playback of video content pictures.

### Note:

- Depending on the disc, pictures may be cut off or doubled. In this case, select "Video".



## Customizing the function settings (continued)

### JPEG Interval

You can continuously playback all JPEG files automatically.

After the selection below, the disc will start playback on JPEG files which have been recorded.

- **Off:** Plays back one file at a time.
- **5 seconds:** Plays back images in the form of a slide show at 5 second intervals.
- **10 seconds:** Plays back images in the form of a slide show at 10 second intervals.
- **15 seconds:** Plays back images in the form of a slide show in 15 second intervals.

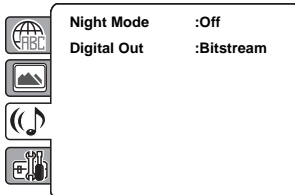

### Night Mode

Night Mode enables you to control the dynamic range so as to achieve a suitable sound for your equipment.

- **Off:** It plays back at the recording level on the disc.
- **On:** Loud sound such as explosion is toned down slightly when played back. This is suitable when it is connected to a stereo.

### Notes:

- This function works only when the disc recorded with Dolby Digital is played back.
- The level of Night Mode may differ depending on DVD video disc.

### Digital Out

You can select the digital output sound format corresponding to your system connection.

- **Off:** There is no sound output from DIGITAL AUDIO OUT jack.
- **PCM:** Change Dolby Digital to PCM for the output.  
Select when connected to a 2 channel digital stereo amplifier.
- **Bitstream:** Disc audio bitstream data will be output.

### Note:

- Even if you select "Bitstream", MPEG Audio will be output in PCM format.

## Customizing the function settings (continued)



	Parental	:Off
	Password	:Change
	DivX(R) VOD	:Display
	DivX Dereistration	:Display

### Parental

Some discs are specified as not suitable for children. Such discs can be limited not to playback with the unit.

- (1) Press **▲ / ▼** to select "Parental", then press **ENTER/CH LIST** . "Enter Password" screen will appear.
- (2) Press "0000" using **Number buttons (0-9)**. (Please note, this is presetting password of this unit). Then press **ENTER/CH LIST** .

Press **ENTER/CH LIST** again to display the parental level listing.





- **Level 1 Kid Safe:** Suitable for children
  - **Level 2 G:** General audience; recommended as acceptable for viewers of all ages.
  - **Level 3 PG:** Parental Guidance suggested.
  - **Level 4 PG-13:** Unsuitable for children under 13.
  - **Level 5 PG-R:** Parental Guidance Recommended.
  - **Level 6 R:** Restricted; under 17 requires accompanying parent or adult guardian.
  - **Level 7 NC-17:** No one under 17 admitted.
  - **Level 8 Adult:** DVD softwares of any grades (adult/general/children) can be played back. Should be viewed only by adults due to graphic sexual material, violence or language.
  - **Level Off:** Parental Control is inactive; all discs can play.
- (3) Press **▲ / ▼** to select from the level 1 to level 8. The limitation will be more severe as the level number is lower. Then press **ENTER/CH LIST** .
  - (4) Press **EJECT ▲** to activate Parental control setting.

### Notes:

- If each setup (pages 47 ~ 49) has been completed, the unit can always work under the same condition (especially with DVD discs). Each setup will be retained in the memory even if you turn the power off.
- Depending on the discs, the unit cannot limit playback.
- Some discs may not be encoded with specific rating level information though its disc jacket says 'adult'. For those discs, the age restriction will not work.
- The password is required every time when you change the parental level.
- If you input a wrong number, press **EXIT/CANCEL** .

## Customizing the function settings (continued)

### Password



- (1) Press **▲ / ▼** to select "Password", then press **ENTER/CH LIST** . The 'Enter Current Password' screen will appear.
- (2) Press **Number buttons (0-9)** to input the current password (If the password has not been set yet after you purchase this unit, it is "0000"), then press **ENTER/CH LIST** . The 'Enter New Password' screen will appear.
- (3) Use the **Number buttons (0-9)** to input the new password.
- (4) Press **ENTER/CH LIST** . You will be prompted to confirm the new password.
- (5) Use the **Number buttons (0-9)** to input the new password again, then press **ENTER/CH LIST** . Now your new password has been set. Be sure to remember this number!

If you forget the password.

- (1) Press **EJECT ▲** to remove the disc.
- (2) Press and hold down **4** on the remote control, then press **VOL -** on the unit. The 'Initializing' message appears on the screen to indicate that the password has been reset to its default factory setting ("0000"). All DVD Setup related settings will also be reset to their default factory values.

### DivX(R) VOD

In order to play DivX® VOD (Video On Demand) content on this unit, you first need to register the unit with your DivX® VOD content provider. You do this by generating a DivX® VOD registration code, which you submit to your provider.

- (1) Press **▲ / ▼** to select "DivX(R) VOD", then press **ENTER/CH LIST** . Your **8**-character registration code is displayed. Make a note of the code as you will need it when you register with a DivX® VOD provider. Then press **ENTER/CH LIST**  to select "Done".

### DivX Deregistration

In order to deregister this unit, you will be required to provide your unit's deregistration code.

To generate this code:

- (1) Press **▲ / ▼** to select "DivX Deregistration", then press **ENTER/CH LIST** . Note down the **8**-character deregistration code that is displayed on-screen.

# Temporary cancel the rating level by DVD disc

Depending on the DVD disc, the disc may try to temporarily cancel the rating level that you have set. It is up to you to decide whether to cancel the rating level or not.

- 1 Load a DVD disc.

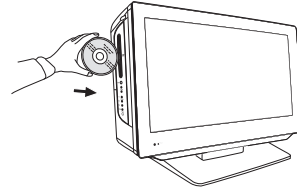

- 2 If the DVD disc has been designed to temporarily cancel the Rating level, the screen which follows the Reading screen will change, depending on which disc is played. If you select "Yes" with the **ENTER**, password input screen will then appear.

- 3 Press **Number buttons (0-9)** to input the password, then press **ENTER/CH LIST**.



- 4 Playback will commence if the entered password was correct.

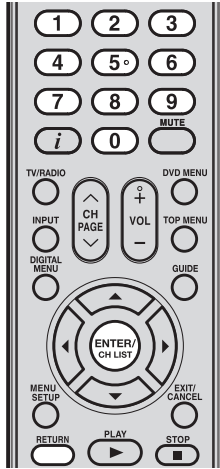

## Note:

- This temporary cancellation of rating level will be kept until the disc is ejected. When the disc is ejected, the original rating level will be set again automatically.

# PC connection

As PCs are sometimes supplied with a 'conventional' CRT monitor, you may need to adjust the display settings of your PC's graphics card, otherwise the pictures may not appear correctly. Switch on your PC (still with your original monitor) - select "1360 x 768" for the screen resolution, and select 60 Hz for the on-screen refresh rate. Switch off your PC, then connect it to your TV while both items are still switched off.

## Monitor Display modes

MODE	Resolution	V. Frequency	H. Frequency	Pixel Clock Frequency
VGA	640 x 480	59.940 Hz	31.469 kHz	25.175 MHz
SVGA	800 x 600	60.317 Hz	37.879 kHz	40.000 MHz
XGA	1024 x 768	60.004 Hz	48.363 kHz	65.000 MHz
WXGA	1280 x 720	60.000 Hz	45.000 kHz	74.250 MHz
WXGA	1280 x 768	59.870 Hz	47.776 kHz	79.500 MHz
WXGA	1360 x 768	60.015 Hz	47.712 kHz	85.500 MHz

(according to Graphic card)

### Select PC input

- Switch on the TV.
- Switch on the computer.
- Select the PC input mode (see page 13). (When you use HDMI cable, select HDMI input mode.)

#### Notes:

- If there is no video signal from the computer when the unit is in PC mode, "No Signal" will appear on the TV screen.
- Digital PC connection via HDMI input is not supported. If you try to connect your PC digitally, the TV-operation might freeze. TV will stop to respond properly on user commands.



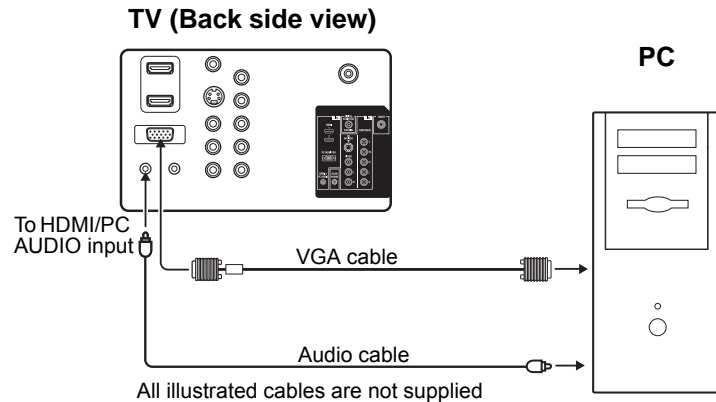

#### Countermeasure:

- Switch-off your TV and disconnect from the 220 ~ 240V power-supply. Disconnect the digital PC connection. Now you may retry operating your TV.
- If a digital PC connection does show a picture, proper working is not guaranteed. Digital PC connection is not granted for this TV.

Use a PC-VGA cable (not supplied) to connect the TV to your PC.





**Example:** To adjust the contrast.



- During PC mode press **MENU SETUP**  to display the Main Menu screen.
- Press **▲/▼** to select "Picture", then press **ENTER/CH LIST** . Press **▲/▼** to select "Picture Setting", then press **ENTER/CH LIST** . Select **CONTRAST**, then press **ENTER/CH LIST** . Press **◀/▶** to adjust the contrast.
- Press **EXIT/CANCEL**  to return to the normal screen.

After connecting a PC to your TV, you can now configure the display and audio settings.

### To configure the display settings

- Press **MENU SETUP**  to display the Main Menu screen.
- Press **▲/▼** to select the "Picture" menu, then press **ENTER/CH LIST** .
- On the Picture menu you can adjust various picture properties such as brightness, contrast, colour, sharpness, tint, colour temperature and backlight.
- For a list of available menu options in the Picture menu, see page 22.

### To configure the audio settings

- Press **MENU SETUP**  to display the Main Menu screen.
- Press **▲/▼** to select the "Sound" menu, then press **ENTER/CH LIST** .
- On the Sound menu you can adjust the NICAM stereo reception, and the bass, treble, balance and sound effects.
- For a list of available menu options in the Sound menu, see page 22.

# Connecting TV to other equipment

## 1 Connecting aerials and other devices to your TV

Connect the cable TV coaxial cable directly to the aerial input jack on the rear of the TV.

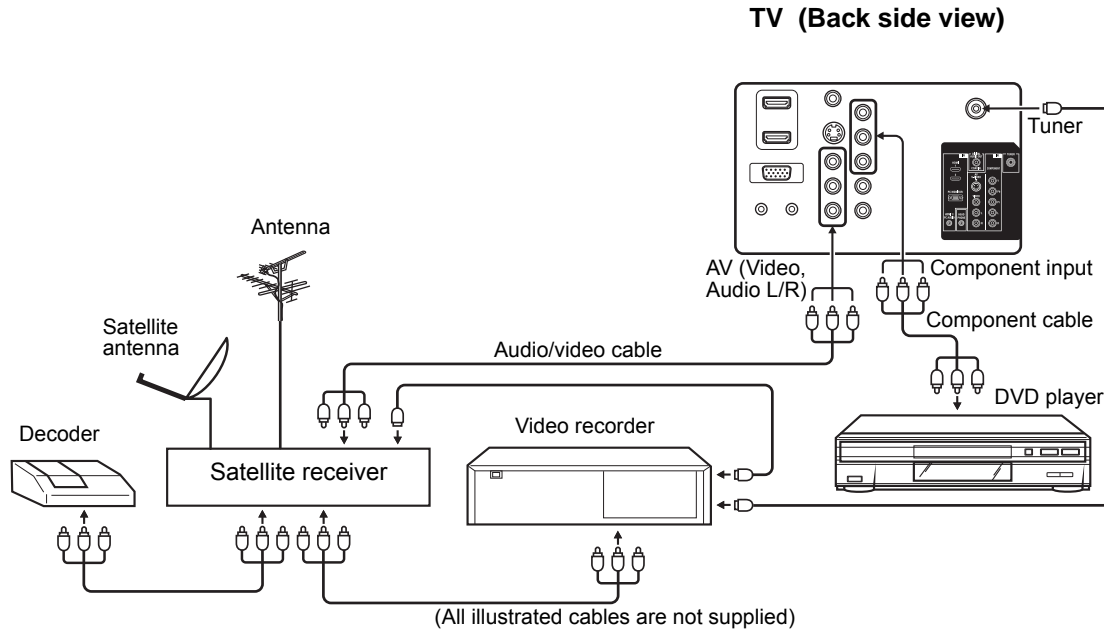

### Caution:

Before connecting:

- Make sure to disconnect the appliance from the power supply in order to avoid any potential damage from occurring.
- Make sure to establish the required connection.
- Make sure that connections are properly and correctly attached before connecting the appliances to the power supply.

## 2 Connecting an audio system

If you have a surround sound amplifier/decoder with a coaxial digital input, you can connect the Coaxial Digital Audio Output to it, using a suitable coaxial digital lead. This connection carries the audio signal from the set's Digital channels only.

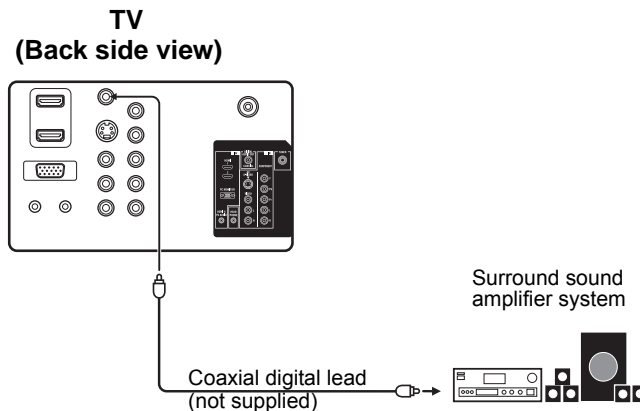

### Notes:

- The Bass/Treble/Balance adjustments only function with the sound from the TV speakers - it does not affect the audio output sockets.
- After connecting a Dolby Digital decoder please select in the DVD menu the Dolby Digital (DD) sound track option.
- Several DVDs may be pre-recorded on both sides however only one side contains the Dolby Digital sound track. Please insert the correct DVD side.
- When a DTS sound track is played the integrated loudspeakers are mute. The DTS sound can only be played digitally using the digital outlet. DTS decoder is necessary for hearing.
- Digital audio output is active only when receiving DVB-T, not when receiving analog cable TV broadcasting.

## Connecting TV to other equipment (continued)

### 3 Connecting a DVD player

Connect the DVD player as shown.  
Select AV as the input mode.

TV (Back side view)

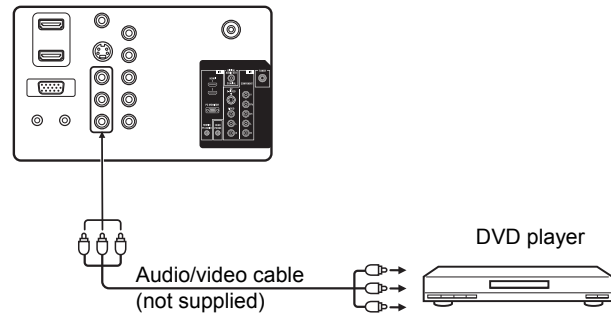

### 4 Connecting a Video camera and a Video recorder

Select the AV input mode (see page 13). You can see the playback picture from the video camera.

TV (Back side view)

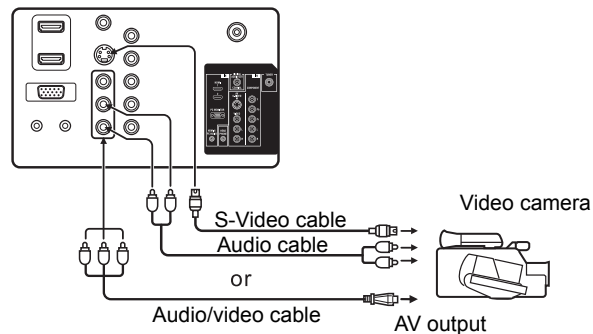

(All illustrated cables are not supplied)

**Note:**

- If you have a camcorder with S-video, use an S-video cable instead of a standard video cable. Do not connect a standard video cable and an S-video cable at the same time, the S-Video cable will override the composite video input.

### 5 Connecting to a DVD player or other AV device with Component Video outputs

If your DVD player (or other device) has Component Video output jacks, use a suitable set of leads (RCA/ Phono) to connect these to the Component Video inputs on this TV as shown - it can greatly enhance the picture quality and performance. Please remember that you will also need to connect separate leads (RCA/Phono) for the audio signals. Select the Component input mode (see page 13).

TV (Back side view)

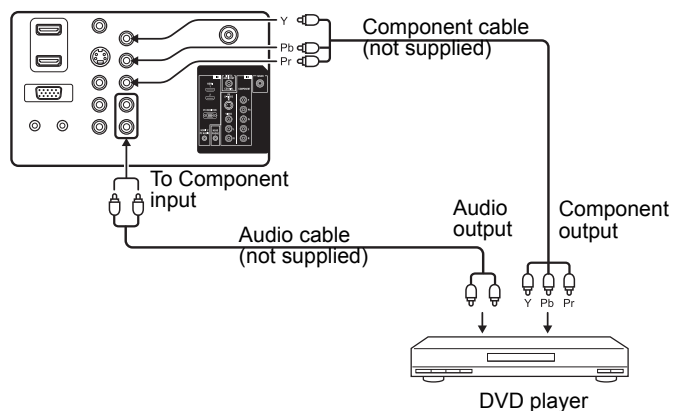

**Note:**

- The Component Video input is used with equipment which outputs interlaced signals (PAL: 576i/1080i or NTSC: 480i/1080i) and progressive signals (PAL: 576p/720p or NTSC: 480p/720p).

## Status message

Information/Status message	Cause
Invalid entry	The channel does not exist. (e.g., "000")
No radio services	Cannot change to Radio mode because there is no radio service in the channel list.
No TV service	Cannot change to TV mode because there is no TV service in the channel list.
No data service	Cannot change to data mode because there is no data service in the channel list.
No services	There are no services in the received signal.
No Teletext signal	There is no Teletext in the channel.
Duplicate Timer	When two event timers overlap.
No subtitles	There are no subtitles in the received signal.
No video No audio	The signal does not contain audio or video.
Audio stream not available	The Multi Audio Menu cannot be displayed because there is no sound.
Descrambling not possible	The services for the selected channel are not available for this card.
Database empty	There are no services in the TV.
No signal	There are no signal inputs.
Locked service	The service is locked with the channel organizer.
Scrambled service	The service is scrambled and unavailable.
Digital Service	Not available.
Not Running	Broadcasting has been suspended.
New service added ...	A new service has been added.
Upgrading available service details	Service information has been changed. The channel list is updating.
Duplicate carrier found	The same signal has already been set.
Invalid Stream	Contains a video format that is not supported by this TV.



# Troubleshooting table

Please check the following list before requesting service.

Symptom	Possible solution	Page
<b>TV</b>		
No picture, no sound	Switch on the set. Check that the mains power outlet is properly connected. Select appropriate input mode. Unplug unit for 1 minute, then plug it back in.	6 9 13
No reception	Have you tuned in the TV stations? Connect the antenna. Make sure the set is ON and not in Standby mode	10, 13 9 6
The TV switches off with missing antenna input signal	This is normal. 15 minutes after the antenna signal has disappeared, the set will change to standby mode.	17
The "Channel" menu cannot be accessed in the Main Menu screen.	The unit is set to AV mode. Press 1 on the remote control.	12
Wrong Colours	Colour and Brightness errors can occur when the viewing angle/ambient air temperature (see technical specifications) are exceeded.	-
There is sound but no picture when viewing a DVB (digital) channel	Some channel offers audio content only.	-
Blocky image or image stops intermittently.	Check all antenna connections. Move the antenna away from areas of possible interference. Try using an antenna booster.	9
Some digital channels cannot be viewed.	Contact the service provider to subscribe.	-
"Database empty" message appears on the screen.	Check all antenna connections and try auto tuning again.	9
<b>DVD</b>		
The playback picture has occasional distortion.	The disc is dirty. Eject the disc and clean it. Some times a small amount of picture distortion may appear. This is not a malfunction.	30, 31
The unit does not start playback.	No disc is inserted. Insert a disc. An unplayable disc is inserted. Insert a playable disc (Check the disc type and colour system). Place the disc in the disc slot with the label side facing forward. The disc is dirty. Clean the disc. Cancel the parental lock function or change the parental lock level.	31 30 31 30 50, 52
<b>X</b> appears on the screen.	The function is prohibited with the unit or the disc.	33

- The LCD panel contained in this TV is manufactured using an extremely high level of precision technology, however there may be an occasional non-active pixel that may appear on the screen as a fixed point of blue, green or red. Please note that this does not affect the performance of your product.

- This product incorporates copyright protection technology that is protected by U.S. patents and other intellectual property rights. Use of this copyright protection technology must be authorized by Macrovision, and is intended for home and other limited viewing uses only unless otherwise authorized by Macrovision. Reverse engineering or disassembly is prohibited.
- Manufactured under license from Dolby Laboratories. Dolby and the double-D symbol are trademarks of Dolby Laboratories.
- DVD** is a trademark of DVD Format/Logo Licensing Corporation.
- Manufactured under license under U.S. Patent #: 5,451,942 & other U.S. and worldwide patents issued & pending. DTS and DTS Digital Out are registered trademarks and the DTS logos and Symbol are trademarks of DTS, Inc. © 1996-2008 DTS, Inc. All Rights Reserved.
- Unauthorized recording of copyrighted television programmes, films, video cassettes and other materials may infringe the rights of copyright owners and be contrary to copyright laws.
- DivX® is a registered trademark of DivX, Inc., and is used under license.
- MPEG Layer-3 audio coding technology licensed from Fraunhofer IIS and Thomson.

# Specifications

Model		19DV615Y	22DV615Y	26DV615Y
<b>Television</b>				
LCD panel (approximate screen size, diagonal)		18.5 inch	21.6 inch	26.0 inch
System	Analog	PAL, B/G		
	Digital	DVB-T (OFDM 2k/8k 16QAM/64QAM)		
Video colour system		PAL/SECAM/NTSC 3.58/NTSC 4.43/PAL 60		
Preset channels:		Analog channels (99) + Digital channels		
Frequency range	Analog	VHF 2-12, UHF 21-69		
	Digital	VHF Band III(174-230 MHz) UHF Band IV & V(519-820MHz)		
LCD		TFT low-glass Active Matrix Colour LCD, 1366 x 768 Pixel		
Speaker		30x70 mm, 4 $\Omega$ x 2	42x110 mm, 6 $\Omega$ x 2	
Audio output power		Approx. 1.5 W (MAX) x 2		Approx. 10 W (MAX) x 2
<b>DVD</b>				
Signal system		NTSC, PAL (Region 4)		
Applicable disc		DVD (12cm, 8cm), CD (12cm, 8cm)		
Output	Audio	(RCA) –12.0 dBm, 1 k ohms		
	Digital audio	0.5 Vp-p / 75 ohms		
Pickup	CD	Wavelength: 775 - 805 nm Maximum output power: 0.5 mW		
	DVD	Wavelength: 640 - 660 nm Maximum output power: 1.0 mW		
<b>Input/Output</b>				
HDMI input		One HDMI compliant (type A connector)	Two HDMI compliant (type A connector)	
		HDCP compliant Suggested scan rates: PAL: 576i/576p/720p/1080i NTSC: 480i/480p/720p/1080i PC Audio: 2-channel PCM, 32/44.1/48 kHz sampling frequency 16/20/24 bits per sample		
S-Video input		(Y) 1.0 V (p-p), 75 $\Omega$ , 4-pin mini-DIN x 1 (C) 1.0 V (p-p), 75 $\Omega$		
ColorStream video input		(Y) 1.0 V (p-p), 75 $\Omega$ , pin jack x 1 (PB, PR) 0.7 V (p-p), 75 $\Omega$ , pin jack x 2		
Video input		1.0 V (p-p), 75 $\Omega$ , pin jack x 1		
Audio input		–8dBm, 50 k $\Omega$ , pin jack (L/R) x 2		
PC input		Monitor: 15-pin mini-D-sub x 1; audio: 3.5-mm stereo jack x 1		
Coaxial digital audio output		0.5 V (p-p), 75 $\Omega$ , pin jack x 1		
Headphone		3.5-mm stereo mini jack x 1		—
<b>General</b>				
Power source		AC 110-240 V, 50/60 Hz		
Power consumption	Operation	Approx. 47 W at 230 V, 50 Hz	Approx. 64 W at 230 V, 50 Hz	Approx. 115 W at 230 V, 50 Hz
	Standby	Approx. 0.8 W at 230 V, 50 Hz	Approx. 0.8 W at 230 V, 50 Hz	Approx. 0.8 W at 230 V, 50 Hz
Weight		4.69 kg	5.32 kg	8.62 kg
Dimensions	Width	18.76 in. (476.4 mm)	21.65 in. (549.9 mm)	26.83 in. (681.4 mm)
	Height	14.44 in. (366.9 mm)	16 in. (406.45 mm)	20.16 in. (512.1 mm)
	Depth	8.07 in. (205 mm)	8.13 in. (206.5 mm)	8.99 in. (228.25 mm)
Operating temperature		5 °C ~ 35 °C (41 °F ~ 95 °F)		
<b>Accessories</b>				
		Remote control 2 batteries (AAA/R03/UM-4) AC cord		Remote control 2 batteries (AAA/R03/UM-4) AC cord

\*Visible screen size is approximate.

## Notes:

- All weight and dimensions are approximate values.
- We continually strive to improve our products. Designs and specifications are subject to change without notice.

# The GNU General Public License (GPL)

Version 2, June 1991

Copyright (C) 1989, 1991 Free Software Foundation, Inc.  
59 Temple Place, Suite 330, Boston, MA 02111-1307 USA

Everyone is permitted to copy and distribute verbatim copies of this license document, but changing it is not allowed.

## Preamble

The licenses for most software are designed to take away your freedom to share and change it. By contrast, the GNU General Public License is intended to guarantee your freedom to share and change free software--to make sure the software is free for all its users. This General Public License applies to most of the Free Software Foundation's software and to any other program whose authors commit to using it. (Some other Free Software Foundation software is covered by the GNU Library General Public License instead.) You can apply it to your programs, too.

When we speak of free software, we are referring to freedom, not price. Our General Public Licenses are designed to make sure that you have the freedom to distribute copies of free software (and charge for this service if you wish), that you receive source code or can get it if you want it, that you can change the software or use pieces of it in new free programs; and that you know you can do these things.

To protect your rights, we need to make restrictions that forbid anyone to deny you these rights or to ask you to surrender the rights. These restrictions translate to certain responsibilities for you if you distribute copies of the software, or if you modify it. For example, if you distribute copies of such a program, whether gratis or for a fee, you must give the recipients all the rights that you have. You must make sure that they, too, receive or can get the source code. And you must show them these terms so they know their rights.

We protect your rights with two steps: (1) copyright the software, and (2) offer you this license which gives you legal permission to copy, distribute and/or modify the software.

Also, for each author's protection and ours, we want to make certain that everyone understands that there is no warranty for this free software. If the software is modified by someone else and passed on, we want its recipients to know that what they have is not the original, so that any problems introduced by others will not reflect on the original authors' reputations.

Finally, any free program is threatened constantly by software patents. We wish to avoid the danger that redistributors of a free program will individually obtain patent licenses, in effect making the program proprietary. To prevent this, we have made it clear that any patent must be licensed for everyone's free use or not licensed at all.

The precise terms and conditions for copying, distribution and modification follow.

## TERMS AND CONDITIONS FOR COPYING, DISTRIBUTION AND MODIFICATION

This License applies to any program or other work which contains a notice placed by the copyright holder saying it may be distributed under the terms of this General Public License. The "Program", below, refers to any such program or work, and a "work based on the Program" means either the Program or any derivative work under copyright law: that is to say, a work containing the Program or a portion of it, either verbatim or with modifications and/or translated into another language. (Hereinafter, translation is included without limitation in the term "modification".) Each licensee is addressed as "you".

Activities other than copying, distribution and modification are not covered by this License; they are outside its scope. The act of running the Program is not restricted, and the output from the Program is covered only if its contents constitute a work based on the Program (independent of having been made by running the Program). Whether that is true depends on what the Program does.

(1) You may copy and distribute verbatim copies of the Program's source code as you receive it, in any medium, provided that you conspicuously and appropriately publish on each copy an appropriate copyright notice and disclaimer of warranty; keep intact all the notices that refer to this License and to the absence of any warranty; and give any other recipients of the Program a copy of this License along with the Program.

You may charge a fee for the physical act of transferring a copy, and you may at your option offer warranty protection in exchange for a fee.

(2) You may modify your copy or copies of the Program or any portion of it, thus forming a work based on the Program, and copy and distribute such modifications or work under the terms of Section 1 above, provided that you also meet all of these conditions:

- a) You must cause the modified files to carry prominent notices stating that you changed the files and the date of any change.
- b) You must cause any work that you distribute or publish, that in whole or in part contains or is derived from the Program or any part thereof, to be licensed as a whole at no charge to all third parties under the terms of this License.
- c) If the modified program normally reads commands interactively when run, you must cause it, when started running for such interactive use in the most ordinary way, to print or display an announcement including an appropriate copyright notice and a notice that there is no warranty (or else, saying that you provide a warranty) and that users may redistribute the program under these conditions, and telling the user how to view a copy of this License. (Exception: if the Program itself is interactive but does not normally print such an announcement, your work based on the Program is not required to print an announcement.)

These requirements apply to the modified work as a whole. If identifiable sections of that work are not derived from the Program, and can be reasonably considered independent and separate works in themselves, then this License, and its terms, do not apply to those sections when you distribute them as separate works. But when you distribute the same sections as part of a whole which is a work based on the Program, the distribution of the whole must be on the terms of this License, whose permissions for other licensees extend to the entire whole, and thus to each and every part regardless of who wrote it.

Thus, it is not the intent of this section to claim rights or contest your rights to work written entirely by you; rather, the intent is to exercise the right to control the distribution of derivative or collective works based on the Program.

- In addition, mere aggregation of another work not based on the Program with the Program (or with a work based on the Program) on a volume of a storage or distribution medium does not bring the other work under the scope of this License.
- (3) You may copy and distribute the Program (or a work based on it, under Section 2) in object code or executable form under the terms of Sections 1 and 2 above provided that you also do one of the following:
    - a) Accompany it with the complete corresponding machine-readable source code, which must be distributed under the terms of Sections 1 and 2 above on a medium customarily used for software interchange; or,
    - b) Accompany it with a written offer, valid for at least three years, to give any third party, for a charge no more than your cost of physically performing source distribution, a complete machine-readable copy of the corresponding source code, to be distributed under the terms of Sections 1 and 2 above on a medium customarily used for software interchange; or,
    - c) Accompany it with the information you received as to the offer to distribute corresponding source code. (This alternative is allowed only for noncommercial distribution and only if you received the program in object code or executable form with such an offer, in accord with Subsection b above.)

The source code for a work means the preferred form of the work for making modifications to it. For an executable work, complete source code means all the source code for all modules it contains, plus any associated interface definition files, plus the scripts used to control compilation and installation of the executable. However, as a special exception, the source code distributed need not include anything that is normally distributed (in either source or binary form) with the major components (compiler, kernel, and so on) of the operating system on which the executable runs, unless that component itself accompanies the executable.

If distribution of executable or object code is made by offering access to copy from a designated place, then offering equivalent access to copy the source code from the same place counts as distribution of the source code, even though third parties are not compelled to copy the source along with the object code.

- (4) You may not copy, modify, sublicense, or distribute the Program except as expressly provided under this License. Any attempt otherwise to copy, modify, sublicense or distribute the Program is void, and will automatically terminate your rights under this License. However, parties who have received copies, or rights, from you under this License will not have their licenses terminated so long as such parties remain in full compliance.
- (5) You are not required to accept this License, since you have not signed it. However, nothing else grants you permission to modify or distribute the Program or its derivative works. These actions are prohibited by law if you do not accept this License. Therefore, by modifying or distributing the Program (or any work based on the Program), you indicate your acceptance of this License to do so, and all its terms and conditions for copying, distributing or modifying the Program or works based on it.
- (6) Each time you redistribute the Program (or any work based on the Program), the recipient automatically receives a license from the original licensor to copy, distribute or modify the Program subject to these terms and conditions. You may not impose any further restrictions on the recipients' exercise of the rights granted herein. You are not responsible for enforcing compliance by third parties to this License.
- (7) If, as a consequence of a court judgment or allegation of patent infringement or for any other reason (not limited to patent issues), conditions are imposed on you (whether by court order, agreement or otherwise) that contradict the conditions of this License, they do not excuse you from the conditions of this License. If you cannot distribute so as to satisfy simultaneously your obligations under this License and any other pertinent obligations, then as a consequence you may not distribute the Program at all. For example, if a patent license would not permit royalty-free redistribution of the Program by all those who receive copies directly or indirectly through you, then the only way you could satisfy both it and this License would be to refrain entirely from distribution of the Program.

If any portion of this section is held invalid or unenforceable under any particular circumstance, the balance of the section is intended to apply and the section as a whole is intended to apply in other circumstances.

It is not the purpose of this section to induce you to infringe any patents or other property right claims or to contest validity of any such claims; this section has the sole purpose of protecting the integrity of the free software distribution system, which is implemented by public license practices. Many people have made generous contributions to the wide range of software distributed through that system in reliance on consistent application of that system; it is up to the author/donor to decide if he or she is willing to distribute software through any other system and a licensee cannot impose that choice.

This section is intended to make thoroughly clear what is believed to be a consequence of the rest of this License.

- (8) If the distribution and/or use of the Program is restricted in certain countries either by patents or by copyrighted interfaces, the original copyright holder who places the Program under this License may add an explicit geographical distribution limitation excluding those countries, so that distribution is permitted only in or among countries not thus excluded. In such case, this License incorporates the limitation as if written in the body of this License.
- (9) The Free Software Foundation may publish revised and/or new versions of the General Public License from time to time. Such new versions will be similar in spirit to the present version, but may differ in detail to address new problems or concerns.

Each version is given a distinguishing version number. If the Program specifies a version number of this License which applies to it and "any later version", you have the option of following the terms and conditions either of that version or of any later version published by the Free Software Foundation. If the Program does not specify a version number of this License, you may choose any version ever published by the Free Software Foundation.

- (10) If you wish to incorporate parts of the Program into other free programs whose distribution conditions are different, write to the author to ask for permission. For software which is copyrighted by the Free Software Foundation, write to the Free Software Foundation; we sometimes make exceptions for this. Our decision will be guided by the two goals of preserving the free status of all derivatives of our free software and of promoting the sharing and reuse of software generally.

## NO WARRANTY

- (1) BECAUSE THE PROGRAM IS LICENSED FREE OF CHARGE, THERE IS NO WARRANTY FOR THE PROGRAM, TO THE EXTENT PERMITTED BY APPLICABLE LAW. EXCEPT WHEN OTHERWISE STATED IN WRITING THE COPYRIGHT HOLDERS AND/OR OTHER PARTIES PROVIDE THE PROGRAM "AS IS" WITHOUT WARRANTY OF ANY KIND, EITHER EXPRESSED OR IMPLIED, INCLUDING, BUT NOT LIMITED TO, THE IMPLIED WARRANTIES OF MERCHANTABILITY AND FITNESS FOR A PARTICULAR PURPOSE. THE ENTIRE RISK AS TO THE QUALITY AND PERFORMANCE OF THE PROGRAM IS WITH YOU. SHOULD THE PROGRAM PROVE DEFECTIVE, YOU ASSUME THE COST OF ALL NECESSARY SERVICING, REPAIR OR CORRECTION.
- (2) IN NO EVENT UNLESS REQUIRED BY APPLICABLE LAW OR AGREED TO IN WRITING WILL ANY COPYRIGHT HOLDER, OR ANY OTHER PARTY WHO MAY MODIFY AND/OR REDISTRIBUTE THE PROGRAM AS PERMITTED ABOVE, BE LIABLE TO YOU FOR DAMAGES, INCLUDING ANY GENERAL, SPECIAL, INCIDENTAL OR CONSEQUENTIAL DAMAGES ARISING OUT OF THE USE OR INABILITY TO USE THE PROGRAM (INCLUDING BUT NOT LIMITED TO LOSS OF DATA OR DATA BEING RENDERED INACCURATE OR LOSSES SUSTAINED BY YOU OR THIRD PARTIES OR A FAILURE OF THE PROGRAM TO OPERATE WITH ANY OTHER PROGRAMS), EVEN IF SUCH HOLDER OR OTHER PARTY HAS BEEN ADVISED OF THE POSSIBILITY OF SUCH DAMAGES.

END OF TERMS AND CONDITIONS

## How to Apply These Terms to Your New Programs

If you develop a new program, and you want it to be of the greatest possible use to the public, the best way to achieve this is to make it free software which everyone can redistribute and change under these terms.

To do so, attach the following notices to the program. It is safest to attach them to the start of each source file to most effectively convey the exclusion of warranty; and each file should have at least the "copyright" line and a pointer to where the full notice is found.

One line to give the program's name and a brief idea of what it does.

Copyright (C) <year> <name of author>

This program is free software; you can redistribute it and/or modify it under the terms of the GNU General Public License as published by the Free Software Foundation; either version 2 of the License, or (at your option) any later version.

This program is distributed in the hope that it will be useful, but WITHOUT ANY WARRANTY; without even the implied warranty of MERCHANTABILITY or FITNESS FOR A PARTICULAR PURPOSE. See the GNU General Public License for more details.

You should have received a copy of the GNU General Public License along with this program; if not, write to the

Free Software Foundation, Inc., 59 Temple Place, Suite 330,

Boston, MA 02111-1307 USA

Also add information on how to contact you by electronic and paper mail.

If the program is interactive, make it output a short notice like this when it starts in an interactive mode:

Gnomovision version 69,

Copyright (C) year name of author Gnomovision comes with ABSOLUTELY NO WARRANTY; for details type `show w'. This is free software, and you are welcome to redistribute it under certain conditions; type `show c' for details.

The hypothetical commands `show w' and `show c' should show the appropriate parts of the General Public License. Of course, the commands you use may be called something other than `show w' and `show c'; they could even be mouse-clicks or menu items--whatever suits your program.

You should also get your employer (if you work as a programmer) or your school, if any, to sign a "copyright disclaimer" for the program, if necessary. Here is a sample; alter the names:

Yoyodyne, Inc., hereby disclaims all copyright interest in the program `Gnomovision' (which makes passes at compilers) written by James Hacker.

signature of Ty Coon, 1 April 1989

Ty Coon, Vice President

This General Public License does not permit incorporating your program into proprietary programs. If your program is a subroutine library, you may consider it more useful to permit linking proprietary applications with the library. If this is what you want to do, use the GNU Library General Public License instead of this License.

# LIMITED WARRANTY STATEMENT

## for TOSHIBA LCD TV/DVD Combo

### GENERAL TERMS

This limited express warranty ("Warranty") applies to Toshiba LCD TV / DVD Combo ("LCD TV/DVD Combo"), sold by Toshiba (AUSTRALIA) Pty Limited ("Toshiba") through its authorised resellers and distributors, and applies only to LCD TV/DVD Combo that is new on the date of purchase and for which you have an invoice showing proof of purchase.

Toshiba expressly warrants this LCD TV/DVD Combo to be free from operational defects in workmanship and materials for a period described in the Warranty Period section below.

If you are in doubt as to the Warranty period relevant to your LCD TV/ DVD Combo, refer to either the Product brochure or Toshiba's Australian Website ([www.toshibaav.com.au](http://www.toshibaav.com.au)), or contact Toshiba on 13 30 70.

This Warranty does not include remedy of failure caused by poor signal, improper setup, installation, operation, cleaning or maintenance, accidental damage, misuse, abuse, non-Toshiba modifications to the LCD TV/DVD Combo, normal wear and tear or display image burn or shadowing, defects advised at the time of sale, or any other event, act, default or omission outside Toshiba's control.

### WARRANTY PERIOD

Subject to the opening paragraph, and unless specified otherwise in the product brochure, Toshiba expressly warrants this LCD TV/ DVD Combo to be free from operational defects in workmanship and materials for:

24 months from the date of purchase for home use

or,

12 months from the date of purchase for commercial use.

Remote control batteries are excluded from this Warranty being consumable items.

### WHAT IS COVERED UNDER THE WARRANTY

- (1) If any genuine and unaltered part within the LCD TV/DVD Combo fails during normal and proper use within the Warranty period stated for that model, Toshiba will, at its option, either repair or exchange the faulty part, using new or refurbished parts; or exchange the LCD TV/ DVD Combo (in both cases, for an item that is functionally equivalent to that originally supplied, or better); or refund the cost of the LCD TV/ DVD Combo.
- (2) Unless otherwise advised in writing, Toshiba will choose to repair or exchange faulty parts. Repaired or exchanged items are warranted for the longer of the balance of the original product Warranty or 90 days.
- (3) All parts removed for exchange become the property of Toshiba.
- (4) This Warranty is personal to the person or organisation named on the original sales receipt (proof of purchase), and is not transferable to a subsequent owner.
- (5) You are required to deliver and pickup your LCD TV/DVD Combo to and from a Toshiba AV authorised service centre at your expense. See "To Obtain Warranty Service" section for more detail.
- (6) The targeted Warranty repair time is 5 working days in depot, subject to the AV authorised service centre's ability to replicate the fault, and parts/ labour availability. Intermittent faults must be replicated to confirm that the fault is related to the LCD TV/DVD Combo and covered by this Warranty.
- (7) This Warranty is only valid within Australia. This Warranty is valid only for Toshiba LCD TV/DVD Combos distributed by Toshiba, and applies only to LCD TV/DVD Combos which are new on the date of purchase and accompanied by a proof of purchase, or evidence of supply from Toshiba.

### WARRANTY START DATE

The Warranty period starts at one of the following instances, provided valid documentation can be produced to substantiate the claim.

- (1) The date of purchase from an authorised Toshiba Reseller. Your dated sales or delivery receipt, showing product code and serial number, is your proof of purchase date.
- (2) In the event that proof of purchase cannot be provided, the date which Toshiba shipped the product to the authorised reseller will be the effective start of the warranty period (warranty entitlement).

### WHAT IS NOT COVERED BY THE WARRANTY

The Warranty shall not apply to certain damages, goods or cases, including without limitation, those set out below:

- (1) Limitations in technology. There are technology limitations on some of the devices used in this LCD TV/DVD Combo. These limitations are common or are defined standards within the Home Electronics & IT Industry and are not specific to Toshiba LCD TV/DVD Combo.
  - a) The DVD player may not play certain DVD movie titles due to DVD regionalisation or other security levels set by the original title (movie) producer.
  - b) The DVD Player may not play certain media formats, including some recordable discs.
  - c) The DVD player will accumulate dust that will affect the player's performance over time. This is not a fault, but requires routine maintenance by the user using non-abrasive cleaning media and by following the media supplier's instructions.
  - d) The LCD panel/ display may present up to 6 non-conforming pixels, (bright or dark spots) representing less than 0.0004% error rate.

These cases are a limitation of technology and do not represent a defect in the LCD TV/DVD Combo. Refer to Toshiba website, Limitation of Technology page, for more details.

- (2) Calls to attend or request for service assistance to install, configure or adjust the LCD TV/DVD Combo, where that adjustment is identified in the User manual supplied with the LCD TV/DVD Combo, or arises from inadequate antenna signal, antenna & cable faults, interference from other devices or cables, or where no fault is found in the LCD TV/DVD Combo, will be chargeable to the user at Toshiba's or the AV Authorised Service Centre's prevailing rates, this includes telephone support beyond 90 days from the date of purchase. Please refer to the Support section of Toshiba's website for details.
- (3) Replacement of any batteries or damage from battery leakage.
- (4) The expense of the service call where no fault is found, or in the event an appointment is made for service and the owner or nominated person is not in attendance at the negotiated time. This expense may be charged at the AV Authorised Service Centre's prevailing rates.
- (5) Damage, delay or any action by any party not authorised to perform Warranty repair on the LCD TV/DVD Combo. Please refer to the Support section of the website for authorised service providers or contact the Toshiba Service Centre.
- (6) Damage caused by improper media insertion, improper installation or improper connection to any device; (antenna, ac power, home theatre system, set top box, mounting bracket, furniture etc.).
- (7) Damage caused by an external electrical fault, power surge, or use of incorrect cabling. Damage or loss caused by accident, intentional or accidental misuse, abuse, neglect or improper maintenance, use under abnormal conditions, including fracture or bruising/bleeding of any glass or display panel (including the LCD display, casework, cables, adaptors, covers, plugs and latches. This includes fluid ingress of any kind (including damage from condensation), foreign objects or infestation, and damage from shock or restriction of airflow, or external heat.
- (8) Damage from use outside usage, installation & mounting parameters set out in the user guide, supplied with each LCD TV/ DVD Combo, and available on the Toshiba Australia website ([www.av.toshiba.com.au](http://www.av.toshiba.com.au)).
- (9) Damage from use of parts not manufactured or supplied by Toshiba.
- (10) Damage to or loss of any programs or, data, or costs of recovering such programs or data.
- (11) Consequential or other damages of any kind that may occur during repair or replacement.
- (12) Costs associated with the de-installation and re-installation of the LCD TV/DVD Combo is not provided under this Warranty.
- (13) LCD TV/DVD Combo purchased from anyone other than Toshiba or a Toshiba authorised Reseller.
- (14) Modifications to LCD TV/DVD Combo not approved in writing by Toshiba.
- (15) Service made necessary by use of incompatible third party products.
- (16) Service of a LCD TV/DVD Combo on which the TOSHIBA label or logo, rating label or serial number have been defaced or removed.
- (17) FORCE MAJEURE. Toshiba will not be responsible for any failure to perform due to causes beyond its control, including, without limitation, fires, floods, earthquakes, explosions, accidents, acts of public enemy, wars, rebellions, insurrections, sabotage, epidemics, quarantine restrictions, labour disputes, labour shortages, transportation embargoes or failures or delays in transportation, inability to secure raw materials or machinery for the manufacture of their products and delivery of their services, acts of God, acts of any government or any agency thereof (including denials or onerous restrictions on required export licenses), and judicial actions.

## ADDITIONAL CARE RECOMMENDATIONS

You should;

- (1) Read and follow all care instructions provided with your LCD TV/ DVD Combo.
- (2) READ and OBSERVE all conditions for mounting the LCD TV/DVD Combo on furniture or walls. Failure to do so may cause the LCD TV/DVD Combo to fall and be damaged. If in doubt contact your reseller for a suitable installation professional, who can provide this service for a fee.
- (3) DO NOT CLEAN THE LCD TV/DVD COMBO GLASS PANEL with anything other than a soft cloth that has been dampened with a weak mixture of mild detergent & water. (Squeeze the cloth until no water is expelled). Use of stronger cleaning agents risks damaging the glass coating and causing a blotching effect, which is not covered under warranty.
- (4) IF PURCHASING THIS LCD TV/DVD COMBO FOR COMMERCIAL USE, discuss your usage patterns with an AV authorised service centre to determine if a preventative maintenance program should be purchased to support your requirements. This is especially important where this LCD TV/DVD Combo is used in a tropical environment, or if the LCD TV/DVD Combo is subject to routine movement.

## STATUTORY RIGHTS AND EXCLUSIONS - AUSTRALIA ONLY



Certain legislation including the Trade Practices Act (1974) and other Commonwealth, State and Territory legislation implies warranties and conditions into consumer contracts. These warranties and conditions exist separately from and are not affected by the Warranties referred to in this booklet. Subject to such legislation and to the express warranties contained in this booklet all warranties, conditions and liability implied by law that may be excluded are hereby excluded and Toshiba shall not be liable for any direct or indirect loss or damage of any kind arising from the products or your use of them (including but not limited to loss of profits and incidental or consequential loss or damage).

## PRIVACY STATEMENT

Information supplied by you is used by Toshiba to process your request and to perform a warranty action. No information will be disclosed without your permission. See Toshiba's Web site for more information. (Address details further in this document).

## TO OBTAIN WARRANTY SERVICE

- (1) Read the owner's manual before operating.
- (2) Contact your Reseller and discuss the problem to eliminate issues related to setup, cables or connected devices. You will be referred to Toshiba if the Reseller determines the problem is related to warranty.
- (3) If your Reseller is unable to assist you, call the Toshiba Service Centre within the Warranty period and no later than 30 days after the discovery of the claimed defect (whichever is the earlier).
- (4) If you call Toshiba Service Centre, a Support Representative will help you to diagnose the problem and identify the most likely method for remedy, including a suitable AV authorised service centre.

- 
- 
- 
- (5) Toshiba maintains a record of warranty entitlement for all LCD TV/ DVD Combos shipped and this will be used to validate your end warranty date. If you disagree with Toshiba's identification of warranty entitlement, you must provide proof of purchase before any warranty service can be performed.
- (6) If you transport or courier the LCD TV/DVD Combo in for service, you agree to insure the LCD TV/DVD Combo, prepay any shipping charges (both ways), and to adequately protect the LCD TV/DVD Combo from damage during shipment by using the original shipping container or equivalent packaging.

Any service outside the scope of this Warranty shall be at Toshiba's or the AV authorised service centre's rates and terms then in effect. Toshiba recommends you confirm these rates and terms prior to signing any AV authorised service centre repair or quote agreement.

### **CONTACTING TOSHIBA ONLINE SUPPORT**

Technical support is available electronically on Toshiba's web site [www.toshibaav.com.au](http://www.toshibaav.com.au). Here you will find answers to many frequently asked technical questions. Additionally, you can obtain a listing of the authorised service centre nearest you.

### **TOSHIBA SERVICE CENTRE - 13 30 70**

Specialist staff provides setup assistance in the first 90 days of purchase and telephone analysis of warranty related issues for the entire warranty period, during normal business hours, 5 days a week.

Be sure to have the following information available before you call:

- Product serial number and part number
- Applicable error messages or problem description

### **COMPLAINTS**

If the warranty service provided does not meet the offer outlined in this document, please detail your concerns in writing to AV Service Complaints, Information Systems Division, Toshiba (Australia) Pty Limited, PO Box 350 North Ryde, NSW, 1670, Australia, or email: [customerrelations@toshiba-tap.c](mailto:customerrelations@toshiba-tap.c)





# TOSHIBA

ColorStream and TheaterWide are registered trademarks of Toshiba America Consumer Products, L.L.C.



49.76A14.001

Printed in China

## Free Manuals Download Website

<http://myh66.com>

<http://usermanuals.us>

<http://www.somanuals.com>

<http://www.4manuals.cc>

<http://www.manual-lib.com>

<http://www.404manual.com>

<http://www.luxmanual.com>

<http://aubethermostatmanual.com>

Golf course search by state

<http://golfingnear.com>

Email search by domain

<http://emailbydomain.com>

Auto manuals search

<http://auto.somanuals.com>

TV manuals search

<http://tv.somanuals.com>