

# OWNER'S MANUAL

---

## LCD Color Television

COLORSTREAM<sup>®</sup> HD

HDTV  
MONITOR

THEATERWIDE HD

# 20DL76

© 2006 TOSHIBA CORPORATION  
All Rights Reserved

### Owner's Record

The model number and serial number are on the back of your TV. Record these numbers in the spaces below. Refer to these numbers whenever you communicate with your Toshiba dealer about this TV.

Model number:   
Serial number:

Introduction

Connecting your TV

Using the remote control

Setting up your TV

Using the TV's features

Appendix

Index

## Dear Customer,

Thank you for purchasing this Toshiba LCD TV. This manual will help you use many exciting features of your new LCD TV. **Before operating the TV, please read this manual completely, and keep it nearby for future reference.**

### Safety Precautions

**WARNING: TO REDUCE THE RISK OF FIRE OR ELECTRIC SHOCK, DO NOT EXPOSE THIS APPLIANCE TO RAIN OR MOISTURE.**



**WARNING**  
RISK OF ELECTRIC SHOCK  
DO NOT OPEN



**WARNING: TO REDUCE THE RISK OF ELECTRIC SHOCK, DO NOT REMOVE COVER (OR BACK). NO USER-SERVICEABLE PARTS INSIDE. REFER SERVICING TO QUALIFIED SERVICE PERSONNEL.**



The lightning symbol in the triangle tells you that the voltage inside this product may be strong enough to cause an electric shock. **DO NOT TRY TO SERVICE THIS PRODUCT YOURSELF.**



The exclamation mark in the triangle tells you that important operating and maintenance instructions follow this symbol.

### WARNING

To prevent injury, this apparatus must be securely attached to the floor/wall in accordance with the installation instructions. (See item 20 on [page 4](#).)

### NOTE TO CATV INSTALLERS

This is a reminder to call the CATV system installer's attention to Article 820-40 of the NEC, which provides guidelines for proper grounding and, in particular, specifies that the cable ground shall be connected to the grounding system of the building, as close to the point of cable entry as practical. For additional antenna grounding information, see items 26 and 27 on [page 4](#).

## FCC Declaration of Conformity Compliance Statement (Part 15):

The **Toshiba 20DL76 LCD Color Televisions** comply with Part 15 of the FCC rules.

Operation is subject to the following two conditions: (1) this device may not cause harmful interference, and (2) this device must accept any interference that may cause undesired operation.

The party responsible for compliance to these rules is: Toshiba America Consumer Products, L.L.C.  
82 Totowa Rd. Wayne, NJ 07470.  
Ph: (973) 628-8000

**Note:** This equipment has been tested and found to comply with the limits for a Class B digital device, pursuant to Part 15 of the FCC rules. These limits are designed to provide reasonable protection against harmful interference in a residential installation. This equipment generates, uses, and can radiate radio frequency energy and, if not installed and used in accordance with the instructions, may cause harmful interference to radio communications. However, there is no guarantee that interference will not occur in a particular installation. If this equipment does cause harmful interference to radio or television reception, which can be determined by removing and applying power to the equipment, the user is encouraged to try to correct the interference by one or more of the following measures:

- Reorient or relocate the receiving antenna.
- Increase the separation between the equipment and the receiver.
- Connect the equipment into an outlet on a circuit different from that to which the receiver is connected.
- Consult the dealer or an experienced radio/TV technician for help.

**CAUTION:** Changes or modifications to this equipment not expressly approved by Toshiba could void the user's authority to operate this equipment.

# Child Safety



## It Makes A Difference Where Your TV Stands

Congratulations on your purchase! As you enjoy your new TV, keep these safety tips in mind:

### The Issue

- o If you are like most consumers, you have a TV in your home. Many homes, in fact, have more than one TV.
- o The home theater entertainment experience is a growing trend, and larger TVs are popular purchases; however, they are not always supported on the proper TV stands.
- o Sometimes TVs are improperly secured or inappropriately situated on dressers, bookcases, shelves, desks, audio speakers, chests, or carts. As a result, TVs may fall over, causing unnecessary injury.



### Toshiba Cares!

- o The consumer electronics industry is committed to making home entertainment enjoyable and safe.
- o The Consumer Electronics Association formed the Home Entertainment Support Safety Committee, comprised of TV and consumer electronics furniture manufacturers, to advocate children's safety and educate consumers and their families about television safety.

### Tune Into Safety

- o One size does NOT fit all! Use appropriate furniture large enough to support the weight of your TV (and other electronic components).
- o Use appropriate angle braces, straps, and anchors to secure your furniture to the wall (but never screw anything directly into the TV).
- o Carefully read and understand the other enclosed instructions for proper use of this product.
- o Do not allow children to climb on or play with furniture and TVs.
- o Avoid placing any item on top of your TV (such as a VCR, remote control, or toy) that a curious child may reach for.
- o Remember that children can become excited while watching a program and can potentially push or pull a TV over.
- o Share our safety message about this hidden hazard of the home with your family and friends. Thank you!



2500 Wilson Blvd.  
Arlington, VA 22201 U.S.A.  
Tel. 703-907-7600 Fax 703-907-7690  
www.CE.org

CEA is the Sponsor, Producer and  
Manager of the International CES®

## Important Safety Instructions

- 1) Read these instructions.
- 2) Keep these instructions.
- 3) Heed all warnings.
- 4) Follow all instructions.



- 5) Do not use this apparatus near water.
- 6) Clean only with dry cloth.
- 7) Do not block any ventilation openings. Install in accordance with the manufacturer's instructions.

- 8) Do not install near any heat sources such as radiators, heat registers, stoves, or other apparatus (including amplifiers) that produce heat.

- 9) Do not defeat the safety purpose of the polarized or grounding type plug. A polarized plug has two blades with one wider than the other. A grounding type plug has two blades and a third grounding prong. The wide blade or the third prong are provided for your safety. If the provided plug does not fit into your outlet, consult an electrician for replacement of the obsolete outlet.

Wide plug

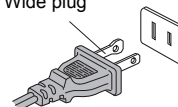

- 10) Protect the power cord from being walked on or pinched, particularly at plugs, convenience receptacles, and the point where they exit from the apparatus.

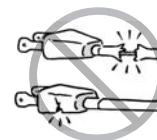

- 11) Only use attachments/accessories specified by the manufacturer.

- 12) Use only with the cart, stand, tripod, bracket, or table specified by the manufacturer, or sold with the apparatus. When a cart is used, use caution when moving the cart/apparatus combination to avoid injury from tip-over.



- 13) Unplug this apparatus during lightning storms or when unused for long periods of time.



- 14) Refer all servicing to qualified service personnel.

Service is required when the apparatus has been damaged in any way, such as power-supply cord or plug is damaged, liquid has been spilled or objects have fallen into the apparatus, the apparatus has been exposed to rain or moisture, does not operate normally, or has been dropped.

- 15) The apparatus shall not be exposed to dripping or splashing and that no objects filled with liquids, such as vases, shall be placed on the apparatus.



- 16) **CAUTION:** To reduce the risk of electric shock, do not use the polarized plug with an extension cord, receptacle, or other outlet unless the blades can be inserted completely to prevent blade exposure.

# Installation, Care, and Service

## Installation

Follow these recommendations and precautions and heed all warnings when installing your TV:

- 17) Never modify this equipment. Changes or modifications may void: a) the warranty, and b) the user's authority to operate this equipment under the rules of the Federal Communications Commission.

- 18)  **DANGER: RISK OF SERIOUS PERSONAL INJURY, DEATH, OR EQUIPMENT DAMAGE!** Never place the TV on an unstable cart, stand, or table. The TV may fall, causing serious personal injury, death, or serious damage to the TV. 

- 19) Never place or store the TV in direct sunlight; hot, humid areas; or areas subject to excessive dust or vibration.

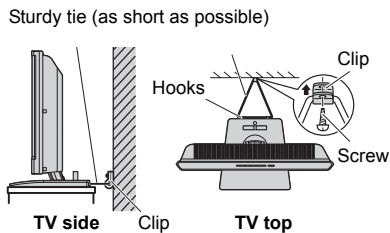
- 20) Always place the TV on the floor or a sturdy, level, stable surface that can support the weight of the unit. To secure the TV, use a sturdy tie from the hooks on the rear of the TV pedestal to a wall, pillar, or other immovable structure. Make sure the tie is tight, secure, and parallel to the floor. Leave a space of at least 4 inches around the TV. Make sure the surface is wide enough so that the TV's width and depth don't exceed the surface's edges. If not, the TV may lean or fall over and cause an injury.
- 

- 21) Never expose the apparatus to dripping or splashing liquid or place items such as vases, aquariums, any other item filled with liquid, or candles on top of the TV.

- 22) Never block or cover the slots or openings in the TV cabinet back, bottom, and sides. Never place the TV:
- on a bed, sofa, rug, or similar surface;
  - too close to drapes, curtains, or walls; or
  - in a confined space such as a bookcase, built-in cabinet, or any other place with poor ventilation.
- 
- The slots and openings are provided to protect the TV from overheating and to help maintain reliable operation of the TV.

- 23) Never allow anything to rest on or roll over the power cord, and never place the TV where the power cord is subject to wear or abuse.

- 24) Never overload wall outlets and extension cords.

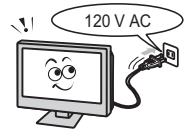

- 25) Always operate the TV with a 120 V AC, 60Hz power source only.

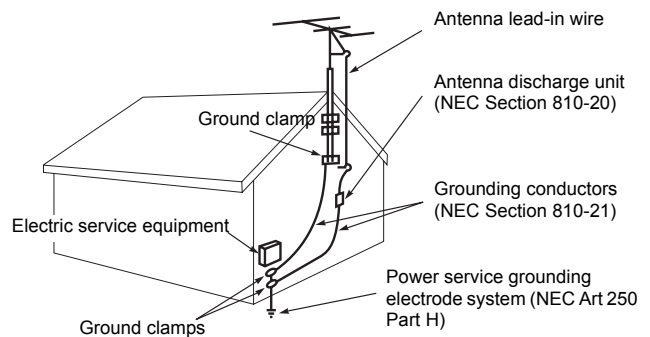

- 26) Always make sure the antenna system is properly grounded to provide adequate protection against voltage surges and built-up static charges (see Section 810 of the National Electric Code).



- 27) **DANGER: RISK OF SERIOUS PERSONAL INJURY OR DEATH!**

- Use extreme care to make sure you are never in a position where your body (or any item you are in contact with, such as a ladder or screwdriver) can accidentally touch overhead power lines. Never locate the antenna near overhead power lines or other electrical circuits.
  - Never attempt to install any of the following during lightning activity:
    - a) an antenna system; or b) cables, wires, or any home theater component connected to an antenna or phone system.
- 
- 

## Care

For better performance and safer operation of your TOSHIBA TV, follow these recommendations and precautions:

- 28) If you use the TV in a room whose temperature is 32 °F (0°C) or below, the picture brightness may vary until the LCD warms up. This is not a sign of malfunction.

29) Always unplug the TV before cleaning. Wipe the display panel surface gently using only a soft cloth (cotton, flannel, etc.). A hard cloth may damage the surface of the panel. Avoid contact with alcohol, thinner, benzene, acidic or alkaline solvent cleaners, abrasive cleaners, or chemical cloths, which may damage the surface. Do not spray volatile compounds such as insecticide on the cabinet. This may cause a discoloration or damage the cabinet.



30) **WARNING: RISK OF ELECTRIC SHOCK!**

Never spill liquids or push objects of any kind into the TV cabinet slots.



31) While it is thundering, do not touch the connecting cables or apparatus. Failure to follow this instruction may result in electric shock.

32) For added protection of your TV from lightning and power surges, always unplug the power cord and disconnect the antenna from the TV if you leave the TV unattended or unused for long periods of time.

33) During normal use, the TV may make occasional snapping or popping sounds. This is normal, especially when the unit is being turned on or off. If these sounds become frequent or continuous, unplug the power cord and contact a Toshiba Authorized Service Center.

34) **WARNING: RISK OF SERIOUS PERSONAL INJURY OR EQUIPMENT DAMAGE!**



Never strike the screen with a sharp or heavy object.

35) The LCD screen of this product can be damaged by Ultraviolet Radiation from the sun. When selecting a location for the television, avoid locations where the screen may be exposed to direct sunlight, such as in front of a window.

Never touch, press, or place anything on the LCD screen. These actions will damage the LCD screen. If you need to clean the LCD screen, follow the instructions in item 29 on [page 5](#).

## Service

36) **WARNING: RISK OF ELECTRIC SHOCK!**

Never attempt to service the TV yourself. Opening and removing the covers may expose you to dangerous voltage or other hazards. Refer all servicing to a Toshiba Authorized Service Center.



37) If you have the TV serviced:

- Ask the service technician to use only replacement parts specified by the manufacturer.
- Upon completion of service, ask the service technician to perform routine safety checks to determine that the TV is in safe operating condition.

38) The cold cathode fluorescent lamp in the LCD panel contains a small amount of mercury. When the TV reaches the end of its useful life, dispose of the used TV by the approved method for your area, or ask a qualified service technician to properly dispose of the TV.



**Note:** The lamp unit contains mercury, the disposal of which may be regulated due to environmental considerations. For disposal or recycling information, contact your local authorities or the Electronics Industries Alliance ([www.eiae.org](http://www.eiae.org)).

## Important notes about your LCD TV

The following symptoms are technical limitations of LCD Display technology and are not an indication of malfunction. Therefore, TACP/TCL is not responsible for perceived defects resulting from these symptoms.

- 1) An afterimage (ghost) may appear on the screen if a fixed non-moving image is displayed for a long period of time. The afterimage is not permanent and will disappear in a short period of time.
- 2) The LCD panel contained in this TV is manufactured using an extremely high level of precision technology; however, there may be an occasional pixel (dot of light) that does not operate properly (that does not light, that remains constantly lit, etc.). This is a structural property of LCD technology, is not a sign of malfunction, and is not covered under your warranty. Such pixels are not visible when the picture is viewed from a normal viewing distance.

**Note:** Interactive video games that involve shooting a "gun" type of joystick at an on-screen target may not work on this TV.



**WARNING: Do not swallow the battery.**



No eating!

<b>Introduction .....</b>	<b>7</b>	<b>Using the TV's features .....</b>	<b>26</b>
Welcome to Toshiba .....	7	Switching between two channels using	
Supplied accessories .....	7	Channel Return .....	26
Connecting the power cord .....	7	Using the Blue screen feature .....	26
Exploring your new TV .....	8	Selecting the video input source .....	26
Cable clamper .....	9	Selecting the picture size .....	27
Adjusting the TV viewing angle .....	9	Using the V-Chip menu .....	28
<b>Connecting your TV .....</b>	<b>10</b>	V-Chip rating and categories .....	28
Connecting an antenna or cable TV .....	10	V-Chip blocking (Parental control) setup .....	29
Connecting a VCR .....	11	Adjusting the picture .....	30
Connecting cable converter box .....	11	Selecting the picture mode .....	30
Connecting a cable converter box and a VCR .....	12	Adjusting the picture quality and advanced picture	
Connecting a DVD player with ColorStream®		quality .....	30
(component video) and a VCR .....	13	Using the Closed Caption feature .....	31
Connecting a DTV receiver/set-top box with		Setting the sleep timer .....	32
ColorStream® (component video) and a VCR .....	14	Setting the Backlight .....	32
Connecting an audio system .....	15	Adjusting the sound .....	33
Connecting a camcorder .....	15	Muting the sound .....	33
Connecting a personal computer (PC) .....	16	Selecting stereo/SAP broadcasts .....	33
<b>Using the remote control .....</b>	<b>17</b>	Selecting the sound mode .....	34
Learning about the remote control .....	17	Adjusting the sound quality .....	34
Installing or replacing the remote control batteries .....	18	Using the AVL	
Remote control effective range .....	18	(Automatic Volume Leveler) feature .....	35
Using the remote control to operate your other devices ..	19	Using the Speaker Out feature .....	35
Programming the remote control to operate		Using the PC setting feature .....	36
your other devices .....	20	Using the Panel Lock feature .....	37
<b>Setting up your TV .....</b>	<b>23</b>	Displaying on-screen information .....	37
Learning about the On-Screen Display (OSD)		Understanding the last mode memory feature .....	37
menu system .....	23	<b>Appendix .....</b>	<b>38</b>
Changing the on-screen display language .....	24	Specifications .....	38
Adding channels to the TV's memory .....	24	Troubleshooting .....	39
Programming channels automatically .....	24	Limited United States Warranty .....	40
Adding and erasing channels manually .....	25	Limited Canada Warranty .....	41
Changing channels .....	25	<b>Index .....</b>	<b>42</b>
Programming your favorite channels .....	25		

# Introduction

## Welcome to Toshiba

Thank you for purchasing this Toshiba LCD TV. The goal of this manual is to guide you through setting up and operating your Toshiba TV as quickly as possible.

The model and serial numbers are on the back of your TV. Write these numbers in the space provided on the front cover of this manual for your records.

Instructions in this manual are based on using the remote control. You also can use the controls on the TV if they have the same name as those referred to on the remote control.

Please read all the safety and operating instructions carefully, and keep this manual for future reference.

## Supplied accessories

Check that you have the accessories and items shown.

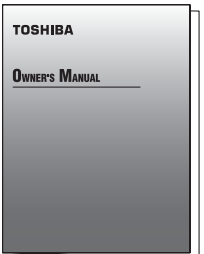
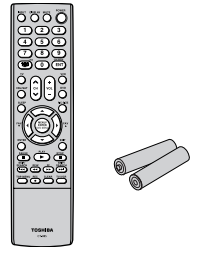
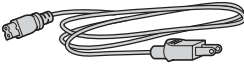
Owner's Manual (This book)	Remote control Battery (AAA) X 2	Power cord
		

## Connecting the power cord

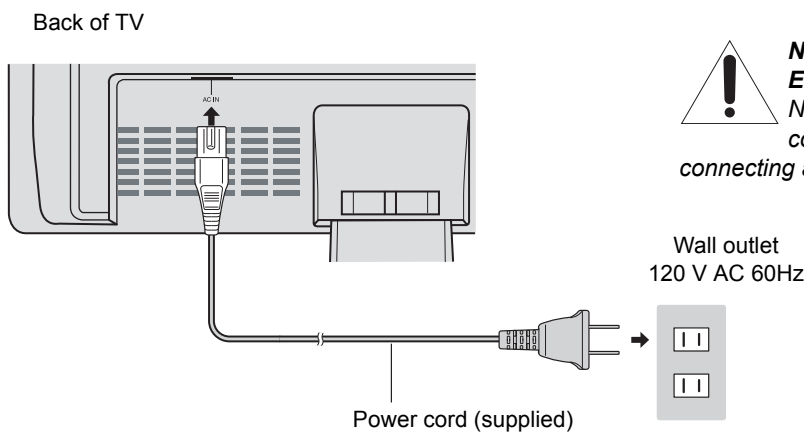

**NOTE: RISK OF EQUIPMENT DAMAGE!**  
Never plug in any power cords until you have finished connecting all equipment (see [page 10](#)).

\* The power cord supplied with this product is to be used in the United States and Canada only.

## Exploring your new TV

You can operate your TV by using the buttons on the right side panel or the remote control. The A/V terminals for connecting other equipment to your TV are on the back panel (see illustrations below). Also see [Connecting your TV](#) from page 10 to page 16.

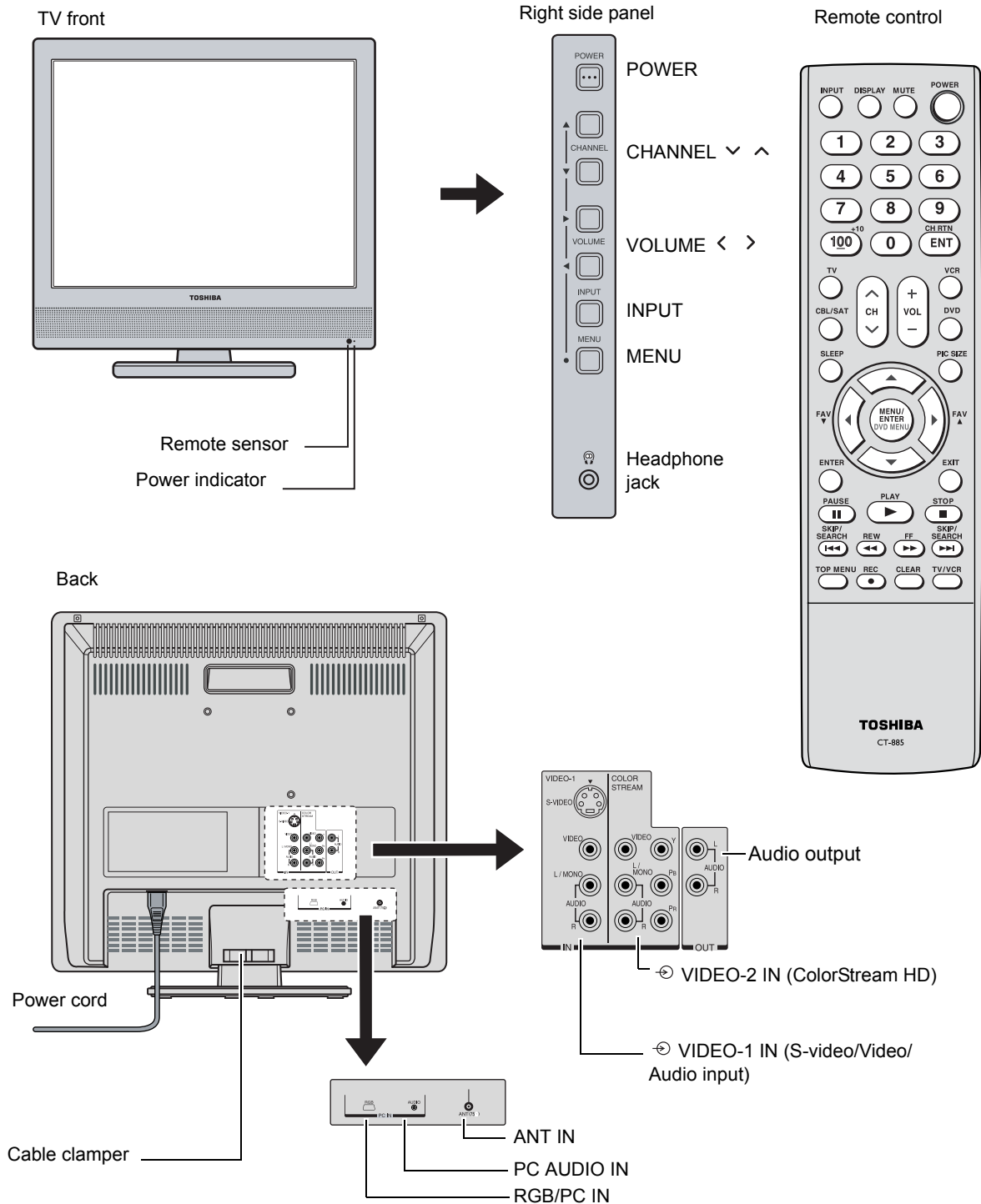



### Cable clamber

The cable clamber can be used to bundle the connection cables (see [page 10](#)).

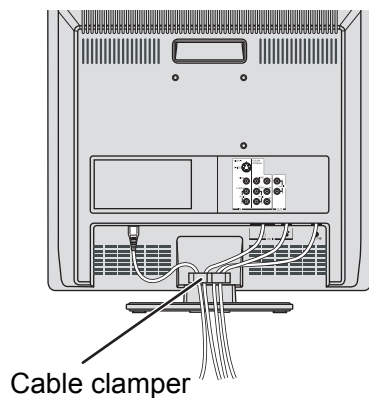

### Adjusting the TV viewing angle

You can adjust the angle of the TV screen.

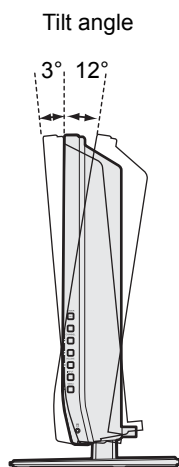

**WARNING: RISK OF  
SERIOUS PERSONAL  
INJURY OR EQUIPMENT**

**DAMAGE!**

*Never grasp the cable clamber when moving or lifting the TV. The cable clamber could break, causing the TV to fall.*

## Connecting your TV

**Note:** All required cables, if not provided with your other devices, can be purchased at many electronics accessory suppliers.

- **Coaxial (F-type) cable** is used for connecting your antenna, cable TV service, and/or cable converter box to the ANT 75 Ω RF input on your TV.
- **Standard A/V cables (composite video)** usually come in sets of three, and are for use with video devices with standard audio and standard (composite) video output. These cables (and the related inputs on your TV) are typically color-coded according to use: yellow for video, red for stereo right audio, and white for stereo left (or mono) audio.
- **S-video cable** is for use with video devices with S-video output. Separate audio cables are required for a complete connection.
 

**Note:** An S-video cable provides better picture performance than a standard (composite) video cable.
- **Component video cables** come in sets of three and are for use with video devices with component video output. These cables are typically color-coded red, green, and blue. (ColorStream® is Toshiba's brand of component video.) Separate audio cables are required for a complete connection.
 

**Note:** Component video cables provide better picture performance than a standard (composite) video or S-video cable.
- **Mini D-sub 15-pin cable** is for use with a personal computer with an analog RGB (15-pin) output. A separate audio cable is required for a complete connection.

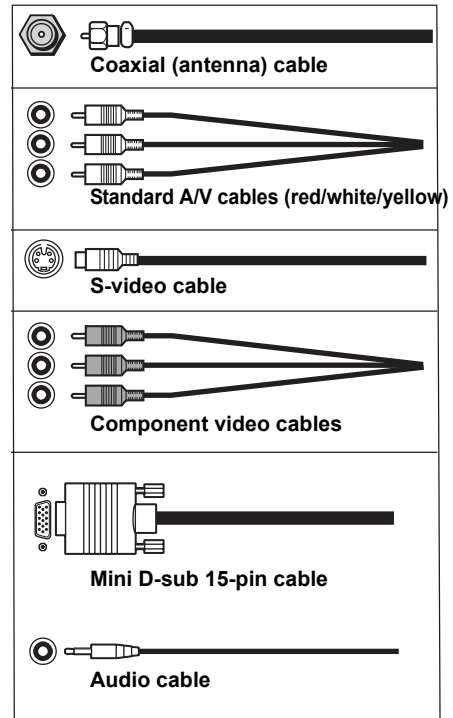

## Connecting an antenna or cable TV

This connection allows you to watch TV programs or basic cable channels.

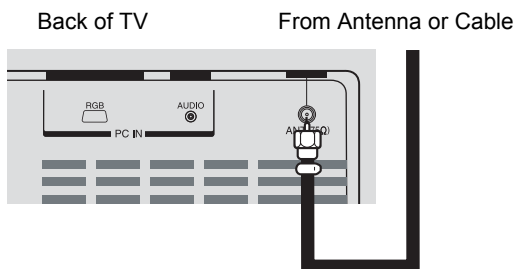

**NOTE: RISK OF EQUIPMENT DAMAGE!**  
 Never plug in any power cords until you have finished connecting all equipment.

## Connecting a VCR

This connection allows you to watch local channels and video programs, play or record on the VCR while watching TV, and record from one channel while watching another channel.

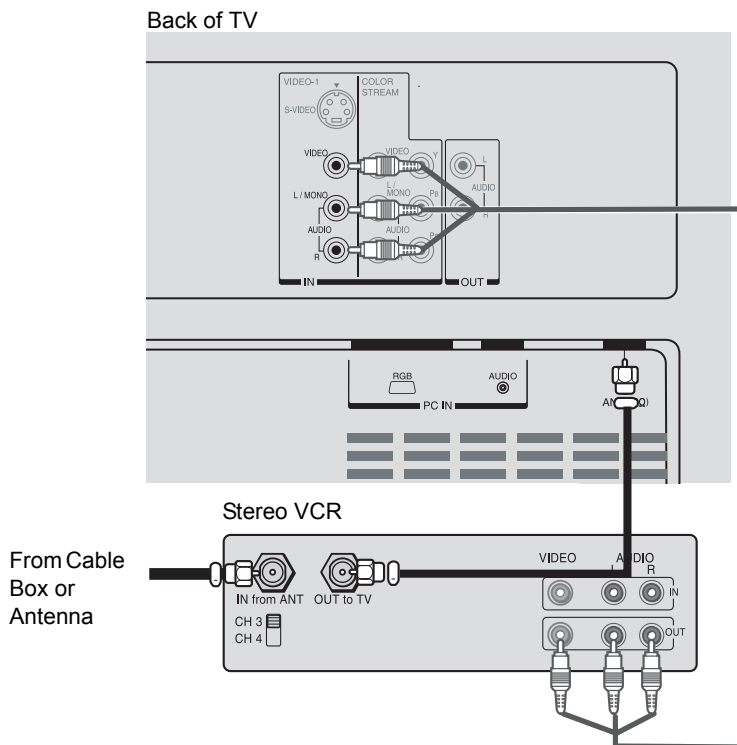

### Note:

If you have a mono VCR, connect L/Mono to VCR Audio OUT using only one audio cable.  
If you have a VCR with S-video, use an S-video cable (in the S-video jacks) instead of a standard video cable.

## Connecting cable converter box

This connection allows you to watch basic and premium cable channels. Tune the TV to channel 3 or 4 (whichever channel is vacant in your area), and use the converter box to change channels.

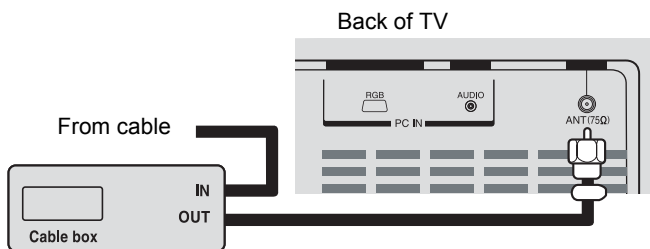

### Note:

When you use a converter box with your TV, the remote control will not operate some features, such as favorite channel programming or channel return.

## Connecting a cable converter box and a VCR

This connection allows you to watch and record basic and premium cable channels, as well as watch videotapes. Set the TV signal source to VIDEO1 (page 26). Tune the VCR to channel 3 or 4 (the same channel as the converter box output switch), and use the cable converter box to change channels.

Back of TV

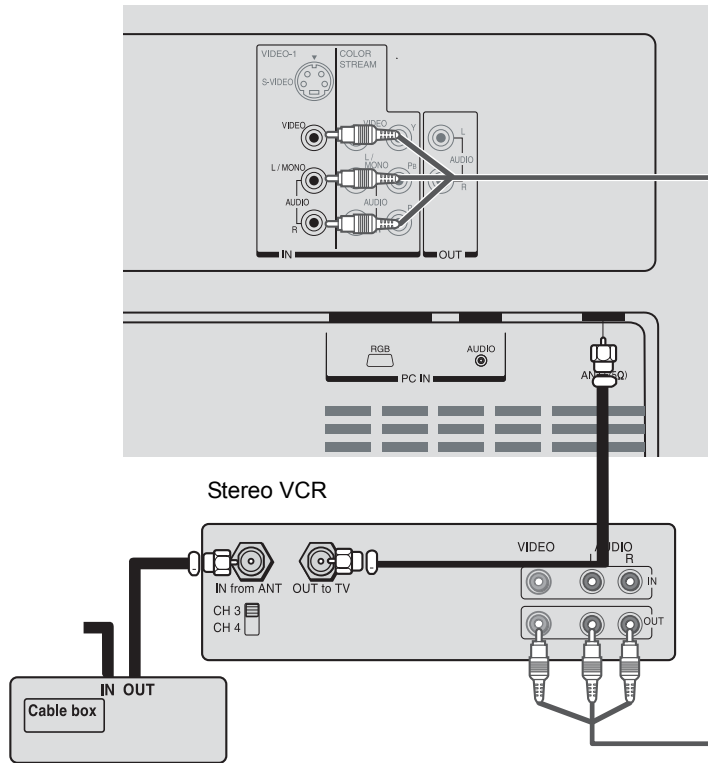

### Note:

When you use a converter box with your TV, the remote control will not operate some features, such as favorite channel programming or channel return.

If you have a mono VCR, connect L/Mono to VCR Audio OUT using only one audio cable.

If you have a VCR with S-video, use an S-video cable (in the S-video jacks) instead of a standard video cable.

The unauthorized recording, use, distribution, or revision of television programs, videotapes, DVDs, and other materials is prohibited under the Copyright Laws of the United States and other countries, and may subject you to civil and criminal liability.

## Connecting a DVD player with ColorStream® (component video) and a VCR

This connection allows you to watch DVD, VCR, and TV programs, and record TV programs.

Your TV has ColorStream® (component video) inputs. Connecting your TV to a DVD player with component video can greatly enhance picture quality and realism.

- To record one TV program while watching another TV program, tune the VCR to the channel to record, and tune the TV to the channel to watch.
- To record a TV program while watching a DVD, tune the VCR to the channel to record, and select VIDEO2 on the TV (see ["Selecting the video input source" on page 26](#)).

### Note:

For the highest possible picture quality, use component video cables between the TV and DVD player.

The ColorStream jacks can be used with 480i and 480p scan system.

The unauthorized recording, use, distribution, or revision of television programs, videotapes, DVDs, and other materials is prohibited under the Copyright Laws of the United States and other countries, and may subject you to civil and criminal liability.

Back of TV

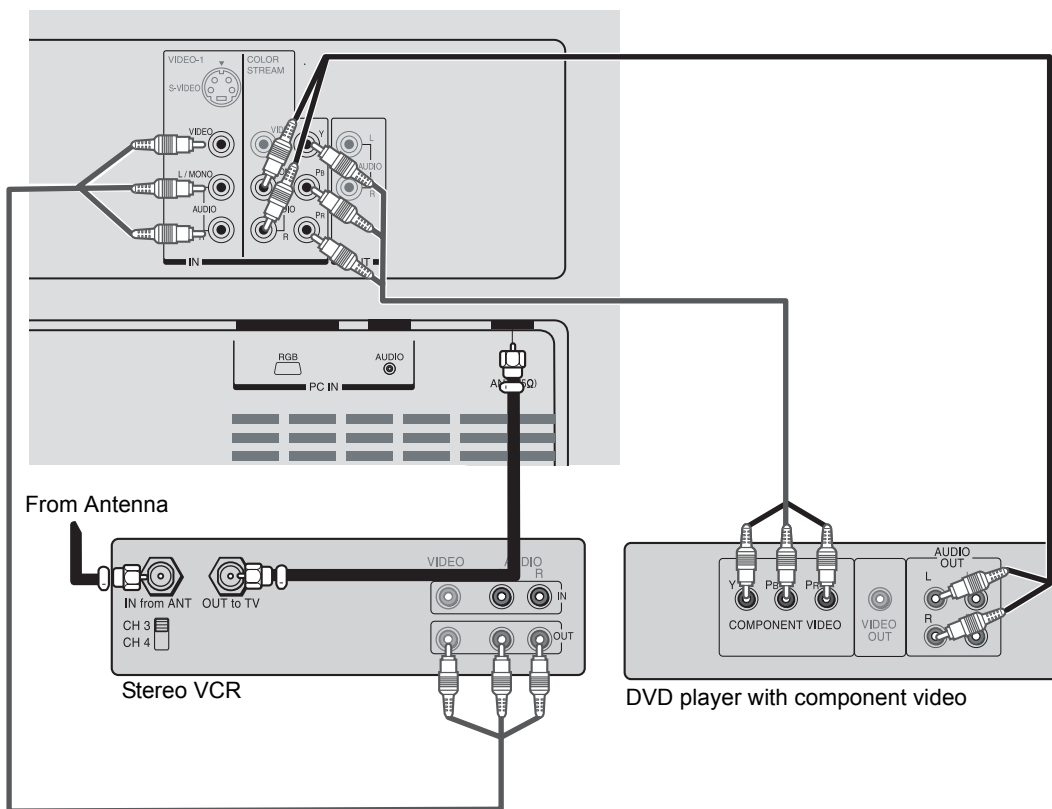

## Connecting a DTV receiver/set-top box with ColorStream® (component video) and a VCR

This connection allows you to watch DTV (digital TV), VCR, and TV programs, and record DTV (composite video only) and TV programs.

Your TV has ColorStream® (component video) inputs. Connecting your TV to a DTV receiver with component video can greatly enhance picture quality and realism.

- To record and watch a DTV program, select LINE IN on the VCR, and select VIDEO1 on the TV (see "[Selecting the video input source](#)" on page 26).
- To record a TV program while watching a DTV program, tune the VCR to the channel to record, and select VIDEO2 on the TV.
- To record and watch the same TV program, tune the VCR to the channel to record, and select VIDEO1 on the TV.
- To record one TV program while watching another TV program, tune the VCR to the channel to record, and tune the TV to the channel to watch.

**Note:**

*For the highest possible picture quality, use component video cables between the TV and DTV receiver/set-top box.*

*The TV side panel can be used to connect a VCR with S-video.*

**The unauthorized recording, use, distribution, or revision of television programs, videotapes, DVDs, and other materials is prohibited under the Copyright Laws of the United States and other countries, and may subject you to civil and criminal liability.**

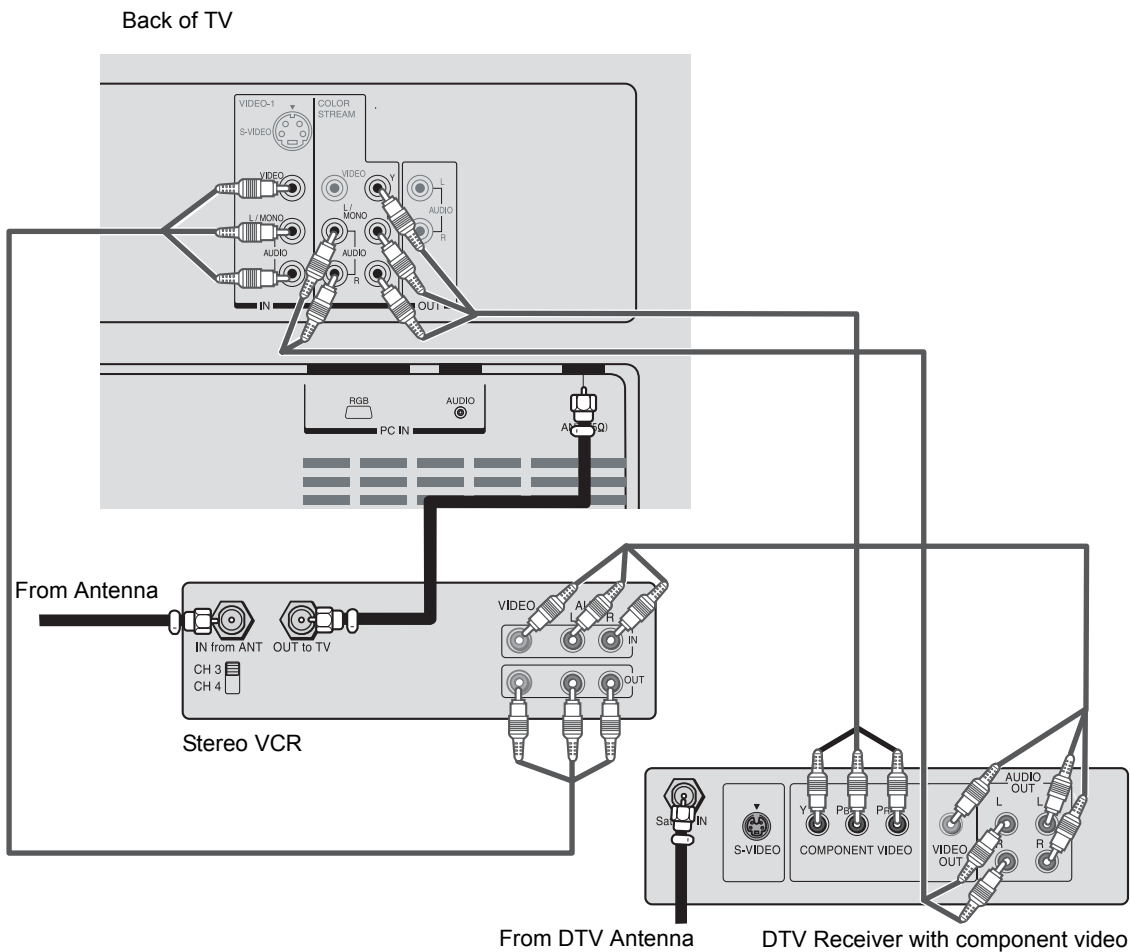

## Connecting an audio system

This connection allows you to hear the TV sound through external speakers connected to an audio amplifier. The audio signal level (fixed) is not affected by pressing the volume buttons on the TV or the TV's remote control. To control the audio through the amplifier, use the audio system's remote control.

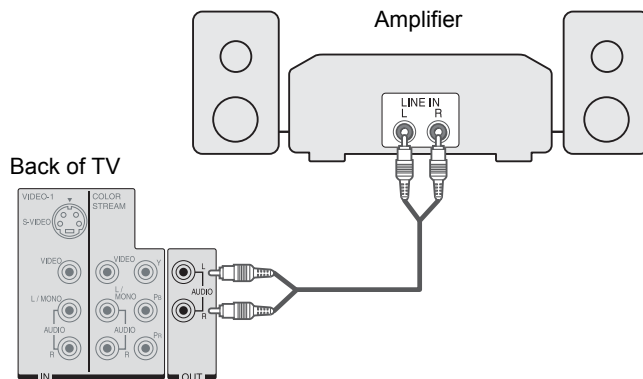

**Note:**

Set the TV's volume to the minimum level if necessary.

## Connecting a camcorder

This connection allows you to watch video materials recorded on a camcorder.

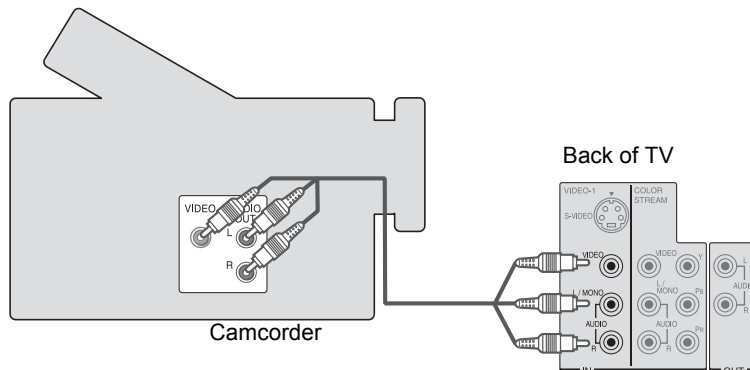

**Note:**

If you have a camcorder with S-video, use an S-video cable instead of a standard video cable for better picture performance.

## Connecting a personal computer (PC)

This connection allows you to view the image of a personal computer (PC) on the TV screen. When connecting a PC to the TV, use an analog RGB (15-pin) computer cable and a PC audio cable.

- To use a PC, set the monitor output resolution on the PC before connecting it to the TV. The following signals can be displayed.
  - SVGA: VESA 800 X 600 @ 60HzOther formats or non-standard signals may not be displayed correctly.
- To display the optimum picture, use the PC setting feature. (see ["Using the PC setting feature" on page 36](#)).

### Note:

- Some PC models cannot be connected to this TV.
- An adapter is not needed for computers with a DOS/V compatible mini D-sub 15-pin terminal.
- Depending on the DVD's title and the specifications of the PC on which you are playing the DVD-Video, some scenes may be skipped or you may not be able to pause during multi-angle scenes.

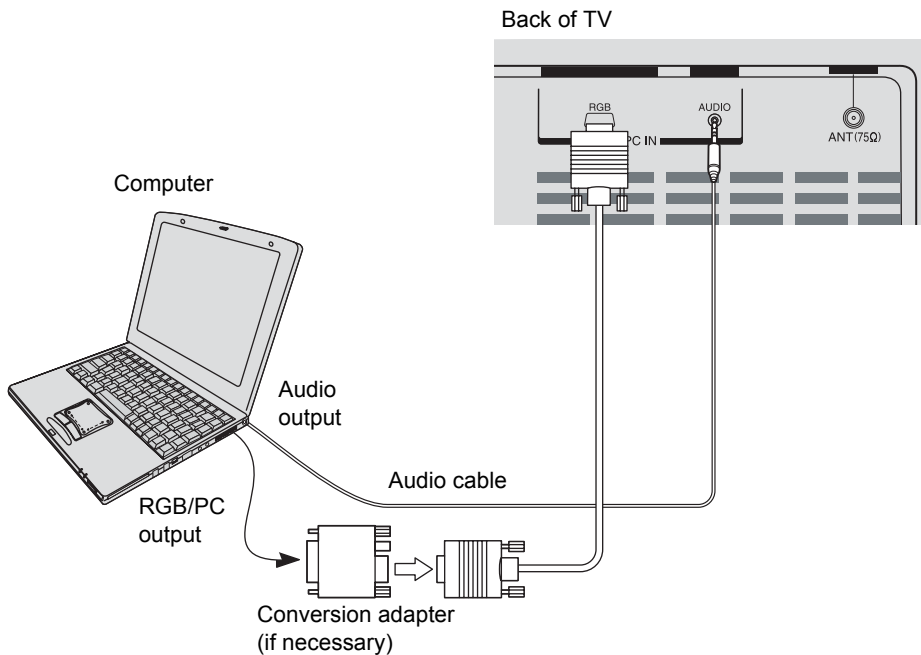



# Using the remote control

## Learning about the remote control

1. **POWER:** Turns the TV on and off (standby mode\*).
2. **MUTE:** Turns off the sound (page 33).
3. **DISPLAY:** Displays TV settings on-screen (page 37) or closes the on-screen menu.
4. **INPUT:** Selects the video input source (page 26).
5. **Channel Numbers (0-9, 100):** Allow direct access to channels (page 25).
6. **CH RTN/ENT:** Enacts the selected channel/switches between the last two viewed channels (page 26).
7. **TV:** Selects TV mode (page 20).
8. **VCR:** Selects VCR mode (page 19).
9. **CBL/SAT:** Selects CBL/SAT mode (page 19).
10. **DVD:** Selects DVD mode (page 20).
11. **VOL (volume) + -:** Adjust the volume level.
12. **CH (channel) ^ v:** Cycle through programmed channels (page 24).
13. **PIC SIZE:** Cycles through the picture sizes: 4:3, 16:9 (page 27).
14. **SLEEP:** Sets the TV to turn off at a specific time (page 32).
15. **▲▼◀▶ (arrow buttons):** Select or adjust menu items (page 23).
16. **FAV ▲▼:** Cycle through channels you programmed as favorite channels (page 25).
17. **MENU/ENTER:** Accesses the menu system (page 23).
18. **EXIT:** Returns to the previous On-Screen Display (OSD) menu, or leaves and saves the menu settings (page 23).

First press TV to control the TV.

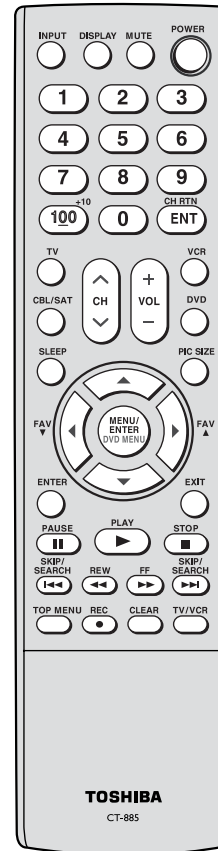

\* The TV is in standby mode when the power is OFF but the power cord is still plugged into an outlet.

## Installing or replacing the remote control batteries

To install the batteries:

1. Open the battery cover on the back of the remote control.
2. Install two batteries (R03 size "AAA"). Match the + and – signs on the batteries to the signs on the battery compartment.

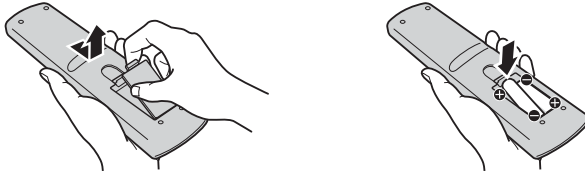

3. Replace the battery cover on the remote control until the lock snaps.

## Remote control effective range

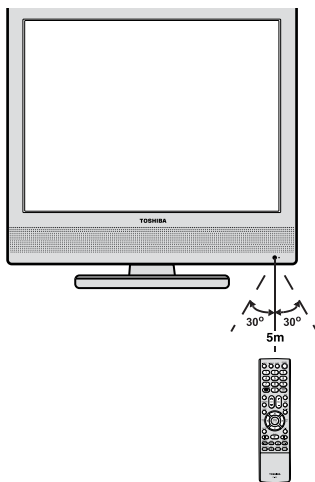

### Caution:

*Never throw batteries into a fire.*

### Note:

- Be sure to use AAA batteries.
- Dispose of batteries in a designated disposal area.
- The batteries should always be disposed of with the environment in mind. Always dispose of the batteries in accordance with applicable laws and regulations.
- If the remote control does not operate correctly, or if the operating range becomes reduced, replace the batteries with new ones.
- Always remove the batteries from remote control if they are dead or if the remote control is not to be used for an extended period of time. This will prevent battery acid from leaking into the battery compartment.

## Using the remote control to operate your other devices

### To control a cable TV converter/satellite receiver:

Program the remote control to recognize the brand of your cable TV converter/satellite receiver (see ["Programming the remote control to operate your other devices on page 20"](#)).

The buttons shown at right will control the cable TV converter/satellite receiver.

Press CBL/SAT first.

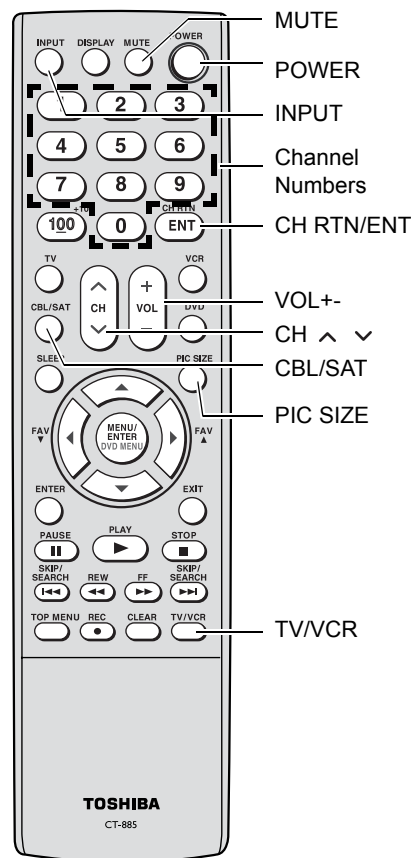

### To control a VCR:

Program the remote control to recognize the brand of your VCR (see ["Programming the remote control to operate your other devices on page 20"](#)).

The buttons shown at right will then control the VCR.

Press VCR first.

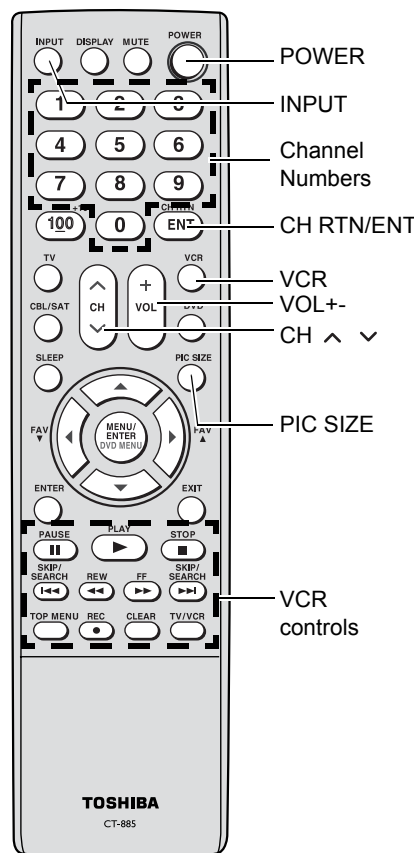

## To control a DVD player:

Program the remote control to recognize the brand of your DVD player (see [Programming the remote control to operate your other devices](#) below).

The buttons shown at right will then control the DVD player. Press DVD first.

## Programming the remote control to operate your other devices

This remote control is pre-programmed to operate most Toshiba satellite receivers, VCRs, and DVD players. To control a non-Toshiba device (or a Toshiba device that the remote control is not reprogrammed to operate), you must follow the steps below to program your remote control.

1. Refer to the code tables (on pages 21 and 22) to find the corresponding code for your device.  
If more than one code is listed, try each one separately until you find the one that works.
2. If you are programming the remote control to operate your:
  - Cable TV converter/satellite receiver: Press CBL/SAT.
  - VCR: Press VCR.
  - DVD player: Press DVD.
3. While holding down DISPLAY, press the Channel Number buttons to enter the three-digit code for your device within 10 seconds.

**Note:** If you do not enter the code within 10 seconds from step 3, or if you enter the wrong code, this operation is canceled.

4. Point the remote control at the cable TV converter/satellite receiver, VCR or DVD player, and press POWER to test the code.
  - If the device responds, you entered the correct code.
  - If the device does not respond, repeat steps 1–4 using another code.
5. Press TV to control the TV.

For future reference, write down the codes you used:

Cable TV converter/satellite receiver code \_\_\_\_\_

VCR code \_\_\_\_\_

DVD player code \_\_\_\_\_

### Note:

- When shipped from the factory, the remote control is set to operate your TV.
- Each time you replace the batteries, you must reprogram the remote control.
- Some newer VCRs are capable of working on either of two remote codes. These VCRs have a switch labeled VCR1/VCR2. If your VCR has this kind of switch and does not respond to any of the codes for your VCR, set the switch to the other position (VCR1 or VCR2) and reprogram the remote control.

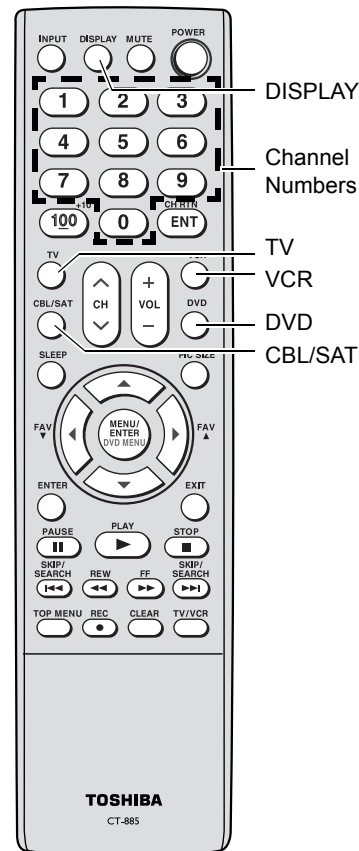
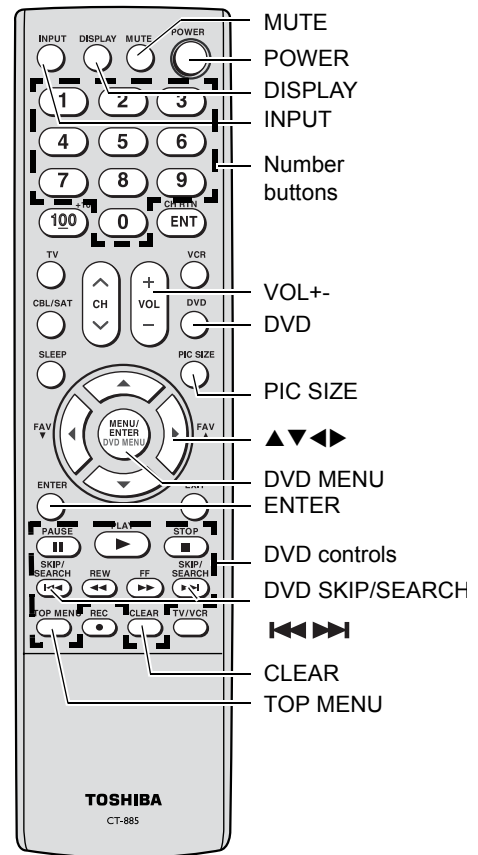

# Cable TV converter/satellite receiver, VCR and DVD player code tables

## [For CBL/SAT Mode]

<p><b>Cable converter box</b></p> <p>ABC: 061, 062, 063, 082, 084, 087, 091, 092, 096, 098</p> <p>Archer: 065, 092, 097, 099</p> <p>Cableview: 064, 094</p> <p>Century: 092</p> <p>Citizen: 090, 092, 097</p> <p>Contec: 083, 085, 086, 088, 093, 098</p> <p>Diamond: 093</p> <p>Eagle: 091</p> <p>GE: 061, 062</p> <p>Gemini: 069, 070, 094</p> <p>General Instruments: 062, 089, 096</p> <p>Hamlin: 093</p> <p>Hitachi: 062, 095, 096</p>	<p>Jasco: 097</p> <p>Jerrold: 062, 069, 071, 082, 086, 089, 091, 096</p> <p>Magnavox: 072, 096</p> <p>Memorex: 091, 092, 104</p> <p>Multi Canal: 090</p> <p>Novavision: 101</p> <p>Panasonic: 081, 083, 085</p> <p>Philco: 087</p> <p>Philips: 066, 067, 068, 070, 072, 073, 074, 075, 091, 092</p> <p>Pioneer: 076, 077</p> <p>Proscan: 061, 062</p> <p>Radio Shack: 092, 097, 099</p> <p>RCA: 064, 081</p> <p>Realistic: 065</p> <p>Recoton: 102</p> <p>Samsung: 077, 090</p>	<p>Scientific Atlanta: 063, 078, 079, 080, 088, 098, 101, 105</p> <p>Sears: 095</p> <p>Signature: 062</p> <p>Signature 2000: 096</p> <p>Sprucer: 081, 085</p> <p>Starcom: 069, 082, 087, 096, 103, 104</p> <p>Stargate: 069, 090</p> <p>Sylvania: 095, 100</p> <p>TeleView: 090</p> <p>Texscan: 100</p> <p>Tocom: 071, 084, 085</p> <p>U. S. Electronics: 087, 096, 098</p> <p>United Cable: 082</p> <p>Universal: 065, 092, 097, 099, 102, 103</p> <p>Wards: 096</p>	<p><b>Satellite</b></p> <p>Alphastar: 038, 059</p> <p>Chaparral: 034</p> <p>DISH Network: 057</p> <p>Drake: 020, 040, 044, 046, 050, 053</p> <p>Echostar: 018, 041, 051</p> <p>Express Vu: 057</p> <p>Fujitsu: 027</p> <p>GE: 008, 009, 013</p> <p>General Instruments: 010, 011, 012, 022, 023, 031, 049</p> <p>Hitachi: 033</p> <p>Hughes: 033</p> <p>Hughes Network Systems: 019</p> <p>Intersat: 048</p> <p>Janel: 027</p> <p>JVC: 017, 057</p> <p>Kenwood: 029</p> <p>Magnavox: 060</p>	<p>Optimus: 058</p> <p>Pansat: 036, 052</p> <p>Primestar: 015, 042</p> <p>Proscan: 008, 009, 013</p> <p>Radio Shack: 022, 023, 030</p> <p>RCA: 008, 009, 013, 016</p> <p>Realistic: 030</p> <p>Samsung: 059</p> <p>Sony: 014, 055</p> <p>Star Choice: 057</p> <p>Star Trak: 025, 026, 037, 054</p> <p>STS: 024</p> <p>Toshiba: 000, 001, 002, 003, 004, 005, 006, 007, 020, 031, 056</p> <p>Uniden: 021, 028, 030, 032, 035, 039, 043, 045, 047, 058</p> <p>Zenith: 027</p>
---	---	---	--	---

## [For VCR Mode]

<p><b>VCR</b></p> <p>Admiral: 049</p> <p>Aiko: 019</p> <p>Aiwa: 018</p> <p>Akai: 003, 004, 037, 038, 039, 058, 069</p> <p>Audiovox: 010</p> <p>Bell &amp; Howell: 007, 068</p> <p>Broksonic: 008, 017</p> <p>Calix: 010</p> <p>Carver: 026</p> <p>CCE: 019</p> <p>Citizen: 009, 010, 011, 012, 013, 014, 015, 019, 057, 073</p> <p>Colortyme: 005</p> <p>Craig: 009, 010, 016, 061, 065, 079</p> <p>Curtis Mathes: 001, 005, 009, 012, 014, 040, 048, 053, 056, 057</p> <p>Daewoo: 011, 013, 015, 017, 018, 019, 057, 078</p> <p>Daytron: 078</p> <p>Denon: 063</p> <p>Dimensia: 001, 048</p> <p>Electrohome: 010, 020, 065</p> <p>Emerson: 003, 008, 010, 011, 017, 018, 020, 028, 039, 054, 057, 062, 065, 068, 072</p> <p>Fisher: 007, 016, 021, 022, 023, 057, 064, 068, 070, 071, 079</p> <p>Fuji: 004, 041</p> <p>Funai: 018, 073</p> <p>Garrard: 018</p> <p>GE: 001, 002, 009, 040, 042, 048, 056</p> <p>Go Video: 056, 059,</p>	<p>061, 081</p> <p>Goldstar: 005, 010, 014, 054, 056, 065, 067</p> <p>Gradiente: 018, 065</p> <p>Harman Kardon: 005</p> <p>Hitachi: 024, 025, 035, 037, 042, 063, 070, 080</p> <p>JBL: 076</p> <p>JC Penney: 005, 006, 007, 008, 009, 010, 023, 024, 025, 026, 035, 056, 061, 063, 065</p> <p>Jensen: 024, 025, 037</p> <p>JVC: 005, 006, 007, 014, 037, 043, 062, 063, 068, 082</p> <p>Kenwood: 005, 006, 007, 012, 014, 037, 043, 053, 068, 071</p> <p>Kodak: 010</p> <p>LG: 010</p> <p>Lloyds: 053, 073, 079</p> <p>Logik: 061</p> <p>LXI: 010</p> <p>Magnasonic: 061, 065, 078</p> <p>Magnavox: 026, 027, 034, 044, 057, 061, 072</p> <p>Marantz: 005, 006, 007, 012, 014, 026, 053, 067</p> <p>Memorex: 007, 009, 010, 016, 018, 034, 049, 063, 065, 066, 068, 075, 079</p> <p>MGA: 020, 028, 039</p> <p>MGN: 056</p> <p>Minolta: 024, 025, 035, 063</p>	<p>Mitsubishi: 020, 024, 025, 028, 039, 043, 065</p> <p>Montgomery Ward: 049</p> <p>Motorola: 049</p> <p>MTC: 009, 046, 061</p> <p>Multitech: 009, 012, 018</p> <p>NEC: 005, 006, 007, 012, 014, 037, 043, 053, 054, 067, 070</p> <p>Nikko: 010</p> <p>Noblex: 009</p> <p>Optimus: 010, 049, 065</p> <p>Optonica: 031</p> <p>Orion: 054, 057, 062, 065, 068, 072</p> <p>Panasonic: 036, 045, 046, 057, 061, 072, 079</p> <p>Pentax: 012, 024, 025, 035, 042, 053, 063</p> <p>Pentex Research: 014</p> <p>Philco: 026, 027, 063</p> <p>Philips: 026, 031, 044, 057</p> <p>Pioneer: 006, 024, 043, 055</p> <p>Portland: 012, 013, 015</p> <p>Proscan: 001, 002, 048</p> <p>Proton: 061</p> <p>Quasar: 045</p> <p>Radio Shack: 010, 031, 065</p> <p>Radio Shack/Realistic: 007, 009, 010, 016, 018, 020, 021, 022, 031, 049</p> <p>Radix: 010</p> <p>RCA: 001, 002, 003, 009, 024, 025, 029, 035, 040, 042, 045, 048, 055, 056, 063, 071, 083</p>	<p>Realistic: 007, 009, 010, 011, 016, 018, 020, 021, 022, 031, 049, 051, 056, 060, 065, 075, 079</p> <p>Ricoh: 047</p> <p>Runco: 034</p> <p>Samsung: 009, 011, 038, 056, 073, 084</p> <p>Sansui: 006, 037, 043, 061</p> <p>Sanyo: 007, 009, 016, 054, 064, 068, 071, 075, 079, 085</p> <p>Scott: 008, 011, 017, 028, 030, 057, 065, 072</p> <p>Sears: 007, 010, 016, 021, 022, 023, 024, 025, 035, 053, 057, 063, 064, 065, 068, 071, 075, 079</p> <p>Sharp: 013, 020, 031, 049, 051, 060, 066</p> <p>Shintom: 004, 025, 032, 061</p> <p>Signature: 049</p> <p>Signature 2000: 075</p> <p>Singer: 047, 061</p> <p>Sony: 004, 032, 033, 041, 052, 058, 070, 074, 076, 077, 080</p> <p>STS: 035</p> <p>Sylvania: 018, 026, 027, 028, 044, 072</p> <p>Symphonic: 018, 051, 053, 073, 079</p> <p>Tandy: 007</p> <p>Tashiko: 010</p> <p>Tatung: 037</p> <p>Teac: 018, 029, 037</p> <p>Technics: 036</p>	<p>Teknika: 010, 018, 065</p> <p>Toshiba: 000, 011, 021, 023, 024, 028, 030, 039, 057, 074, 078, 079</p> <p>Totevision: 009, 010, 065</p> <p>Unitec: 073</p> <p>Unitech: 009</p> <p>Vector Research: 005, 006, 011, 012, 053</p> <p>Video Concepts: 005, 006, 011, 012, 039, 053</p> <p>Wards: 009, 010, 011, 016, 018, 020, 024, 025, 031, 035, 049, 051, 056, 057, 060, 065, 066, 079</p> <p>White Westinghouse: 073</p> <p>XR-1000: 018</p> <p>Yamaha: 005, 006, 007, 014, 037, 053</p> <p>Zenith: 004, 032, 034, 041, 047, 069, 086</p>
---	---	--	---	---

### TV/VCR Combo

Action: 078

GE: 059, 062

Goldstar: 065

Panasonic: 065

Precision: 078

Quasar: 065

Realistic: 079

Sony: 074

Toshiba: 057

Totevision 009, 010, 065

Zenith: 065

## [For DVD Mode]

### DVD

Aiwa: 006, 015  
Apex: 016, 017  
BOSE: 097  
Broksonic: 018  
Clarion: 019  
Classic: 020  
Daewoo: 021  
Denon: 022, 023, 024, 025  
Emerson: 026, 027  
Fisher: 028  
Funai: 027  
GE: 001, 029, 030  
Go Video: 087  
GPX: 031

Hitachi: 005, 032, 033, 034, 035  
JVC: 003, 007, 036, 042, 088  
Kenwood: 037  
Konka: 008, 009  
Magnavox: 004, 038  
Memorex: 039  
Mintek: 040  
NAD: 026  
Nakamichi: 041  
Norcent: 043  
Onkyo: 044  
Oritron: 058  
Panasonic: 010, 045, 046, 047, 048, 049, 050  
Philips: 004, 051

Pioneer: 052, 053, 054, 055  
Proscan: 001, 056  
Qwestar: 057, 058  
RCA: 001, 002, 059, 089  
Sampo: 060  
Samsung: 061, 062, 086, 090  
Sansui: 073  
Sanyo: 063, 091  
Sharp: 064, 067  
Sherwood: 074  
Sony: 011, 012, 065, 066, 068, 069, 070  
Sylvania: 027  
Teac: 071  
Technics: 072

Techwood: 075  
Toshiba: 000, 013, 076, 077, 078  
Yamaha: 079, 080, 081  
Zenith: 014, 082, 092

### Portable DVD player

Aiwa: 093  
Audiovox: 094, 095  
Panasonic: 024, 096, 099  
RCA: 098

### HTIB

Lasonic: 083  
Panasonic: 084  
Venturer: 085

## [For VCR and DVD Mode]

### DVD/VCR Combo

Go Video:  
DVD=087, VCR=081  
JVC:  
DVD=088, VCR=082  
RCA:  
DVD=089, VCR=083  
Samsung:  
DVD=090, VCR=084  
Sanyo:  
DVD=091, VCR=085  
Zenith:  
DVD=092, VCR=086

# Setting up your TV

## Learning about the On-Screen Display (OSD) menu system

After you have installed the batteries, you will need to set some preferences on the TV by using the OSD menu system. You can access the system using the buttons on the TV or remote control.

1. Press MENU/ENTER to display the OSD menu.
2. Press ◀ or ▶ to select a menu.
3. Press ▲ or ▼ to select an item.
4. Press ◀ or ▶ to adjust a setting, or press ▶ to display the next page of menu and repeat step 3-4.
5. To return to the previous menu, or leave and save your menu settings, press EXIT.

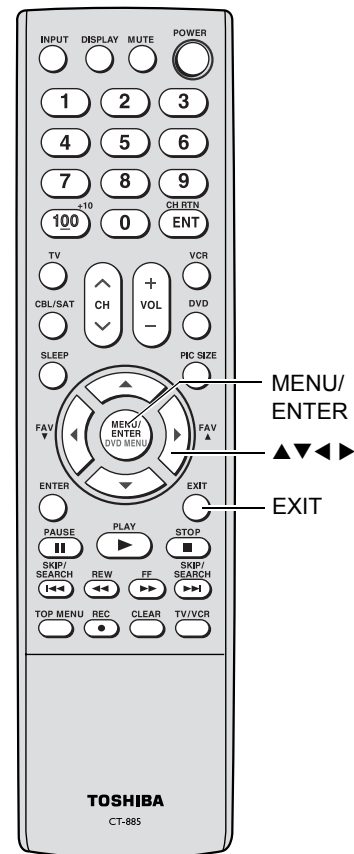
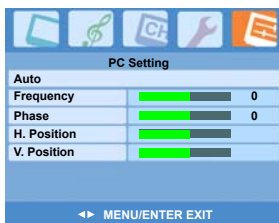
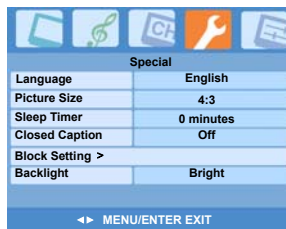
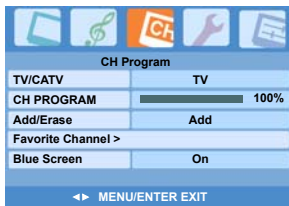
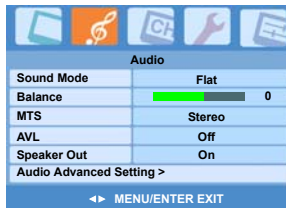

### Note:

The PC mode is selectable only when the TV is in PC input mode and active picture is on-screen (see "Selecting the video input source" on page 26).

## Changing the on-screen display language

You can choose from three different languages (English, Spanish, and French) for the on-screen display of adjustment menus and messages.

To select a language:

1. Press MENU/ENTER, and then press ◀ or ▶ until the Special menu appears.
2. Press ▲ or ▼ to highlight Language.
3. Press ◀ or ▶ to select your desired language.

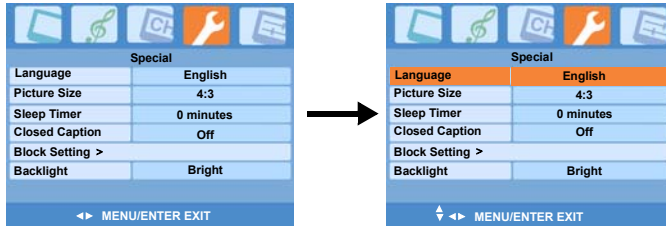

## Adding channels to the TV's memory

When you press CH ^ or CH v, your TV will stop only on the channels you program into the TV's channel memory.

Follow the steps below and on the next page to program all active channels into the TV's memory.

### Programming channels automatically

Your TV can automatically detect all active channels in your area and store them in the channel memory. After the channels are programmed automatically, you can manually add or erase individual channels (see page 25).

To program channels automatically:

1. Press MENU/ENTER, and then press ◀ or ▶ until the CH Program menu appears.
2. Press ▼ to highlight TV/CATV. Select the system (CATV or TV) that you want to program the channels.
3. Press ▲ or ▼ to highlight CH PROGRAM.

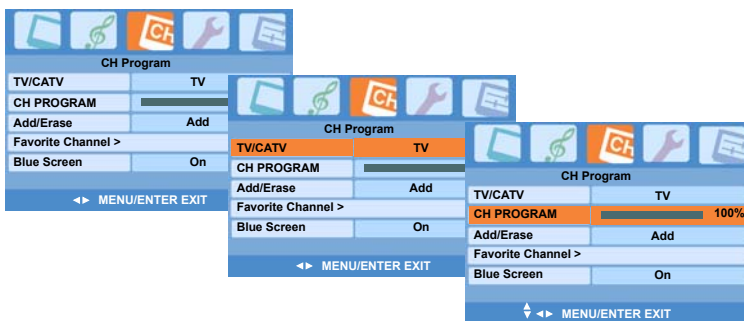

4. Press ▶ or MENU/ENTER to start auto-programming. The TV will automatically cycle through all the TV and Cable channels, and store all active channels in the channel memory.
5. Press EXIT to close the OSD menu and press CH ^ or CH v to view the programmed channels.

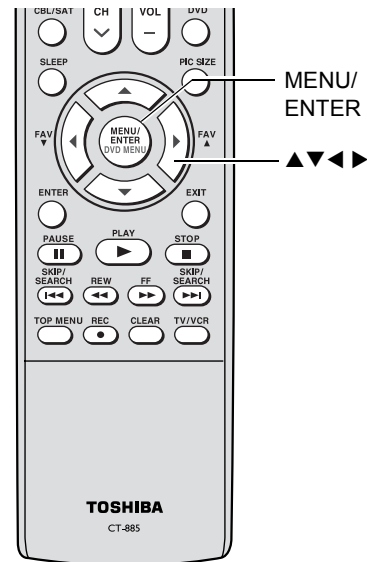

### Note:

- To tune the TV to a channel not programmed in the channel memory, you must use the Channel Number buttons on the remote control.
- If you press EXIT during auto-programming, the function will stop and only the channels programmed up to that time will be stored in the channel memory.

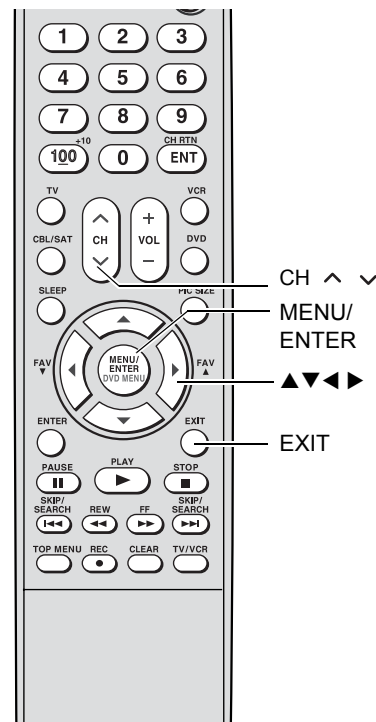



## Adding and erasing channels manually

After you have automatically programmed the active channels into the TV's channel memory, you can manually add or erase specific channels.

To add or erase channels:

1. Tune your TV to the channel you want to add or erase.
2. Press MENU/ENTER, and then press ◀ or ▶ until the CH Program menu appears.
3. Press ▲ or ▼ to highlight Add/Erase.
4. Press ◀ or ▶ to select Add or Erase.

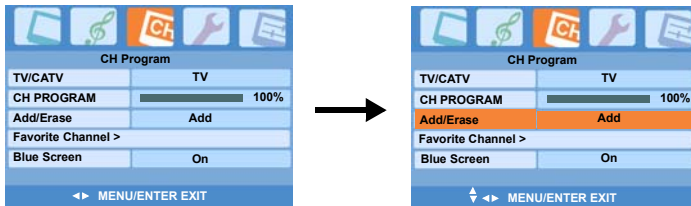

5. Press EXIT to leave and save the setting. The current channel is added to the TV's memory or erased from the channel list.

## Changing channels

To change to a specific channel (programmed or unprogrammed):

Press the Channel Number buttons (0–9 and 100).  
For channels 100 and higher, press the 100 button, and then the next two numbers. For example, to select channel 125, press 100, 2, 5.

To change to the next programmed channel:

Press CH ▲ or CH ▼ on the TV or remote control.

## Programming your favorite channels

You can preset up to 5 of your favorite channels using the Favorite Channel Programming feature. Because this feature scans through only your favorite channels, it allows you to skip other channels you do not normally watch.

To program your favorite channels:

1. Press MENU/ENTER, and then press ◀ or ▶ until the CH Program menu appears.
2. Press ▲ or ▼ to highlight Favorite Channel >.
3. Press ▶ or MENU/ENTER to display the Favorite Channel page.

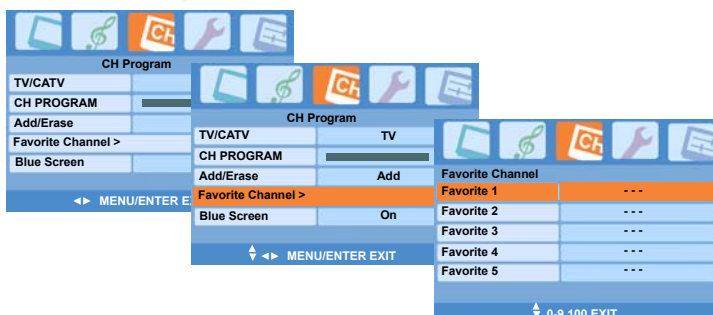

TV side panel

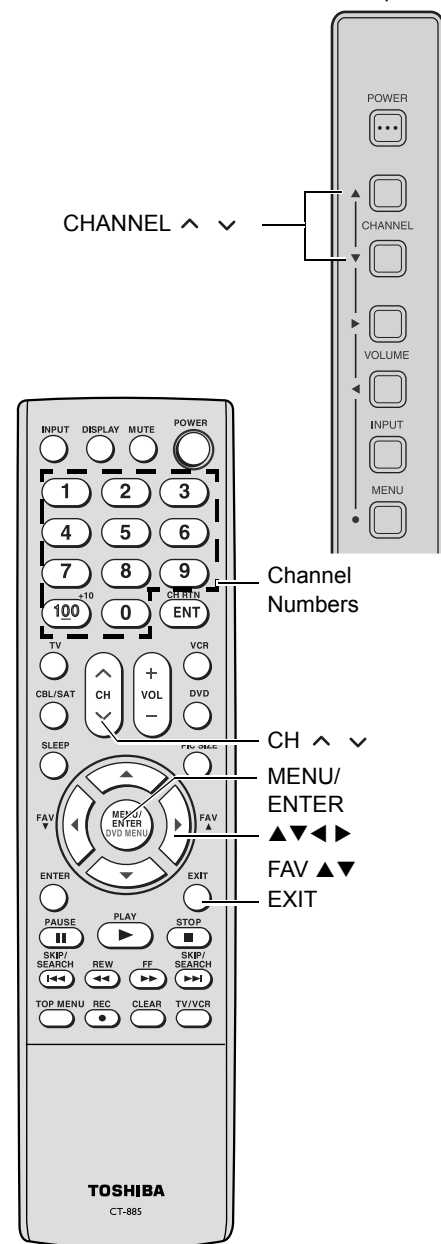

4. Press ▲ or ▼ to select the first favorite channel position.
5. Press the Channel Number buttons to set the desired channel number for the first favorite channel position.

**Note:** If the channel number you want to set is below 10, press 0 and then the number.

6. Repeat steps 4 and 5 to program other channels.

To select your favorite channels:

Repeatedly press FAV ▲ or ▼ on the remote control.

## Using the TV's features

### Switching between two channels using Channel Return

The Channel Return feature allows you to switch between two channels without entering an actual channel number each time.

To switch between two channels:

1. Select the first channel you want to view.
2. Select a second channel using the Channel Number buttons (0–9, 100).
3. Press CH RTN/ENT. The previous channel will be displayed.

Each time you press CH RTN/ENT, the TV will switch back and forth between the last two channels that were selected.

### Using the Blue screen feature

With the Blue screen function On, the screen will automatically turn blue and the sound will be muted when no signal is received.

To turn on the Blue screen feature:

1. Press MENU/ENTER, and then press ◀ or ▶ until the CH Program menu appears.
2. Press ▲ or ▼ to highlight Blue Screen.
3. Press ◀ or ▶ to select On.

**Note:** If the Blue screen appears repeatedly because of poor signal strength, select Off in step 3.

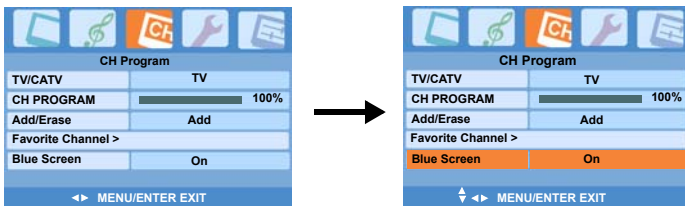

### Selecting the video input source

Press INPUT on the remote control or on the TV side panel to view a signal from another device connected to your TV, such as a VCR or DVD player. You can select VIDEO1, VIDEO2 (including ColorStream), or PC depending on which input jacks are used for connecting the devices (see "Connecting your TV" on page 10).

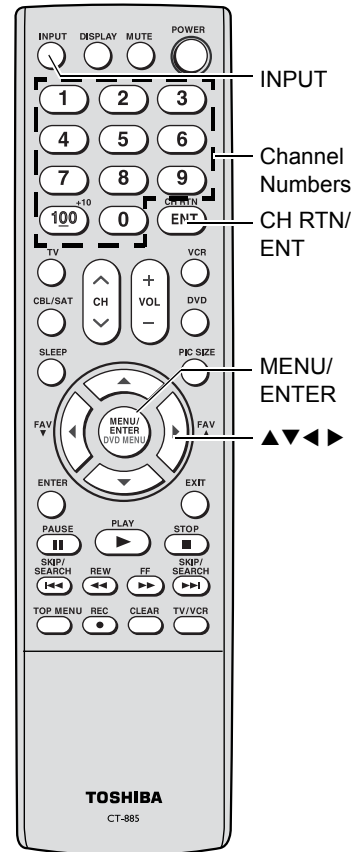
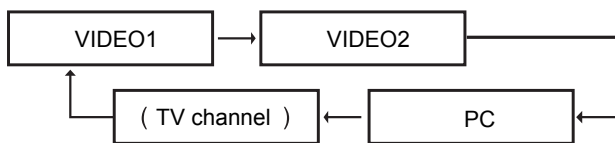

TV side panel

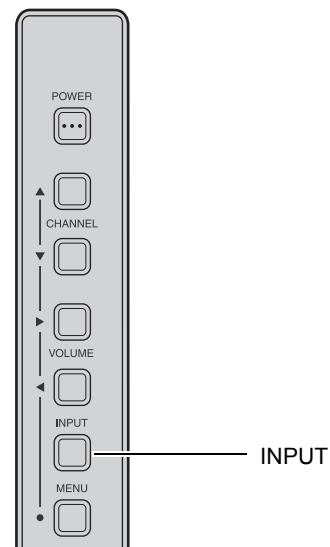

## Selecting the picture size

You can select a desired picture size either directly on the remote control or in the On-Screen Display (OSD) menu.

- Using the remote control

Repeatedly press PIC SIZE on the remote control to select the desired picture size.

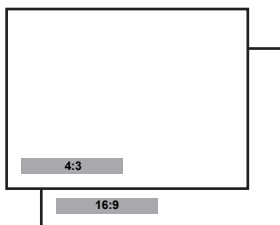

- Using the OSD menu
1. Press MENU/ENTER and press ◀ or ▶ to highlight the Special menu.
  2. Press ▲ or ▼ to highlight Picture Size, then press ◀ or ▶ to select a desired picture size.

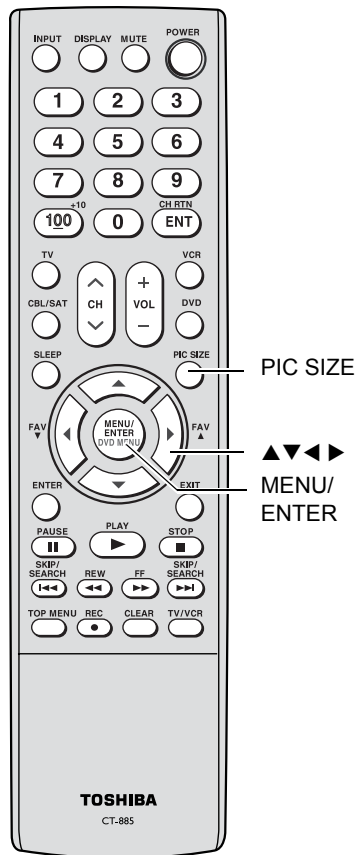
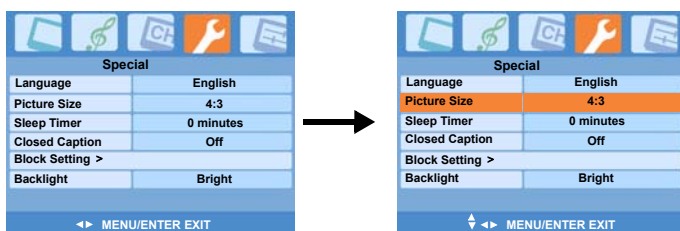

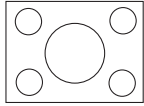
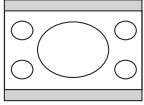
Item	Pressing ◀ or ▶
4:3 	Scales an image so that it is displayed in the center of the screen with a 4:3 aspect ratio. This is most suitable for 4:3 images like computer monitors, standard definition TV and 4:3 aspect DVD movies, as it displays them without aspect alteration.
16:9 	Scales an image so that it is displayed in the center of the screen with a 16:9 aspect. This is most suitable for images which are already in a 16:9 aspect, like high definition TV, as it displays them without aspect alteration.

## Using the V-Chip menu

Some TV programs and movies include signals that classify the content of the program (violence, sex, dialog, language). The V-Chip control feature in this TV detects the signals and blocks the programs according to your selections. To use this feature, perform the following setup.

1. Enable the Lock.
2. Set a four-digit password.
3. Select the ratings and categories you want to block.

### **Note:**

*The V-Chip function is available for the U.S. V-Chip system.*

## V-Chip rating and categories

Rating guidelines are provided by broadcast stations. Most television programs and television movies can be blocked by TV rating and/or category. Movies that have been shown at the theaters and direct-to-video movies use the MPAA movie rating system instead.

### **For Movies previously shown in theaters:**

#### **Movie Ratings:**

- Unblocked
- G & above (general audience)
- PG & above (parental guidance suggested)
- PG-13 & above (13 years and older)
- R & above (restricted)
- NC-17 & above (18 years and older)
- X (adult)

If you select "PG-13 & above," all G and PG rated movies will be available, and all PG-13, R, NC-17 and X rated movies will be blocked.

### **For Television programs including made-for-TV movies:**

#### **General TV Ratings:**

- Unblocked
- TV-G & above (general audience)  
(individual categories do not apply)
- TV-PG & above (parental guidance suggested)
- TV-14 & above (14 years and older)
- TV-MA (mature audience)

#### **Children TV Ratings:**

- Unblocked
- TV-Y & above (youth)  
(individual content categories do not apply)
- TV-Y7 (youth, 7 years and up)

#### **Content Categories:**

- Dialog - sexual dialogue (applies to TV-PG & above, TV-14)
- Language - adult language (applies to TV-PG & above, TV-14 & above, TV-MA)
- Sex - sexual situations (applies to TV-PG & above, TV-14 & above, TV-MA)
- Violence (applies to TV-PG & above, TV-14 & above, TV-MA)
- F. Violence - fantasy violence (applies only to TV-Y7)
- No Rating (blocks all viewing)

## V-Chip blocking (Parental control) setup

1. Press MENU/ENTER, and then press ◀ or ▶ until the Special menu appears.
2. Press ▲ or ▼ to highlight Block Setting >. Press ▶ to enter the Block Setting page.

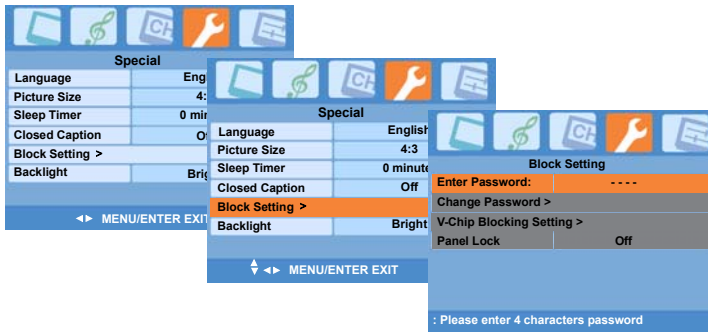

- If you already set a password, enter your four-digit password.
  - If you have not created a password, the TV is initially set up with the password "0000".
  - If you cannot remember your password, press "7777".
3. Should you need to change the password:  
Press ▲ or ▼ to highlight Change Password >. Press ▶ to display the Change Password page and then enter a four-digit new password. Enter it again when requested.

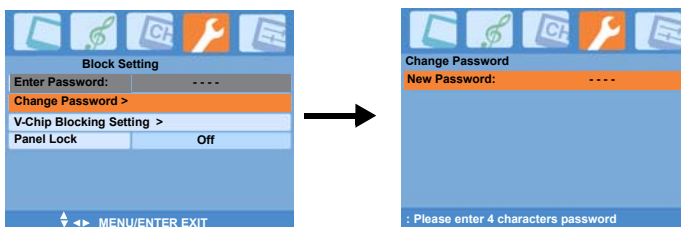

4. To set the type of blocking:  
Press ▲ or ▼ to highlight V-Chip Blocking Setting >. Press ▶ to display the V-Chip Blocking Setting page. Press ▲ or ▼ to select the type of rating to be set. For USA TV Ratings, press ▶ to display the next page and select the rate to be set. For Moive Ratings, press ◀ or ▶ to select an item to be set.

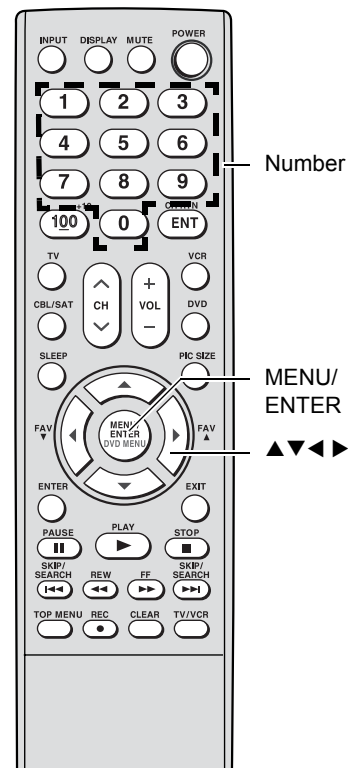
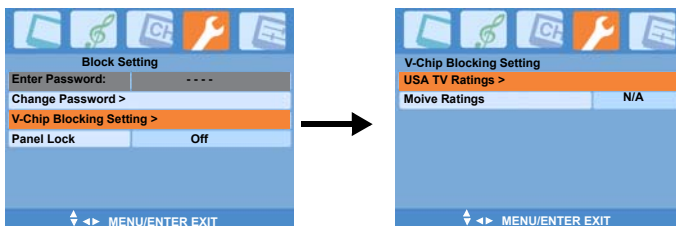

If you try to watch a TV program that exceeds the rating limits you set, the TV enters program lock mode.

To unlock the program, press ▼ and enter the password you set.

To skip this program, press channel number buttons or CH ^ v to select other channel.

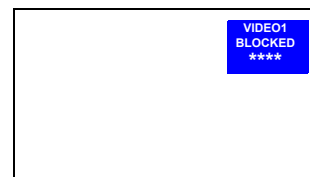

## Adjusting the picture

### Selecting the picture mode

You can select your desired picture type from four picture modes: Dynamic, Standard, Movie, or Memory.

Mode	Picture quality
Dynamic	Bright and dynamic picture (factory setting)
Standard	Standard picture setting (factory setting)
Movie	Movie-like picture setting (factory setting)
Memory	Your personal preference

To select the picture mode:

1. Press MENU/ENTER, and then press ◀ or ▶ until the Picture menu appears.
2. Press ▼ or ▲ to highlight Picture Mode.
3. Press ◀ or ▶ to select the mode you prefer.



### Adjusting the picture quality and advanced picture quality

You can adjust the picture quality to your personal preferences, including Contrast, Brightness, Color, Sharpness, and Tint.

Selection	◀ Pressing	▶
Contrast	lower	higher
Brightness	darker	lighter
Color	paler	deeper
Sharpness	softer	sharper
Tint	reddish	greenish

To adjust the picture quality and advanced picture quality:

1. Press MENU/ENTER, and then press ◀ or ▶ until the Picture menu appears.
2. Press ▲ or ▼ until the item you want to adjust is highlighted.
3. Press ◀ or ▶ to adjust the level.
4. To continue adjusting the other items, repeat step 2-3.

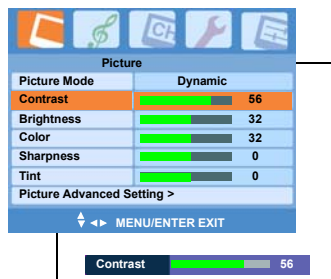

The picture qualities you adjusted can be saved in the TV's Memory mode.

### Note:

If you select one of the factory-set picture modes (Dynamic, Standard, or Movie) and then adjust a picture quality setting (for example, increase the contrast), the picture mode automatically changes to Memory in the Picture menu.

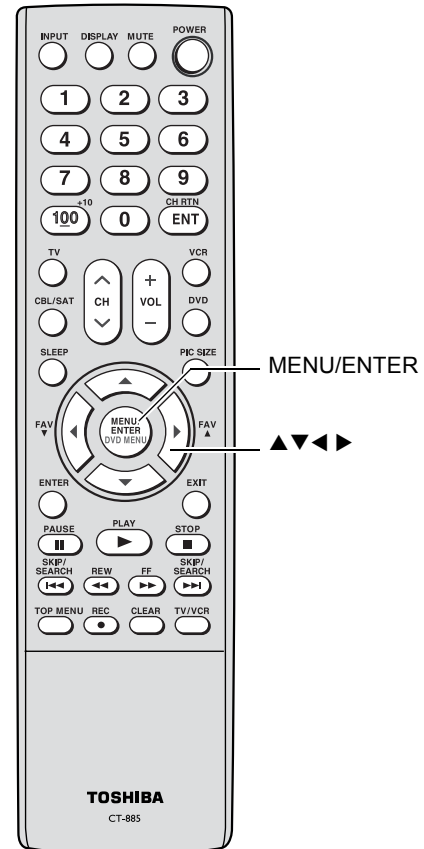

### Note:

When the selected input signal is PC, the following functions will not be available: Color, Sharpness, Tint, NTSC Setup, Black Stretch, and Noise Reduction.

To adjust the advanced picture quality (continued):

- Press ▲ or ▼ to highlight Picture Advanced Setting > and press ► to display the Picture Advanced Setting page.

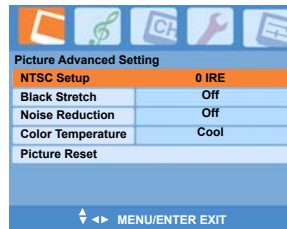

- Press ▲ or ▼ until the item you want to adjust is highlighted and press ◀ or ▶ to adjust the level.

## Using the Closed Caption feature

The Closed Caption feature has two options:

- Captions—An on-screen display of the dialogue, narration, and sound effects of TV programs and videos that are closed captioned (usually marked as "CC" in TV listings).
- Text—An on-screen display of information not related to the current program, such as weather or stock data (when provided by individual stations).

To select captions or text:

- Tune the TV to the desired program.
- Press MENU/ENTER, and then press ◀ or ▶ to display the Special menu.
- Press ▲ or ▼ to highlight Closed Caption.

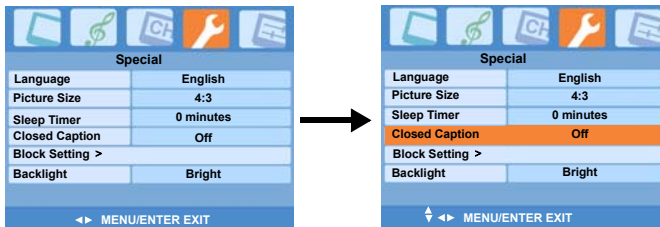

- Press ◀ or ▶ to select the Caption or Text mode you prefer.
  - To view captions, select CC1, CC2, CC3, or CC4 (CC1 displays captions in the primary language in your area).
 

**Note:** If the program or video you selected is not closed captioned, the captions will not display on the screen.



- To view text, select Text1, Text2, Text3, or Text4.
 

**Note:** If text is not available in your area, a black rectangle may appear on your screen. If this happens, turn the Closed Caption feature Off.

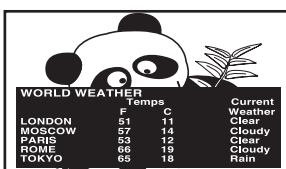

- To turn off the Closed Caption feature, select Off.

Item	Options
NTSC Setup	0 IRE, 7.5 IRE
Black Stretch	Low, Middle, High, Off
Noise Reduction	Low, Middle, High, Off
Color Temperature	Normal, Warm, Cool
Picture Reset	Press OK to reset all of the functions in the Picture menu to the default values of Dynamic mode.

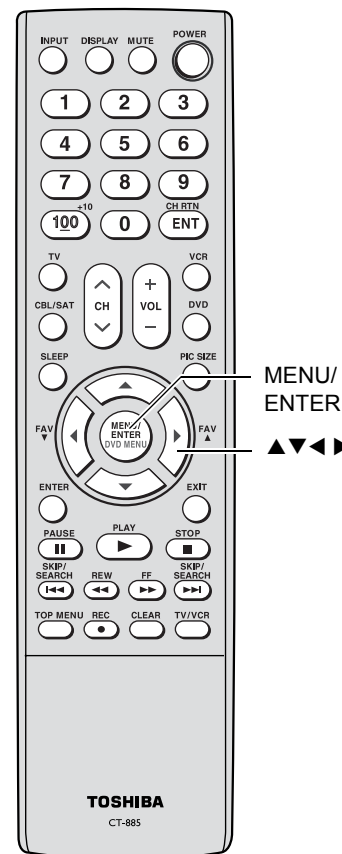

### Note:

A closed caption signal may not display in the following situations:

- When a videotape has been dubbed
- When the signal reception is weak
- When the signal reception is nonstandard

## Setting the sleep timer

To set the sleep timer to turn off the TV automatically:

- Using the remote control
  1. Press SLEEP to display the current setting.
  2. Repeatedly press SLEEP to set the length of time before the TV turns off.

The time length ranges from 0 minutes to 120 minutes.  
0 → 15 → 30 → 45 → 60 → 120

- Using the On-Screen Display (OSD) menu
  1. Press MENU/ENTER, and then press ◀ or ▶ until the Special menu appears.
  2. Press ▲ or ▼ to highlight Sleep Timer.

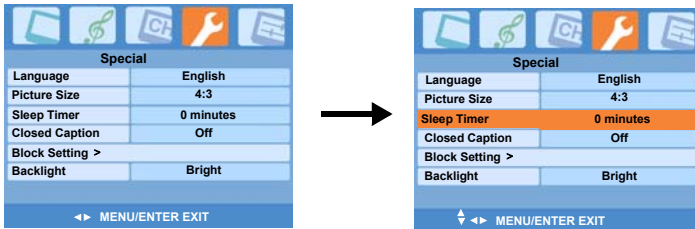

3. Press ◀ or ▶ to set the length of time before the TV turns off.

The time length ranges from 0 minutes to 120 minutes.  
0 → 15 → 30 → 45 → 60 → 120

To cancel the sleep timer:

Press SLEEP until "0 minutes" appears.

## Setting the Backlight

Your LCD TV set have a bright fluorescent light behind its LCD panel. The light source, which is called backlight, affects the brightness of the entire screen. In a darkened room with proper lighting, we recommend you lower this setting before you begin adjusting the brightness and contrast. You can always raise it later if it proves too dim.

To set the Backlight:

1. Press MENU/ENTER, and then press ◀ or ▶ to display the Special menu.
2. Press ▲ or ▼ to highlight Backlight.
3. Press ◀ or ▶ to select Bright, Normal, or Dark.

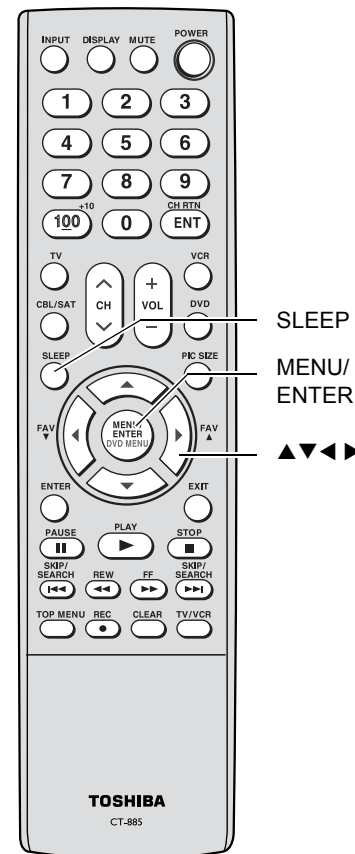
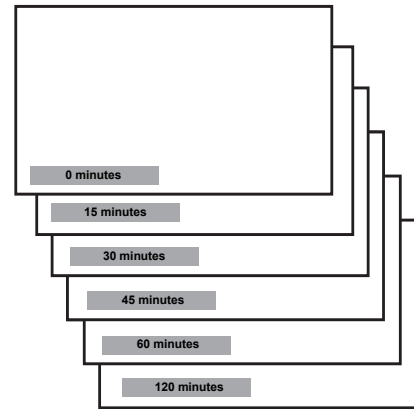
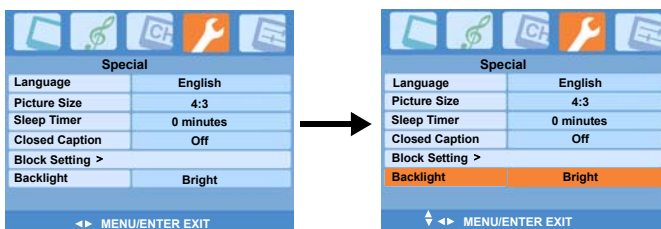

### Note:

- When an instant power failure occurs, the sleep timer settings may be cleared.
- To display the amount of time left until the TV turns off automatically, press SLEEP once.



## Adjusting the sound

### Muting the sound

Press MUTE to temporarily turn off the sound. While the sound is off, the screen will display "M" in the upper right corner.

To restore the sound, press MUTE again.

### Selecting stereo/SAP broadcasts

The multi-channel TV sound (MTS) feature allows you to listen to high-fidelity stereo sound while watching TV. MTS can also transmit a second audio program (SAP) containing a second language, music, or other audio information (when provided by individual stations).

When the TV receives a stereo or SAP broadcast, the word "ST.SAP", "Stereo" or "SAP" appears on-screen every time the TV is turned on, the channel is changed, or DISPLAY is pressed.

When the TV is in VIDEO1, VIDEO2, or PC mode, the options for MTS feature are L+R, L+L, R+R. Your selection decides from which speaker the audio is output.

To listen to different sound types:

1. Press MENU/ENTER, and then press ◀ or ▶ until the Audio menu appears.
2. Press ▲ or ▼ to highlight MTS.
3. Press ◀ or ▶ to select Stereo, SAP, or Mono.

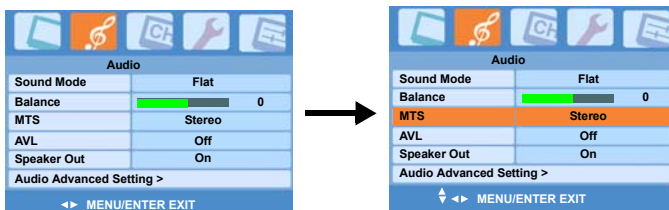

You can leave your TV in Stereo mode because it will automatically output the type of sound being broadcast (stereo or monaural).

If the stereo sound is noisy, select Mono to reduce the noise.

If you select SAP, You will hear the station's second audio program (if available) from the speakers, while viewing the original program's picture.

#### Note:

The operation methods mentioned above can also be applied when the TV is in VIDEO1, VIDEO2, or PC mode.

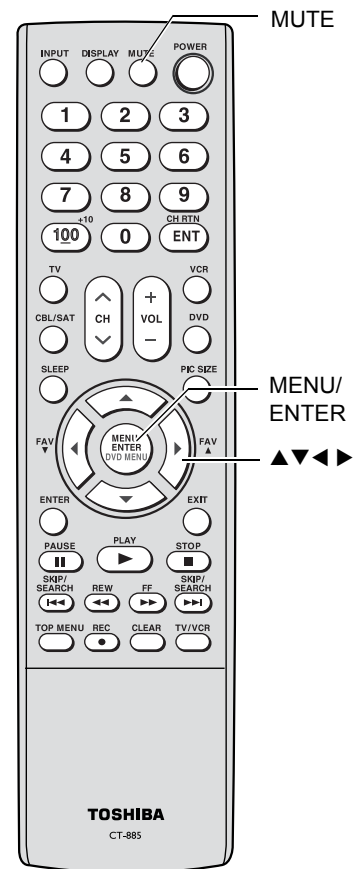

## Selecting the sound mode

You can select your desired sound type from five sound modes: Flat, Hall, Theater, News, or Memory.

To select the sound mode:

1. Press MENU/ENTER, and then press ◀ or ▶ until the Audio menu appears.
2. Press ▼ or ▲ to highlight Sound Mode.
3. Press ◀ or ▶ to select the mode you prefer.

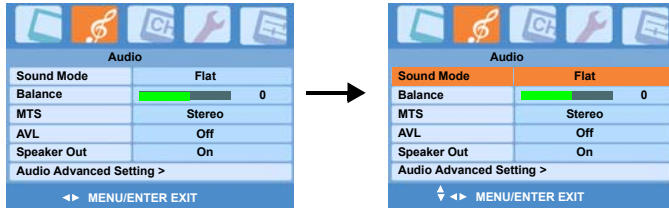

Mode	Sound Quality
Flat	flat sound (factory setting)
Hall	a concert hall filled with a rich warm sound (factory setting)
Theater	a movie theater filled with a dynamic sound (factory setting)
News	news/dialogue (factory setting)
Memory	your personal preference

## Adjusting the sound quality

You can change the quality of your TV's sound by adjusting the bass, treble, and balance.

To adjust the sound balance:

1. Press MENU/ENTER, and then press ◀ or ▶ until the Audio menu appears.
2. Press ▲ or ▼ to highlight Balance.

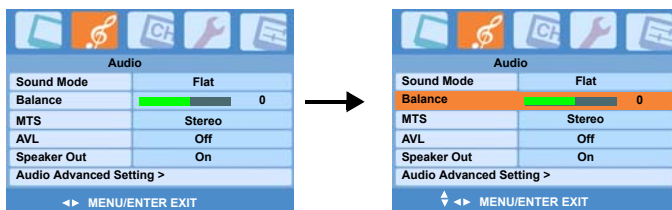

3. Press ◀ or ▶ to adjust the level.
  - ◀ makes the sound quality weaker or increases the balance in the left channel, depending on the item selected.
  - ▶ makes the sound quality stronger or increases the balance in the right channel, depending on the item selected.

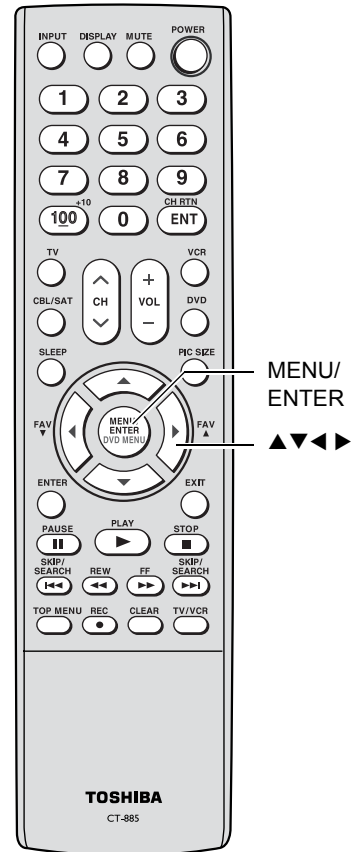

### Note:

If you select one of the factory-set audio modes (Flat, Hall, Theater, or News) and then change a sound quality setting (for example, increase the bass), the sound mode automatically change to Memory mode.

To adjust the sound bass and treble:

4. Press ▼ to highlight Audio Advanced Setting >.
5. Press ► to display the Audio Advanced Setting page.
6. Press ▲ or ▼ to highlight one of the items (Treble, Mid Treble, Middle, Mid Bass, and Bass) you want to adjust.
7. Press ◀ or ▶ to adjust the level.

The sound qualities you adjusted in the Audio Advanced Setting page can be saved in the Memory mode.

To reset the audio settings:

8. Press ▼ to highlight Audio Reset and press MENU/ENTER to return all of the audio settings to the default values of Flat.

### Using the AVL (Automatic Volume Leveler) feature

When the signal source is changed, the AVL feature limits the highest volume level to prevent extreme changes in volume (for example, to prevent the sudden increase in volume that often happens when a TV program switches to a commercial).

To turn on the AVL feature:

1. Press MENU/ENTER, and then press ◀ or ▶ until the Audio menu appears.
2. Press ▲ or ▼ to highlight AVL.
3. Press ◀ or ▶ to select On.

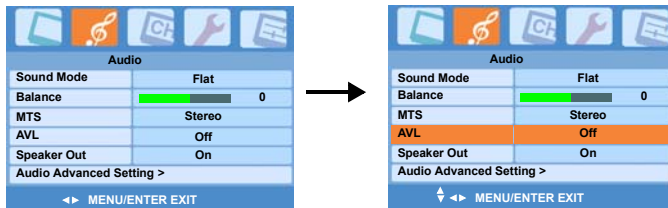

To turn off the AVL feature:  
Select Off in step 3 above.

### Using the Speaker Out feature

Be sure you have correctly connected your TV to an external audio system, if you want to activate the Speaker Out function. For connection method, refer to "[Connecting an audio system](#)" on page 15.

To use the Speaker Out function:

1. In the Audio menu, press ▲ or ▼ to highlight Speaker Out.
2. Press ◀ or ▶ to select On.

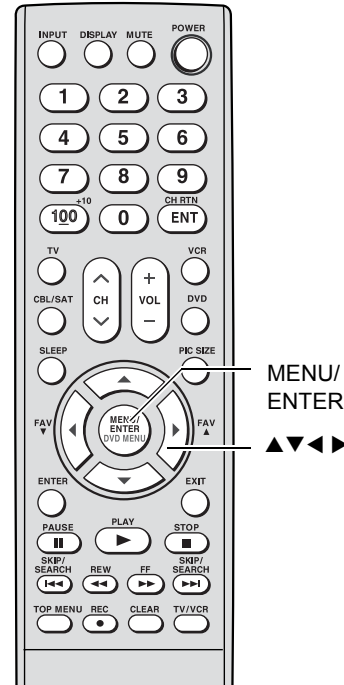

To adjust the sound bass and treble:  
Step 4–6

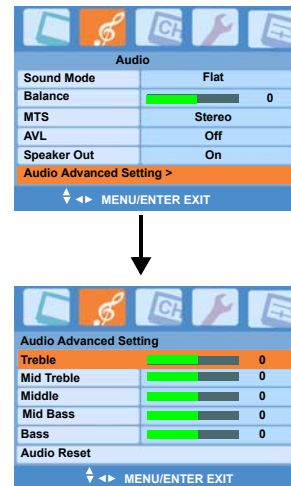

Selection	◀ Pressing	▶
Treble	weaker	stronger
Mid Treble	weaker	stronger
Middle	weaker	stronger
Mid Bass	weaker	stronger
Bass	weaker	stronger

## Using the PC setting feature

You can adjust the horizontal/vertical picture position, frequency (to minimize vertical stripes on the screen), and phase (to remove horizontal noise and sharpen the picture).

You can auto-configure or set these settings manually.

1. Confirm a PC is connected (see ["Connecting a personal computer \(PC\)"](#) on page 16).
2. Repeatedly press INPUT on the remote control or on the TV side panel to select PC input mode. (See ["Selecting the video input source"](#) on page 26.)
3. Press MENU/ENTER, and then press ◀ or ▶ until the PC Setting menu appears.

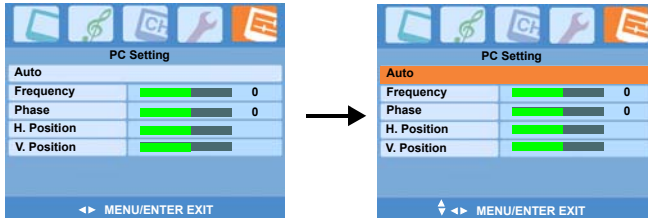

4. To automatically adjust the settings, press ▼ to highlight Auto and then press MENU/ENTER.

To manually make the appropriate adjustments to other items, press ▼ to highlight the item to be set and then press ◀ or ▶.

- Auto

Automatically adjusts the screen position, frequency, and phase. (The displayed image will disappear for a few seconds while auto-configuration is in progress.)

- Frequency

Minimizes any vertical bars or stripes appearing on the screen background. The adjustable range may vary depending on the input mode.

- Phase

Reduces (or minimizes) any horizontal noise and clears up or sharpens the character images. The adjustable range may vary depending on the input mode.

- H. Position/V. Position

Adjusts picture left/right and up/down. The adjustable range may vary depending on the input mode.

TV side panel

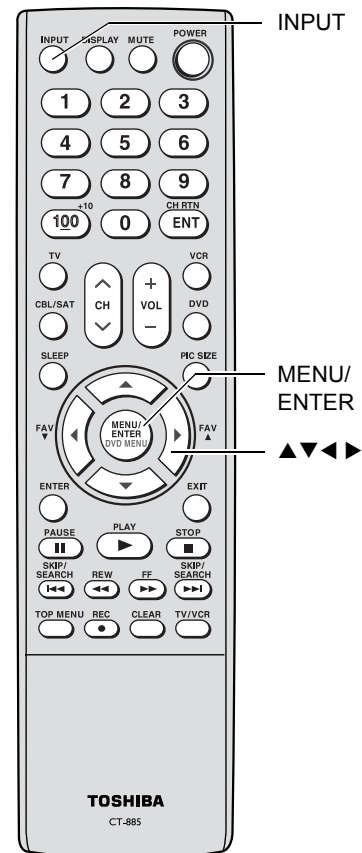
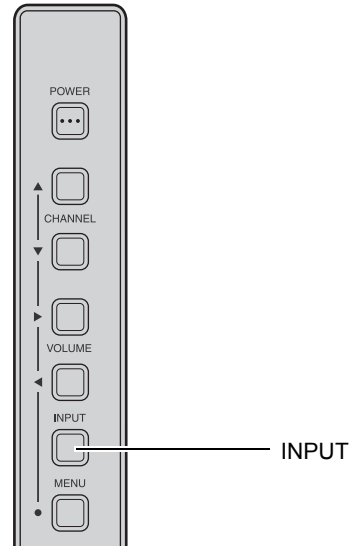

## Using the Panel Lock feature

1. Press MENU/ENTER, and then press ◀ or ▶ until the Special menu appears.
2. Press ▲ or ▼ to highlight Block Setting >. Press ▶ to enter the Block Setting page.

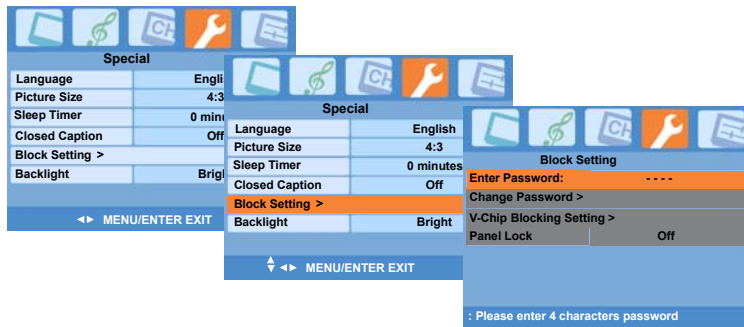

- If you already set a password, enter your four-digit password.
  - If you have not created a password, the TV is initially set up with the password "0000".
  - If you cannot remember your password, press "7777".
3. Press ▲ or ▼ to highlight Panel Lock. Press ◀ or ▶ to select On (Lock) or Off (Unlock).

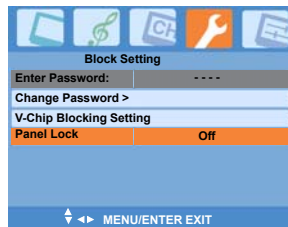

## Displaying on-screen information

Press DISPLAY to display the following information on-screen:

- Channel number or Video mode selected
- Stereo or SAP audio status



## Understanding the last mode memory feature

If the power is cut off while you are viewing the TV, the Last Mode Memory feature turns on the TV automatically when the power is resupplied.

If the power is going to be off for a long time and you are going to be away from your TV, unplug the power cord to prevent the TV from turning on in your absence.

### Note:

With the panel locked, you can prevent your TV settings from being changed accidentally (by children, for example).

When the Panel Lock is on, no control buttons on the TV side panel will operate except POWER.

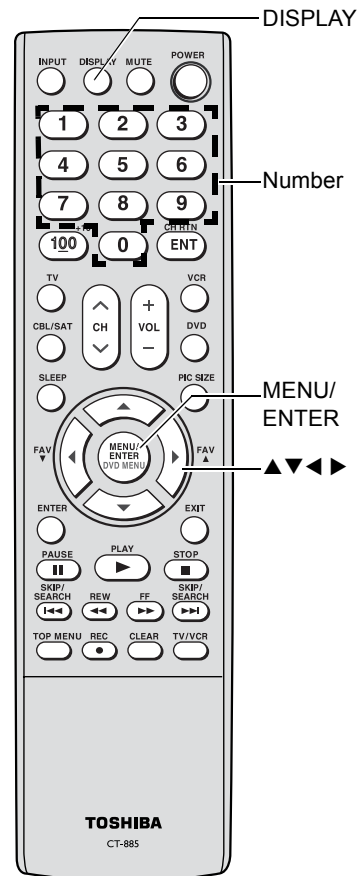

# Appendix

## Specifications

- This model complies with the specifications listed below.
- Designs and specifications are subject to change without notice.
- This model may not be compatible with features and/or specifications that may be added in the future.



### WARNING: RISK OF ELECTRIC SHOCK!

Never attempt to service the TV yourself. Opening and removing the covers may expose you to dangerous voltage or other hazards. Refer all servicing to a Toshiba Authorized Service Center.

Television System  
NTSC standard

Channel Coverage  
VHF: 2 through 13  
UHF: 14 through 69  
Cable TV: Mid band (A-8 through A-1, A through I)  
Super band (J through W)  
Hyper band (AA through ZZ, AAA, BBB)  
Ultra band (65 through 94, 100 through 125)

Power Source  
120 V AC, 60 Hz

Power Consumption  
70 W  
< 1 W in standby mode

Audio Power  
2 W + 2 W

Video/Audio Terminals  
S-VIDEO INPUT  
Y: 1 V(p-p), 75 ohms, negative sync.  
C: 0.286 V(p-p) (burst signal), 75 ohms  
VIDEO/AUDIO INPUT  
VIDEO: 1 V(p-p), 75 ohms, negative sync.  
AUDIO: 400 mV(rms) (30% modulation equivalent, 22k ohms or greater)  
ColorStream® (Component video) INPUT  
Y: 1V(p-p), 75 ohms  
PR: 0.7 V(p-p), 75 ohms  
PB: 0.7 V(p-p), 75 ohms  
AUDIO: 500 mV(rms), 47k ohms or greater  
Suggested resolutions: 1080i, 480p, 480i, 720p  
AUDIO OUTPUT  
500 mV(rms) (30% modulation equivalent, 2.2k ohms or less)

HEADPHONE jack  
3.5 mm stereo mini jack  
PC INPUT  
15-pin D-sub Analog RGB  
PC AUDIO INPUT  
3.5 mm stereo mini jack

Dimensions (Including TV stand)  
Width: 18-5/8 inches (474 mm)  
Height: 18-5/16 inches (465 mm)  
Depth: 9-5/16 inches (236 mm)

Mass (weight)  
18.5 lbs (8.4 kg)

Operating conditions  
Temperature: 32°F–95°F (0°C–35°C)  
Humidity: 20 – 80% (no moisture condensation)

\*E-EDID = Enhanced-Extended Display Identification

## Troubleshooting

Before calling a service technician, please check the following table for a possible cause of the symptom and some solutions.

Symptom	Solution
TV will not turn on	<ul style="list-style-type: none"> <li>• Make sure the power cord is plugged in, then press POWER.</li> <li>• The remote control batteries may be dead. Replace the batteries.</li> </ul>
No picture, no sound	<ul style="list-style-type: none"> <li>• Check the antenna/cable connections.</li> </ul>
No sound, picture OK	<ul style="list-style-type: none"> <li>• The sound may be muted. Press VOL + –.</li> <li>• The station may have broadcast difficulties. Try another channel.</li> <li>• Make sure the MTS feature is set properly.</li> </ul>
Poor picture, sound OK	<ul style="list-style-type: none"> <li>• Check the antenna connections.</li> <li>• The station may have broadcast difficulties. Try another channel.</li> <li>• Adjust the Picture menu.</li> </ul>
Poor reception of broadcast channels	<ul style="list-style-type: none"> <li>• The station may have broadcast difficulties. Try another channel.</li> <li>• Check the antenna connections.</li> </ul>
Black box appears on the screen	<ul style="list-style-type: none"> <li>• The Closed Caption feature may be set to one of the Text modes (Text1, Text2, Text3, or Text4). Turn closed captioning Off.</li> </ul>
Unable to select a certain channel	<ul style="list-style-type: none"> <li>• The channel may be erased with the manual programming feature.</li> </ul>
Multiple images	<ul style="list-style-type: none"> <li>• The station may have broadcast difficulties. Try another channel.</li> <li>• Antenna reception may be poor. Use a highly directional outdoor antenna.</li> </ul>
Poor color or no color	<ul style="list-style-type: none"> <li>• The station may have broadcast difficulties. Try another channel.</li> <li>• Adjust the Tint and/or Color in the Picture menu.</li> </ul>
No stereo or SAP sound from a known MTS broadcast	<ul style="list-style-type: none"> <li>• Make sure the MTS feature is set properly.</li> </ul>
The side panel buttons do not operate	<ul style="list-style-type: none"> <li>• Check the Panel Lock feature.</li> </ul>
The remote control does not operate	<ul style="list-style-type: none"> <li>• Remove all obstructions between the remote control and the remote control sensor in the TV.</li> <li>• The remote control batteries may be dead. Replace the batteries.</li> </ul>

# Limited United States Warranty for 20" LCD Television

Toshiba America Consumer Products, L.L.C. ("TACP") makes the following limited warranties to original consumers in the United States. THESE LIMITED WARRANTIES EXTEND TO THE ORIGINAL CONSUMER PURCHASER OR ANY PERSON RECEIVING THIS LCD PRODUCT AS A GIFT FROM THE ORIGINAL CONSUMER PURCHASER AND TO NO OTHER PURCHASER OR TRANSFEREE.

LCD PRODUCTS PURCHASED IN THE U.S.A. AND USED ANYWHERE OUTSIDE OF THE U.S.A., INCLUDING, WITHOUT LIMITATION, CANADA AND MEXICO, ARE NOT COVERED BY THESE WARRANTIES.

LCD PRODUCTS PURCHASED ANYWHERE OUTSIDE OF THE U.S.A., INCLUDING, WITHOUT LIMITATION, CANADA AND MEXICO, AND USED IN THE U.S.A., ARE NOT COVERED BY THESE WARRANTIES.

## Limited One (1) Year Warranty on Parts and Labor

TACP warrants this LCD Product and its parts against defects in materials or workmanship for a period of one (1) year after the date of original retail purchase. DURING THIS PERIOD, TACP WILL, AT TACP'S OPTION, REPAIR OR REPLACE A DEFECTIVE PART WITH A NEW OR REFURBISHED PART WITHOUT CHARGE TO YOU FOR PARTS OR LABOR.

## Rental Units

The warranty for LCD Product rental units begins on the date of the first rental or thirty (30) days after the date of shipment to the rental firm, whichever comes first.

## Limited Warranty for Commercial Units

TACP warrants LCD Products that are sold and used for commercial purposes as follows: all parts are warranted against defects in materials or workmanship for a period of ninety (90) days after the date of original retail purchase. DURING THIS PERIOD, TACP WILL, AT TACP'S OPTION, REPAIR OR REPLACE A DEFECTIVE PART WITH A NEW OR REFURBISHED PART WITHOUT CHARGE TO YOU.

## Owner's Manual and Product Registration Card

Read this owner's manual thoroughly before operating this LCD Product.

Complete and mail the enclosed product registration card or register your LCD Product online at [www.tacp.toshiba.com/service](http://www.tacp.toshiba.com/service) as soon as possible. By registering your LCD Product you will enable TACP to bring you new products specifically designed to meet your needs and help us to contact you in the unlikely event a safety notification is required under the U.S. Consumer Product Safety Act. Failure to complete and return the product registration card does not diminish your warranty rights.

## Your Responsibility

THE ABOVE WARRANTIES ARE SUBJECT TO THE FOLLOWING CONDITIONS:

- (1). You must retain your original bill of sale or provide other proof of purchase.
- (2). All warranty servicing of this LCD Product must be performed by an Authorized TACP Service Station.
- (3). The warranties from TACP are effective only if this LCD Product is purchased and operated in the Continental U.S.A. or Puerto Rico.
- (4). Labor service charges for set installation, setup, adjustment of customer controls, and installation or repair of antenna systems are not covered by this warranty. Reception problems caused by inadequate antenna systems, misaligned satellite dishes, cable television distribution, VCRs, DVD players/recorders, personal computer level IEEE-1394 devices, and any other connected signal source device are your responsibility.

- (5). Warranties extend only to defects in materials or workmanship as limited above, and do not extend to any LCD Product or parts that have been lost or discarded by you or to damage to the LCD Product or parts caused by fires, misuse, accident, Acts of God (such as lightning or fluctuations in electric power), improper installation, improper maintenance, or use in violation of instructions furnished by TACP; use or malfunction through simultaneous use of this LCD Product and connected equipment; or to units that have been modified or had the serial number removed, altered, defaced, or rendered illegible.

## How to Obtain Warranty Service

If, after following all of the operating instructions in this manual and reviewing the section entitled "Troubleshooting," you find that service is needed:

- (1). To find the nearest TACP Authorized Service Station, visit TACP's website at [www.tacp.toshiba.com/service](http://www.tacp.toshiba.com/service) or contact TACP's Consumer Solution Center toll free at 1-800-575-5469.
- (2). You must present your original bill of sale or other proof of purchase to the TACP Authorized Service Station. You must deliver the entire LCD Product to a TACP Authorized Service Station. You must pay for all transportation and insurance charges for the LCD Product to and from the TACP Authorized Service Station.

For additional information, visit TACP's website:

[www.tacp.toshiba.com](http://www.tacp.toshiba.com)

ALL WARRANTIES IMPLIED BY THE LAW OF ANY STATE OF THE U.S.A., INCLUDING THE IMPLIED WARRANTIES OF MERCHANTABILITY AND FITNESS FOR A PARTICULAR PURPOSE, ARE EXPRESSLY LIMITED TO THE DURATION OF THE LIMITED WARRANTIES SET FORTH ABOVE. WITH THE EXCEPTION OF ANY WARRANTIES IMPLIED BY THE LAW OF ANY STATE OF THE U.S.A. AS HEREBY LIMITED, THE FOREGOING WARRANTY IS EXCLUSIVE AND IN LIEU OF ALL OTHER WARRANTIES, GUARANTEES, AGREEMENTS, AND SIMILAR OBLIGATIONS OF TACP WITH RESPECT TO THE REPAIR OR REPLACEMENT OF ANY PARTS. IN NO EVENT SHALL TACP BE LIABLE FOR CONSEQUENTIAL OR INCIDENTAL DAMAGES (INCLUDING, BUT NOT LIMITED TO, LOST PROFITS, BUSINESS INTERRUPTION, OR MODIFICATION OR ERASURE OF RECORDED DATA CAUSED BY USE, MISUSE OR INABILITY TO USE THIS LCD PRODUCT).

No person, agent, distributor, dealer, or company is authorized to change, modify, or extend the terms of these warranties in any manner whatsoever. The time within which an action must be commenced to enforce any obligation of TACP arising under the warranty or under any statute or law of the United States or any state thereof is hereby limited to ninety (90) days from the date you discover, or should have discovered, the defect. This limitation does not apply to implied warranties arising under the law of any state of the U.S.A.

THIS WARRANTY GIVES YOU SPECIFIC LEGAL RIGHTS AND YOU MAY ALSO HAVE OTHER RIGHTS WHICH MAY VARY FROM STATE TO STATE IN THE U.S.A. SOME STATES OF THE U.S.A. DO NOT ALLOW LIMITATIONS ON THE DURATION OF AN IMPLIED WARRANTY, WHEN AN ACTION MAY BE BROUGHT, OR THE EXCLUSION OR LIMITATION OF INCIDENTAL OR CONSEQUENTIAL DAMAGES. THEREFORE, THE ABOVE PROVISIONS MAY NOT APPLY TO YOU UNDER SUCH CIRCUMSTANCES.



# Limited Canada Warranty for 20" LCD Television

Toshiba Canada Limited, ("TCL") makes the following limited warranties to original consumers in Canada. THESE LIMITED WARRANTIES EXTEND TO THE ORIGINAL CONSUMER PURCHASER OR ANY PERSON RECEIVING THIS LCD PRODUCT AS A GIFT FROM THE ORIGINAL CONSUMER PURCHASER AND TO NO OTHER PURCHASER OR TRANSFEREE.

LCD PRODUCTS PURCHASED IN CANADA AND USED ANYWHERE OUTSIDE OF CANADA, INCLUDING, WITHOUT LIMITATION, THE U.S.A. AND MEXICO, ARE NOT COVERED BY THESE WARRANTIES.

LCD PRODUCTS PURCHASED ANYWHERE OUTSIDE OF CANADA, INCLUDING, WITHOUT LIMITATION, THE U.S.A. AND MEXICO, AND USED IN CANADA ARE NOT COVERED BY THESE WARRANTIES.

## Limited One (1) Year Warranty on Parts and Labour

TCL warrants this LCD Product and its parts against defects in materials or workmanship for a period of one (1) year after the date of original retail purchase. DURING THIS PERIOD, TCL WILL, AT TCL'S OPTION, REPAIR OR REPLACE A DEFECTIVE PART WITH A NEW OR REFURBISHED PART WITHOUT CHARGE TO YOU. YOU MUST DELIVER THE ENTIRE TELEVISION TO AN AUTHORIZED TCL SERVICE DEPOT. YOU MUST PAY FOR ALL TRANSPORTATION AND INSURANCE CHARGES FOR THE TELEVISION TO AND FROM THE SERVICE DEPOT.

## Rental Units

The warranty for LCD Product rental units begins on the date of the first rental or thirty (30) days after the date of shipment to the rental firm, whichever comes first.

## Limited Warranty for Commercial Units

TCL warrants LCD Products that are sold and used for commercial purposes as follows: all parts are warranted against defects in materials or workmanship for a period of ninety (90) days after the date of original retail purchase. DURING THIS PERIOD, TCL WILL, AT TCL'S OPTION, REPAIR OR REPLACE A DEFECTIVE PART WITH A NEW OR REFURBISHED PART WITHOUT CHARGE TO YOU. YOU MUST DELIVER THE ENTIRE TELEVISION TO AN AUTHORIZED TCL SERVICE DEPOT. YOU MUST PAY FOR ALL TRANSPORTATION AND INSURANCE CHARGES FOR THE TELEVISION TO AND FROM THE SERVICE DEPOT.

## Owner's Manual and Product Registration

Read this owner's manual thoroughly before operating this LCD Product.

Register your LCD Product online at [www.toshiba.ca](http://www.toshiba.ca) as soon as possible. By registering your LCD Product you will enable TCL to bring you new products specifically designed to meet your needs and help us to contact you in the unlikely event a safety notification is required. Failure to register your LCD Product does not diminish your warranty rights.

## Your Responsibility

THE ABOVE WARRANTIES ARE SUBJECT TO THE FOLLOWING CONDITIONS:

- (1). You must retain your original bill of sale or provide other proof of purchase.
- (2). All warranty servicing of this LCD Product must be made by an Authorized TCL Service Depot.
- (3). The warranties from TCL are effective only if this LCD Product is purchased in Canada from an authorized TCL dealer and operated in Canada.
- (4). Labour service charges for set installation, setup, adjustment of customer controls, and installation or repair of antenna systems are not covered by this warranty. Reception problems

caused by inadequate antenna systems, misaligned satellite dishes, cable television distribution, VCRs, DVD players/ recorders, personal computer level IEEE-1394 devices, and any other connected signal source device are your responsibility.

- (5). Warranties extend only to defects in materials or workmanship as limited above, and do not extend to any LCD Product or parts that have been lost or discarded by you or to damage to the LCD Product or parts caused by fires, misuse, accident, Acts of God (such as lightning or fluctuations in electric power), improper installation, improper maintenance, or use in violation of instructions furnished by TCL; use or malfunction through simultaneous use of this LCD Product and connected equipment; or to units that have been modified or had the serial number removed, altered, defaced, or rendered illegible.

## How to Obtain Warranty Service

If, after following all of the operating instructions in this manual and reviewing the section entitled "Troubleshooting," you find that service is needed:

- (1). To find the nearest TCL Authorized Service Depot, visit TCL's web site at [www.toshiba.ca](http://www.toshiba.ca).
- (2). You must include the original bill of sale (or a copy thereof) or other proof of purchase along with the entire LCD Product to the Authorized Service Depot. You are responsible for all inbound transportation and insurance charges for the LCD Product to the Authorized Service Depot.

**For additional information, visit TACP's website:**

[www.tacp.toshiba.com](http://www.tacp.toshiba.com)

ALL WARRANTIES IMPLIED BY THE LAW OF ANY PROVINCE OF CANADA, INCLUDING THE IMPLIED WARRANTIES OF MERCHANTABILITY AND FITNESS FOR A PARTICULAR PURPOSE, ARE EXPRESSLY LIMITED TO THE DURATION OF THE LIMITED WARRANTIES SET FORTH ABOVE. WITH THE EXCEPTION OF ANY WARRANTIES IMPLIED BY THE LAW OF ANY PROVINCE OF CANADA AS HEREBY LIMITED, THE FOREGOING WARRANTY IS EXCLUSIVE AND IN LIEU OF ALL OTHER WARRANTIES, GUARANTEES, AGREEMENTS, AND SIMILAR OBLIGATIONS OF TCL WITH RESPECT TO THE REPAIR OR REPLACEMENT OF ANY PARTS. IN NO EVENT SHALL TCL BE LIABLE FOR CONSEQUENTIAL OR INCIDENTAL DAMAGES (INCLUDING, BUT NOT LIMITED TO, LOST PROFITS, BUSINESS INTERRUPTION, OR MODIFICATION OR ERASURE OF RECORDED DATA CAUSED BY USE, MISUSE, OR INABILITY TO USE THIS LCD PRODUCT).

No person, agent, distributor, dealer, or company is authorized to change, modify, or extend the terms of these warranties in any manner whatsoever. The time within which an action must be commenced to enforce any obligation of TCL arising under the warranty or under any law of Canada or any province thereof is hereby limited to ninety (90) days from the date you discover, or should have discovered, the defect. This limitation does not apply to implied warranties arising under the law of any province of Canada.

THIS WARRANTY GIVES YOU SPECIFIC LEGAL RIGHTS AND YOU MAY ALSO HAVE OTHER RIGHTS WHICH MAY VARY FROM PROVINCE TO PROVINCE IN CANADA. SOME PROVINCES OF CANADA DO NOT ALLOW LIMITATIONS ON THE DURATION OF AN IMPLIED WARRANTY, WHEN AN ACTION MAY BE BROUGHT, OR THE EXCLUSION OR LIMITATION OF INCIDENTAL OR CONSEQUENTIAL DAMAGES. THEREFORE, THE ABOVE PROVISIONS MAY NOT APPLY TO YOU UNDER SUCH CIRCUMSTANCES. [0305]

# Index

## A

A/V cables .....	10
Antenna cables .....	10
Audio system connection .....	15
AVL .....	35

## B

Back of the TV .....	8
Blue screen .....	26

## C

Cable clamper .....	9
Cable converter box connection .....	11, 12
Camcorder connection .....	15
CBL/SAT button .....	19
CH ^ or CH v buttons .....	25
CH RTN/ENT button .....	26
Channel Number buttons .....	25
Channel programming	
Add/Erase .....	25
Automatically programming .....	24
CLEAR .....	20
Closed Caption .....	31
ColorStream® .....	13, 14
Component video cables .....	10

## D

DISPLAY button .....	33, 37
DTV receiver connection .....	14
DVD button .....	20
DVD connection .....	13
DVD MENU button .....	20

## F

FAV ▲▼ button .....	25
Favorite channels .....	25
FF ►► button .....	19
Front of the TV .....	8

## I

INPUT button .....	26
--------------------	----

## L

Language selection .....	24
Last mode memory .....	37

## M

Menu system .....	23
MTS .....	33
MUTE button .....	33

## P

Panel Lock .....	37
PAUSE ■■ button .....	19
PC connection .....	16
PC settings .....	36
PIC SIZE button .....	27
Picture adjustments	
Picture mode .....	30

Picture quality .....	30
Picture size selection .....	27
PLAY ► button .....	19
POWER button .....	17

## R

REC .....	19
Remote control	
Battery installation .....	18
Learning about the buttons .....	17
REW ◀◀ button .....	19

## S

SAP sound .....	33
Set-top box .....	14
SKIP/SEARCH ◀◀▶▶ button .....	20
Sleep timer .....	32
Sound mode selection .....	34
Sound quality adjustments .....	34
Specifications .....	38
Stereo sound .....	33
STOP ■ button .....	19
S-video cable .....	10

## T

TOP MENU button .....	20
Troubleshooting .....	39
TV button .....	20
TV/VCR button .....	19

## V

V-Chip	
Change Password .....	29
Moive Ratings .....	29
Password .....	29
USA TV Ratings .....	29
VCR button .....	19
VCR connection .....	11
VOL button .....	17

## W

Warranty .....	40, 41
----------------	--------

## **TOSHIBA AMERICA CONSUMER PRODUCTS, L.L.C.**

HEAD OFFICE:82 TOTOWA ROAD, WAYNE, NEW JERSEY 07470, U.S.A.

NATIONAL SERVICE DIVISION:1420B TOSHIBA DRIVE, LEBANON, TN. 37087, U.S.A.

## **TOSHIBA OF CANADA LTD.**

HEAD OFFICE/191 McNABB STREET MARKHAM, ONTARIO L3R 8H2, CANADA TEL: (905) 470-5400

SERVICE CENTERS:

TORONTO: 191 McNABB STREET MARKHAM, ONTARIO L3R 8H2, CANADA TEL: (905) 470-5400

MONTREAL: 18050 TRANS CANADA, KIRKLAND, QUEBEC, H9J-4A1, CANADA TEL:(514)390-7766

VANCOUVER: 22171 FRASERWOOD WAY, RICHMOND, B.C. V6W 1J5, CANADA TEL: (604) 303-2500

ColorStream is the registered trademark of Toshiba America Consumer Products, L.L.C.

# **TOSHIBA**

(Y/C/L) 72742112

## Free Manuals Download Website

<http://myh66.com>

<http://usermanuals.us>

<http://www.somanuals.com>

<http://www.4manuals.cc>

<http://www.manual-lib.com>

<http://www.404manual.com>

<http://www.luxmanual.com>

<http://aubethermostatmanual.com>

Golf course search by state

<http://golfingnear.com>

Email search by domain

<http://emailbydomain.com>

Auto manuals search

<http://auto.somanuals.com>

TV manuals search

<http://tv.somanuals.com>