

# TOSHIBA

# Owner's Manual

## LCD Color Television

COLORSTREAM® HD

SRS  
WOW

HDMI HDTV  
MONITOR

**26HL86**

**32HL86**

**37HL86**

For an overview of steps for setting up your new TV, see page 7.

A high definition tuner and programming are required to view High Definition TV broadcasts. Please contact your cable or satellite provider.

### Owner's Record

The model number and serial number are on the back of your TV. Record these numbers in the spaces below. Refer to these numbers whenever you communicate with your Toshiba dealer about this TV.

Model number:

Serial number:

## Dear Customer,

Thank you for purchasing this Toshiba LCD TV. This manual will help you use the many exciting features of your new LCD TV. **Before operating your LCD TV, please read this manual completely**, and keep it nearby for future reference.

### Safety Precautions

**WARNING: TO REDUCE THE RISK OF FIRE OR ELECTRIC SHOCK, DO NOT EXPOSE THIS APPLIANCE TO RAIN OR MOISTURE.**



**WARNING**  
RISK OF ELECTRIC SHOCK  
DO NOT OPEN.



**WARNING: TO REDUCE THE RISK OF ELECTRIC SHOCK, DO NOT REMOVE COVER (OR BACK). NO USER-SERVICEABLE PARTS INSIDE. REFER SERVICING TO QUALIFIED SERVICE PERSONNEL.**



The lightning flash with arrowhead symbol, within an equilateral triangle, is intended to alert the user to the presence of uninsulated "dangerous voltage" within the product's enclosure that may be of sufficient magnitude to constitute a risk of electric shock to persons.



The exclamation point within an equilateral triangle is intended to alert the user to the presence of important operating and maintenance (servicing) instructions in the literature accompanying the appliance.

### WARNING

To prevent injury, this apparatus must be securely attached to the floor/wall in accordance with the installation instructions. See item 19 on page 3.

**WARNING:** If you decide to wall mount this television, always use a UL-approved wall bracket appropriate for the size and weight of this television. The use of any wall bracket other than a UL-approved wall bracket appropriate for the size and weight of this television for wall mounting this television could result in serious bodily injury and/or property damage.

## Child Safety

### It Makes A Difference Where Your TV Stands



**Congratulations on your purchase! As you enjoy your new TV, keep these safety tips in mind:**

### The Issue

- If you are like most consumers, you have a TV in your home. Many homes, in fact, have more than one TV.
- The home theater entertainment experience is a growing trend, and larger TVs are popular purchases; however, they are not always supported on the proper TV stands.
- Sometimes TVs are improperly secured or inappropriately situated on dressers, bookcases, shelves, desks, audio speakers, chests, or carts. As a result, TVs may fall over, causing unnecessary injury.



### Toshiba Cares!

- The consumer electronics industry is committed to making home entertainment enjoyable and safe.
- The Consumer Electronics Association formed the Home Entertainment Support Safety Committee, comprised of TV and consumer electronics furniture manufacturers, to advocate children's safety and educate consumers and their families about television safety.

### Tune Into Safety

- One size does NOT fit all! Use appropriate furniture large enough to support the weight of your TV (and other electronic components).
- Use appropriate angle braces, straps, and anchors to secure your furniture to the wall (but never screw anything directly into the TV).
- Carefully read and understand the other enclosed instructions for proper use of this product.
- Do not allow children to climb on or play with furniture and TVs.
- Avoid placing any item on top of your TV (such as a VCR, remote control, or toy) that a curious child may reach for.
- Remember that children can become excited while watching a program and can potentially push or pull a TV over.
- Share our safety message about this hidden hazard of the home with your family and friends. Thank you!



2500 Wilson Blvd.  
Arlington, VA 22201 U.S.A.  
Tel. 703-907-7600 Fax 703-907-7690  
www.CE.org

*CEA is the Sponsor, Producer and  
Manager of the International CES®*

## Important Safety Instructions

- 1) **Read these instructions.**
  - 2) **Keep these instructions.**
  - 3) **Heed all warnings.**
  - 4) **Follow all instructions.**
- 
- 5) **Do not use this apparatus near water.**
- 
- 6) **Clean only with dry cloth.**
- 
- 7) **Do not block any ventilation openings.** Install in accordance with the manufacturer's instructions.



- 8) **Do not install near any heat sources** such as radiators, heat registers, stoves, or other apparatus (including amplifiers) that produce heat.
- 
- 9) **Do not defeat the safety purpose of the polarized or grounding type plug.** A polarized plug has two blades with one wider than the other. A grounding type plug has two blades and a third grounding prong. The wide blade or the third prong are provided for your safety. If the provided plug does not fit into your outlet, consult an electrician for replacement of the obsolete outlet.

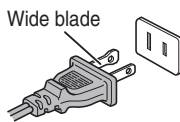

- 10) **Protect the power cord** from being walked on or pinched, particularly at plugs, convenience receptacles, and the point where they exit from the apparatus.

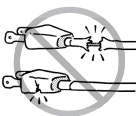

- 11) **Only use attachments/accessories specified by the manufacturer.**

- 12) **Use only with the cart, stand, tripod, bracket, or table specified by the manufacturer, or sold with the apparatus.** When a cart is used, use caution when moving the cart/apparatus combination to avoid injury from tip-over.



- 13) **Unplug this apparatus during lightning storms or when unused for long periods of time.**

- 14) **Refer all servicing to qualified service personnel.** Servicing is required when the apparatus has been damaged in any way, such as power-supply cord or plug is damaged, liquid has been spilled or objects have fallen into the apparatus, the apparatus has been exposed to rain or moisture, does not operate normally, or has been dropped.

## Additional Safety Precautions

- 14a) **CAUTION:** If the TV is dropped and the cabinet or enclosure surface has been damaged or the TV does not operate normally, take the following precautions:
  - ALWAYS turn off the TV and unplug the power cord to avoid possible electric shock or fire.
  - NEVER allow your body to come in contact with any broken glass or liquid from the damaged television. The LCD panel inside the TV contains glass and a toxic liquid. If the liquid comes in contact with your mouth or eyes, or your skin is cut by broken glass, rinse the affected area thoroughly with water and consult your doctor.

- ALWAYS contact a service technician to inspect the TV any time it has been damaged or dropped.

### 15) CAUTION:

- To reduce the risk of electric shock, do not use the polarized plug with an extension cord, receptacle, or other outlet unless the blades can be inserted completely to prevent blade exposure.
- To prevent electric shock, match wide blade of plug to wide slot; fully insert.

## Installation, Care, and Service

### Installation

Follow these recommendations and precautions and heed all warnings when installing your TV:

- 16) Never change or modify this equipment. Changes or modifications may void the warranty.

- 17) **DANGER: RISK OF SERIOUS PERSONAL INJURY, DEATH, OR EQUIPMENT DAMAGE!**



Never place the TV on an unstable cart, stand, or table. The TV may fall, causing serious personal injury, death, or serious damage to the TV.



- 18) To avoid damage to this product, never place or store the TV in direct sunlight; hot, humid areas; or areas subject to excessive dust or vibration.

- 19) Always place the TV on the floor or a sturdy, level, stable surface that can support the weight of the unit. To secure the TV, use a sturdy tie from the hooks on the rear of the TV pedestal to a wall, pillar, or other immovable structure. Make sure the tie is tight, secure, and parallel to the floor.

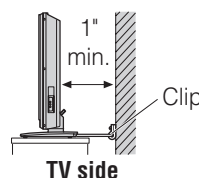

Sturdy tie (as short as possible; 1" min.)

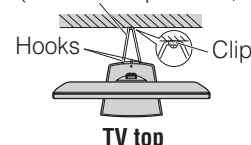

- 20) The apparatus shall not be exposed to dripping or splashing and that no objects filled with liquids, such as vases, shall be placed on the apparatus.

- 21) Never block or cover the slots or openings in the TV cabinet back, bottom, and sides. Never place the TV:

- on a bed, sofa, rug, or similar surface;
- too close to drapes, curtains, or walls; or
- in a confined space such as a bookcase, built-in cabinet, or any other place with poor ventilation.

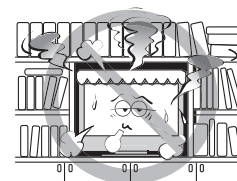

The slots and openings are provided to protect the TV from overheating and to help maintain reliable operation of the TV. Leave a space of at least 1 (one) inch around the TV.

- 22) Always place the back of the television at least one (1) inch away from any vertical surface (such as a wall) to allow proper ventilation.
- 23) Never allow anything to rest on or roll over the power cord, and never place the TV where the power cord is subject to wear or abuse.
- 24) Never overload wall outlets and extension cords.
- 25) Always operate this equipment from a 120 VAC, 60 Hz power source only.
- 26) Always make sure the antenna system is properly grounded to provide adequate protection against voltage surges and built-up static charges (see Section 810 of the National Electric Code).

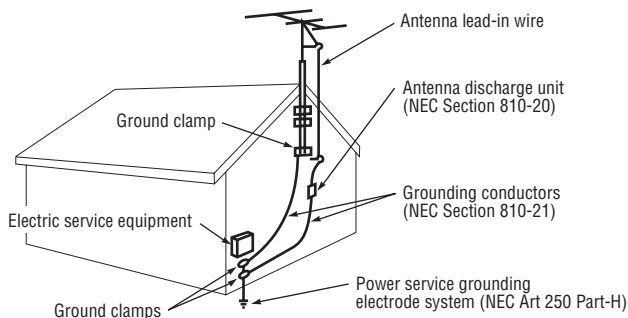

27) **! DANGER: RISK OF SERIOUS PERSONAL INJURY OR DEATH!**

- Use extreme care to make sure you are never in a position where your body (or any item you are in contact with, such as a ladder or screwdriver) can accidentally touch overhead power lines. Never locate the antenna near overhead power lines or other electrical circuits.
- Never attempt to install any of the following during lightning activity: a) an antenna system; or b) cables, wires, or any home theater component connected to an antenna or phone system.

### Care

For better performance and safer operation of your TOSHIBA TV, follow these recommendations and precautions:

- 28) If you use the TV in a room whose temperature is 32 °F (0 °C) or below, the picture brightness may vary until the LCD warms up. This is not a sign of malfunction.
- 29) Always unplug the TV before cleaning. Gently wipe the display panel surface (the TV screen) using dry, soft cloth only (cotton, flannel, etc.). A hard cloth may damage the surface of the panel. Avoid contact with alcohol, thinner, benzene, acidic or alkaline solvent cleaners, abrasive cleaners, or chemical cloths, which may damage the surface. Never spray volatile compounds such as insecticide on the cabinet. Such products may damage or discolor the cabinet.

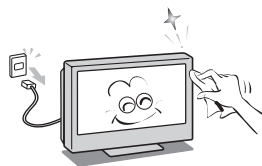

- 30) **! WARNING: RISK OF ELECTRIC SHOCK! !**  
Never spill liquids or push objects of any kind into the TV cabinet slots.

- 31) While it is thundering, do not touch the connecting cables or apparatus.
- 32) For added protection of your TV from lightning and power surges, always unplug the power cord and disconnect the antenna from the TV if you leave the TV unattended or unused for long periods of time.
- 33) During normal use, the TV may make occasional snapping or popping sounds. This is normal, especially when the unit is being turned on or off. If these sounds become frequent or continuous, unplug the power cord and contact a Toshiba Authorized Service Center.

- 34) **! WARNING: RISK OF SERIOUS PERSONAL INJURY OR EQUIPMENT DAMAGE!**  
Never strike the screen with a sharp or heavy object.



- 35) • The LCD screen of this product can be damaged by ultraviolet radiation from the sun. When selecting a location for the television, avoid locations where the screen may be exposed to direct sunlight, such as in front of a window.
- Never touch, press, or place anything on the LCD screen. These actions will damage the LCD screen. If you need to clean the LCD screen, follow the instructions in item 29 on this page.

### Service

- 36) **! WARNING: RISK OF ELECTRIC SHOCK! !**  
Never attempt to service the TV yourself. Opening and removing the covers may expose you to dangerous voltage or other hazards. Failure to follow this WARNING may result in death or serious injury. Refer all servicing not specified in this manual to a Toshiba Authorized Service Center.

- 37) If you have the TV serviced:
  - Ask the service technician to use only replacement parts specified by the manufacturer.
  - Upon completion of service, ask the service technician to perform routine safety checks to determine that the TV is in safe operating condition.

- 38) The cold cathode fluorescent lamp in the LCD panel contains a small amount of mercury. When the TV reaches the end of its useful life, dispose of the used TV by the approved method for your area, or ask a qualified service technician to properly dispose of the TV.

**! Note:** The lamp unit contains mercury, the disposal of which may be regulated due to environmental considerations. For disposal or recycling information, contact your local authorities or the Electronics Industries Alliance ([www.eiae.org](http://www.eiae.org)).

---

## Welcome to Toshiba

Thank you for purchasing this Toshiba TV, one of the most innovative LCD TVs on the market.

This manual applies to models 26HL86, 32HL86, and 37HL86. The model and serial numbers are on the back of your TV. Write these numbers in the space provided on the front cover of this manual for your records.

Instructions in this manual are based on using the remote control. You can also use the controls on the TV if they have the same name as those on the remote control.

Please read all the safety and operating instructions carefully, and keep the manual for future reference.

---

## Important notes about your LCD TV

**The following symptoms are technical limitations of LCD Display technology and are not an indication of malfunction; therefore, Toshiba is not responsible for perceived issues resulting from these symptoms.**

- 1) An afterimage (ghost) may appear on the screen if a fixed, non-moving image is displayed for a long period of time. The afterimage is not permanent and will disappear in a short period of time.
- 2) The LCD panel contained in this TV is manufactured using an extremely high level of precision technology; however, there may be an occasional pixel (dot of light) that does not operate properly (does not light, remains constantly lit, etc.). This is a structural property of LCD technology, is not a sign of malfunction, and is not covered under your warranty. Such pixels are not visible when the picture is viewed from a normal viewing distance.

**Note:** Interactive video games that involve shooting a "gun" type of joystick at an on-screen target may not work with this TV.

---

## Trademark Information

- WOW, SRS and  symbol are trademarks of SRS Labs, Inc. WOW technology is incorporated under license from SRS Labs, Inc.
- HDMI, the HDMI logo and High-Definition Multimedia Interface are trademarks or registered trademarks of HDMI Licensing LLC.

# Contents

<b>Chapter 1: Introduction</b> . . . . .	<b>7</b>	Adjusting the picture. . . . .	35
Features of your new TV . . . . .	7	Selecting the picture mode. . . . .	35
Overview of steps for installing, setting up, and using your new TV. . . . .	7	Adjusting the picture quality . . . . .	35
TV front and side panel controls and connections . . . . .	8	Using the black stretch feature. . . . .	36
TV back panel connections. . . . .	9	Using MPEG noise reduction. . . . .	36
<b>Chapter 2: Connecting your TV</b> . . . . .	<b>10</b>	Using CableClear®/DNR (digital noise reduction) . . . . .	36
Overview of cable types . . . . .	10	Selecting the color temperature . . . . .	37
About the connection illustrations . . . . .	11	Using the closed caption mode. . . . .	37
Connecting an antenna or cable TV . . . . .	11	Closed Caption Reception Adjustment . . . . .	38
Connecting a VCR and antenna or Cable TV (no Cable box) . . . . .	11	Adjusting the audio. . . . .	38
Connecting a VCR and Cable box . . . . .	12	Muting the sound . . . . .	38
Connecting a DVD player with ColorStream® (component video), a VCR, and a satellite receiver. . . . .	13	Selecting stereo/SAP broadcasts . . . . .	38
Connecting two VCRs . . . . .	14	Adjusting the audio quality . . . . .	39
Connecting a camcorder . . . . .	14	Using the SRS WOW™ surround sound feature . . . . .	39
Connecting an HDMI™ or DVI device to the HDMI input . . . . .	15	Using the StableSound® feature. . . . .	40
HDMI device connection . . . . .	15	Using the Locks menu . . . . .	40
DVI device connection. . . . .	15	Entering the PIN code . . . . .	40
Connecting a personal computer (PC) . . . . .	16	If you cannot remember your PIN code. . . . .	40
<b>Chapter 3: Using the remote control</b> . . . . .	<b>17</b>	Changing your PIN code . . . . .	41
Preparing the remote control for use. . . . .	17	Locking channels . . . . .	41
Installing the remote control batteries . . . . .	17	Using the Video lock feature . . . . .	41
Remote control effective range. . . . .	17	Using the PC setting feature . . . . .	42
Learning about the remote control . . . . .	18	PC Audio. . . . .	42
Using the remote control to operate your other devices. . . . .	19	Setting the sleep timer. . . . .	43
Remote Control functional key chart . . . . .	20	Setting the On timer . . . . .	43
Programming the remote control to operate your other devices. . . . .	21	Displaying TV setting information on-screen using RECALL . . . . .	44
Remote control codes . . . . .	22	Understanding the auto power off feature . . . . .	44
<b>Chapter 4: Menu layout and navigation</b> . . . . .	<b>24</b>	Understanding the last mode memory feature . . . . .	44
Menu Layout. . . . .	24	<b>Chapter 7: Troubleshooting</b> . . . . .	<b>45</b>
Navigating the menu system. . . . .	25	General troubleshooting . . . . .	45
<b>Chapter 5: Setting up your TV</b> . . . . .	<b>26</b>	<b>Chapter 8: Appendix</b> . . . . .	<b>47</b>
Selecting the menu language . . . . .	26	Specifications . . . . .	47
Programming channels into the TV's channel memory . . . . .	26	Limited Canada Warranty for LCD Televisions. . . . .	48
Programming channels automatically . . . . .	26	<b>Index</b> . . . . .	<b>49</b>
Manually adding and deleting channels in the channel memory . . . . .	27		
Programming your favorite channels . . . . .	27		
Labeling channels . . . . .	28		
Setting the HDMI™ audio mode. . . . .	29		
<b>Chapter 6: Using the TV's features</b> . . . . .	<b>30</b>		
Selecting the video input source to view . . . . .	30		
Labeling the video input sources . . . . .	30		
Tuning channels . . . . .	31		
Tuning your favorite channels . . . . .	31		
Tuning to the next programmed channel . . . . .	31		
Tuning to a specific channel (programmed or unprogrammed) . . . . .	31		
Tuning to a specific programmed channel (or video mode) using the Program list. . . . .	31		
Switching between two channels using Channel Return . . . . .	31		
Selecting the picture size . . . . .	31		
Adjusting the Picture Position . . . . .	33		
Using the auto aspect ratio feature . . . . .	33		
Using the blue screen function . . . . .	34		
Selecting the gray level for 4:3 mode side panels . . . . .	34		
Selecting the cinema mode (480i signals only) . . . . .	34		

## Features of your new TV

The following are just a few of the many exciting features of your new Toshiba widescreen LCD TV:

- **Two sets of ColorStream® HD** high-resolution component video inputs (☞ pages 9 and 13).
- **HDMI™** digital, high-definition multimedia interface (☞ pages 9 and 15).
- **SRS WOW™** audio technologies (☞ page 39).
- **CableClear® DNR** digital picture noise reduction (☞ page 36).
- **PC IN (Analog RGB)** computer input (☞ pages 9 and 16).

## Overview of steps for installing, setting up, and using your new TV

Follow these steps to set up your TV and begin using its many exciting features.

- 1** Carefully read the important safety, installation, care, and service information (☞ pages 2–4). Keep this manual for future reference.
- 2** Observe the following when choosing a location for the TV:
  - Place the TV on the floor or a sturdy, level, stable surface that can support the weight of the unit. Secure the TV to a wall, pillar, or other immovable structure (☞ page 3).
  - Place the TV in a location where light does not reflect on the screen.
  - Place the TV far enough from walls and other objects to allow proper ventilation. Inadequate ventilation may cause overheating, which will damage the TV. **THIS TYPE OF DAMAGE IS NOT COVERED UNDER THE TOSHIBA WARRANTY.**
- 3** Do not plug in any power cords until **AFTER** you have connected all cables and devices to your TV.
- 4** **BEFORE** connecting cables or devices to the TV, learn the functions of the TV's connections and controls (☞ pages 8–9).
- 5** Connect your other electronic device(s) to the TV (☞ pages 10–16).
- 6** Install the batteries in the remote control (☞ page 17).
- 7** See “Learning about the remote control” (☞ page 18) for an overview of the buttons on the remote control.
- 8** Program the remote control to operate your other device(s) (☞ pages 19–23).

- 9** **AFTER** connecting all cables and devices, plug in the power cords for your TV and other devices. Press **POWER** on the TV control panel or remote control to turn on the TV.
- 10** See “Menu layout and navigation” for a quick overview of the TV's menu system (☞ page 24).
- 11** Program channels into the TV's channel memory (☞ page 26).
- 12** For details on using the TV's features, see Chapter 6.
- 13** For help, refer to the Troubleshooting section (☞ Chapter 7).
- 14** For technical specifications and warranty information, see Chapter 8.
- 15** Enjoy your new TV!

## TV front and side panel controls and connections

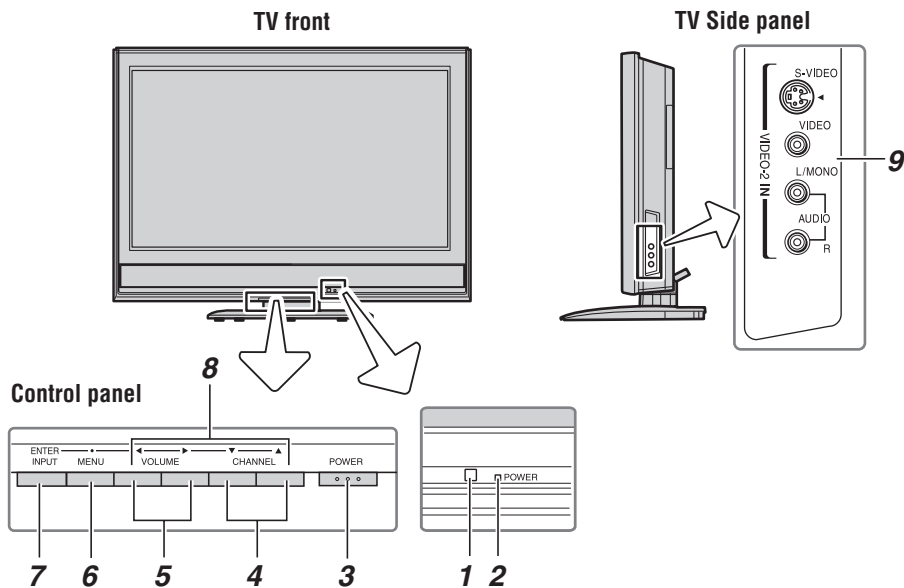

- 1 Remote sensor** — Point the remote control toward the remote sensor. See “Remote control effective range” (🔍 page 17).
- 2 Red LED** — Red light indicates power is on.
- 3 POWER** — Press to turn the TV on and off.
- 4 CHANNEL ▲▼** — When no menu is on-screen, these buttons change the channel (programmed channels only; 🔍 page 26). When a menu is on-screen, these buttons function as up/down menu navigation buttons.
- 5 VOLUME ◀▶** — When no menu is on-screen, these buttons adjust the volume level. When a menu is on-screen, these buttons function as left/right menu navigation buttons.
- 6 MENU** — Press to access the menu system (🔍 page 24).
- 7 INPUT (ENTER)** — Repeatedly press to change the source you are viewing (**VIDEO-1/ColorStream HD-1, VIDEO-2, ColorStream HD-2, HDMI, PC, or antenna/cable channel**). When a menu is on-screen, the **INPUT** button on the TV’s control panel functions as the **Enter** button.
- 8 ARROWS ▲▼◀▶** — When a menu is on-screen, these buttons function as up/down/left/right menu navigation buttons.
- 9 VIDEO-2 IN** — Standard (composite) video and standard (analog) audio inputs plus optional S-video input for connecting devices with either composite video or S-video output.
 

**Note:**

  - Standard (composite) video and S-video cables carry only video information; separate audio cables are required for a complete connection.
  - Do not connect both a composite video and an S-video cable to **VIDEO-2** simultaneously or the picture performance will be unacceptable.



## TV back panel connections

For an explanation of cable types and connections, see Chapter 2 (🔗 page 10).

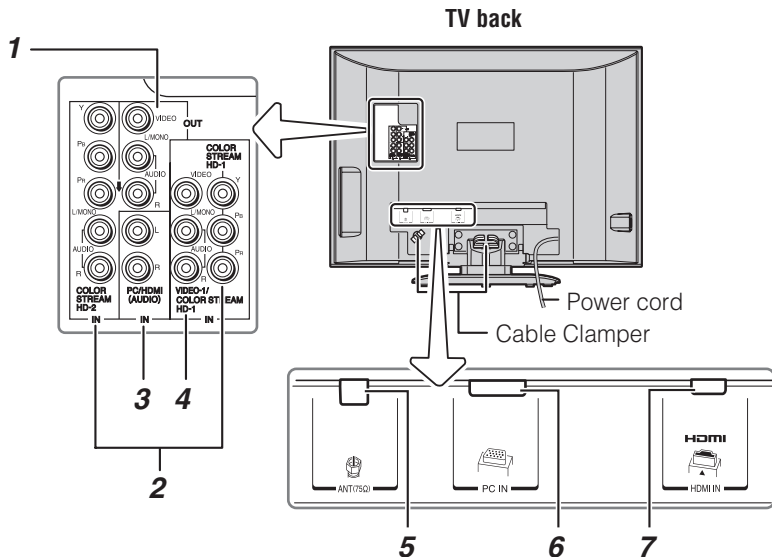

- 1 A/V OUT** — Standard composite video and analog audio outputs for connecting a VCR for editing and dubbing.
- 2 ColorStream® HD-1 and ColorStream® HD-2** — Two sets of ColorStream® high-definition component video inputs (with standard analog audio inputs) for connecting devices with component video output, such as a Toshiba DVD player with ColorStream®.  
*Note: Component video cables carry only video information; separate audio cables are required for a complete connection.*
- 3 PC/HDMI (AUDIO) IN** — One set of shared analog audio inputs (shared between the **PC IN** and **HDMI IN** terminals). Their use can be configured in the **Set Up** menu (🔗 page 42).
- 4 VIDEO-1 IN** — Standard (composite) video and standard (analog) audio inputs for connecting devices with composite video output.

*Note: VIDEO-1 input terminals are shared with ColorStream HD-1 input terminals. When component video cables are connected to the ColorStream HD-1 terminals and ColorStream HD-1 is the current input mode, the VIDEO-1 input terminals will not carry any signals.*

- 5 ANT** — Antenna input that supports analog (NTSC) antenna signals and analog cable TV signals.
- 6 PC IN** — For use when connecting a personal computer (🔗 page 16).
- 7 HDMI™ IN** — High-Definition Multimedia Interface input receives digital audio and uncompressed digital video from an HDMI device, or uncompressed digital video from a DVI device (🔗 item 3, at left; also 🔗 page 15).

HDMI, the HDMI logo and High-Definition Multimedia Interface are trademarks or registered trademarks of HDMI Licensing LLC.

## Chapter 2: Connecting your TV

### Overview of cable types

#### Coaxial (F-type) cable



Coaxial (F-type) cable is used for connecting your antenna, cable TV service, and/or cable converter box to the **ANT** input on your TV.

#### Standard A/V cables (red/white/yellow)



Standard A/V cables (composite video) usually come in sets of three, and are for use with video devices with analog audio and composite video output. These cables (and the related inputs on your TV) are typically color-coded according to use: yellow for video, red for stereo right audio, and white for stereo left (or mono) audio.

#### S-video cable



S-video cable is for use with video devices with S-video output. Separate audio cables are required for a complete connection.

**Note:** An S-video cable provides better picture performance than a composite video cable. If you connect an S-video cable, be sure to disconnect the standard (composite) video cable or the picture performance will be unacceptable.

#### Component video cables (red/green/blue)



Component video cables come in sets of three and are for use with video devices with component video output.

(ColorStream® is Toshiba's brand of component video.) These cables are typically color-coded red, green, and blue. Separate audio cables are required for a complete connection.

**Note:** Component video cables provide better picture performance than a standard (composite) video or S-video cable.

#### HDMI™ cable



HDMI (High-Definition Multimedia Interface) cable is for use with devices with HDMI output. An HDMI cable delivers digital audio and video in its native format. This cable carries both video and audio information; therefore, separate audio cables are not required for a complete HDMI device connection (➤ page 15).

**Note:** HDMI cable provides better picture performance than a standard (composite) video or S-video cable.

#### Analog RGB (15-pin) computer cable

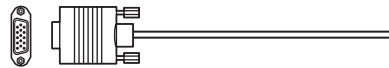

Analog RGB (15-pin) computer cable is for connecting a PC to the TV's **PC IN** terminal (➤ page 16).

## About the connection illustrations

You can connect different types and brands of devices to your TV in several different configurations. The connection illustrations in this manual are representative of typical device connections only. The input/output terminals on your devices may differ from those illustrated herein. For details on connecting and using your specific devices, refer to each device's owner's manual.

## Connecting an antenna or cable TV

This connection allows you to watch TV programs or basic cable channels.

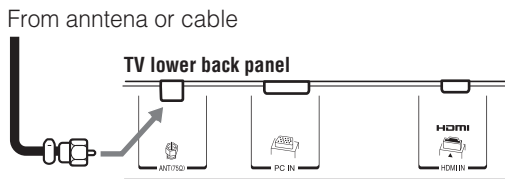

## Connecting a VCR and antenna or Cable TV (no Cable box)

### You will need:

- coaxial cables
- standard A/V cables
  - For better picture performance, if your VCR has S-video, connect an S-video cable and standard (analog) audio cables to the **VIDEO-2** inputs on the side panel (instead of the **VIDEO-1** inputs). Do not connect both types of video cable to **VIDEO-2** at the same time or the picture performance will be unacceptable.
  - If you have a mono VCR, connect **L/MONO** on the TV to your VCR's audio out terminal using the white audio cable only.

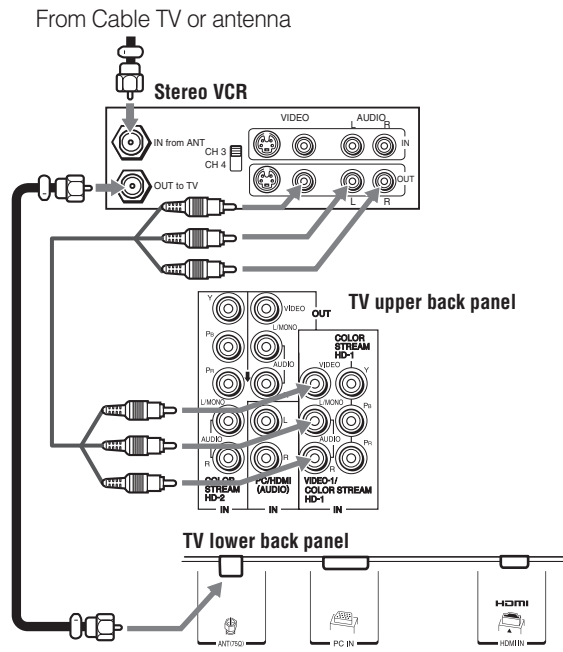

### To view the antenna or Cable signal:

Select the antenna/cable channel input source on the TV.\*

### To view the VCR:

Turn ON the VCR. Select the **Video 1** video input source on the TV.\*

\*To select the video input source, press **INPUT** on the remote control (page 30). To program the TV remote control to operate other devices, see "Using the remote control to operate your other devices" on page 19.

**The unauthorized recording, use, distribution, or revision of television programs, videotapes, DVDs, and other materials is prohibited under the Copyright Law and may subject you to civil and criminal liability.**

## Connecting a VCR and Cable box

### You will need:

- coaxial cables
- standard A/V cables
  - For better picture performance, if your VCR has S-video, connect an S-video cable and standard (analog) audio cables to the **VIDEO-2** inputs on the side panel (instead of the **VIDEO-1** inputs). Do not connect both types of video cable to **VIDEO-2** at the same time or the picture performance will be unacceptable.
  - If you have a mono VCR, connect **L/MONO** on the TV to your VCR's audio out terminal using the white audio cable only.
  - When you use a Cable box, you may not be able to use the remote control to program or access certain features on the TV.

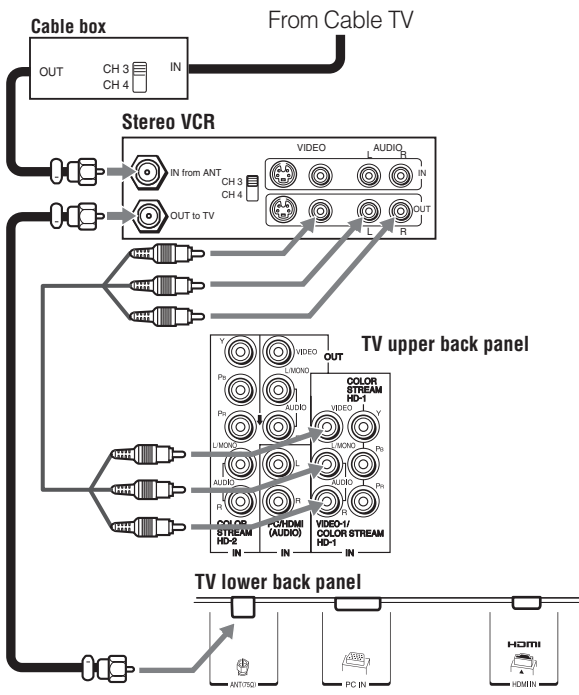

### To view basic and premium Cable channels:

Turn OFF the VCR. Select the antenna/cable channel input source on the TV.\* Tune the TV to channel 3 or 4 (whichever channel the Cable box output is set to). Use the Cable box controls to change channels.

### To view the VCR:

Turn ON the VCR. Select the **Video 1** video input source on the TV.\*

\*To select the video input source, press **INPUT** on the remote control (page 30). To program the TV remote control to operate other devices, see "Using the remote control to operate your other devices" on page 19.

**The unauthorized recording, use, distribution, or revision of television programs, videotapes, DVDs, and other materials is prohibited under the Copyright Law and may subject you to civil and criminal liability.**

## Connecting a DVD player with ColorStream® (component video), a VCR, and a satellite receiver

Your TV has two sets of ColorStream® HD (high definition component video) inputs.

### You will need:

- coaxial cables
- standard A/V cables
- For better picture performance, if your VCR has S-video, connect an S-video cable and standard (analog) audio cables to the **VIDEO-2** inputs on the side panel (instead of the **VIDEO-1** inputs). Do not connect both types of video cable to **VIDEO-2** at the same time or the picture performance will be unacceptable.
- If you have a mono VCR, connect **L/MONO** on the TV to your VCR's audio out terminal using the white audio cable only.
- standard audio cables
- component video cables
- You can connect the component video cables (plus audio cables) from the DVD player or satellite receiver to either set of **ColorStream** terminals on the TV (**HD-1** or **HD-2**). The **ColorStream HD-1** and **HD-2** terminals can be used with Progressive (480p, 720p) and Interlaced (480i, 1080i) scan systems. A 1080i signal will provide the best picture performance.
- If your DVD player or satellite receiver does not have component video or S-video, connect standard A/V cables to **VIDEO-1**. If your DVD player has HDMI video, see page 15.

### To view antenna or Cable channels:

Select the antenna/cable channel input source on the TV.\*

### To view the DVD player:

Turn ON the DVD player. Select the **ColorStream HD-1** video input source on the TV.\*

### To view satellite programs using the component video connections:

Turn on the satellite receiver. Select the **ColorStream HD-2** video input source on the TV.\*

### To view the VCR or view and record antenna channels:

Turn ON the VCR. Tune the VCR to the channel you want to watch. Select the **Video 2** video input source on the TV.\*

### To record a TV program while watching a DVD:

Turn ON the VCR. Tune the VCR to the channel to record. Select the **ColorStream HD-1** video input source on the TV\* to view the DVD.

\*To select the video input source, press **INPUT** on the remote control (see page 30). To program the TV remote control to operate other devices, see "Using the remote control to operate your other devices" on page 19.

The unauthorized recording, use, distribution, or revision of television programs, videotapes, DVDs, and other materials is prohibited under the Copyright Law and may subject you to civil and criminal liability.

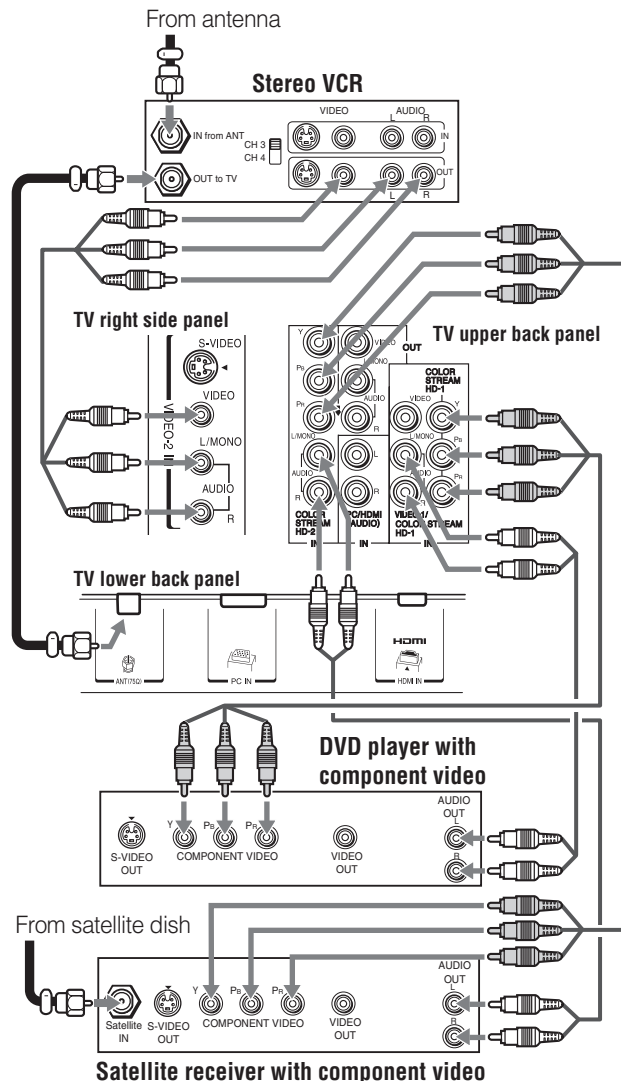

## Connecting two VCRs

This connection allows you to record (dub/edit) from one VCR (“VCR1” in the illustration below) to a second VCR (“VCR2”) while watching a videotape. You also can record from one TV channel with VCR1 while watching another TV channel.

### You will need:

- coaxial cables
- standard A/V cables

### Note:

- If you have VCRs with S-video, use S-video cables instead of standard video cables for better picture performance.
- Do not connect the same VCR to the output and input jacks on the TV at the same time. To dub or edit, VCR 2 must select **LINE IN**, and the TV must select **Video 1**.

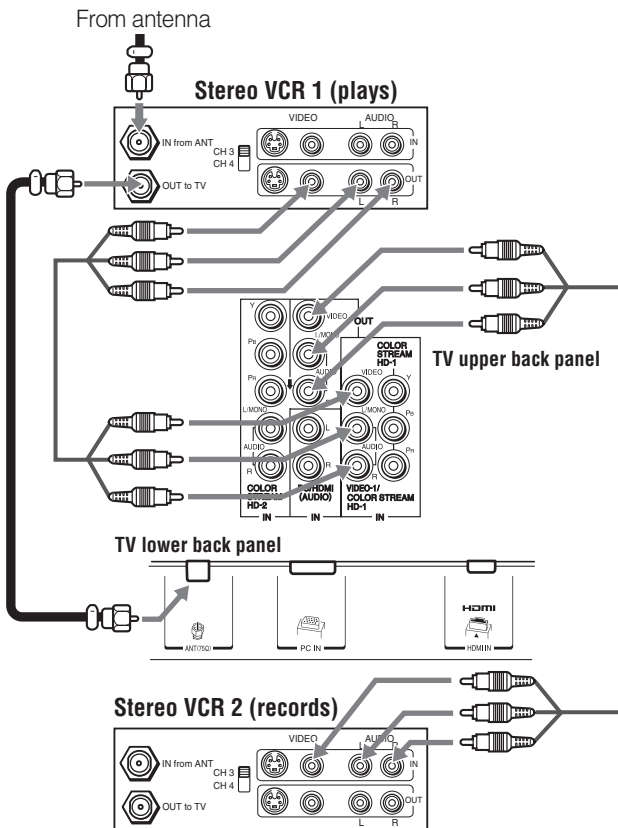

## Connecting a camcorder

### You will need:

- standard A/V cables
  - For better picture performance, if your camcorder has S-video, connect an S-video cable (plus the audio cables) to **VIDEO-2** on the TV side panel.

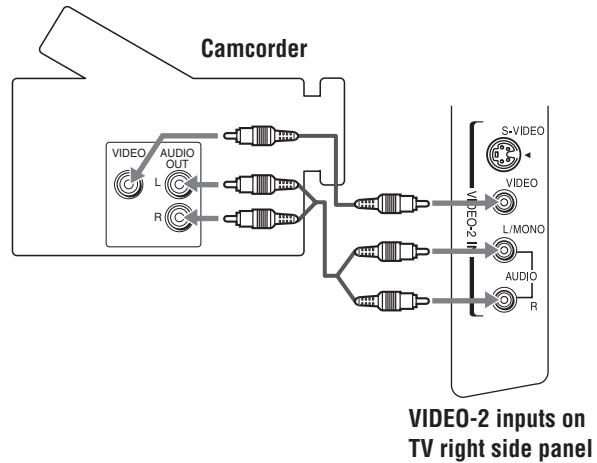

### To view the camcorder video:

Select the **Video 2** video input source on the TV.\*

\*To select the video input source, press **INPUT** on the remote control (page 30). To program the TV remote control to operate other devices, see “Using the remote control to operate your other devices” on page 19.

## Connecting an HDMI™ or DVI device to the HDMI input

The HDMI input on your TV receives digital audio and uncompressed digital video from an HDMI source device, or uncompressed digital video from a DVI (Digital Visual Interface) source device.

This input is designed to accept HDCP (High-Bandwidth Digital-Content Protection) program material in digital form from EIA/CEA-861-861B-compliant<sup>[1]</sup> consumer electronic devices (such as a set-top box or DVD player with HDMI or DVI output).

The HDMI input is designed for best performance with 1080i signals but will also accept and display 480i, 480p and 720p signals.



**NOTE: DO NOT CONNECT A PC USING THE HDMI PORT.** Always use the TV's PC IN (VGA) port to connect a PC.

- The **HDMI** port is not designed to support input from a PC.
- Only TV models that include a **PC IN** (VGA) port are suitable for connection to a PC.

## HDMI device connection

To connect an HDMI device, you will need:

- one HDMI cable (type A connector) per HDMI device
  - For proper operation, it is recommended that you use as short an HDMI cable as possible. You should not encounter difficulty if you use an HDMI cable shorter than 16.4 ft (5m).
  - HDMI cable transfers both video and audio. Separate analog audio cables are not required (see illustration).
  - See “Setting the HDMI™ audio mode” on page 29.

### HDMI device

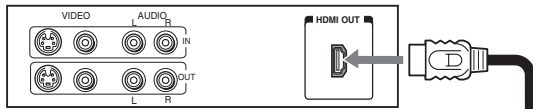

### TV lower back panel

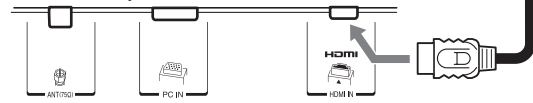

**Note:** If the audio output mode of the HDMI device is other than the PCM mode, the TV speakers will not output sound.

## DVI device connection

To connect a DVI device, you will need:

- one HDMI-to-DVI adapter cable (HDMI type A connector) per DVI device
  - For proper operation, the length of an HDMI-to-DVI adapter cable should not exceed 9.8 ft (3m). The recommended length is 6.6 ft (2m).
- one pair of standard analog audio cables per DVI device
  - An HDMI-to-DVI adapter cable transfers video only. Separate analog audio cables are required (see illustration).
  - See “Setting the HDMI™ audio mode” on page 29.

### DVI device

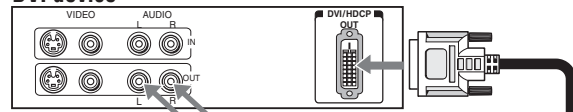

### TV upper back panel

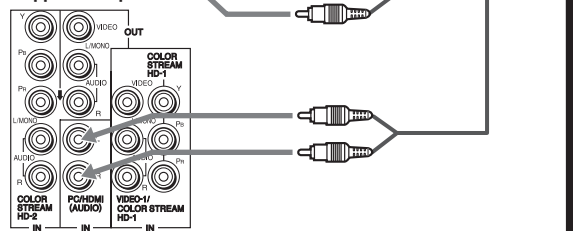

### TV lower back panel

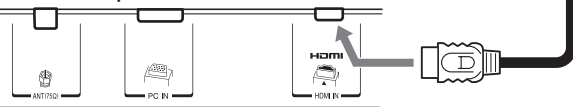

**Note:** To ensure that the HDMI or DVI device is reset properly, it is recommended that you follow these procedures:

- When turning on your electronic components, **turn on the TV first**, and then the HDMI or DVI device.
- When turning off your electronic components, **turn off the HDMI or DVI device first**, and then the TV.

[1] EIA/CEA-861-861B compliance covers the transmission of uncompressed digital video with high-bandwidth digital content protection, which is being standardized for reception of high-definition video signals. Because this is an evolving technology, it is possible that some devices may not operate properly with the TV.

HDMI, the HDMI logo and High-Definition Multimedia Interface are trademarks or registered trademarks of HDMI Licensing LLC.

## Connecting a personal computer (PC)

This connection allows you to view the image from a PC on the TV screen. When connecting a PC to the TV, use an analog RGB (15-pin) computer cable and a PC audio cable.

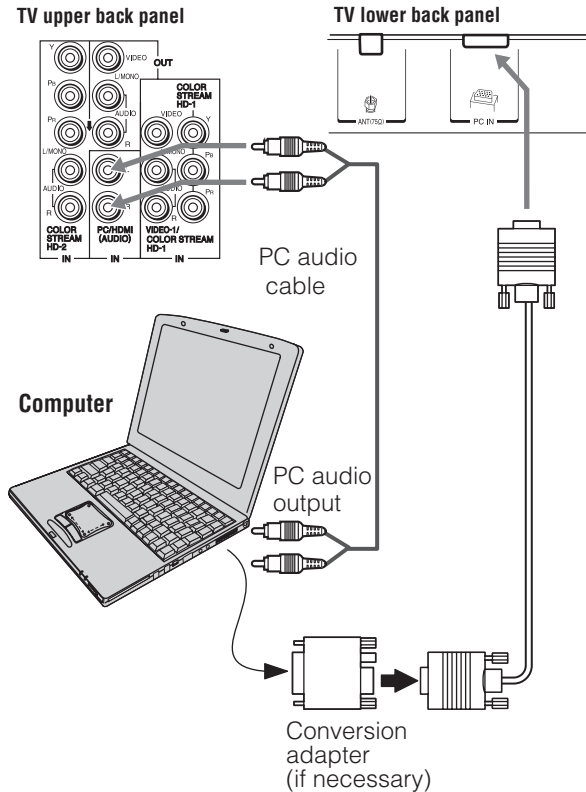

- To use a PC, set the monitor output resolution on the PC before connecting it to the TV. The following signals can be displayed:
  - VGA: 640 × 480 @ 60Hz
  - SVGA: 800 × 600 @ 60Hz
  - XGA: 1024 × 768 @ 60Hz
  - SXGA: 1280 × 1024 @ 60Hz
 Other formats or non-standard signals will not be displayed correctly.
- To display the optimum picture, use the PC setting feature (🔍 “Using the PC setting feature” on page 42).

### Signal names for mini D-sub 15-pin connector

Pin assignment for RGB/PC terminal

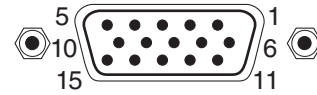

Pin No.	Signal name
1	R
2	G
3	B
4	NC (not connected)
5	NC
6	Ground
7	Ground
8	Ground
9	NC
10	Ground
11	NC
12	NC
13	H-sync
14	V-sync
15	NC

#### Note:

- Some PC models cannot be connected to this TV.
- An adapter is not needed for computers with a DOS/V compatible mini D-sub 15-pin terminal.
- Depending on the DVD's title and the specifications of the PC on which you are playing the DVD-Video, some scenes may be skipped or you may not be able to pause during multi-angle scenes.
- Never connect a PC to the **HDMI** port.



## Chapter 3: Using the remote control

### Preparing the remote control for use

Your TV remote control can operate your TV and many other devices such as cable converter boxes, satellite receivers, VCRs, DVD players, and HTIBs (home theater in a box), even if they are different brands.

#### If you have a Toshiba device:

Your TV remote control is preprogrammed to operate most Toshiba devices (see page 21).

#### If you have a non-Toshiba device or a Toshiba device that the remote control is not preprogrammed to operate:

You can program the TV remote control so it will operate the other device (see pages 19–23).

### Installing the remote control batteries

- 1 Remove the battery cover from the back of the remote control.

Squeeze tab and lift cover.

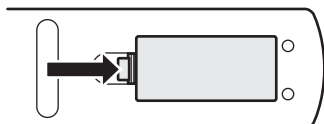

- 2 Install two “AAA” size batteries, making sure to match the + and – signs on the batteries to the signs on the battery compartment.

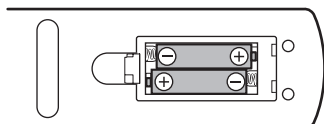

- 3 Reinsert the battery cover in the remote control until the tab snaps.

**Caution:** Never throw batteries into a fire.

#### Note:

- Be sure to use AAA size batteries.
- Dispose of batteries in a designated disposal area.
- Batteries should always be disposed of with the environment in mind. Always dispose of batteries in accordance with applicable laws and regulations.
- If the remote control does not operate correctly, or if the operating range becomes reduced, replace batteries with new ones.
- When necessary to replace batteries in the remote control, always replace both batteries with new ones. Never mix battery types or use new and used batteries in combination.

- Always remove batteries from the remote control if they are dead or if the remote control is not to be used for an extended period of time. This will prevent battery acid from leaking into the battery compartment.

### Remote control effective range

For optimum performance, aim the remote control directly at the TV and make sure there is no obstruction between the remote control and the TV.

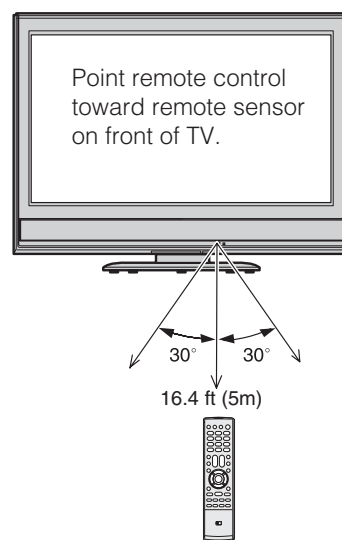

## Learning about the remote control

The buttons used for operating the TV only are described here. For a complete list of the remote control's functions, see the remote control functional key chart (page 20).

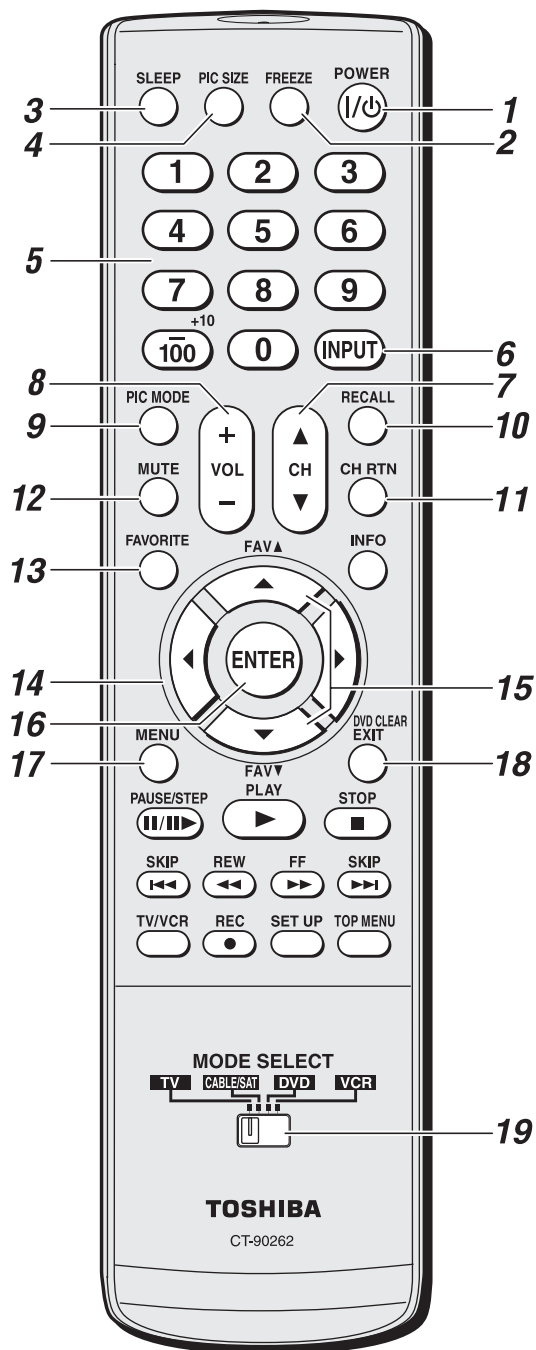

- 1 **POWER** turns the TV on and off. Press **POWER** to turn on the TV. The red LED indicator on the TV front will be illuminated. Press **POWER** again to turn off the TV.
- 2 **FREEZE** freezes the picture. Press again to restore the moving picture.
- 3 **SLEEP** accesses the sleep timer (page 43).
- 4 **PIC SIZE** cycles through the pictures sizes: **Natural**, **TheaterWide 1/2/3**, **Full**, and **4:3 HD** (page 31).
- 5 **Channel Numbers (0–9, –/100)** directly tune channels. The “–” button is used to tune digital channels (page 31) or to display the favorite channel list (page 27).
- 6 **INPUT** selects the video input source (page 30).
- 7 **CH ▲▼** cycles through programmed channels when no menu is on-screen (page 26) and functions as page up/down when a menu is on-screen.
- 8 **VOL + –** adjusts the volume level.
- 9 **PIC MODE** selects the picture mode (page 35).
- 10 **RECALL** displays TV setting information on-screen (page 44).
- 11 **CH RTN** returns to the last viewed channel (page 31).
- 12 **MUTE** reduces or turns off the sound (page 38).
- 13 (This button is not available for this TV.)
- 14 **Arrow buttons (▲▼◀▶)** When a menu is on-screen, these buttons select or adjust programming menus.
- 15 **FAV ▲▼** tunes to the next higher/lower favorite channel (page 27).
- 16 **ENTER** activates highlighted items in the main menu system.
- 17 **MENU** accesses the main TV menu system (pages 24 and 25).
- 18 **EXIT** closes on-screen menus.
- 19 **MODE SELECT Switch** switches between TV, CABLE/SAT, DVD, and VCR modes (page 19). Set to “TV” to control the TV.

**Note:** The error message “Not Available” may appear if you press a key for a function that is not available.

## Using the remote control to operate your other devices

If you have a non-Toshiba device or a Toshiba device that the remote control is not preprogrammed to operate, you must first program the remote control to recognize the device (if you have not already done so) (pages 21–23).

### To use your TV remote control to operate a:

- Cable converter box or satellite receiver, set the MODE SELECT Switch to **CABLE/SAT**.
- DVD player or HTIB, set the MODE SELECT Switch to **DVD**.
- VCR, set the MODE SELECT Switch to **VCR**.

**Note:** Even after the TV remote control is programmed, it may not operate certain features on your other device. If this happens and you wish to use those features, you will need to use the device's original remote control.

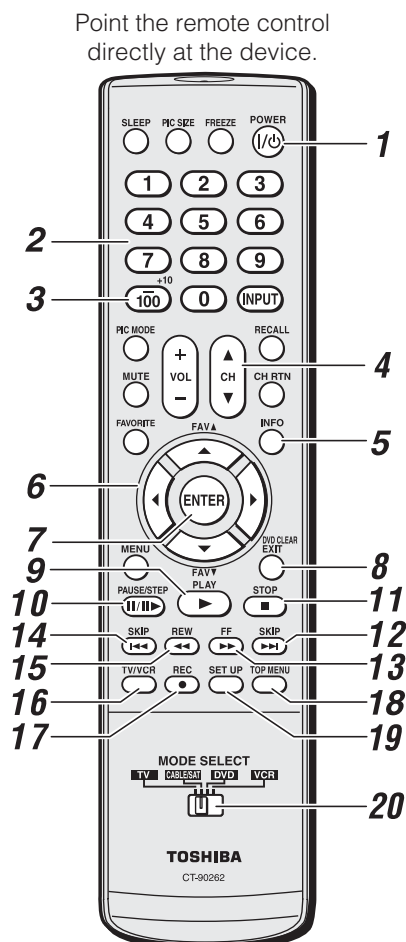

- 1 POWER** Turns the selected device on and off.
- 2 Channel Numbers (0-9)** Press to directly access channels (as opposed to  $\uparrow$  CH  $\downarrow$  CH).
- 3 +10** Press to directly access DVD chapters higher than 10.
- 4 CH  $\uparrow$   $\downarrow$**   
 $\uparrow$  selects the next higher channel;  
 $\downarrow$  selects the next lower channel (for channels programmed into memory only).
- 5 INFO** Displays TV status information on-screen.
- 6  $\uparrow$   $\downarrow$   $\leftarrow$   $\rightarrow$**  Press to navigate DVD menus (may not work on some DVD players).
- 7 ENTER** Required by some satellite receivers and DVD players.
- 8 DVD CLEAR** Press to reset the title and chapter number.
- 9 PLAY** Begins playback of a tape or DVD.
- 10 PAUSE** Press during play or record mode to pause the picture; press again to restart.
- 11 STOP** Stops the tape or DVD.
- 12 SKIP  $\rightarrow$**  Skips forward to locate later DVD chapters.
- 13 FF** Fast-forwards the tape or DVD. (Press during play mode to view the picture moving rapidly forward.)
- 14 SKIP  $\leftarrow$**  Skips back to beginning of current DVD chapter or locates previous chapters.
- 15 REW** Rewinds/reverses the tape or DVD. (Press during play mode to view the picture moving rapidly backward.)
- 16 TV/VCR** To view one program while recording another, press to select TV mode.
- 17 REC** Starts tape recording.
- 18 TOP MENU** Accesses a DVD's top menu.
- 19 SET UP** Accesses a DVD's setup menu.
- 20 MODE SELECT Switch** Set to "TV" to control the TV; "CABLE/SAT" to control a cable converter box or satellite receiver; "DVD" to control a DVD player or HTIB; "VCR" to control a VCR.

## Remote Control functional key chart

**Note:**

- “---” = key does not send a signal in that remote control mode.
- ← TV = key will affect the TV, even when the remote control is not in the “TV” device mode.

REMOTE CONTROL KEY	DEVICE MODE				
	TV	CABLE	SAT	VCR	DVD
POWER	Power	Power	Power	Power	Power
SLEEP	Sleep timer	← TV	← TV	← TV	← TV
INPUT	TV/Video select	← TV	← TV	← TV	← TV
1-9	Digit 1-9	Digit 1-9	Digit 1-9	Digit 1-9	Digit 1-9
0	Digit 0	Digit 0	Digit 0	Digit 0	Digit 0
100/-/+10	-/100	---	– (sub CH)	100	+10
RECALL	RECALL	← TV	← TV	Display	← TV
CH RTN	Previous channel	---	---	---	---
INFO	---	---	Info	---	---
MENU	Menu/DVD Menu	---	Menu	---	DVD Menu
▲▼/FAV▲▼	Menu select/ FAV up/down	---	Menu up/down	---	Menu up/down
◀	Menu select	---	Menu left	---	Menu left
▶	Menu select	---	Menu right	---	Menu right
ENTER	Enter	---	Select Enter	---	Enter
EXIT/DVD CLEAR	Exit	---	Exit	---	DVD Clear
VOL + -	Volume up/down	← TV	← TV	← TV	← TV
CH▲▼	Channel up/down	Channel up/down	Channel up/down	Channel up/down	---
PIC SIZE	Picture size	← TV	← TV	← TV	← TV
MUTE	Sound mute	← TV	← TV	← TV	← TV
FF	---	---	---	Fast FWD	Fast FWD
PAUSE/STEP	---	---	---	Pause	Pause
PLAY	---	---	---	Play	Play
REW	---	---	---	Rewind	Rewind (reverse)
PIC MODE	PIC MODE	← TV	← TV	← TV	← TV
STOP	---	---	---	Stop	Stop
FREEZE	Freeze picture	← TV	← TV	← TV	← TV
SKIP ◀◀	---	---	---	---	Skip REV
SKIP ▶▶	---	---	---	---	Skip FWD
TV/VCR	---	---	---	TV/VCR	---
REC	---	---	---	Record (2 click)	---
SET UP	---	---	---	---	DVD Setup
TOP MENU	---	---	---	---	Top Menu

## Programming the remote control to operate your other devices

Your Toshiba TV remote control is preprogrammed to operate most Toshiba devices. To program your TV remote control to operate a non-Toshiba device (or a Toshiba device that it is not preprogrammed to operate), follow the steps below. For details on using the remote control to operate the device, see page 19.

- 1 In the remote control code table (see page 22), find the code for your device. If more than one code is listed, try each one separately until you find one that works.
- 2 Set the MODE SELECT Switch to the type of device you are programming the remote control to operate — CABLE/SAT (for a cable converter box or satellite receiver), DVD (for a DVD player or HTIB [home theater in a box]), or VCR (for a VCR or TV/VCR combo).
- 3 While holding down **RECALL**, press the Channel Number buttons to enter the 3-digit code for your device.
- 4 To test the code, turn on the device, point the remote control at it, and press **POWER**. (Also see notes below.)
  - If the correct code was entered, the device will turn off.
  - If the device does not respond, repeat steps 1–4 using another code.
  - If the device does not respond to another code, you will need to use the device’s original remote control.
- 5 Remember to set the MODE SELECT Switch back to “TV” to control the TV.
- 6 For future reference, write down the code(s) you used:

DEVICE	CODE	DEVICE	CODE

**Note:**

- In addition to **POWER**, confirm that all necessary keys on the TV remote control operate your device. If some keys are not operational, repeat the device code setup using another code (if other codes are listed for your device). If, after trying all listed codes, the necessary keys do not operate your device, use the device’s original remote control.
- Every time you change the batteries, you will need to reprogram the remote control.
- Some newer VCRs respond to either of two codes. These VCRs have a switch labeled “VCR1/VCR2.” If your VCR has this kind of switch and does not respond to the codes for your VCR brand, set the switch to the other position (“VCR1” or “VCR2”) and reprogram the remote control.

## Remote control codes

In some cases you may not be able to operate your device with the TV remote control. Your other device may use a code that is not recognized by the TV remote control. If this happens, use the device's remote control.

### Cable converter box

ABC	061, 062, 063, 082, 084, 087, 091, 092, 096, 098
Archer	065, 092, 097, 099
Cableview	064, 094
Century	092
Citizen	090, 092, 097
Contec	083, 085, 086, 088, 093, 098
Diamond	093
Eagle	091
GE	061, 062
Gemini	069, 070, 094
Hamlin	093
Hitachi	062, 095, 096
Jasco	097
Magnavox	072, 096
Memorex	091, 092, 104
Motorola/GI/Jerrold	062, 069, 071, 082, 086, 089, 091, 096
Multi Canal	090
Novavision	101
Panasonic	081, 083, 085
Philco	087
Philips	066, 067, 068, 070, 072, 073, 074, 075, 091, 092
Pioneer	076, 077
Proscan	061, 062
Radio Shack	092, 097, 099
RCA	064, 081
Realistic	065
Recoton	102
Samsung	077, 090
Scientific Atlanta	063, 078, 079, 080, 088, 098, 101, 105
Sears	095
Signature	062
Signature 2000	096
Sprucer	081, 085
Starcom	069, 082, 087, 096, 103, 104
Stargate	069, 090
Sylvania	095, 100
TeleView	090
Texscan	100
Tocom	071, 084, 085
U. S. Electronics	087, 096, 098
United Cable	082
Universal	065, 092, 097, 099, 102, 103
Wards	096

### Satellite receiver

Alphastar	038, 059
Chaparral	034
DISH Network	057

Drake	020, 040, 044, 046, 050, 053
Echostar	018, 041, 051
Express Vu	057
Fujitsu	027
GE	008, 009, 013
General Instruments	010, 011, 012, 022, 023, 031, 049
Hitachi	033
Hughes	033
Hughes Network Systems	019
Intersat	048
Janeil	027
JVC	017, 057
Kenwood	029
Magnavox	060
Optimus	058
Pansat	036, 052
Primestar	015, 042
Proscan	008, 009, 013
Radio Shack	022, 023, 030
RCA	008, 009, 013, 016
Realistic	030
Samsung	059
Sony	014, 055
Star Choice	057
Star Trak	025, 026, 037, 054
STS	024
Toshiba	000, 001, 002, 003, 004, 005, 006, 007, 020, 031, 056
Uniden	021, 028, 030, 032, 035, 039, 043, 045, 047, 058
Zenith	027

### TV/VCR Combo

Action	078
GE	059, 062
Goldstar	065
Panasonic	065
Precision	078
Quasar	065
Realistic	079
Sony	074
Toshiba	057
Totevision	009, 010, 065
Zenith	065

### DVD/VCR Combo

Go Video	DVD=087, VCR=081
JVC	DVD=088, VCR=082
RCA	DVD=089, VCR=083
Samsung	DVD=090, VCR=084
Sanyo	DVD=091, VCR=085
Zenith	DVD=092, VCR=086

### DVD player

Aiwa	006, 015
Apex	016, 017
BOSE	097
Broksonic	018
Clarion	019

Classic	020
Daewoo	021
Denon	022, 023, 024, 025
Emerson	026, 027
Fisher	028
Funai	027
GE	001, 029, 030
Go Video	087
GPX	031
Hitachi	005, 032, 033, 034, 035
JVC	003, 007, 036, 042, 088
Kenwood	037
Konka	008, 009
Magnavox	004, 038
Memorex	039
Mintek	040
NAD	026
Nakamichi	041
Norcent	043
Onkyo	044
Oritron	058
Panasonic	010, 045, 046, 047, 048, 049, 050
Philips	004, 051
Pioneer	052, 053, 054, 055
Proscan	001, 056
Qwestar	057, 058
RCA	001, 002, 059, 089
Sampo	060
Samsung	061, 062, 086, 090
Sansui	073
Sanyo	063, 091
Sharp	064, 067
Sherwood	074
Sony	011, 012, 065, 066, 068, 069, 070
Sylvania	027
Teac	071
Technics	072
Techwood	075
Toshiba	000, 013, 076, 077, 078
Yamaha	079, 080, 081
Zenith	014, 082, 092

### Portable DVD player

Aiwa	093
Audiovox	094, 095
Panasonic	024, 096, 099
RCA	098

### VCR

Admiral	049
Aiko	019
Aiwa	018
Akai	003, 004, 037, 038, 039, 058, 069
Audiovox	010
Bell & Howell	007, 068
Broksonic	008, 017
Calix	010
Carver	026
CCE	019
Citizen	009, 010, 011, 012, 013, 014, 015, 019, 057, 073
Colortyme	005
Craig	009, 010, 016, 061, 065, 079

### Chapter 3: Using the remote control





Curtis Mathes	001, 005, 009, 012, 014, 040, 048, 053, 056, 057	Panasonic	036, 045, 046, 057, 061, 072, 079	Wards	009, 010, 011, 016, 018, 020, 024, 025, 031, 035, 049, 051, 056, 057, 060, 065, 066, 079
Daewoo	011, 013, 015, 017, 018, 019, 057, 078	Pentax	012, 024, 025, 035, 042, 053, 063	White Westinghouse	073
Daytron	078	Pentex Research	014	XR-1000	018
Denon	063	Philco	026, 027, 063	Yamaha	005, 006, 007, 014, 037, 053
Dimensia	001, 048	Philips	026, 031, 044, 057	Zenith	004, 032, 034, 041, 047, 069, 086
Electrohome	010, 020, 065	Pioneer	006, 024, 043, 055	<b>HTIB</b>	
Emerson	003, 008, 010, 011, 017, 018, 020, 028, 039, 054, 057, 062, 065, 068, 072	Portland	012, 013, 015	Lasonic	083
Fisher	007, 016, 021, 022, 023, 057, 064, 068, 070, 071, 079	Proscan	001, 002, 048	Panasonic	084
Fuji	004, 041	Proton	061	Venturer	085
Funai	018, 073	Quasar	045		
Garrard	018	Radio Shack	010, 031, 065		
GE	001, 002, 009, 040, 042, 048, 056	Radio Shack/Realistic	007, 009, 010, 016, 018, 020, 021, 022, 031, 049		
Go Video	056, 059, 061, 081	Radix	010		
Goldstar	005, 010, 014, 054, 056, 065, 067	RCA	001, 002, 003, 009, 024, 025, 029, 035, 040, 042, 045, 048, 055, 056, 063, 071, 083		
Gradiente	018, 065	Realistic	007, 009, 010, 011, 016, 018, 020, 021, 022, 031, 049, 051, 056, 060, 065, 075, 079		
Harman Kardon	005	Ricoh	047		
Hitachi	024, 025, 035, 037, 042, 063, 070, 080	Runco	034		
JBL	076	Samsung	009, 011, 038, 056, 073, 084		
JC Penney	005, 006, 007, 008, 009, 010, 023, 024, 025, 026, 035, 056, 061, 063, 065	Sansui	006, 037, 043, 061		
Jensen	024, 025, 037	Sanyo	007, 009, 016, 054, 064, 068, 071, 075, 079, 085		
JVC	005, 006, 007, 014, 037, 043, 062, 063, 068, 082	Scott	008, 011, 017, 028, 030, 057, 065, 072		
Kenwood	005, 006, 007, 012, 014, 037, 043, 053, 068, 071	Sears	007, 010, 016, 021, 022, 023, 024, 025, 035, 053, 057, 063, 064, 065, 068, 071, 075, 079		
Kodak	010	Sharp	013, 020, 031, 049, 051, 060, 066		
LG	010	Shintom	004, 025, 032, 061		
Lloyds	053, 073, 079	Signature	049		
Logik	061	Signature 2000	075		
LXI	010	Singer	047, 061		
Magnasonic	061, 065, 078	Sony	004, 032, 033, 041, 052, 058, 070, 074, 076, 077, 080		
Magnavox	026, 027, 034, 044, 057, 061, 072	STS	035		
Marantz	005, 006, 007, 012, 014, 026, 053, 067	Sylvania	018, 026, 027, 028, 044, 072		
Memorex	007, 009, 010, 016, 018, 034, 049, 063, 065, 066, 068, 075, 079	Symphonic	018, 051, 053, 073, 079		
MGA	020, 028, 039	Tandy	007		
MGN	056	Tashiko	010		
Minolta	024, 025, 035, 063	Tatung	037		
Mitsubishi	020, 024, 025, 028, 039, 043, 065	Teac	018, 029, 037		
Montgomery Ward	049	Technics	036		
Motorola	049	Teknika	010, 018, 065		
MTC	009, 046, 061	Toshiba	000, 011, 021, 023, 024, 028, 030, 039, 057, 074, 078, 079		
Multitech	009, 012, 018	Totevision	009, 010, 065		
NEC	005, 006, 007, 012, 014, 037, 043, 053, 054, 067, 070	Unitec	073		
Nikko	010	Unitech	009		
Noblex	009	Vector Research	005, 006, 011, 012, 053		
Optimus	010, 049, 065	Video Concepts	005, 006, 011, 012, 039, 053		
Optonica	031				
Orion	054, 057, 062, 065, 068, 072				

# Chapter 4: Menu layout and navigation

## Menu Layout

The illustrations below provide a quick overview of your TV's menu system.

To open the main menus (illustrated below), press  on the remote control or TV control panel.

Icon	Item	Option
<b>Picture</b> 	Mode	→ Sports/Standard/Movie/Preference
	Picture Settings	→ [Picture Settings edit window]
	Cinema Mode	→ Film/Video
<b>Audio</b> 	MTS	→ Stereo/SAP/Mono
	Bass	→ [Adjust the bass audio quality]
	Treble	→ [Adjust the treble audio quality]
	Balance	→ [Adjust the balance audio quality]
	WOW	→ SRS 3D/FOCUS/TruBass
	StableSound	→ On/Off
<b>Set Up</b> 	Language	→ English / Français / Español
	TV/CABLE	→ [Select the input source (TV/Cable)]
	Ch Program	→ [Start channel programming automatically]
	Add/Erase	→ [Add/Erase a channel]
	Channel Labeling	→ [Channel Labeling edit window]
	Video Label	→ [Video input labeling edit window]
	AV Connection	→ [PC/HDMI Audio Settings edit window]
	Picture Position	→ [Picture Position Settings edit window]
	PC Settings	→ [PC Settings edit window]
	Sleep Timer	→ [Sleep Timer edit window]
<b>Timer</b> 	On Timer	→ [On Timer edit window]
<b>Function</b> 	CC	→ Off/C1/C2/C3/C4/T1/T2/T3/T4
	CC Reception Adjustment	→ Mode 1/Mode 2
	Favorite Channel	→ [Favorite Channels edit window]
	Auto Aspect	→ On/Off
	Blue Screen	→ On/Off
	Side Panel	→ 1/2/3
	Locks	→ Channel Lock/Video Lock/New PIN Code



## Navigating the menu system

You can use the buttons on the remote control or TV control panel to access and navigate your TV's on-screen menu system.

- Press **MENU** to open the menu system.
- When a menu is open, use the up/down/left/right arrow buttons (**▲▼◀▶**) on the remote control or TV control panel to move in the corresponding direction in the menu.
- Press **ENTER** to save your menu settings or to select a highlighted item. (A highlighted menu item appears in a different color in the menu.)
- All menus close automatically if you do not make a selection within 60 seconds.
- To close a menu instantly, press **EXIT**.

## Selecting the menu language

You can choose from three different languages (English, French and Spanish) for the on-screen display of menus and messages.

### To select the menu language:

- 1 Press **MENU** and open the **Set Up** menu.
- 2 Press **▲** or **▼** to highlight **Language**.

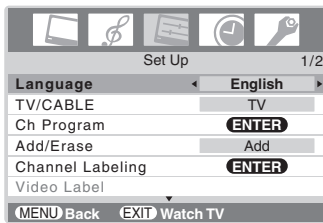

- 3 Press **◀** or **▶** to display your desired language.
- 4 Press **EXIT** to close the **Set Up** menu.

## Programming channels into the TV's channel memory

When you press **(CH)** or **(CH)** on the remote control or TV control panel, your TV will stop only on the channels you program into the TV's channel memory.

Follow the steps below to program channels into the TV's channel memory.

### Programming channels automatically

Your TV can automatically detect all active channels in your area and store them in its memory. After the channels are programmed automatically, you can manually add or erase individual channels in the channel memory.

#### Note:

- If the input signal type is set to **CABLE** for an antenna input, the automatic channel programming process erases channels that were previously programmed into the TV's memory.
- If the input signal type is set to **TV**, the automatic channel programming process does NOT erase channels that were previously programmed into the TV's memory, but adds newly found channels to the existing set of programmed channels. To remove a channel from the memory, you must manually delete it.
- To tune the TV to a channel not programmed in the channel memory, you must use the Channel Number buttons on the remote control.
- Programming channels for an antenna input configured for **CABLE** will take substantially longer than for an antenna input configured for **TV**. This is normal; however, once channel programming is completed, you should not have to repeat the programming process again unless your Cable TV service lineup changes significantly.

### To program channels automatically:

- 1 Press **MENU** and open the **Set Up** menu.
- 2 Press **▲** or **▼** to highlight **TV/CABLE**.
- 3 Press **◀** or **▶** to select either **TV** (if you use an antenna) or **CABLE** (if you use cable channels).

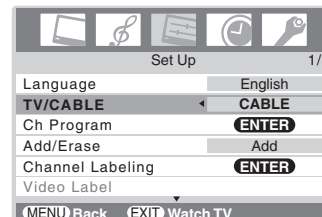

- 4 Press **▼** to select **Ch Program**.

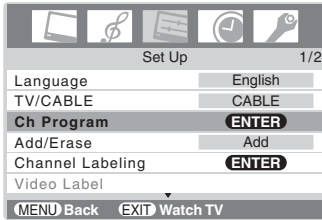

- 5 Press **ENTER** to start channel programming. The TV will automatically cycle through every channel (**TV** or **CABLE**, depending on which you selected in step 3), and store all active channels in the channel memory. While the TV is cycling through the channels, the message “Programming Now—Please Wait” appears.
- 6 When channel programming is complete, the message “Completed” appears.
- 7 Press **▲** or **▼** to view the programmed channels.

## Manually adding and deleting channels in the channel memory

After automatically programming channels into the channel memory, you can manually add or delete individual channels.

### To add or delete channels in the channel memory:

- 1 Select the channel you want to add or erase. If you are adding a channel, you must select the channel using the Channel Number buttons.
- 2 Press **MENU** and open the **Set Up** menu.
- 3 Press **▲** or **▼** to highlight **Add/Erase**.

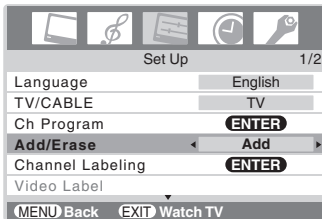

- 4 Press **◀** or **▶** to select **Add** or **Erase**, depending on the function you want to perform.
- 5 Repeat steps 1–4 for other channels you want to add or erase.

## Programming your favorite channels

You can preset up to 12 of your favorite channels using the Favorite Channel Programming feature. Because this feature scans through only your favorite channels, it allows you to skip other channels you do not normally watch.

### To add and delete channels in the Favorite Channel lists:

- 1 Press **MENU** and open the **Function** menu.
- 2 Press **▲** or **▼** to highlight **Favorite Channel**.

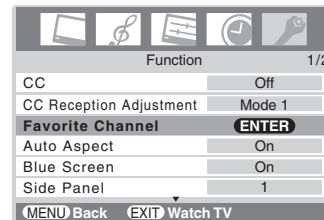

- 3 Press **ENTER** to display the **Favorite Channel** menu. **Channel Input** will be highlighted.

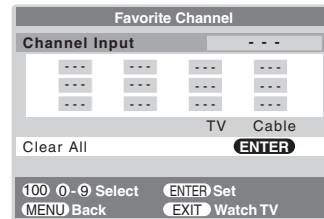

- 4 Press the Channel Number buttons to enter one of your favorite channels.
- 5 Press **ENTER**.
- 6 Repeat steps 4 and 5 for your other favorite channels.

**To clear a favorite channel:**

- 1 Press **MENU** and open the **Function** menu.
- 2 Highlight **Favorite Channel** and press **ENTER**.
- 3 Press **▲▼◀▶** to highlight the channel you want to clear, then press **ENTER**.

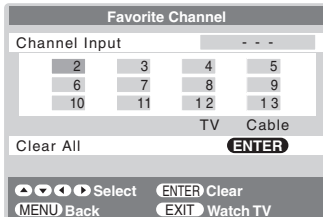

- 4 Repeat step 3 for other favorite channels you want to clear.

**To clear all favorite channels at once:**

Press **▲** or **▼** to highlight **Clear All** in step 3 above, and then press **ENTER** to clear all favorite channels at once.

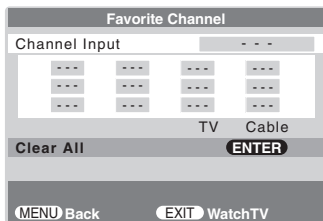

**To tune your favorite channels for the current ANT input:**

Press **FAV▲ / FAV▼**.

**Labeling channels**

Channel labels appear briefly on-screen above the channel number display each time you turn on the TV, change a channel, or press **RECALL**. You can choose any seven characters to identify a channel.

**To create channel labels:**

- 1 Press **MENU** and open the **Set Up** menu.
- 2 Highlight **Channel Labeling** and press **ENTER**.

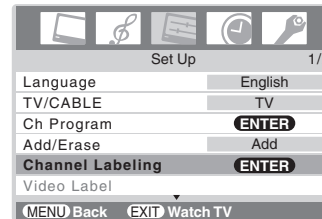

- 3 Press **▲** or **▼** or the Channel Numbers to select a channel you want to label.

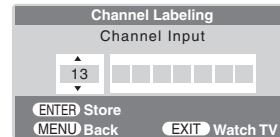

- 4 Press **▶** to select a character for the first space, and then repeatedly press **▲** or **▼** to select a character.



- 5 Repeat step 4 to enter the rest of the characters. If you would like a blank space in the label name, you must choose an empty space from the list of characters; otherwise, a dash (-) will appear in that space.
- 6 Repeat steps 3-5 to label other channels.
- 7 Press **ENTER** to store your settings.

**To erase channel labels:**

Select blanks in steps 4 and 5 above.

## Setting the HDMI™ audio mode

To set the HDMI audio mode:

- 1 Press **MENU** and open the **Set Up** menu.
- 2 Highlight **AV Connection** and press **ENTER**.
- 3 Press **▲** or **▼** to select **HDMI Audio**, and then press **◀** or **▶** to select the HDMI audio mode (**Auto**, **Digital**, or **Analog**). (**Auto** is the recommended mode). See “Connecting an HDMI or DVI device to the HDMI input” (page 15).

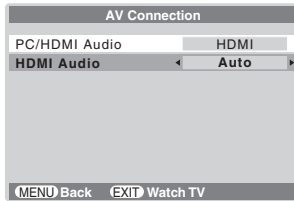

**Note:** The **PC/HDMI Audio** setting influences the **HDMI Audio** setting. If **PC/HDMI Audio** is set to **HDMI**, the **HDMI Audio** setting changes to **Auto**. If **PC/HDMI Audio** is set to **PC**, the **HDMI Audio** setting is set to **Digital** and will be grayed out.

### Selecting the video input source to view

Press **INPUT** on the remote control or **INPUT** on the TV control panel to view a signal from another device connected to your TV, such as a VCR or DVD player. You can select Video 1/ ColorStream HD1, Video 2, ColorStream HD2, HDMI, PC or Antenna/Cable channel, depending on which input jacks you used to connect your devices (see Chapter 2).

#### To select the video input source using the program list:

- 1 Press and hold **INPUT** or **INPUT** for a few seconds to display the program list.

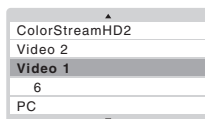

- 2 To scroll through the program list, repeatedly press **INPUT** or hold **INPUT** or **▲** or **▼** while the program list is on-screen.
- 3 When the desired video input mode is highlighted, press **ENTER**.

**Note:** When **HDMI**, **ColorStream HD1** or **ColorStream HD2** is selected, the **VIDEO OUT** jack does not output a signal. To receive a **VIDEO OUT** signal, you must use a standard video or S-video IN connection.

### Labeling the video input sources

The video label feature allows you to label each input source for your TV from the following preset list of labels:

- --- : Uses the default label name
- VCR : Video cassette recorder
- DVD : DVD video
- DTV : Digital TV set-top box
- SAT : Satellite box
- CBL : Cable box

#### To label the video input sources:

- 1 Press **INPUT** to select the video source you want to label.
- 2 Press **MENU** and open the **Set Up** menu.
- 3 Press **▲** or **▼** to highlight **Video Label**.

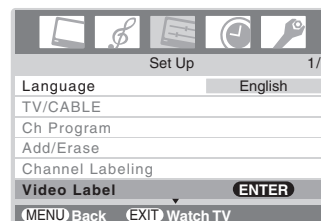

- 4 Press **ENTER** to display the **Video Label** menu.



- 5 Press **▶** to highlight the first space.
- 6 Press **▲** or **▼** to select the desired character for that space.
- 7 Repeat steps 5 and 6 to enter the rest of the characters.
- 8 Finish labeling the other video input sources as desired.
- 9 Press **ENTER** to store your settings.
- 10 To return to the previous menu, press **MENU**.
- 11 To exit the menu, press **EXIT**.



## Tuning channels

### Tuning your favorite channels

To tune to the channels you programmed as Favorite Channels, see page 27.

### Tuning to the next programmed channel

#### To tune to the next programmed channel:





Press  or  on the remote control or TV control panel.

**Note:** This feature will not work unless you program channels into the TV's channel memory (see page 26).

### Tuning to a specific channel (programmed or unprogrammed)

Press the Channel Number buttons (0–9, 100) on the remote control. For example, to select channel 125, press 100, 2, 5.

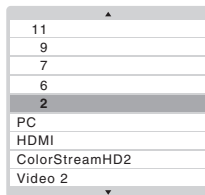

### Tuning to a specific programmed channel (or video mode) using the Program list

Press  to display the Program list, and then press  or  to scroll through the Program list. When the desired channel number (or video mode) is highlighted, press .



### Switching between two channels using Channel Return

The Channel Return feature allows you to switch between two channels without entering an actual channel number each time.

- 1 Select the first channel you want to view.
- 2 Select a second channel using the Channel Number buttons (0–9, 100).
- 3 Press  on the remote control. The previous channel will display. Each time you press , the TV will switch back and forth between the last two channels that were tuned.

**Note:** If you press  from a non-antenna input, the TV will return to the last-viewed ANT input and channel.

## Selecting the picture size

You can view 480i, 480p, 720p, and 1080i format programs in a variety of picture sizes—Natural, TheaterWide 1, TheaterWide 2, TheaterWide 3, Full, and 4:3 HD.

**Note:** The “picture size” illustrations are examples only. The format of the image (in any of the picture sizes) will vary depending on the format of the signal you are currently watching.

Select the picture size that displays the current program the way that looks best to you.

Picture size	Natural	Theater Wide 1	Theater Wide 2	Theater Wide 3	Full	4:3 HD
480i	yes	yes	yes	yes	yes	no
480p	yes	yes	yes	yes	yes	no
720p	(Full)	yes	yes	yes	no	yes
1080i	(Full)	yes	yes	yes	no	yes

#### To select the picture size:

Repeatedly press  on the remote control to select the desired picture size, as described below and on the next page.

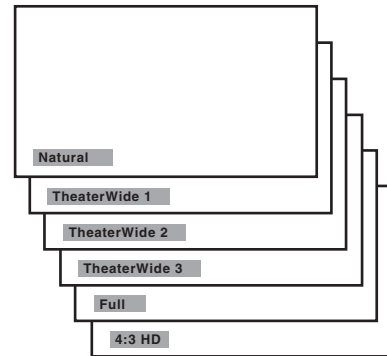

Using these functions to change the picture size (i.e., changing the height/ width ratio) for any purpose other than your private viewing may be prohibited under the Copyright Law and may subject you to civil and criminal liability.

### Natural picture size (for 480i and 480p program sources only)

- The image is displayed close to its originally formatted proportion. Some program formats will display with sidebars and/or bars at the top and bottom.

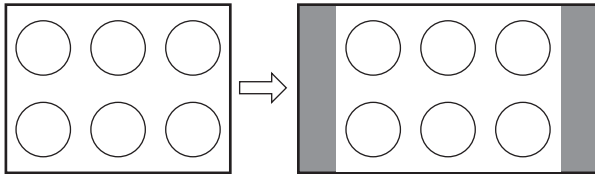

Conventional picture on a conventional TV screen

Natural picture size example

### TheaterWide 1 picture size (for 4:3 format programs)

- The center of the picture remains close to its original proportion, but the left and right edges are stretched wider to fill the screen.
- A small part of the picture at the top and bottom is hidden.

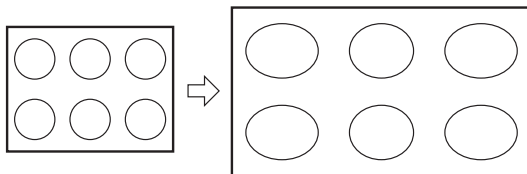

TheaterWide 1 picture size example

### TheaterWide 2 picture size (for letter box programs)

- The picture is stretched wider to fill the width of the screen, but only slightly stretched taller.
- The top and bottom edges of the picture are hidden.

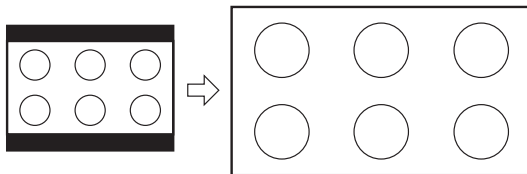

TheaterWide 2 picture size example

### TheaterWide 3 picture size (for letter box programs with subtitles)

- The picture is stretched wider to fill the width of the screen, but only slightly stretched taller.
- The top and bottom edges are hidden.

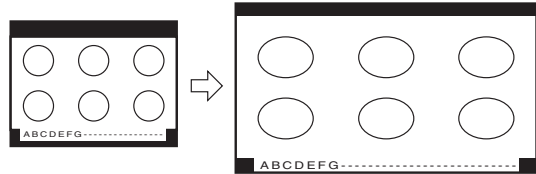

TheaterWide 3 picture size example

### Full picture size (for 16:9 source programs only)

- If receiving a 4:3 format program, the picture is stretched wider to fill the width of the screen, but not stretched taller.
- None of the picture is hidden.

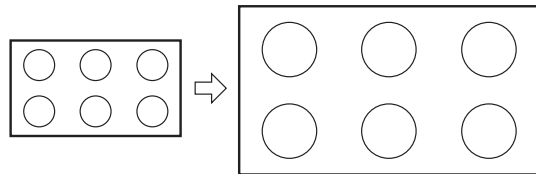

Full picture size example

### 4:3 HD picture size (for 720p and 1080i program sources only)

- The picture is squeezed to its original proportion.

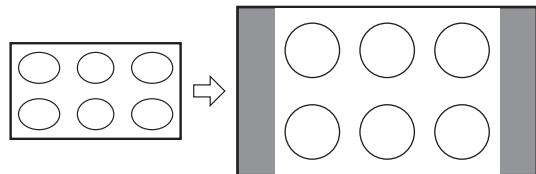

4:3 HD picture size example

#### Note:

- If you select one of the TheaterWide® picture sizes, the top and bottom edges of the picture (including subtitles or captions) may be hidden. To view the hidden edges, try viewing the program in **Full** or **Natural** picture size.
- The "picture size" illustrations are examples only. The format of the image (in any of the picture sizes) will vary depending on the format of the signal you are currently watching.



## Adjusting the Picture Position

- 1 Press **MENU** and open the **Set Up** menu.
- 2 Press **▲** or **▼** to highlight **Picture Position**, and then press **ENTER**.

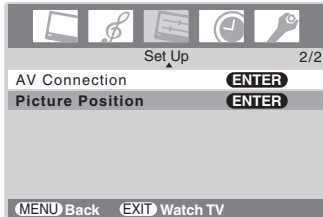

- 3 Press **▲** or **▼** to highlight the item you want to adjust.

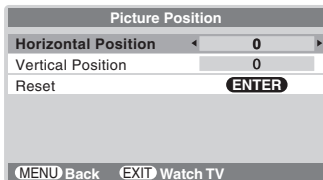

- 4 Press **◀** or **▶** to adjust the settings as required.



The display will return to the previous menu after 4 seconds if no button is pressed.

Selection	Pressing <b>◀</b>	Pressing <b>▶</b>
Horizontal Position	Moves picture left	Moves picture right
Vertical Position	Moves picture down	Moves picture up

### To reset to the factory-set status:

Follow steps 1-3 above, select **Reset** in step 3, and then press **ENTER**.

**Note:** You can adjust the **Horizontal Position** and **Vertical Position** in TheaterWide 2 and TheaterWide 3 modes only.

## Using the auto aspect ratio feature

When the auto aspect ratio feature is set to **On**, the picture size is automatically selected when one of the following input sources is received:

- A 480i signal from the **VIDEO-1**, **VIDEO-2**, **ColorStream HD-1**, or **ColorStream HD-2** input.
- A 1080i, 480i, 480p, or 720p signal from the **HDMI** input.

Aspect ratio of signal source	Automatic aspect size (automatically selected when Auto Aspect is On)
4:3 normal	Natural (with sidebars)
4:3 letter box	TheaterWide 2
16:9 full	Full
Not defined (no ID-1 data or HDMI aspect data)	Selecting the picture size (see page 31)

**Note:** The auto aspect ratio feature is not applicable to antenna or cable input sources.

### To turn on the auto aspect ratio feature:

- 1 Press **MENU** and open the **Function** menu.
- 2 Press **▲** or **▼** to highlight **Auto Aspect**.

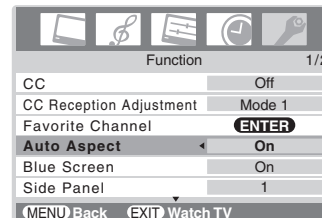

- 3 Press **◀** or **▶** to select **On**.

### To turn off the auto aspect ratio feature:

Select **Off** in step 3 above.

## Using the blue screen function

When a TV is on but not receiving a signal, the screen typically displays a “snowy” image and the speakers transmit a “static” sound.

With the blue screen function set to **On**, the TV will automatically mute the sound and replace the snowy image with a solid blue screen until the TV receives a signal. Once a signal is received, the normal image and sound are restored.

### To turn on the blue screen function:

- 1 Press **MENU** and open the **Function** menu.
- 2 Press **▲** or **▼** to highlight **Blue Screen**.
- 3 Press **◀** or **▶** to select **On**.

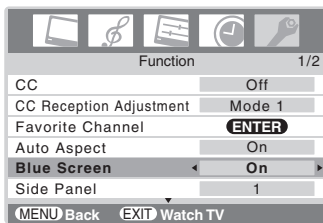

### To turn off the blue screen function:

Select **Off** in step 3 above.

## Selecting the gray level for 4:3 mode side panels

You can select the gray level of the side panels that display in 4:3 mode.

### To select the gray level:

- 1 Press **MENU** and open the **Function** menu.
- 2 Press **▲** or **▼** to highlight **Side Panel**.

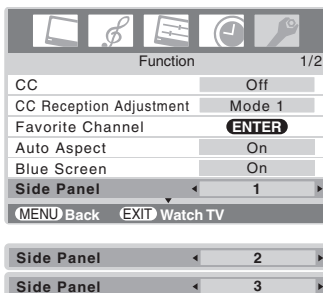

- 3 Press **◀** or **▶** to select the desired gray level (**1**, **2** or **3**), as follows:
  - 1: Black
  - 2: Dark gray
  - 3: Light gray



## Selecting the cinema mode (480i signals only)

When you view a DVD (480i signal; 3:2 pulldown processed) from a DVD player connected to the **VIDEO-1**, **VIDEO-2**, **ColorStream HD-1/HD-2** (component video), or **HDMI** inputs on the TV, smoother motion can be obtained by setting the **Cinema Mode** to **Film**.

### To set the Cinema Mode to Film:

- 1 Press **MENU** and open the **Picture** menu.
- 2 Press **▲** or **▼** to highlight **Cinema Mode**.
- 3 Press **◀** or **▶** to select **Film**.

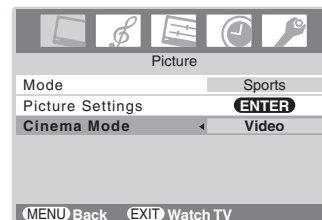

### To set the Cinema Mode to Video:

Select **Video** in step 3 above.

## Adjusting the picture

### Selecting the picture mode

You can select your desired picture settings from four different modes, as described below.

Mode	Picture Quality
Sports	Bright and dynamic picture (factory setting)
Standard	Standard picture settings (factory setting)
Movie	Lower contrast for darkened room (factory setting)
Preference	Your personal preferences

#### To select the picture mode:

Press **PIC MODE** on the remote control.

The following popup menu appears on-screen.



Repeatedly press **PIC MODE** to cycle among the modes or use **◀** or **▶** to select the modes.

#### To select the picture mode using the menu system:

- 1 Press **MENU** and open the **Picture** menu.
- 2 Press **▲** or **▼** to highlight **Mode**.

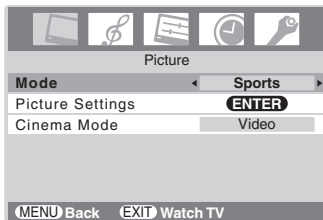

- 3 Press **◀** or **▶** to select the mode you prefer.

#### Note:

- The picture mode you select affects the current input only. You can select a different picture mode for each input.
- If you select one of the factory-set picture modes (**Sports**, **Standard**, or **Movie**) and then change a picture quality setting (for example, increase the contrast or change the color temperature), the picture mode automatically changes to **Preference** in the **Picture** menu.

## Adjusting the picture quality

You can adjust the picture quality (back light, contrast, brightness, color, tint, and sharpness) to your personal preferences.

Selection	Pressing <b>◀</b>	Pressing <b>▶</b>
Back Light	darker	lighter
Contrast	lower	higher
Brightness	darker	lighter
Color	paler	deeper
Tint	reddish	greenish
Sharpness	softer	sharper

#### To adjust the picture quality:

- 1 Press **MENU** and open the **Picture** menu.
- 2 Highlight **Picture Settings** and press **ENTER**.
- 3 Press **▲** or **▼** to select the picture quality you want to adjust (**Back Light**, **Contrast**, **Brightness**, **Color**, **Tint**, or **Sharpness**), and then press **◀** or **▶** to adjust the setting, as described in the table above.

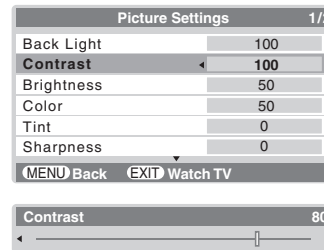

The picture qualities you adjusted are automatically saved in the **Preference** mode (see "Selecting the picture mode," above left).

#### Note:

- The cold cathode fluorescent lamp used for the back light on this TV has a limited life. When areas on the screen darken, flicker, or no longer light up, the lamp may be at the end of its life.
- When the TV is in **VIDEO** mode or when no signal is received, the back light feature is automatically set to "0" (zero).

## Using the black stretch feature

You can use the black stretch feature to correct the contrast balance in the black areas of the picture. The effect depends on the quality of the video signal.

### To turn on the black stretch feature:

- 1 Press **MENU** and open the **Picture** menu.
- 2 Highlight **Picture Settings** and press **ENTER**.
- 3 Press **▲** or **▼** to highlight **Black Stretch**.

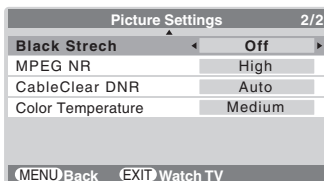

- 4 Press **◀** or **▶** to select **On**.



### To turn off the black stretch feature:

Select **Off** in step 4 above.

## Using MPEG noise reduction

The MPEG noise reduction feature allows you to reduce visible interference caused by MPEG compression. Choices for MPEG noise reduction are **Off**, **Low**, **Middle**, and **High**. **Off** is automatically selected when this feature is disabled (“grayed out”).

### To select the MPEG noise reduction level:

- 1 Press **MENU** and open the **Picture** menu.
- 2 Highlight **Picture Settings** and press **ENTER**.
- 3 Press **▲** or **▼** to highlight **MPEG NR**.

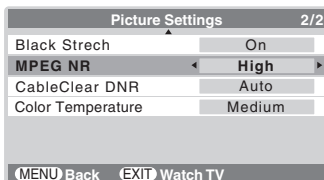

- 4 Press **◀** or **▶** to select **Low**, **Middle**, **High**, or **Off**.



**Note:** The MPEG NR feature is enabled for 480i signals only.

## Using CableClear®/DNR (digital noise reduction)

The CableClear® digital noise reduction feature allows you to reduce visible interference in your TV picture. This may be useful when receiving a broadcast with a weak signal (especially a Cable channel) or playing a noisy video cassette or disc.

### To turn on the CableClear/DNR settings:

- 1 Press **MENU** and open the **Picture** menu.
- 2 Highlight **Picture Settings** and press **ENTER**.
- 3 Press **▲** or **▼** to highlight **CableClear DNR**.

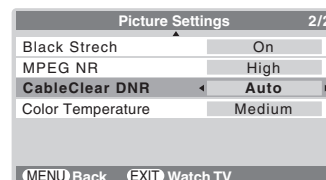

- 4 Press **◀** or **▶** to select **Low**, **Middle**, **High**, or **Auto**.

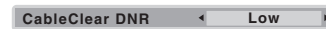

### To turn off CableClear DNR:

Select **Off** in step 4 above.

#### **Note:**

- The CableClear® DNR feature works with 480i input sources only.
- When the TV is in ColorStream or HDMI mode, the words “CableClear DNR” will change to “DNR” in the menu.
- DNR is not selectable in ColorStream HD1/HD2, PC or HDMI mode.

## Selecting the color temperature

You can change the quality of the picture by selecting from three preset color temperatures (Cool, Medium, and Warm), as described below.

Mode	Picture Quality
Cool	blueish
Medium	neutral
Warm	reddish

### To select the color temperature:

- 1 Press **MENU** and open the **Picture** menu.
- 2 Highlight **Picture Settings** and press **ENTER**.
- 3 Press **▲** or **▼** to highlight **Color Temperature**.

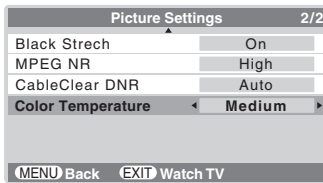

- 4 Press **◀** or **▶** to select the mode you prefer, as described in the table above.

**Note:** If you select one of the factory-set picture modes (**Sports**, **Standard**, or **Movie**) and then change the color temperature, the picture mode automatically changes to **Preference** in the **Picture** menu.

## Using the closed caption mode

The closed caption mode has two options:

- **Captions**—An on-screen display of the dialogue, narration, and sound effects of TV programs and videos that are closed captioned (usually marked “CC” in program guides).
- **Text**—An on-screen display of information not related to the current program, such as weather or stock data (when provided by individual stations).

### To view captions or text:

- 1 Press **MENU** and open the **Function** menu.
- 2 Press **▲** or **▼** to highlight **CC**.
- 3 Press **◀** or **▶** to select the desired closed caption mode.

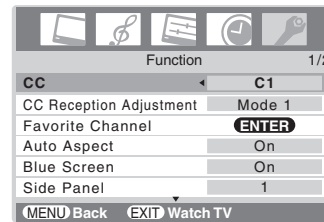

#### To view captions:

Highlight **C1**, **C2**, **C3**, or **C4**. (**C1** displays translation of the primary language in your area.)



**Note:** If the program or video you selected is not closed captioned, no captions will display on-screen.

#### To view text:

Highlight **T1**, **T2**, **T3**, or **T4**.

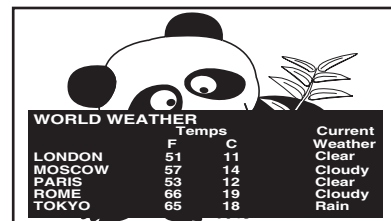

**Note:** If text is not available in your area, a black rectangle may appear on your screen. If this happens, turn the Closed Caption Mode **Off**.

- **To turn off the Closed Caption mode:** Select **Off** in step 3 above.

(continued)

**Note:** A closed caption signal may not display in the following situations:

- When a videotape has been dubbed
- When the signal reception is weak
- When the signal reception is non-standard

## Closed Caption Reception Adjustment

If reception is weak, the picture may appear blurred, and captions or text may not appear clearly on the screen. In this case, use this function to make them appear clearer.

- 1 Press **MENU** and open the **Function** menu.
- 2 Press **▲** or **▼** to highlight **CC Reception Adjustment**.
- 3 Press **◀** or **▶** to select mode **1** or **2**.

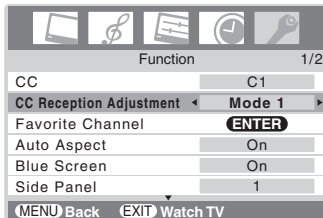

**Note:**

- This function may not be available in some cases.
- The function is available when the TV is in ANT mode only. The Closed Caption Reception Adjustment function may display the captions more clearly.

## Adjusting the audio

### Muting the sound

Press **MUTE** to partially reduce (1/2 MUTE) or turn off (MUTE) the sound. Each time you press **MUTE**, the mute mode will change in the following order:



If the closed caption mode is set to **Off** when you select "MUTE" mode, the closed caption feature is automatically activated. To mute the audio without automatically activating the closed caption feature, use **VOL** to set the volume to 0. See "Using the closed caption mode" on page 37 for more information on closed caption modes.

## Selecting stereo/SAP broadcasts

The multi-channel TV sound (MTS) feature allows you to output high-fidelity stereo sound. MTS also can transmit a second audio program (SAP) containing a second language, music, or other audio information (when provided by individual analog stations).

The MTS feature is not available when the TV is in VIDEO mode. When the TV receives a stereo or SAP broadcast, the word "STEREO" or "SAP" appears on-screen when **RECALL** is pressed.

### To listen to stereo sound:

- 1 Press **MENU** and open the **Audio** menu.
- 2 Press **▲** or **▼** to highlight **MTS**.
- 3 Press **◀** or **▶** to select **Stereo**.

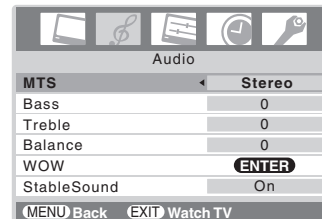

**Note:**

- You can leave the MTS feature in **Stereo** mode and it will automatically output the type of sound being broadcast (stereo or monaural).
- If the stereo sound is noisy, select **Mono** to reduce the noise.

### To listen to a second audio program on an analog station (if available):

Select **SAP** in step 3 above.

**Note:**

- A second audio program (SAP) can be heard only on those TV stations that offer it. For example, a station might broadcast another language as a second audio program. If you have SAP on, you will see the current program on the screen but hear the other language instead of the program's normal audio.
- If you have SAP on and the station you are watching is not broadcasting a second audio program, the station's normal audio will be output. However, occasionally there is no sound at all in **SAP** mode. If this happens, set the **MTS** feature to **Stereo** mode.

## Adjusting the audio quality

You can adjust the audio quality by adjusting the bass, treble, and balance.

### To adjust the audio quality:

- 1 Press **MENU** and open the **Audio** menu.
- 2 Press **▼** or **▲** to highlight the item you want to adjust (**Bass**, **Treble**, or **Balance**).

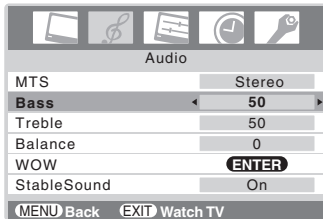

- 3 Press **◀** or **▶** to adjust the level.
  - **◀** makes the bass or treble weaker or increases the balance in the left channel.
  - **▶** makes the bass or treble stronger or increases the balance in the right channel.

## Using the SRS WOW™ surround sound feature

WOW™ is a special combination of SRS Labs audio technologies (SRS 3D, FOCUS, and TruBass) that creates a thrilling surround sound experience with deep, rich bass from stereo sound sources. Your TV's audio will sound fuller, richer, and wider.

### To adjust the WOW™ settings:

- 1 Put the TV in **Stereo** mode (see “Selecting stereo/SAP broadcasts” on page 38).
- 2 Press **MENU** and open the **Audio** menu.
- 3 Highlight **WOW** and press **ENTER**.
- 4 Press **▼** or **▲** to highlight the WOW feature you want to adjust, and then press **◀** or **▶** to adjust the item.



- **SRS 3D** — To turn the surround sound effect **On** or **Off**.

**Note:** If the broadcast is monaural, the SRS 3D effect will not work.

- **FOCUS** — To turn the vocal emphasis effect **On** or **Off**.
- **TruBass** — To select the desired bass expansion level (**Off**, **Low**, or **High**).

WOW, SRS and  symbol are trademarks of SRS Labs, Inc. WOW technology is incorporated under license from SRS Labs, Inc.

## Using the StableSound® feature

The StableSound® feature limits the highest volume level to prevent extreme changes in volume when the signal source changes (for example, to prevent the sudden increase in volume that often happens when a TV program switches to a commercial).

**To turn on the StableSound® feature:**

- 1 Press **MENU** and open the **Audio** menu.
- 2 Press **▲** or **▼** to highlight **StableSound**.
- 3 Press **◀** or **▶** to select **On**.

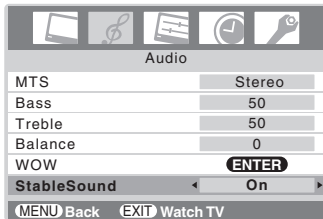

**To turn off the StableSound feature:**

Select **Off** in step 3 above.

## Using the Locks menu

The Locks menu includes the Channel Lock, Video Lock, and New PIN Code features. You can use these features after entering the correct PIN code.

### Entering the PIN code

- 1 Press **MENU** and open the **Function** menu.

- 2 Highlight **Locks** and press **ENTER**.

The **Locks** menu appears.

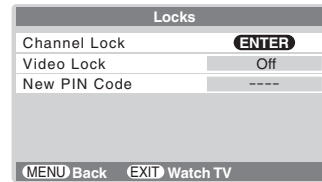

- 3 Press **▲** or **▼** to highlight **Channel Lock** or **Video Lock**, and then press **ENTER** to display the PIN code entering mode.

- **Blocking Reset status:**

Set a new 4-digit code by pressing the Number buttons (0–9).

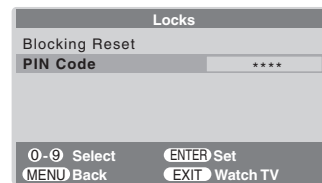

- **When the PIN code is already stored:**

Press the Number buttons (0–9) to enter your 4-digit PIN code.

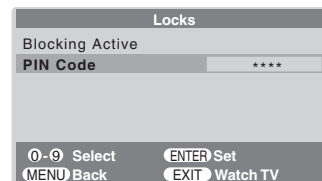

If the wrong PIN code is entered, the message “Incorrect” appears. Enter your code again, and then press **ENTER**.

### If you cannot remember your PIN code

While the PIN code entering screen is displayed, press **RECALL** four times within five seconds. The PIN code will be cleared and you can enter a new PIN code.



## Changing your PIN code

- 1 Press **MENU** and open the **Function** menu.
- 2 Highlight **Locks** and press **ENTER**.
- 3 Press **▲** or **▼** to highlight **New PIN Code**.

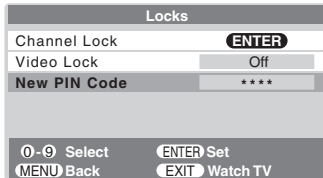

- 4 Press the Number buttons to enter a new four-digit code.
- 5 Press **ENTER**. The new PIN code is now active.

## Locking channels

You can use the Channel Lock feature, to lock specific channels. You will not be able to tune locked channels using **CH** or the Channel Number buttons unless you clear the setting.

You can lock a maximum of twelve channels.

### To lock channels:

- 1 Press **MENU** and open the **Function** menu.
- 2 Highlight **Locks** and press **ENTER**.
- 3 Highlight **Channel Lock** and press **ENTER**. The **Channel Lock** menu appears, and **Channel Input** will be highlighted.

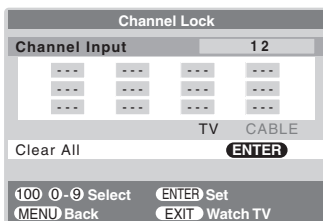

- 4 Press the Channel Number buttons to enter the channel you want to lock.
- 5 Press **ENTER**.

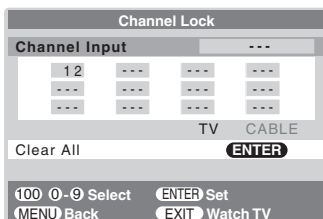

- 6 Repeat steps 4 and 5 for other channels.

**Note:** After programming Channel Lock, change the channel before turning off the TV.

### To unlock individual channels:

In step 4 above, press **▲▼◀▶** to highlight the channel you want to unlock, and then press **ENTER**.

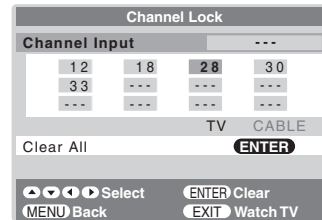

Repeat this step for other channels.

### To unlock all locked channels at once:

Press **▲** or **▼** to highlight **Clear All**, and then press **ENTER**.

## Using the Video lock feature

You can use the Video Lock feature to lock the video inputs (**Video 1, Video 2, ColorStream HD-1, ColorStream HD-2, and HDMI**) and channels 3 and 4. You will not be able to view the input sources or channels until you unlock the inputs.

### To lock/unlock the video inputs:

- 1 Press **MENU** and open the **Function** menu.
- 2 Highlight **Locks** and press **ENTER**.
- 3 Press **▲** or **▼** to highlight **Video Lock**.
- 4 Press **◀** or **▶** to select the level of video input locking you prefer, as described below.

**Video:** Locks VIDEO 1, VIDEO 2, ColorStream HD1/HD2, and HDMI.

**Video+:** Locks VIDEO 1, VIDEO 2, ColorStream HD1/HD2, HDMI, and channels 3 and 4.

- Select **Video+** if you play video tapes via an ANT input.

**Off:** Unlocks all video inputs and channels 3 and 4.

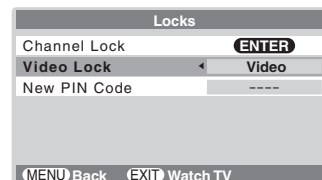

- 5 To close the menu, press **EXIT**.

## Using the PC setting feature

You can view the image from a PC on the TV screen. The PC must be connected to the TV's PC IN terminals. (☞ page 16).

You can use the PC Settings feature to adjust the picture's horizontal position/width, vertical position/height, clock phase, and sampling clock.

**Note:** If a PC is not connected, this feature will be grayed out in the **Set Up** menu.

### To adjust the PC settings:

- 1 Repeatedly press **(INPUT)** to select PC input mode (☞ "Selecting the video input source to view" on page 30).
- 2 Press **MENU** and open the **Set Up** menu.
- 3 Highlight **PC Settings** and press **(ENTER)**.

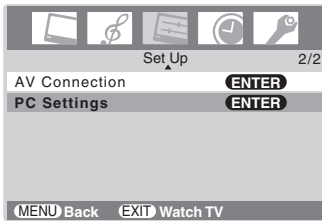

- 4 Press **▲** or **▼** to highlight the item you want to adjust.
- 5 Press **◀** or **▶** to make the appropriate adjustments.

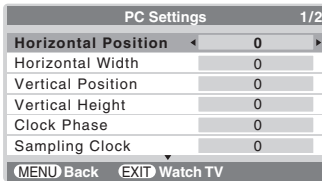

- **Horizontal Position:**  
Moves the picture left/right.  
The adjustment range is within  $\pm 5$  from center.\*
- **Horizontal Width:**  
Adjusts the width of the picture.  
The adjustment range is within  $\pm 5$  from center.\*
- **Vertical Position:**  
Moves the picture up/down.  
The adjustment range is within  $\pm 5$  from center.\*
- **Vertical Height:**  
Adjusts the height of the picture.  
The adjustment range is within  $\pm 5$  from center.\*
- **Clock Phase:**  
Helps to reduce noise and sharpen the picture.  
The adjustment range is within  $\pm 15$  from center.\*

- **Sampling Clock:**  
Helps to minimize periodic vertical stripes on the screen.  
The adjustment range is within  $\pm 15$  from center.\*
- **Reset:**  
To reset the PC setting, select **Reset** and press **(ENTER)**.

\*The range of adjustment may vary slightly.

## PC Audio

This function allows you to output the sound from your PC, if connected, or mute the sound from your PC and output the sound from your HDMI connection (☞ page 15).

### To set the PC Audio:

- 1 Press **MENU** and open the **Set Up** menu.
- 2 Highlight **AV Connection** and press **(ENTER)**.
- 3 Press **▲** or **▼** to select **PC/HDMI Audio**, and then press **◀** or **▶** to select **PC** or **HDMI**.

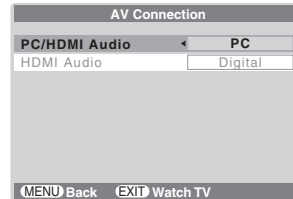

**PC:** Mutes the sound from the HDMI device, and outputs the sound from the PC

**HDMI:** Mutes the sound from your PC, and outputs the sound from the HDMI device

### Note:

- The **PC/HDMI Audio** switch setting influences the **HDMI Audio** setting. If it is set to **HDMI**, the **HDMI Audio** setting changes to **Auto**. If it is set to **PC**, the **HDMI Audio** setting is set to **Digital** and will be grayed out.
- The **PC IN** and **HDMI IN** terminals share the audio inputs labeled **PC/HDMI (AUDIO)** on the TV back panel.
- If you have both a PC and an HDMI device connected to the TV, use the PC Audio setting to specify which audio (PC or HDMI) will be output from the TV's speakers. Also see pages 15 and 16.

## Setting the sleep timer

You can set the sleep timer to turn off the TV after a set length of time (maximum of 12h50m).

### To set the sleep timer:

Press **SLEEP** on the remote control to set the length of time until the TV turns off. Repeatedly press **SLEEP** to increase the time in 10-minute increments, or press **▲** or **▼** to increase or decrease the time in 10-minute increments, up to 12h50m.

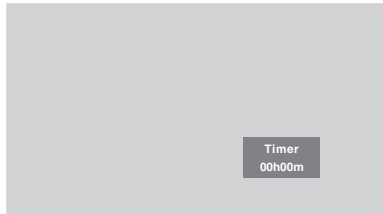

### To cancel the sleep timer:

Press **SLEEP** until it is set to 00h00m.

### To set the sleep timer using the on-screen menus:

- 1 Press **MENU** and open the **Timer** menu.
- 2 Press **▲** or **▼** to highlight **Sleep Timer**.

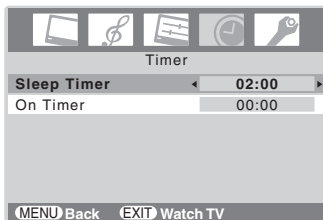

- 3 Press the Number buttons (0–9) or **◀** or **▶** to enter the length of time until the TV turns off automatically.
- 4 Press **EXIT** to start the timer.

#### Note:

- When a power failure occurs, the sleep timer setting may be cleared.
- To display the amount of time remaining on the sleep timer, press **RECALL**.

## Setting the On timer

### To set the On timer to turn on the TV automatically:

- 1 Press **MENU** and open the **Timer** menu.
- 2 Press **▲** or **▼** to highlight **On Timer**.
- 3 Press the Number buttons (0–9) or **▲** or **▼** to enter the length of time until the TV turns on automatically.  
You can set the On timer in 10-minute increments, up to 12h50m.
- 4 Press **EXIT** to start the timer.

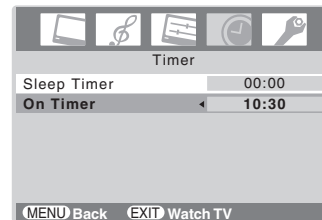

- 5 Press **POWER** to turn off the TV.  
The TV will turn on automatically after the length of time you set in the On timer.

#### Note:

- When a power failure occurs, the On timer settings may be cleared.
- To display the amount of time remaining on the On timer (while the TV is still on), press **RECALL**.

## Displaying TV setting information on-screen using RECALL

### To display TV setting information on-screen:

Press **RECALL** on the remote control.

The following information will display on-screen (if applicable):

- Channel number or VIDEO mode selected
- Remaining time of On/Sleep timer (if set)
- Channel label (if set)
- Video label (when in video mode)
- Stereo or SAP audio status
- Picture size

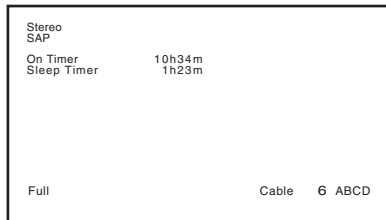

### To close the RECALL screen:

Press **RECALL** again.

## Understanding the auto power off feature

The TV will automatically turn itself off after approximately 15 minutes if it is tuned to a vacant channel or a station that completes its broadcast for the day. This feature does not work in VIDEO mode.

## Understanding the last mode memory feature

**If the power is cut off while you are viewing the TV, the Last Mode Memory feature automatically turns on the TV when the power is resupplied.**

**Note:** You should unplug the TV's power cord if it is possible that you will be away from the TV for an extended period of time after the power is restored. This will prevent the TV from turning on in your absence.

# Chapter 7: Troubleshooting

## General troubleshooting

Before calling a service technician, please check this section for a possible cause of the problem and some solutions you can try.

### Black box on screen

- The Closed Caption feature is set to one of the Text modes (**T1**, **T2**, **T3**, or **T4**). Set the Closed Caption feature to **Off** (☞ page 37).

### TV stops responding to controls

- If the TV stops responding to the controls on the remote control or TV control panel and you cannot turn off the TV, press and hold the **POWER** button on the TV control panel for 5 or more seconds to reset the TV.

### TV will not turn on

- Make sure the power cord is plugged in, and then press **POWER** (☞).
- The remote control batteries may be dead. Replace the batteries or try the control panel buttons.

### Picture problems

#### General picture problems

- Check the antenna/cable connections (☞ page 10).
- Press **(INPUT)** on the remote control or **INPUT** on the TV control panel and select a valid video input source (☞ page 30). If no device is connected, no picture will display when you select that particular input source. For device connection details, see page 10.
- Antenna reception may be poor. Use a highly directional outdoor antenna (if applicable).
- The station may have broadcast difficulties. Try another channel.
- Adjust the picture qualities (☞ page 35).
- If you are using a VCR, make sure **TV/VCR** on the remote control is set correctly (☞ page 19).
- If you have two VCRs connected to your TV, make sure you have not connected the same VCR to the TV's output and input connections at the same time.
- Do not connect both a standard video cable and an S-video cable to the **VIDEO-2** inputs at the same time (☞ page 14).

#### Noisy picture

- If you are watching a tuned analog channel (off-air broadcast or Cable TV), set the **CableClear®/DNR** feature to **Auto** to reduce visible interference in the TV picture (☞ page 36).

#### Video Input Selection problems

- If the program list does not appear when you press **(INPUT)** on the remote control or **INPUT** on the TV control panel, press the button a second time, which will change the TV to the next video input source and display the program list.

#### Cannot view external signals or channel 3 or 4

- If you cannot view signals from external devices connected to **VIDEO-1**, **VIDEO-2**, **ColorStream®**, or **HDMI**, or from channels 3 or 4, make sure the **Video Lock** is set to **Off** (☞ page 41).

#### Poor color or no color

- The station may have broadcast difficulties. Try another channel.
- Adjust the **Tint** and/or **Color** (☞ page 35).
- When the **ColorStream®** signal source is active, the **VIDEO OUT** terminal outputs blank video. To receive video from the **VIDEO OUT** signal, a standard video or **S-video IN** terminal must be used instead of the **ColorStream®** connections.

#### Poor composite or S-video picture

- If the poor picture occurs when the TV is connected to an external A/V device (e.g., DVD player, video game system, set-top box, etc.) try using a **ColorStream** or **HDMI** video connection instead.

#### Picture and sound are out of sync

- As with all products that contain a digital display, in rare instances, when viewing certain content (e.g., television broadcasts, video games, DVDs), you may notice that the sound and picture are slightly out of sync. This phenomenon can be caused by various factors including, without limitation, video processing within the TV, video processing in an attached gaming system, and video processing or different compression rates used by broadcasters in their programming. You may want to try one or more of the following suggestions, which may help to reduce the effect of this phenomenon:
  - If the TV is connected to an A/V receiver that has a programmable audio delay feature, use this feature to help synchronize the sound to the picture.
  - If you notice this phenomenon only on certain TV channels, please contact your local broadcast, cable, or satellite provider to inform them of this issue.

### Sound problems

- Check the antenna/cable connections (☞ page 10).
- The station may have broadcast difficulties. Try another channel.
- The sound may be muted. Press **VOLUME**.
- If you hear no sound, try setting the **MTS** feature to **Stereo** mode (☞ page 38).
- If you are not receiving a second audio program from a known SAP source, make sure the **MTS** feature is set to **SAP** mode (☞ page 38).
- If you hear audio that seems “incorrect” for the program you are watching (such as music or a foreign language), the SAP mode may be on. Set the **MTS** feature to **Stereo** mode (☞ page 38).

---

### Remote control problems

- Make sure the remote control is set to the correct device mode (🔍 page 19).
- Remove all obstructions between the remote control and the TV.
- The remote control batteries may be dead. Replace the batteries (🔍 page 17).
- The TV remote control may not operate certain features on your external device. Refer to the owner's manual for your other device to determine its available features. If the TV remote control does not operate a specific feature on the device, use the remote control provided with the device (🔍 pages 19–23).

---

### Channel tuning problems

- Make sure the remote control is set to the correct device mode (🔍 page 18).
- The channel may have been erased from the channel memory by the **Add/Erase** feature. Add the channel to the channel memory (🔍 page 27).
- The channel may be blocked by the **Channel Lock** feature. Unblock the channel (🔍 page 41).

---

### Closed caption problems

- If the program or video you selected is not closed-captioned, no captions will display on-screen (🔍 page 37).
- If text is not available, a black rectangle may appear on-screen. If this happens, turn off the closed caption feature (🔍 page 37).
- A closed caption signal may not display correctly in the following situations: a) when a videotape has been dubbed; b) when the signal reception is weak; or c) when the signal reception is nonstandard (🔍 page 37).

## Specifications

### Notes:

- **This model complies with the specifications listed below.**
- **Designs and specifications are subject to change without notice.**
- **This model may not be compatible with features and/or specifications that may be added in the future.**

### Television System

NTSC standard

### Channel Coverage

VHF: 2 through 13

UHF: 14 through 69

Cable TV: Mid band (A-8 through A-1, A through I)

Super band (J through W)

Hyper band (AA through ZZ, AAA, BBB)

Ultra band (65 through 94, 100 through 125)

### Power Source

120 V AC, 60 Hz

### Power Consumption

26HL86: 85 W (average)  
0.6 W in standby mode

32HL86: 107 W (average)  
0.6 W in standby mode

37HL86: 114 W (average)  
0.6 W in standby mode

### Audio Power

10 W + 10 W

### Speaker Type

Two 2-3/8 × 4-3/4 inches (6 × 12 cm)

### Video/Audio Terminals

#### S-VIDEO INPUT:

Y: 1 V(p-p), 75 ohm, negative sync.

C: 0.286 V(p-p) (burst signal), 75 ohm

#### VIDEO/AUDIO INPUT:

VIDEO: 1 V(p-p), 75 ohm, negative sync.

AUDIO: 150 mV(rms) (30% modulation equivalent,  
22 k ohm or greater)

#### ColorStream® (component video) HD INPUT:

VIDEO:Y: 1V(p-p), 75 ohm

Pr: 0.7 V(p-p), 75 ohm

Pb: 0.7 V(p-p), 75 ohm

Suggested formats: 1080i, 480p, 480i, 720p

AUDIO: 150 mV(rms), 22 k ohm or greater

#### HDMI™ INPUT:

HDMI compliant (type A connector)

HDCP compliant

E-EDID\*\* compliant

Suggested formats: 1080i, 480p, 480i, 720p

HDMI Audio: 2-channel PCM; 32/44.1/48 kHz

sampling frequency; 16/20/24 bits per sample

#### VIDEO/AUDIO OUTPUT (also for recording):

VIDEO: 1 V(p-p), 75 ohm, negative sync.

AUDIO: 150 mV(rms) (30% modulation equivalent,  
2.2 k ohm or less)

#### PC INPUT:

15-Pin D-sub Analog RGB

### Dimensions

26HL86: Width: 26 inches (660 mm)  
Height: 21-1/16 inches (535 mm)  
Depth: 10-25/32 inches (274 mm)

32HL86: Width: 31-1/4 inches (794 mm)  
Height: 24-1/16 inches (611 mm)  
Depth: 11-13/16 inches (300 mm)

37HL86: Width: 38-7/16 inches (916 mm)  
Height: 27-3/32 inches (688 mm)  
Depth: 11-13/16 inches (300 mm)

### Weight

26HL86: 32.6 lbs (14.8 kg)

32HL86: 42.6 lbs (19.3 kg)

37HL86: 56.7 lbs (25.7 kg)

### Operating conditions

Temperature: 32°F - 95°F (0°C - 35°C)

Humidity: 20 - 80% (no moisture condensation)

### Supplied Accessories

- Remote control with two size “AAA” batteries
- Owner’s Manual (this book)
- Lead Clip—Use this clip to attach the TV to a wall, pillar, or other immovable structure. See item 19 on page 3.

\*\*E-EDID = Enhanced-Extended Display Identification

## Limited Canada Warranty

### for LCD Televisions

Toshiba of Canada Limited ("TCL") makes the following limited warranties to original consumers in Canada.

LCD TVs PURCHASED IN CANADA AND USED ANYWHERE OUTSIDE OF CANADA, INCLUDING, WITHOUT LIMITATION, THE U.S.A. AND MEXICO, ARE NOT COVERED BY THESE WARRANTIES.

LCD TVs PURCHASED ANYWHERE OUTSIDE OF CANADA, INCLUDING, WITHOUT LIMITATION, THE U.S.A. AND MEXICO, AND USED IN CANADA, ARE NOT COVERED BY THESE WARRANTIES.

THESE LIMITED WARRANTIES EXTEND TO THE ORIGINAL CONSUMER PURCHASER OR ANY PERSON RECEIVING THIS LCD TV AS A GIFT FROM THE ORIGINAL CONSUMER PURCHASER AND TO NO OTHER PURCHASER OR TRANSFEREE.

#### Limited One (1) Year Warranty on Parts and Labor

TCL warrants this LCD TV and its parts against defects in materials or workmanship for a period of one (1) year after the date of original retail purchase. DURING THIS PERIOD, TCL WILL, AT TCL'S OPTION, REPAIR OR REPLACE A DEFECTIVE PART WITH A NEW OR REFURBISHED PART WITHOUT CHARGE TO YOU FOR PARTS OR LABOR.

##### a) FOR LCD TVs UNDER 37":

To receive warranty service, you must return the LCD TV to a TCL Authorized Service Depot.

##### b) FOR LCD TVs 37" AND LARGER:

During this period, TCL Authorized Service Depot personnel will come to your home when warranty service is required. Depending on the type of repair required, the service will either be performed in your home or the LCD Television will be taken to a TCL Authorized Service Depot for repair and returned to your home at no cost to you. **IN-HOME SERVICE ONLY APPLIES WITHIN 100 KILOMETERS OF AN AUTHORIZED TCL SERVICE DEPOT.**

#### Rental Units

The warranty for rental units begins with the date of first rental or thirty (30) days from the date of shipment to the rental firm, whichever comes first.

#### Commercial Units

LCD TVs sold and used for commercial purposes have a limited ninety (90) day warranty for all parts and labor.

#### Owner's Manual and Product Registration

Read this owner's manual thoroughly before operating this LCD TV. If you purchased your LCD TV in Canada, register it online at [www.toshiba.ca](http://www.toshiba.ca) as soon as possible. By registering your product you will enable TCL to bring you new products specifically designed to meet your needs and help us to contact you in the unlikely event a safety notification is required.

**Failure to register online does not diminish your warranty rights.**

#### Your Responsibility

THE ABOVE WARRANTIES ARE SUBJECT TO THE FOLLOWING CONDITIONS:

- (1) You must provide your bill of sale or other proof of purchase.
- (2) All warranty servicing of this LCD TV must be made by an Authorized TCL Service Depot.
- (3) The warranties from TCL are effective only if the LCD TV is purchased in Canada from an authorized TCL dealer and operated in Canada.
- (4) Labor charges for installation, setup, adjustment of customer controls, and installation or repair of antenna systems are not covered by these warranties. Reception problems caused by inadequate antenna systems are your responsibility.

- (5) Warranties extend only to defects in materials or workmanship as limited above, and do not extend to any LCD TV or parts that have been lost or discarded by you or to damage to the LCD TV or parts caused by fires, misuse, accident, Acts of God (such as lightning or fluctuations in electric power), improper installation, improper maintenance, or use in violation of instructions furnished by TCL; use or malfunction through simultaneous use of this product and connected equipment; or to units that have been modified or had the serial number removed, altered, defaced, or rendered illegible.

#### How to Obtain Warranty Services

If, after following all of the operating instructions in this manual and checking the "Troubleshooting" section, you find that service is needed:

- (1) To find the nearest TCL Authorized Service Depot, visit TCL's web site at [www.toshiba.ca](http://www.toshiba.ca).
- (2) Present your bill of sale or other proof of purchase to the Authorized Service Depot.

---

**For additional information, visit TCL's web site:  
[www.toshiba.ca](http://www.toshiba.ca)**

---

ALL WARRANTIES IMPLIED BY THE LAW OF ANY PROVINCE OF CANADA, INCLUDING THE IMPLIED WARRANTIES OF MERCHANTABILITY AND FITNESS FOR A PARTICULAR PURPOSE, ARE EXPRESSLY LIMITED TO THE DURATION OF THE LIMITED WARRANTIES SET FORTH ABOVE. WITH THE EXCEPTION OF ANY WARRANTIES IMPLIED BY THE LAW OF ANY PROVINCE OF CANADA AS HEREBY LIMITED, THE FOREGOING WARRANTY IS EXCLUSIVE AND IN LIEU OF ALL OTHER WARRANTIES, GUARANTEES, AGREEMENTS, AND SIMILAR OBLIGATIONS OF TCL WITH RESPECT TO THE REPAIR OR REPLACEMENT OF ANY PARTS. IN NO EVENT SHALL TCL BE LIABLE FOR CONSEQUENTIAL OR INCIDENTAL DAMAGES (INCLUDING, BUT NOT LIMITED TO, LOST PROFITS, BUSINESS INTERRUPTION, OR MODIFICATION OR ERASURE OF RECORDED DATA) CAUSED BY USE, MISUSE, OR INABILITY TO USE THIS PRODUCT.

No person, agent, distributor, dealer, or company is authorized to change, modify, or extend the terms of these warranties in any manner whatsoever. The time within which action must be commenced to enforce any obligation of TCL arising under this warranty or under any law of Canada or of any province thereof is hereby limited to 90 days from the date you discover, or should have discovered, the defect. This limitation does not apply to implied warranties arising under the law of any province of Canada.

THIS WARRANTY GIVES YOU SPECIFIC LEGAL RIGHTS, AND YOU MAY ALSO HAVE OTHER RIGHTS, WHICH MAY VARY FROM PROVINCE TO PROVINCE IN CANADA. SOME PROVINCES OF CANADA DO NOT ALLOW LIMITATIONS ON THE DURATION OF AN IMPLIED WARRANTY, LIMITATIONS ON THE TIME WITHIN WHICH AN ACTION MAY BE BROUGHT, OR THE EXCLUSION OR LIMITATION OF INCIDENTAL OR CONSEQUENTIAL DAMAGES; THEREFORE, THE ABOVE LIMITATIONS OR EXCLUSIONS MAY NOT APPLY TO YOU UNDER SUCH CIRCUMSTANCES.



# Index

<b>A</b>			
Antenna cable .....	10		
Audio quality adjustments .....	39		
Auto aspect .....	33		
Auto power off .....	44		
<b>B</b>			
Back of the TV .....	9		
Blue screen .....	34		
<b>C</b>			
Cable box connection .....	12		
CableClear DNR .....	36		
Cables .....	10		
Camcorder connection .....	14		
CC Reception Adjustment .....	38		
CH ▲▼ buttons .....	31		
CH RTN button .....	31		
Channel Number buttons .....	31		
Channel programming			
Automatic programming .....	26		
Manually adding and deleting ...	27		
Cinema mode .....	34		
Closed captions .....	37		
Color temperature .....	37		
ColorStream .....	13		
Component video .....	13		
Component video cables .....	10		
Connecting devices .....	11		
<b>D</b>			
DNR (Digital Noise Reduction) .....	36		
DVD player connection .....	13		
DVI connection .....	15		
<b>F</b>			
Favorite channels .....	27		
Features, TV .....	7		
Front of the TV .....	8		
<b>H</b>			
HDMI audio mode .....	29		
HDMI cable .....	10		
HDMI™ connection .....	15		
<b>I</b>			
Installation, care, and service .....	3		
Installation, setup .....	7		
<b>L</b>			
Labeling video input .....	30		
Language selection .....	26		
Last mode memory feature .....	44		
Locks menu			
New PIN code .....	41		
Video inputs, locking .....	41		
<b>M</b>			
MPEG noise reduction .....	36		
MTS feature .....	38		
MUTE button .....	38		
<b>P</b>			
PC connection .....	16		
PC setting .....	42		
Picture adjustment .....	35		
Picture mode .....	35		
Picture quality .....	35		
Picture size selection .....	31		
POWER button .....	8		
<b>R</b>			
RECALL button .....	44		
Remote control			
Battery installation .....	17		
Device code table .....	22		
Effective range .....	17		
Functional key chart .....	20		
Learning about the buttons .....	18		
Programming .....	21		
<b>S</b>			
Safety .....	2		
SAP sound .....	38		
Selecting Menu Language .....	26		
Service .....	4		
Side panel control .....	8		
Sleep timer .....	43		
Specifications .....	47		
StableSound® .....	40		
Stereo sound .....	38		
S-video cable .....	10		
<b>T</b>			
TheaterWide® picture size .....	32		
Troubleshooting .....	45		
<b>V</b>			
VCR connection .....	11, 12, 13, 14		
Video cables .....	10		
Video input label .....	30		
Video input lock .....	41		
<b>W</b>			
Warranty			
Canada .....	48		
WOW:Focus .....	39		
WOW:SRS 3D .....	39		
WOW:TruBass .....	39		

## **TOSHIBA OF CANADA LTD.**

HEAD OFFICE: 191 McNABB STREET, MARKHAM, ONTARIO, L3R 8H2, CANADA – TEL: (905) 470-5400

SERVICE CENTERS:

TORONTO: 191 McNABB STREET, MARKHAM, ONTARIO L3R 8H2, CANADA – TEL: (905) 470-5400

MONTREAL: 18050 TRANS CANADA, KIRKLAND, QUEBEC, H9J 4A1, CANADA – TEL: (514) 390-7766

VANCOUVER: 13551 COMMERCE PARKWAY, SUITE 110, RICHMOND, B.C., V6V 2L1, CANADA – TEL: (604) 303-2500

MANUFACTURED BY

**TOSHIBA ELECTROMEX, S.A. DE C.V.**

CableClear, ColorStream, StableSound, and TheaterWide are registered trademarks of Toshiba America Consumer Products, L.L.C.

PRINTED IN USA  
(06-05)

# **TOSHIBA**

## Free Manuals Download Website

<http://myh66.com>

<http://usermanuals.us>

<http://www.somanuals.com>

<http://www.4manuals.cc>

<http://www.manual-lib.com>

<http://www.404manual.com>

<http://www.luxmanual.com>

<http://aubethermostatmanual.com>

Golf course search by state

<http://golfingnear.com>

Email search by domain

<http://emailbydomain.com>

Auto manuals search

<http://auto.somanuals.com>

TV manuals search

<http://tv.somanuals.com>