

OWNER'S MANUAL

LCD Color Television

COLORSTREAM®

SRS
WOW

HDTV
MONITOR

THEATERWIDE **HD** **HDMI**

Introduction

Connecting
your TV

Using the
remote control

Setting up
your TV

Using the TV's
Features

Appendix

Index

Owner's Record

The model number and serial number are on the back of your TV. Record these numbers in the spaces below. Refer to these numbers whenever you communicate with your Toshiba dealer about this TV.

Model number:

27HL85

Serial number:

27HL85

Dear Customer,

Thank you for purchasing this Toshiba LCD TV. This manual will help you use the many exciting features of your new LCD TV. **Before operating the LCD TV, please read this manual completely, and keep it nearby for future reference.**

Safety Precautions

WARNING: TO REDUCE THE RISK OF FIRE OR ELECTRIC SHOCK, DO NOT EXPOSE THIS APPLIANCE TO RAIN OR MOISTURE.



WARNING: TO REDUCE THE RISK OF ELECTRIC SHOCK, DO NOT REMOVE COVER (OR BACK). NO USER-SERVICEABLE PARTS INSIDE. REFER SERVICING TO QUALIFIED SERVICE PERSONNEL.

 The lightning symbol in the triangle tells you that the voltage inside this product may be strong enough to cause an electric shock. **DO NOT TRY TO SERVICE THIS PRODUCT YOURSELF.**

 The exclamation mark in the triangle tells you that important operating and maintenance instructions follow this symbol.

WARNING

To prevent injury, this apparatus must be securely attached to the floor/wall in accordance with the installation instructions. (See item 19 on page 3.)

WARNING: Always use Toshiba wall bracket model number **FWB2027** or a **Toshiba approved type** to wall mount this television. The use of any wall bracket other than Toshiba wall bracket model number **FWB2027** or a **Toshiba approved type** could result in serious bodily injury and/or property damage. Consult your consumer electronics dealer for ordering information.

 **NOTE: NEVER CONNECT THIS TV TO A PERSONAL COMPUTER (PC).**
This TV is not intended for use with a PC.

NOTE TO CATV INSTALLERS

This is a reminder to call the CATV system installer's attention to Article 820-40 of the NEC, which provides guidelines for proper grounding and, in particular, specifies that the cable ground shall be connected to the grounding system of the building, as close to the point of cable entry as practical. For additional antenna grounding information, see items 25 and 26 on page 4.

Child Safety

It Makes A Difference Where Your TV Stands



Congratulations on your purchase! As you enjoy your new TV, keep these safety tips in mind:

The Issue

- If you are like most consumers, you have a TV in your home. Many homes, in fact, have more than one TV.
- The home theater entertainment experience is a growing trend, and larger TVs are popular purchases; however, they are not always supported on the proper TV stands.
- Sometimes TVs are improperly secured or inappropriately situated on dressers, bookcases, shelves, desks, audio speakers, chests, or carts. As a result, TVs may fall over, causing unnecessary injury.

Toshiba Cares!

- The consumer electronics industry is committed to making home entertainment enjoyable and safe.
- The Consumer Electronics Association formed the Home Entertainment Support Safety Committee, comprised of TV and consumer electronics furniture manufacturers, to advocate children's safety and educate consumers and their families about television safety.



Tune Into Safety

- One size does NOT fit all! Use appropriate furniture large enough to support the weight of your TV (and other electronic components).
- Use appropriate angle braces, straps, and anchors to secure your furniture to the wall (but never screw anything directly into the TV).
- Carefully read and understand the other enclosed instructions for proper use of this product.
- Do not allow children to climb on or play with furniture and TVs.
- Avoid placing any item on top of your TV (such as a VCR, remote control, or toy) that a curious child may reach for.
- Remember that children can become excited while watching a program and can potentially push or pull a TV over.
- Share our safety message about this hidden hazard of the home with your family and friends. Thank you!



2500 Wilson Blvd.
Arlington, VA 22201 U.S.A.
Tel. 703-907-7600 Fax 703-907-7690
www.CE.org

CEA is the Sponsor, Producer and Manager of the International CES®

Important Safety Instructions

- 1) Read these instructions.
- 2) Keep these instructions.
- 3) Heed all warnings.
- 4) Follow all instructions.



- 5) Do not use this apparatus near water.
- 6) Clean only with dry cloth.
- 7) Do not block any ventilation openings. Install in accordance with the manufacturer's instructions.
- 8) Do not install near any heat sources such as radiators, heat registers, stoves, or other apparatus (including amplifiers) that produce heat.

- 9) Do not defeat the safety purpose of the polarized or grounding type plug. A polarized plug has two blades with one wider than the other. A grounding type plug has two blades and a third grounding prong. The wide blade or the third prong are provided for your safety. If the provided plug does not fit into your outlet, consult an electrician for replacement of the obsolete outlet.

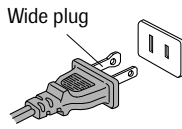

- 10) Protect the power cord from being walked on or pinched, particularly at plugs, convenience receptacles, and the point where they exit from the apparatus.

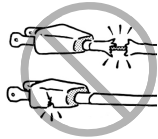

- 11) Only use attachments/accessories specified by the manufacturer.

- 12) Use only with the cart, stand, tripod, bracket, or table specified by the manufacturer, or sold with the apparatus. When a cart is used, use caution when moving the cart/apparatus combination to avoid injury from tip-over.



- 13) Unplug this apparatus during lightning storms or when unused for long periods of time.

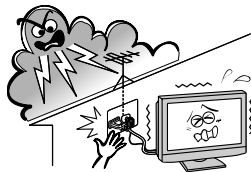

- 14) Refer all servicing to qualified service personnel. Servicing is required when the apparatus has been damaged in any way, such as power-supply cord or plug is damaged, liquid has been spilled or objects have fallen into the apparatus, the apparatus has been exposed to rain or moisture, does not operate normally, or has been dropped.

CAUTION: If the TV is dropped and the cabinet or enclosure surface has been damaged or the TV does not operate normally, take the following precautions:

- ALWAYS turn off the TV and unplug the power cord to avoid possible electric shock or fire.
- NEVER allow your body to come in contact with any broken glass or liquid from the damaged television. The LCD panel inside the TV contains glass and a toxic liquid. If the liquid comes in contact with your mouth or eyes, or your skin is cut by broken glass, rinse the affected area thoroughly with water and consult your doctor.
- ALWAYS contact a service technician to inspect the TV any time it has been damaged or dropped.

- 15) The apparatus shall not be exposed to dripping or splashing and that no objects filled with liquids, such as vases, shall be placed on the apparatus.

Installation, Care, and Service

Installation

Follow these recommendations and precautions and heed all warnings when installing your TV:

- 16) Never modify this equipment. Changes or modifications may void: a) the warranty, and b) the user's authority to operate this equipment under the rules of the Federal Communications Commission.

- 17) **DANGER: RISK OF SERIOUS PERSONAL INJURY, DEATH, OR EQUIPMENT DAMAGE!** Never place the TV on an unstable cart, stand, or table. The TV may fall, causing serious personal injury, death, or serious damage to the TV.



- 18) Never place items such as vases, aquariums, or candles on top of the TV.

- 19) Always place the TV on the floor or a sturdy, level, stable surface that can support the weight of the unit. To secure the TV, use a sturdy tie from the hooks on the rear of the TV pedestal to a wall, pillar, or other immovable structure. Make sure the tie is tight, secure, and parallel to the floor. Leave a space of at least 4 inches around the TV.

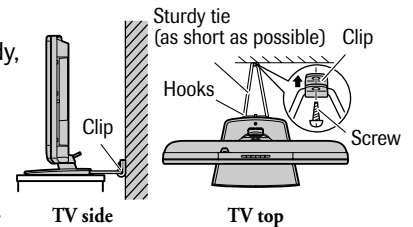

- 20) Never expose the apparatus to dripping or splashing liquid or place items such as vases, aquariums, any other item filled with liquid, or candles on top of the TV.

- 21) Never block or cover the slots or openings in the TV cabinet back, bottom, and sides. Never place the TV:

- on a bed, sofa, rug, or similar surface;
- too close to drapes, curtains, or walls; or
- in a confined space such as a bookcase, built-in cabinet, or any other place with poor ventilation.

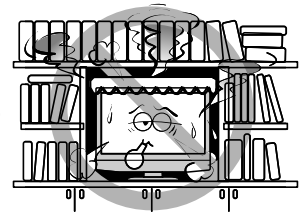

The slots and openings are provided to protect the TV from overheating and to help maintain reliable operation of the TV.

- 22) Never allow anything to rest on or roll over the power cord, and never place the TV where the power cord is subject to wear or abuse.

- 23) Never overload wall outlets and extension cords.

- 24) Always operate the TV with a 120V AC, 60Hz power source only.

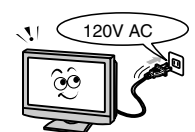

CAUTION: To reduce the risk of electric shock, do not use the polarized plug with an extension cord, receptacle, or other outlet unless the blades can be inserted completely to prevent blade exposure.

Installation (cont. from previous page)

- 25) Always make sure the antenna system is properly grounded to provide adequate protection against voltage surges and built-up static charges (see Section 810 of the National Electric Code).

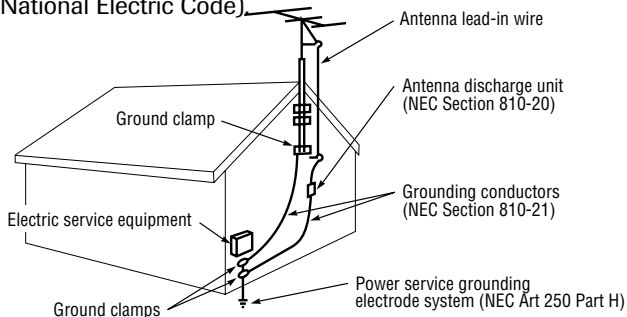

26) **! DANGER: RISK OF SERIOUS PERSONAL INJURY OR DEATH!**

• Use extreme care to make sure you are never in a position where your body (or any item you are in contact with, such as a ladder or screwdriver) can accidentally touch overhead power lines. Never locate the antenna near overhead power lines or other electrical circuits.

- Never attempt to install any of the following during lightning activity:
- an antenna system; or
 - cables, wires, or any home theater component connected to an antenna or phone system.



Care

For better performance and safer operation of your TOSHIBA TV, follow these recommendations and precautions:

- 27) If you use the TV in a room whose temperature is 32 °F (0 °C) or below, the picture brightness may vary until the LCD warms up. This is not a sign of malfunction.

- 28) Always unplug the TV before cleaning. Gently wipe the display panel surface (the TV screen) using dry, soft cloth only (cotton, flannel, etc.). A hard cloth may damage the surface of the panel. Avoid contact with alcohol, thinner, benzene, acidic or alkaline solvent cleaners, abrasive cleaners, or chemical cloths, which may damage the surface. Never spray volatile compounds such as insecticide on the cabinet. Such products may damage or discolor the cabinet.

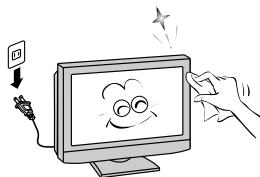

- 29) To avoid damage to this product, never place or store the TV in direct sunlight; hot, humid areas; or areas subject to excessive dust or vibration.

Care (cont. from previous column)

- 30) **! WARNING: RISK OF ELECTRIC SHOCK!** Never spill liquids or push objects of any kind into the TV cabinet slots.

- 31) While it is thundering, do not touch the connecting cables or apparatus.

- 32) For added protection of your TV from lightning and power surges, always unplug the power cord and disconnect the antenna from the TV if you leave the TV unattended or unused for long periods of time.

- 33) During normal use, the TV may make occasional snapping or popping sounds. This is normal, especially when the unit is being turned on or off. If these sounds become frequent or continuous, unplug the power cord and contact a Toshiba Authorized Service Center.

- 34) **! WARNING: RISK OF SERIOUS PERSONAL INJURY OR EQUIPMENT DAMAGE!**



Never strike the screen with a sharp or heavy object.

- 35) • The LCD screen of this product can be damaged by ultraviolet radiation from the sun. When selecting a location for the television, avoid locations where the screen may be exposed to direct sunlight, such as in front of a window.
- Never touch, press, or place anything on the LCD screen. These actions will damage the LCD screen. If you need to clean the LCD screen, follow the instructions in item 28 on page 4.

Service

- 36) **! WARNING: RISK OF ELECTRIC SHOCK!** Never attempt to service the TV yourself. Opening and removing the covers may expose you to dangerous voltage or other hazards. Refer all servicing to a Toshiba Authorized Service Center.

- 37) If you have the TV serviced:

- Ask the service technician to use only replacement parts specified by the manufacturer.
- Upon completion of service, ask the service technician to perform routine safety checks to determine that the TV is in safe operating condition.

- 38) The cold cathode fluorescent lamp in the LCD panel contains a small amount of mercury. When the TV reaches the end of its useful life, dispose of the used TV by the approved method for your area, or ask a qualified service technician to properly dispose of the TV.

! Note: The lamp unit contains mercury, the disposal of which may be regulated due to environmental considerations. For disposal or recycling information, contact your local authorities or the Electronics Industries Alliance (www.eiae.org).

Important notes about your LCD TV

The following symptoms are technical limitations of LCD Display technology and are not an indication of malfunction. Therefore, Toshiba is not responsible for perceived defects resulting from these symptoms.

- 1) An afterimage (ghost) may appear on the screen if a fixed, non-moving image is displayed for a long period of time. The afterimage is not permanent and will disappear in a short period of time.
- 2) The LCD panel contained in this TV is manufactured using an extremely high level of precision technology; however, there may be an occasional pixel (dot of light) that does not operate properly (does not light, remains constantly lit, etc.). This is a structural property of LCD technology, is not a sign of malfunction, and is not covered under your warranty. Such pixels are not visible when the picture is viewed from a normal viewing distance.

Note: Interactive video games that involve shooting a “gun” type of joystick at an on-screen target may not work on this TV.

Introduction 7

Welcome to Toshiba 7
Supplied accessories 7
Exploring your new TV 8

Connecting your TV 9

Connecting an antenna or cable TV 9
Connecting a VCR 10
Connecting a cable converter box and VCR 10
Connecting a DVD player or satellite receiver and a VCR 11
Connecting a DVD player with ColorStream® (component video) and a VCR 12
Connecting a DTV receiver/set-top box with ColorStream® (component video) and a VCR 13
Connecting two VCRs 14
Connecting a camcorder 14
Connecting an HDMI™ or a DVI device to the HDMI input 15

Using the remote control 16

Preparing the remote control for use 16
Installing the remote control batteries 16
Remote control effective range 16
Programming the remote control to operate a cable converter box, satellite receiver, VCR, DVD player, or HTIB (home theater in a box) 17
Remote control codes 17
Using the remote control to operate a cable converter box, satellite receiver, VCR, DVD player, or HTIB (home theater in a box) 19
Remote Control function key chart 20
Learning about the remote control 21

Setting up your TV 22

Learning about the menu system 22
Changing the on-screen display language 23
Adding channels to the TV's memory 24
Programming channels automatically 24
Adding and erasing channels manually 25
Changing channels 25

Using the TV's features 26

Adjusting the channel settings 26
Switching between two channels using Channel Return 26
Programming your favorite channels 26
Labeling channels 28
Viewing the wide-screen picture formats 29
Selecting the picture size 29
Adjusting the PICTURE POSITION 31
Using the AUTO ASPECT feature 32
Setting the HDMI audio mode 32
Using the gray screen function 33
Selecting the gray level of the side panels 33
Using the LOCKS menu 34
Entering the PIN code 34
If you cannot remember your PIN code 34

Using the V-CHIP menu 34
ENABLE BLOCKING 35
TV RATING (Independent rating system for broadcasters) 35
MPAA RATING (Independent rating system for movies) 36
BLOCKING OPTION 36
Unlocking programs temporarily 37
Locking channels 37
Locking the video inputs 39
Changing the PIN code 39
Adjusting the picture 40
Selecting the picture mode 40
Adjusting the back light feature 40
Adjusting the picture quality 41
Using the Black stretch feature 41
Using the MPEG NR feature 42
Using the CableClear® DNR feature 42
Selecting the color temperature 43
Selecting the cinema mode 43
Selecting the video input source 44
Labeling the video input sources 44
Using the closed caption feature 45
Setting the sleep timer 46
Setting the ON timer 46
Adjusting the sound 47
Muting the sound 47
Selecting stereo/SAP broadcasts 47
Using the WOW™ surround sound feature 48
Adjusting the sound quality 49
Using the StableSound® feature 49
Displaying on-screen information 50
Understanding the auto power off feature 50
Understanding the last mode memory feature 50

Appendix 51

Specifications 51
Troubleshooting 52
Limited United States Warranty 53
Limited Canada Warranty 54

Index 51

Introduction

Welcome to Toshiba

Thank you for purchasing this Toshiba LCD TV. The goal of this manual is to guide you through setting up and operating your Toshiba TV as quickly as possible.

The model and serial numbers are on the back of your TV. Write these numbers in the space provided on the front cover of this manual for your records.

Instructions in this manual are based on using the remote control. You also can use the controls on the TV if they have the same name as those referred to on the remote control.

Please read all the safety and operating instructions carefully, and keep this manual for future reference.

Supplied accessories

Check that you have the accessories and items shown.

Owner's Manual
(This book)

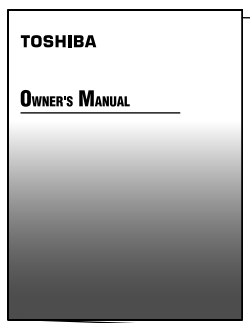

Remote control
CT-90159

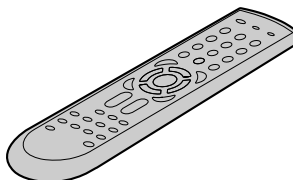

Batteries for the remote control
LR6 (AA) × 2

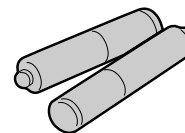

Clip



Use this clip to attach the TV to a wall, pillar, or other immovable structure. See item 19 on page 3.

Exploring your new TV

You can operate your TV by using the buttons on the top panel or the remote control. The A/V terminals for connecting other equipment to your TV are on the back panel and side panel (see illustrations below). Also see "Connecting your TV" on pages 9-15.

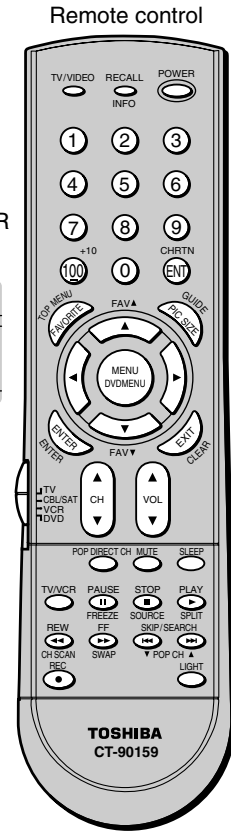
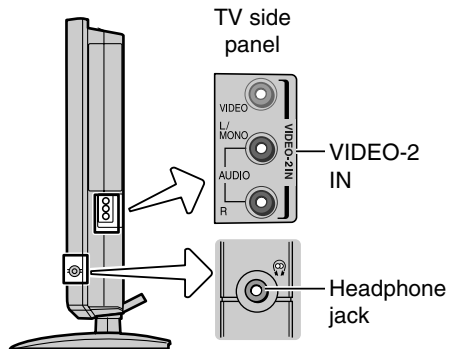
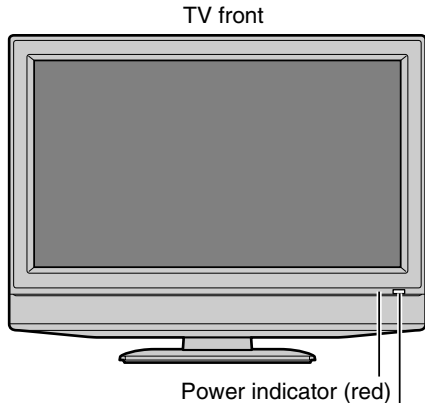
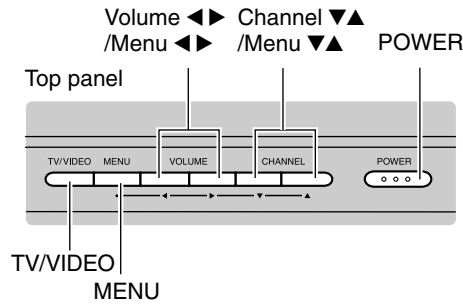
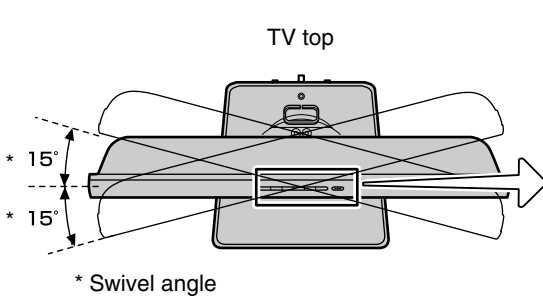

Remote sensor

TV upper back panel

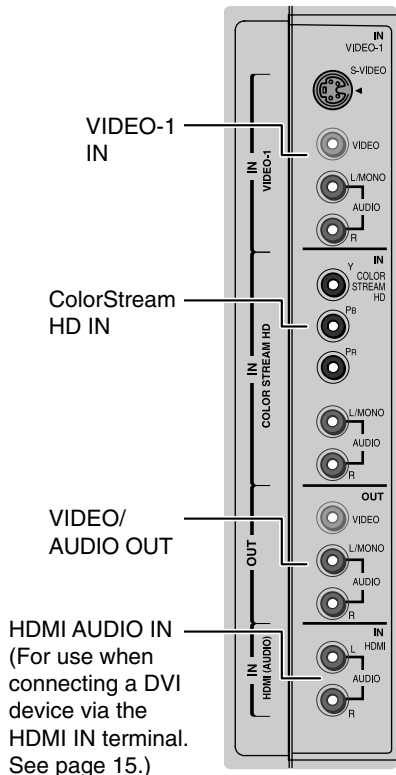

Before connecting the external equipment etc., remove the panel covers. To remove the covers, squeeze the tabs in the direction of the arrow (→), then pull the covers.

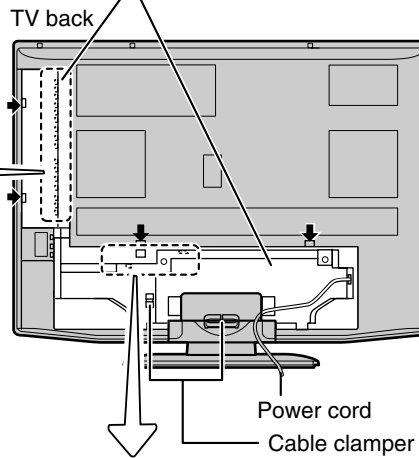

TV lower back panel

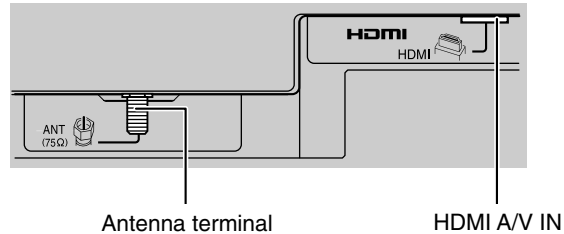

Connecting your TV

Note: Cables are not supplied with your TV.

- **Coaxial (F-type) cable** is used for connecting your antenna, cable TV service, and/or cable converter box to the ANT RF input on your TV.
- **Standard A/V cables (composite video)** usually come in sets of three, and are for use with video devices with standard audio and standard (composite) video output. These cables (and the related inputs on your TV) are typically color-coded according to use: yellow for video, red for stereo right audio, and white for stereo left (or mono) audio.
- **S-video cable** is for use with video devices with S-video output. Separate audio cables are required for a complete connection.

Note: An S-video cable provides better picture performance than a standard (composite) video cable.

- **Component video cables** come in sets of three and are for use with video devices with component video output. These cables are typically color-coded red, green, and blue. (ColorStream® is Toshiba's brand of component video.) Separate audio cables are required for a complete connection.

Note: Component video cables provide better picture performance than a standard (composite) video or S-video cable.

- **HDMI cable** is for use with devices with uncompressed HDMI (high-definition multimedia interface) video/compressed audio output. HDMI cable delivers digital audio and video in its native format (see page 15). This cable carries both video and audio information; therefore, no separate audio cables are needed for a complete connection.

Note: HDMI cable provides better picture performance than a standard (composite) video or S-video cable.

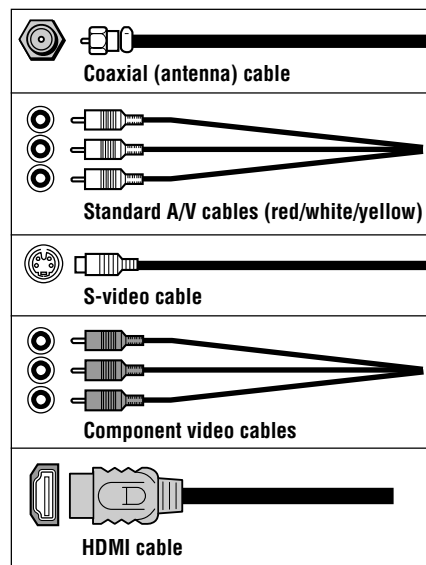

NOTE: RISK OF EQUIPMENT DAMAGE!
Never plug in any power cords until you have finished connecting all equipment.

NOTE: NEVER CONNECT THIS TV TO A PERSONAL COMPUTER (PC).
This TV is not intended for use with a PC.

Connecting an antenna or cable TV

This connection allows you to watch TV programs or basic cable channels.

From Antenna or Cable

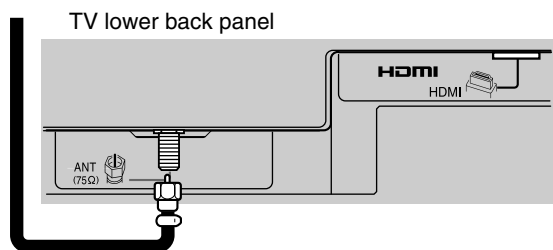

Connecting a VCR

This connection allows you to watch local channels and video programs, play or record on the VCR while watching TV, and record from one channel while watching another channel.

You will need:

- two coaxial cables
- one set of standard A/V cables

From Cable Box or Antenna

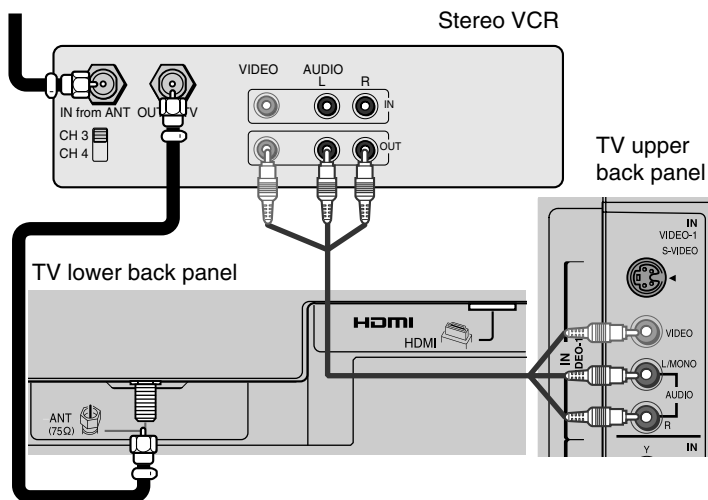

Note:

If you have a mono VCR, connect L/Mono to VCR Audio OUT using only one audio cable.

If you have a VCR with S-video, use an S-video cable instead of a standard video cable.

The unauthorized recording, use, distribution, or revision of television programs, videotapes, DVDs, and other materials is prohibited under the Copyright Laws of the United States and other countries, and may subject you to civil and criminal liability.

Connecting a cable converter box and VCR

This connection allows you to watch and record basic and premium cable channels, as well as watch videotapes. Set the TV signal source to VIDEO-1 (page 44). Tune the VCR to channel 3 or 4 (the same channel as the converter box output switch), and use the cable converter box to change channels.

- three coaxial cables
- one set of standard A/V cables

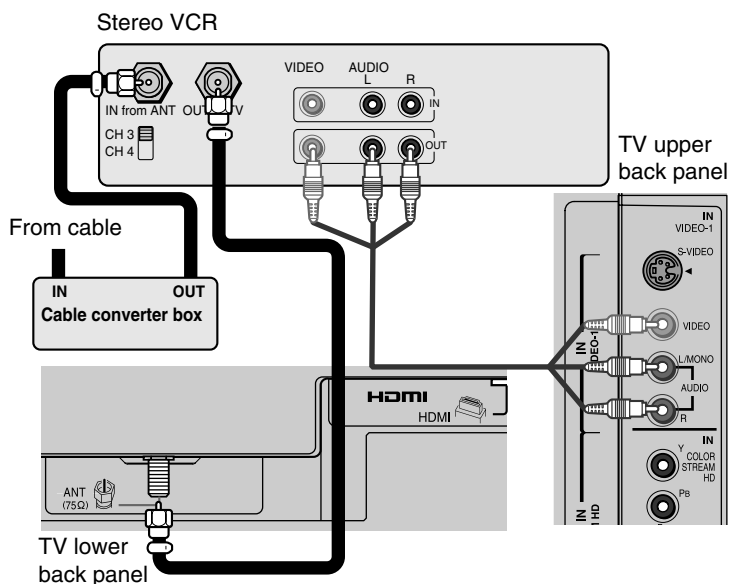

Note:

When you use a converter box with your TV, the channel selection feature does not operate.

When you use a converter box with your TV, the remote control may not operate some features, such as programming your favorite channels, labeling channels, and locking channels.

If you have a mono VCR, connect L/Mono to VCR Audio OUT using only one audio cable.

If you have a VCR with S-video, use an S-video cable instead of a standard video cable.

The unauthorized recording, use, distribution, or revision of television programs, videotapes, DVDs, and other materials is prohibited under the Copyright Laws of the United States and other countries, and may subject you to civil and criminal liability.

Connecting a DVD player or satellite receiver and a VCR

This connection allows you to watch DVD/satellite, VCR, and TV programs, and record one TV channel while watching another channel.

You will need:

- two (or three, if satellite receiver is used) coaxial cables
- one set of standard A/V cables (between the TV and VCR)
- one S-video cable (between the TV and DVD player/satellite receiver)
- one pair of standard audio cables (between the TV and DVD player/satellite receiver)

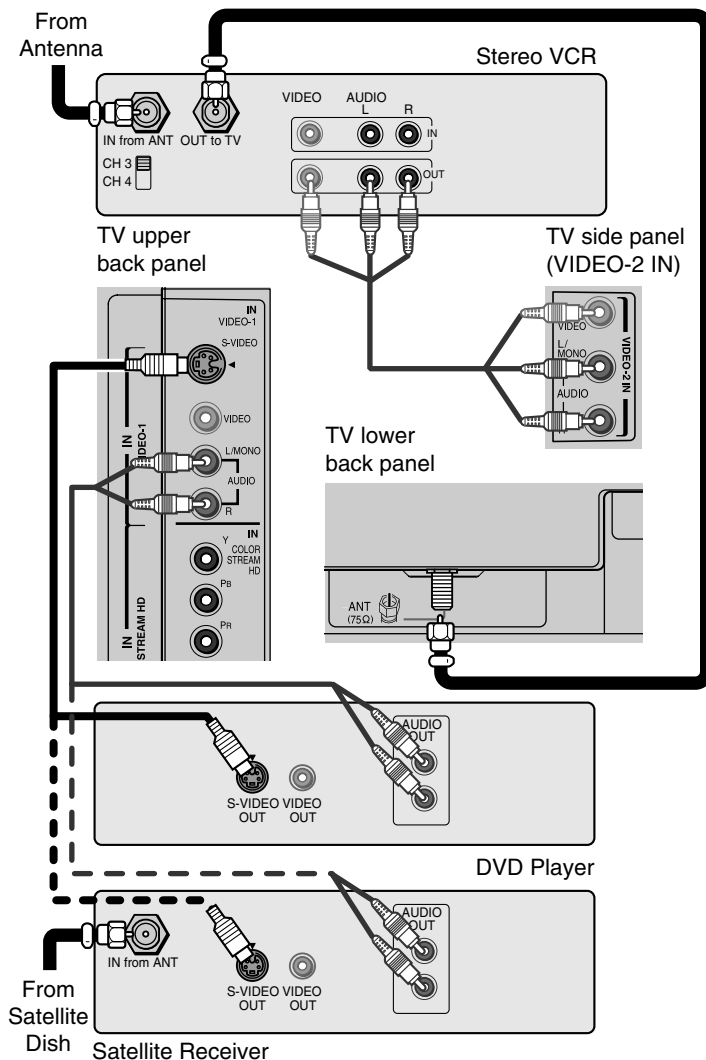

Note:

For the highest possible picture quality from a DVD player or satellite receiver without component video, HDMI, or DVI, use an S-video cable. (If your DVD player has component video, see page 12. If your DVD player or satellite receiver has HDMI or DVI, see page 15.)

Do not connect the DVD player/satellite receiver and VCR to the same set of Video inputs on the TV. (See the illustration, which shows the DVD player/satellite receiver connected to VIDEO 1 on the TV upper back panel, and the VCR connected to VIDEO 2 on the TV side panel.)

The unauthorized recording, use, distribution, or revision of television programs, videotapes, DVDs, and other materials is prohibited under the Copyright Laws of the United States and other countries, and may subject you to civil and criminal liability.

Connecting a DVD player with ColorStream® (component video) and a VCR

This connection allows you to watch DVD, VCR, and TV programs, and record TV programs.

Your TV has ColorStream® (component video) inputs. Connecting your TV to a DVD player with component video (such as a Toshiba DVD player with ColorStream®) can greatly enhance picture quality and realism.

- To record one TV program while watching another TV program, tune the VCR to the channel to record, and tune the TV to the channel to watch.
- To record a TV program while watching a DVD, tune the VCR to the channel to record, and select ColorStream HD on the TV (see "Selecting the video input source" on page 44).

You will need:

- two coaxial cables
- one set of standard A/V cables
- one pair of standard audio cables
- one set of component video cables

Note:

For the highest possible picture quality, use component video cables (or an HDMI or DVI cable) between the TV and DVD player.

For HDMI or DVI connection, see page 15.

The ColorStream HD input and the HDMI input can be used with Progressive (480p, 720p) and Interlaced (480i, 1080i) scan systems; however, a 1080i signal will provide the best picture performance.

If your DVD player is not compatible with component video, HDMI, or DVI, use the S-video connections (plus the standard audio connections) instead (see page 11).

The unauthorized recording, use, distribution, or revision of television programs, videotapes, DVDs, and other materials is prohibited under the Copyright Laws of the United States and other countries, and may subject you to civil and criminal liability.

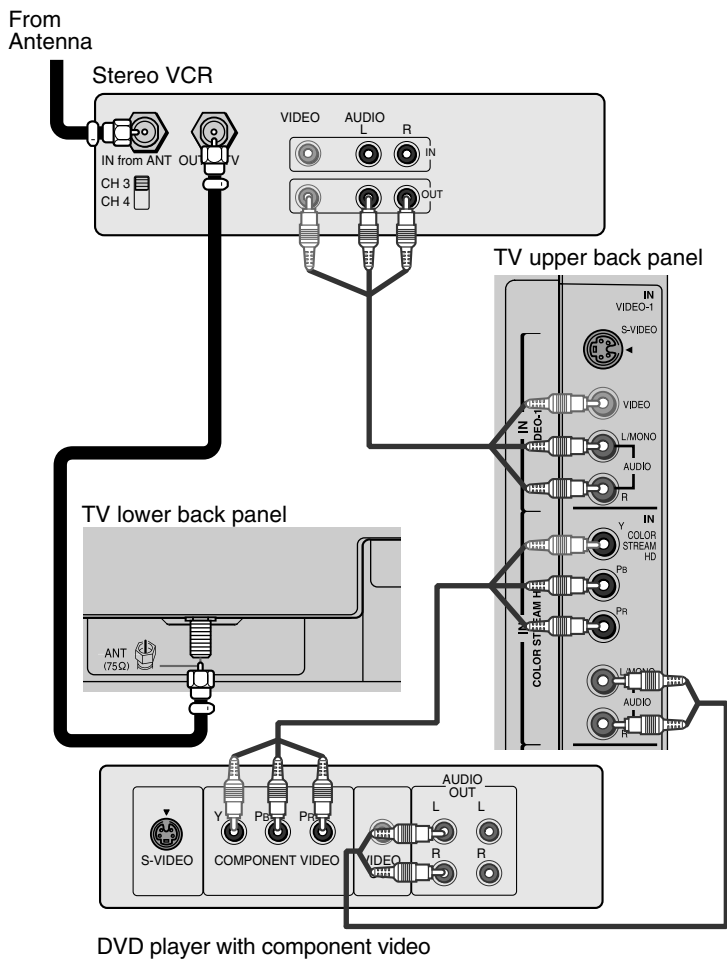

Connecting a DTV receiver/set-top box with ColorStream® (component video) and a VCR

This connection allows you to watch DTV (digital TV), VCR, and TV programs, and record DTV (composite video only) and TV programs.

Your TV has ColorStream® (component video) inputs. Connecting your TV to a DTV receiver with component video can greatly enhance picture quality and realism.

- To record and watch a DTV program, select LINE IN on the VCR, and select ColorStream HD (or VIDEO 1 for a non-ColorStream connection) on the TV (see "Selecting the video input source" on page 44).
- To record a TV program while watching a DTV program, tune the VCR to the channel to record, and select ColorStream HD on the TV.
- To record and watch the same TV program, tune the VCR to the channel to record, and select VIDEO 1 on the TV.
- To record one TV program while watching another TV program, tune the VCR to the channel to record, and tune the TV to the channel to watch.

You will need:

- three coaxial cables
- two sets of standard A/V cables
- one pair of standard audio cables
- one set of component video cables

Note:

For the highest possible picture quality, use component video cables (or an HDMI cable) between the TV and DTV receiver/set-top box.

For HDMI or DVI connection, see page 15.

The ColorStream HD and HDMI inputs can be used with Progressive (480p, 720p) and Interlaced (480i, 1080i) scan systems; however, a 1080i signal will provide the best picture performance.

If your DTV receiver or set-top box is not compatible with component video, HDMI, or DVI use the S-video connections (plus the standard audio connections) instead (see page 12).

The unauthorized recording, use, distribution, or revision of television programs, videotapes, DVDs, and other materials is prohibited under the Copyright Laws of the United States and other countries, and may subject you to civil and criminal liability.

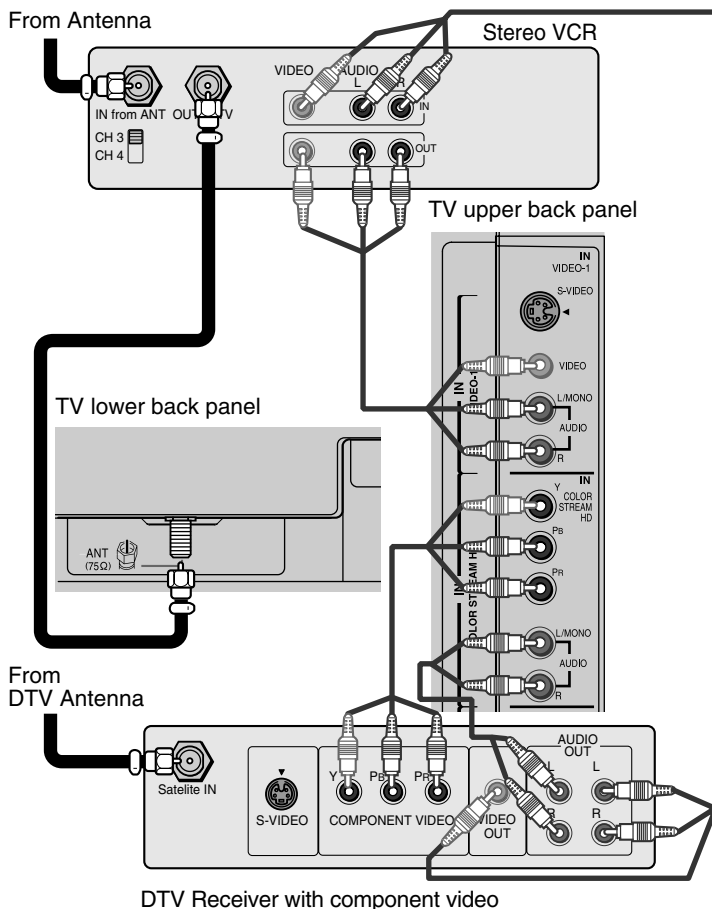

DTV Receiver with component video

Connecting two VCRs

This connection allows you to record (dub/edit) from VCR1 to VCR2 while watching a videotape. You also can record from one TV channel with VCR1 while watching another TV channel.

You will need:

- two coaxial cables
- two sets of standard A/V cables

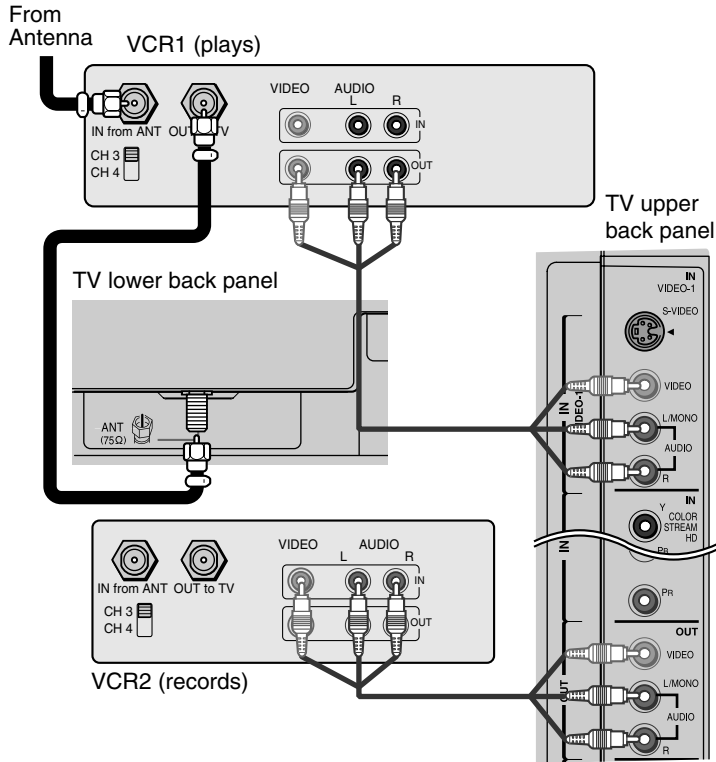

Note:

If you have VCRs with S-video, use S-video cables instead of standard video cables for better picture performance.

Do not connect the same VCR to the output and input jacks on the TV at the same time. To dub or edit, VCR 2 must select LINE IN, and the TV must select VIDEO 1.

The unauthorized recording, use, distribution, or revision of television programs, videotapes, DVDs, and other materials is prohibited under the Copyright Laws of the United States and other countries, and may subject you to civil and criminal liability.

Connecting a camcorder

This connection allows you to watch video materials recorded on a camcorder.

You will need:

- one set of standard A/V cables

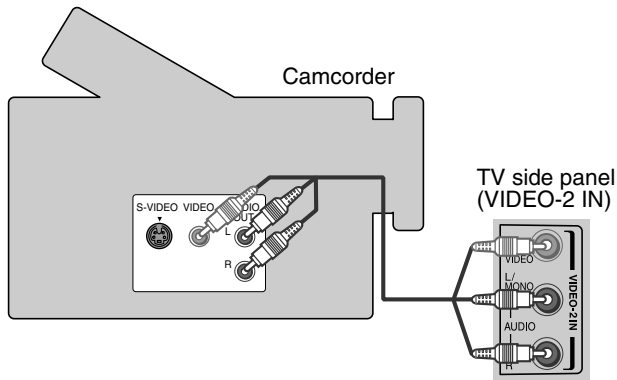

Note:

If you have a camcorder with S-video, you can use an S-video cable instead of a standard video cable for better picture performance. Plug the S-video and standard audio cables into the "VIDEO-1 IN" inputs on the upper back panel of the TV instead of the inputs on the side panel.

Connecting an HDMI™ or a DVI device to the HDMI input

The HDMI^[1] input on your TV receives digital audio and uncompressed digital video from an HDMI device or uncompressed digital video from a DVI^[2] device.

This input is designed to accept HDCP^[3] program material in digital form from EIA/CEA-861/861B-compliant^[4] consumer electronic devices (such as a set-top box or DVD player with HDMI or DVI output).

The HDMI input is designed for best performance with 1080i high-definition video signals, but will also accept and display 480i, 480p, and 720p signals.



NOTE: NEVER CONNECT THIS TV TO A PERSONAL COMPUTER (PC).
This TV is not intended for use with a PC.

To connect an HDMI device, you will need:

- one HDMI cable (type A connector)

For proper operation, it is recommended that you use a short HDMI cable.

HDMI cable transfers both video and audio. Separate analog audio cables are not required (see illustration below). Some CDVs (Video CDs) may not output digital audio signals. In that case, you may be able to hear sound by connecting analog audio cables. However, if you connect analog audio cables with this connection, the HDMI terminal on the TV will not receive the HDMI digital audio signal and you will hear analog audio only.

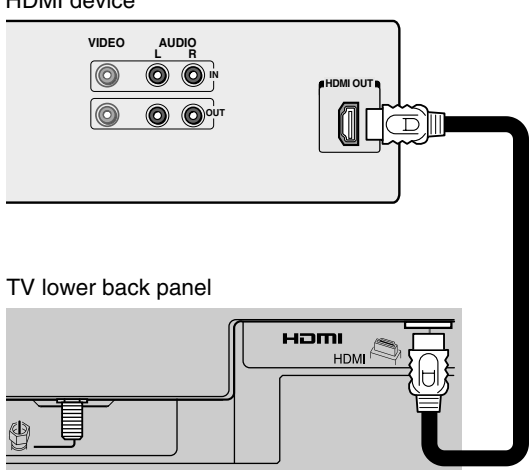

[1] HDMI = High-Definition Multimedia Interface.
 [2] DVI = Digital Video Interface.
 [3] HDCP = High-bandwidth Digital Content Protection.
 [4] EIA/CEA-861/861B compliance covers the transmission of uncompressed digital video with high-bandwidth digital content protection, the technology of which is being standardized for reception of high-definition video signals. Because this is an evolving technology, it is possible that some devices may not operate properly with the TV.

To ensure that the HDMI or DVI device is reset properly, it is recommended that you follow these procedures:

- *When turning on your electronic components, **turn on the TV first**, and then the HDMI or DVI device.*
- *When turning off your electronic components, **turn off the HDMI or DVI device first**, and then the TV.*

To connect a DVI device, you will need:

- one HDMI-to-DVI adapter cable (HDMI type A connector)

For proper operation, the length of an HDMI-to-DVI adapter cable should not exceed 9.8 ft (3m). The recommended length is 6.6 ft (2m).

- one pair of standard analog audio cables

An HDMI-to-DVI adapter cable transfers only video. Separate analog audio cables are required (see illustration below).

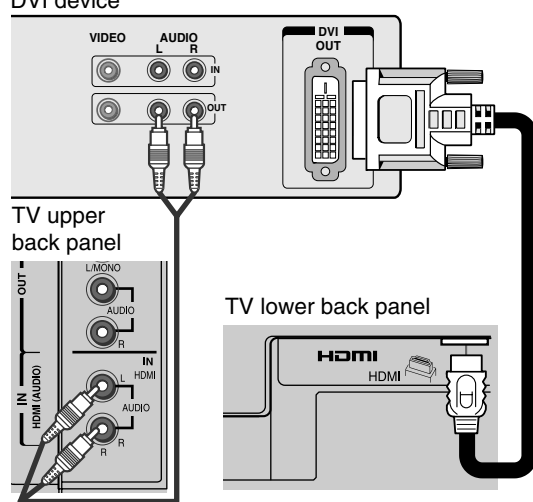

HDMI, the HDMI logo, and High-Definition Multimedia Interface are trademarks or registered trademarks of HDMI Licensing, LLC.

Using the remote control

Preparing the remote control for use

Your TV remote control can operate your TV and many other devices such as cable converter boxes, satellite receivers, VCRs, DVD players, and HTIBs (home theater in a box), even if they are different brands.

If you have a Toshiba device:

Your TV remote control is preprogrammed to operate most Toshiba devices. See page 20.

If you have a non-Toshiba device or a Toshiba device that the remote control is not preprogrammed to operate:

You can program the TV remote control so it will operate the other device. See pages 17–19.

Installing the remote control batteries

1. Remove the battery cover from the back of the remote control.

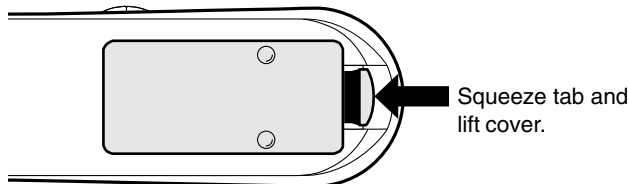

2. Install two “AA” size batteries, making sure to match the + and – signs on the batteries to the signs on the battery compartment.

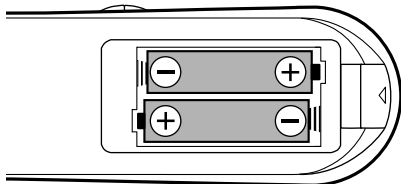

3. Reinsert the battery cover in the remote control until the tab snaps.

Remote control effective range

For optimum performance, aim the remote control directly at the TV and make sure there is no obstruction between the remote control and the TV.

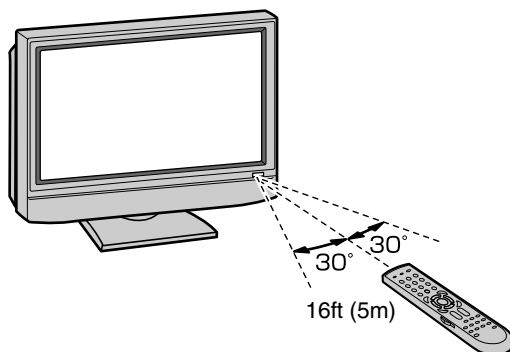

Caution:

Never throw batteries into a fire.

Note:

- Be sure to use AA size batteries.
- Dispose of batteries in a designated disposal area.
- Batteries should always be disposed of with the environment in mind. Always dispose of batteries in accordance with applicable laws and regulations.
- If the remote control does not operate correctly, or if the operating range becomes reduced, replace batteries with new ones.
- When necessary to replace batteries in the remote control, always replace both batteries with new ones. Never mix battery types or use new and used batteries in combination.
- Always remove batteries from remote control if they are dead or if the remote control is not to be used for an extended period of time. This will prevent battery acid from leaking into the battery compartment.

Programming the remote control to operate a cable converter box, satellite receiver, VCR, DVD player, or HTIB (home theater in a box)

Your Toshiba TV remote control is preprogrammed to operate most Toshiba devices. To program your TV remote control to operate a non-Toshiba device (or a Toshiba device that it is not preprogrammed to operate), follow the steps below. For details on using the remote control to operate the device, see pages 19–20.

1. In the remote control code table (below and on the next page), find the code for your device. If more than one code is listed, try each one separately until you find one that works.
2. Set the Device Switch to the type of device you are programming the remote control to operate — **CBL/SAT** (for a cable converter box or satellite receiver), **VCR** (for a VCR or TV/VCR combo), or **DVD** (for a DVD player or HTIB [home theater in a box]).
3. While holding down **RECALL**, press the **Channel Number** buttons to enter the 3-digit code for your device.
4. To test the code, turn on the device, point the remote control at it, and press **POWER**. *See note at right.*
 - If the correct code was entered, the device will turn off.
 - If the device does not respond, repeat steps 1–4 using another code.
 - If the device does not respond to another code, you will need to use the remote control that came with the device.
5. Remember to set the **Device Switch** back to **TV** to control the TV.
6. For future reference, write down the code(s) you used:

DEVICE	CODE	DEVICE	CODE

Remote control codes

In some cases you may not be able to operate your device with the TV remote control. Your other device may use a code that is not recognized by the TV remote control. If this happens, use the device's remote control.

Cable converter box				
ABC: 061, 062, 063, 082, 084, 087, 091, 092, 096, 098	Hamlin: 093	RCA: 064, 081	U. S. Electronics: 087, 096, 098	General Instruments: 010, 011, 012, 022, 023, 031, 049
Archer: 065, 092, 097, 099	Hitachi: 062, 095, 096	Realistic: 065	United Cable: 082	Hitachi: 033
Cableview: 064, 094	Jasco: 097	Recoton: 102	Universal: 065, 092, 097, 099, 102, 103	Hughes: 033
Century: 092	Jerrold: 062, 069, 071, 082, 086, 089, 091, 096	Samsung: 077, 090	Wards: 096	Hughes Network Systems: 019
Citizen: 090, 092, 097	Magnavox: 072, 096	Scientific Atlanta: 063, 078, 079, 080, 088, 098, 101, 105		Intersat: 048
Contec: 083, 085, 086, 088, 093, 098	Memorex: 091, 092, 104	Sears: 095		Janeil: 027
Diamond: 093	Multi Canal: 090	Signature: 062		JVC: 017, 057
Eagle: 091	Novavision: 101	Signature 2000: 096		Kenwood: 029
GE: 061, 062	Panasonic: 081, 083, 085	Sprucer: 081, 085		Magnavox: 060
Gemini: 069, 070, 094	Philco: 087	Starcom: 069, 082, 087, 096, 103, 104		Optimus: 058
General Instruments: 062, 089, 096	Philips: 066, 067, 068, 070, 072, 073, 074, 075, 091, 092	Stargate: 069, 090		Pansat: 036, 052
	Pioneer: 076, 077	Sylvania: 095, 100		Primestar: 015, 042
	Proscan: 061, 062	TeleView: 090		Proscan: 008, 009, 013
	Radio Shack: 092, 097, 099	Texscan: 100		Radio Shack: 022, 023, 030
		Tocom: 071, 084, 085		
			Satellite receiver	
			Alphastar: 038, 059	
			Chaparral: 034	
			DISH Network: 057	
			Drake: 020, 040, 044, 046, 050, 053	
			Echostar: 018, 041, 051	
			Express Vu: 057	
			Fujitsu: 027	
			GE: 008, 009, 013	

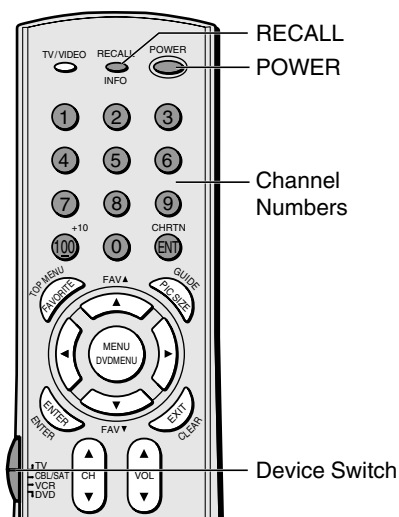

Note:

- In addition to **POWER**, confirm that all necessary keys on the TV remote control operate your device. If some keys are not operational, repeat the device code setup using another code (if other codes are listed for your device). If, after trying all listed codes, the necessary keys do not operate your device, use the device's original remote control.
- Every time you change the batteries, you will need to reprogram the remote control.
- Some newer VCRs respond to either of two codes. These VCRs have a switch labeled "VCR1/VCR2." If your VCR has this kind of switch and does not respond to the codes for your VCR brand, set the switch to the other position ("VCR1" or "VCR2") and reprogram the remote control.

Remote control codes (cont.)

Satellite receiver (cont.)

RCA: 008, 009, 013, 016
 Realistic: 030
 Samsung: 059
 Sony: 014, 055
 Star Choice: 057
 Star Trak: 025, 026, 037, 054
 STS: 024
 Toshiba: 000, 001, 002, 003, 004, 005, 006, 007, 020, 031, 056
 Uniden: 021, 028, 030, 032, 035, 039, 043, 045, 047, 058
 Zenith: 027

TV/VCR Combo

Action: 078
 GE: 059, 062
 Goldstar: 065
 Panasonic: 065
 Precision: 078
 Quasar: 065
 Realistic: 079
 Sony: 074
 Toshiba: 057
 Totevision 009, 010, 065
 Zenith: 065

DVD/VCR Combo

Go Video:
 DVD=087, VCR=081
 JVC:
 DVD=088, VCR=082
 RCA:
 DVD=089, VCR=083
 Samsung:
 DVD=090, VCR=084
 Sanyo:
 DVD=091, VCR=085
 Zenith:
 DVD=092, VCR=086

DVD player

Aiwa: 006, 015
 Apex: 016, 017
 BOSE: 097
 Broksonic: 018
 Clarion: 019
 Classic: 020
 Daewoo: 021
 Denon: 022, 023, 024, 025
 Emerson: 026, 027
 Fisher: 028
 Funai: 027
 GE: 001, 029, 030
 Go Video: 087

GPX: 031
 Hitachi: 005, 032, 033, 034, 035
 JVC: 003, 007, 036, 042, 088
 Kenwood: 037
 Konka: 008, 009
 Magnavox: 004, 038
 Memorex: 039
 Mintek: 040
 NAD: 026
 Nakamichi: 041
 Norcent: 043
 Onkyo: 044
 Oritron: 058
 Panasonic: 010, 045, 046, 047, 048, 049, 050
 Philips: 004, 051
 Pioneer: 052, 053, 054, 055
 Proscan: 001, 056
 Qwestar: 057, 058
 RCA: 001, 002, 059, 089
 Sampo: 060
 Samsung: 061, 062, 086, 090
 Sansui: 073
 Sanyo: 063, 091
 Sharp: 064, 067
 Sherwood: 074
 Sony: 011, 012, 065, 066, 068, 069, 070
 Sylvania: 027
 Teac: 071
 Technics: 072
 Techwood: 075
 Toshiba: 000, 013, 076, 077, 078
 Yamaha: 079, 080, 081
 Zenith: 014, 082, 092

Portable DVD player

Aiwa: 093
 Audiovox: 094, 095
 Panasonic: 024, 096, 099
 RCA: 098

VCR

Admiral: 049
 Aiko: 019
 Aiwa: 018
 Akai: 003, 004, 037, 038, 039, 058, 069
 Audiovox: 010
 Bell & Howell: 007, 068
 Broksonic: 008, 017
 Calix: 010
 Carver: 026
 CCE: 019
 Citizen: 009, 010, 011, 012, 013, 014, 015, 019, 057, 073

ColorTyme: 005
 Craig: 009, 010, 016, 061, 065, 079
 Curtis Mathes: 001, 005, 009, 012, 014, 040, 048, 053, 056, 057
 Daewoo: 011, 013, 015, 017, 018, 019, 057, 078
 Daytron: 078
 Denon: 063
 Dimensia: 001, 048
 Electrohome: 010, 020, 065
 Emerson: 003, 008, 010, 011, 017, 018, 020, 028, 039, 054, 057, 062, 065, 068, 072
 Fisher: 007, 016, 021, 022, 023, 057, 064, 068, 070, 071, 079
 Fuji: 004, 041
 Funai: 018, 073
 Garrard: 018
 GE: 001, 002, 009, 040, 042, 048, 056
 Go Video: 056, 059, 061, 081
 Goldstar: 005, 010, 014, 054, 056, 065, 067
 Gradiente: 018, 065
 Harman Kardon: 005
 Hitachi: 024, 025, 035, 037, 042, 063, 070, 080
 JBL: 076
 JC Penney: 005, 006, 007, 008, 009, 010, 023, 024, 025, 026, 035, 056, 061, 063, 065
 Jensen: 024, 025, 037, 050
 JVC: 005, 006, 007, 014, 037, 043, 062, 063, 068, 082
 Kenwood: 005, 006, 007, 012, 014, 037, 043, 053, 068, 071
 Kodak: 010
 LG: 010
 Lloyds: 053, 073, 079
 Logik: 061
 LXI: 010
 Magnasonic: 061, 065, 078
 Magnavox: 026, 027, 034, 044, 057, 061, 072
 Marantz: 005, 006, 007, 012, 014, 026, 053, 067

Memorex: 007, 009, 010, 016, 018, 034, 049, 063, 065, 066, 068, 075, 079
 MGA: 020, 028, 039
 MGN: 056
 Minolta: 024, 025, 035, 063
 Mitsubishi: 020, 024, 025, 028, 039, 043, 065
 Montgomery Ward: 049
 Motorola: 049
 MTC: 009, 046, 061
 Multitech: 009, 012, 018
 NEC: 005, 006, 007, 012, 014, 037, 043, 053, 054, 067, 070
 Nikko: 010
 Noblex: 009
 Optimus: 010, 049, 065
 Optonica: 031
 Orion: 054, 057, 062, 065, 068, 072
 Panasonic: 036, 045, 046, 057, 061, 072, 079
 Pentax: 012, 024, 025, 035, 042, 053, 063
 Pentex Research: 014
 Philco: 026, 027, 063
 Philips: 026, 031, 044, 057
 Pioneer: 006, 024, 043, 055
 Portland: 012, 013, 015
 Proscan: 001, 002, 048
 Proton: 061
 Quasar: 045
 Radio Shack: 010, 031, 065
 Radio Shack/Realistic: 007, 009, 010, 016, 018, 020, 021, 022, 031, 049
 Radix: 010
 RCA: 001, 002, 003, 009, 024, 025, 029, 035, 040, 042, 045, 048, 055, 056, 063, 071, 083
 Realistic: 007, 009, 010, 011, 016, 018, 020, 021, 022, 031, 049, 051, 056, 060, 065, 075, 079
 Ricoh: 047
 Runco: 034
 Samsung: 009, 011, 038, 056, 073, 084
 Sansui: 006, 037, 043, 061

Sanyo: 007, 009, 016, 054, 064, 068, 071, 075, 079, 085
 Scott: 008, 011, 017, 028, 030, 057, 065, 072
 Sears: 007, 010, 016, 021, 022, 023, 024, 025, 035, 053, 057, 063, 064, 065, 068, 071, 075, 079
 Sharp: 013, 020, 031, 049, 051, 060, 066
 Shintom: 004, 025, 032, 061
 Signature: 049
 Signature 2000: 075
 Singer: 047, 061
 Sony: 004, 032, 033, 041, 052, 058, 070, 074, 076, 077, 080
 STS: 035
 Sylvania: 018, 026, 027, 028, 044, 072
 Symphonic: 018, 051, 053, 073, 079
 Tandy: 007
 Tashiko: 010
 Tatung: 037
 Teac: 018, 029, 037
 Technics: 036
 Teknika: 010, 018, 065
 Toshiba: 000, 011, 021, 023, 024, 028, 030, 039, 057, 074, 078, 079
 Totevision: 009, 010, 065
 Unitec: 073
 Unitech: 009
 Vector Research: 005, 006, 011, 012, 053
 Video Concepts: 005, 006, 011, 012, 039, 053
 Wards: 009, 010, 011, 016, 018, 020, 024, 025, 031, 035, 049, 051, 056, 057, 060, 065, 066, 079
 White Westinghouse: 073
 XR-1000: 018
 Yamaha: 005, 006, 007, 014, 037, 053
 Zenith: 004, 032, 034, 041, 047, 069, 086

HTIB

Lasonic: 083
 Panasonic: 084
 Venturer: 085

Using the remote control to operate a cable converter box, satellite receiver, VCR, DVD player, or HTIB (home theater in a box)

If you have a non-Toshiba device or a Toshiba device that the remote control is not preprogrammed to operate, you must first program the remote control to recognize the device (if you have not already done so). See pages 17 and 18.

To use your TV remote control to operate a:

- Cable converter box or satellite receiver, set the **Device Switch** to CBL/SAT.
- VCR, set the **Device Switch** to VCR.
- DVD player or HTIB, set the **Device Switch** to DVD.

Note:

Even after the TV remote control is programmed, it may not operate certain features on your other device. If this happens and you wish to use those features, you will need to use the device's original remote control.

Point the remote control directly at the device.

POWER
Turns the selected device on and off.

INFO
Displays TV status information on-screen.

Channel Numbers (0-9)
Press to directly access channels (as opposed to CH ▲ ▼).

DVD MENU
Accesses DVD menus.

GUIDE
Displays channel guide.

▲▼◄►
Press to navigate DVD menus (may not work on some DVD players).

CLEAR
Press to reset the title and chapter number.

CH ▲ ▼
▲ selects the next higher channel; ▼ selects the next lower channel. (for channels programmed into memory only)

PLAY
Begins playback of a tape or DVD.

STOP
Stops the tape or DVD.

SKIP/SEARCH ►►
Skips forward to locate later DVD chapters.

SKIP/SEARCH ◄◄
Skips back to beginning of current DVD chapter or locates previous chapters.

+10
Press to directly access DVD chapters higher than 10.

TOP MENU
Accesses a DVD's top menu.

ENTER
Required by some VCRs and cable converter boxes to change the channel.

Device Switch
Set to "TV" to control the TV; "CBL/SAT" to control a cable converter box or satellite receiver; "VCR" to control a VCR; "DVD" to control a DVD player or HTIB.

PAUSE
Press during play or record mode to pause the picture; press again to restart.

TV/VCR
To view one program while recording another, press to select TV mode.

REW
Rewinds the tape or DVD. (Press during play mode to view the picture moving rapidly backward.)

REC
Starts tape recording.

FF
Fast-forwards the tape or DVD. (Press during play mode to view the picture moving rapidly forward.)

TOSHIBA CT-90159

Remote Control function key chart

Key Label	Toshiba TV (TV)	Cable/Satellite (CBL/SAT)	VCR	DVD
POWER	Power	Power	Power	Power
TV/VIDEO	Input	TV Input	TV Input	TV Input
RECALL/INFO	On-screen display	INFO	---	On-screen display
1	Digit 1	Digit 1	Digit 1	Digit 1
2	Digit 2	Digit 2	Digit 2	Digit 2
3	Digit 3	Digit 3	Digit 3	Digit 3
4	Digit 4	Digit 4	Digit 4	Digit 4
5	Digit 5	Digit 5	Digit 5	Digit 5
6	Digit 6	Digit 6	Digit 6	Digit 6
7	Digit 7	Digit 7	Digit 7	Digit 7
8	Digit 8	Digit 8	Digit 8	Digit 8
9	Digit 9	Digit 9	Digit 9	Digit 9
0	Digit 0	Digit 0	Digit 0	Digit 0
100/-/+10	100	100/-	100	+10
CH RTN/ENT	Previous channel	CH Enter	CH Enter	---
TOP MENU/ FAVORITE	---	---	---	Top Menu
GUIDE/ PIC SIZE	Selects the image shape.	Guide	---	---
ENTER/ENTER	Enter	Select	---	Enter
CLEAR/EXIT	Exit	Exit	---	Clear
▲▼/FAV▲▼	Menu select/ FAV▲▼	Menu select	---	Menu select
◀▶	Menu select	Menu select	---	Menu select
VOL▲▼	Volume up/down	TV Volume up/down	TV Volume up/down	TV Volume up/down
CH▲▼	Channel up/down	Channel up/down	Channel up/down	---
SLEEP	Sleep timer	---	---	---
MUTE	Sound mute	TV Sound mute	TV Sound mute	TV Sound mute
POP DIRECT CH	---	---	---	---
PLAY/SPLIT	---	---	Play	Play
STOP/SOURCE	---	---	Stop	Stop
PAUSE/FREEZE	Still picture	---	Pause	Pause
TV/VCR	---	---	TV/VCR	---
SKIP/SEARCH/ POP CH ▲▼	---	---	Search- +	Skip FWD/REV
FF/SWAP	---	---	Fast FWD	Fast FWD
REW/CH SCAN	---	---	Rewind	Rewind
REC	---	---	Record	---
LIGHT	Lights the remote keys.			

Note:

“---” sends no signal.

Learning about the remote control

The buttons used for operating the TV only are described here.

POWER turns the TV on and off.

Press POWER to turn on the TV. Press POWER again to turn off the TV (standby mode).

RECALL displays TV settings on-screen (page 50)

SLEEP sets the TV to turn off at a specific time (page 46)

TV/VIDEO selects the video input source (page 44)

MUTE reduces or turns off the sound (page 47)

Device Switch switches between TV, CBL/SAT, VCR, and DVD modes (pages 17–19). Set to “TV” to control the TV.

CH (channel) ▲ ▼ cycles through programmed channels (page 25)

Channel Numbers (0–9, 100) allow direct access to channels (page 25)

VOL (volume) ▲ ▼ adjusts the volume level

CH RTN switches between the last two viewed channels (page 26)

MENU opens the menu system (page 22)

ENTER activates the function settings in the menu or selects the next menu (page 22)

▲ ▼ ◀ ▶ (arrow buttons) select or adjust menu items (page 22)

FAV ▲ ▼ cycle through channels you programmed as favorite channels (page 27)

PIC SIZE cycles through the five picture sizes: Natural, TheaterWide1/2/3, and Full (page 29)

EXIT closes the menu system (page 22)

FREEZE freezes the picture. Press again to restore the moving picture.

LIGHT illuminates the keypad for five seconds

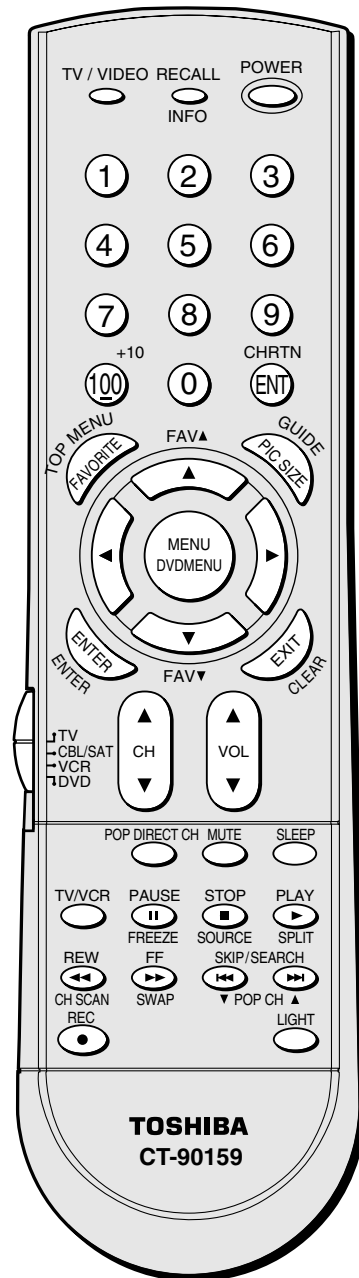

Note:

The error message “Not Available” will appear if you press a key for a function that is not available.

Setting up your TV

Learning about the menu system

After you have installed the batteries and programmed the remote control, you will need to set some preferences on the TV by using the menu system. You can access the menu system using the buttons on the TV or remote control.

1. Press MENU to display the menu system.
2. Press ◀ or ▶ to select a menu.
3. Press ▲ or ▼ to select an item.
4. Press ◀ or ▶ to select or adjust a setting.
5. Press ENTER to activate the settings or display the next menu.
6. To close the menu, press EXIT.

If you do not make a selection within 60 seconds, the menu display will close automatically.

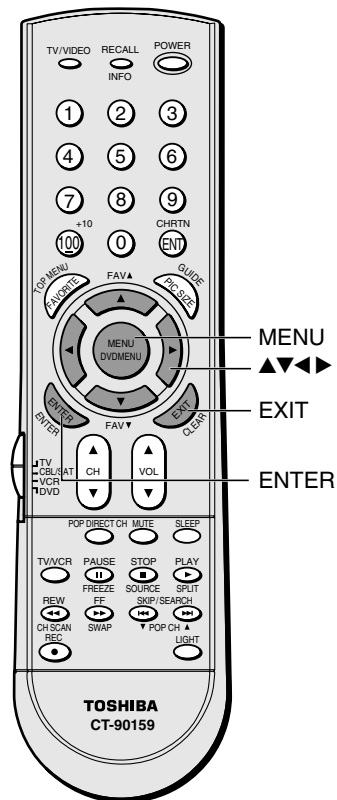
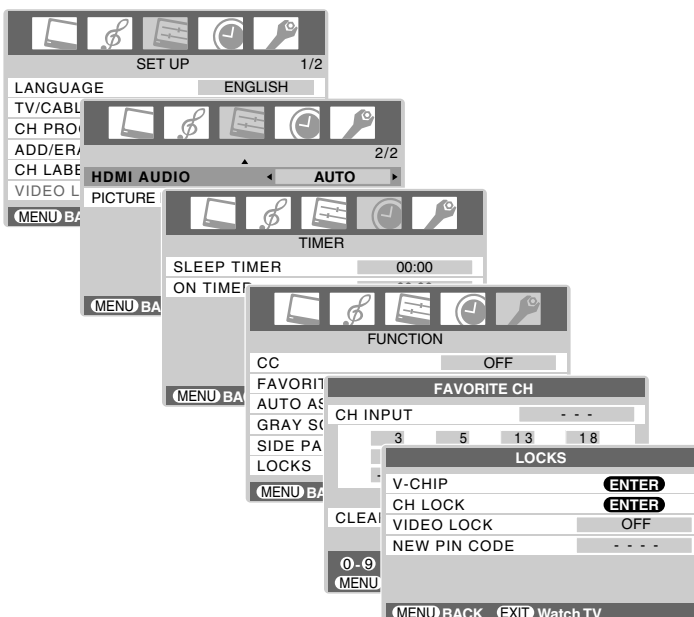
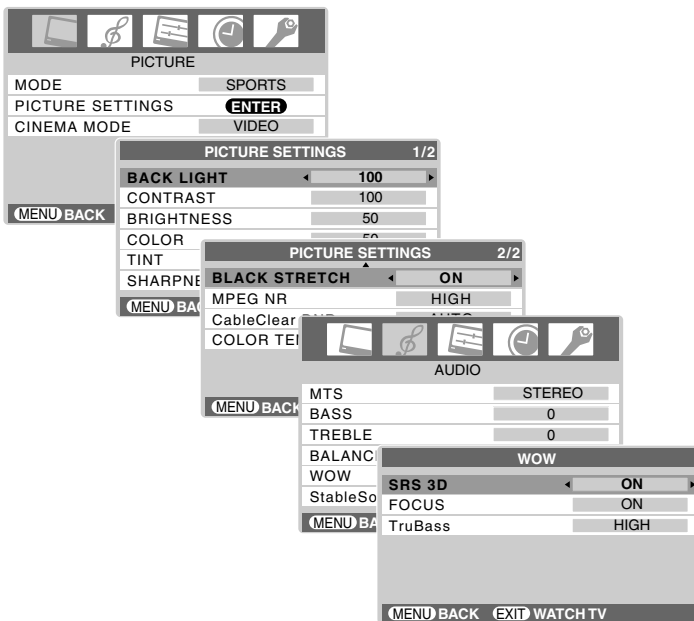
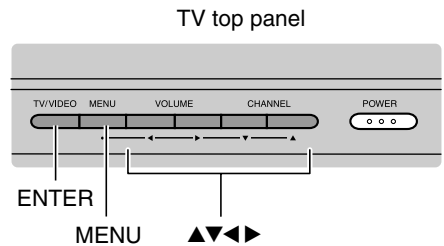

Changing the on-screen display language

You can choose from three different languages (English, French and Spanish) for the on-screen display of adjustment menus and messages.

To select a language:

1. Press MENU, and then press ◀ or ▶ until the SET UP menu appears.
2. Press ▲ or ▼ to highlight LANGUAGE.

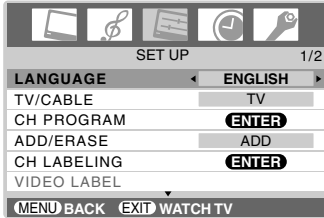

3. Press ◀ or ▶ to display your desired language.

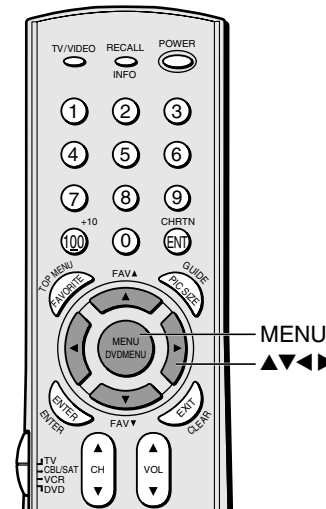
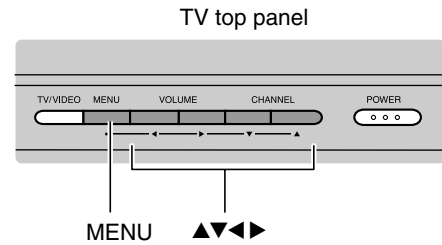

Adding channels to the TV's memory

When you press Channel ▲ or ▼, your TV will stop only on the channels you program into the TV's channel memory.

Follow the steps below and on the next page to program all active channels into the TV's memory.

Programming channels automatically

Your TV can automatically detect all active channels in your area and store them in the channel memory. After the channels are programmed automatically, you can manually add or erase individual channels (see page 25).

To program channels automatically:

1. Press MENU, and then press ◀ or ▶ until the SET UP menu appears.
2. Press ▲ or ▼ to highlight TV/CABLE.
3. Press ◀ or ▶ to select either TV (if you use an antenna) or CABLE (if you use cable channels).

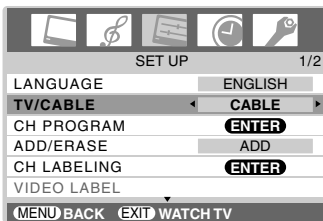

4. Press ▼ to select CH PROGRAM.

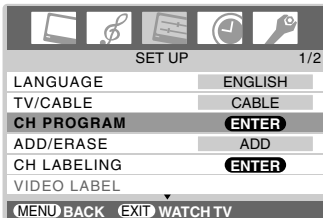

5. Press ENTER to start channel programming. The TV will automatically cycle through all the TV or Cable channels (depending on which you selected), and store all active channels in the channel memory.

While the TV is cycling through the channels, the message "Programming Now—Please Wait" appears.

6. When channel programming is complete, the message "Completed" appears.
7. Press Channel ▲ or ▼ to view the programmed channels.

Note:

To tune the TV to a channel not programmed in the channel memory, you must use the Channel Number buttons on the remote control.

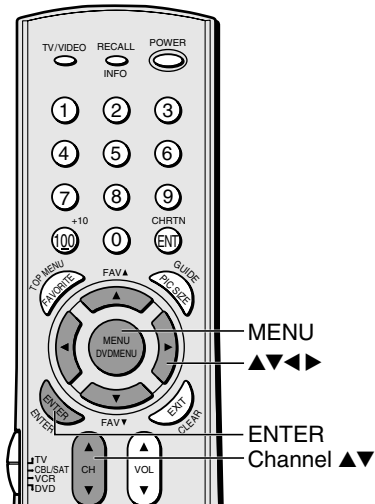

Adding and erasing channels manually

After you have automatically programmed the active channels into the TV's channel memory, you can manually add or erase specific channels.

To manually add or erase channels:

1. Select the channel you want to add or erase. If you are adding a channel, you must select the channel using the Channel Number buttons.
2. Press MENU, and then press ◀ or ▶ until the SET UP menu appears.
3. Press ▲ or ▼ to highlight ADD/ERASE.

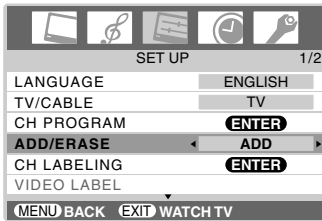

4. Press ◀ or ▶ to select ADD or ERASE, depending on the function you want to perform.
5. Repeat steps 1–4 for other channels you want to add or erase.

Changing channels

To change to a specific channel (programmed or unprogrammed):

Press the Channel Number buttons (0–9 and 100).

For channels 100 and higher, press the 100 button, and then the next two numbers. For example, to select channel 125, press 100, 2, 5.

To change to the next programmed channel:

Press Channel ▲ or ▼ on the TV or remote control.

To use the Program list to change to a specific programmed channel (or video mode):

Press ENTER to display the Program list, and then press ▲ or ▼ to scroll through the Program list. When the desired channel number (or video mode) is highlighted, press ENTER.

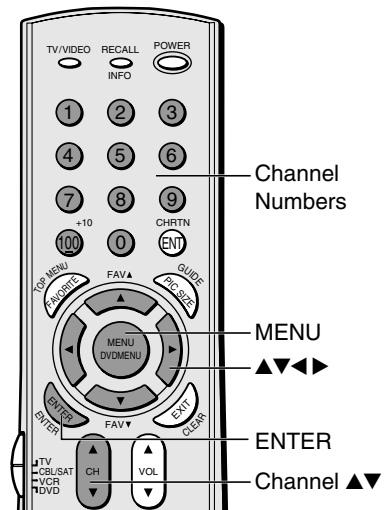
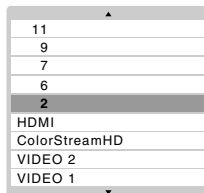

Using the TV's features

Adjusting the channel settings

Switching between two channels using Channel Return

The Channel Return feature allows you to switch between two channels without entering an actual channel number each time.

To switch between two channels:

1. Select the first channel (or video mode) you want to view.
2. Select a second channel using the Channel Number buttons (0–9, 100).
3. Press CH RTN. The previous channel will be displayed.

Each time you press CH RTN, the TV will switch back and forth between the last two channels that were selected.

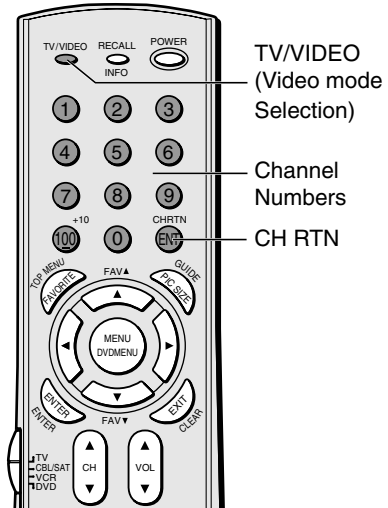

Programming your favorite channels

You can preset up to 12 of your favorite channels using the Favorite Channel Programming feature. Because this feature scans through only your favorite channels, it allows you to skip other channels you do not normally watch.

To program your favorite channels:

1. Press MENU, and then press ◀ or ▶ until the FUNCTION menu appears.
2. Press ▲ or ▼ to highlight FAVORITE CH.

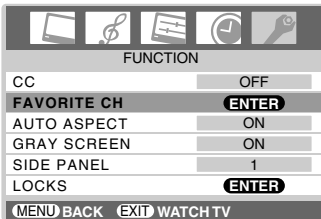

3. Press ENTER to display the FAVORITE CH menu. CH INPUT will be highlighted.

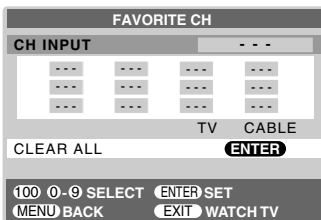

4. Press the Channel Number buttons to enter one of your favorite channels.
5. Press ENTER.
6. Repeat steps 4 and 5 for your other favorite channels.

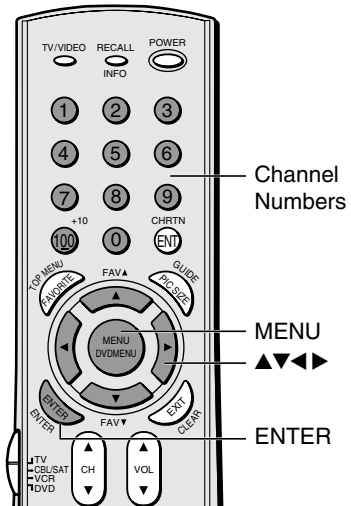

To select your favorite channels:

Press FAV ▲ or ▼.

To clear a favorite channel:

1. Press MENU, and then press ◀ or ▶ until the FUNCTION menu appears.
2. Press ▲ or ▼ to highlight FAVORITE CH.
3. Press ENTER to display the FAVORITE CH menu.

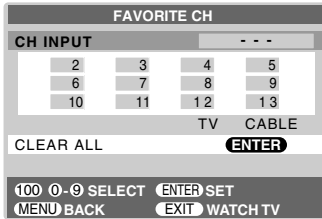

4. Press ▲▼◀▶ to highlight the channel you want to clear, then press ENTER.

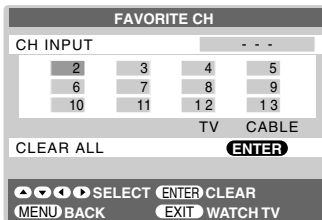

5. Repeat step 4 for other favorite channels you want to clear.

To clear all favorite channels at once:

Press ▲ or ▼ to highlight CLEAR ALL in step 4 above, and then press ENTER to clear all favorite channels at once.

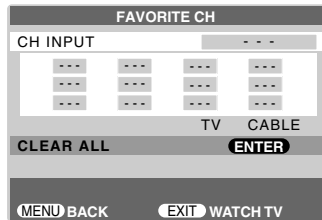

Note:

The FAV ▲▼ buttons operate as MENU ▼▲ buttons when a menu is on-screen.

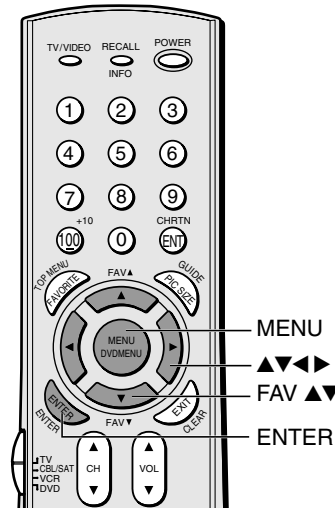

Labeling channels

Channel labels appear above the on-screen channel number display each time you turn on the TV, change a channel, or press **RECALL**. You can choose any four characters to identify a channel.

To create channel labels:

1. Press **MENU**, and then press **◀** or **▶** until the **SET UP** menu appears.
2. Press **▲** or **▼** to highlight **CH LABELING**.

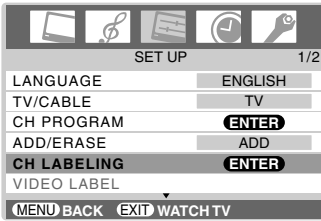

3. Press **ENTER** to display the **CH LABELING** menu.
4. Press **▲** or **▼** or Channel Number buttons to select a channel you want to label.

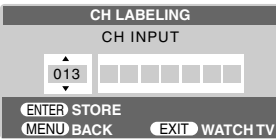

5. Press **▶** to select a character for the first space, and then press **▲** or **▼** repeatedly to select a character.

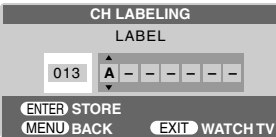

6. Repeat step 5 to enter the rest of the characters.
If you would like a blank space in the label name, you must choose an empty space from the list of characters. Otherwise, a dash “-” will appear in that space.
7. Repeat steps 4–6 to label other channels.
8. Press **ENTER** to store your settings.

To erase channel labels:

Select blanks in steps 5 and 6 above.

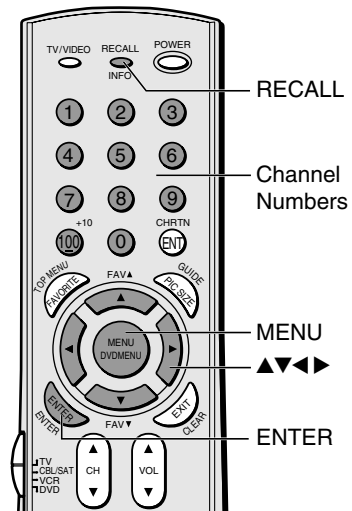

Viewing the wide-screen picture formats

You can view 480i, 480p, 720p, and 1080i format programs in a variety of picture sizes—NATURAL, TheaterWide 1, TheaterWide 2, TheaterWide 3, and FULL.

The way the image displays in any of the picture sizes will vary depending on the format of the program you are viewing. Select the picture size that displays the current program the way that looks best to you.

Picture size \ Signal	NATURAL	Theater Wide 1	Theater Wide 2	Theater Wide 3	FULL
480i	yes	yes	yes	yes	yes
480p	yes	yes	yes	yes	yes
720p	yes (Full)	yes	yes	yes	no
1080i	yes (Full)	yes	yes	yes	no

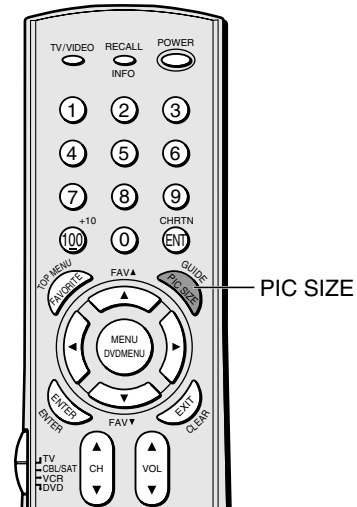

Selecting the picture size

Press PIC SIZE on the remote control repeatedly to select the desired picture size, as described below and on the next page.

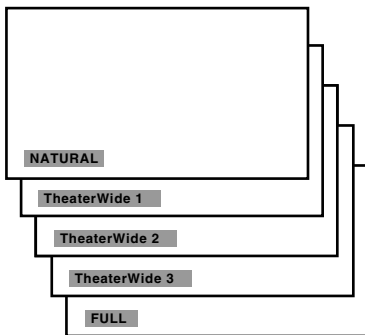

NATURAL picture size

- The image is displayed close to its originally formatted proportion. Some program formats will display with side bars and/or bars at the top and bottom.

Natural picture size example: The way the image displays will vary depending on the format of the program you are currently watching.

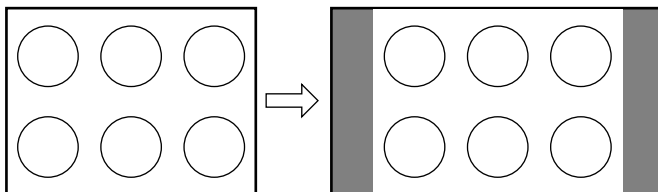

Conventional picture on a conventional TV screen

Conventional picture in Natural size on your wide-screen TV

(continued on next page)

TheaterWide 1 picture size (For 4:3 format programs)

- The picture is non-uniformly enlarged—the center of the picture remains close to its original proportion, but the left and right edges are stretched wider to fill the screen.
- A small part of the picture at the top and bottom is hidden.

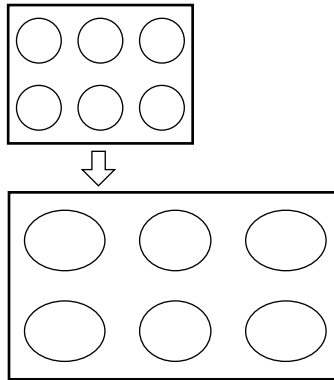

TheaterWide 1 picture size example

TheaterWide 2 picture size (For Letter box programs)

- The entire picture is uniformly enlarged—it is stretched the same amount both wider and taller (retains its original proportion).
- Part of the picture at the top and bottom is hidden.

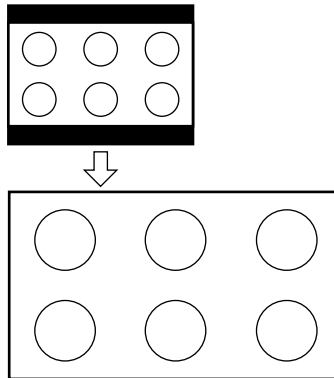

TheaterWide 2 picture size example

TheaterWide 3 picture size (For Letter box programs with subtitles)

- The picture is non-uniformly enlarged—The picture is stretched wider to fill the width of the screen, but only slightly stretched taller.
- A small part of the picture at the top and bottom is hidden.

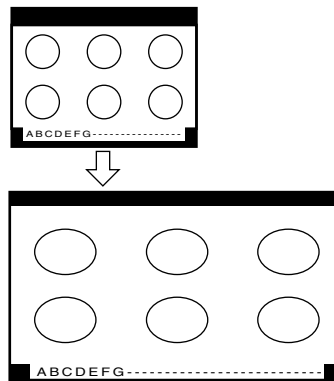

TheaterWide 3 picture size example

Note:

Using these functions to change the picture size (i.e., changing the height/width ratio) for any purpose other than your private viewing may be prohibited under the Copyright Laws of the United States and other countries, and may subject you to civil and criminal liability.

FULL picture size (For 16:9 format programs)

- If you are receiving a 4:3 format program, the picture is stretched wider to fill the width of the screen, but not stretched taller.
- None of the picture is hidden.

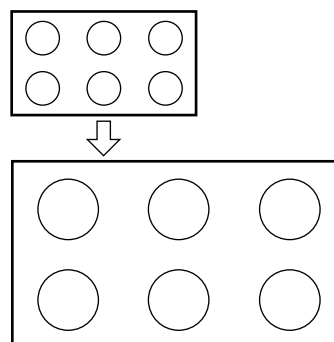

FULL picture size example

Adjusting the PICTURE POSITION

1. Press MENU, and then press ◀ or ▶ until the SET UP menu appears.
2. Press ▲ or ▼ to highlight PICTURE POSITION, and then press ENTER.
The PICTURE POSITION menu appears.

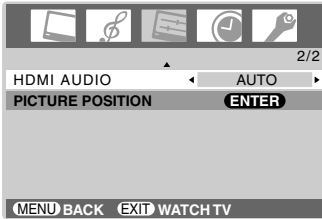

3. Press ▲ or ▼ to highlight the item you want to adjust.

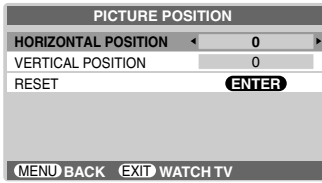

4. Press ◀ or ▶ to adjust the settings as required.



- The display will return to the previous menu after 4 seconds if no button is pressed.

Selection	Pressing	
	◀	▶
HORIZONTAL POSITION	To move to the left	To move to the right
VERTICAL POSITION	To move downwards	To move upwards

To reset to the factory-set status:

Select RESET in the PICTURE POSITION menu, and then press ENTER.

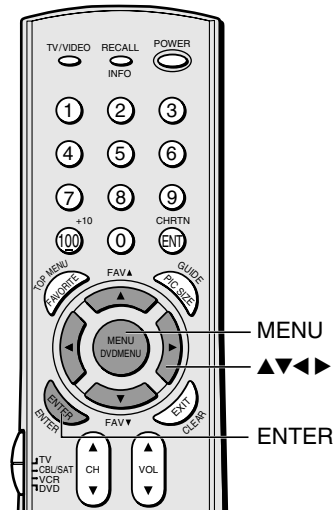

Note:

You can adjust the HORIZONTAL POSITION and VERTICAL POSITION in TheaterWide 1, 2, or 3 mode only.

Using the AUTO ASPECT feature

When the AUTO ASPECT feature is set to on and the TV receives a 480i signal, the picture size is automatically selected (as described in the following table).

Aspect ratio of signal source	Automatic aspect size (automatically selected when AUTO ASPECT is ON)
4:3 Normal	Natural
16:9 Full	Full
4:3 Letter box	TheaterWide 2
Not defined (no ID-1 data)*	User-set mode

*If the signal does not include aspect information, the picture size you selected on pages 29–30 is displayed.

To turn on the AUTO ASPECT feature:

1. Press MENU, and then press ◀ or ▶ until the FUNCTION menu appears.

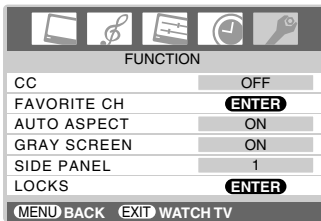

2. Press ▲ or ▼ to highlight AUTO ASPECT.

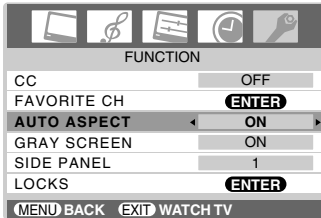

3. Press ◀ or ▶ to select ON.

Note:

The AUTO ASPECT feature is available for additional formats when viewing HDMI sources because AUTO ASPECT operates based on information found in the digital HDMI signal (not ID-1 signal).

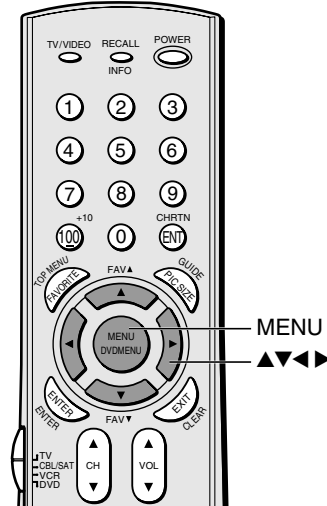

Setting the HDMI audio mode

1. Press MENU, and then press ◀ or ▶ until the SET UP menu appears.
2. Press ▼ or ▲ to highlight HDMI AUDIO.
3. Press ◀ or ▶ to select HDMI audio mode from AUTO, DIGITAL, or ANALOG (AUTO is recommended). See “Connecting an HDMI™ or a DVI device to the HDMI input” on page 15.

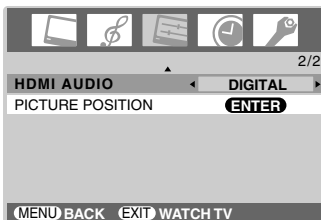

Using the gray screen function

With the gray screen function ON, the screen will automatically turn gray and the sound will be muted when no signal is being received.

To turn on the gray screen function:

1. Press MENU, and then press ◀ or ▶ until the FUNCTION menu appears.
2. Press ▲ or ▼ to highlight GRAY SCREEN.
3. Press ◀ or ▶ to select ON.

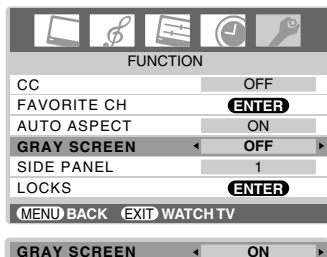

To turn off the gray screen function:

Select OFF in step 3 above.

Selecting the gray level of the side panels

You can select the gray level of the side panels in 4:3 mode.

To select the gray level:

1. Press MENU, and then press ◀ or ▶ until the FUNCTION menu appears.
2. Press ▲ or ▼ to highlight SIDE PANEL.

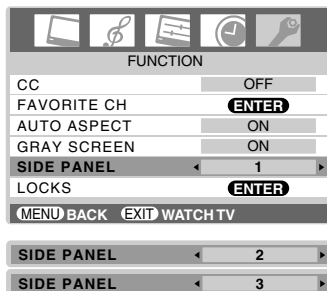

3. Press ◀ or ▶ to select the desired gray level from 1, 2 or 3.
 - 1: Dark gray
 - 2: Mid gray
 - 3: Light gray

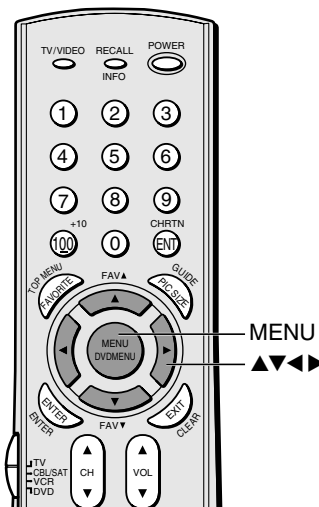

Using the LOCKS menu

The LOCKS menu includes the V-Chip, CH Lock, Video Lock, and New PIN Code functions. You can use these functions after entering the correct PIN code.

Entering the PIN code

1. Press MENU, and then press ◀ or ▶ until the FUNCTION menu appears.
2. Press ▲ or ▼ to highlight LOCKS, and then press ENTER. The LOCKS menu appears.

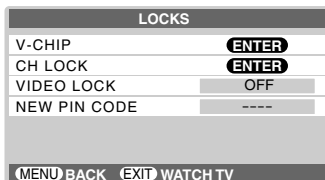

3. Press ▲ or ▼ to highlight V-CHIP, and then press ENTER to display the PIN code entering mode.
 - Blocking Reset status: Set a new 4-digit code by pressing the Number buttons (0–9).
 - When the PIN code is already stored: Press the Number buttons (0–9) to enter your 4-digit PIN code.



If the wrong PIN code is entered, the message “Incorrect” appears. Enter the code again, and then press ENTER.

If you cannot remember your PIN code

1. While the PIN code entering screen is displayed, press RECALL four times within five seconds. The PIN code will be released (Blocking Reset status restored).
2. Set a new 4-digit code, and then press ENTER. The LOCKS menu appears.

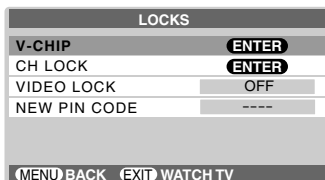

Continue to set each item following the steps on page 35.

Using the V-CHIP menu

Some TV programs and movies include signals that classify the content of the program (violence, sex, dialog, language). The V-CHIP control feature in this TV detects the signals and blocks the programs according to your selections. To use this feature, perform the following setup.

Note:

The V-Chip function is available for the U.S. V-Chip system only. The Canadian V-Chip system is not supported.

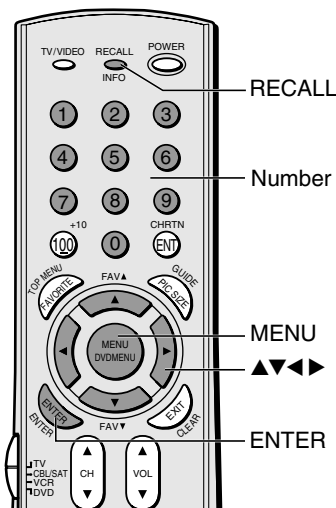

ENABLE BLOCKING

- From the LOCKS menu, press ▼ or ▲ to highlight V-CHIP, and then press ENTER.
The V-CHIP menu appears.
- Press ▼ or ▲ to highlight ENABLE BLOCKING.

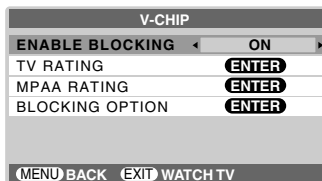

- Press ◀ or ▶ to select ON or OFF.
ON : To enable your setting (Lock)
OFF: To release your setting (Unlock)

Note: The CH LOCK function is not affected by this setting.

TV RATING (Independent rating system for broadcasters)

- From the V-CHIP menu, press ▼ or ▲ to highlight TV RATING, and then press ENTER.
The TV RATING menu appears.
- Press ▼ or ▲ to select an item.
- Press ▶ to lock (displays "X").
Press ◀ to unlock (displays "✓").
- Repeat steps 2 and 3 to set the next item.



The TV age-based ratings and content themes you can lock are listed in the table below.

Ratings	Description and Content themes
MA	Mature Audience Only (This program is specifically designed to be viewed by adults and therefore may be unsuitable for children under 17.) L) Crude or indecent language S) Explicit sexual activity V) Graphic violence
14	Parents Strongly Cautioned (This program contains some material that many parents would find unsuitable for children under 14 years of age.) D) Intensely suggestive dialog L) Strong, coarse language S) Intense sexual situations V) Intense violence
PG	Parental Guidance Suggested (This program contains material that parents may find unsuitable for younger children.) D) Some suggestive dialog L) Infrequent coarse language S) Some sexual situations V) Moderate violence
G	General Audience (Most parents would find this program suitable for all ages.)
Y7, Y7FV	Directed to Older Children (This program is designed for children age 7 and above. Note: Programs in which fantasy violence may be more intense or more combative than other programs in this category are designated Y7FV.)
Y	All Children (This program is designed to be appropriate for all children.)

LOCKS menu

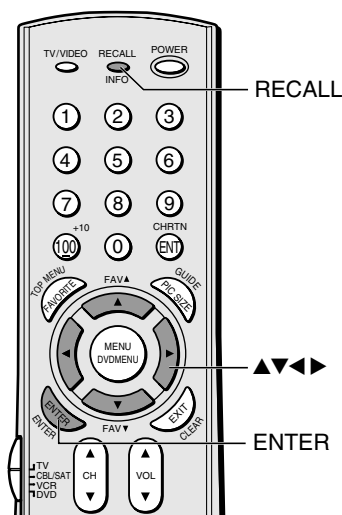
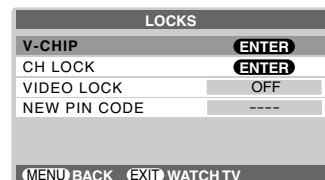

Press RECALL to display the rating of the TV program you are currently watching.

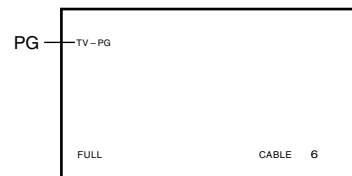

MPAA RATING (Independent rating system for movies)

- From the V-CHIP menu, press ▼ or ▲ to highlight MPAA RATING, and then press ENTER. The MPAA RATING menu appears.
- Press ► to lock (“X”) or press ◀ to unlock (“✓”).

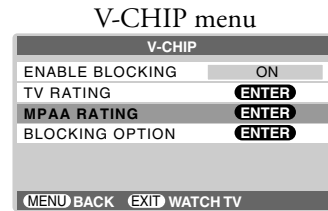
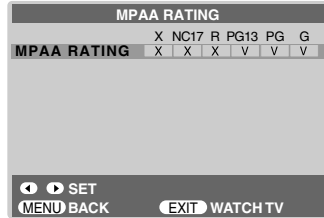

The movie ratings you can lock are described as follows:

- X : X-rated (For adults only)
- NC17: Not intended for anyone 17 and under
- R : Restricted (Under 17 requires accompanying parent or adult guardian.)
- PG13 : Parents Strongly Cautioned (Some material may be inappropriate for children under 13.)
- PG : Parental Guidance Suggested (Some material may not be suitable for children.)
- G : General Audience (Appropriate for all ages)

BLOCKING OPTION

- From the V-CHIP menu, press ▼ or ▲ to highlight BLOCKING OPTION, and then press ENTER. The BLOCKING OPTION menu appears.
- Press ▲ or ▼ to select an item.

MPAA UNRATED :

- Highlight MPAA UNRATED.
- Press ◀ or ► to select ON (Lock) or OFF (Unlock) for unrated programs in the MPAA rating system.

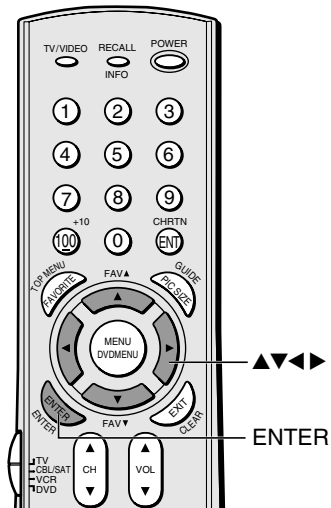
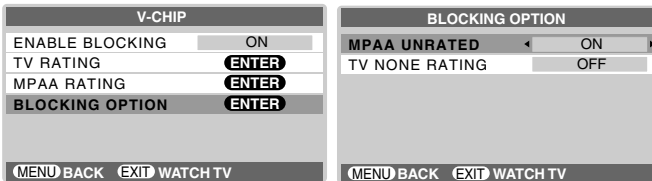

TV NONE RATING :

- Highlight TV NONE RATING.
- Press ◀ or ► to select ON (Lock) or OFF (Unlock) for programs rated NONE in the TV PARENTAL GUIDELINES.

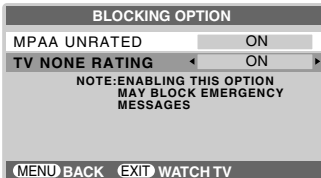

Caution:

Be aware that setting the TV None Rating to ON may block the broadcast of emergency information. The menu will display the note, “Enabling this option may block emergency messages” to warn you of this possibility.

Unlocking programs temporarily

1. If you try to watch a TV program that exceeds the rating limits you set, the TV enters program lock mode. You can either unlock the program temporarily (see steps 2–4 below) or select an unlocked program to watch.

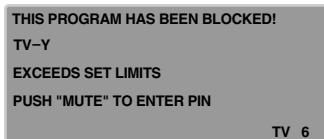

2. To temporarily unlock the program, press MUTE while the message is on the screen.
3. Press the Number buttons (0–9) to enter your 4-digit PIN code.

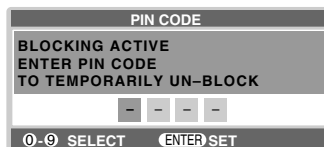

4. Press ENTER.

If the correct code is entered, the program lock mode is released and the normal picture appears.

All locking is disabled until the TV is turned off, and will be enabled when the TV is turned on again.

Locking channels

With the CH LOCK feature, you can lock specific channels. You will not be able to tune locked channels with the Channel \blacktriangle \blacktriangledown buttons or Channel Number buttons unless you clear the setting.

You can lock a maximum of twelve channels.

To lock channels:

1. From the LOCKS menu, press \blacktriangle or \blacktriangledown to highlight CH LOCK, and then press ENTER.

The CH LOCK menu appears, and CH INPUT will be highlighted.
2. Press the Channel Number buttons to enter the channel you want to lock.
3. Press ENTER.

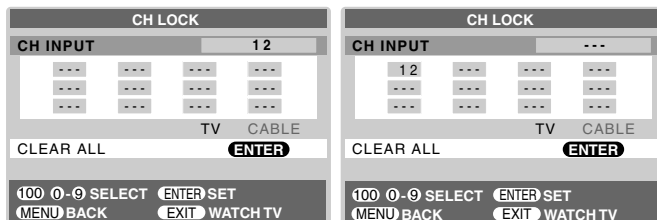

4. Repeat steps 2 and 3 for other channels.

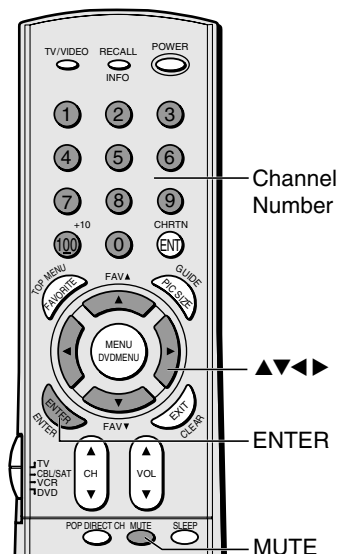

LOCKS menu

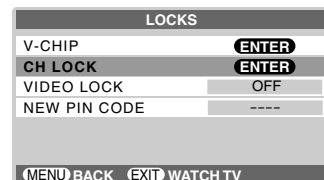

Note:

After programming CH Lock, change the channel before turning off the TV.

To unlock individual channels:

1. From the LOCKS menu, press ▲ or ▼ to highlight CH LOCK, then press ENTER.

The CH LOCK menu appears.

2. Press ▲▼◀▶ to highlight the channel you want to unlock, and then press ENTER.

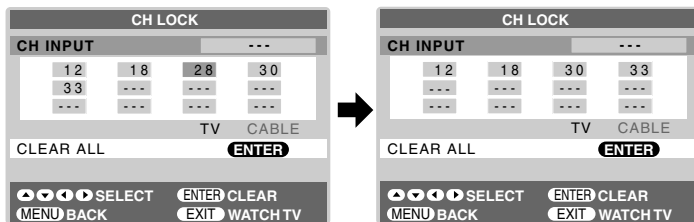

3. Repeat step 2 for other channels.

To unlock all locked channels at once:

Press ▲ or ▼ to highlight CLEAR ALL, and then press ENTER.

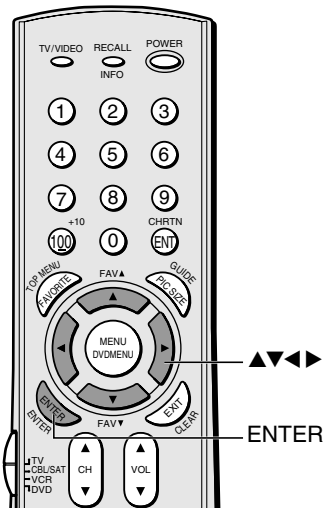
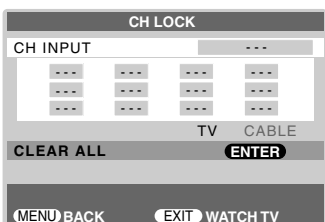

Locking the video inputs

With the VIDEO LOCK feature, you can lock the input sources (Video 1, Video 2, ColorStream HD, HDMI) and channels 3 and 4. You will not be able to select the input sources with the TV/VIDEO button or Channel buttons unless you clear the setting.

To set up the video lock:

1. From the Locks menu, press ▲ or ▼ to highlight VIDEO LOCK.
2. Press ◀ or ▶ to highlight the level of video locking you want (Video, Video+, or Off), as follows:
OFF : Unlocks all video input sources.
VIDEO : Locks Video 1, Video 2, ColorStream HD, and HDMI.
VIDEO+ : Locks Video 1, Video 2, ColorStream HD, HDMI, and channels 3 and 4. This option should be used if you use the antenna terminal to play a video tape.

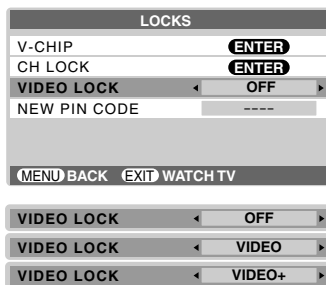

3. To close the menu, press EXIT.

Changing the PIN code

1. From the LOCKS menu, press ▲ or ▼ to highlight NEW PIN CODE.
2. Press the Number buttons (0–9) to enter a 4-digit code. The numbers you enter will replace the dashes in the display.

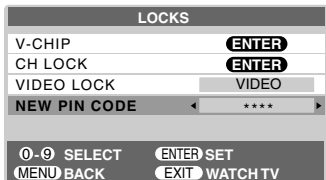

3. Press ENTER. The New PIN Code is now active.

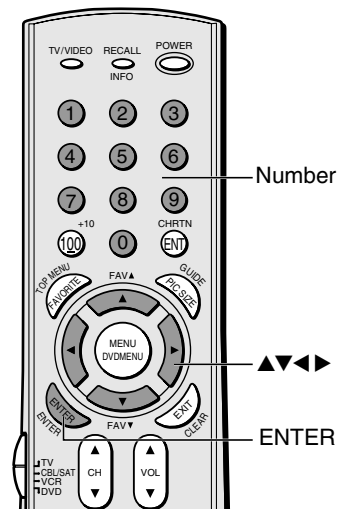
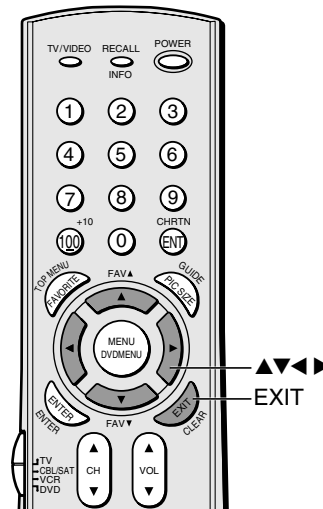

Adjusting the picture

Selecting the picture mode

You can select your desired picture type from four picture modes: Sports, Standard, Movie, and Preference.

Mode	Picture Quality
Sports	Bright and dynamic picture (factory setting)
Standard	Standard picture setting (factory setting)
Movie	Movie-like picture setting (factory setting)
Preference	Your personal preferences

To select the picture mode:

1. Press MENU, and then press ◀ or ▶ until the PICTURE menu appears.
2. Press ▼ or ▲ to highlight MODE.

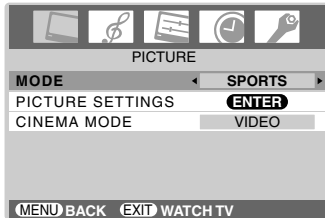

3. Press ◀ or ▶ to select the mode you prefer.

Adjusting the back light feature

You can use the BACK LIGHT feature to adjust the screen brightness for improved picture clarity.

To adjust the back light:

1. Press MENU, and then press ◀ or ▶ until the PICTURE menu appears.
2. Press ▼ or ▲ to highlight PICTURE SETTINGS, then press ENTER. The PICTURE SETTINGS menu appears.
3. Press ▲ or ▼ to highlight BACK LIGHT.

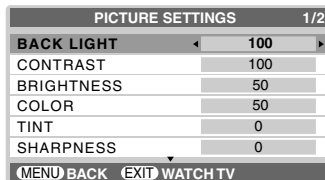

4. Press ◀ or ▶ to adjust the screen brightness (0–100).



Note:

If you select one of the factory-set picture modes (SPORTS, STANDARD, or MOVIE) and then change a picture quality setting (for example, increase the contrast), the picture mode automatically changes to PREFERENCE in the Picture menu.

TV top panel

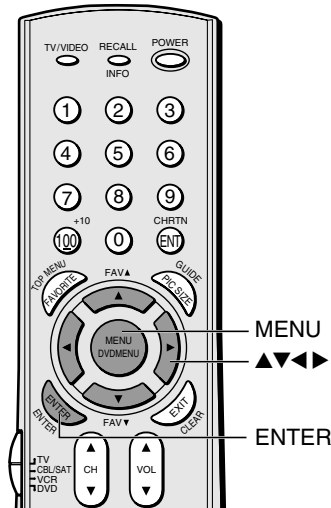
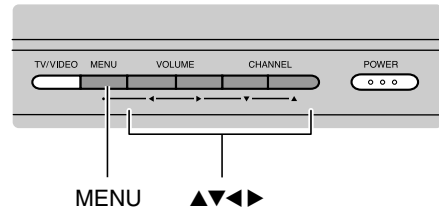

Note:

The cold cathode fluorescent lamp used for the back light on this TV has a limited life. When areas on the screen darken, flicker, or no longer light up, the lamp may be at the end of its life.

Adjusting the picture quality

You can adjust the picture quality to your personal preferences, including the back light, contrast, brightness, color, tint, sharpness, Black stretch, and color temperature.

Selection	◀ Pressing	▶	
back light	darker	lighter	
contrast	lower	higher	
brightness	darker	lighter	
color	paler	deeper	
tint	reddish	greenish	
sharpness	softer	sharper	
Black stretch	On/Off	Off/On	
color temperature	cool	medium	warm

To adjust the picture quality:

1. Press MENU, and then press ◀ or ▶ until the PICTURE menu appears.
2. Press ▼ or ▲ to highlight PICTURE SETTINGS, then press ENTER.
The PICTURE SETTINGS menu appears.
3. Press ▲ or ▼ until the item you want to adjust is highlighted.
4. Press ◀ or ▶ to adjust the level.

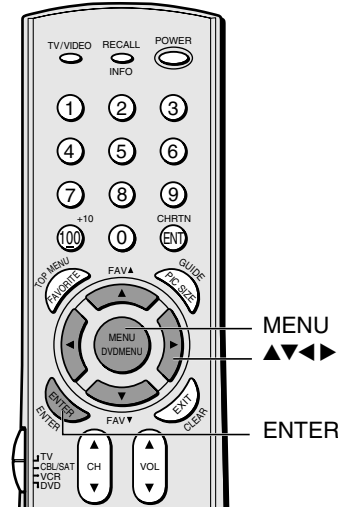
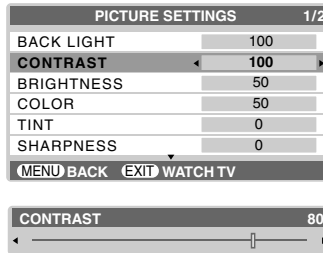

The PICTURE qualities you adjusted will be saved in the TV's memory (in the PICTURE menu PREFERENCE mode). You can select the PREFERENCE MODE (your settings) or choose factory-set modes, as described under "Selecting the picture mode" on page 40.

Using the Black stretch feature

You can use the Black stretch feature to correct the contrast balance in the black areas of the picture. The effect depends on the quality of the video signal.

To turn on the Black stretch feature:

1. Press MENU, and then press ◀ or ▶ until the PICTURE menu appears.
2. Press ▲ or ▼ to highlight PICTURE SETTINGS, and then press ENTER.
The PICTURE SETTINGS menu appears.
3. Press ▲ or ▼ to highlight BLACK STRETCH.

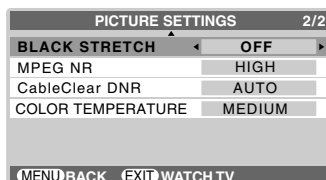

4. Press ◀ or ▶ to select ON.



To turn off the Black stretch feature:
Select OFF in step 4 above.

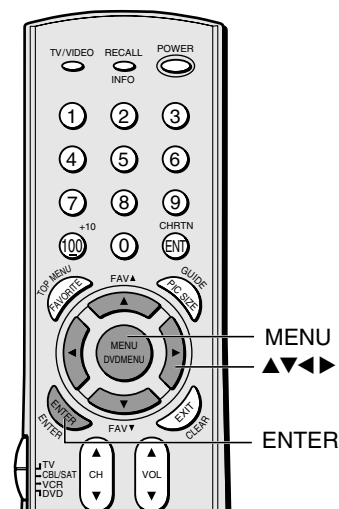

Using the MPEG NR feature

The MPEG NR (noise reduction) feature allows you to reduce visible interference caused by MPEG compression.

1. Press MENU, and then press ◀ or ▶ until the PICTURE menu appears.
2. Press ▲ or ▼ to highlight PICTURE SETTINGS, and then press ENTER.
The PICTURE SETTINGS menu appears.
3. Press ▲ or ▼ to highlight MPEG NR.

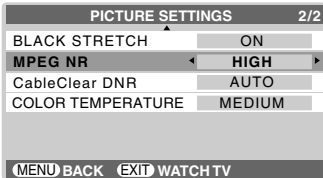

4. Press ◀ or ▶ to select LOW, MIDDLE, HIGH, or OFF.



Using the CableClear® DNR feature

CableClear® DNR reduces visible interference in your TV picture. This is useful when receiving a broadcast with a weak signal or playing a video cassette or disc damaged by repeated use.

To turn on CableClear DNR:

1. Press MENU, and then press ◀ or ▶ until the PICTURE menu appears.
2. Press ▲ or ▼ to highlight PICTURE SETTINGS, and then press ENTER.
The PICTURE SETTINGS menu appears.
3. Press ▲ or ▼ to highlight CableClear DNR.

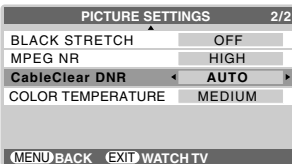

4. Press ◀ or ▶ to select LOW, MIDDLE, HIGH, or AUTO.



To turn off CableClear DNR:

Select OFF in step 4 above.

Note:

The MPEG NR feature is enabled for 480i signals only.

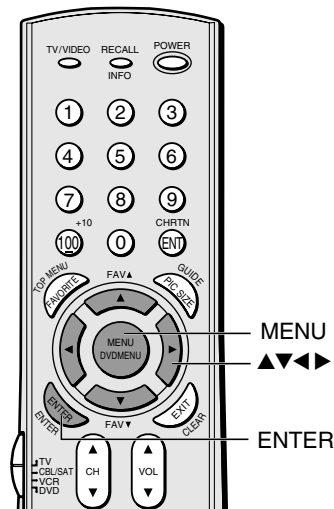

Note:

- The CableClear® DNR feature works with 480i input sources only.
- When the TV is in ColorStream or HDMI mode, the words "CableClear DNR" will change to "DNR" in the menu.
- DNR is not selectable in HDMI mode.

Selecting the color temperature

You can change the quality of the picture by selecting from three preset color temperatures: cool, medium, and warm.

To select the color temperature:

1. Press MENU, and then press ◀ or ▶ until the PICTURE menu appears.
2. Press ▲ or ▼ to highlight PICTURE SETTINGS, and then press ENTER.

The PICTURE SETTINGS menu appears.

3. Press ▲ or ▼ to highlight COLOR TEMPERATURE.

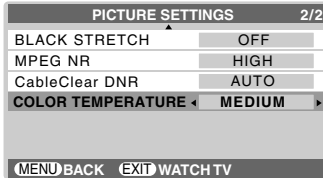

4. Press ◀ or ▶ to select the mode you prefer, as described in the following table.

Mode	Picture Quality
cool	bluish
medium	neutral
warm	reddish

Selecting the cinema mode

When you view a DVD movie (3:2 pulldown processed) from a DVD player connected to the ColorStream (component video) inputs on the TV, smoother and more natural motion can be obtained by setting the CINEMA MODE to FILM.

To set the CINEMA MODE to FILM:

1. Press MENU, and then press ◀ or ▶ until the PICTURE menu appears.
2. Press ▲ or ▼ to highlight CINEMA MODE.
3. Press ◀ or ▶ to select FILM.

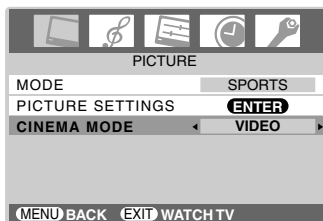

To turn off the CINEMA MODE:

Press ◀ or ▶ to select VIDEO in step 3 above.

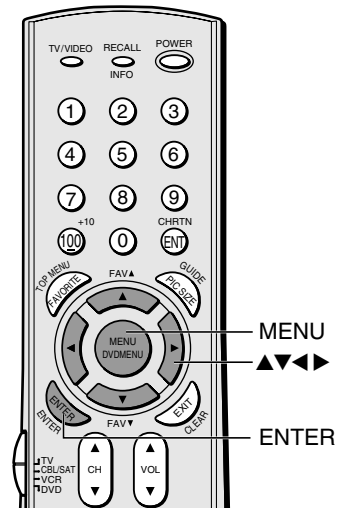

Selecting the video input source

Press TV/VIDEO on the remote control or the TV top panel to view a signal from another device connected to your TV, such as a VCR or DVD player. You can select VIDEO 1, VIDEO 2, ColorStream HD, HDMI, or Antenna/Cable channel depending on which input jacks you used to connect your devices (see “Connecting your TV” on page 9).

To select the video input source using the program list:

1. Press and hold TV/VIDEO for a few seconds to display the program list.

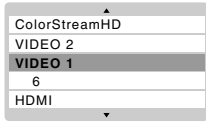

2. Repeatedly press or hold TV/VIDEO or ▲ or ▼ while the program list is on-screen to scroll through the program list.
3. When your desired video input mode is highlighted, press ENTER.

Labeling the video input sources

The video label feature allows you to label each input source for your TV from the following preset list of labels:

- : Uses the default label name
- VCR : Video cassette recorder
- DVD : DVD video
- DTV : Digital TV set-top box
- SAT : Satellite box
- CBL : Cable box

To label the video input sources:

1. Press TV/VIDEO to select the video source you want to label.
2. Press MENU, and then press ◀ or ▶ until the SET UP menu appears.
3. Press ▲ or ▼ to highlight VIDEO LABEL.
4. Press ENTER to display the VIDEO LABEL menu.
5. Press ▶ to select a character for the first space.
6. Press ▲ or ▼ to select the desired character.
7. Repeat steps 5 and 6 to enter the rest of the characters.
8. Finish labeling the other video input sources as desired.
9. Press ENTER to store your settings.
10. To return to the previous menu, press MENU.
11. To exit the menu, press EXIT.

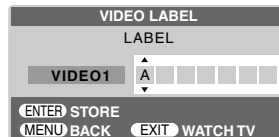
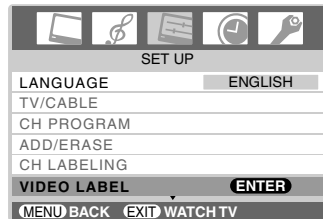

Note:

When HDMI or ColorStream HD is selected, the VIDEO OUT jack does not output a signal. To receive a VIDEO OUT signal, you must use a standard video or S-video IN connection.

Please note the following regarding the HDMI source selection:

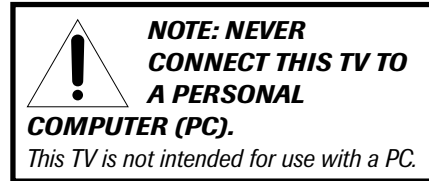

See “Connecting an HDMI or a DVI device to the HDMI input” on page 15 for details.

TV top panel

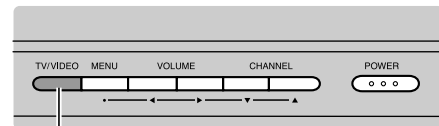

TV/VIDEO

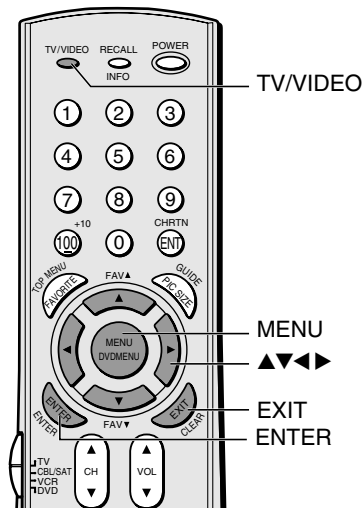

Using the closed caption feature

The closed caption feature has two options:

- Captions—An on-screen display of the dialogue, narration, and sound effects of TV programs and videos that are closed captioned (usually designated as “CC” in program listings).
- Text—An on-screen display of information not related to the current program, such as weather or stock data (when provided by individual stations).

To view captions or text:

1. Tune the TV to the desired program.
2. Press MENU, and then press ◀ or ▶ to display the FUNCTION menu.
3. Press ▲ or ▼ to highlight CC.

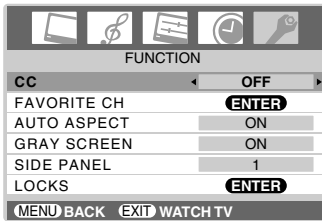

4. Press ◀ or ▶ to highlight C1-C4 or T1-T4.

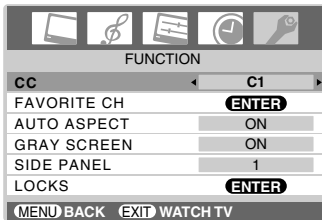

- To view captions, highlight C1, C2, C3, or C4 (C1 displays captions in the primary language in your area).

Note: If the program or video you selected is not closed captioned, the captions will not display on the screen.



- To view text, highlight T1, T2, T3, or T4.

Note: If text is not available in your area, a black rectangle may appear on your screen. If this happens, turn the Closed Caption feature OFF.

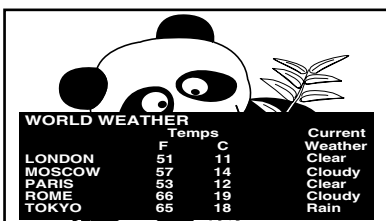

To turn off the Closed Caption feature:
Highlight OFF in step 4.

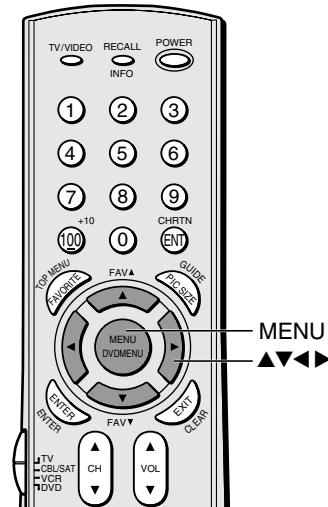

Note:

A closed caption signal may not display in the following situations:

- When a videotape has been dubbed
- When the signal reception is weak
- When the signal reception is nonstandard

Setting the sleep timer

To use the remote control to set the sleep timer to turn off the TV automatically:

1. Press SLEEP to set the length of time until the TV turns off.



Every time you press SLEEP, the time display will increase by 10 minutes, up to 3 hours.

00h00m → 00h10m → 00h20m → ... → 02h50m → 03h00m → 00h00m

To cancel the sleep timer:

Press SLEEP until it is set to 00h00m.

To use the menu system to set the sleep timer:

1. Press MENU, and then press ◀ or ▶ until the TIMER menu appears.
2. Press ▲ or ▼ to highlight SLEEP TIMER.
3. Press the Number buttons (0–9) or ◀ or ▶ button to enter the length of time until the TV turns off automatically.
4. Press EXIT to start the timer.

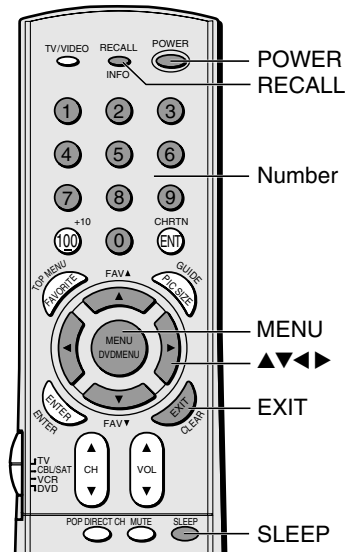

Note:

- When an instant power failure occurs, the ON timer and sleep timer settings may be cleared.
- To display the amount of time left until the TV turns on or off automatically, press RECALL.

Setting the ON timer

To set the ON timer to turn on the TV automatically:

1. Press MENU, and then press ◀ or ▶ until the TIMER menu appears.
2. Press ▲ or ▼ to highlight ON TIMER.
3. Press the Number buttons (0–9) or ◀ or ▶ button to enter the length of time until the TV turns on automatically.
You can set the ON timer in 10-minute increments, up to 12h00m.
4. Press EXIT. (The ON timer will start.)

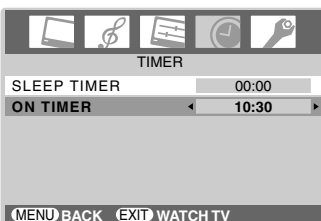

5. Press POWER to turn off the TV.
The TV will turn on automatically after the length of time you set in the ON Timer.

Adjusting the sound

Muting the sound

Press MUTE to temporarily reduce (1/2 MUTE) or turn off (MUTE) the sound. While the sound is off, the screen will display “1/2 MUTE” or “MUTE” in the lower right corner. Every time you press MUTE, the mute mode will change in the following order.

→ Normal → 1/2 MUTE → MUTE →

When you select “MUTE” mode, the closed caption feature is automatically activated. To deactivate this feature, deactivate MUTE. This feature works only when the closed caption mode is set to OFF. See “Using the closed caption feature” on page 45 for more information.

Selecting stereo/SAP broadcasts

The multi-channel TV sound (MTS) feature allows you to listen to high-fidelity stereo sound while watching TV. MTS can also transmit a second audio program (SAP) containing a second language, music, or other audio information (when provided by individual stations).

When the TV receives a stereo or SAP broadcast, the word STEREO or SAP appears on-screen every time the TV is turned on, the channel is changed, or the RECALL button is pressed.

The MTS feature is not available when the TV is in VIDEO mode.

To listen to stereo sound:

1. Press MENU, and then press ◀ or ▶ until the AUDIO menu appears.
2. Press ▲ or ▼ to select MTS.
3. Press ◀ or ▶ to select STEREO.

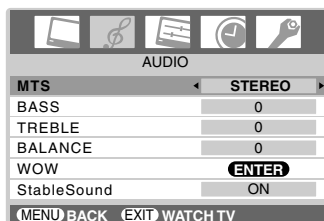

You can leave your TV in STEREO mode because it will automatically output the type of sound being broadcast (stereo or monaural).

If the stereo sound is noisy, select MONO to reduce the noise.

To listen to SAP (if available):

1. Press MENU, and then press ◀ or ▶ until the AUDIO menu appears.
2. Press ▲ or ▼ to highlight MTS.
3. Press ◀ or ▶ to highlight SAP. You will hear the station's second audio program (if available) from the speakers, while viewing the original program's picture (see note at right).

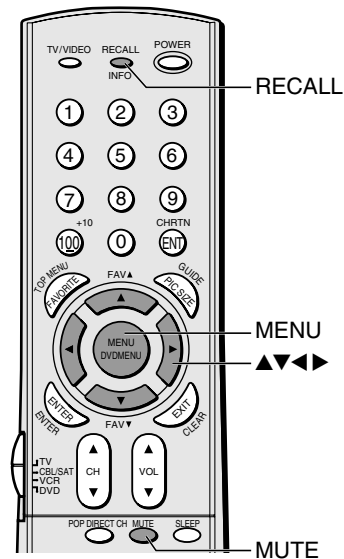

TV top panel

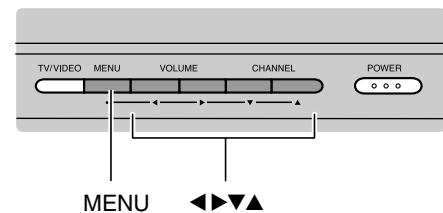

Note:

A second audio program (SAP) can be heard only on those TV stations that offer it.

For example, a station might broadcast music as a second audio program. If you have SAP on, you will see the current program on the screen but hear music instead of the program's normal audio.

However, if you have SAP on and the station you are watching is not currently broadcasting a second audio program, the station's normal audio will be output.

Occasionally there is no sound at all in SAP mode. If this happens, set the MTS feature to STEREO mode.

Using the WOW™ surround sound feature

WOW™ is a special combination of SRS Labs audio technologies that creates a thrilling surround sound experience with deep, rich bass from stereo sound sources. Your TV's audio will sound fuller, richer, and wider. WOW consists of three features: SRS 3D, FOCUS, and TruBass.

To adjust the WOW feature:

1. Select STEREO mode (see “Selecting stereo/SAP broadcasts” on page 47).
2. Press MENU, and then press ◀ or ▶ until the AUDIO menu appears.
3. Press ▲ or ▼ to highlight WOW, then press ENTER. The WOW menu appears.

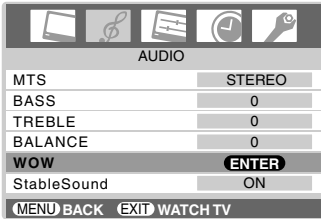

4. Press ▲ or ▼ to highlight the desired WOW feature you want to adjust.

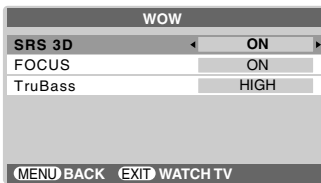

5. Press ◀ or ▶ to adjust the item.
 - SRS 3D — To turn on or off the surround sound effect.
 - FOCUS — To turn on or off the vocal emphasis effect.
 - TruBass — To select your desired bass expansion level (HIGH, LOW, or OFF).

Note:

If the broadcast is monaural, the WOW SRS 3D surround sound effect will not work.

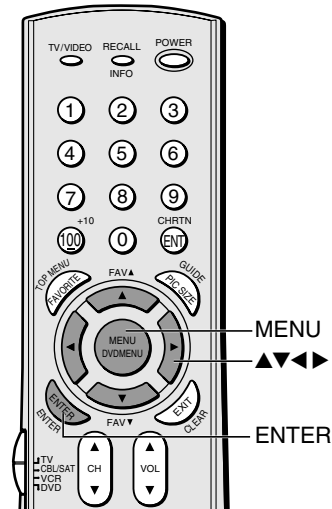

Adjusting the sound quality

You can change the quality of your TV's sound by adjusting the bass, treble, and balance.

To adjust the sound quality:

1. Press MENU, and then press ◀ or ▶ until the AUDIO menu appears.
2. Press ▲ or ▼ to highlight the item you want to adjust.

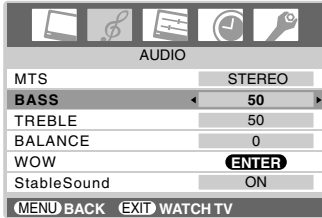

3. Press ◀ or ▶ to adjust the level.



- ◀ makes the sound quality weaker or increases the balance in the left channel, depending on the item selected.
- ▶ makes the sound quality stronger or increases the balance in the right channel, depending on the item selected.

Using the StableSound® feature

When the signal source is changed, the StableSound feature limits the highest volume level to prevent extreme changes in volume (for example, to prevent the sudden increase in volume that often happens when a TV program switches to a commercial).

To turn on the StableSound feature:

1. Press MENU, and then press ◀ or ▶ until the AUDIO menu appears.
2. Press ▲ or ▼ to highlight StableSound.
3. Press ◀ or ▶ to select ON.



To turn off the StableSound feature:

Select OFF in step 3 above.

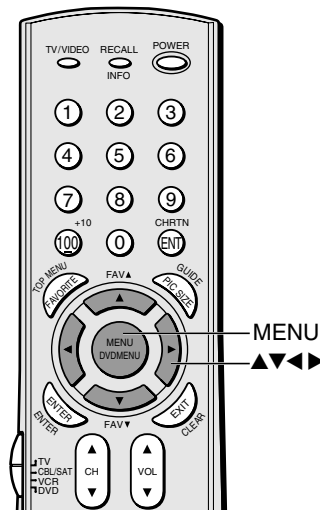

Displaying on-screen information

Press **RECALL** to display the following information on-screen:

- Channel number or VIDEO mode selected
- Remaining time of ON/SLEEP timer (if set)
- Channel label (if set)
- Video label (when in video mode)
- Stereo or SAP audio status
- V-CHIP rating status
- Picture size

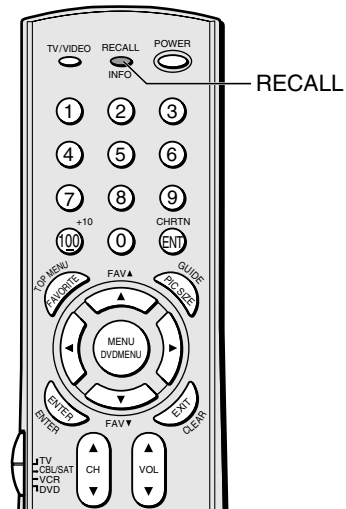
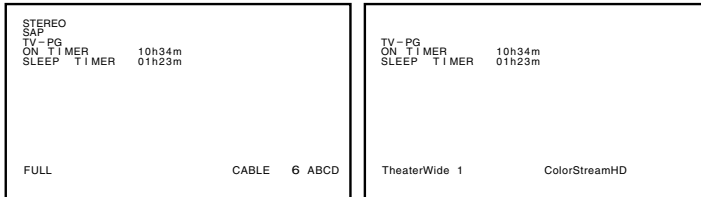

Understanding the auto power off feature

The TV will automatically turn itself off after approximately 15 minutes if it is tuned to a vacant channel or a station that completes its broadcast for the day. This feature does not work in VIDEO mode.

Understanding the last mode memory feature

If the power is cut off while you are viewing the TV, the Last Mode Memory feature turns on the TV automatically when the power is resupplied.

If the power is going to be off for a long time and you are going to be away from your TV, unplug the power cord to prevent the TV from turning on in your absence.

Appendix

Specifications

- This model complies with the specifications listed below.
- Designs and specifications are subject to change without notice.
- This model may not be compatible with features and/or specifications that may be added in the future.



WARNING: RISK OF ELECTRIC SHOCK!

Never attempt to service the TV yourself. Opening and removing the covers may expose you to dangerous voltage or other hazards. Refer all servicing to a Toshiba Authorized Service Center.

Television System

NTSC standard

Channel Coverage

VHF: 2 through 13

UHF: 14 through 69

Cable TV: Mid band (A-8 through A-1, A through I)

Super band (J through W)

Hyper band (AA through ZZ, AAA, BBB)

Ultra band (65 through 94, 100 through 125)

Power Source

120 V AC, 60 Hz

Power Consumption

89 W (average)

0.5 W in standby mode

Audio Power

10 W + 10 W

Speaker Type

Two 2-3/8 × 4-3/4 inches (60 × 120 mm)

Video/Audio Terminals

S-VIDEO INPUT

Y : 1 V(p-p), 75 ohms, negative sync.

C : 0.286 V(p-p) (burst signal), 75 ohms

VIDEO/AUDIO INPUT

VIDEO: 1 V(p-p), 75 ohms, negative sync.

AUDIO: 150 mV(rms) (30% modulation equivalent, 22k ohms or greater)

ColorStream® (component video) INPUT

Y : 1V(p-p), 75 ohms

PR: 0.7 V(p-p), 75 ohms

PB: 0.7 V(p-p), 75 ohms

Suggested scan rates: 1080i, 480p, 480i, 720p
(These signal formats are converted to match the number of pixels of the LCD panel.)

AUDIO: 150 mV(rms), 22k ohms or greater

VIDEO/AUDIO OUTPUT

VIDEO: 1 V(p-p), 75 ohms, negative sync.

AUDIO: 150 mV(rms) (30% modulation equivalent, 2.2k ohms or less)

HDMI INPUT:

HDMI compliant (type A connector)

HDCP compliant

E-EDID* compliant

Suggested scan rates: 1080i, 480p, 480i, 720p
(These signal formats are converted to match the number of pixels of the LCD panel.)

HDMI Audio: 2-channel PCM

32/44.1/48 kHz sampling frequency

16/20/24 bits per sample

Headphone jack

3.5 mm stereo

Dimensions (Including TV stand)

Width : 27-1/4 inches (690 mm)

Height : 22-1/2 inches (570 mm)

Depth : 10-7/8 inches (274 mm)

Mass (weight)

34 lbs (15.4 kg)

Operating conditions

Temperature: 32°F – 95°F (0°C – 35°C)

Humidity: 20 – 80% (no moisture condensation)

*E-EDID = Enhanced-Extended Display Identification

Troubleshooting

Before calling a service technician, please check the following table for a possible cause of the symptom and some solutions.

Symptom	Solution
TV will not turn on	<ul style="list-style-type: none">• Make sure the power cord is plugged in, then press POWER.• Make sure the appropriate device mode on the remote control is selected.• The remote control batteries may be dead. Replace the batteries.
No picture, no sound	<ul style="list-style-type: none">• Check the antenna/cable connections.
No sound, picture OK	<ul style="list-style-type: none">• The sound may be muted. Press VOLUME.• The station may have broadcast difficulties. Try another channel.
Poor picture, sound OK	<ul style="list-style-type: none">• Check the antenna connections.• The station may have broadcast difficulties. Try another channel.• Adjust the PICTURE menu.
Poor reception of broadcast channels	<ul style="list-style-type: none">• The station may have broadcast difficulties. Try another channel.• Check the antenna connections.• If you are using a VCR, make sure the TV/VCR button is set correctly.
Cannot receive above channel 13	<ul style="list-style-type: none">• Make sure the TV/CABLE switch is set to the mode that corresponds with the signal source type (cable company or outside antenna).
Black box appears on the screen	<ul style="list-style-type: none">• The closed caption feature may be set to one of the Text modes (T1, T2, T3, or T4). Turn closed captioning OFF.
Unable to select a certain channel	<ul style="list-style-type: none">• The channel may be locked with the CH LOCK feature, or erased with the ADD/ERASE feature.
Multiple images	<ul style="list-style-type: none">• The station may have broadcast difficulties. Try another channel.• Antenna reception may be poor. Use a highly directional outdoor antenna.
Poor color or no color	<ul style="list-style-type: none">• The station may have broadcast difficulties. Try another channel.• Adjust the TINT and/or COLOR in the PICTURE menu.
No stereo or SAP sound from a known MTS broadcast	<ul style="list-style-type: none">• Make sure the MTS feature is set properly.
The remote control does not operate	<ul style="list-style-type: none">• Make sure the appropriate device mode is selected.• Remove all obstructions between the remote control and the remote control sensor in the TV.• The remote control batteries may be dead. Replace the batteries.
Cannot access signal input sources (Video1, Video2, ColorStream HD, HDMI) and/or Channels 3 and 4.	<ul style="list-style-type: none">• Check the VIDEO LOCK feature.

Limited United States Warranty

for LCD Televisions 26" and Larger

Toshiba America Consumer Products, L.L.C. ("TACP") makes the following limited warranties to original consumers in the United States.

THESE LIMITED WARRANTIES EXTEND TO THE ORIGINAL CONSUMER PURCHASER OR ANY PERSON RECEIVING THIS LCD TELEVISION AS A GIFT FROM THE ORIGINAL CONSUMER PURCHASER AND TO NO OTHER PURCHASER OR TRANSFEREE.

LCD TELEVISIONS PURCHASED IN THE U.S.A. AND USED ANYWHERE OUTSIDE OF THE U.S.A., INCLUDING, WITHOUT LIMITATION, CANADA AND MEXICO, ARE NOT COVERED BY THESE WARRANTIES.

LCD TELEVISIONS PURCHASED ANYWHERE OUTSIDE OF THE U.S.A., INCLUDING, WITHOUT LIMITATION, CANADA AND MEXICO, AND USED IN THE U.S.A., ARE NOT COVERED BY THESE WARRANTIES.

Limited One (1) Year Warranty on Parts and Labor

TACP warrants this LCD Television and its parts against defects in materials or workmanship for period of one (1) year after the date of original retail purchase. DURING THIS PERIOD, TACP WILL, AT TACP'S OPTION, REPAIR OR REPLACE A DEFECTIVE PART WITH A NEW OR REFURBISHED PART WITHOUT CHARGE TO YOU FOR PARTS OR LABOR. During this period, TACP Authorized Service Station personnel will come to your home when warranty service is required. Depending on the type of repair required, the service will either be performed in your home or the LCD Television will be taken to a TACP Authorized Service Station for repair and returned to your home at no cost to you.

Rental Units

The warranty for LCD Television rental units begins on the date of the first rental or thirty (30) days after the date of shipment to the rental firm, whichever comes first.

Limited Warranty for Commercial Units

TACP warrants LCD Televisions that are sold and used for commercial purposes as follows: all parts are warranted against defects in materials or workmanship for a period of ninety (90) days after the date of original retail purchase. DURING THIS PERIOD, TACP WILL, AT TACP'S OPTION, REPAIR OR REPLACE A DEFECTIVE PART WITH A NEW OR REFURBISHED PART WITHOUT CHARGE TO YOU.

Owner's Manual and Product Registration Card

Read this owner's manual thoroughly before operating this LCD Television.

Complete and mail the enclosed product registration card or register your LCD Television online at www.tacp.toshiba.com/service as soon as possible. By registering your LCD Television you will enable TACP to bring you new products specifically designed to meet your needs and help us to contact you in the unlikely event a safety notification is required under the U.S. Consumer Product Safety Act. **Failure to complete and return the product registration card does not diminish your warranty rights.**

Your Responsibility

THE ABOVE WARRANTIES ARE SUBJECT TO THE FOLLOWING CONDITIONS:

- (1) You must retain your original bill of sale or provide other proof of purchase.
- (2) All warranty servicing of this LCD Television must be performed by an Authorized TACP Service Station.
- (3) The warranties from TACP are effective only if this LCD Television is purchased and operated in the Continental U.S.A. or Puerto Rico.

- (4) Labor service charges for set installation, setup, adjustment of customer controls, and installation or repair of antenna systems are not covered by this warranty. Reception problems caused by inadequate antenna systems, misaligned satellite dishes, cable television distribution, VCRs, DVD players/recorders, personal computer level IEEE-1394 devices, and any other connected signal source device are your responsibility.
- (5) Warranties extend only to defects in materials or workmanship as limited above, and do not extend to any LCD Television or parts that have been lost or discarded by you or to damage to the LCD Television or parts caused by fires, misuse, accident, Acts of God (such as lightning or fluctuations in electric power), improper installation, improper maintenance, or use in violation of instructions furnished by TACP; use or malfunction through simultaneous use of this LCD Television and connected equipment; or to units that have been modified or had the serial number removed, altered, defaced, or rendered illegible.

How to Obtain Warranty Service

If, after following all of the operating instructions in this manual and reviewing the section entitled "Troubleshooting," you find that service is needed:

- (1) To find the nearest TACP Authorized Service Station, visit TACP's website at www.tacp.toshiba.com/service or contact TACP's Consumer Solution Center toll free at 1-800-575-5469.
- (2) You must present your original bill of sale or other proof of purchase to the TACP Authorized Service Station.

**For additional information, visit TACP's website:
www.tacp.toshiba.com**

ALL WARRANTIES IMPLIED BY THE LAW OF ANY STATE OF THE U.S.A., INCLUDING THE IMPLIED WARRANTIES OF MERCHANTABILITY AND FITNESS FOR A PARTICULAR PURPOSE, ARE EXPRESSLY LIMITED TO THE DURATION OF THE LIMITED WARRANTIES SET FORTH ABOVE. WITH THE EXCEPTION OF ANY WARRANTIES IMPLIED BY THE LAW OF ANY STATE OF THE U.S.A. AS HEREBY LIMITED, THE FOREGOING WARRANTY IS EXCLUSIVE AND IN LIEU OF ALL OTHER WARRANTIES, GUARANTEES, AGREEMENTS, AND SIMILAR OBLIGATIONS OF TACP WITH RESPECT TO THE REPAIR OR REPLACEMENT OF ANY PARTS. IN NO EVENT SHALL TACP BE LIABLE FOR CONSEQUENTIAL OR INCIDENTAL DAMAGES (INCLUDING, BUT NOT LIMITED TO, LOST PROFITS, BUSINESS INTERRUPTION, OR MODIFICATION OR ERASURE OF RECORDED DATA CAUSED BY USE, MISUSE OR INABILITY TO USE THIS LCD TELEVISION).

No person, agent, distributor, dealer, or company is authorized to change, modify, or extend the terms of these warranties in any manner whatsoever. The time within which an action must be commenced to enforce any obligation of TACP arising under the warranty or under any statute or law of the United States or any state thereof is hereby limited to ninety (90) days from the date you discover, or should have discovered, the defect. This limitation does not apply to implied warranties arising under the law of any state of the U.S.A.

THIS WARRANTY GIVES YOU SPECIFIC LEGAL RIGHTS AND YOU MAY ALSO HAVE OTHER RIGHTS WHICH MAY VARY FROM STATE TO STATE IN THE U.S.A. SOME STATES OF THE U.S.A. DO NOT ALLOW LIMITATIONS ON THE DURATION OF AN IMPLIED WARRANTY, WHEN AN ACTION MAY BE BROUGHT, OR THE EXCLUSION OR LIMITATION OF INCIDENTAL OR CONSEQUENTIAL DAMAGES. THEREFORE, THE ABOVE PROVISIONS MAY NOT APPLY TO YOU UNDER SUCH CIRCUMSTANCES.

[0305]

E

F

S

Introduction

Connecting
your TV

Using the
remote control

Setting up
your TV

Using the TV's
Features

Appendix

Index

Limited Canada Warranty

for LCD TV

Toshiba of Canada Limited ("TCL") makes the following limited warranties to original consumers in Canada.

THESE LIMITED WARRANTIES EXTEND TO THE ORIGINAL CONSUMER PURCHASER OR ANY PERSON RECEIVING THIS LCD TV AS A GIFT FROM THE ORIGINAL CONSUMER PURCHASER AND TO NO OTHER PURCHASER OR TRANSFEREE.

Limited One (1) Year Warranty on Parts and Labor

TCL warrants this LCD TV and its parts against defects in materials or workmanship for a period of one (1) year after the date of original retail purchase. DURING THIS PERIOD, TCL WILL, AT TCL'S OPTION, REPAIR OR REPLACE A DEFECTIVE PART WITH A NEW OR REFURBISHED PART WITHOUT CHARGE TO YOU FOR PARTS OR LABOR. To receive warranty service, you must return the LCD TV to a TCL Authorized Service Depot.

Rental Units

The warranty for rental units begins with the date of first rental or thirty (30) days from the date of shipment to the rental firm, whichever comes first.

Commercial Units

LCD TVs sold and used for commercial purposes have a limited ninety (90) day warranty for all parts and labor.

Owner's Manual and Product Registration

Read this owner's manual thoroughly before operating this LCD TV. If you purchased your LCD TV in Canada, register it online at www.toshiba.ca as soon as possible. By registering your product you will enable TCL to bring you new products specifically designed to meet your needs and help us to contact you in the unlikely event a safety notification is required under the U.S. Consumer Product Safety Act. **Failure to register online does not diminish your warranty rights.**

Your Responsibility

THE ABOVE WARRANTIES ARE SUBJECT TO THE FOLLOWING CONDITIONS:

- (1) You must provide your bill of sale or other proof of purchase.
- (2) All warranty servicing of this LCD TV must be made by an Authorized TCL Service Depot.
- (3) The warranties from TCL are effective only if the LCD TV is purchased in Canada from an authorized TCL dealer and operated in Canada.
- (4) Labor charges for installation, setup, adjustment of customer controls, and installation or repair of antenna systems are not covered by these warranties. Reception problems caused by inadequate antenna systems are your responsibility.
- (5) Warranties extend only to defects in materials or workmanship as limited above, and do not extend to any LCD TV or parts that have been lost or discarded by you or to damage to the LCD TV or parts caused by fires, misuse, accident, Acts of God (such as lightning or fluctuations in electric power), improper installation, improper maintenance, or use in violation of instructions furnished by TCL; use or malfunction through simultaneous use of this product and connected equipment; or to units that have been modified or had the serial number removed, altered, defaced, or rendered illegible.

How to Obtain Warranty Services

If, after following all of the operating instructions in this manual and checking the "Troubleshooting" section, you find that service is needed:

- (1) To find the nearest TCL Authorized Service Depot, visit TCL's web site at www.toshiba.ca.
- (2) Present your bill of sale or other proof of purchase to the Authorized Service Depot.

**For additional information, visit TCL's web site:
www.toshiba.ca**

ALL WARRANTIES IMPLIED BY THE LAW OF ANY PROVINCE OF CANADA, INCLUDING THE IMPLIED WARRANTIES OF MERCHANTABILITY AND FITNESS FOR A PARTICULAR PURPOSE, ARE EXPRESSLY LIMITED TO THE DURATION OF THE LIMITED WARRANTIES SET FORTH ABOVE. WITH THE EXCEPTION OF ANY WARRANTIES IMPLIED BY THE LAW OF ANY PROVINCE OF CANADA AS HEREBY LIMITED, THE FOREGOING WARRANTY IS EXCLUSIVE AND IN LIEU OF ALL OTHER WARRANTIES, GUARANTEES, AGREEMENTS, AND SIMILAR OBLIGATIONS OF TCL WITH RESPECT TO THE REPAIR OR REPLACEMENT OF ANY PARTS. IN NO EVENT SHALL TCL BE LIABLE FOR CONSEQUENTIAL OR INCIDENTAL DAMAGES (INCLUDING, BUT NOT LIMITED TO, LOST PROFITS, BUSINESS INTERRUPTION, OR MODIFICATION OR ERASURE OF RECORDED DATA) CAUSED BY USE, MISUSE, OR INABILITY TO USE THIS PRODUCT.

No person, agent, distributor, dealer, or company is authorized to change, modify, or extend the terms of these warranties in any manner whatsoever. The time within which action must be commenced to enforce any obligation of TCL arising under this warranty or under any law of Canada or of any province thereof is hereby limited to 90 days from the date you discover, or should have discovered, the defect. This limitation does not apply to implied warranties arising under the law of any province of Canada.

THIS WARRANTY GIVES YOU SPECIFIC LEGAL RIGHTS, AND YOU MAY ALSO HAVE OTHER RIGHTS, WHICH MAY VARY FROM PROVINCE TO PROVINCE IN CANADA. SOME PROVINCES OF CANADA DO NOT ALLOW LIMITATIONS ON THE DURATION OF AN IMPLIED WARRANTY, LIMITATIONS ON THE TIME WITHIN WHICH AN ACTION MAY BE BROUGHT, OR THE EXCLUSION OR LIMITATION OF INCIDENTAL OR CONSEQUENTIAL DAMAGES; THEREFORE, THE ABOVE LIMITATIONS OR EXCLUSIONS MAY NOT APPLY TO YOU UNDER SUCH CIRCUMSTANCES.

Index

A B

Antenna cables	9
Auto aspect	32
Auto power off	50
A/V cables	9
Back light	40
Back of the TV	8
Black stretch	41

C

CableClear® DNR (Digital Noise Reduction)	42
Cable converter box connection	10
Camcorder connection	14
CH ▲▼ buttons	25
CH LABELING	28
CH LOCK	37
CH RTN button	26
Channel Number buttons	26
Channel programming	
ADD/ERASE	25
Automatic programming	24
TV/CABLE selection	24
Cinema mode	43
Closed caption	45
Color temperature	43
Component video cables	9

D

DTV receiver connection	13
DVI connection	15
DVD connection	11, 12

F G H

FAV ▲▼ buttons	27
Favorite channels	26
FOCUS	48
Front of the TV	8
Gray level	33
HDMI™ connection	15

L M

Labeling channels	28
Labeling video inputs	44
Language selection	23
Last mode memory	50
Locking channels	37
Locking video inputs	39
LOCKS menu	34
Menu system	22
MPEG NR	42
MTS	47
MUTE button	47

O P Q

ON timer	46
Picture adjustments	
COLOR TEMPERATURE	43
Picture mode	40
Picture quality	41
Picture size selection	29
POWER button	21

R

RECALL button	50
Remote control	
Battery installation	16
Control codes	17-18
Functional key chart	20
Learning about the buttons	21
Programming	17

S

S-video cables	9
SAP sound	47
Satellite receiver connection	11
Set-top box	13
Sleep timer	46
Sound quality adjustments	49
Specifications	51
SRS 3D	48
StableSound®	49
Stereo sound	47

T

Troubleshooting	52
TruBass	48
TV/VIDEO button	26, 44

V

V-CHIP	
BLOCKING OPTION	36
ENABLE BLOCKING	35
MPAA RATING	36
NEW PIN CODE	39
TV RATING	35
Unlocking programs temporarily	37
VCR connection	10-14
VIDEO LABEL	44
VIDEO LOCK	39
VOL (volume) ▲▼ buttons	21

W

Warranty	53, 54
WOW™ surround	48

TOSHIBA AMERICA CONSUMER PRODUCTS, L.L.C.

HEAD OFFICE: 82 TOTOWA ROAD, WAYNE, NEW JERSEY 07470, U.S.A.
NATIONAL SERVICE DIVISION: 1420B TOSHIBA DRIVE, LEBANON, TN. 37087, U.S.A.

TOSHIBA OF CANADA LTD.

HEAD OFFICE/191 McNABB STREET MARKHAM, ONTARIO L3R 8H2, CANADA TEL: (905) 470-5400

SERVICE CENTERS:

TORONTO: 191 McNABB STREET MARKHAM, ONTARIO L3R 8H2, CANADA TEL: (905) 470-5400
MONTREAL: 18050 TRANS CANADA, KIRKLAND, QUEBEC, H9J-4A1, CANADA TEL: (514) 390-7766
VANCOUVER: 22171 FRASERWOOD WAY, RICHMOND, B.C. V6W 1J5, CANADA TEL: (604) 303-2500

MANUFACTURED BY

TOSHIBA ELECTROMEX, S.A. DE C.V.

CableClear, ColorStream, StableSound, and TheaterWide are registered trademarks of Toshiba America Consumer Products, L.L.C.

TOSHIBA

Printed in USA
(05-05)

YC/M 23566644

Free Manuals Download Website

<http://myh66.com>

<http://usermanuals.us>

<http://www.somanuals.com>

<http://www.4manuals.cc>

<http://www.manual-lib.com>

<http://www.404manual.com>

<http://www.luxmanual.com>

<http://aubethermostatmanual.com>

Golf course search by state

<http://golfingnear.com>

Email search by domain

<http://emailbydomain.com>

Auto manuals search

<http://auto.somanuals.com>

TV manuals search

<http://tv.somanuals.com>