

TOSHIBA

OWNER'S MANUAL

Integrated High definition LCD Television

COLORSTREAM[®] HD

THEATERWIDE **HD**

DOLBY
DIGITAL

SRS
WOW

TV
GUIDE

HDTV
HIGH DEFINITION TELEVISION

HDMI

High definition programming is required to view High Definition TV broadcasts. Please contact your cable or satellite provider.

For an overview of steps for setting up and using your new TV, see page 8.

Owner's Record

The model number and serial number are on the back of your TV. Record these numbers in the spaces below. Refer to these numbers whenever you communicate with your Toshiba dealer about this TV.

Model number:

Serial number:

27HL95

© 2005 TOSHIBA CORPORATION
All Rights Reserved

YCM 23566693A

Dear Customer,

Thank you for purchasing this Toshiba LCD TV. This manual will help you use the many exciting features of your new LCD TV.

Before operating your LCD TV, please read this manual completely and keep it nearby for future reference.

Safety Precautions

WARNING: TO REDUCE THE RISK OF FIRE OR ELECTRIC SHOCK, DO NOT EXPOSE THIS APPLIANCE TO RAIN OR MOISTURE.



WARNING: TO REDUCE THE RISK OF ELECTRIC SHOCK, DO NOT REMOVE COVER (OR BACK). NO USER-SERVICEABLE PARTS INSIDE. REFER SERVICING TO QUALIFIED SERVICE PERSONNEL.

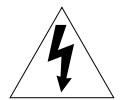

The lightning symbol in the triangle tells you that the voltage inside this product may be strong enough to cause an electric shock. **DO NOT TRY TO SERVICE THIS PRODUCT YOURSELF.**



The exclamation mark in the triangle tells you that important operating and maintenance instructions follow this symbol.

WARNING

To prevent injury, this apparatus must be securely attached to the floor/wall in accordance with the installation instructions. (See item 19 on page 3.)

WARNING: If you decide to wall mount this television, always use the Toshiba wall bracket specified below or another UL-approved wall bracket appropriate for the size and weight of this television. The use of any wall bracket other than the Toshiba wall bracket specified below or another UL-approved wall bracket appropriate for the size and weight of this television for wall mounting this television could result in serious bodily injury and/or property damage.

In the U.S.:

Use Toshiba wall bracket model number **FWB2027** or, if no longer available, another UL-approved wall bracket appropriate for the size and weight of the television. For more information, call TACP's Consumer Solutions Center at 1-800-631-3811 or visit TACP's website at www.tacp.toshiba.com.

NOTE TO CATV INSTALLERS

This is a reminder to call the CATV system installer's attention to Article 820-40 of the U.S. NEC, which provides guidelines for proper grounding and, in particular, specifies that the cable ground shall be connected to the grounding system of the building, as close to the point of cable entry as practical. For additional antenna grounding information, see items 25 and 26 on page 4.

Child Safety

It Makes A Difference Where Your TV Stands



Congratulations on your purchase! As you enjoy your new TV, keep these safety tips in mind:

The Issue

- If you are like most consumers, you have a TV in your home. Many homes, in fact, have more than one TV.
- The home theater entertainment experience is a growing trend, and larger TVs are popular purchases; however, they are not always supported on the proper TV stands.
- Sometimes TVs are improperly secured or inappropriately situated on dressers, bookcases, shelves, desks, audio speakers, chests, or carts. As a result, TVs may fall over, causing unnecessary injury.

Toshiba Cares!

- The consumer electronics industry is committed to making home entertainment enjoyable and safe.
- The Consumer Electronics Association formed the Home Entertainment Support Safety Committee, comprised of TV and consumer electronics furniture manufacturers, to advocate children's safety and educate consumers and their families about television safety.

Tune Into Safety

- One size does NOT fit all! Use appropriate furniture large enough to support the weight of your TV (and other electronic components).
- Use appropriate angle braces, straps, and anchors to secure your furniture to the wall (but never screw anything directly into the TV).
- Carefully read and understand the other enclosed instructions for proper use of this product.
- Do not allow children to climb on or play with furniture and TVs.
- Avoid placing any item on top of your TV (such as a VCR, remote control, or toy) that a curious child may reach for.
- Remember that children can become excited while watching a program and can potentially push or pull a TV over.
- Share our safety message about this hidden hazard of the home with your family and friends. Thank you!



2500 Wilson Blvd.
Arlington, VA 22201 U.S.A.
Tel. 703-907-7600 Fax 703-907-7690
www.CE.org

CEA is the Sponsor, Producer and Manager of the International CES®

Important Safety Instructions

- 1) Read these instructions.
- 2) Keep these instructions.
- 3) Heed all warnings.
- 4) Follow all instructions.



5) Do not use this apparatus near water.

6) Clean only with dry cloth.

7) Do not block any ventilation openings. Install in accordance with the manufacturer's instructions.

8) Do not install near any heat sources such as radiators, heat registers, stoves, or other apparatus (including amplifiers) that produce heat.

9) Do not defeat the safety purpose of the polarized or grounding type plug. A polarized plug has two blades with one wider than the other. A grounding type plug has two blades and a third grounding prong. The wide blade or the third prong are provided for your safety. If the provided plug does not fit into your outlet, consult an electrician for replacement of the obsolete outlet.

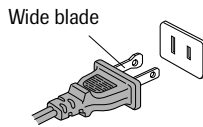

10) Protect the power cord from being walked on or pinched, particularly at plugs, convenience receptacles, and the point where they exit from the apparatus.

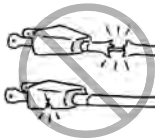

11) Only use attachments/accessories specified by the manufacturer.

12) Use only with the cart, stand, tripod, bracket, or table specified by the manufacturer, or sold with the apparatus. When a cart is used, use caution when moving the cart/apparatus combination to avoid injury from tip-over.



13) Unplug this apparatus during lightning storms or when unused for long periods of time.



14) Refer all servicing to qualified service personnel. Servicing is required when the apparatus has been damaged in any way, such as power-supply cord or plug is damaged, liquid has been spilled or objects have fallen into the apparatus, the apparatus has been exposed to rain or moisture, does not operate normally, or has been dropped.

14a) **CAUTION:** If the TV is dropped and the cabinet or enclosure surface has been damaged or the TV does not operate normally, take the following precautions:

- ALWAYS turn off the TV and unplug the power cord to avoid possible electric shock or fire.
- NEVER allow your body to come in contact with any broken glass or liquid from the damaged television. The LCD panel inside the TV contains glass and a toxic liquid. If the liquid comes in contact with your mouth or eyes, or your skin is cut by broken glass, rinse the affected area thoroughly with water and consult your doctor.
- ALWAYS contact a service technician to inspect the TV any time it has been damaged or dropped.

15) The apparatus shall not be exposed to dripping or splashing and that no objects filled with liquids, such as vases, shall be placed on the apparatus.

Installation, Care, and Service

Installation

Follow these recommendations and precautions and heed all warnings when installing your TV:

16) Never modify this equipment. Changes or modifications may void: a) the warranty, and b) the user's authority to operate this equipment under the rules of the Federal Communications Commission.

17) **DANGER: RISK OF SERIOUS PERSONAL INJURY, DEATH, OR EQUIPMENT DAMAGE!** Never place the TV on an unstable cart, stand, or table. The TV may fall, causing serious personal injury, death, or serious damage to the TV.



18) Never place items such as vases, aquariums, or candles on top of the TV.

19) Always place the TV on the floor or a sturdy, level, stable surface that can support the weight of the unit. To secure the TV, use a sturdy tie from the hooks on the rear of the TV pedestal to a wall, pillar, or other immovable structure. Make sure the tie is tight, secure, and parallel to the floor.

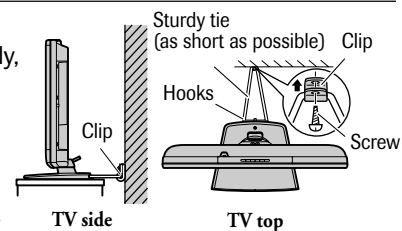

20) Never expose the apparatus to dripping or splashing liquid or place items such as vases, aquariums, any other item filled with liquid, or candles on top of the TV.

21) Never block or cover the slots or openings in the TV cabinet back, bottom, and sides. Never place the TV:

- on a bed, sofa, rug, or similar surface;
- too close to drapes, curtains, or walls; or
- in a confined space such as a bookcase, built-in cabinet, or any other place with poor ventilation.

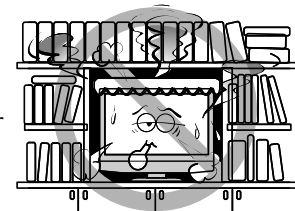

The slots and openings are provided to protect the TV from overheating and to help maintain reliable operation of the TV. Leave a space of at least 4 inches around the TV.

22) Never allow anything to rest on or roll over the power cord, and never place the TV where the power cord is subject to wear or abuse.

23) Never overload wall outlets and extension cords.

24) Always operate the TV with a 120V AC, 60Hz power source only.

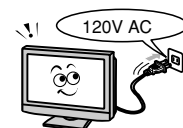

CAUTION: To reduce the risk of electric shock, do not use the polarized plug with an extension cord, receptacle, or other outlet unless the blades can be inserted completely to prevent blade exposure.

Installation *(cont. from previous page)*

- 25) Always make sure the antenna system is properly grounded to provide adequate protection against voltage surges and built-up static charges (see Section 810 of the National Electric Code).

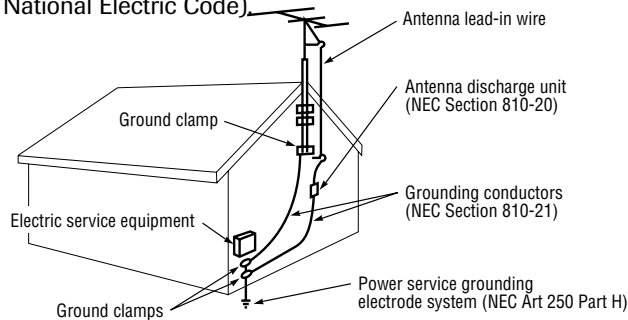

- 26) **! DANGER: RISK OF SERIOUS PERSONAL INJURY OR DEATH!**
- Use extreme care to make sure you are never in a position where your body (or any item you are in contact with, such as a ladder or screwdriver) can accidentally touch overhead power lines. Never locate the antenna near overhead power lines or other electrical circuits.
 - Never attempt to install any of the following during lightning activity:
 - a) an antenna system; or b) cables, wires, or any home theater component connected to an antenna or phone system.
-

Care

For better performance and safer operation of your TOSHIBA TV, follow these recommendations and precautions:

- 27) If you use the TV in a room whose temperature is 32 °F (0 °C) or below, the picture brightness may vary until the LCD warms up. This is not a sign of malfunction.
- 28) Always unplug the TV before cleaning. Gently wipe the display panel surface (the TV screen) using dry, soft cloth only (cotton, flannel, etc.). A hard cloth may damage the surface of the panel. Avoid contact with alcohol, thinner, benzene, acidic or alkaline solvent cleaners, abrasive cleaners, or chemical cloths, which may damage the surface. Never spray volatile compounds such as insecticide on the cabinet. Such products may damage or discolor the cabinet.
-
- 29) To avoid damage to this product, never place or store the TV in direct sunlight; hot, humid areas; or areas subject to excessive dust or vibration.

Care *(cont. from previous column)*

- 30) **! WARNING: RISK OF ELECTRIC SHOCK!** Never spill liquids or push objects of any kind into the TV cabinet slots.
- 31) While it is thundering, do not touch the connecting cables or apparatus.
- 32) For added protection of your TV from lightning and power surges, always unplug the power cord and disconnect the antenna from the TV if you leave the TV unattended or unused for long periods of time.
- 33) During normal use, the TV may make occasional snapping or popping sounds. This is normal, especially when the unit is being turned on or off. If these sounds become frequent or continuous, unplug the power cord and contact a Toshiba Authorized Service Center.
- 34) **! WARNING: RISK OF SERIOUS PERSONAL INJURY OR EQUIPMENT DAMAGE!** Never strike the screen with a sharp or heavy object.
-
- 35) • The LCD screen of this product can be damaged by ultraviolet radiation from the sun. When selecting a location for the television, avoid locations where the screen may be exposed to direct sunlight, such as in front of a window.
- Never touch, press, or place anything on the LCD screen. These actions will damage the LCD screen. If you need to clean the LCD screen, follow the instructions in item 28 on page 4.

Service

- 36) **! WARNING: RISK OF ELECTRIC SHOCK!** Never attempt to service the TV yourself. Opening and removing the covers (except as specified herein) may expose you to dangerous voltage or other hazards. Refer all servicing to a Toshiba Authorized Service Center.
- 37) If you have the TV serviced:
- Ask the service technician to use only replacement parts specified by the manufacturer.
 - Upon completion of service, ask the service technician to perform routine safety checks to determine that the TV is in safe operating condition.
- 38) The cold cathode fluorescent lamp in the LCD panel contains a small amount of mercury. When the TV reaches the end of its useful life, dispose of the used TV by the approved method for your area, or ask a qualified service technician to properly dispose of the TV.

! Note: The lamp unit contains mercury, the disposal of which may be regulated due to environmental considerations. For disposal or recycling information, contact your local authorities or the Electronics Industries Alliance (www.eiae.org).

FCC Declaration of Conformity Compliance Statement (Part 15):

The **Toshiba 27HL95 LCD Color Televisions** comply with Part 15 of the FCC rules.

Operation is subject to the following two conditions: (1) this device may not cause harmful interference, and (2) this device must accept any interference that may cause undesired operation.

The party responsible for compliance to these rules is:
Toshiba America Consumer Products, L.L.C.
82 Totowa Rd. Wayne, NJ 07470.
Ph: (973) 628-8000

Note: This equipment has been tested and found to comply with the limits for a Class B digital device, pursuant to Part 15 of the FCC rules. These limits are designed to provide reasonable protection against harmful interference in a residential installation. This equipment generates, uses, and can radiate radio frequency energy and, if not installed and used in accordance with the instructions, may cause harmful interference to radio communications. However,

there is no guarantee that interference will not occur in a particular installation. If this equipment does cause harmful interference to radio or television reception, which can be determined by removing and applying power to the equipment, the user is encouraged to try to correct the interference by one or more of the following measures:

- Reorient or relocate the receiving antenna.
- Increase the separation between the equipment and the receiver.
- Connect the equipment into an outlet on a circuit different from that to which the receiver is connected.
- Consult the dealer or an experienced radio/TV technician for help.

CAUTION: Changes or modifications to this equipment not expressly approved by Toshiba could void the user's authority to operate this equipment.

Important notes about your LCD TV

The following symptoms are technical limitations of LCD Display technology and are not an indication of malfunction; therefore, Toshiba is not responsible for perceived issues resulting from these symptoms.

1) An afterimage (ghost) may appear on the screen if a fixed, non-moving image is displayed for a long period of time. The afterimage is not permanent and will disappear in a short period of time.

2) The LCD panel contained in this TV is manufactured using an extremely high level of precision technology; however, there may be an occasional pixel (dot of light) that does not operate properly (does not light, remains constantly lit, etc.). This is a structural property of LCD technology, is not a sign of malfunction, and is not covered under your warranty. Such pixels are not visible when the picture is viewed from a normal viewing distance.

Note: Interactive video games that involve shooting a "gun" type of joystick at an on-screen target may not work with this TV.

Contents

Important Safety Information	2-4
FCC Declaration of Conformity Compliance Statement (Part 15):	5
Important notes about your LCD TV	5
Chapter 1: Introduction	7
Welcome to Toshiba	7
Features of your new TV	7
Overview of steps for installing, setting up, and using your new TV	8
Chapter 2: Connecting your TV	9
TV top panel and side panel controls and connections	9
TV back panel connections	10
Overview of cable types	11
About the connection illustrations	12
Connecting a CableCARD™	12
Connecting a VCR and antenna or Cable TV (no Cable box)	13
Connecting a camcorder	13

Connecting a VCR and Cable box	14
Connecting a VCR and satellite receiver	15
Connecting a DVD player with S-video, a VCR, and a Cable box	16
Connecting a DVD player with ColorStream® (component video) and a VCR	17
Connecting two VCRs	18
Connecting an HDMI™ or a DVI device to the HDMI input	19
Connecting a digital audio system	20
G-LINK® connection	21
Connecting a personal computer (PC)	22

Chapter 3: Using the remote control	23
Preparing the remote control for use	23
Installing the remote control batteries	23
Remote control effective range	23
Programming the remote control to operate a cable converter box, satellite receiver, VCR, DVD player, or HTIB (home theater in a box)	24

(Continued on next page)

Contents (Continued from previous page)

Remote control codes	24	Switching between two channels using Channel Return	60
Using the remote control to operate a cable converter box, satellite receiver, VCR, DVD player, or HTIB (home theater in a box)	26	Switching between two channels using SurfLock™	60
Remote Control function key chart	27	Selecting the picture size	61
Learning about the remote control	28	Scrolling the TheaterWide® picture (TheaterWide 2 and 3 only)	63
Chapter 4: Menu layout and navigation	29	Using the auto aspect ratio feature	63
Main menu layout	29	Selecting the cinema mode (480i signals only)	64
Setup/Installation menu layout	30	Using the FREEZE feature	64
Navigating the menu system	30	Adjusting the picture	65
Chapter 5: TV Guide On Screen® setup	31	Selecting the picture mode	65
Setting up the TV Guide On Screen® system	31	Adjusting the picture quality	65
TV Guide On Screen® Reminder	34	Using CableClear®/DNR (digital noise reduction)	66
Turning off the TV Guide On Screen® automatic display feature	34	Selecting the color temperature	66
Chapter 6: Setting up your TV	35	Adjusting the back lighting feature	67
Selecting the menu language	35	Using MPEG noise reduction	67
Configuring the antenna input sources	35	Using dynamic contrast	67
Programming channels into the TV's channel memory	36	Using the closed caption mode	68
Programming channels automatically	36	Advanced closed captions	68
Manually adding and deleting channels in the channel memory	37	Digital closed captions	69
Programming your favorite channels	38	Adjusting the audio	70
Setting the HDMI™ audio mode	39	Muting the sound	70
Setting the time and date	39	Using the digital audio selector	70
Viewing the CableCARD™ menu	40	Selecting stereo/SAP broadcasts	70
Viewing the digital signal meter	40	Adjusting the audio quality	71
Viewing the system status	41	Using the StableSound® feature	71
Chapter 7: Using the TV Guide On Screen® interactive program guide	42	Using the SRS WOW™ surround sound feature	72
Setting up the TV Guide On Screen® system	42	Selecting the optical audio output format	72
Navigating the TV Guide On Screen® system	43	Setting the On/Off timer	73
TV Guide On Screen® remote control functions	43	Setting the sleep timer	73
Video Window	44	Using the PC setting feature	74
Panel Menus	44	PC Audio	74
Info Box	45	Displaying TV setting information on-screen using RECALL	75
TV Guide On Screen® Icons	45	Understanding the auto power off feature	75
TV Guide On Screen® Services	46	Understanding the last mode memory feature	75
LISTINGS screen	46	Using the Grey Level feature	75
SEARCH screen	47	Chapter 9: Using the Locks menu	76
SCHEDULE screen	49	Entering the PIN code	76
Record features	49	If you cannot remember your PIN code	76
Remind features	51	Changing your PIN code	76
SETUP screen	53	Blocking TV programs and movies by rating (V-Chip)	77
Change system settings	53	Blocking channels	78
Change channel display	54	Unlocking programs temporarily	78
Change default options	54	Locking video inputs	78
Chapter 8: Using the TV's features	56	Using the GameTimer™	79
Selecting the video input source to view	56	Using the panel lock feature	79
Labeling the video input sources	57	Chapter 10: Troubleshooting	80
Tuning channels	58	General troubleshooting	80
Using the Channel Browser	58	TV Guide On Screen® FAQs	82
Tuning your favorite channels	60	Chapter 11: Appendix	85
Tuning to the next programmed channel	60	Specifications	85
Tuning to a specific channel (programmed or unprogrammed)	60	Limited United States Warranty	86
		Index	90

1 Introduction

Welcome to Toshiba

Thank you for purchasing this Toshiba TV, one of the innovative LCD TVs on the market.

The goal of this manual is to guide you through setting up and operating your TV as quickly as possible.

See "Important notes about your LCD TV" on page 5.

- This manual applies to model 27HL95. Before you proceed, check the model number on the back of your TV.
- Instructions in this manual are based on using the remote control. You also can use the controls on the TV top panel if they have the same name as those referred to on the remote control. (MENU on the top panel functions as ENTER when a menu is on-screen or when the TV Guide On Screen® system is open.)
- The side panel and back panel provide terminals for connecting other equipment to your TV. See page 9 for top panel and side panel details. See page 10 for back panel details. See pages 12–22 for instructions on connecting other devices to your TV.
- **Please read all safety and operating instructions in this manual carefully, and keep this manual for future reference.**

Features of your new TV

The following are just a few of the many exciting features of your new Toshiba widescreen, integrated HD, LCD TV:

- **Integrated digital tuning (8VSB ATSC and QAM)** eliminates the need for a separate digital converter set-top box (in most cases).
- **TV Guide On Screen®** no-fee interactive program guide (Chapters 5 and 7).
- **Digital CableCARD™ slot** for viewing encrypted digital Cable TV programs (page 12).
- **HDMI (DVI)** digital, high-definition multimedia interface (page 19).
- **ColorStream® HD** high-resolution component video inputs (pages 15 and 17).
- **Dolby Digital*** (page 20) and **SRS WOW™** (page 72) audio technologies.
- **Digital Audio Out** optical audio connection (page 20).
- **CableClear® DNR** digital picture noise reduction (page 66).
- **PC IN (Analog RGB)** computer terminal (page 22).

Note: After you set up the TV Guide On Screen® system (Chapter 5), the program guide opens automatically by default when you turn on the TV. You can turn off the automatic program guide (page 34) and instead press the TV GUIDE button on the remote control to manually open the program guide.

In the United States, TV Guide and other related marks are registered marks of Gemstar-TV Guide International, Inc. and/or one of its affiliates. The TV Guide On Screen® system is manufactured under license from Gemstar-TV Guide International, Inc. and/or one of its affiliates. The TV Guide On Screen® system is protected by one or more of the following issued United States patents 6,498,895; 6,418,556; 6,331,877; 6,239,794; 6,154,203; 5,940,073; 4,908,713; 4,751,578; 4,706,121.

GEMSTAR-TV GUIDE INTERNATIONAL INC. AND/OR ITS RELATED AFFILIATES ARE NOT IN ANY WAY LIABLE FOR THE ACCURACY OR AVAILABILITY OF THE PROGRAM SCHEDULE INFORMATION OR OTHER DATA IN THE TV GUIDE ON SCREEN® SYSTEM AND CANNOT GUARANTEE SERVICE AVAILABILITY IN YOUR AREA. IN NO EVENT SHALL GEMSTAR-TV GUIDE INTERNATIONAL, INC. AND/OR ITS RELATED AFFILIATES BE LIABLE FOR ANY DAMAGES IN CONNECTION WITH THE ACCURACY OR AVAILABILITY OF THE PROGRAM SCHEDULE INFORMATION OR OTHER DATA IN THE TV GUIDE ON SCREEN® SYSTEM.

- This product incorporates copyright protection technology that is protected by U.S. patents and other intellectual property rights. Use of this copyright protection technology must be authorized by Macrovision and is intended for home and other limited pay-per-view uses only, unless otherwise authorized by Macrovision. Reverse engineering or disassembly is prohibited.
- WOW, SRS and (●) symbol are trademarks of SRS Labs, Inc.
- WOW technology is incorporated under license from SRS Labs, Inc.
- *Manufactured under license from Dolby Laboratories. "Dolby", "Pro Logic" and the double-D symbol are trademarks of Dolby Laboratories.
- CableCARD™ is a trademark of Cable Television Laboratories, Inc.

Overview of steps for installing, setting up, and using your new TV

Follow these steps to set up your TV and begin using its many exciting features.

1. **Carefully read the important safety, installation, care, and service information on pages 2–5. Keep this manual for future reference.**
2. **Observe the following when choosing a location for the TV:**
 - Place the TV on the floor or a sturdy, level, stable surface that can support the weight of the unit. Secure the TV to a wall, pillar, or other immovable structure as described on page 3, item 19.
 - Place the TV in a location where light does not reflect on the screen.
 - Place the TV far enough from walls and other objects to allow proper ventilation. Inadequate ventilation may cause overheating, which will damage the TV. **THIS TYPE OF DAMAGE IS NOT COVERED UNDER THE TOSHIBA WARRANTY.**
 - Read “Installation” on pages 3–4.
 - Read “Important notes about your LCD TV” on page 5.
3. **Do not plug in any power cords** until AFTER you have connected all cables and devices to your TV.
4. **BEFORE connecting cables or devices to the TV, learn the functions** of the TV’s connections and controls (pages 9 and 10).
5. **Connect your other electronic device(s) to the TV** (pages 12–22).
6. **Connect the G-LINK® cable** (either one of the enclosed IR blaster cables) from your VCR and/or Cable box (if applicable) to the G-LINK® terminal so you can use the TV Guide On Screen® features (applies to VCRs and cable boxes only). See page 21.
7. **Install the batteries in the remote control** (page 23).
8. **See “Learning about the remote control”** (page 28) **for an overview of the buttons on the remote control.**
9. **Program the remote control to operate your other device(s)** (pages 24–25).
10. **AFTER connecting all cables and devices, plug in the power cords** for your TV and other devices.

“Now Booting...” will be displayed on the screen until the picture appears or the green LED will blink until the TV goes into standby mode.

When the TV is in standby mode, press POWER on the TV top panel or remote control to turn on the TV.
11. **See “Menu layout and navigation” for a quick overview of navigating the TV’s menu system** (pages 29–30).
12. **See Chapter 5 for details on setting up the TV Guide On Screen® system** (if available in your area).
13. **See Chapter 7 for details on using the TV Guide On Screen® program guide** (if available in your area).
14. **Program channels into the TV’s channel memory** (page 36).
15. **For details on using the TV’s features, see Chapter 8.**
16. **For help, refer to the Troubleshooting Guide (Chapter 10).**
17. **For technical specifications and warranty information, see Chapter 11.**
18. **Enjoy your new TV!**

Note: If you sell or transfer this television to a third party, be sure to reset the PIN code as described on page 76 under the heading, “If you cannot remember your PIN code.”

If the TV stops responding to the controls on the remote control or TV top panel and you cannot turn the TV off or on, press and hold the POWER button for 5 seconds to reset the TV.

2 Connecting your TV

TV top panel and side panel controls and connections

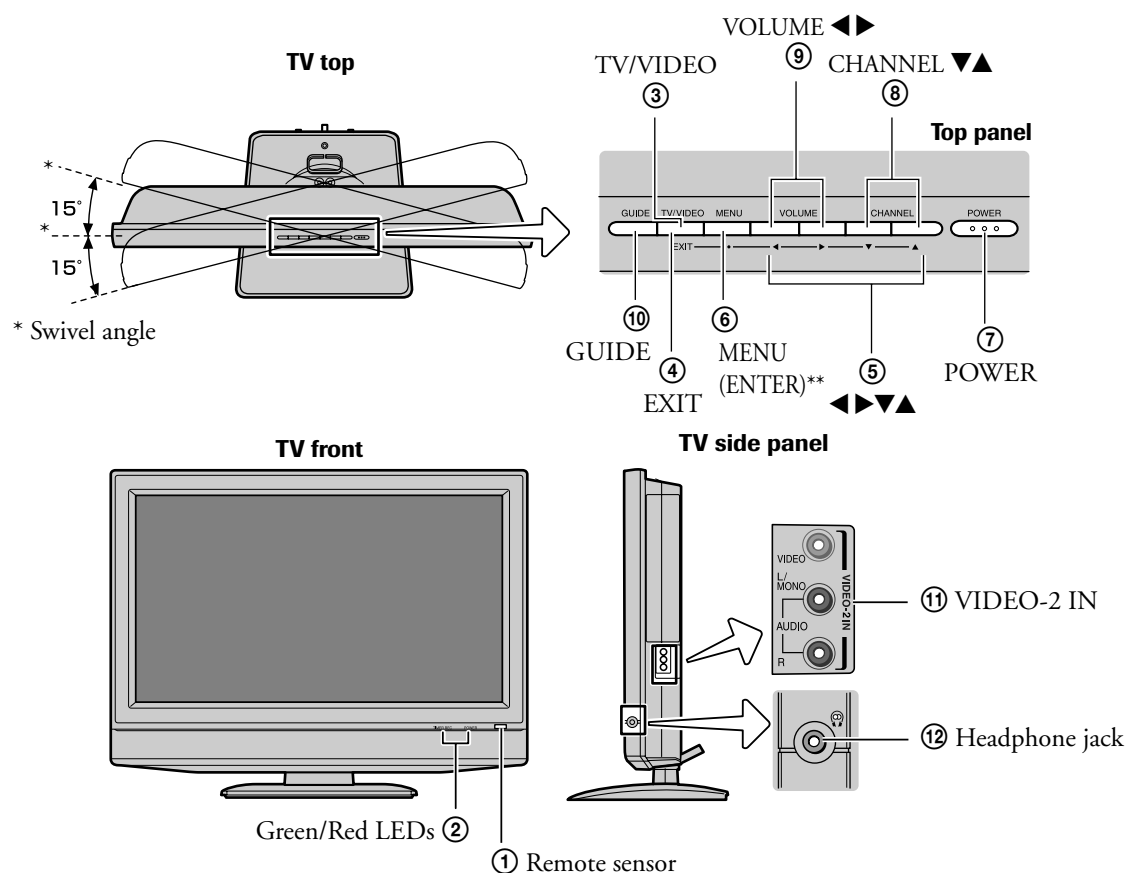

** The MENU button on the TV top panel functions as the ENTER button in the TV Guide On Screen® system or when a menu is on-screen.

- ① **Remote sensor** — Point the remote control toward this remote sensor. See “Remote control effective range” on page 23.
- ② **Green and Red LEDs**
Green — Timer recording indicator
Red — Power indicator
- ③ **TV/VIDEO** — Repeatedly press to change the source you are viewing (ANT 1, ANT 2, VIDEO 1, VIDEO 2, HDMI, ColorStream HD, PC).
- ④ **EXIT** — Press to close an on-screen menu instantly.
- ⑤ **ARROWS ▲▼◀▶** — When a menu is on-screen, these buttons function as up/down/left/right menu navigation buttons.
- ⑥ **MENU (ENTER)** — Press to access the menu system (see page 29). When a menu is on-screen or the TV Guide On Screen® program guide is open, this button functions as the ENTER button (on the top panel only).
- ⑦ **POWER** — Press to turn the TV on and off.
Note: If the TV stops responding to the controls on the remote control or TV top panel and you cannot turn off the TV, press and hold the POWER button on the TV top panel for 5 or more seconds to reset the TV.
- ⑧ **CHANNEL ▲▼** — When no menu is on-screen, these buttons change the channel (programmed channels only; see page 36). When a menu is on-screen, these buttons function as up/down menu navigation buttons.
- ⑨ **VOLUME ◀▶** — When no menu is on-screen, these buttons adjust the volume level. When a menu is on-screen, these buttons function as left/right menu navigation buttons.
- ⑩ **GUIDE** — Press to access the TV Guide On Screen® program guide. (See page 42 for details on using the program guide.)
- ⑪ **VIDEO 2 IN** — One sets of standard (composite) video and standard audio inputs.
- ⑫ **Headphone jack** — For use with headphones.
Note: When the Headphone jack is being used, the sound from all speakers will be muted, and normal sound will be output to the headphones only.

Copyright © 2005 TOSHIBA CORPORATION. All rights reserved.

TV back panel connections

TV upper back panel

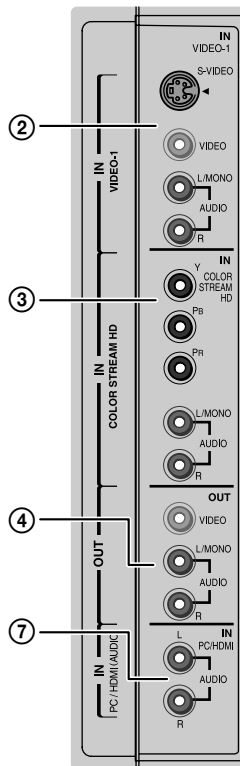

Before connecting an external device to the TV, remove the applicable panel cover by squeezing the tab(s) in the direction of the arrow (→) and pulling the cover.

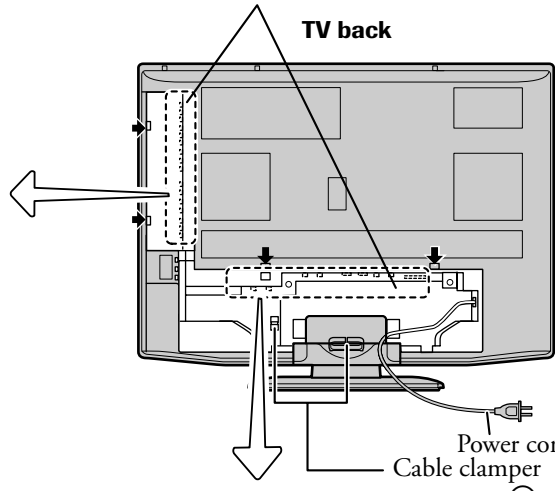

TV lower back panel

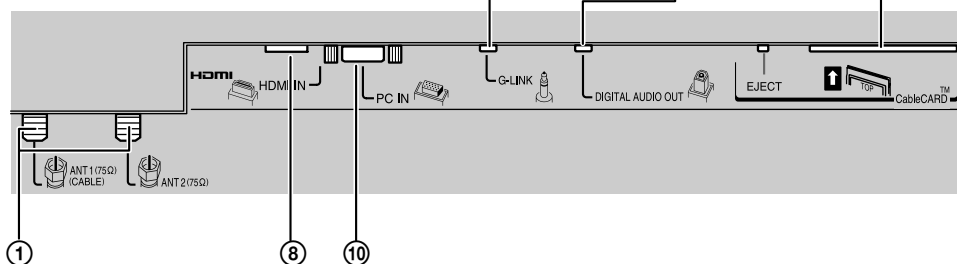

- ① **ANT-1 (CABLE) IN and ANT-2 IN** — Two inputs that support analog (NTSC) and digital (ATSC) off-air antenna signals and analog and digital (QAM) Cable TV signals.
Note: If you have an antenna only, connect it to ANT-1. If you have both cable TV and an antenna, connect the cable TV to ANT-1 and the antenna to ANT-2.
- ② **VIDEO 1 IN** — Standard (composite) video and standard audio inputs plus optional S-video input for connecting devices with composite video or S-video output.
Note: Standard (composite) video and S-video cables carry only video information; separate audio cables are required for a complete connection.
- ③ **ColorStream® HD** — ColorStream® high-definition component video and standard stereo audio inputs for connecting devices with component video output, such as a Toshiba DVD player with ColorStream®. See pages 15 and 17.
Note: Component video cables carry only video information; separate audio cables are required for a complete connection.
- ④ **A/V OUT** — Standard composite video and analog audio outputs for connecting a VCR for editing and dubbing. See page 18 for details.
- ⑤ **DIGITAL AUDIO OUT** — Optical audio output in Dolby Digital or PCM (pulse-code modulation) format for connecting an external Dolby Digital decoder, amplifier, A/V receiver, or home theater system with optical audio input. See page 20.
- ⑥ **G-LINK®** — For use with one of the enclosed IR blaster/G-LINK® cables to enable the TV Guide On Screen® recording features. See page 21.
- ⑦ **PC/HDMI Audio IN** — For use when connecting a personal computer or a DVI device with analog audio output. See pages 19 and 22. Also see items 8 and 10 below.
- ⑧ **HDMI™ IN** — High-Definition Multimedia Interface input receives digital audio and uncompressed digital video from an HDMI device or uncompressed digital video from a DVI device. See page 19.
- ⑨ **CableCARD™ slot** — For use with a digital security card and digital cable TV service (provided by your local cable operator) to view encrypted digital programming. See pages 12 and 40.
- ⑩ **PC IN** — For use when connecting a personal computer (PC). See page 22.

HDMI, the HDMI logo and High-Definition Multimedia Interface are trademarks or registered trademarks of HDMI Licensing LLC.

CableCARD™ is a trademark of Cable Television Laboratories, Inc.

Overview of cable types

Note: One dual-wand IR blaster/G-LINK® cable is included with your TV. All other required cables, if not provided with your other devices, can be purchased at many electronics accessory suppliers.

- **Coaxial (F-type) cable** is used for connecting your antenna, cable TV service, and/or cable converter box to the ANT-1 and/or ANT-2 RF inputs on your TV.
- **Standard A/V cables (composite video)** usually come in sets of three, and are for use with video devices with standard audio and standard (composite) video output. These cables (and the related inputs on your TV) are typically color-coded according to use: yellow for video, red for stereo right audio, and white for stereo left (or mono) audio.
- **S-video cable** is for use with video devices with S-video output. Separate audio cables are required for a complete connection.

Note: An S-video cable provides better picture performance than a composite video cable. If you connect an S-video cable, be sure to disconnect the standard (composite) video cable or the picture performance will be unacceptable.

- **Component video cables** come in sets of three and are for use with video devices with component video output. (ColorStream® is Toshiba's brand of component video.) These cables are typically color-coded red, green, and blue. Separate audio cables are required for a complete connection.

Note: Component video cables provide better picture performance than a standard (composite) video or S-video cable.

- **HDMI cable** is for use with devices with HDMI (High-Definition Multimedia Interface) output. HDMI cable delivers digital audio and video in its native format. This cable carries both video and audio information; therefore, separate audio cables are not required for a complete HDMI device connection. See page 19 for further details.

Note: HDMI cable provides better picture performance than a standard (composite) video or S-video cable.

- **Dual-wand IR blaster/G-LINK® cable** is for use with video devices with IR (infrared) remote control. This cable is for connection to the G-LINK® terminal (page 21) to enable TV Guide On Screen® recording features (Chapters 5 and 7).

Note: The IR blaster/G-LINK® cable included with your TV has specific characteristics that allow them to work properly with this G-LINK® port. **Never use other aftermarket IR blaster or G-LINK® cables with this TV.** Other cables may not function properly and can cause damage. THIS TYPE OF DAMAGE IS NOT COVERED BY YOUR TOSHIBA WARRANTY.

- **Optical audio cable** is for connecting receivers with Dolby Digital or PCM (pulse-code modulation) optical audio input to the TV's DIGITAL AUDIO OUT terminal. See page 20.

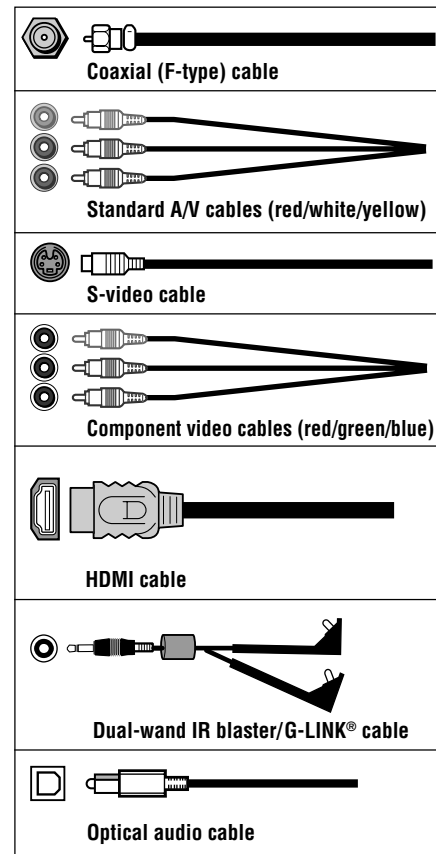

About the connection illustrations

You can connect different types and brands of devices to your TV in several different configurations. The connection illustrations in this manual are representative of typical device connections only. The input/output terminals on your devices may differ from those illustrated herein. For details on connecting and using your specific devices, refer to each device's owner's manual.

Connecting a CableCARD™

This digital television is capable of receiving analog basic, digital basic, and digital premium cable television programming by direct connection to a cable system providing such programming.

A security card (such as a CableCARD™), provided by your cable operator, is required to view encrypted digital programming.

Certain advanced and interactive digital cable services (such as video-on-demand, a cable operator's enhanced program guide, and data-enhanced television services) will not work with the use of a CableCARD™ and may require the use of a separate set-top box from your cable operator.

For more information, call your local cable operator.

You will need:

- ▶ one CableCARD™ (contact your cable operator)
- ▶ digital cable subscription service (contact your cable operator)

To view encrypted digital channels:

1. Connect your digital Cable TV cable to ANT-1.
2. With the front of the CableCARD™ facing up, insert it into the CableCARD™ slot on the back of the TV (see illustration below left).
3. After the CableCARD™ is inserted, a CableCARD™ option appears in the Applications menu, with informational screens provided by your CableCARD™ service. See page 40 for additional information.

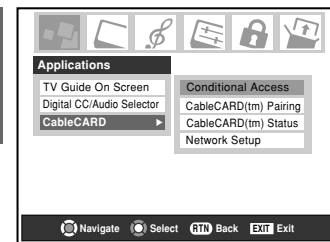
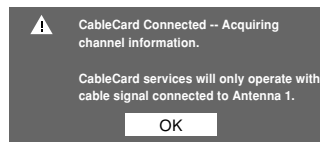

TV lower back panel

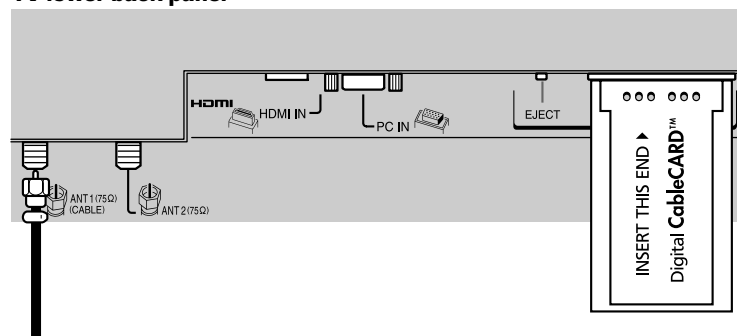

From digital Cable service
(connect to ANT 1 only)

This cable should be connected to ANT 1 terminal directly. If you connect the cable via a VCR, the TV may not receive the signals correctly.

Note:

- Always use the EJECT button to remove the CableCARD™. Never remove the CableCARD™ by hand.
- Never insert any object or card (including, without limitation, a PCMCIA card) other than a CableCARD™ into the CableCARD™ slot.
- Always make sure the CableCARD™ is facing the correct direction.
- Connect the cable for your digital cable TV service to ANT-1 only.
- When using a CableCARD™, channel programming is unnecessary because the CableCARD™ automatically loads the cable channel list into the TV's channel memory (page 36).
- The CableCARD™ may take up to 5 minutes to "pair" with the TV and download channel information. CableCARD™ information and channels will not be available until this process is completed.

CableCARD™ technology, like all new and emerging technology, may from time to time experience compatibility issues due to the different ways in which television manufacturers and cable system operators implement the CableCARD™ specifications. Most issues can be easily resolved. If you experience any performance-related CableCARD™ issues with your Toshiba television, please contact Toshiba Consumer Solutions by calling (800) 631-3811 or by visiting <http://www.tacp.com/customersupport/contact.asp>.

CableCARD is a trademark of Cable Television Laboratories, Inc.

Connecting a VCR and antenna or Cable TV (no Cable box)

You will need:

- ▶ one signal splitter
- ▶ three coaxial cables
- ▶ two sets of standard A/V cables
 - For better picture performance, if your VCR has S-video, use an S-video cable (plus the audio cables) instead of the standard video cable. However, do not connect both types of video cables to VIDEO 1 at the same time or the picture performance will be unacceptable.
 - If you have a mono VCR, connect L/MONO on the TV (VIDEO 1) to your VCR's audio out terminal using the white audio cable only.

To view the antenna or Cable signal:

Select the ANT 1 video input source on the TV.*

To view the VCR:

Turn ON the VCR. Select the VIDEO 1 video input source on the TV.*

To use the TV Guide On Screen® recording features:

1. Connect the G-LINK® cable according to the instructions on page 21.
2. Make sure the VCR is connected to the A/V OUT terminals on the TV (see illustration).
3. Set the VCR to the appropriate line input (refer to your VCR owner's manual for details), and then turn OFF the VCR.
4. See Chapter 5 for details on setting up the TV Guide On Screen® system.
5. See Chapter 7 for details on using the TV Guide On Screen® system.

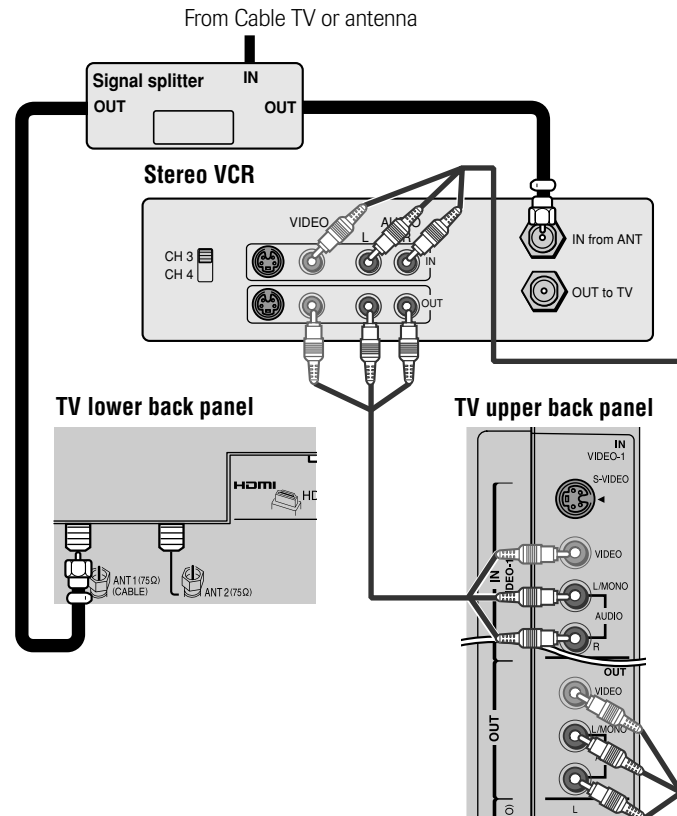

Note: The VIDEO/AUDIO OUT terminals output signals from the ANT 1, ANT 2, VIDEO 1, and VIDEO 2 terminals when the appropriate input mode is selected.

The unauthorized recording, use, distribution, or revision of television programs, videotapes, DVDs, and other materials is prohibited under the Copyright Laws of the United States and other countries, and may subject you to civil and criminal liability.

Connecting a camcorder

You will need:

- ▶ one set of standard A/V cables
 - If you have a camcorder with S-video, you can use an S-video cable instead of a standard video cable for better picture performance. Plug the S-video and standard audio cables into the "VIDEO 1 IN" inputs on the upper back panel of the TV instead of the inputs on the side panel.

To view the camcorder video:

Select the VIDEO 2 video input source (or the VIDEO 1 video input source when you use an S-video cable) on the TV.*

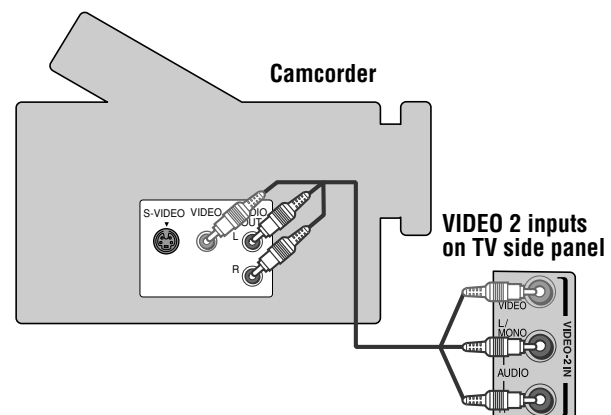

* To select the video input source, press INPUT on the remote control (see page 56).
To program the TV remote control to operate other devices, see Chapter 3.

Connecting a VCR and Cable box

You will need:

- ▶ one signal splitter
- ▶ five coaxial cables
- ▶ two sets of standard A/V cables
 - For better picture performance from your VCR: If your VCR has S-video, connect an S-video cable (plus the audio cables) instead of the standard video cable. Do not connect an S-video cable and a standard video cable to VIDEO 1 at the same time or the picture performance will be unacceptable.
 - If you have a mono VCR, connect L/MONO on the TV (VIDEO 1) to your VCR's audio out terminal using the white audio cable only.
 - When you use a Cable box, you may not be able to use the remote control to program or access certain features on the TV.

To view basic Cable channels and use the TV's features:

Select the ANT 1 video input source on the TV.* Use the TV controls (top panel or remote control) to change channels and access the TV's features.

To view basic and premium Cable channels:

Turn OFF the VCR. Select the ANT 2 video input source on the TV.* Tune the TV to channel 3 or 4 (whichever channel is vacant in your area). Use the Cable box controls to change channels.

To view the VCR:

Turn ON the VCR. Select the VIDEO 1 video input source on the TV.*

Note: A VIDEO 1 connection with an S-Video cable (instead of a standard video cable) will provide better picture performance (as mentioned in the first bulleted item at the top of this page).

* To select the video input source, press INPUT on the remote control (see page 56). To program the TV remote control to operate other devices, see Chapter 3.

The unauthorized recording, use, distribution, or revision of television programs, videotapes, DVDs, and other materials is prohibited under the Copyright Laws of the United States and other countries, and may subject you to civil and criminal liability.

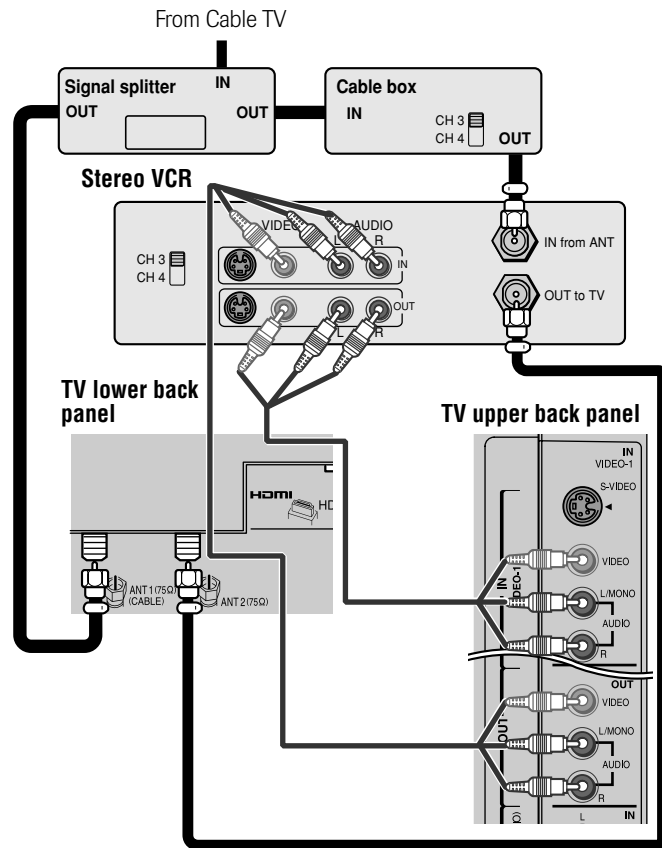

Note: The VIDEO/AUDIO OUT terminals output signals from the ANT 1, ANT 2, VIDEO 1, and VIDEO 2 terminals when the appropriate input mode is selected.

To enable the TV Guide On Screen® system to work with your cable box and to use the TV Guide On Screen® recording features:

1. Connect the G-LINK® cable according to the instructions on page 21.
2. Make sure the VCR is connected to the A/V OUT terminals on the TV (see illustration).
3. Set the VCR to the appropriate line input (refer to your VCR owner's manual for details), and then turn OFF the VCR.
4. See Chapter 5 for details on setting up the TV Guide On Screen® system.
5. See Chapter 7 for details on using the TV Guide On Screen® system.

Connecting a VCR and satellite receiver

You will need:

- ▶ one signal splitter
- ▶ four coaxial cables
- ▶ one set of component video cables (if your satellite receiver does not have component video, connect the standard A/V cables only)
- ▶ one pair of standard audio cables
- ▶ three sets of standard A/V cables
 - For better picture performance, if your satellite receiver and VCR have S-video, connect S-video cables (plus the audio cables) instead of the standard video cables. Do not connect both types of video cable to VIDEO 1 at the same time or the picture performance will be unacceptable.
 - If you have a mono VCR, connect L/MONO on the TV (VIDEO 1) to your VCR's audio out terminal using the white audio cable only.

To view satellite programs using the component video connections:

Select the ColorStream HD video input source on the TV.*

To view satellite programs using the standard video connections or to record satellite programs:

Turn on all three devices. Set the VCR to the appropriate line input (refer to your VCR owner's manual for details). Select the VIDEO 2 video input source on the TV.*

To view the VCR or view and record antenna channels:

Turn ON the VCR. Tune the VCR to the channel you want to watch. Select the VIDEO 1 video input source on the TV.*

* To select the video input source, press INPUT on the remote control (see page 56). To program the TV remote control to operate other devices, see Chapter 3.

To use the TV Guide On Screen® recording features:

1. Connect the G-LINK® cable according to the instructions on page 21.
2. Make sure the VCR is connected to the A/V OUT terminals on the TV (see illustration).
3. Set the VCR to the appropriate line input (refer to your VCR owner's manual for details), and then turn OFF the VCR.
4. See Chapter 5 for details on setting up the TV Guide On Screen® system.
5. See Chapter 7 for details on using the TV Guide On Screen® system.

Note: The TV Guide On Screen® system does not receive program listings from or for any satellite service.

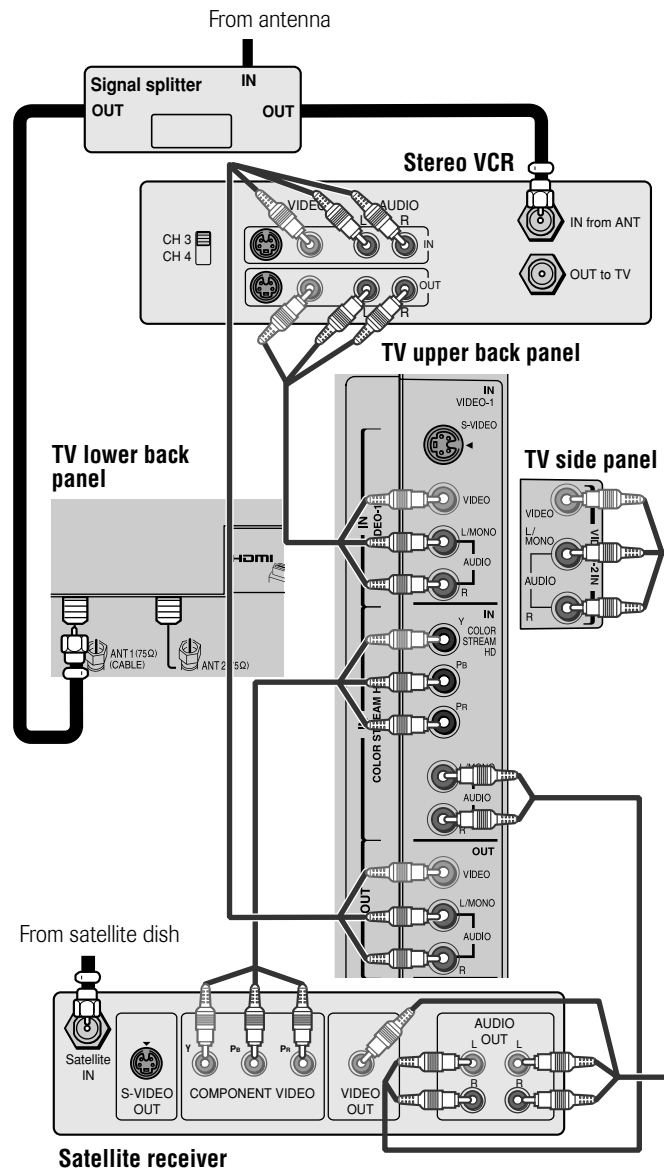

Note: The VIDEO/AUDIO OUT terminals output signals from the ANT 1, ANT 2, VIDEO 1, and VIDEO 2 terminals when the appropriate input mode is selected.

The unauthorized recording, use, distribution, or revision of television programs, videotapes, DVDs, and other materials is prohibited under the Copyright Laws of the United States and other countries, and may subject you to civil and criminal liability.

Connecting a DVD player with S-video, a VCR, and a Cable box

You will need:

- ▶ one signal splitter
- ▶ five coaxial cables
- ▶ two sets of standard A/V cables

Note: If you have a mono VCR, connect L/MONO on the TV (VIDEO 1) to your VCR's audio out terminal using the white audio cable only.

- ▶ one S-video cable
- ▶ one pair of standard audio cables

Note:

- If your DVD player does not have S-video, use a standard video cable instead. Do not connect an S-video cable and a standard video cable to VIDEO 1 at the same time or the picture performance will be unacceptable.
- If your DVD player has component video, see page 17.
- Do not connect the DVD player and VCR to the same set of A/V inputs on the TV. (See the illustration, which shows the VCR connected to VIDEO 2 on the TV, and the DVD player connected to VIDEO 1.)

To view basic channels and access the TV's features:

Select the ANT 1 video input source.* Use the TV controls to change channels and access the TV's features.

To view premium Cable channels:

Turn OFF the VCR. Select the ANT 2 video input source on the TV.* Tune the TV to channel 3 or 4 (whichever channel is vacant in your area). Use the Cable box controls to change channels.

Note: When you use a Cable box, you may not be able to use the remote control to program or access certain features on the TV.

To view the DVD player:

Turn ON the DVD player. Select the VIDEO 1 video input source on the TV.*

To view VCR:

Turn ON the VCR. Select the VIDEO 2 video input source on the TV.*

* To select the video input source, press INPUT on the remote control (see page 56). To program the TV remote control to operate other devices, see Chapter 3.

The unauthorized recording, use, distribution, or revision of television programs, videotapes, DVDs, and other materials is prohibited under the Copyright Laws of the United States and other countries, and may subject you to civil and criminal liability.

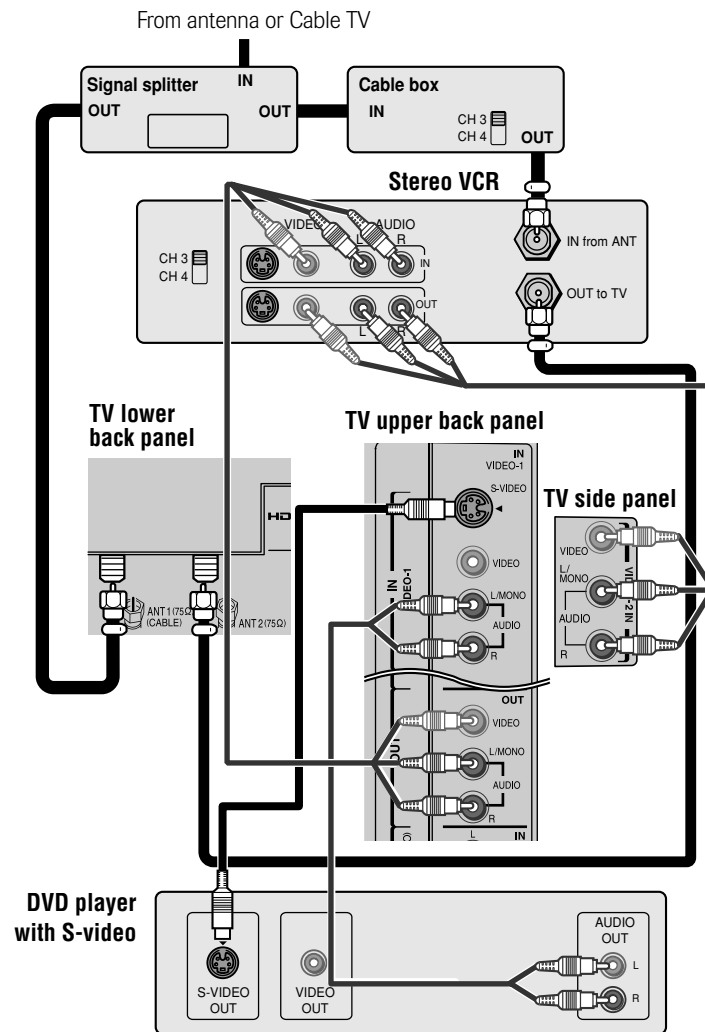

Note: The VIDEO/AUDIO OUT terminals output signals from the ANT 1, ANT 2, VIDEO 1, and VIDEO 2 terminals when the appropriate input mode is selected.

To enable the TV Guide On Screen® system to work with your cable box and to use the TV Guide On Screen® recording features:

1. Connect the G-LINK® cable according to the instructions on page 21.
2. Make sure the VCR is connected to the A/V OUT terminals on the TV (see illustration).
3. Set the VCR to the appropriate line input (refer to your VCR owner's manual for details), and then turn OFF the VCR.
4. See Chapter 5 for details on setting up the TV Guide On Screen® system.
5. See Chapter 7 for details on using the TV Guide On Screen® system.

Connecting a DVD player with ColorStream® (component video) and a VCR

Your TV has ColorStream® (component video) inputs.

You will need:

- ▶ one signal splitter
- ▶ three coaxial cables
- ▶ two sets of standard A/V cables
 - For better picture performance, if your VCR has S-video, use an S-video cable (plus the audio cables) instead of the standard video cable. However, do not connect both types of video cable to VIDEO 1 at the same time or the picture performance will be unacceptable.
 - If you have a mono VCR, connect L/MONO on the TV (VIDEO 1) to your VCR's audio out terminal using the white audio cable only.
- ▶ one pair of standard audio cables
- ▶ one set of component video cables
 - You can connect the component video cables (plus audio cables) from the DVD player to the ColorStream terminal on the TV. The ColorStream HD terminal can be used with Progressive (480p, 720p) and Interlaced (480i, 1080i) scan systems. A 1080i signal will provide the best picture performance.
 - If your DVD player does not have component video, see page 16. If your DVD player has HDMI video, see page 19.

- To view antenna or Cable channels:**
Select the ANT 1 video input source on the TV.*
- To view the DVD player:**
Turn ON the DVD player. Select the ColorStream HD video input source on the TV.*
- To view the VCR:**
Turn ON the VCR. Select the VIDEO 1 video input source on the TV.*
- To record a TV program while watching a DVD:**
Turn ON the VCR. Tune the VCR to the channel to record. Select the ColorStream HD video input source on the TV* to view the DVD.

* To select the video input source, press INPUT on the remote control (see page 56). To program the TV remote control to operate other devices, see Chapter 3.

The unauthorized recording, use, distribution, or revision of television programs, videotapes, DVDs, and other materials is prohibited under the Copyright Laws of the United States and other countries, and may subject you to civil and criminal liability.

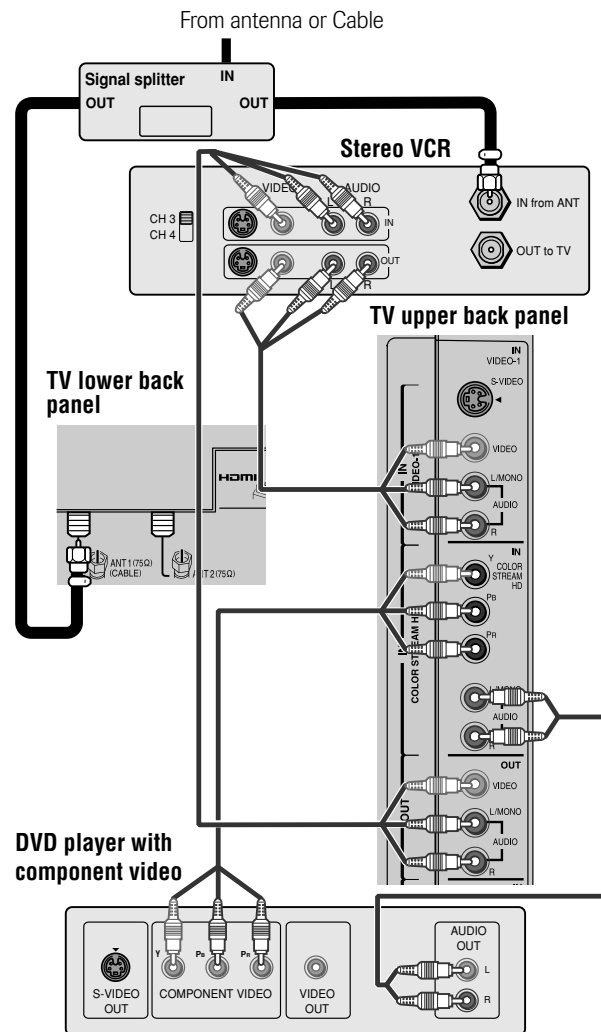

Note: The VIDEO/AUDIO OUT terminals output signals from the ANT 1, ANT 2, VIDEO 1, and VIDEO 2 terminals when the appropriate input mode is selected.

- To use the TV Guide On Screen® recording feature:**
 1. Connect the G-LINK® cable according to the instructions on page 21.
 2. Make sure the VCR is connected to the A/V OUT terminals on the TV (see illustration).
 3. Set the VCR to the appropriate line input (refer to your VCR owner's manual for details), and then turn OFF the VCR.
 4. See Chapter 5 for details on setting up the TV Guide On Screen® system.
 5. See Chapter 7 for details on using the TV Guide On Screen® system.

Connecting two VCRs

You will need:

- ▶ one signal splitter
- ▶ three coaxial cables
- ▶ two sets of standard A/V cables
 - For better picture performance, if VCR 1 has S-video, use an S-video cable (plus the audio cables) instead of the standard video cable. However, do not connect both types of video cable to VIDEO 1 at the same time or the picture performance will be unacceptable.
 - If VCR 1 has mono audio, connect L/MONO on the TV (VIDEO 1) to the audio out terminal on VCR 1 using the white audio cable only.
 - Do not connect the same VCR to the output and input terminals on the TV at the same time.

To view the antenna or Cable signal:

Select the ANT 1 video input source on the TV.*

To view VCR 1:

Turn ON VCR 1. Select the VIDEO 1 video input source on the TV.*

To dub or edit from VCR 1 to VCR 2:

Turn ON both VCRs. Set VCR 2 to the appropriate line input (refer to your VCR owner's manual for details). Select the VIDEO 1 video input source on the TV.*

Note:

- If you have a Cable box, connect the Cable box and splitter to VCR1 as shown on page 14.
- The VIDEO OUT signal incorporates Macrovision® copyright protection technology, which may prevent you from recording certain copy-restricted video materials.***

* To select the video input source, press INPUT on the remote control (see page 56). To program the TV remote control to operate other devices, see Chapter 3.

** Do not connect the unit through a VCR. Video signals fed through VCRs may be affected by copyright protection systems and the picture will be distorted on the television.

*** This product incorporates copyright protection technology that is protected by U.S. patents and other intellectual property rights. Use of this copyright protection technology must be authorized by Macrovision and is intended for home and other limited pay-per-view uses only, unless otherwise authorized by Macrovision. Reverse engineering or disassembly is prohibited. Macrovision is a registered trademark of Macrovision Corporation.

The unauthorized recording, use, distribution, or revision of television programs, videotapes, DVDs, and other materials is prohibited under the Copyright Laws of the United States and other countries, and may subject you to civil and criminal liability.

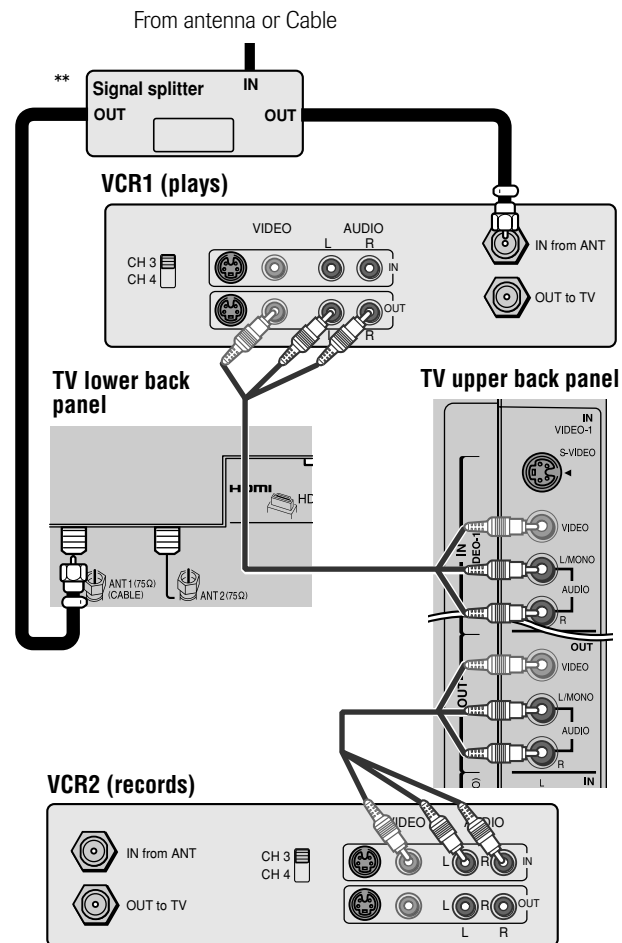

Note: The VIDEO/AUDIO OUT terminals output signals from the ANT 1, ANT 2, VIDEO 1, and VIDEO 2 terminals when the appropriate input mode is selected.

To use the TV Guide On Screen® recording feature:

1. Connect the G-LINK® cable according to the instructions on page 21.
2. Make sure the VCR is connected to the A/V OUT terminals on the TV (see illustration).
3. Set the VCR to the appropriate line input (refer to your VCR owner's manual for details), and then turn OFF the VCR.
4. See Chapter 5 for details on setting up the TV Guide On Screen® system.
5. See Chapter 7 for details on using the TV Guide On Screen® system.

Connecting an HDMI™ or a DVI device to the HDMI input

The HDMI^[1] input on your TV receives digital audio and uncompressed digital video from an HDMI device or uncompressed digital video from a DVI^[2] device.

This input is designed to accept HDCP^[3] program material in digital form from EIA/CEA-861/861B-compliant^[4] consumer electronic devices (such as a set-top box or DVD player with HDMI or DVI output).

The HDMI input is designed for best performance with 720p signals but will also accept and display 1080i, 480i, and 480p signals.



NOTE: DO NOT CONNECT A PC USING THE HDMI PORT.

ALWAYS use the VGA port provided to connect a PC.

To connect an HDMI device, you will need:

- one HDMI cable (type A connector) per HDMI device

For proper operation, it is recommended that you use as short an HDMI cable as possible.

HDMI cable transfers both video and audio. Separate analog audio cables are not required (see illustration below). Some DVDs (video CDs) may not output digital audio signals. In that case, you may hear sound by connecting analog audio cables.

See "Setting the HDMI audio mode" on page 39.

HDMI device

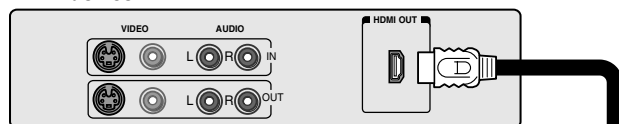

TV lower back panel

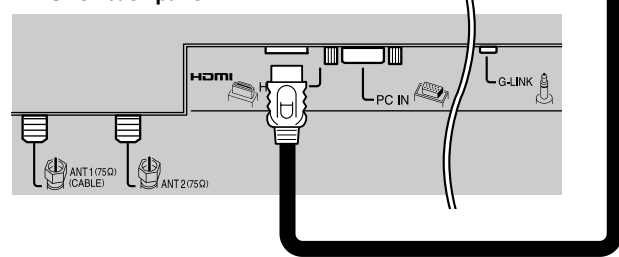

^[1] HDMI = High-Definition Multimedia Interface.

^[2] DVI = Digital Video Interface.

^[3] HDCP = High-bandwidth Digital Content Protection.

^[4] EIA/CEA-861/861B compliance covers the transmission of uncompressed digital video with high-bandwidth digital content protection, which is being standardized for reception of high-definition video signals. Because this is an evolving technology, it is possible that some devices may not operate properly with the TV.

Note: To ensure that the HDMI or DVI device is reset properly, it is recommended that you follow these procedures:

- When turning on your electronic components, **turn on the TV first**, and then the HDMI or DVI device.
- When turning off your electronic components, **turn off the HDMI or DVI device first**, and then the TV.

To connect a DVI device, you will need:

- one HDMI-to-DVI adapter cable (HDMI type A connector) per DVI device

For proper operation, the length of an HDMI-to-DVI adapter cable should not exceed 9.8 ft (3m). The recommended length is 6.6 ft (2m).

- one pair of standard analog audio cables per DVI device

An HDMI-to-DVI adapter cable transfers video only. Separate analog audio cables are required (see illustration below).

See "Setting the HDMI audio mode" on page 39.

DVI device

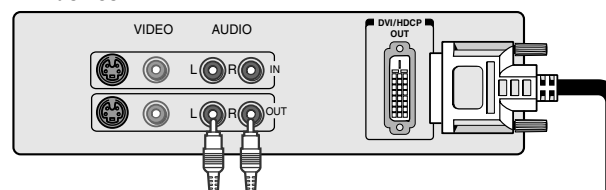

TV upper back panel

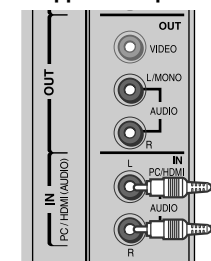

TV lower back panel

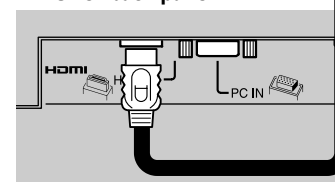

HDMI, the HDMI logo and High-Definition Multimedia Interface are trademarks or registered trademarks of HDMI Licensing LLC.

Connecting a digital audio system

The TV's DIGITAL AUDIO OUT terminal outputs a Dolby Digital  or 2-channel down-mixed PCM (pulse-code modulation) signal for use with an external Dolby Digital decoder or other external audio system with optical audio input.

You will need:

- ▶ one optical audio cable (Use an optical audio cable that has the larger "TosLink" connector and not the smaller "mini-optical" connector.)

To control the audio:

Turn on the TV and the digital audio device.

Press MENU on the TV's remote control and open the Audio menu.

Highlight Audio Setup and press ENTER.

In the Optical Output Format field, select either Dolby Digital or PCM, depending on your device (see "Selecting the optical audio output format" on page 72).

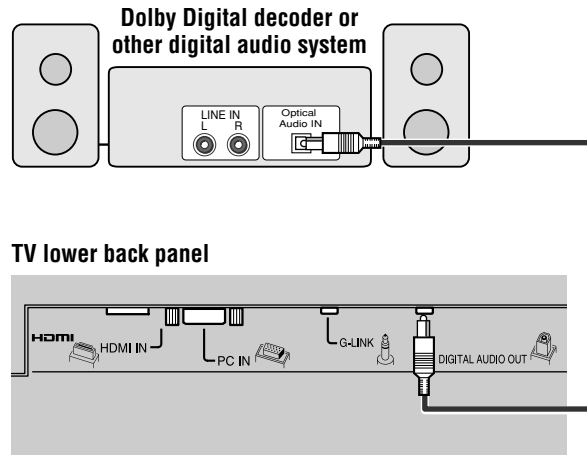
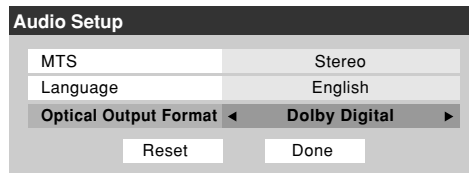
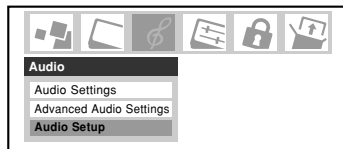

Note:

- Some audio systems may not be compatible with Dolby Digital bitstream signals. Older audio systems that are not compatible with standard optical out signals may not work properly, creating a high noise level that may damage speakers or headphones. **THIS DAMAGE IS NOT COVERED BY YOUR WARRANTY.**
- The DIGITAL AUDIO OUT terminal may not output some digital audio sources because of copy restrictions.
- The DIGITAL AUDIO OUT terminal outputs signals only when receiving digital broadcasts.

G-LINK® connection

- **This connection is necessary for the TV Guide On Screen® system to work with your cable box to receive program listings and to enable the TV Guide On Screen® recording features with your VCR.**

After you connect your devices to the TV, you will need to connect the G-LINK® cable (either of the dual-wand IR blaster cables included with your TV) from your VCR and Cable box (if applicable) to the G-LINK® terminal on the TV.

Note: TV Guide On Screen® program data is available through the ANT-1 and ANT-2 antenna inputs and also through the VIDEO 1 inputs if you have a cable box connected to VIDEO 1. TV Guide On Screen® program data is not available through any other inputs on this TV. See the connection information on pages 12–22.

The G-LINK® connection is necessary to enable the following features of your TV Guide On Screen® system:

- If you have a Cable box, you need to connect the G-LINK® cable from the Cable box to the G-LINK® terminal to receive the TV Guide On Screen® program listings for your Cable service.
- If you have a VCR, you need to connect the G-LINK® cable from the VCR to the G-LINK® terminal to use the TV Guide On Screen® recording features.

To connect to the G-LINK® terminal:

1. Locate the infrared sensor on the front of your VCR or Cable box. The sensor is marked on some devices.*
2. Align one of the G-LINK® (IR blaster) cable's wands about 1 inch away from the infrared sensor on the front of the VCR and attach it using double-sided mounting tape.

If you have a Cable box, attach the other wand in a similar manner. (See illustration at right.)

Note: If you do not have a Cable box, coil the second wand with a rubber band and leave it behind the TV.

3. Plug the G-LINK® (IR blaster) cable's plug into the TV's G-LINK® terminal.

For details on setting up the TV Guide On Screen® system:

See Chapter 5.

For details on using the TV Guide On Screen® interactive program guide:

See Chapter 7.

*If you cannot locate the device's infrared sensor:

1. Turn OFF the device.
2. Starting at the lower left corner of the device, place the end of the device's remote control (with the infrared emitter) so it touches the front of the device and press POWER. (Do not use the TV's remote control for this step.)
3. If the device turns on, the point at which the remote control touched the device is the location of the sensor.
4. If the device does not turn on, move the remote control slightly to the right and press POWER again.
5. Repeat step 4 until you locate the device's infrared sensor.

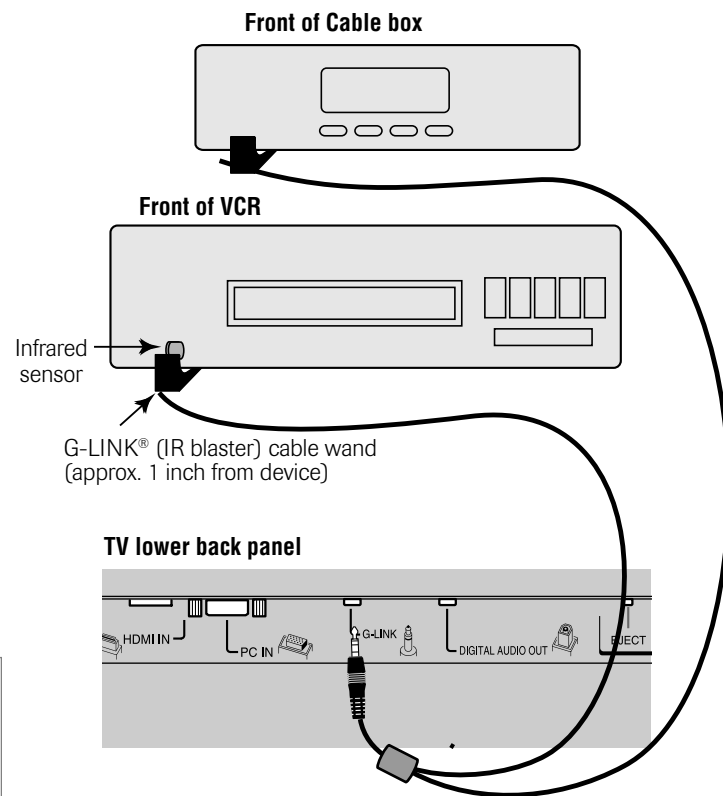

Connecting a personal computer (PC)

This connection allows you to view the image of a personal computer (PC) on the TV screen. When connecting a PC to the TV, use an analog RGB (15-pin) computer cable and a PC audio cable.

– To use a PC, set the monitor output resolution on the PC before connecting it to the TV. The following signals can be displayed.

- VGA: 640 × 480 @ 60Hz
- SVGA: 800 × 600 @ 60Hz
- XGA: 1024 × 768 @ 60Hz

Other formats or non-standard signals may not be displayed correctly.

– To display the optimum picture, use the PC setting feature. (see “Using the PC setting feature” on page 74).

Signal names for mini D-sub 15 pin connector

Pin assignment for RGB/PC terminal	
Pin No.	Signal name
1	R
2	G
3	B
4	NC (not connected)
5	NC
6	Ground
7	Ground
8	Ground
9	NC
10	Ground
11	NC
12	NC
13	H-sync
14	V-sync
15	NC

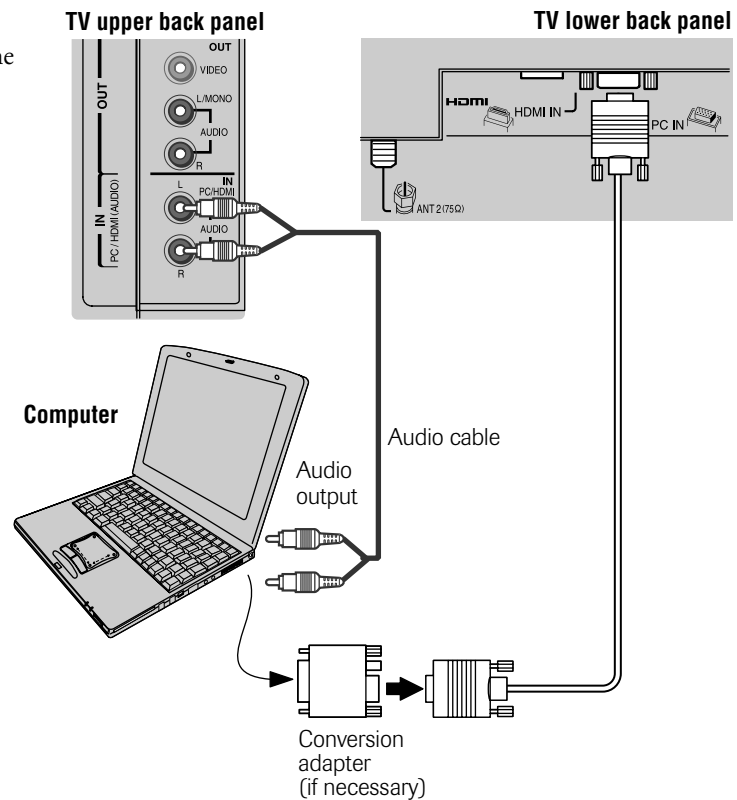

Note:

- Some PC models cannot be connected to this TV.
- An adapter is not needed for computers with a DOS/V compatible mini D-sub 15-pin terminal.
- Depending on the DVD's title and the specifications of the PC on which you are playing the DVD-Video, some scenes may be skipped or you may not be able to pause during multi-angle scenes.

3 Using the remote control

Preparing the remote control for use

Your TV remote control can operate your TV and many other devices such as cable converter boxes, satellite receivers, VCRs, DVD players, and HTIBs (home theater in a box), even if they are different brands.

If you have a Toshiba device:

Your TV remote control is preprogrammed to operate most Toshiba devices. See page 27.

If you have a non-Toshiba device or a Toshiba device that the remote control is not preprogrammed to operate:

You can program the TV remote control so it will operate the other device. See pages 24–25.

Installing the remote control batteries

1. Remove the battery cover from the back of the remote control.

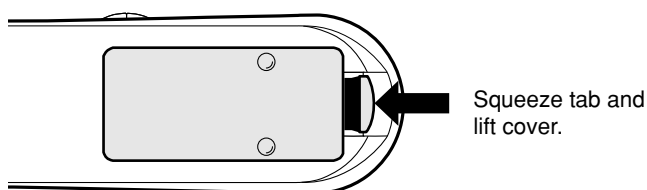

2. Install two “AA” size batteries, making sure to match the + and – signs on the batteries to the signs on the battery compartment.

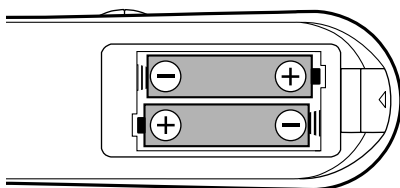

3. Reinsert the battery cover in the remote control until the tab snaps.

Caution:

Never throw batteries into a fire.

Note:

- Be sure to use AA size batteries.
- Dispose of batteries in a designated disposal area.
- Batteries should always be disposed of with the environment in mind. Always dispose of batteries in accordance with applicable laws and regulations.
- If the remote control does not operate correctly, or if the operating range becomes reduced, replace batteries with new ones.
- When necessary to replace batteries in the remote control, always replace both batteries with new ones. Never mix battery types or use new and used batteries in combination.
- Always remove batteries from remote control if they are dead or if the remote control is not to be used for an extended period of time. This will prevent battery acid from leaking into the battery compartment.

Remote control effective range

For optimum performance, aim the remote control directly at the TV and make sure there is no obstruction between the remote control and the TV.

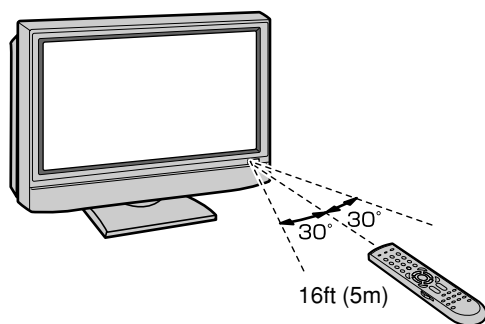

Programming the remote control to operate a cable converter box, satellite receiver, VCR, DVD player, or HTIB (home theater in a box)

Your Toshiba TV remote control is preprogrammed to operate most Toshiba devices. To program your TV remote control to operate a non-Toshiba device (or a Toshiba device that it is not preprogrammed to operate), follow the steps below. For details on using the remote control to operate the device, see pages 26–27.

1. In the remote control code table (below and on the next page), find the code for your device. If more than one code is listed, try each one separately until you find one that works.
2. Set the Device Switch to the type of device you are programming the remote control to operate — **CBL/SAT** (for a cable converter box or satellite receiver), **VCR** (for a VCR or TV/VCR combo), or **DVD** (for a DVD player or HTIB [home theater in a box]).
3. While holding down **RECALL**, press the **Channel Number** buttons to enter the 3-digit code for your device.
4. To test the code, turn on the device, point the remote control at it, and press **POWER**. *See note at right.*
 - If the correct code was entered, the device will turn off.
 - If the device does not respond, repeat steps 1–4 using another code.
 - If the device does not respond to another code, you will need to use the remote control that came with the device.
5. Remember to set the **Device Switch** back to **TV** to control the TV.
6. For future reference, write down the code(s) you used:

DEVICE	CODE	DEVICE	CODE

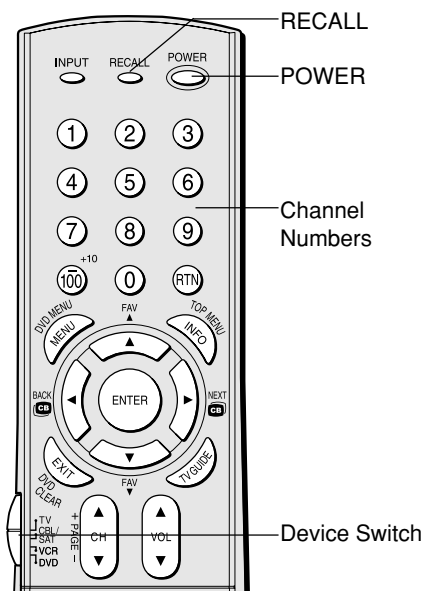

Note:

- In addition to **POWER**, confirm that all necessary keys on the TV remote control operate your device. If some keys are not operational, repeat the device code setup using another code (if other codes are listed for your device). If, after trying all listed codes, the necessary keys do not operate your device, use the device's original remote control.
- Every time you change the batteries, you will need to reprogram the remote control.
- Some newer VCRs respond to either of two codes. These VCRs have a switch labeled "VCR1/VCR2." If your VCR has this kind of switch and does not respond to the codes for your VCR brand, set the switch to the other position ("VCR1" or "VCR2") and reprogram the remote control.

Remote control codes

In some cases you may not be able to operate your device with the TV remote control. Your other device may use a code that is not recognized by the TV remote control. If this happens, use the device's remote control.

Cable converter box ABC: 061, 062, 063, 082, 084, 087, 091, 092, 096, 098 Archer: 065, 092, 097, 099 Cableview: 064, 094 Century: 092 Citizen: 090, 092, 097 Contec: 083, 085, 086, 088, 093, 098 Diamond: 093 Eagle: 091 GE: 061, 062 Gemini: 069, 070, 094 General Instruments: 062, 089, 096	Hamlin: 093 Hitachi: 062, 095, 096 Jasco: 097 Jerrold: 062, 069, 071, 082, 086, 089, 091, 096 Magnavox: 072, 096 Memorex: 091, 092, 104 Multi Canal: 090 Novavision: 101 Panasonic: 081, 083, 085 Philco: 087 Philips: 066, 067, 068, 070, 072, 073, 074, 075, 091, 092 Pioneer: 076, 077 Proscan: 061, 062 Radio Shack: 092, 097, 099	RCA: 064, 081 Realistic: 065 Recoton: 102 Samsung: 077, 090 Scientific Atlanta: 063, 078, 079, 080, 088, 098, 101, 105 Sears: 095 Signature: 062 Signature 2000: 096 Sprucer: 081, 085 Starcom: 069, 082, 087, 096, 103, 104 Stargate: 069, 090 Sylvania: 095, 100 TeleView: 090 Texscan: 100 Tocom: 071, 084, 085	U. S. Electronics: 087, 096, 098 United Cable: 082 Universal: 065, 092, 097, 099, 102, 103 Wards: 096	General Instruments: 010, 011, 012, 022, 023, 031, 049 Hitachi: 033 Hughes: 033 Hughes Network Systems: 019 Intersat: 048 Janeil: 027 JVC: 017, 057 Kenwood: 029 Magnavox: 060 Optimus: 058 Pansat: 036, 052 Primestar: 015, 042 Proscan: 008, 009, 013 Radio Shack: 022, 023, 030
	Satellite receiver Alphastar: 038, 059 Chaparral: 034 DISH Network: 057 Drake: 020, 040, 044, 046, 050, 053 Echostar: 018, 041, 051 Express Vu: 057 Fujitsu: 027 GE: 008, 009, 013			

Remote control codes (cont.)

Satellite receiver (cont.)

RCA: 008, 009, 013, 016
 Realistic: 030
 Samsung: 059
 Sony: 014, 055
 Star Choice: 057
 Star Trak: 025, 026, 037, 054
 STS: 024
 Toshiba: 000, 001, 002, 003, 004, 005, 006, 007, 020, 031, 056
 Uniden: 021, 028, 030, 032, 035, 039, 043, 045, 047, 058
 Zenith: 027

TV/VCR Combo

Action: 078
 GE: 059, 062
 Goldstar: 065
 Panasonic: 065
 Precision: 078
 Quasar: 065
 Realistic: 079
 Sony: 074
 Toshiba: 057
 Totevision 009, 010, 065
 Zenith: 065

DVD/VCR Combo

Go Video:
 DVD=087, VCR=081
 JVC:
 DVD=088, VCR=082
 RCA:
 DVD=089, VCR=083
 Samsung:
 DVD=090, VCR=084
 Sanyo:
 DVD=091, VCR=085
 Zenith:
 DVD=092, VCR=086

DVD player

Aiwa: 006, 015
 Apex: 016, 017
 BOSE: 097
 Broksonic: 018
 Clarion: 019
 Classic: 020
 Daewoo: 021
 Denon: 022, 023, 024, 025
 Emerson: 026, 027
 Fisher: 028
 Funai: 027
 GE: 001, 029, 030
 Go Video: 087

GPX: 031
 Hitachi: 005, 032, 033, 034, 035
 JVC: 003, 007, 036, 042, 088
 Kenwood: 037
 Konka: 008, 009
 Magnavox: 004, 038
 Memorex: 039
 Mintek: 040
 NAD: 026
 Nakamichi: 041
 Norcent: 043
 Onkyo: 044
 Oritron: 058
 Panasonic: 010, 045, 046, 047, 048, 049, 050
 Philips: 004, 051
 Pioneer: 052, 053, 054, 055
 Proscan: 001, 056
 Qwestar: 057, 058
 RCA: 001, 002, 059, 089
 Sampo: 060
 Samsung: 061, 062, 086, 090
 Sansui: 073
 Sanyo: 063, 091
 Sharp: 064, 067
 Sherwood: 074
 Sony: 011, 012, 065, 066, 068, 069, 070
 Sylvania: 027
 Teac: 071
 Technics: 072
 Techwood: 075
 Toshiba: 000, 013, 076, 077, 078
 Yamaha: 079, 080, 081
 Zenith: 014, 082, 092

Portable DVD player

Aiwa: 093
 Audiovox: 094, 095
 Panasonic: 024, 096, 099
 RCA: 098

VCR

Admiral: 049
 Aiko: 019
 Aiwa: 018
 Akai: 003, 004, 037, 038, 039, 058, 069
 Audiovox: 010
 Bell & Howell: 007, 068
 Broksonic: 008, 017
 Calix: 010
 Carver: 026
 CCE: 019
 Citizen: 009, 010, 011, 012, 013, 014, 015, 019, 057, 073

Colorlyme: 005
 Craig: 009, 010, 016, 061, 065, 079
 Curtis Mathes: 001, 005, 009, 012, 014, 040, 048, 053, 056, 057
 Daewoo: 011, 013, 015, 017, 018, 019, 057, 078
 Daytron: 078
 Denon: 063
 Dimensia: 001, 048
 Electrohome: 010, 020, 065
 Emerson: 003, 008, 010, 011, 017, 018, 020, 028, 039, 054, 057, 062, 065, 068, 072
 Fisher: 007, 016, 021, 022, 023, 057, 064, 068, 070, 071, 079
 Fuji: 004, 041
 Funai: 018, 073
 Garrard: 018
 GE: 001, 002, 009, 040, 042, 048, 056
 Go Video: 056, 059, 061, 081
 Goldstar: 005, 010, 014, 054, 056, 065, 067
 Gradiente: 018, 065
 Harman Kardon: 005
 Hitachi: 024, 025, 035, 037, 042, 063, 070, 080
 JBL: 076
 JC Penney: 005, 006, 007, 008, 009, 010, 023, 024, 025, 026, 035, 056, 061, 063, 065
 Jensen: 024, 025, 037
 JVC: 005, 006, 007, 014, 037, 043, 062, 063, 068, 082
 Kenwood: 005, 006, 007, 012, 014, 037, 043, 053, 068, 071
 Kodak: 010
 LG: 010
 Lloyds: 053, 073, 079
 Logik: 061
 LXI: 010
 Magnasonic: 061, 065, 078
 Magnavox: 026, 027, 034, 044, 057, 061, 072
 Marantz: 005, 006, 007, 012, 014, 026, 053, 067

Memorex: 007, 009, 010, 016, 018, 034, 049, 063, 065, 066, 068, 075, 079
 MGA: 020, 028, 039
 MGN: 056
 Minolta: 024, 025, 035, 063
 Mitsubishi: 020, 024, 025, 028, 039, 043, 065
 Montgomery Ward: 049
 Motorola: 049
 MTC: 009, 046, 061
 Multitech: 009, 012, 018
 NEC: 005, 006, 007, 012, 014, 037, 043, 053, 054, 067, 070
 Nikko: 010
 Noblex: 009
 Optimus: 010, 049, 065
 Optonica: 031
 Orion: 054, 057, 062, 065, 068, 072
 Panasonic: 036, 045, 046, 057, 061, 072, 079
 Pentax: 012, 024, 025, 035, 042, 053, 063
 Pentex Research: 014
 Philco: 026, 027, 063
 Philips: 026, 031, 044, 057
 Pioneer: 006, 024, 043, 055
 Portland: 012, 013, 015
 Proscan: 001, 002, 048
 Proton: 061
 Quasar: 045
 Radio Shack: 010, 031, 065
 Radio Shack/Realistic: 007, 009, 010, 016, 018, 020, 021, 022, 031, 049
 Radix: 010
 RCA: 001, 002, 003, 009, 024, 025, 029, 035, 040, 042, 045, 048, 055, 056, 063, 071, 083
 Realistic: 007, 009, 010, 011, 016, 018, 020, 021, 022, 031, 049, 051, 056, 060, 065, 075, 079
 Ricoh: 047
 Runco: 034
 Samsung: 009, 011, 038, 056, 073, 084
 Sansui: 006, 037, 043, 061

Sanyo: 007, 009, 016, 054, 064, 068, 071, 075, 079, 085
 Scott: 008, 011, 017, 028, 030, 057, 065, 072
 Sears: 007, 010, 016, 021, 022, 023, 024, 025, 035, 053, 057, 063, 064, 065, 068, 071, 075, 079
 Sharp: 013, 020, 031, 049, 051, 060, 066
 Shintom: 004, 025, 032, 061
 Signature: 049
 Signature 2000: 075
 Singer: 047, 061
 Sony: 004, 032, 033, 041, 052, 058, 070, 074, 076, 077, 080
 STS: 035
 Sylvania: 018, 026, 027, 028, 044, 072
 Symphonic: 018, 051, 053, 073, 079
 Tandy: 007
 Tashiko: 010
 Tatung: 037
 Teac: 018, 029, 037
 Technics: 036
 Teknika: 010, 018, 065
 Toshiba: 000, 011, 021, 023, 024, 028, 030, 039, 057, 074, 078, 079
 Totevision: 009, 010, 065
 Unitec: 073
 Unitech: 009
 Vector Research: 005, 006, 011, 012, 053
 Video Concepts: 005, 006, 011, 012, 039, 053
 Wards: 009, 010, 011, 016, 018, 020, 024, 025, 031, 035, 049, 051, 056, 057, 060, 065, 066, 079
 White Westinghouse: 073
 XR-1000: 018
 Yamaha: 005, 006, 007, 014, 037, 053
 Zenith: 004, 032, 034, 041, 047, 069, 086

HTIB

Lasonic: 083
 Panasonic: 084
 Venturer: 085

Using the remote control to operate a cable converter box, satellite receiver, VCR, DVD player, or HTIB (home theater in a box)

If you have a non-Toshiba device or a Toshiba device that the remote control is not preprogrammed to operate, you must first program the remote control to recognize the device (if you have not already done so). See pages 24 and 25.

To use your TV remote control to operate a:

- Cable converter box or satellite receiver, set the **Device Switch** to CBL/SAT.
- VCR, set the **Device Switch** to VCR.
- DVD player or HTIB, set the **Device Switch** to DVD.

Note:

Even after the TV remote control is programmed, it may not operate certain features on your other device. If this happens and you wish to use those features, you will need to use the device's original remote control.

Point the remote control directly at the device.

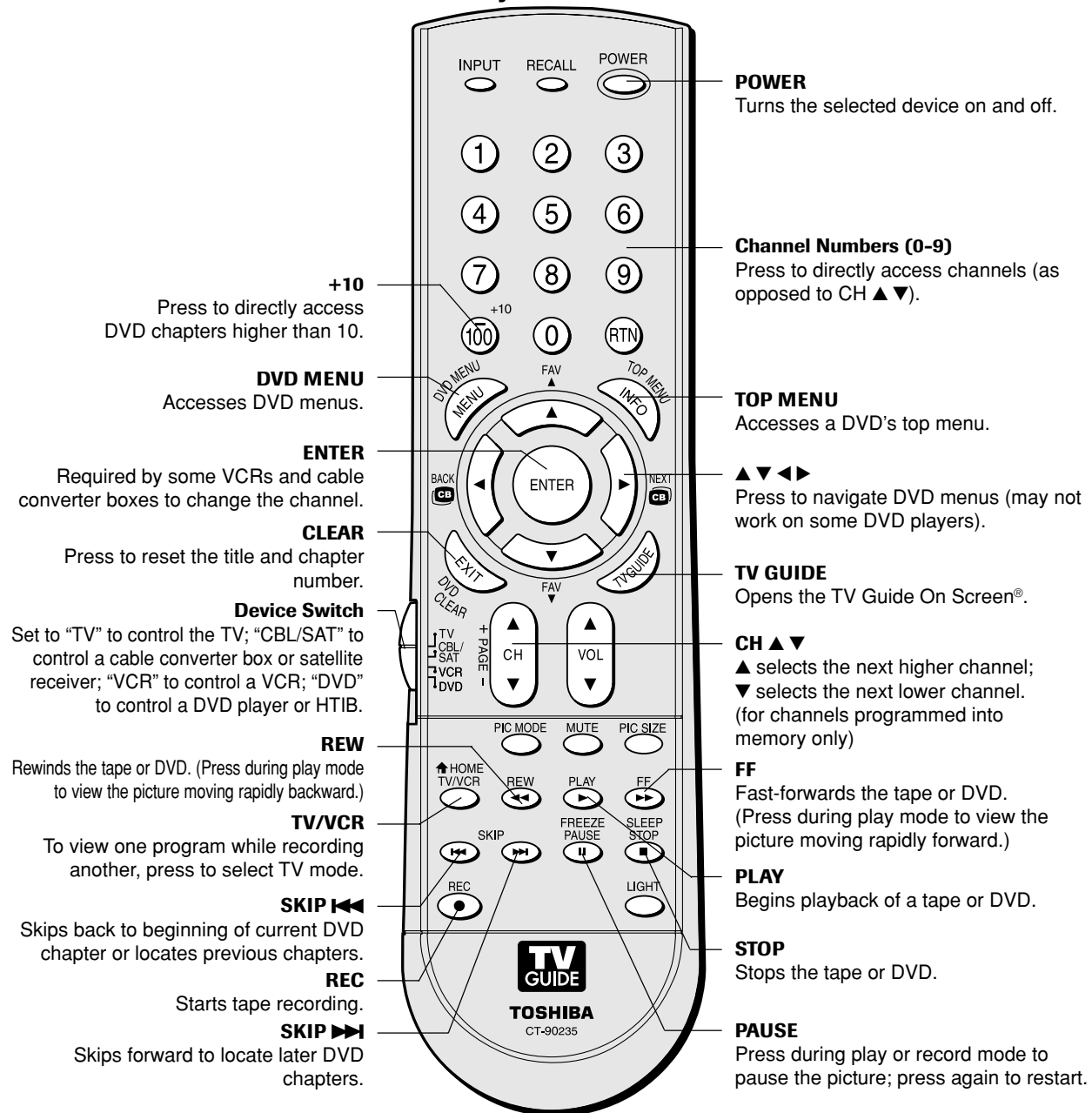

Remote Control function key chart

Key Label	Toshiba TV (TV)	Cable/Satellite (CBL/SAT)	VCR	DVD
POWER	Power	Power	Power	Power
RECALL	On-screen display	---	---	On-screen display
INPUT	Input	TV Input	TV Input	TV Input
1	Digit 1	Digit 1	Digit 1	Digit 1
2	Digit 2	Digit 2	Digit 2	Digit 2
3	Digit 3	Digit 3	Digit 3	Digit 3
4	Digit 4	Digit 4	Digit 4	Digit 4
5	Digit 5	Digit 5	Digit 5	Digit 5
6	Digit 6	Digit 6	Digit 6	Digit 6
7	Digit 7	Digit 7	Digit 7	Digit 7
8	Digit 8	Digit 8	Digit 8	Digit 8
9	Digit 9	Digit 9	Digit 9	Digit 9
0	Digit 0	Digit 0	Digit 0	Digit 0
100/-/+10	- (Sub channel)/ FAV channel list	- or 100	100	+10
RTN	Previous channel	---	---	---
INFO/ TOP MENU	Info/ Top Menu	Info	---	Top Menu
MENU/ DVD MENU	Menu/DVD Menu	Menu	---	Menu
▲▼/FAV▲▼	Menu select/ up/down	---	---	Menu select
	Menu select/ Channel Browser	---	---	Menu select
	Menu select/ Channel Browser	---	---	Menu select
ENTER	Enter	Select, Enter	---	Enter
EXIT/DVD CLEAR	Exit	Exit	---	Clear
VOL▲▼	Volume up/down	TV Volume up/down	TV Volume up/down	TV Volume up/down
CH▲▼/PAGE+-	Channel up/down Page up/down	Channel up/down	Channel up/down	---
PIC SIZE	Picture size	TV Picture size	TV Picture size	TV Picture size
MUTE	Sound mute	TV Sound mute	TV Sound mute	TV Sound mute
PIC MODE	Picture mode	TV Picture mode	TV Picture mode	TV Picture mode
FF	---	---	Fast FWD	Fast FWD
PLAY	---	---	Play	Play
REW	---	---	Rewind	Rewind
HOME TV/VCR	Channel Browser Home	---	TV/VCR	---
SLEEP/STOP	Sleep timer	---	Stop	Stop
FREEZE/PAUSE	Still picture	---	Pause	Pause
SKIP 	---	---	---	Skip REV/FWD
REC	Record	---	Record (2 click)	---
LIGHT	Lights the remote keys.			

Note:

“---” sends no signal.

Learning about the remote control

The buttons used for operating the TV only are described here. For a complete list of the remote control's functions, see the remote control functional key chart on pages 27.

For a list of the buttons that operate the TV Guide On Screen® system, see page 43.

POWER turns the TV on and off. Press POWER to turn on the TV. The red indicator on the TV will be illuminated. Press POWER again to turn off the TV.

RECALL displays TV setting information on-screen (page 75).

INPUT selects the video input source (page 56).



Channel Numbers (0–9, –/100) directly tune channels. The “–” button is used to tune digital channels (page 60) or to display the favorite channel list (page 38).

RTN returns to the last viewed channel (page 60).

INFO provides detailed information on highlighted items in the TV Guide On Screen® system (Chapter 7).

MENU accesses the main TV menu system (pages 29 and 30) or opens a menu in the TV Guide On Screen® system (Chapter 7).

ENTER activates highlighted items in the main menu system and the TV Guide On Screen® system.

Arrow buttons (▲▼◀▶) When a menu is on-screen, these buttons select or adjust programming menus. (Also see   below.)

FAV ▲▼ tunes to the next higher/lower favorite channel (page 38).

TV GUIDE opens the TV Guide On Screen® system (Chapter 7).

CH ▲▼ cycles through programmed channels when no menu is on-screen (page 60); functions as page up/down when a menu is on-screen or when the TV Guide On Screen® system is open (Chapter 7).

VOL ▲▼ adjusts the volume level.

EXIT closes on-screen menus and the TV Guide On Screen® system.



Device Switch switches between TV, CBL/SAT, VCR, and DVD modes (pages 24–26). Set to “TV” to control the TV.

PIC MODE selects the picture mode (page 65).

MUTE reduces or turns off the sound (page 70).

PIC SIZE cycles through the five pictures sizes: Natural, TheaterWide 1/2/3, and Full (page 61).

HOME (↑) accesses the home function of the Channel Browser™ feature (page 59)

  While watching TV, these buttons tune to the previous/next channel in the channel history (page 58). (Also see “Arrow buttons” above.)

FREEZE freezes the picture (page 64).

SLEEP accesses the sleep timer (page 73).

REC initiates the recording process when in the TV Guide On Screen® system.

LIGHT illuminates the keypad for 5 seconds.

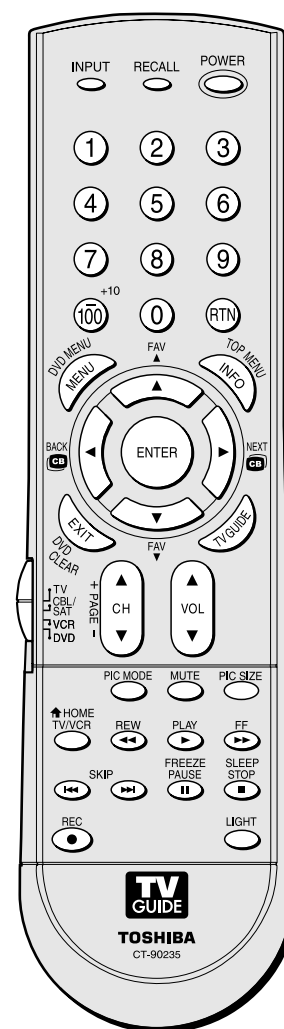

Note: The error message “Not Available” will appear if you press a key for a function that is not available.

4 Menu layout and navigation

The illustrations below and on the next page provide a quick overview of your TV's menu system.

Main menu layout

To open the main menus (illustrated below), press MENU on the remote control or TV top panel.

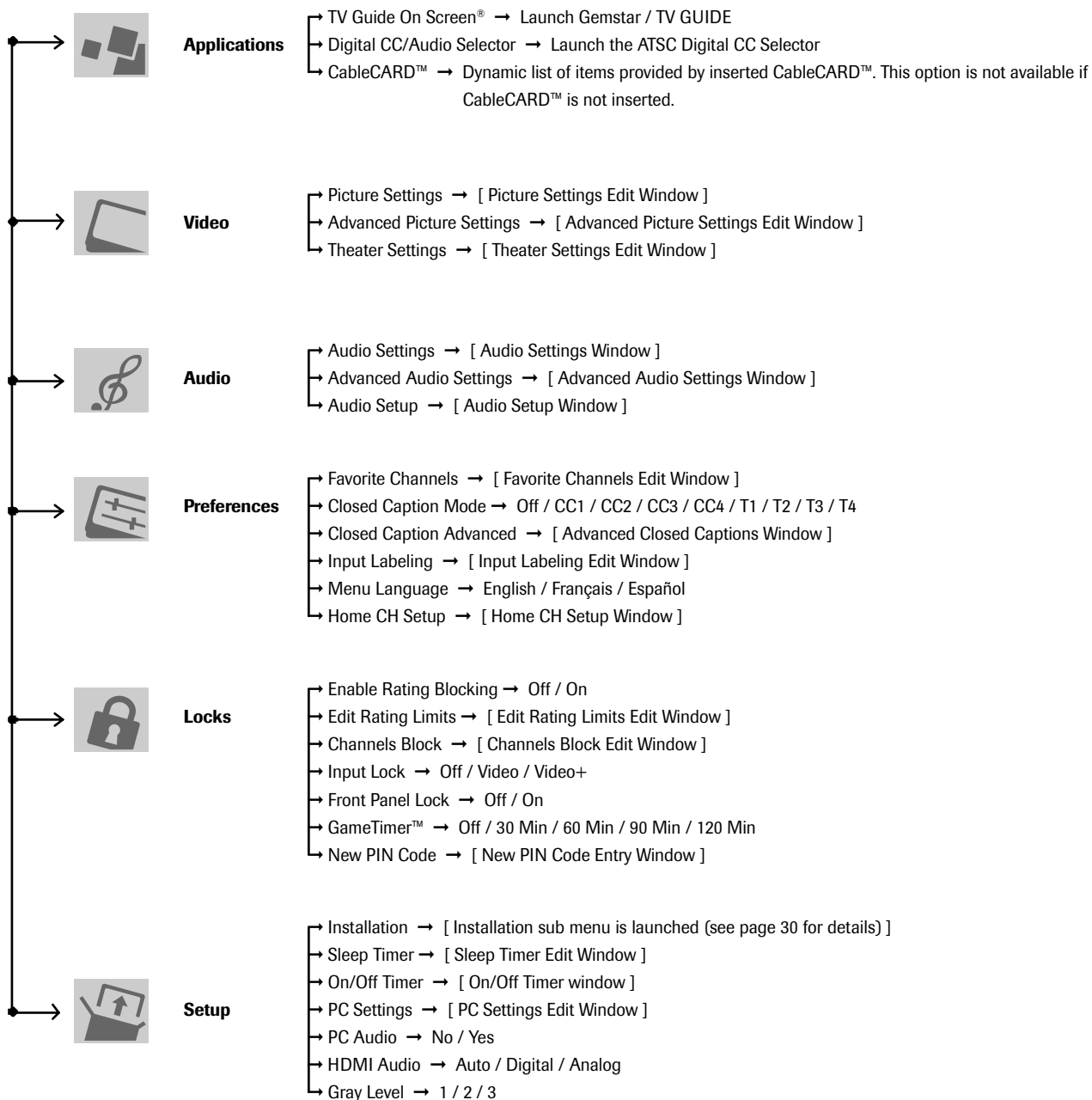

Setup / Installation menu layout

To open the Installation menu (illustrated below), press MENU on the remote control or TV top panel, open the Setup menu, select Installation, and press ENTER.

From Main Menu/Setup menu, select "Installation" sub-menu

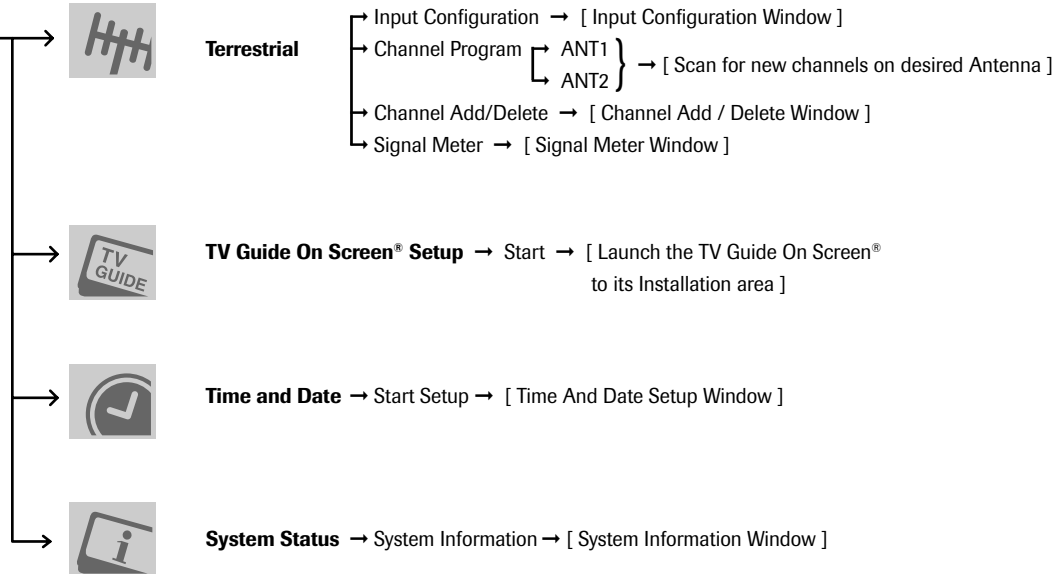

Navigating the menu system

You can use the buttons on the remote control or TV top panel to access and navigate your TV's on-screen menu system.

- Press MENU to open the menu system.
- Use the up/down/left/right arrow buttons (▲▼◀▶) on the remote control or TV top panel to move in the corresponding direction in a menu.
- Press ENTER to save your menu settings or select a highlighted item. (A highlighted menu item appears in a different color in the menu.)
- All menus close automatically if you do not make a selection within 60 seconds except the signal meter menu which closes automatically after 5 minutes.
- To close a menu instantly, press EXIT.

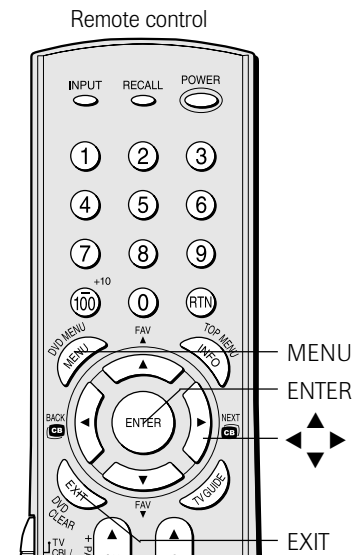
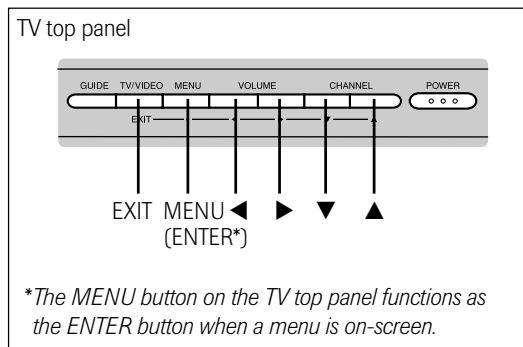

5 TV Guide On Screen® setup

Setting up the TV Guide On Screen® system

The TV Guide On Screen® system in your TV is a no-fee interactive program guide that uses the information you enter during the following setup process to provide you with a channel lineup and program listings for your area. The listings are automatically updated several times a day.

Note:

You must first set up your TV according to the applicable connection instructions in Chapter 2.

To set up the TV Guide On Screen® system:

1. Press MENU and open the Setup menu.
2. Highlight Installation and press ENTER.

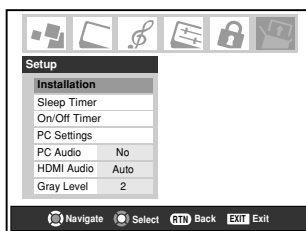

3. A new set of Installation menu icons appears on-screen (see illustration at right). Open the TV Guide On Screen® Setup menu, highlight Start, and press ENTER.



4. The following screen appears. Highlight “Set up TV Guide On Screen® now” and press ENTER to continue.

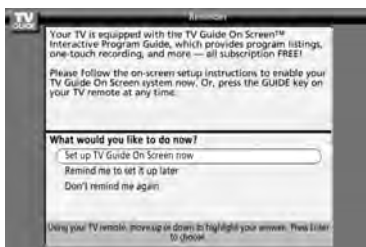

5. The following screen appears. Press ENTER to continue.



Configuring the location of your TV

Screen 1: Select the TV location (USA), and then press ENTER.

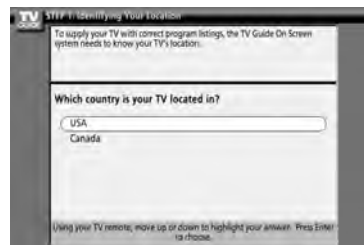

Screen 2: Enter the ZIP code (U.S.A.) for your location (use the Number buttons on the remote control for numbers and the ▲▼ buttons for letters), and then press ENTER. Screen 3 appears.

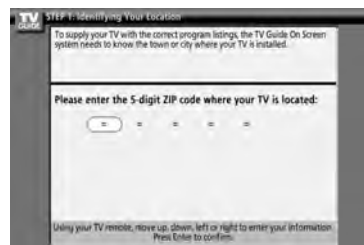

Screen 3: Do you have Cable service connected? If you select Yes (and press ENTER), screen 4 appears. If you select No (and press ENTER), screen 12 appears.

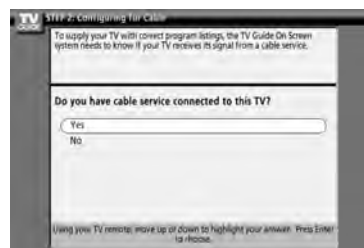

Screen 4: Do you have a Cable box connected? If you select Yes (and press ENTER), screen 5 appears. If you select No (and press ENTER), screen 13 appears.

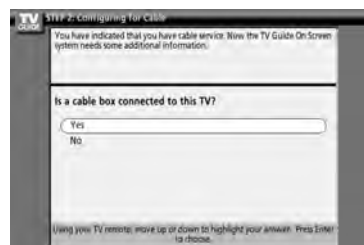

Setting up the TV Guide On Screen® system (continued)

Screen 5: Which TV input is your cable box plugged into?

If you select ANT 1, screen 6 appears.

If you select Video 1, screen 7 appears.

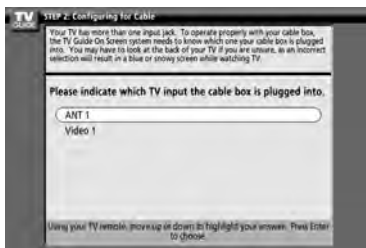

Screen 6: Select the channel your TV is tuned to when using your cable box, and then press ENTER. Screen 7 appears.

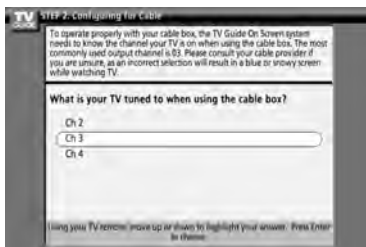

Screen 7: The on-screen diagram shows the correct way to connect your Cable box to the G-LINK® terminal on the TV. **Make sure the G-LINK® cable is installed properly. For additional details, see page 21.**

Press ENTER to display screen 8.

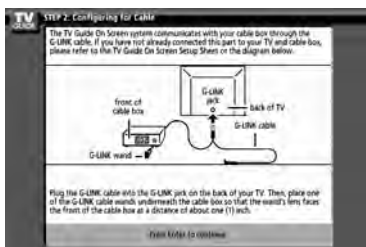

Screen 8: Highlight your Cable box brand, and then press ENTER to display screen 9.

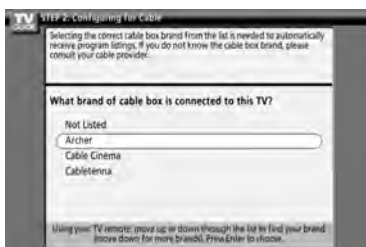

Screen 9: To allow the TV Guide On Screen® system to find the correct code for your brand of Cable box, tune your Cable box to channel 02, leave the Cable box and TV ON, and then press ENTER. Screen 10 appears.

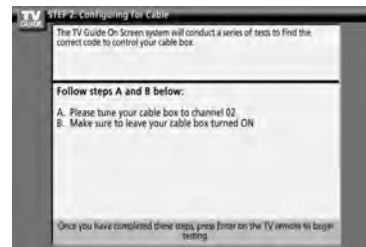

Screen 10: The TV Guide On Screen® system will test the code for the brand of Cable box you selected. Do not press any keys on the TV, remote control, or Cable box until the testing process is completed. When testing is completed, screen 11 appears.



Screen 11: If your Cable box tuned itself to channel 09 after testing, select Yes and press ENTER. If you selected ANT 1 in screen 5, screen 13 appears. If you selected Video 1 in screen 5, screen 12 appears.

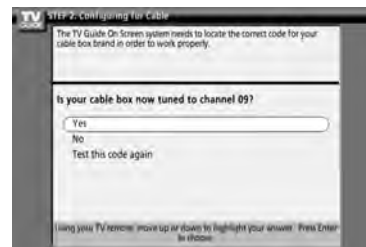

If your Cable box did not tune itself to channel 09 after testing and you want to test the same code again, select "Test this code again" and press ENTER.

If you want to test a different code, select No and press ENTER. Screen 10 appears.

Note: Many cable boxes require testing more than one code.

(Continued on next page)

Setting up the TV Guide On Screen® system (continued)

Screen 12: Do you have an antenna connected?
Select either Yes or No, and then press ENTER. Screen 13 appears.

Note: If you selected No in screen 3, you must select Yes in this screen to receive a channel lineup and program listings.

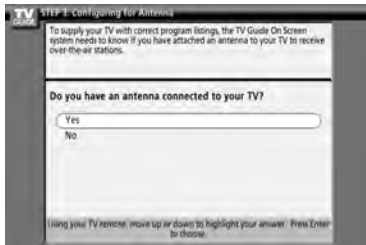

Screen 13: Are the settings correct?
If you select Yes, screen 14 appears.
If you select No, screen 1 appears.

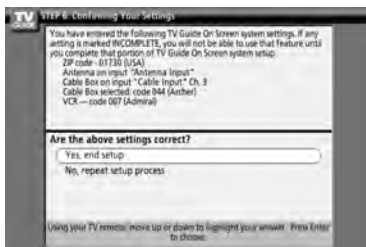

Screen 14: Congratulations! You have completed basic TV Guide On Screen® system setup.

Note: Read the on-screen information regarding the amount of time it may take for listing information to download from the TV Guide On Screen® service.

Press ENTER to display screen 15.

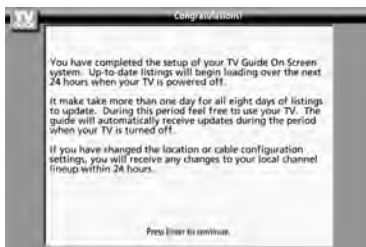

Screen 15: Is a VCR connected?
If you select Yes, screen 16 appears.
If you select No, screen 21 appears.

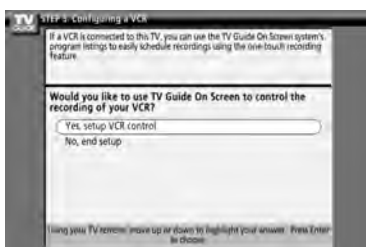

Screen 16: The on-screen diagram shows the correct way to connect your VCR to the G-LINK® terminal on the TV.
Make sure the G-LINK® cable is installed properly. For additional details, see page 21.
Press ENTER to display screen 17.

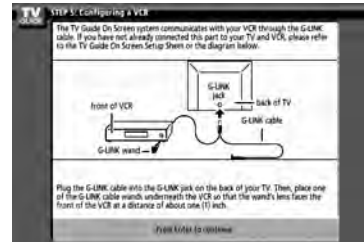

Screen 17: Select your VCR brand, and then press ENTER. Screen 18 appears.

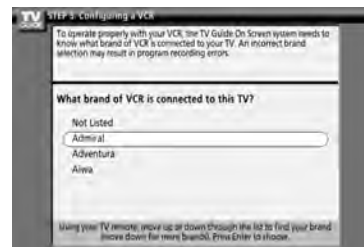

Screen 18: Turn on your VCR, insert a tape (either blank or previously recorded), and then press PLAY. Screen 19 appears.

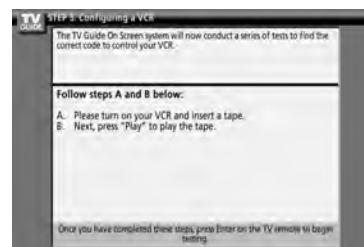

Screen 19: The TV Guide On Screen® system will test the code for the brand of VCR you selected. Do not press any keys on the TV, remote control, or VCR until the testing process is completed. When testing is completed, screen 20 appears.



Setting up the TV Guide On Screen® system (continued)

Screen 20: If your VCR stopped playing the tape after testing, select Yes and press ENTER. Screen 21 appears.

If your VCR did not stop playing the tape after testing and you want to test the same code again, select “Test this code again” and press ENTER.

If you want to test a different code, select No and press ENTER. Screen 19 appears.

Note: Many VCRs require testing more than one code.

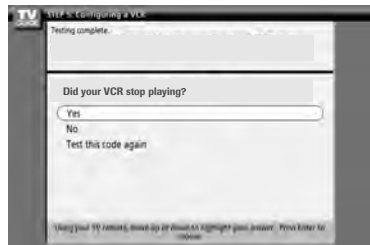

Screen 21: Review the setup information displayed on your TV screen (an example is shown below).

If the information on your TV screen is correct for your setup, select “Yes, end setup” and press ENTER. Screen 22 appears.

If the information is incorrect, select “No, repeat setup process” and press ENTER. Screen 1 appears.

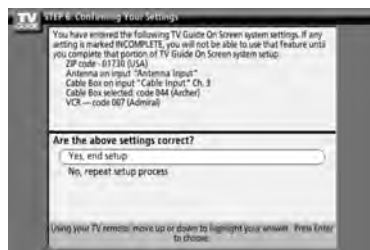

Screen 22: Congratulations! You have successfully completed TV Guide On Screen® system setup. Press ENTER to display screen 23.

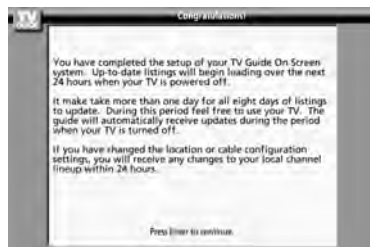

Screen 23: This screen provides helpful information on using your TV Guide On Screen® system.

Press ENTER to exit the TV Guide On Screen® setup and watch TV.



TV Guide On Screen® Reminder

The TV Guide On Screen® system receives program listings data through your Cable or over-the-air video signal. In order to receive regular program listing updates, remember to do the following:

1. Leave the TV in standby mode when it is not in use by turning it OFF but leaving the power cord plugged in.
2. If you have a Cable box connected, leave it ON.
3. If you have a VCR connected, turn it OFF when not in use. (Do not unplug the power cord.) See page 13 for VCR connection instructions.
4. If you have more than one Cable system in your area, you may be prompted to select which Cable system's program data to download. If so prompted, follow the on-screen instructions.

Note: If the TV power cord is unplugged for an extended period of time, it may take up to 24 hours with the TV in standby mode (power cord plugged in and power OFF) to download the TV Guide On Screen® program schedule. It may take up to a week before an entire program schedule is available.

Turning off the TV Guide On Screen® automatic display feature

After you set up the TV Guide On Screen® system, the program guide will display automatically (by default) when you turn on the TV. To turn off the automatic program guide:

1. Press TV GUIDE on the remote control to open the TV Guide On Screen® system (if it is not already open).
2. Use the ◀▶ buttons to select the Setup menu.
3. Use the ▲▼ buttons to select “Change Default Options”, and then press ENTER.
4. Use the ▲▼ buttons to select “General Defaults”, and then press ENTER.
5. Set the “Auto Guide” option to Off.
6. Use the ▲▼ buttons to select Done, and then press ENTER.

6 Setting up your TV

For menu navigation instructions, see Chapter 4.

Selecting the menu language

You can choose from three different languages (English, French and Spanish) for the on-screen display of menus and messages. (The TV Guide On Screen® menus are in English, regardless of the language selected in this menu.)

To select the menu language:

1. Press MENU and open the Preferences menu.
2. Highlight Menu Language and then press ►.
3. Press ▲ or ▼ to select your preferred menu language and then press ENTER.

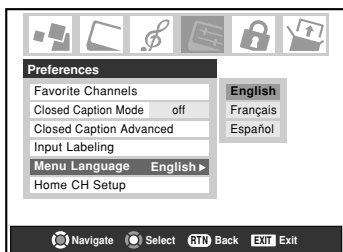

Configuring the antenna input sources

To configure the ANT 1 and ANT 2 input sources:

1. Press MENU and open the Setup menu.
2. Highlight Installation and press ENTER. (A new set of Installation menu icons will appear on-screen, as shown in step 3 below.)

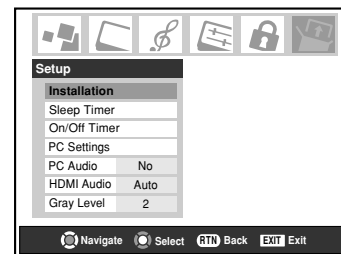

3. Open the Terrestrial menu, highlight Input Configuration, and press ENTER.

Note: The Terrestrial menu may not be accessible (items will be "grayed out") in some instances (for example, if a cable box is connected to the ANT 1 input or if one of the VIDEO modes is the current input during TV Guide On Screen® setup).

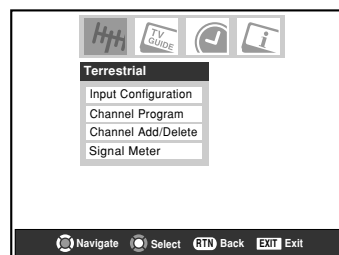

4. Press ◀▶ to select the input source (Cable or Antenna) for the ANT 1 input on the TV.

Note: If a cable box is connected to the ANT 1 input during TV Guide On Screen® setup, the entire Terrestrial menu will not be accessible, including the input source for ANT 1, which will automatically display "Cable Box."

5. Press ▼ and then ◀▶ to select the input source (Cable or Antenna) for the ANT 2 input on the TV, if applicable. If you have not connected anything to ANT 2, skip this step.

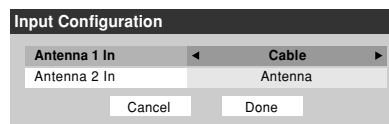

6. To save your new settings, highlight Done and press ENTER. To revert to your original settings, highlight Cancel and press ENTER.

Programming channels into the TV's channel memory

When you press CHANNEL ▲ or ▼ on the remote control or TV top panel, your TV will stop only on the channels stored in the TV's channel memory.

Follow the steps below to program channels into the TV's channel memory.

Programming channels automatically

Your TV can automatically detect all active channels in your area and store them in its memory. After the channels are programmed automatically, you can manually add or erase individual channels.

Note:

- You must configure the antenna input sources before programming channels (see page 35).
- If the input signal type is set to Cable for an antenna input, the automatic channel programming process erases channels that were previously programmed into the TV's memory.
- If the input signal type is set to Antenna, the automatic channel programming process does NOT erase channels that were previously programmed into the TV's memory, but adds newly found channels to the existing set of programmed channels. To remove a channel from the memory, you must manually delete it (see next page).
- To tune the TV to a channel not programmed in the channel memory, you must use the Channel Number buttons on the remote control.
- Programming channels for an antenna input configured for Cable will take substantially longer than for an antenna input configured for Antenna. This is normal; however, once channel programming is completed, you should not have to repeat the programming process again unless your Cable TV service lineup changes significantly.
- If you have a CableCARD™ inserted (page 12), channel programming for ANT 1 is disabled because the CableCARD™ automatically loads the Cable channel list into the TV's channel memory.

To program channels automatically:

1. Make sure you have configured the antenna input sources. See page 35 for details.
2. Press MENU and open the Setup menu.
3. Highlight Installation and press ENTER. (A new set of Installation menu icons will appear on-screen.)

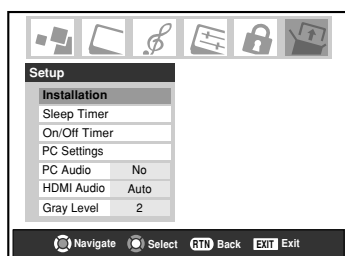

4. Open the Terrestrial menu, highlight Channel Program, and press ENTER.
5. Highlight ANT 1 or ANT 2, depending on which antenna input you want to program channels for, and then press ENTER to start automatic channel programming.

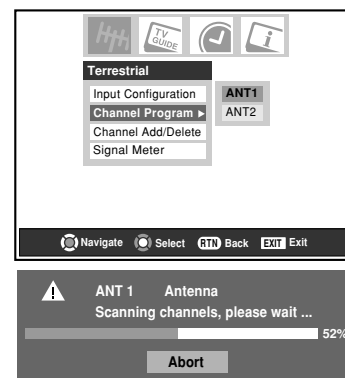

The TV will automatically cycle through all the channels for the antenna input you selected, and store all active channels in the channel memory. While the TV is cycling through the channels, the message “Scanning channels, please wait” appears (as shown above).

6. To cancel channel programming, either press EXIT or highlight Abort in the on-screen display and press ENTER. When channel programming is done, press CHANNEL ▲ or ▼ to view the programmed channels.

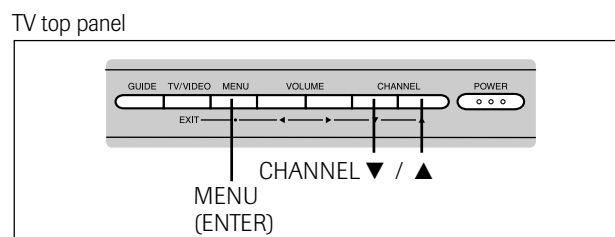
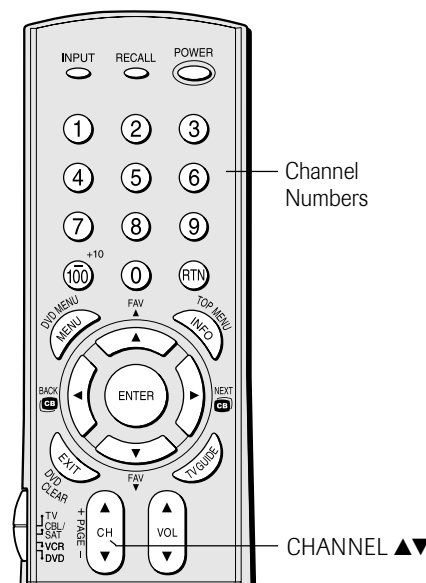

Programming channels into the TV's channel memory (continued)

Manually adding and deleting channels in the channel memory

After automatically programming channels into the channel memory, you can manually add or delete individual channels.

To add or delete channels in the channel memory:

1. Press MENU and open the Setup menu.
2. Highlight Installation and press ENTER. (A new set of Installation menu icons will appear on-screen, as shown in step 3).

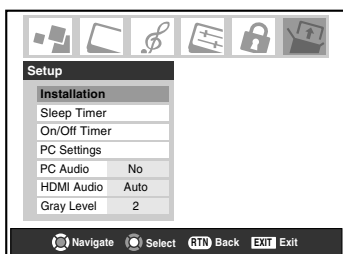

3. Open the Terrestrial menu, highlight Channel Add/Delete, and then press ENTER.

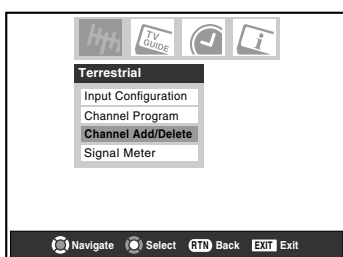

4. The illustration below left shows channels programmed for the ANT 1 antenna input. To view the list of channels programmed for the ANT 2 or Cable box antenna input, press the ▲▼ to highlight either "ANT 2" or "Cable Box" and press ENTER.

Note: "Cable Box" will appear only if you connected a cable box to your TV.

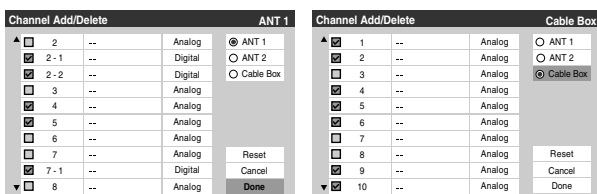

To add a channel to the channel memory:

Highlight the unchecked box next to the channel number you want to add, and then press ENTER to check the box.

To manually add digital subchannels on a physical channel:

Use the Channel Numbers and the Dash (-/100) on the remote control to enter the channel number (for example, 56-1).

If the channel is found, the number will be added to the list and the box will be checked.

If the channel is not found, a message will appear.

To remove a channel from the channel memory:

Highlight the checked box next to the channel number you want to remove, and then press ENTER to uncheck the box.

To save your new settings:

Highlight Done and press ENTER.

To revert to your original settings:

Highlight Cancel and press ENTER before saving.

To remove all channels from the channel memory:

Highlight Reset and press ENTER, and then highlight Done and press ENTER.

Note:

- This action applies to the current antenna input only. To delete/add channels on the other input, highlight the input you want (ANT1 or ANT 2) and press ENTER.
- This action cannot be canceled unless you highlight Cancel and press ENTER before saving your changes.

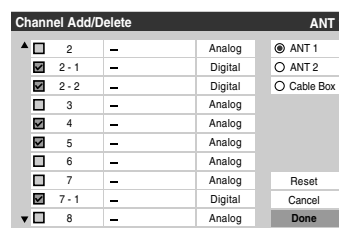

Programming your favorite channels

You can program up to 27 channels as favorite channels into three Favorite Channel sets (nine channels from the ANT 1 input, nine from the ANT 2 input, and nine from the Cable Box input). You can then scan through your favorite channels only, skipping other channels you do not normally watch.

To add and delete channels in the Favorite Channels sets:

1. Press MENU and open the Preferences menu.
2. Highlight Favorite Channels and press ENTER.
3. Use ▲▼ to select either ANT 1, ANT 2, or Cable Box and press ENTER.
4. Highlight Edit and press ENTER.

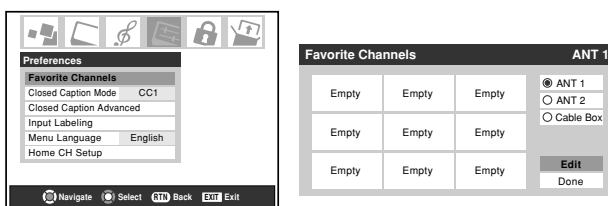

To add a channel to the selected Favorite Channel set:

Use ▲▼ to highlight an unchecked box next to the channel you want to set as a favorite, and then press ENTER to check the box.

To delete the channel from the selected Favorite Channels set:

Highlight a checked box and press ENTER to uncheck it.

Note: If you try to add more than nine favorite channels per input, an error message will appear. You will need to delete (uncheck) a channel before you can add another.

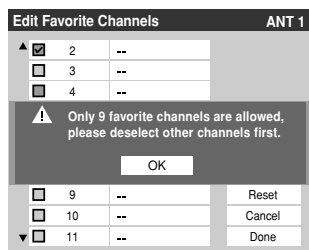

When done, highlight Done and press ENTER.

To program favorite channels for another input:

Either... Highlight ANT 1, ANT 2, or Cable Box, which will change the favorite channel settings in the selected input. (This will not change the TV's current input.)

Or... Press INPUT to select ANT 1, ANT 2, or Cable Box and then repeat steps 1–4.

Note: "Cable Box" will appear only if you connected a cable box to your TV.

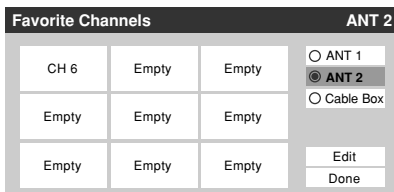

To clear your favorite channel lists:

1. Press MENU and open the Preferences menu.
2. Highlight Favorite Channels and press ENTER.
3. Highlight Edit and press ENTER.
4. Highlight Reset and press ENTER.
5. Highlight Done and press ENTER.

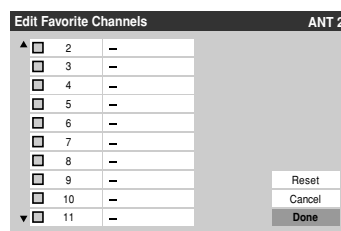

To tune your favorite channels for the current ANT input:

Press FAV ▲▼.

To tune your favorite channels using the favorite channel list:

1. Press 100 to display the favorite channel list.
2. Press the corresponding number button (1-9) to select your desired channel.



Note: To tune your favorite channels for another input, you will need to change the Input Selection first.

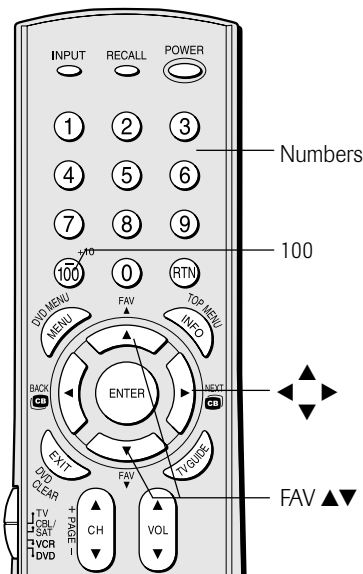

Setting the HDMI™ audio mode

To select the HDMI audio mode:

1. Press MENU and open the Setup menu.
2. Highlight HDMI Audio and press ►.
3. Press ▼ ▲ to select the HDMI audio mode (Auto, Digital, or Analog) and press ENTER. (Auto is the recommended mode). See “Connecting an HDMI or a DVI device to the HDMI input” on page 19.

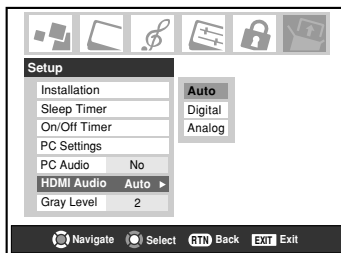

Setting the time and date

Note: If you already set up the TV Guide On Screen® system, the time and date were set automatically and you can skip this step.

To set the time and date:

1. Press MENU and open the Setup menu.
2. Highlight Installation and press ENTER. (A new set of Installation menu icons will appear on-screen, as shown in step 3 below.)
3. Open the Time And Date menu, highlight Start Setup, and press ENTER.

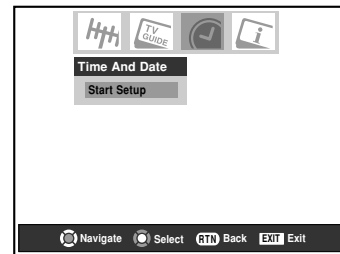

If you have not set up the TV Guide On Screen® system, the following screen will appear. To set the time, highlight TV Guide On Screen® and press ENTER. The TV Guide On Screen® setup sequence will start, and the time and date will be set automatically.

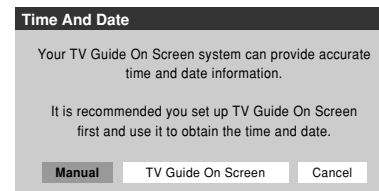

If you have already set up the TV Guide On Screen® system, or if you have not set up the time, the time and date setting screen will appear, set the time and date manually.

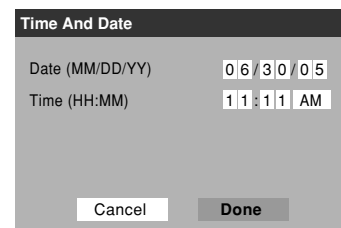

Note:

- If you highlight TV Guide On Screen® (above) to set the time and date through the TV Guide On Screen® system and a power outage occurs, the time and date will be updated automatically when the power is restored.
- If you highlight Manual (above) to set the time and date manually and a power outage occurs, you will lose the time and date settings when the power is restored.
- If you manually set the time and date and then perform TV Guide On Screen® setup, the manual time and date settings will be overridden by the TV Guide On Screen® settings.

Viewing the CableCARD™ menu

A CableCARD™ enables you to view encrypted digital channels. See page 12 for connection and subscription information.

After the CableCARD™ is inserted, a CableCARD™ option appears in the Applications menu, with informational screens provided by your CableCARD™ service (see illustrations below).

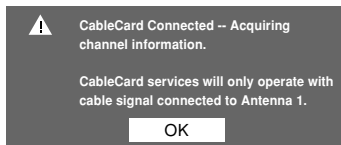

To view the CableCARD™ menu:

1. Press MENU and open the Applications menu.
2. Highlight CableCARD™ and press ►.
3. Press ▲▼ to select one of the side menu items and press ENTER to display the information.

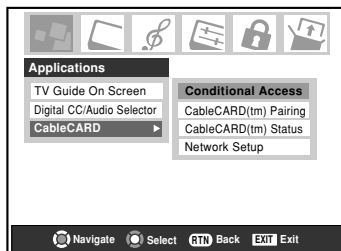

Note: The CableCARD™ menu has no user-adjustable options and is for informational purposes only.

Viewing the digital signal meter

You can view the digital signal meter for ANT 1 and ANT 2 digital TV input sources only.

To view the digital signal meter:

1. Press MENU and open the Setup menu.
2. Highlight Installation and press ENTER. (A new set of Installation menu icons will appear on-screen, as shown in step 3 below.)

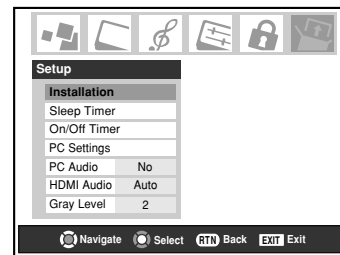

3. Open the Terrestrial menu, highlight Signal Meter, and press ENTER.

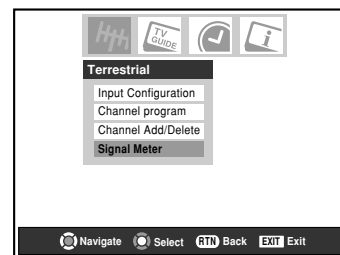

4. Use ▲▼◀▶ to select the antenna input and digital channel whose signal you want to check.

Note: The physical digital channel number listed in the Signal Meter screen may not correspond to a virtual TV channel number. Contact your local broadcasters to obtain the RF channel numbers for your local digital stations.

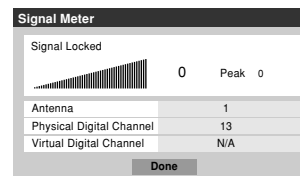

To close the screen and return to the Terrestrial menu:

Highlight Done and press ENTER.

To return to normal viewing:

Press EXIT.

Viewing the system status

To check the system status:

1. Press MENU and open the Setup menu.
2. Highlight Installation and press ENTER. (A new set of Installation menu icons will appear on-screen, as shown below right.)

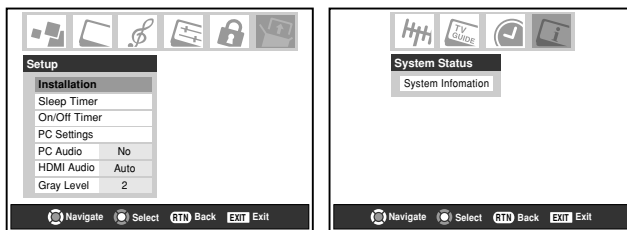

3. Open the System Status menu, highlight System Information, and then press ENTER.
4. Use ◀▶ to scroll through the menu bar to check the Product Information and Software Version.

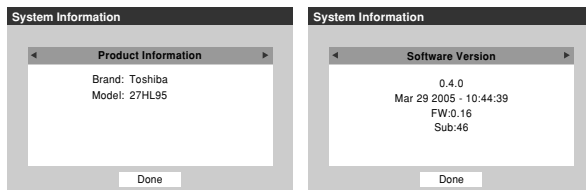

To close the screen and return to the Installation menu:

Highlight Done and press ENTER.

To return to normal viewing:

Press EXIT.

Restore Factory Defaults

To restore all settings and channels to their factory default values:

1. Follow steps 1–3 above.
2. Use ◀▶ to scroll through the menu bar to select Factory Defaults.
3. Enter your PIN code (or 0000 if no PIN code has been set).
4. Highlight Yes and press ENTER. The TV will turn off automatically after a few seconds. After the TV turns off, unplug the TV power cord and then plug it in again to complete the restore process.

To cancel the reset:

Highlight No and press ENTER.

7 Using the TV Guide On Screen® interactive program guide

The TV Guide On Screen® system is a free, interactive, on-screen program guide built in to your Toshiba TV that lists schedules and information for TV programs in your area.

Note: Over-the-air or cable access to stations carrying TV Guide On Screen® data is required for the TV Guide On Screen® system to operate. The TV Guide On Screen® system does not work with satellite programming. Toshiba does not provide the TV Guide On Screen® data; rather, such data is provided by a third party, which is responsible for its accuracy and availability. Additionally, occasional compatibility issues may exist between the TV Guide On Screen® system contained in your TV and the data provided by the third party. If you experience any performance issues with your TV Guide On Screen® system, please contact Toshiba Consumer Solutions by calling (800) 631-3811 or by visiting <http://www.tacp.com/customersupport/contact.asp>.

The TV Guide On Screen® system includes the following features:

- **Streamlined on-screen assisted setup**—Quickly and easily set up your TV Guide On Screen® system using the on-screen prompts (see “Setting up the TV Guide On Screen® system” below).
- **Program listings and INFO windows**—Scroll through eight days of TV listings and view program information such as rating, stereo, HDTV, new episode.
- **Watch TV and display TV Guide On Screen® information simultaneously.**

- **Channel lineup customization**—Customize your channel lineup so your favorite stations are listed first.
- **Direct tuning**—Directly tune the TV to a current program you want to watch by selecting it in the program guide.
- **Reminders**—Schedule show reminders that will either display an on-screen notification banner or automatically tune the TV to the channel of the show for which you set the reminder.
- **Recording**—Easily schedule recording of one or more programs.
Note: A VCR is required for recording. It is recommended that you connect your devices according to the instructions in Chapter 2.
- **Search**—Search for shows by category, keyword, or alphabetically.
- **On-screen help**—The TV Guide On Screen® system contains on-screen feature definitions and navigation instructions.

To open the TV Guide On Screen® system:

- While watching TV, press TV GUIDE on the remote control;
—or—
- Press MENU, open the Applications menu, highlight TV Guide On Screen®, and press ENTER.

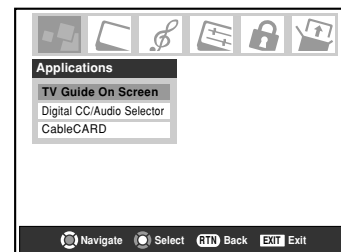

Note: After setting up the TV Guide On Screen® system, the program guide opens automatically by default when you turn on the TV. To turn off this feature, see page 34.

Setting up the TV Guide On Screen® system

Follow these instructions to set up the TV Guide On Screen® system so it can receive current program data for your area.

Note: If you move the TV to a different ZIP/postal code, you will need to perform the TV Guide On Screen® Setup process to reconfigure your TV Guide On Screen® system.

If you have not already connected your antenna, cable box, and/or recording device, see Chapter 2 for connection instructions.

Note: You must connect a VCR to use the TV Guide On Screen® system's one-touch recording feature. It is recommended that you connect your devices according to the connection instructions in Chapter 2.

The unauthorized recording, use, distribution, or revision of television programs, videotapes, DVDs, and other materials is prohibited under the Copyright Laws of the United States and other countries, and may subject you to civil and criminal liability.

1. Press MENU and open the Setup menu.
2. Highlight Installation and then press ENTER to open the Installation menus. (A new set of menu icons will appear on-screen, as shown in step 3 below.)
3. Open the TV Guide On Screen® Setup menu, highlight Start, and then press ENTER.

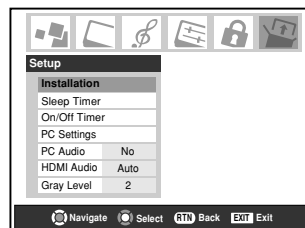

4. Go to Chapter 5 for instructions on completing the setup. Read this chapter for details on using the TV Guide On Screen® interactive program guide.

Navigating the TV Guide On Screen® system

- While watching TV, press TV GUIDE to enter the TV Guide On Screen® system. The LISTINGS screen will appear with the current show highlighted.
- When in the TV Guide On Screen® system, if you press TV GUIDE from any screen, the TV will tune to the show displayed in the Video Window.
- Use the arrow keys on the remote control (▲▼◀▶) to highlight any show, and then press ENTER to tune to that show.
- Scroll left or right (◀▶) to view eight days of listings.
- Press MENU to display a panel menu with options for the currently highlighted program or tile, including setting recordings and reminders.
- To access another Service screen:
 1. Press ▲ to highlight the Service Bar.
 2. Press ◀ or ▶ to highlight a different Service (LISTINGS, SEARCH, SETUP, or SCHEDULE).
 3. Press ▼ to use that Service.

Note: Helpful information about each Service appears in the Info Box.



Note:

- The TV Guide On Screen® menus shown in this manual are for illustration purposes only. The channels, programs, and TV Guide On Screen® information as illustrated may not be available in your area. The options and features as illustrated are subject to change when updates are downloaded from the TV Guide On Screen® service to your TV.
- The TV Guide On Screen® interactive program guide supports cable-ready, cable box, and digital cable services, as well as over-the-air broadcasts. It does not provide listings for satellite services.
- The RECORDINGS service label is not available on this TV model.

TV Guide On Screen® remote control functions

BUTTON	FUNCTION
TV GUIDE	<ul style="list-style-type: none"> • When watching TV, enters the TV Guide On Screen® system and highlights the current show listing. • When in the TV Guide On Screen® system, returns to watching TV and displays the show in the Video Window.
Numbers	• For direct channel tuning, priority ordering, and channel editing.
- (digital separator)	• For entering digital channel numbers.
MENU	• Displays the panel menu, in which you can choose options (for example, record, remind, keyword).
INFO	• Cycles between levels of information, as available, in a Service screen or other type of screen.
ENTER	<ul style="list-style-type: none"> • Makes a selection or executes an action. • With a currently airing show listing highlighted, returns to watching TV and tunes to the show channel. • With a future airing show listing highlighted, displays a panel menu with viewing options.
▲▼◀▶	<ul style="list-style-type: none"> • Provide directional control. • When watching TV, ▲ and ▼ provide surfing through channels turned ON in the LISTINGS screen.
PAGE UP/DOWN	• When in the TV Guide On Screen® system, moves from one set of screen information to the next, when applicable.
REC	• When in the TV Guide On Screen® system or watching TV, initiates the recording process.

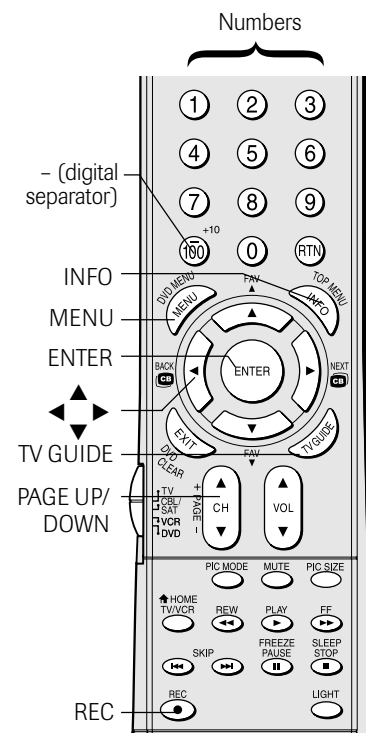

Navigating the TV Guide On Screen® system (continued)

Video Window

- When you open the TV Guide On Screen® system, the current program appears in the Video Window.
- As you scroll through the listings, the Video Window will change to display the selected program.



- The lock/unlock icon indicates the status of the Video Window.
- You can set the Video Window to remain on a single channel (locked) or to change channels (unlocked) as you navigate through listings.

To lock/unlock the Video Window:

Highlight a channel logo or the LISTINGS Service Bar Label and press MENU to display the option to lock/unlock the Video Window.

Panel Menus

- A panel menu appears:
 - when you press MENU on a highlighted tile (if additional options are available); or
 - when you press ENTER on a show starting in the future.
- When a panel menu appears, the highlighted tile changes color to indicate that the panel menu relates to the tile.
- Press INFO to display help for the current panel menu.
- Press ▲ and ▼ to move among the options.
- Press ◀ and ▶ to move to adjacent options or, if the highlight is on a odometer, to change the odometer choice.
- To move the highlight to the default command button, press ENTER from an odometer or entry box.
- To execute the action and close the panel menu, highlight the command button and press ENTER.
- To cancel any changes and close the panel menu:
 - press MENU; or
 - highlight Cancel and press ENTER.
- If a panel menu contains more options than can be displayed in one panel, the word “more” appears at the bottom of the menu. To access the additional options, either scroll down using ▼ or the PAGE UP/DOWN (CH ▲▼) button.

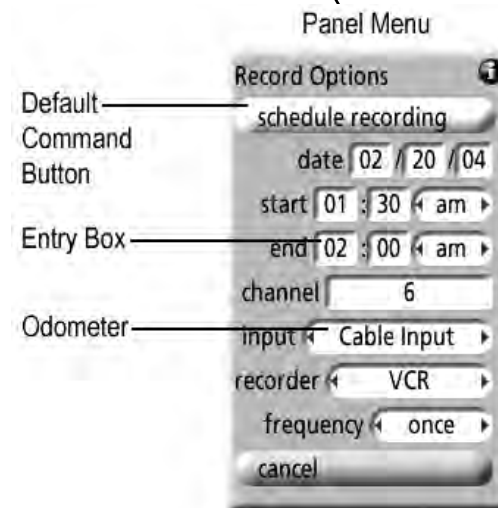

Navigating the TV Guide On Screen® system (continued)

Info Box

- An Info Box contains information about a show, Service, or Panel Ad, or provides general help (for example, for a panel menu).
- An Info Box for a program in the LISTINGS screen can have up to three sizes: Small, Large, or “No.”
 - Press INFO on the remote control to cycle among the sizes.
 - The default Info Box size is Small. To change the default size, open the SETUP Service screen (see page 53).
- The Info Button icon () appears on the Info Action Bar if the Info Box size can change and/or if there are additional Info screens. Press INFO on the remote control to change the size and/or to display additional Info screens.
- In some instances, INFO on the remote control is used to page forward (for example, if there are additional pages of information in a Panel Ad, a Channel Ad, or help text).



Info Action Bar

















Small Info Box



Large Info Box

TV Guide On Screen® Icons

ICON	NAME	DESCRIPTION
	Info Button	• Additional Info Box information is available, or the Info Box has additional sizes.
	Progress Bar	• Elapsed time in current show. • Progress bar appears in LISTINGS and SEARCH and when the Info Button is pressed while watching TV.
	HDTV	• Show is presented in high-definition TV, if available.
	New	• Show is new (not a repeat).
	Stereo	• Show is available in stereo.
	Dolby Digital	• Show is available with Dolby Digital 5.1 audio (digital channels only).
	CC	• Closed captioning is available for the show.
	TV Rating	• TV rating for the show.
	Record Once	• Show is set to record once. • Other frequencies are Daily (manual recording only), Regularly, and Weekly.
	Record Off	• Show is set to record but recording is currently Off (show remains in schedule).
	Record Suspended	• Recording is suspended due to a schedule conflict (show remains in schedule). • Recording resumes when the conflict no longer exists.
	Remind Once	• Show is set to remind once. • Other frequencies are Daily (manual reminding only), Regularly, and Weekly.
	Remind Off	• Show is set to remind but reminder is currently Off (show remains in schedule).
	Remind Suspended	• Reminder is suspended due to a schedule conflict (show remains in schedule). • Reminder resumes when the conflict no longer exists.



TV Guide On Screen® Services

The TV Guide On Screen® system consists of four main services: LISTINGS, SEARCH, SCHEDULE, and SETUP.

Note:

- For the RECORDINGS service to display, an IEEE1394 recording device must be connected to the television; otherwise, only four services display. Recording to other devices, such as a VCR, are possible from within the LISTINGS service.
- When using the TV Guide On Screen® system to record a program for the first time, it is recommended that you perform a test recording to make sure your system is set up properly.
- If power is cut or the plug becomes disconnected during timer recording, any recorded contents will be lost. It may take up to a week before an entire program schedule is available.
- If the TV power cord is unplugged for an extended period of time, it may take up to 24 hours with the TV in standby mode (power cord plugged in and power OFF) to download the entire TV Guide On Screen® program schedule. Be sure to follow the instructions under "TV Guide On Screen® Reminder" on page 34.

LISTINGS screen

- When you open the TV Guide On Screen® system, LISTINGS is always the first service displayed.



- With LISTINGS highlighted in the Service Bar, press INFO to display a help screen. Press INFO again to close the screen.



- Use the arrow keys to move the highlight within LISTINGS to do the following:

- View eight days of show listings
- Read show descriptions



- Tune directly to a show currently airing
- Set a show to Remind (e.g., start time, frequency, automatic power ON, auto-tune TV)
- Set a show to Record (e.g, start/end time, frequency)
- Lock and unlock the Video Window
- Access panel ads and channel ads

- Use the Number buttons on the remote control to jump to a specific channel's listings.
- To watch a show (if on now), highlight the show and press ENTER.
- To display the Episode Options panel menu for a particular show, highlight a show and press MENU.



Episode Options panel menu

From the Episode Options panel menu, you can choose to set a recording, set a reminder, or tune to the channel. The following are descriptions of the buttons.

GO TO SERVICE BAR: Closes the menu, changes no information, and returns to the Service Bar.

TUNE TO CHANNEL / WATCH NOW: Exits the TV Guide On Screen® system and tunes to the channel of the highlighted show (if the show airs in the future) or tunes to the show (if the show is currently airing). The button label changes according to whether the show is currently airing or not.

SET RECORDING: Displays the Record Options panel menu, from which you can set the show to record. For additional information, see "SCHEDULE screen" and "Record features" on page 49.

SET REMINDER: Displays the Remind Options panel menu, from which you can set a reminder for the show. For additional information, see "SCHEDULE screen" on page 49 and "Remind features" on page 51.

CANCEL: Closes the menu, changes no information, and returns to the highlighted show.

TV Guide On Screen® Services (continued)

SEARCH screen

- SEARCH allows you to find shows by keyword, alphabetically, or by category (HDTV, Movies, Sports, Children, Educational, News, Variety, Series).



- With SEARCH highlighted in the Service Bar, press INFO to display a help screen. Press INFO again to close the screen.

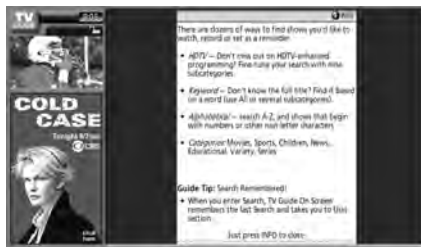

- Use the arrow keys to move the highlight within SEARCH.

Example: Category search

- From the SEARCH screen, press ▼ to highlight a category (in this example, MOVIES).



- Press ▼ to highlight a subcategory (in this example, ALL).



- Press ENTER to display a list of all movies, organized by date and time.



- Highlight a show and press ENTER to watch (if on now) or press MENU to display the Episode Options panel menu. (See "Episode Options panel menu" on page 46.)



TV Guide On Screen® Services (continued)

SEARCH screen (continued)

Example: Keyword search

Keyword search lets you enter a word(s) to find a particular show by category or for every show title that matches.

1. From the SEARCH screen, highlight KEYWORD, and then press ENTER.
2. Highlight NEW SEARCH in the panel menu, and then press ENTER.



3. The Search Options panel menu opens. Highlight CATEGORY, and then use the arrow keys to highlight a category to search (All, HDTV, Children, Sports, etc.).
4. After highlighting a category, press ▼ to highlight ENTER KEYWORD, and then press ENTER.



5. The keyboard is displayed. Use the arrow keys to highlight a character and then press ENTER to display it. When finished entering all characters, highlight DONE and press ENTER.



6. A list of all matching shows for that keyword is displayed.



7. Highlight a show and press ENTER to display all airings. Then highlight a specific listing and press ENTER to watch (if on now) or press MENU to display the Episode Options panel menu. From the Episode Options menu, you can choose to set a recording or reminder, or tune to the channel (see “Episode Options panel menu” on page 46.)



The TV Guide On Screen® system stores all the keywords you create.

To edit or delete a keyword:

From the SEARCH/KEYWORD screen, highlight the keyword you want to edit or delete, and then press MENU to display the Search Options panel menu, with the following options:

- GO TO SERVICE BAR: Closes the menu, changes no information, and returns to the Service Bar.
- EDIT SEARCH: Displays the keyboard, from which you can change the keyword.



- DELETE SEARCH: Displays the Confirmation panel menu. Select YES to delete the search or NO to close the panel menu.
- CANCEL: Closes the panel menu, changes no information, and returns to the highlighted keyword.

TV Guide On Screen® Services (continued)

SCHEDULE screen

The SCHEDULE service screen allows you to review, edit, or delete Record and Remind events you set previously.



- With SCHEDULE highlighted in the Service Bar, press INFO to display a help screen. Press INFO again to close the screen.

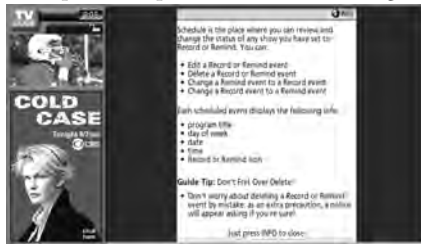

- Highlight an event and press MENU to display the Schedule Options panel menu, with the following options (as applicable) :
 - GO TO SERVICE BAR: Closes the menu, changes no information, and returns to the Service Bar.
 - WATCH NOW: Exits the TV Guide On Screen® system and tunes to the highlighted show.
 - DELETE RECORDING: Removes the recording from the schedule. A Confirm panel menu displays. Press YES to delete the recording or NO to close the panel menu.
 - EDIT RECORDING: Opens a menu in which you can change existing recording information.
 - SET REMINDER: Opens a menu in which you can set a reminder for the show (Record is not cancelled).
 - SET RECORDING: Opens a menu in which you can set a recording for a show (reminder is not cancelled)
 - DELETE REMINDER: Removes the reminder from the schedule. A confirm panel menu displays. Select YES to delete the reminder or NO to close the panel menu.
 - EDIT REMINDER: Opens a menu in which you can change existing reminder information.
 - CANCEL: Closes the panel menu, changes no information, and returns to the highlighted show.

An icon identifies the event type. For more details, see “Record features,” at right, and “Remind features” on page 51.



Record features

You can set a show to Record, or edit the record settings for a show, in LISTINGS, SEARCH, and SCHEDULE. There are three ways to set a show to Record, as described below.

1) Set a show to Record using the REC key on the remote control

Press REC on the remote control to record the show Once with current default settings (start and end recording on time). Each time you press REC, you change the Record frequency (but not the default settings) among Once (default), Regularly, Weekly, and Cancel.

Note: The related Record icon appears on the show tile each time you press REC. See “Record icons,” on page 50.

2) Set a show to Record from a panel menu

1. Highlight a show and press MENU to display the Episode Options panel menu.
2. Highlight SET RECORDING and press ENTER to display the Record Options panel menu.



3. Highlight the FREQUENCY field, and press ◀▶ to choose among Once, Regularly, Weekly, or Off.
 4. Highlight the START field, and press ◀▶ to choose in the range from 120 minutes early to 120 minutes late or On Time (default = On Time).
 5. Repeat step 4 for the END field.
 6. Highlight the RECORDER field and press ◀▶ to choose the recording device.
- Note:** For connected IEEE1394 recording devices only.
7. Highlight the KEEP UNTIL field and press ◀▶ to choose how long you want to keep the Record event.
- Note:** For connected IEEE1394 recording devices only.
8. Press ENTER to highlight SCHEDULE RECORDING, and press ENTER again to close the menu.

A Record icon for the selected frequency appears on the show tile. See “Record icons” on page 50.

Note: For connected IEEE1394 recording devices only.

Or highlight CANCEL and press ENTER to close the menu, change no information, and return to the highlighted show.

Note: You can change the default values of the Record Options panel menu fields. See “Change default options” on page 54.

TV Guide On Screen® Services (continued)

Record features (continued)

3) Manually set a show to Record

1. Highlight SCHEDULE in the Service Bar, and press MENU to display the Schedule Options panel menu.
2. Highlight NEW MANUAL RECORDING and press ENTER to display the Record Options panel menu.
Press ▲▼◀▶ to move through the options.
Press the Number buttons or ▲▼◀▶ to change the information, as necessary.
3. Enter the information in the panel menu fields. You will need to set the start and end time for the recording. For details, see “Set a show to Record from a panel menu” on the previous page.

Note: When setting a Manual Recording, the frequency option “Daily” is available instead of “Regularly.” See “Record icons,” below right, for a description of Record icons.

4. When finished entering the information in the fields, press ENTER to highlight SCHEDULE RECORDING, and press ENTER again to close the menu.

A Record icon for the selected frequency appears on the show tile. See “Record Icons,” below right.

Note: Manual recording is listed by channel number.

Or highlight CANCEL and press ENTER to close the menu, change no information, and return to the highlighted show.

When using the TV Guide On Screen® system to record a program for the first time, it is recommended that you perform a test recording to make sure your system is set up properly.

Recording notification banner

- If the TV is not on, the recording occurs as scheduled.
- If the TV is on and you are watching the channel that is set to record, the recording occurs as scheduled.
- If the TV is on and you are watching a channel other than the one that is set to record, a notification banner (illustrated below) appears on-screen before recording starts. At that time you can choose to start or cancel recording.

The default highlighted item in the notification banner is “Change channel; start recording.” If no change is made within 3 minutes, the notification banner will close automatically, the channel will change to the one set to record, and the recording will occur as scheduled. If you want to cancel the recording, select “Don’t change; cancel recording” in the notification banner and press ENTER.



Record conflict

A conflict message appears for the following reasons:

- A show set to Record overlaps with any part of another show previously set to Record.
- A show set to Record overlaps with a show previously set to auto-tune. (For auto-tune details, see “Remind features” on page 51.)





Select one of these options:

- Record Anyway—This show will override an existing show set to Record or auto-tune.
- Don’t Record This Show—Cancels the Recording.





Record icons

Following is a description of the Record icons that will appear on the tile for a show set to Record.

- Record Once —Records the show one time.
- Record Regularly —Records the show every time the show airs on the same channel and starts at the same time.
- Record Weekly —Records the show every time the show airs on the same day of the week and on the same channel, and starts at the same time.
- Record Daily —Records on the same channel and at the same start time every weekday (Monday through Friday).

Note: This icon displays for manual recordings only.

- Record Suspend —Recording is Suspended due to a schedule conflict (show remains in Schedule).
- Record Off —Keeps the Recording in the Schedule list but will not record this show until the frequency is changed.

The unauthorized recording, use, distribution, or revision of television programs, videotapes, DVDs, and other materials is prohibited under the Copyright Laws of the United States and other countries, and may subject you to civil and criminal liability.

TV Guide On Screen® Services (continued)

Remind features

You can set a Reminder to perform the following functions:

- Automatically turn on the TV (if off) at the scheduled reminder time, and tune the TV to the channel of the show for which you set the reminder.
- Automatically tune the TV, at the scheduled reminder time, to the channel of the show for which you set the reminder.
- Display an on-screen notification banner (reminding you that the show is about to start), from which you can choose to tune the TV to the show's channel or cancel the reminder.

You can set a show reminder, or edit the reminder settings for a show, in LISTINGS, SEARCH, and SCHEDULE. There are two ways to set a show reminder, as described below.

1) Set a show Reminder from a panel menu

1. Highlight a show and press MENU to display the Episode Options panel menu.
2. Highlight SET REMINDER and press ENTER to display the Remind Options panel menu.



3. Highlight the FREQUENCY field, and press ◀▶ to choose among Once, Regularly, Weekly, or Off.
4. Highlight the POWER ON TV field, and press ◀▶ to choose either Yes (to turn on the TV automatically, if off, at the scheduled Reminder time) or No (default).
5. Highlight the AUTO TUNE TV field, and press ◀▶ to choose either Yes (to automatically tune the TV to the channel you are setting the Reminder for at the scheduled Reminder time; the TV must be on at the time) or No (default).

Note: You can change the default values of the Remind Options panel menu fields. See "Change default options" on page 54 for details.
6. Highlight the WHEN field (to set a time for displaying the reminder screen), and press ◀▶ to choose in the range from 15 minutes early to 15 minutes late or On Time (default = 1 minute early).
7. Press ENTER to highlight SCHEDULE REMINDER, and press ENTER again to close the menu. A Remind icon for the selected frequency appears on the show tile. See "Remind icons" on page 52.

Or highlight CANCEL and press ENTER to close the menu, change no information, and return to the highlighted show.

2) Manually set a show Reminder

1. Highlight SCHEDULE in the Service Bar, and press MENU to display the Schedule Options panel menu.
2. Highlight NEW MANUAL REMINDER and press ENTER to display the Remind Options panel menu. Press ▲▼◀▶ to move through the options. Press the Number buttons or ▲▼◀▶ to change the information, as necessary.



3. Enter the information in the panel menu fields. You will need to set the start and end time for the reminder. For details, see "Set a show reminder from a panel menu," at left.

Note: When setting a Manual Reminder, the frequency option "Daily" is available instead of "Regularly." See "Remind icons," on the following page, for a description of Reminder icons.

4. When finished entering the information in the fields, press ENTER to highlight SCHEDULE REMINDER, and press ENTER again to close the menu.

A Remind icon for the selected frequency appears on the show tile. See "Remind icons" on the following page.

Note: Manual reminders are listed by channel number.

Or highlight CANCEL and press ENTER to close the menu, change no information, and return to the highlighted show.

TV Guide On Screen® Services (continued)

Remind features (continued)

Reminder notification banner

Based on your option settings, a notification banner will appear on-screen, if your TV is on at the scheduled Reminder time.

At that time you can either press ENTER to hide the Reminder banner, or highlight the show and press ENTER to tune to the show.

If no choice is made within 3 minutes, the notification banner closes automatically and completes the highlighted item (default is HIDE REMINDERS).

Note: If more than two reminders are set for the same time, arrows appear on the Reminder notification banner. Press ▲▼ to highlight the shows.



Remind conflict

A conflict message appears for the following reasons:

- A show set with an auto-tune Reminder has the same start time as an existing auto-tune Reminder.
- A show set with an auto-tune Reminder overlaps with a scheduled Recording.

Select one of these options:

- Auto-Tune Anyway—This show will override an existing show set to auto-tune.
- Proceed, No Auto-Tune—Set the show as a Reminder but do not auto-tune.
- Don't Set This Reminder—Cancels the Reminder.

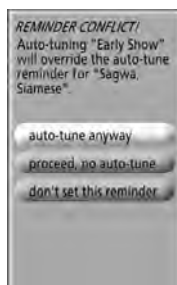

Remind icons

Following is a description of the Remind icons that will appear on the tile for a show set to Remind.

- Remind Once —Displays a show reminder one time.
- Remind Regularly —Displays a show reminder every time the show airs on the same channel and starts at the same time.
- Remind Daily —Displays a show Reminder every weekday (Monday through Friday) for the same channel and start time.

Note: This icon displays for manual reminders only.

- Remind Suspend —Reminder is Suspended due to a schedule conflict (show remains in Schedule).
- Remind Off —Keeps the Reminder in the schedule list but will not display a reminder until you change the frequency.

TV Guide On Screen® Services (continued)

SETUP screen

After you complete the initial TV Guide On Screen® setup (as described in Chapter 5), you can change the following settings:

- Change system settings
- Change channel display
- Change default options

Highlight a choice, press ENTER, and follow the on-screen instructions.



With SETUP highlighted in the Service Bar, press INFO to display a help screen. Press INFO again to close the screen.

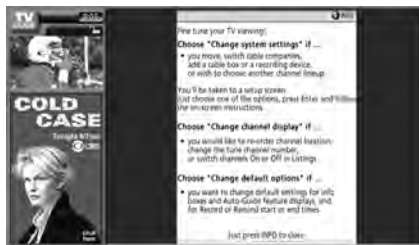

Change system settings

This option appears only after you have completed the initial TV Guide On Screen® setup process (as described in Chapter 5).

1. From the SETUP screen, highlight CHANGE SYSTEM SETTINGS and press ENTER.



2. Press ENTER again to display the Confirming Your Settings screen.

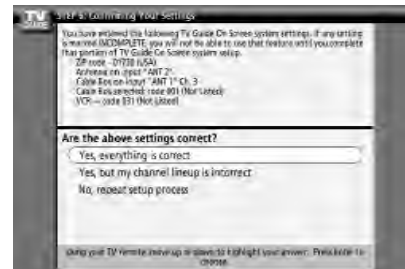

3. Highlight one of the options, press ENTER, and follow the on-screen instructions.

TV Guide On Screen® Services (continued)

SETUP screen (continued)

Change channel display

This option allows you to edit channel information that appears in LISTINGS, including the following:

- Reorder the position the channels appear in LISTINGS.
- Change the “tune channel” number.

Note: The “tune channel” is the channel on which you receive a station. For example, two viewers in the same zip code may receive the same station on different channel numbers, depending on whether they have Cable service or are using a cable box.

- Switch a channel to one of the following settings:
 - **On** (channel is always displayed in LISTINGS)
 - **Off** (channel is never displayed in LISTINGS)
 - **Auto-Hide** (channel is displayed in LISTINGS only when program information is available)

1. From the SETUP screen, highlight CHANGE CHANNEL DISPLAY and press ENTER.



2. Highlight the channel row you want to edit and press ENTER to display the Grid Options panel menu.



3. To edit the options, press INFO and follow the on-screen instructions.

Change default options

This option allows you to change default settings in the following categories:

- General Defaults
- Record Defaults
- Remind Defaults

General defaults

1. From the SETUP screen, highlight CHANGE DEFAULT OPTIONS and press ENTER.



2. Highlight GENERAL DEFAULTS and press MENU to display the General Defaults panel menu.



3. Enter the following information in the panel menu fields:
 - **BOX SIZE:** The initial Info Box size when you open the TV Guide On Screen® system. Choices are No, Small, Large, and Last Used (default).
 - **BOX CYCLE:** The Info Box size rotation when you press INFO on the remote control when the TV Guide On Screen® system is open. Choices are No Only, Small Only, Large Only, No & Small, No & Large, Small & Large, and All (default).
 - **AUTO GUIDE:** Automatic entry into the TV Guide On Screen® system when the TV is powered on. Choices are On (default) and Off.

Note: Set the AUTO GUIDE to Off if you do not want the TV Guide On Screen® system to open every time you turn on the TV.
4. When finished, press ENTER to highlight DONE, and press ENTER again to close the menu and accept the changes (or highlight CANCEL to close the menu with no changes).

TV Guide On Screen® Services (continued)

SETUP screen (continued)

Record defaults

1. From the SETUP screen, highlight CHANGE DEFAULT OPTIONS and press ENTER.
2. Highlight RECORD DEFAULTS and press MENU to display the Record Defaults panel menu.



3. Enter the required information in the panel menu fields (start time, end time, recorder choice, how long to keep a Record event, the quality of the recording). See “Record features” on page 49 for details on entering values in these fields.
4. When finished, press ENTER to highlight DONE, and press ENTER again to close the menu and accept the changes (or highlight CANCEL to close the menu with no changes).

Remind defaults

1. From the SETUP screen, highlight CHANGE DEFAULT OPTIONS and press ENTER.
2. Highlight REMIND DEFAULTS and press MENU to display the Remind Defaults panel menu.



3. Enter the required information in the panel menu fields (power On TV, auto-tune, when to display the Remind screen). See “Remind features” on page 51 for details on entering values in these fields.
4. When finished, press ENTER to highlight DONE, and press ENTER again to close the menu and accept the changes (or highlight CANCEL to close the menu with no changes).

8 Using the TV's features

Selecting the video input source to view

To select the video input source to view:

1. Press INPUT on the remote control or TV/VIDEO on the TV top panel.
2. Press 0–6 to select the input source you want to view, which will depend on the input terminals you used to connect your devices (see Chapter 2).

The current signal source displays in the top right corner of the Input Selection screen.

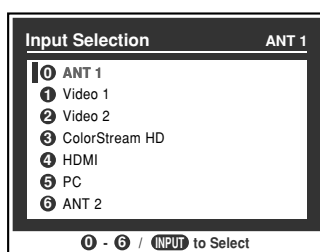

Note:

- When the Input Selection screen is open, you also can use ▲▼ on the remote control (or the CHANNEL ▲▼ on the top panel) to change the input.
- You can repeatedly press INPUT on the remote control or TV/VIDEO on the TV top panel to change the input.
- You can label the video input sources according to the specific devices you have connected to the TV (see "Labeling the video input sources" on the next page).
- The source can be "hidden." See page 57 for details.

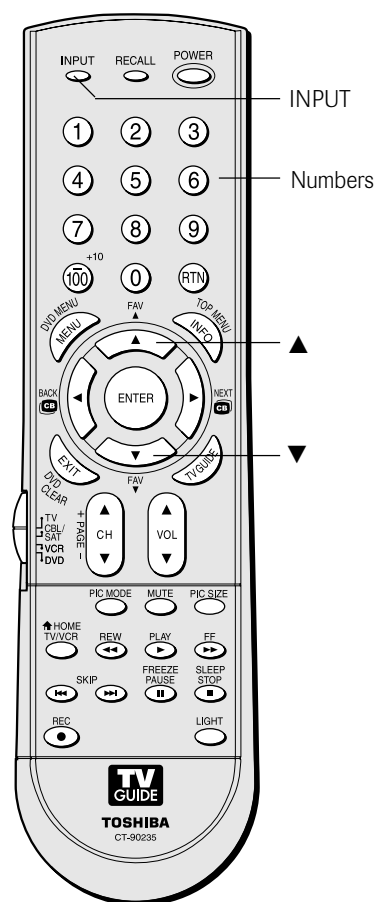

Remote control

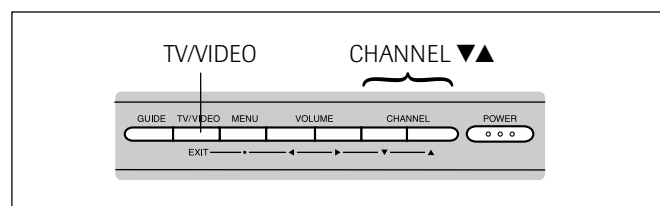

TV top panel

Labeling the video input sources

You can label each video input source according to the type of device you connected to each source, from the following preset list of labels:

-- (default label)

- Cable
- DTV
- Satellite/DSS
- VCR
- Laser Disk
- DVD
- Audio Receiver
- Compact Disc
- Video Recorder
- Hide (to hide an unused input in the Input Selection window)

Note:

If you set up a cable box in VIDEO 1, that input will be labeled automatically and cannot be relabeled until you remove the device from the TV Guide On Screen® setup.

To label the video input sources:

1. Press MENU and open the Preferences menu.
2. Highlight Input Labeling and press ENTER.
3. Press ▲▼ to highlight the video source you want to label.

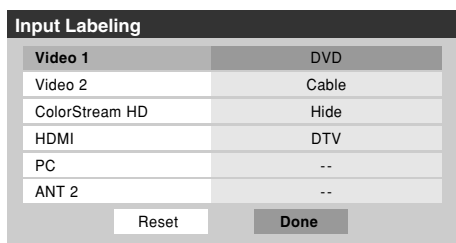
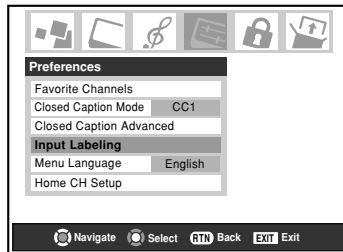

4. Press ◀▶ to select the desired label for that input source. If a particular input is not used, you can select “Hide” as the label, which will cause that input to be “grayed out” in the input list and skipped over when you press INPUT on the remote control.
5. To save the new input labels, highlight Done and press ENTER. To revert to the factory default labels, highlight Reset and press ENTER.

Input labeling example:

The screen below left shows the default Input Selection screen (with none of the inputs labeled). The screen below right is an example of how you could label the inputs if you had connected a DVD player to VIDEO 1, Cable TV to VIDEO 2, and a DTV set-top box to HDMI. Also note that the ColorStream HD input is labeled “Hidden,” which means that the input will be skipped over when INPUT or TV/VIDEO is pressed.

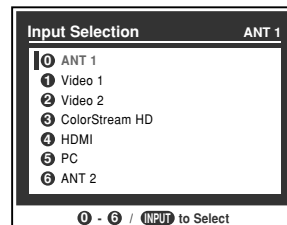

Input Selection screen with no inputs labeled

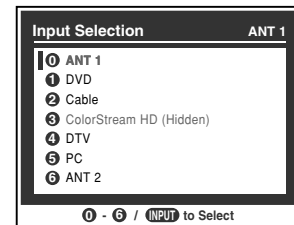

Input Selection screen with all inputs labeled except input 3, which has been hidden.

To clear the input labels:

1. Press MENU and open the Preferences menu.
2. Highlight Input Labeling and press ENTER.
3. Highlight Reset and press ENTER.

Tuning channels

Using the Channel Browser™

The Channel Browser stores the most recently viewed channels (up to 32) in the channel history. This feature allows you to:

- Keep a separate, temporary* history of the last 32 channels tuned from each of three inputs: ANT 1, ANT 2, and Cable Box.
 - ***Note:** Turning off the TV will clear the channel history for all three inputs.
- Quickly surf and tune your recently viewed channels from the Channel Browser banner (illustrated below).
- Surf via Browse mode (to immediately tune channels as you highlight them in the Channel Browser banner) or Select mode (to surf over channels in the browser banner before you select one to tune).
- Set a "HOME" channel for the ANT 1, ANT 2, and Cable Box inputs.

To open the Channel Browser banner: Press ◀ (BACK CB), ▶ (NEXT CB), or ENTER on the remote control.

- Press ◀ (BACK CB) to surf back from the most recently viewed channel through the last 32 channels that were tuned from the current input, which are automatically stored in the channel history for the current input (ANT 1, ANT 2, or Cable Box only).
- Press ▶ (NEXT CB) to surf forward from the previous channels in the channel history up to the most recently viewed channel.

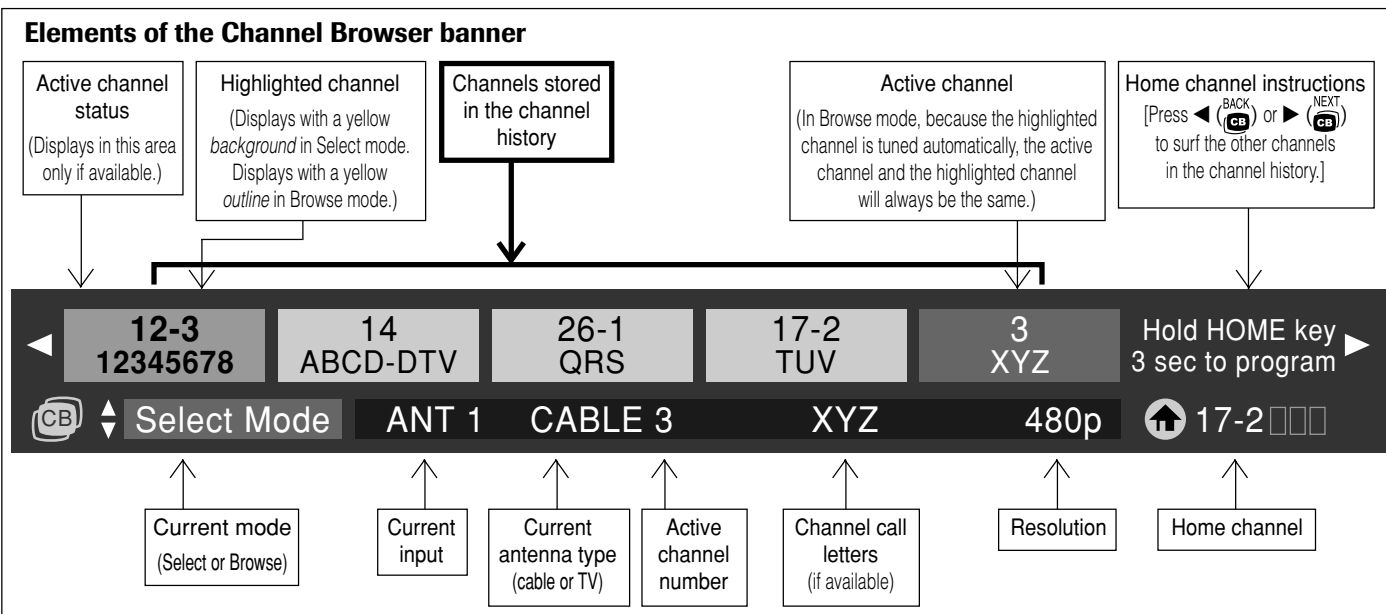

To toggle between Browse mode and Select mode:

After opening the Channel Browser banner, press ▲ or ▼ to toggle between Browse mode and Select mode. The "Current mode" field on the Channel Browser banner will flash green. **Note:** The Channel Browser banner opens in Browse mode by default.

To tune to a channel in Browse mode:

1. While watching TV, press ◀ (BACK CB) or ▶ (NEXT CB) to open the Channel Browser banner and surf back to a previous channel or forward to the next channel in the channel history. In Browse mode, when you stop on a channel number in the browser banner, it will be highlighted with a yellow outline and the TV will automatically tune to the channel.
2. Press EXIT to close the Channel Browser banner.



In Browse mode, the highlighted channel number is outlined in yellow and the channel will be tuned to automatically.

Note: The Channel Browser banner will close automatically if you do not make a selection within 60 seconds.

To tune to a channel in Select mode:

1. While watching TV, press ◀ (BACK CB) or ▶ (NEXT CB) to open the Channel Browser banner and surf back to a previous channel or forward to the next channel in the channel history. In Select mode, when you stop on a channel number in the browser banner, it will be highlighted with a yellow background but the TV will not automatically tune to the channel.
2. Press ENTER to tune the TV to the highlighted channel.
3. Press EXIT to close the Channel Browser banner.

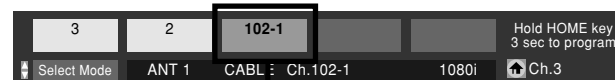

In Select mode, the highlighted channel number has a yellow background. Press ENTER to tune to the channel.

Tuning channels (continued)

Using the Channel Browser™ (continued)

Adding and clearing channels in the channel history

Adding channels to the channel history

The Channel Browser automatically creates a history of the last 32 channels that were tuned in the current input (ANT 1, ANT 2, and Cable Box inputs only). A separate history will be stored for each of these inputs.

If you change the input you are viewing:

- you will begin a channel history for that input if one did not exist; or
- you will return to the existing channel history for that input if one had already been started.

The Channel Browser will store the following channels:

- All channels that are tuned using the numeric buttons on the remote control.
- All channels that are tuned for at least 7 seconds using the CH ▲▼ buttons or the FAV ▲▼ buttons on the remote control.

Clearing channels from the channel history

- Turning off the TV will clear all three channel histories (ANT 1, ANT 2, and Cable Box).
- Removing the CableCARD™ will clear the channel history for the ANT 1 input.
- Reconfiguring the ANT 1, ANT 2, or Cable Box input will clear the channel history for the newly configured input(s).

Note: See page 35 for details on configuring the antenna inputs.

Setting a channel as the "Home" channel for an input

To set a channel as Home using the remote control:

- Tune the TV to the channel you would like to set as the Home channel for the current antenna input.
- Press and hold the HOME (🏠) button on the remote control for 3 seconds. When the Home channel is saved, the Channel Browser banner will appear at the bottom of the screen with the home icon flashing green.

Note: You can set a different Home channel for each input (ANT 1, ANT 2, and Cable Box inputs only).

To set a channel as Home using the menus:

- Press MENU and open the Preferences menu.
- Highlight Home CH Setup and press ENTER. The Home CH Setup window will display.

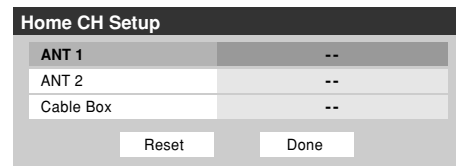

Note: "Cable Box" will appear in the Home CH Setup window only if you connected a cable box to your TV.

- Use the ▲▼ buttons to select the input for which you want to set the Home channel.
- Use the numeric and dash (-) buttons on the remote control to enter the desired Home channel for each input.
- To save your entries, highlight Done and press ENTER. To clear your entries, highlight Reset and press ENTER.

To tune to the Home channel:

While an input that has a set Home channel is active, press the HOME (🏠) button on the remote control.

Note: If you press the HOME button while an input other than an antenna or Cable Box input is selected, the TV will tune to the most recently tuned Home channel and input.

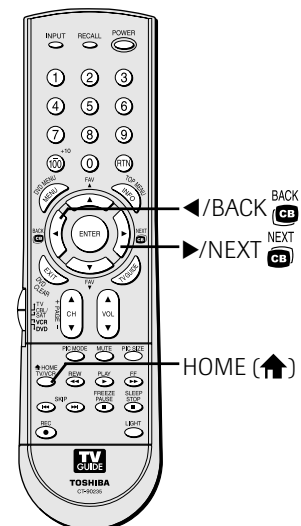

Tuning channels (continued)

Tuning your favorite channels

To tune to the channels you programmed as Favorite Channels, see page 38.

Tuning to the next programmed channel

To tune to the next programmed channel:

Press CH ▲▼ on the remote control or TV top panel.

Note:

- This feature will not work unless you program channels into the TV's channel memory (see page 36).
- If you are recording a digital channel, you will only be able to change analog channels while the recording is in progress. If you are recording an analog channel, you will only be able to change digital channels while the recording is in progress. This is because the TV tuner that is being recorded (digital or analog) will be locked on the channel that is currently recording.

Tuning to a specific channel (programmed or unprogrammed)

Tuning analog channels:

Press the Channel Number buttons (0–9) on the remote control. For example, to select channel 125, press 1, 2, 5.

Tuning digital channels:

Press the Channel Number buttons (0–9) on the remote control, followed by the – (dash) button and then the sub-channel number. For example, to select digital channel 125-1, press 1, 2, 5, –, 1.

Note: If a digital channel is not programmed—either through the automatic channel scan (page 36) or the channel add/delete function (page 37)—you will have to tune the RF channel using the Channel Number and Dash buttons on the remote control.

Switching between two channels using Channel Return

The Channel Return feature allows you to switch between two channels without entering an actual channel number each time.

1. Select the first channel you want to view.
2. Select a second channel using the Channel Number buttons (and the dash (–) button if selecting a digital channel).
3. Press RTN on the remote control. The previous channel will display. Each time you press RTN, the TV will switch back and forth between the last two channels that were selected.

Note:

- If you press RTN from a non-antenna input, the TV will return to the last-viewed ANT input and channel.
- If you are currently recording a program, this feature will not be available.

Switching between two channels using SurfLock™

The SurfLock™ feature temporarily “memorizes” one channel in the RTN button, so you can return to that channel quickly from any other channel by pressing RTN. To memorize a channel in the RTN button:

1. Select the channel you want to program into the RTN button.
2. Press and hold RTN for about 2 seconds until the message “Channel Memorized” appears on the screen. The channel has been programmed into the RTN button.
3. You can then change channels repeatedly, and when you press RTN, the memorized channel will be selected.

Press RTN. The memorized channel will be selected. The TV will return to the memorized channel one time only. Once you press RTN and then change channels again, the RTN button memory will be cleared and the button will function as Channel Return, by switching back and forth between the last two channels that were selected.

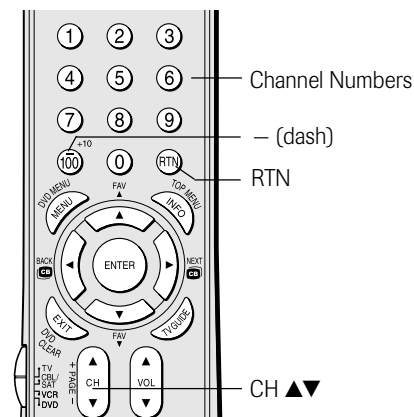

Selecting the picture size

You can view many program formats in a variety of picture sizes—Natural, TheaterWide 1, TheaterWide 2, TheaterWide 3, and Full—as described below and on the next page.

The way the image displays in any of the picture sizes will vary depending on the format of the program you are viewing. Select the picture size that displays the current program the way that looks best to you.

Your picture size preferences can be saved for each input on your TV.

To select the picture size:

1. Press PIC SIZE on the remote control.
2. While the Picture Size menu is on-screen, press the corresponding number button (0–4) to select the desired picture size.

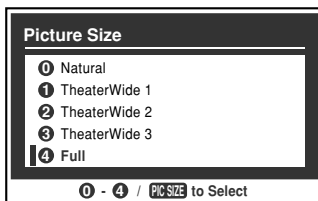

Note:

- You also can repeatedly press PIC SIZE to select the desired picture size (or press ▲ ▼ on the remote control while the Picture Size screen is open).
- "Full" may not be available for some program formats (will be "grayed out" in the Picture Size screen).

Natural picture size

- The image is displayed close to its originally formatted proportion. Some program formats will display with side bars and/or bars at the top and bottom.

Natural picture size example: The way the image displays will vary depending on the format of the program you are currently watching.

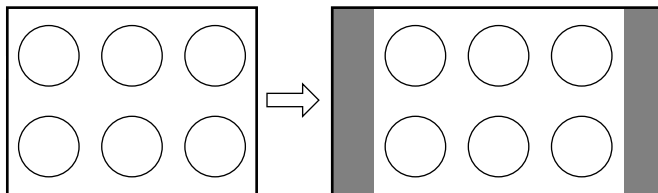

Conventional picture on a conventional TV screen

Conventional picture in Natural size on your wide-screen TV

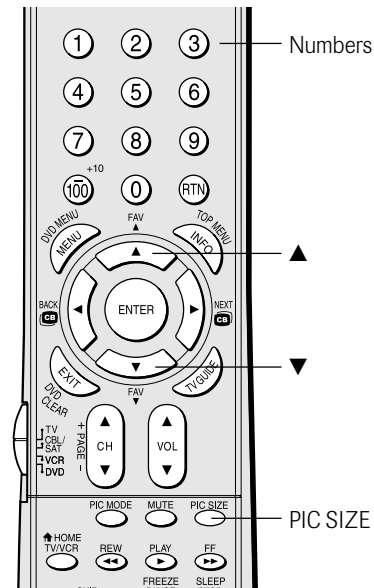

Note:

You also can select the picture size using the menu system. Select Picture Size in the Video/Theater Settings menu. Select the input for which you want to save your picture settings. To save your settings, highlight Done and press ENTER.

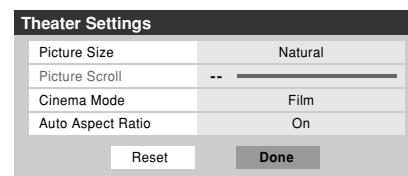

Selecting the picture size (continued)

TheaterWide 1 picture size (For 4:3 format program)

- The center of the picture remains close to its original proportion, but the left and right edges are stretched wider to fill the screen.

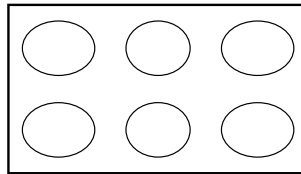
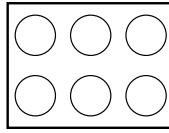

TheaterWide 1 picture size example

TheaterWide 2 picture size (for letter box programs)

- The picture is stretched wider to fill the width of the screen, but only slightly stretched taller.
- The top and bottom edges of the picture are hidden. To view the hidden areas, see "Scrolling the TheaterWide® picture" on page 63.

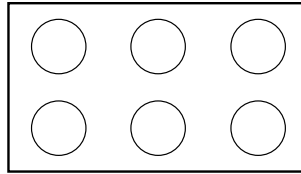
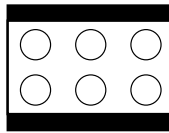

TheaterWide 2 picture size example

TheaterWide 3 picture size (for letter box programs with subtitles)

- The picture is stretched wider to fill the width of the screen, but only slightly stretched taller.
- The top and bottom edges are hidden. To view the hidden areas (such as subtitles or captions), see "Scrolling the TheaterWide® picture" on page 63.

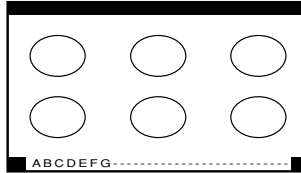
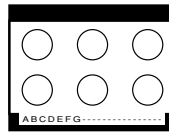

TheaterWide 3 picture size example

Full picture size (for 16:9 [480i, 480p] source programs only)

- If receiving a squeezed 4:3 format program, it is stretched wider to fill the width of the screen, but not stretched taller.
- None of the picture is hidden.

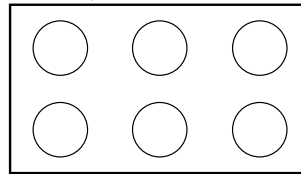
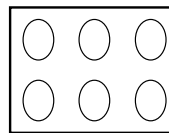

Full picture size example

To select the picture size, press PIC SIZE on the remote control.

Note:

- If you select one of the TheaterWide® picture sizes, the top and bottom edges of the picture (including subtitles or captions) may be hidden. To view the hidden edges, either scroll the picture (TheaterWide 2 and 3 only) or try viewing the program in Full or Natural picture size.
- When selecting the picture size, the way the image displays will vary depending on currently watching.

Using these functions to change the picture size (i.e., changing the height/width ratio) for any purpose other than your private viewing may be prohibited under the Copyright Laws of the United States and other countries, and may subject you to civil and criminal liability.

Scrolling the TheaterWide® picture (TheaterWide 2 and 3 only)

You can set separate scroll settings for the TheaterWide 2 and TheaterWide 3 modes for each input.

To set the scroll settings:

1. Press INPUT on the remote control or TV/VIDEO on the TV to select the input for which you want to set the picture size and scroll settings.
2. Press MENU and open the Video menu.
3. Highlight Theater Settings and press ENTER.

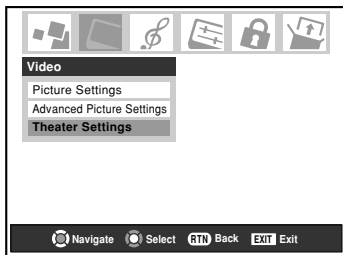

4. In the Picture Size field, select either TheaterWide 2 or TheaterWide 3 (you cannot scroll in any other mode).
5. Press ▼ to highlight the Picture Scroll field.
6. Press ◀▶ to scroll the picture up and down as needed, from -10 to +20.

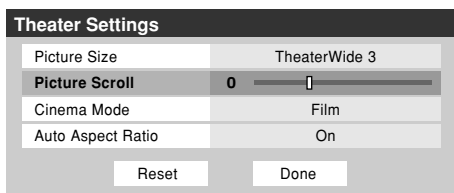

7. To save the new settings, highlight Done and press ENTER. To revert to the factory defaults, highlight Reset and press ENTER.

Using the auto aspect ratio feature

When the auto aspect ratio feature is set to On, the picture size is automatically selected when one of the following input sources is received:

- A 480i signal from the VIDEO 1, VIDEO 2, or ColorStream HD input.
- A 480i, 480p, 1080i or 720p signal from the HDMI input.

Aspect ratio of signal source	Automatic aspect size (automatically selected when Auto Aspect is On)
4:3 normal	Natural (with sidebars)
4:3 letter box	TheaterWide 2
16:9 full	Full
Not defined (no ID-1 data or HDMI aspect data)	User-selected picture size (see pages 61-62)

Note:

- The auto aspect ratio feature is not applicable to antenna or Cable input sources.
- The auto aspect ratio feature is not available when the FREEZE mode is active, or the TV Guide On Screen® system is open.

To turn on the auto aspect ratio feature:

1. Press MENU and open the Video menu.
2. Highlight Theater Settings and press ENTER.

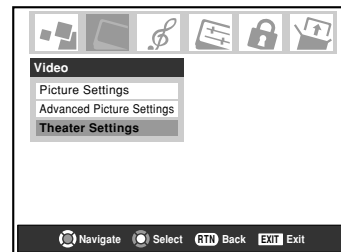

3. In the Auto Aspect Ratio field, select On.

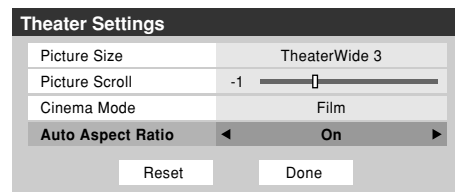

4. To save the new settings, highlight Done and press ENTER. To revert to the factory defaults, highlight Reset and press ENTER.

To turn off the auto aspect ratio feature:

Select Off in step 3 above.

Selecting the cinema mode (480i signals only)

When you view a DVD (480i signal; 3:2 pulldown processed) from a DVD player connected to the VIDEO 1, VIDEO 2, ColorStream HD (component video), or HDMI inputs on the TV, smoother motion can be obtained by setting the Cinema Mode to Film.

To set the Cinema Mode to Film:

1. Press MENU and open the Video menu.
2. Highlight Theater Settings and press ENTER.

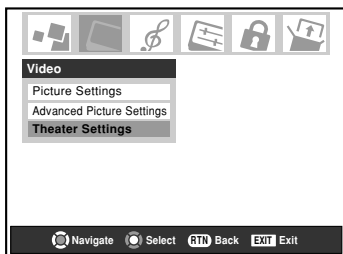

3. In the Cinema Mode field, select Film.

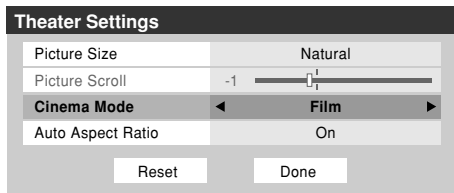

4. To save the new settings, highlight Done and press ENTER. To revert to the factory defaults, highlight Reset and press ENTER.

To set the Cinema Mode to Video:

Select Video in step 3 above.

Using the FREEZE feature

1. When viewing the TV, press FREEZE to make the picture a still picture.
2. To return to the moving picture, either press FREEZE again, press EXIT, or press any other button.

Note: If the TV is left in FREEZE mode, after 15 minutes it will automatically release the FREEZE mode and return to the moving picture.

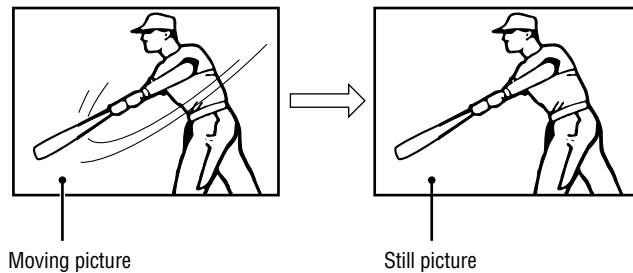

Using the FREEZE function for any purpose other than your private viewing may be prohibited under the Copyright Laws of the United States and other countries, and may subject you to civil and criminal liability.

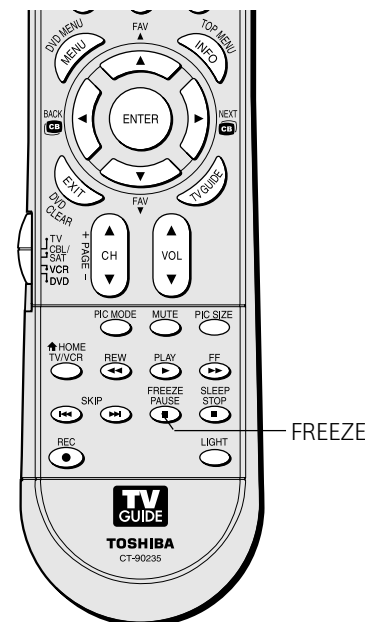

Adjusting the picture

Selecting the picture mode

You can select your desired picture settings from four picture modes, as described below.

Mode	Picture Quality
Sports	Bright and dynamic picture (factory setting)
Standard	Standard picture settings (factory setting)
Movie	Lower contrast for darkened room (factory setting)
Preference	Your personal preferences

To select the picture mode:

Press PIC MODE on the remote control. The following popup menu appears on-screen.



Repeatedly press PIC MODE to cycle among the modes.

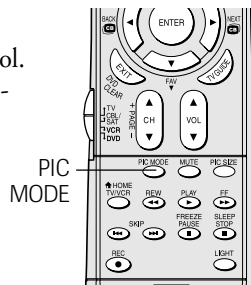

To select the picture mode using the menu system:

1. Press MENU and open the Video menu.
2. Highlight Picture Settings and press ENTER.

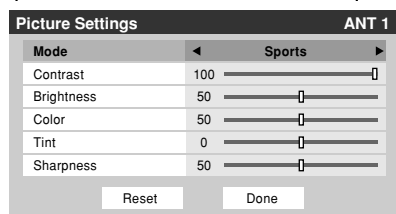
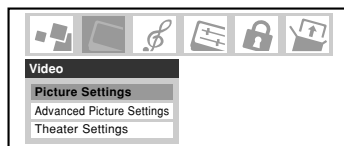

3. Press ▼ to highlight the Mode field, and then ◀▶ to select the mode you prefer.



4. To save the new settings, highlight Done and press ENTER. To revert back to the factory defaults, highlight Reset and press ENTER.

Note:

- The picture mode you selected is for the current input selection only (ANT 1 in the example above). You can select a different picture mode for each input selection.
- If you select one of the factory-set picture modes (Sports, Standard, or Movie) and then change a picture quality setting (for example, increase the contrast or change the color temperature), the picture mode automatically changes to Preference in the Picture Settings menu.

Adjusting the picture quality

You can adjust the picture quality (contrast, brightness, color, tint, and sharpness) to your personal preferences.

Selection	◀ Pressing ▶
Contrast	lower higher
Brightness	darker lighter
Color	paler deeper
Tint	reddish greenish
Sharpness	softer sharper

To adjust the picture quality:

1. Press MENU and open the Video menu.
2. Highlight Picture Settings and press ENTER.

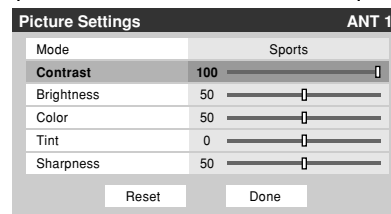
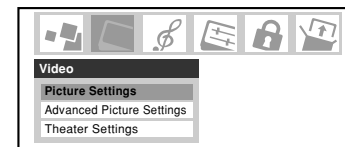

3. Press ▲▼ to select the picture quality you want to adjust (Contrast, Brightness, Color, Tint, or Sharpness), and then ◀▶ to adjust the setting, as described in the table above.

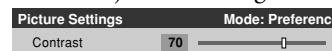

4. To save the new settings, highlight Done and press ENTER. To revert back to the factory defaults, highlight Reset and press ENTER.

The picture qualities you adjusted are automatically saved in the Preference mode (see “Selecting the picture mode,” above left).

Adjusting the picture (continued)

Using CableClear® /DNR (digital noise reduction)

The CableClear® digital noise reduction feature allows you to reduce visible interference in your TV picture. This may be useful when receiving a broadcast with a weak signal (especially a Cable channel) or playing a noisy video cassette or disc.

To select CableClear/DNR preferences:

1. Press MENU and open the Video menu.
2. Highlight Advanced Picture Settings and press ENTER.
3. Press ▼ to highlight the CableClear/DNR field, and then press ◀▶ to make a selection.

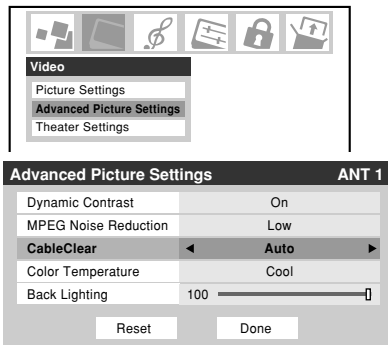

Note:

- For the current inputs Antenna, Video 1, or Video 2, the menu will display the text "CableClear." If the signal is analog, the available selections are Off, Low, Middle, High, and Auto. If the signal is digital, the menu will display the text "CableClear" and will be "grayed out" with "Off" selected.
 - For the current inputs ColorStream HD or HDMI, the menu will display the text "DNR." If the video resolution is 480i, the available selections are Off, Low, Middle, High, and Auto. If the video resolution is 1080i, the available selections are Off, Low, and High. If the video resolution is anything other than 480i or 1080i, the menu will display the text "DNR" and will be "grayed out" with "Off" selected.
4. To save the new settings, highlight Done and press ENTER. To revert to the factory defaults, highlight Reset and press ENTER.

Selecting the color temperature

You can change the quality of the picture by selecting from three preset color temperatures (cool, medium, and warm), as described below.

Mode	Picture Quality
Cool	blueish
Medium	neutral
Warm	reddish

To select the color temperature:

1. Press MENU and open the Video menu.
2. Highlight Advanced Picture Settings and press ENTER.
3. Press ▼ to highlight the Color Temperature field, and then press ◀▶ to select the mode you prefer (Cool, Medium, or Warm).

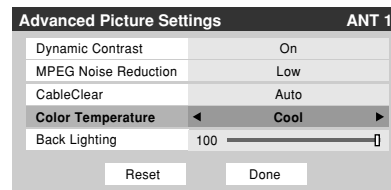
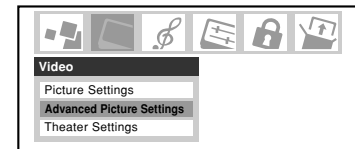

4. To save the new settings, highlight Done and press ENTER. To revert to the factory defaults, highlight Reset and press ENTER.

Note:

If you select one of the factory-set picture modes (Sports, Standard, or Movie) and then change the color temperature mode, the picture mode automatically changes to Preference in the Picture Settings menu.

Adjusting the picture (continued)

Adjusting the back lighting feature

You can use the back lighting feature to adjust the screen brightness for improved picture clarity.

To adjust the back lighting:

1. Press MENU and open the Video menu.
2. Highlight Advanced Picture Settings and press ENTER.
3. Press ▼ to highlight Back Lighting, and then press ◀▶ to adjust the screen brightness (0-100).

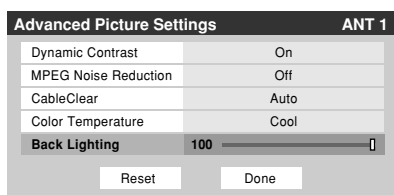

4. To save the new settings, highlight Done and press ENTER. To revert to the factory defaults, highlight Reset and press ENTER.

Using MPEG noise reduction

The MPEG noise reduction feature allows you to reduce visible interference caused by MPEG compression. Choices for MPEG noise reduction are High, Medium, Low and Off. Off is automatically selected when this feature is disabled ("grayed out"). This feature is not available in the PC input mode.

To select the MPEG noise reduction level:

1. Press MENU and open the Video menu.
2. Highlight Advanced Picture Settings and press ENTER.

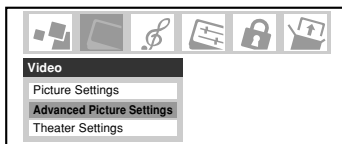

3. Press ▼ to highlight the MPEG Noise Reduction field, and then press ◀▶ to make a selection.

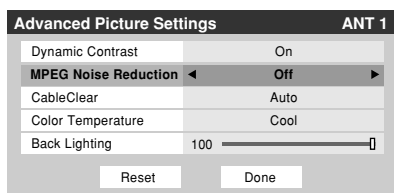

4. To save the new settings, highlight Done and press ENTER. To revert to the factory defaults, highlight Reset and press ENTER.

Using dynamic contrast

When dynamic contrast is set to "On," the TV will detect changes in the picture quality that affect the appearance of your contrast settings and then automatically adjust the video.

When dynamic contrast is set to "Off," the settings selected in the Contrast field in Picture Settings will be used.

To select dynamic contrast preferences:

1. Press MENU and open the Video menu.
2. Highlight Advanced Picture Settings and press ENTER.

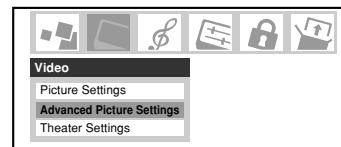

3. Press ▼ to highlight the Dynamic Contrast field, and then press ◀▶ to make a selection (On or Off).

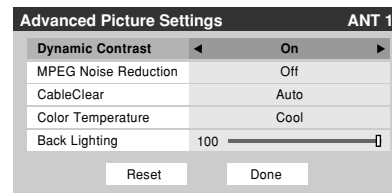

4. To save the new settings, highlight Done and press ENTER. To revert to the factory defaults, highlight Reset and press ENTER.

Note:

If you select one of the factory-set picture modes (Sports, Standard, or Movie) and then set the dynamic contrast to "On," the picture mode automatically changes to Preference in the Picture Settings menu.

Using the closed caption mode

The closed caption mode has two options:

- Captions—An on-screen display of the dialogue, narration, and sound effects of TV programs and videos that are closed captioned (usually marked “CC” in program guides).
- Text—An on-screen display of information not related to the current program, such as weather or stock data (when provided by individual stations).

To view captions or text:

1. Press MENU and open the Preferences menu.
2. Highlight Closed Caption Mode and then press ► to open the menu sidebar.
3. Press ▼ to highlight the desired closed caption mode and then press ENTER.

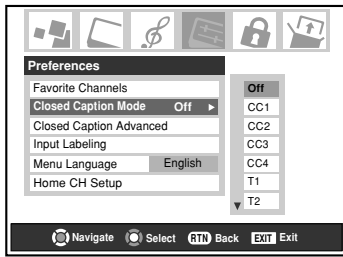

To view captions:

Highlight CC1, CC2, CC3, or CC4. (CC1 displays translation of the primary language in your area.)



Note: If the program or video you selected is not closed captioned, no captions will display on-screen.

To view text:

Highlight T1, T2, T3, or T4.

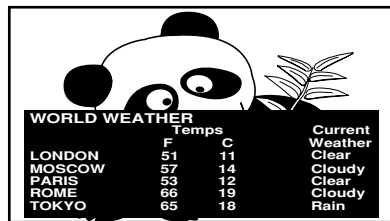

Note: If text is not available in your area, a black rectangle may appear on your screen. If this happens, turn the Closed Caption Mode Off.

To turn off the Closed Caption mode:

Select Off in step 3 above.

Note: A closed caption signal may not display in the following situations:

- When a videotape has been dubbed
- When the signal reception is weak
- When the signal reception is non-standard

Advanced closed captions

You can customize the closed caption display characteristics by changing the text size, type, edge, color, and the background color. You cannot set the Caption Text and Background as the same color.

Note: This feature is available for digital channels only.

To customize the closed captions:

1. Press MENU and open the Preferences menu.
2. Highlight Closed Caption Advanced and press ENTER.
3. Press ▲▼ to highlight the characteristic you want to change, and then press ◀▶ to select the format for that characteristic.
4. To save the new settings, highlight Done and press ENTER. To revert to the factory defaults, highlight Reset and press ENTER.

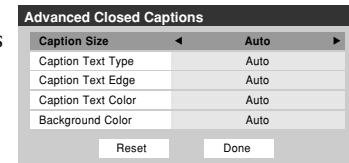
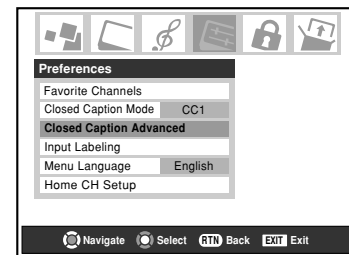

Caption Size	Auto, Small, Standard, Large
Caption Text Type	Auto, Default, Mono w. serif, Prof. w. serif, Mono w/o serif, Prop w/o serif, Casual, Cursive, Small capitals
Caption Text Edge	Auto, None, Raised, Depressed, Uniform, Left Drop shadow, Right Drop shadow
Caption Text Color	Auto, Black, White, Red, Green, Blue, Yellow, Magenta, Cyan
Background Color	Auto, Black, White, Red, Green, Blue, Yellow, Magenta, Cyan

Using the closed caption mode (continued)

Digital closed captions

You can use the Digital CC/Audio selector to select digital closed caption services (if available), which will temporarily override closed captions for digital channels only.

When such services are not available, the Digital CC/Audio selector presents a default list of services. If the selected service is not available, the next best service will be used instead.

To select digital closed captions:

1. Press MENU and open the Applications menu.
2. Highlight Digital CC/Audio Selector and press ENTER.

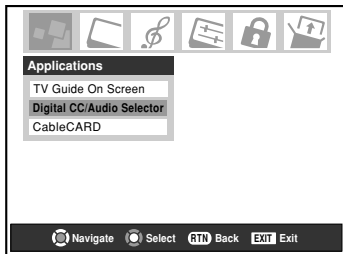

3. Press ▲▼ to select Closed Caption.



Adjusting the audio

Muting the sound

Press MUTE to partially reduce (1/2 Mute) or turn off (Mute) the sound. Each time you press MUTE, the mute mode will change in the following order.

→ 1/2 Mute → Mute → Volume →

If the closed caption mode is set to Off when you select "Mute" mode, the closed caption feature is automatically activated. To mute the audio without automatically activating the closed caption feature, use VOL ▼ to set the volume to 0. See "Using the closed caption mode" on page 68 for more information on closed caption modes.

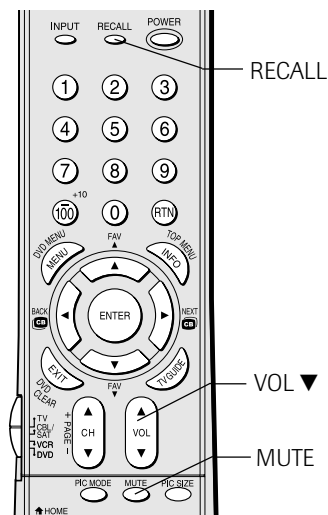

Using the digital audio selector

You can use the Digital CC/Audio selector to conveniently switch between audio tracks on a digital channel (for those channels that have multiple audio tracks). This temporarily overrides the audio track chosen by the language option under Audio Setup (see "Selecting stereo/SAP broadcasts," at right).

To use the digital audio selector:

1. Press MENU and open the Applications menu.
2. Highlight Digital CC/Audio Selector and press ENTER.
3. Press ▲▼ to select Audio, and then press ◀▶ to select the desired service.

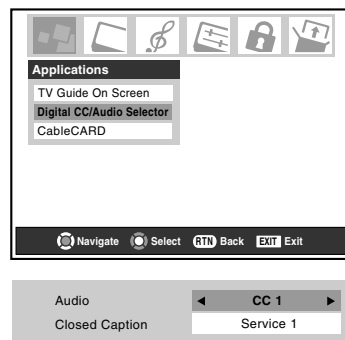

Selecting stereo/SAP broadcasts

The multi-channel TV sound (MTS) feature allows you to output high-fidelity stereo sound. MTS also can transmit a second audio program (SAP) containing a second language, music, or other audio information (when provided by individual stations).

The MTS feature is not available when the TV is in VIDEO mode. When the TV receives a stereo or SAP broadcast, the word "STEREO" or "SAP" appears on-screen when RECALL is pressed.

To listen to stereo sound:

1. Press MENU and open the Audio menu.
2. Highlight Audio Setup and press ENTER.
3. Press ▼ to highlight the MTS field, and then press ◀▶ to select Stereo.

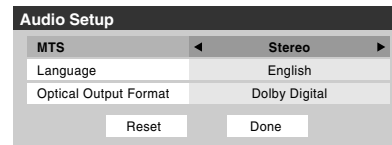
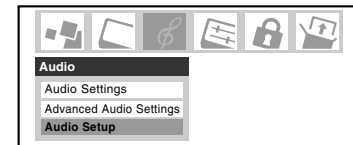

4. To save the new settings, highlight Done and press ENTER. To reset the settings to the factory defaults, highlight Reset and press ENTER.

Note:

- You can leave the TV in Stereo mode because it automatically outputs the type of sound being broadcast (stereo or monaural).
- If the stereo sound is noisy, select Mono to reduce the noise.

To listen to an alternate language on an ATSC digital station (if available):

Highlight the Language field in step 3 above, and then press ◀▶ to select the language you prefer.

To listen to a second audio program on an analog station (if available):

Select SAP in step 3 above.

Note:

- A second audio program (SAP) can be heard only on those TV stations that offer it. For example, a station might broadcast another language as a second audio program. If you have SAP on, you will see the current program on the screen but hear the other language instead of the program's normal audio.
- If you have SAP on and the station you are watching is not broadcasting a second audio program, the station's normal audio will be output. However, occasionally there is no sound at all in SAP mode. If this happens, set the MTS feature to Stereo mode.

Adjusting the audio (continued)

Adjusting the audio quality

You can adjust the audio quality by adjusting the bass, treble, and balance.

To adjust the audio quality:

1. Press MENU and open the Audio menu.
2. Highlight Audio Settings and press ENTER.

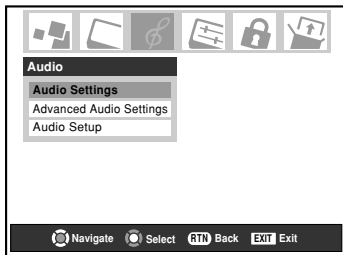

3. Press ▼ to highlight the item you want to adjust (Bass, Treble, or Balance).

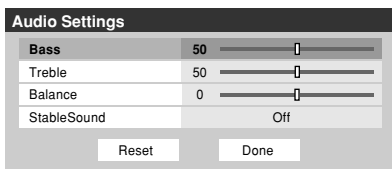

4. Press ◀▶ to adjust the level.
 - ◀ makes the bass or treble weaker or increases the balance in the left channel (depending on the item selected).
 - ▶ makes the bass or treble stronger or increases the balance in the right channel (depending on the item selected).
5. To save the new settings, highlight Done and press ENTER. To reset the settings to the factory defaults, highlight Reset and press ENTER.

Using the StableSound® feature

The StableSound® feature limits the highest volume level to prevent extreme changes in volume when the signal source changes (for example, to prevent the sudden increase in volume that often happens when a TV program switches to a commercial).

To turn on the StableSound® feature:

1. Press MENU and open the Audio menu.
2. Highlight Audio Settings and press ENTER.

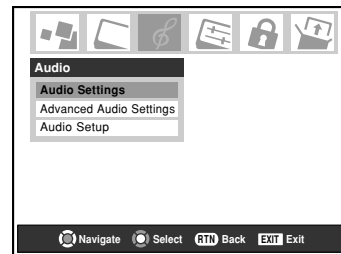

3. Press ▼ to highlight StableSound, and then press ◀▶ to select On.

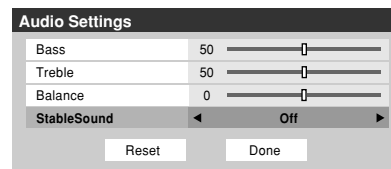

4. To save the new settings, highlight Done and press ENTER. To reset the settings to the factory defaults, highlight Reset and press ENTER.

Note: The Reset function returns your audio adjustments to the following factory settings:

Bass center (50)
 Treble center (50)
 Balance center (0)
 StableSound Off

To turn off the StableSound feature:

Select Off in step 3 above.

Adjusting the audio (continued)

Using the SRS WOW™ surround sound feature

WOW™ is a special combination of SRS Labs audio technologies (SRS 3D, FOCUS, and TruBass) that creates a thrilling surround sound experience with deep, rich bass from stereo sound sources. Your TV's audio will sound fuller, richer, and wider.

To adjust the WOW™ settings:

1. Put the TV in STEREO mode (see "Selecting stereo/SAP broadcasts" on page 70).
2. Press MENU and open the Audio menu.
3. Highlight Advanced Audio Settings and press ENTER.

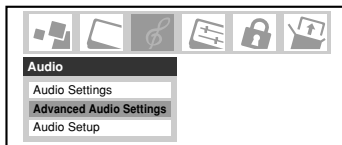

4. Press ▼▲ to highlight the WOW feature you want to adjust, and then press ◀▶ to adjust the item.

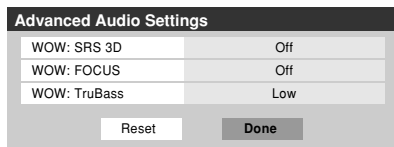

- **WOW: SRS 3D** — To turn the surround sound effect On or Off.
Note: If the broadcast is monaural, the 3D effect does not work.
- **WOW: FOCUS** — To turn the vocal emphasis effect On or Off.
- **WOW: TruBass** — To select the desired bass expansion level (High, Low, or Off).

5. To save the new settings, highlight Done and press ENTER. To revert to the factory defaults, highlight Reset and press ENTER.

Selecting the optical audio output format

Use this feature to select the optical audio output format when you connect a Dolby Digital decoder or other digital audio system to the Optical Audio Out terminal on the TV (see "Connecting a digital audio system" on page 20).

To select the optical audio output format:

1. Press MENU and open the Audio menu.
2. Highlight Audio Setup and press ENTER.

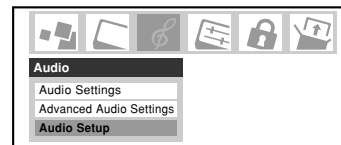

3. Press ▼ to highlight the Optical Output Format field, and then press ◀▶ to select either Dolby Digital or PCM, depending on your device.

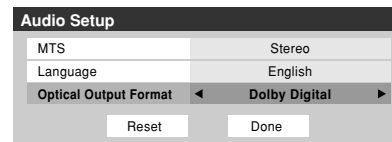

4. To save the new settings, highlight Done and press ENTER. To revert to the factory defaults, highlight Reset and press ENTER.

Setting the On/Off timer

You can use the On/Off timer to turn the TV on and off at a preset time on a recurring basis.

Note: You must first set the time (see page 39).

To set the On/Off Timer:

1. Press MENU and open the Setup menu.
2. Highlight On/Off Timer and press ENTER.

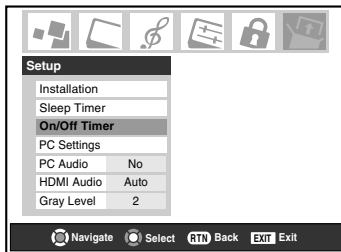

3. Press ▼ to highlight the Day field, and then press ◀▶ to select the recurrence (weekends, weekdays, every day, etc).

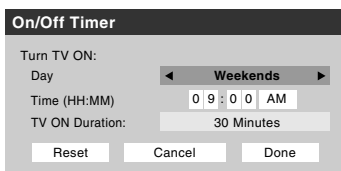

4. Press ▼ to highlight the Time field, and then use the Number buttons to enter the time you want the TV to turn on.
5. When the AM/PM field is highlighted, press ▶ to select AM or PM.
6. Press ▼ to highlight the TV ON Duration field, and then press ◀▶ to select the length of time until the TV turns off (30 Minutes, 12 Hours, 8 Hours, 4 Hours, 2 Hours, 1 Hour).
7. Highlight Done and press ENTER.
8. Turn off the TV. The TV will turn on automatically on the day(s) and at the time you set. The TV will then turn off automatically after the length of time you set in the TV ON Duration field.

Note:

- When a power failure occurs, the On/Off Timer settings may be cleared.
- To display the On/Off Timer setting, press RECALL.

To turn off the On/Off Timer:

Select Not Set in step 3 above.

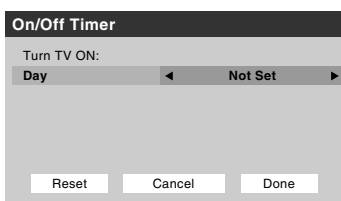

Setting the sleep timer

You can set the sleep timer to turn off the TV after a set length of time (maximum of 3 hours). The sleep timer turns off the TV one time only, as opposed to the On/Off Timer, which turns off the TV on a recurring basis.

To set the sleep timer:

Press SLEEP on the remote control to set the length of time until the TV turns off. Repeatedly press SLEEP to increase the time in 10-minute increments or press ▲ or ▼ to increase or decrease the time in 10-minute increments, to a maximum of 3 hours and 00 minutes.

0h00m → 0h10m → 0h20m - - - - → 2h50m → 3h00m → 0h00m

To cancel the sleep timer:

Press SLEEP until it is set to 0.

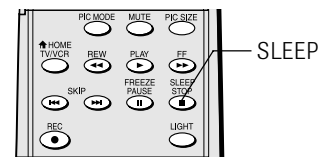

To set the sleep timer using the on-screen menus:

1. Press MENU and open the Setup menu.
2. Press ▼ to highlight Sleep Timer and press ENTER.

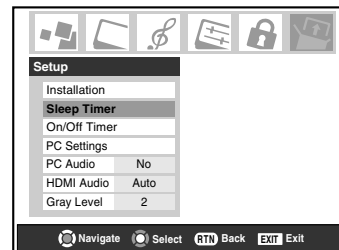

3. Press the Number buttons to enter the length of time in 10-minute increments.

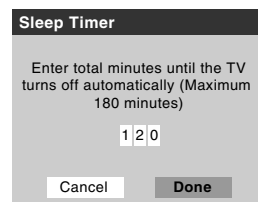

4. Highlight Done and press ENTER.

Note:

- When a power failure occurs, the sleep timer setting may be cleared.
- To display the amount of time left on the sleep timer, press RECALL.

To display the remaining minutes on the sleep timer:

Press SLEEP.

Note: A message will display on-screen when there is one minute remaining on the sleep timer.

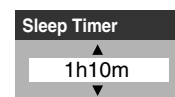

Using the PC setting feature

You can adjust the horizontal position/size, vertical position/size, clock phase, and sampling clock. This feature will be grayed out on the menu unless there is a PC connected to the TV (See "Connecting a personal computer (PC)" on page 22.)

To set the PC setting:

1. Confirm a PC is connected (see "Connecting a personal computer (PC)" on page 22).
2. Repeatedly press INPUT to select PC input mode. (See "Selecting the video input source to view" on page 56.)
3. Press MENU and open the Setup menu.
4. Highlight PC Settings and press ENTER.

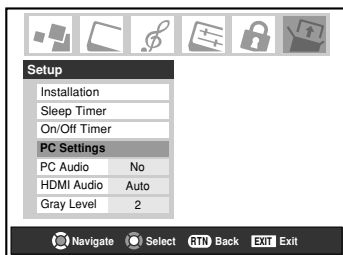

5. Press ▲▼ to select the item you want to adjust.
6. Press ◀▶ to make the appropriate adjustments.

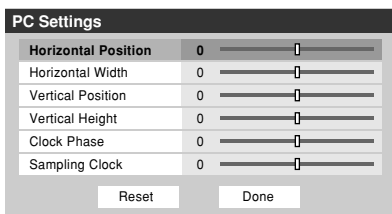

• Horizontal Position/Vertical Position:

Adjusts picture left/right and up/down. The adjustment range is within ± 5 from center.

(The adjustable range may vary depending on the input mode.)

• Horizontal Width/Vertical Height:

Adjusts picture width of Horizontal and picture height of Vertical. The adjustment range is within ± 5 from center.

• Clock Phase:

This function is to reduce noise and sharpen the picture.

The adjustment range is within ± 15 from center.

• Sampling Clock:

This function is to minimize periodic vertical stripes on the screen.

The adjustment range is within ± 15 from center.

PC Audio

This function allows you to output the sound from your PC, if connected, or mute the sound from your PC and output the sound from your HDMI connection. (See "Connecting a personal computer(PC)" on page 22.)

To set the PC Audio:

1. Press MENU and open the Setup menu.
2. Highlight PC Audio.
3. Press ▶ and then press ▼ to select No or Yes.

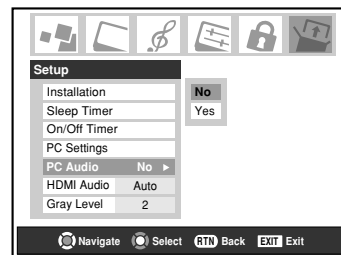

Yes: Outputs the sound from your PC

No: Mutes the sound from your PC, and outputs the sound from the HDMI connection

Note:

The PC Audio switch setting influences the HDMI Audio setting. If it is set to No, the HDMI Audio setting changes to Auto.

Displaying TV setting information on-screen using RECALL

To display TV setting information on-screen:

Press RECALL on the remote control.

The following information will display on-screen (if applicable):

- Current input (ANT 1, ANT 2, VIDEO 1, etc.)
- If ANT 1 or ANT 2 is the current input, whether it is Cable TV ("CABLE") or off-air ("TV")
- Channel number (if in ANT 1 or ANT 2 mode)
- Signal strength indicator (bar graph in lower right corner of screen; for ATSC signal only)
- Time (if set)
- On/Off timer settings (if set)
- Remaining time on sleep timer (if set)
- Remaining time on game timer (if set)
- Stereo or SAP audio status
- V-Chip rating status
- Picture size
- Tuner hold* (if applicable)

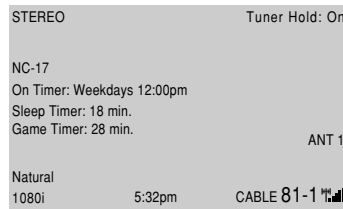

Sample RECALL screen

Note: The signal strength indicator will react to fading and increasing signals.

- *If you are recording on one tuner (for example, the digital tuner), you will be able to change channels on the other tuner only (the analog tuner in this example). The tuner from which you are recording is "on hold" (i.e., locked) so your recordings will not be affected by channel changes.

- Video resolution

To close TV setting information on-screen:

Press RECALL again.

Understanding the auto power off feature

The TV will automatically turn itself off after approximately 15 minutes if it is tuned to a vacant channel or a station that completes its broadcast for the day. This feature functions in ANT 1 and ANT 2 modes only.

Understanding the last mode memory feature

If the power is cut off while you are viewing the TV, the Last Mode Memory feature automatically turns on the TV when the power is resupplied.

Note: You should unplug the TV's power cord if it is possible that you will be away from the TV for an extended period of time after the power is restored.

Using the Gray Level feature

The gray level feature will set the sidebars to three different levels of darkness. Sidebars are the blank spaces on either side of a 4:3 viewing area.

To set the gray level of the sidebars:

1. Press MENU and open the Setup menu.
2. Highlight Gray Level and press ►.
3. Press ▲ or ▼ to select your desired level of darkness (1 – Black, 2 – Dark Gray or 3 – Gray).

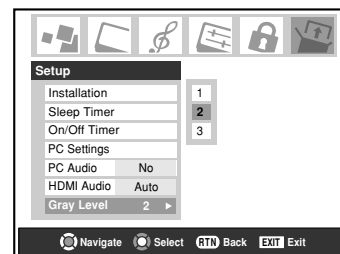

Note:

- The gray level feature does not affect video being viewed in 16:9 aspect ratio.
- When receiving a signal that has sidebars (e.g., 4:3 aspect ratio video over a 1080i or 720p signal), the gray level feature will not be applied to the sidebars.

9 Using the Locks menu

The Locks menu includes the Enable Rating Blocking, Edit Rating Limits, Channels Block, Input Lock, Front Panel Lock, Game Timer, and New PIN Code features. You can use these features after entering the correct PIN code.

Entering the PIN code

1. Press MENU and highlight the Locks menu icon.

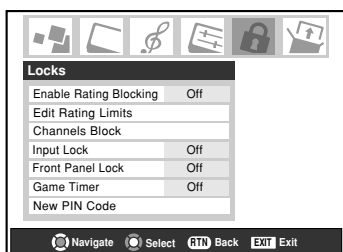

2. Press ▼, which displays the PIN code entry screen.
 - The Lock System screen (below) appears if a PIN code has not been stored. Press the Channel Number buttons to enter a new four-digit code, enter the code a second time to confirm, and press ENTER.

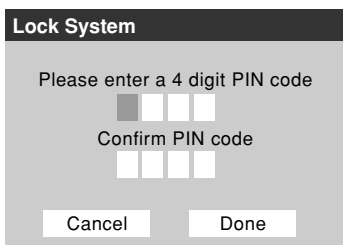

- The Locks Active screen (below) appears if the PIN code is already stored. Press the Channel Number buttons to enter your four-digit code and press ENTER.

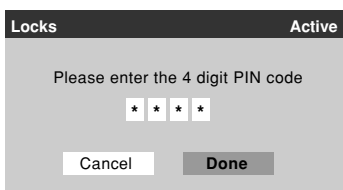

If the wrong PIN code is entered, the message “Incorrect PIN Code, please try again!” appears. Highlight Retry and press ENTER. Enter the code again and press ENTER.

When the correct PIN code is entered, the Locks menu opens.

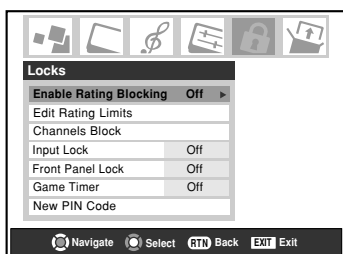

If you cannot remember your PIN code

While the PIN code entering screen is displayed, press RECALL four times within five seconds. The PIN code will be reset and you can enter a new PIN code.

Changing your PIN code

1. Press MENU and highlight the Locks menu icon.
2. Press ▼ to display the PIN code entering screen.
3. Enter your four-digit PIN code and press ENTER.
4. Press ▼ to highlight New PIN Code and press ENTER.

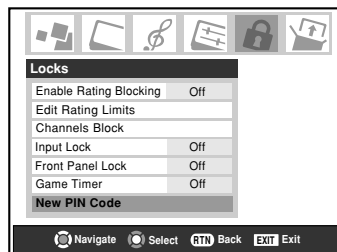

5. Press the Number buttons to enter a new four-digit code. Retype the numbers to confirm the PIN code you entered.
6. Press ENTER. The new PIN code is now active.

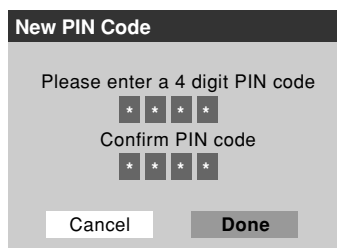

Blocking TV programs and movies by rating (V-Chip)

Some TV programs and movies include signals that classify the content of the program (violence, sex, dialog, language). The V-Chip feature in this TV detects the signals and blocks the programs according to the ratings you select. (See the tables at right for rating descriptions.)

Note: Rating blocking is a function of the V-Chip feature in this TV, which supports the U.S. V-Chip system only.

To block and unblock TV programs and movies:

1. Press MENU and highlight the Locks menu icon.
2. Press ▼, which displays the PIN code entering screen.
3. Enter your four-digit PIN code and press ENTER.
4. Press ▼ to highlight Enable Rating Blocking.
5. Press ► and then press ▼ to select On, and then press ENTER.

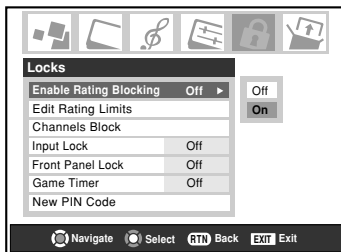

6. Press ▼ to highlight Edit Rating Limits and press ENTER.

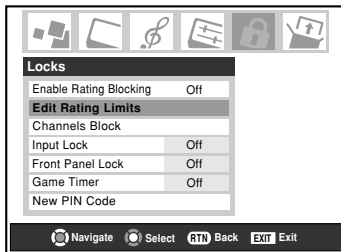

The Edit Rating Limits screen (below) appears.

7. Press ▲▼◀▶ and then press ENTER to select the level of blocking you prefer. A box with an "X" is a rating that will be blocked. As you highlight a rating, a definition for the rating appears at the bottom of the screen. See notes at right.
8. When done selecting the ratings you want to block, highlight Done and press ENTER.

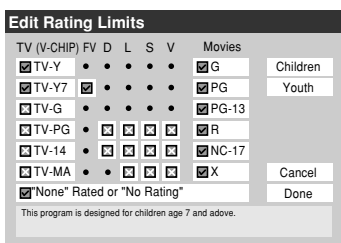

Independent rating system for broadcasters	
Ratings	Description and content themes
TV-MA	Mature Audience Only (This program is specifically designed to be viewed by adults and therefore may be unsuitable for children under 17.) L) Crude or indecent language S) Explicit sexual activity V) Graphic violence
TV-14	Parents Strongly Cautioned (This program contains some material that many parents would find unsuitable for children under 14 years of age.) D) Intensely suggestive dialog L) Strong, coarse language S) Intense sexual situations V) Intense violence
TV-PG	Parental Guidance Suggested (This program contains material parents may find unsuitable for younger children.) D) Some suggestive dialog L) Infrequent coarse language S) Some sexual situations V) Moderate violence
TV-G	General Audience (Most parents would find this program suitable for all ages.)
TV-Y7 TV-Y7FV	Directed to Older Children (This program is designed for children age 7 and above. Note: Programs in which fantasy violence may be more intense or more combative than other programs in this category are designated Y7FV.)
TV-Y	All Children (This program is designed to be appropriate for all children.)

Independent rating system for movies	
Rating	Description and content themes
X	X-rated (For adults only)
NC-17	Not intended for anyone 17 and under
R	Restricted (Under 17 requires accompanying parent or adult)
PG-13	Parents Strongly Cautioned (Some material may be inappropriate for children under 13)
PG	Parental Guidance Suggested (Some material may not be suitable for children)
G	General Audience (Appropriate for all ages)

Note:

- If you place an "X" in the box next to "None Rated or No Rating," programs rated "None" or "No Rating" will be blocked. However, if the program has no rating information provided, nothing will be displayed in the banner and ratings blocking will not be in effect.
- To display the rating of the program you are watching, press RECALL on the remote control. If it is not rated, the word "NONE" appears.

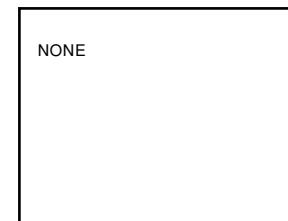
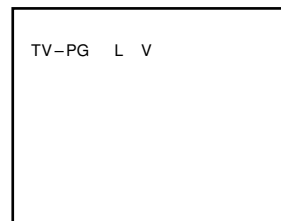

Blocking channels

With the Channels Block feature, you can block specific channels. You will not be able to tune blocked channels unless you clear the setting first.

To block channels:

1. Press MENU and highlight the Locks menu icon.
Note: To exit the Locks menu, press MENU.
2. Press ▼, which displays the PIN code entering screen.
3. Enter your four-digit PIN code and press ENTER (see page 76 for details).
4. Press ▼ to highlight Channels Block and then press ENTER.
5. Using the ▲▼◀▶ buttons, select the input that you want to change the rating limits for (ANT1, ANT2, or Cable Box if connected) and press ENTER.

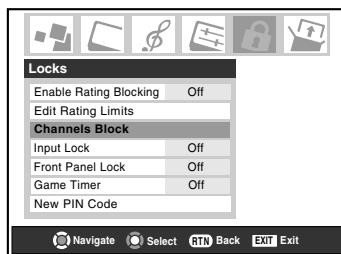

A list of the channels available for that input will be displayed along with the call letters for each channel, if available.

6. Press ▲▼ to highlight the channel you want to block, then press ENTER, which puts an "X" in the box next to that channel.
7. Repeat step 6 for other channels you want to block.
8. Highlight Done and press ENTER.

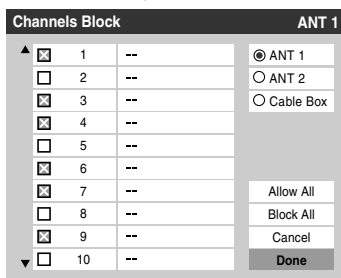

To unblock individual channels:

In step 6 above, press ▲▼ to highlight the channel you want to unblock, and then press ENTER to remove the "X" from the box, and highlight Done, and then press ENTER.

To block all channels at once:

Highlight Block All in step 6 above, and then highlight Done, and then press ENTER.

To unblock all locked channels at once:

Highlight Allow All in step 6 above, and then highlight Done, and then press ENTER.

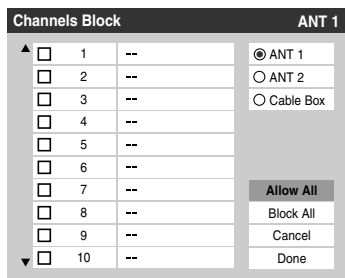

Note: Channel blocking may not take effect if you have a cable box connected and use the cable box controls to change channels.

Unlocking programs temporarily

If you try to watch a TV program that exceeds the rating limits you set, the TV enters program lock mode. You can either unlock the program temporarily or select a non-locked program to watch.

This program exceeds the rating limit you set.
Push 'mute' to enter PIN.

To temporarily unlock the program:

1. Press MUTE.
2. Enter your four-digit PIN code and press ENTER. If the correct code is entered, the program lock mode is released and the normal picture appears. All locking is disabled until the TV is turned off, and will be enabled when the TV is turned on again.

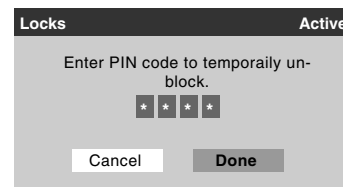

Locking video inputs

You can use the Input Lock feature to lock the video input sources (VIDEO 1, VIDEO 2, ColorStream HD, HDMI, PC) and channels 3 and 4. You will not be able to view the input sources or channels until you turn off the input lock.

To lock the video inputs:

1. Press MENU and highlight the Locks menu icon.
2. Press ▼ to display the PIN code entering screen.
3. Enter your four-digit PIN code and press ENTER.
4. Press ▼ to highlight Input Lock and press ▶.
5. Press ▲▼ to select the level of video input locking you prefer, as described below:

Video: Locks VIDEO 1, VIDEO 2, ColorStream HD, HDMI, and PC.

Video+: Locks VIDEO 1, VIDEO 2, ColorStream HD, HDMI, PC, and channels 3 and 4. Select Video+ if you use the antenna terminal to play a video tape.

Off: Unlocks all video input sources.

6. Press ENTER.

Note: When a CableCARD™ is inserted, Video+ will behave the same as Video lock.

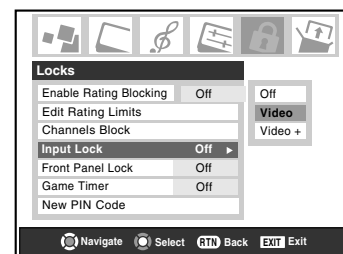

Using the GameTimer™

You can use the GameTimer to set a time limit for playing a video game (30–120 minutes). When the GameTimer is activated, the TV enters Video Lock mode and locks out the input source for the video game device.

To set the GameTimer™:

1. Press MENU and highlight the Locks menu icon.
2. Press ▼ to display the PIN code entering screen.
3. Enter your four-digit PIN code and press ENTER.
4. Press ▼ to highlight Game Timer and press ►.
5. Press ▲▼ to select the length of time until the Video Lock is activated (30, 60, 90, or 120 minutes) and press ENTER.

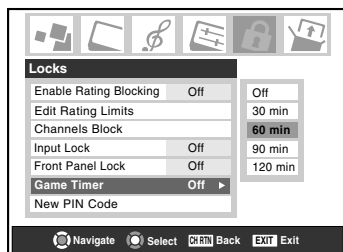

To cancel the GameTimer™:

Select Off in step 5 above.

To deactivate the video lock once the GameTimer has activated it:

Set the Video Lock to Off (see “Locking video inputs” on page 78).

Note:

- A message will appear on-screen when 10 minutes, 3 minutes, and 1 minute remain on the GameTimer.
- If the TV loses power with time remaining on the GameTimer, when power is restored the TV will enter VIDEO LOCK mode (as if the GameTimer has expired) and you will have to deactivate the video lock (as described above).

Using the panel lock feature

You can lock the top panel buttons to prevent your settings from being changed accidentally (by children, for example). When the top panel lock is On, none of the controls on the TV top panel will operate except POWER.

To lock the top panel:

1. Press MENU and highlight the Locks menu icon.
2. Press ▼ to display the PIN code entering screen.
3. Enter your four-digit PIN code and press ENTER.
4. Press ▼ to highlight Front Panel Lock.
5. Press ► to highlight On and press ENTER. When the top panel is locked and a button on the top panel except POWER button is pressed, the message “Not Available” appears.

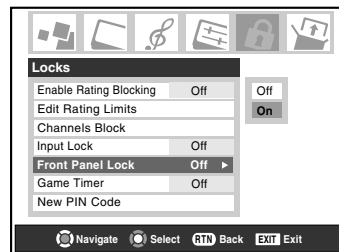

To unlock the top panel:

Highlight Off in step 5 above, or press and hold VOLUME ◀ on the TV top panel for about 10 seconds until the volume icon appears on-screen.

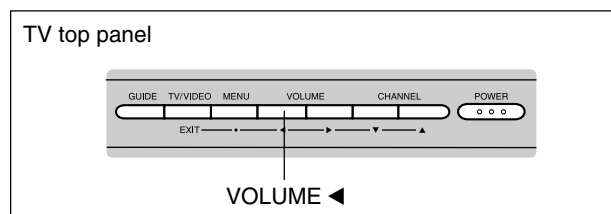

10 Troubleshooting

General troubleshooting

Before calling a service technician, please check the following table for a possible cause of the symptom some solutions.

Symptom	Solution
TV will not turn on	<ul style="list-style-type: none">• Make sure the power cord is plugged in, and then press POWER.• The remote control batteries may be dead. Replace the batteries or try the top panel buttons.
Picture problems	<ul style="list-style-type: none">• Check the antenna/cable connections (Chapter 2).• Press INPUT on the remote control or TV/VIDEO on the TV top panel and select a valid video input source (page 56). If no device is connected to any of the inputs on the TV, no picture will display when you select that particular input source. For device connection details, see Chapter 2.• Antenna reception may be poor. Use a highly directional outdoor antenna (if applicable).• The station may have broadcast difficulties. Try another channel.• Adjust the picture qualities (page 65).• If you are using a VCR, make sure the TV/VCR button on the remote control is set correctly (page 26).• If you have two VCRs connected to your TV, do not connect the same VCR to the TV's output and input connections at the same time (page 18).• Do not connect a standard video cable and an S-video cable to VIDEO-1 on the TV back at the same time (Chapter 2).
Noisy picture	<ul style="list-style-type: none">• If you are watching a tuned analog channel (off-air broadcast or Cable TV), set the CableClear® DNR feature to Auto to reduce visible interference in the TV picture (page 66).
Video Input Selection problems	<ul style="list-style-type: none">• If the Input Selection window does not appear when you press INPUT on the remote control or TV/VIDEO on the TV top panel, press INPUT or TV/VIDEO a second time, which will change to the next video input source and display the Input Selection window.
Cannot view external signals or channel 3 or 4	<ul style="list-style-type: none">• If you cannot view signals from external devices connected to VIDEO 1, VIDEO 2, or ColorStream®, or from channels 3 or 4, make sure the Input Lock is set to Off (page 78).
Black box on screen	<ul style="list-style-type: none">• Set the Closed Caption feature to Off (page 68).
Poor color or no color	<ul style="list-style-type: none">• The station may have broadcast difficulties. Try another channel.• Adjust the Tint and/or Color (page 65).• When the ColorStream® signal source is active, the VIDEO OUT terminal outputs blank video. To receive video from the VIDEO OUT signal, a standard video or S-video IN terminal must be used instead of the ColorStream® connections.
Picture and sound are out of sync	<ul style="list-style-type: none">• As with all products that contain a digital display, in rare instances, when viewing certain content (e.g., television broadcasts, video games, DVD), you may notice that the sound and picture are slightly out of sync. This phenomenon can be caused by various factors including, without limitation, video processing within the TV, video processing in an attached gaming system, and video processing/different compression rates used by broadcasters in their programming. You may want to try one or more of the following suggestions, which may help to reduce the effect of this phenomenon:<ul style="list-style-type: none">- If the TV is connected to an A/V receiver that has a programmable audio delay feature, use this feature to help synchronize the sound to the picture.- If you notice this phenomenon only on certain TV channels, please contact your local broadcast, cable, or satellite provider to inform them of this issue.

General troubleshooting (continued)

Symptom	Solution
Sound problems	<ul style="list-style-type: none"> • Check the antenna/cable connections (see Chapter 2). • The station may have broadcast difficulties. Try another channel. • The sound may be muted. Press VOLUME. • If you hear no sound, try setting the MTS feature to Stereo mode (page 70). • If you are not receiving a second audio program from a known SAP source, make sure the MTS feature is set to SAP mode (page 70). • If you hear audio that seems “incorrect” for the program you are watching (such as music or a foreign language), the SAP mode may be on. Set the MTS feature to Stereo mode (page 70).
Remote control problems	<ul style="list-style-type: none"> • Make sure the remote control is set to the correct device mode (page 26). • Remove all obstructions between the remote control and the TV. • The remote control batteries may be dead. Replace the batteries (page 23). • Your TV remote control may not operate certain features on your external device. Refer to the owner’s manual for your other device to determine its available features. If your TV remote control does not operate a specific feature on another device, use the remote control that came with the device (page 26). • If the TV still does not act as expected, use the Restore Factory Defaults procedure as described on page 41.
Channel tuning problems	<ul style="list-style-type: none"> • Make sure the remote control is set to the correct device mode (page 26). • The channel may have been erased from the channel memory by the Channel Add/Delete feature. Add the channel to the channel memory (page 37). • The channel may be blocked by the Channels Block feature. Unblock the channel (page 78). • If you are unable to tune digital channels, check the antenna configuration (page 35). If you are still unable to tune digital channels, clear all channels from the channel list (page 37) and reprogram channels into the channel memory (page 36). If you are still unable to tune digital channels, use the Restore Factory Defaults procedure as described on page 41.
Closed caption problems	<ul style="list-style-type: none"> • If the program or video you selected is not closed-captioned, no captions will display on-screen (page 68). • If text is not available, a black rectangle may appear on-screen. If this happens, turn off the closed caption feature (page 68). • A closed caption signal may not display correctly in the following situations: a) when a videotape has been dubbed; b) when the signal reception is weak; or c) when the signal reception is nonstandard (page 68).
Rating Blocking (V-Chip) problems	<ul style="list-style-type: none"> • If you forget your PIN code: While the PIN code entering screen is displayed, press RECALL four times within 5 seconds. The PIN code you previously stored will be cleared (page 76). • The V-Chip feature is available for the U.S. V-Chip system only (page 77).
Recording problems	<ul style="list-style-type: none"> • If you use the TV’s remote control to start recording, you will not be able to change inputs (page 56). If you attempt to do so, the message “Not Available While Recording” will appear on-screen. • If you are recording a digital channel, you will only be able to change analog channels while the recording is in progress. If you are recording an analog channel, you will only be able to change digital channels while the recording is in progress. This is because the TV tuner that is being recorded (digital or analog) will be locked on the channel that is currently recording. • It is recommended that you use the TV’s remote control to start recording. If you use a device other than the TV’s remote control to start recording and then attempt to access a feature that is normally denied during recording (changing inputs), the recorded audio and/or video may not be what you intended to record. See pages 56 and 60.
TV stops responding to controls	<ul style="list-style-type: none"> • If the TV stops responding to the controls on the remote control or TV top panel and you cannot turn off the TV, press and hold the POWER button on the TV top panel for 5 or more seconds to reset the TV.
Other problems	<ul style="list-style-type: none"> • If your TV’s problem has not been addressed in this Troubleshooting section or the recommended solution has not worked, use the Restore Factory Defaults procedure as described on page 41.

TV Guide On Screen® FAQs

The following are frequently asked questions about the TV Guide On Screen® system. The answers represent the most likely solutions to the problem.

After you set up the TV Guide On Screen® system (Chapter 5), the program guide opens automatically by default when you turn on the TV. You can turn off the automatic program guide (see page 34) and instead press the TV GUIDE button on the remote control to manually open the TV Guide On Screen® program guide.

SETUP

1. Q: What if I move and my ZIP code or postal code changes?

A: Highlight SETUP in the Service Bar. Press ▼ to highlight Change System Settings (page 53), and then press ENTER. Follow the on-screen prompts to enter new information (see Chapter 5 for details). It can take up to 24 hours to receive new data.

2. Q: What if I change my cable hook-up to antenna or vice versa?

A: Highlight SETUP in the Service Bar. Press ▼ to highlight Change System Settings (page 53), and then press ENTER. Follow the on-screen prompts to enter new input information and rescan channels for the new input (see Chapter 5 for details).

3. Q: What if I change cable boxes?

A: Highlight SETUP in the Service Bar. Press ▼ to highlight Change System Settings (page 53), and then press ENTER. Follow the on-screen prompts to enter new input information and rescan channels for the new input (see Chapter 5 for details).

4. Q: I used to have a cable box, but now I get direct cable. What do I do?

A: Highlight SETUP in the Service Bar. Press ▼ to highlight Change System Settings (page 53), and then press ENTER. Follow the on-screen prompts to enter new input information and rescan channels for the new input (see Chapter 5 for details).

5. Q: If I add a recorder or change my cable service, how do I change my Setup information?

A: Highlight SETUP in the Service Bar. Press ▼ to highlight Change System Settings (page 53), and then press ENTER. Follow the on-screen prompts to enter new information (see Chapter 5 for details). It can take up to 24 hours to receive new data.

6. Q: Why does it take up to 24 hours for the TV Guide On Screen® system to be ready for use?

A: The initial setup process consists of finding the stations in your area that carry the TV Guide On Screen® system data and tuning to those stations to receive the setup and listings data.

7. Q: I had a power outage. Do I need to go through initial setup of the TV Guide On Screen® system again?

A: No. The information you entered is stored in the TV Guide On Screen® system memory.

Note: For Cable box users, the TV must be OFF and the Cable box must be left ON for the TV Guide On Screen® system to receive channel line-up information.

8. Q: How do I connect the G-LINK® (IR blaster) cable to the G-LINK® input on the TV?

A: See “Chapter 2: Connecting your TV” in this manual. You also can refer to the TV Guide On Screen® prompts during VCR or Cable box setup.

9. Q: When will I be able to view my TV program listings and use other TV Guide On Screen® system features?

A: You will be able to use initial program listings within 24 hours of initial setup. It may take up to one week to receive the full eight days of program listings.

10. Q: What should I do if I cannot complete initial setup?

A: If you are unable to complete initial setup using the owner’s manual and the on-screen prompts, please call Toshiba’s National Service Division at 1-800-631-3811.

11. Q: If I make a mistake during setup, how do I go back to the previous step?

A: Complete the remaining setup steps. When “Confirming Your Settings” appears, select “No, repeat setup process.” Follow the on-screen prompts and input the correct information.

12. Q: What if the channel number is not visible on my cable box?

A: Your cable box may be defaulting to a clock or time display once the channel changes. Watch the box carefully when testing the cable box brand code to see if the channel changes to 09.

13. Q: Why won’t my VCR turn on?

A: There are several possibilities:

- a) An incorrect or “no VCR” code was entered during the TV Guide On Screen® initial setup. Press TV GUIDE on the remote control, and then press ► to highlight SETUP. Press ▼ to highlight “Change system settings,” and then press ENTER. Follow the on-screen prompts to select the correct VCR information.
- b) Make sure the G-LINK® (IR blaster) cable is connected correctly (see page 21).
- c) The VCR record timer is on. Turn off the timer.
- d) The wired remote VCR is incompatible.

TV Guide On Screen® FAQs (continued)

CHANNEL LINEUPS & LISTINGS

14. Q: **Why aren't all my channels initially displayed?**
 A: After initial setup, approximately 120 channels are automatically displayed. The user may use the "Change channel display" feature to turn On or Off additional channels.
Note: Even though you have the option of enabling many more channels, the system may not have the memory capacity to hold detailed program descriptions for all of them.
15. Q: **When I opened the TV Guide On Screen® system, I was asked to choose from more than one channel lineup. What should I do?**
 A: Select the lineup that most closely matches the one for your area. If after you choose the lineup, you want to make changes to it, highlight SETUP in the Service Bar. Press ▼ to select Change Channel Display. Follow the on-screen instructions.
16. Q: **Why do all my channels display "No Listing?"**
 A: The TV Guide On Screen® system has not yet received its data download. The phrase "No Listing" will be replaced with program information during the next download cycle, which will occur within the next 24-hour period.
17. Q: **Why do some of my channels display "No Listing?"**
 A: There are several possibilities:
 a) The channels in question were recently turned On (in Change channel display) and TV Guide On Screen® has yet to receive its next data download.
 b) After completing the initial setup, the first data download of the day was interrupted by a VCR recording.
 c) The TV power cord was left unplugged for an extended period of time and the TV Guide On Screen® system was unable to receive program listings during the scheduled download cycle.
 d) Poor reception caused some of the data to be missed.
 e) The cable box was turned Off. The TV power cord must be plugged in and the cable box must be On.
 g) A/V Cable: The VCR was turned OFF. If the connection includes stereo cables with cable box to VCR and stereo connection from VCR to television, the VCR must be ON.
18. Q: **A show entry in the TV Guide On Screen® system reads "No Listing." What does that mean?**
 A: Show information for that entry was not available during the last TV Guide On Screen® system information update (download). Show information is updated on a daily basis.
19. Q: **I have seen the word "download" in reference to the TV Guide On Screen® system. What does that mean?**
 A: "Download" refers to the times throughout the day when the TV Guide On Screen® system is *receiving* channel and listings information from your Cable or over-the-air antenna transmission.
20. Q: **After some show titles, I have noticed from 1 to 4 stars (****). What does that mean?**
 A: These stars are a broadcast-industry ratings system used to inform you of a show's quality. The more stars, the better the rating.
21. Q: **What do the colors for shows in the Listings and Search screens indicate?**
 A: Green = Sports; Dark Blue = Children's; Purple = Movies; Teal = Other Show.
22. Q: **How do I add, delete, or change the assigned number of channels on the TV Guide On Screen® system?**
 A: See the "Change channel display" section in the TV Guide On Screen® owner's manual (see page 54).
23. Q: **Why are some of my channels listed on the wrong number?**
 A: There are several possibilities (see page 53 for details):
 a) Incorrect channel lineup was selected. Access "Change system settings" and choose "Yes, but my channel lineup is incorrect," and then reselect the correct lineup.
 b) Channel lineup changes have not yet been processed. Use the "Change channel display" feature to make adjustments.
 c) Initial setup was done incorrectly (that is, the wrong ZIP/postal code was entered). Redo the initial setup.
24. Q: **Why doesn't the program highlighted match up with the video window on my TV screen?**
 A: There are several possibilities (see page 53 for details):
 a) The station in question made a late change to its scheduled program listing and the TV Guide On Screen® system has not yet been updated.
 b) The TV is receiving broadcasts through a modified or boosted antenna system or a satellite dish (not supported by the TV Guide On Screen® system).
 c) Initial setup was done incorrectly. (i.e., the wrong ZIP/postal code was entered.) Redo the initial setup.
 d) Incorrect channel lineup was selected. Access "Change system settings" and choose "Yes, but my channel lineup is incorrect," and then reselect the correct lineup (see page 54 for details).
25. Q: **Can I move my favorite stations to the top of the TV Guide On Screen® display screen?**
 A: Yes. Use the "Change channel display" feature to make adjustments (see page 54). Highlight the station call letters to be moved, then use up/down arrows, and/or Number buttons to reassign the position of the station.

TV Guide On Screen® FAQs (continued)

OPERATIONS

26. Q: **How can I look for a specific show in the TV Guide On Screen® system?**
 A: SEARCH lets you find shows by keyword, alphabetically, or by category (HDTV, Movies, Sports, Children, Educational, News, Variety, Series).
27. Q: **My cable box will not change channels with the TV Guide On Screen® system. What's wrong?**
 A: There are several possibilities:
 a) The incorrect cable box code was entered during TV Guide On Screen® initial setup. Redo initial setup.
 b) The G-LINK® (IR blaster) cable may not be connected properly (see page 21).
 c) The cable box has no remote capability and is incompatible.
28. Q: **How do I resize or close the Info window?**
 A: Press INFO on the remote control to resize the Info window. Press INFO again to close the Info window.
29. Q: **Is there a way to go directly to the next day's listings without scrolling through each time slot?**
 A: Yes. In LISTINGS, highlight the station you want to look ahead and use the Channel Number buttons on the remote control to enter "24". In the resulting menu, press ▼ two times to scroll down to select the HOURS AHEAD option, and then press ENTER. You also can use the SKIP button on the remote control.
30. Q: **Why can't I record a show? All I get is snow or a blue screen.**
 A: There are several possibilities (without a cable box):
 a) The recording unit was not connected or set up correctly.
 b) The incorrect channel lineup was selected. Press TV GUIDE and then ► to highlight SETUP. Press ▼ to highlight "Change system settings," and then press ENTER. Follow the on-screen prompts to select the correct channel lineup.
31. Q: **Why won't my VCR change channels and why does it change to the wrong channel?**
 A: There are two possibilities (with a cable box):
 a) The VCR is not set on the correct output channel. Set the VCR to 03, 04, or whichever output channel is set by your cable system.
 b) The VCR and/or cable box are hooked up incorrectly. Refer to your VCR owner's manual or contact your Cable TV company for proper wiring procedures.
32. Q: **Is Help available in the TV Guide On Screen® system? If so, how do I find it?**
 A: Yes. Highlight any of the four main Services (Listings, Schedule, Setup, Search) and press INFO on the remote control. An expanded Info Box displays additional help information. Press INFO again to close the box.
 Help is also available in a panel menu. Press INFO to display an expanded Info Box. Press INFO again to close the box.

RECORD/REMIND

33. Q: **Can I tune to a different channel while recording a program?**
 A: No.
34. Q: **How many programs can be scheduled for RECORD in the GUIDE?**
 A: There is no limit to the number of shows that can be programmed into the schedule memory.
35. Q: **If a program is scheduled to RECORD on a Regular basis, does it count as five?**
 A: No, whether a program is scheduled ONCE, REGULARLY, or WEEKLY, it only counts as one show in the RECORD stack memory.
36. Q: **If I have a power failure, will I need to reset the recorded shows I have already programmed?**
 A: The start times and channel numbers of shows that have been programmed will be retained in the memory of the TV Guide On Screen® system. Titles will appear once listings are restored.
37. Q: **Can I set a Record or Remind event without highlighting a show title in the TV Guide On Screen® system?**
 A: Yes. TV Guide On Screen® has a Manual Record and Remind feature. Highlight SCHEDULE in the Service Bar, and press MENU. Choose the event type, press ENTER, and then enter the date, start and stop time, channel number, and so forth.
38. Q: **What do the frequencies for Record and Remind mean?**
 A: Once—records/reminds the show one time.
 Daily (manual only)—records/reminds the time, channel, input, recorder combination Monday through Friday.
 Regularly— records/reminds the show every time the show airs on the same channel and starts at the same time.
 Weekly— records/reminds the show each time the show airs on the same day of the week, on the same channel and starts at the same time.
 Off (not cancel)—keeps the show in the schedule list but will not record/remind the show until the frequency is changed.

11 Appendix

Specifications

Note:

- **This model complies with the specifications listed below.**
- **Designs and specifications are subject to change without notice.**
- **This model may not be compatible with features and/or specifications that may be added in the future.**

Television System

NTSC standard
ATSC standard (8VSB)
Digital Cable (64 QAM, 256 QAM; in-the-clear, unencrypted*)

**Encrypted channels can be viewed on this TV using a CableCARD™. See page 12 for details.*

Channel Coverage

VHF: 2 through 13
UHF: 14 through 69
Cable TV: Mid band (A-8 through A-1, A through I)
Super band (J through W)
Hyper band (AA through ZZ, AAA, BBB)
Ultra band (65 through 94, 100 through 135)

Power Source

120 V AC, 60 Hz

Power Consumption

107 W (average)
31 W in standby mode (Using a CableCARD™)
27 W in standby mode (Without a CableCARD™)

Audio Power

10 W + 10 W

Speaker Type

Two 2-3/8 × 4-3/4 inches (60 × 120mm)

Video/Audio Terminals

S-VIDEO INPUT:

Y : 1 V(p-p), 75 ohm, negative sync.
C : 0.286 V(p-p) (burst signal), 75 ohm

VIDEO/AUDIO INPUT:

VIDEO: 1 V(p-p), 75 ohm, negative sync.
AUDIO: 150 mV(rms) (30% modulation equivalent, 22 k ohm or greater)

ColorStream® (component video) HD INPUT:

Y : 1V(p-p), 75 ohm
PR: 0.7 V(p-p), 75 ohm
PB: 0.7 V(p-p), 75 ohm
AUDIO: 150 mV(rms), 22 k ohm or greater
Suggested formats: 1080i, 480p, 480i, 720p

HDMI™ INPUT:

HDMI compliant (type A connector)
HDCP compliant
E-EDID** compliant
Suggested formats: 1080i, 480p, 480i, 720p
HDMI Audio: 2-channel PCM; 32/44.1/48 kHz sampling frequency; 16/20/24 bits per sample

Video/Audio Terminals (continued)

PC INPUT:

15-pin D-sub Analog RGB

VIDEO/AUDIO OUTPUT (also for recording):

VIDEO: 1 V(p-p), 75 ohm, negative sync.
AUDIO: 150 mV(rms) (30% modulation equivalent, 2.2 k ohm or less)

G-LINK® OUTPUT:

3 V(p-p), 3.5 mm mono socket (IR blaster cables supplied)

DIGITAL AUDIO OUTPUT:

Optical type

Headphone jack:

3.5 mm stereo

Dimensions

Width: 27-1/4 inches (690 mm)
Height: 22-1/2 inches (570 mm)
Depth: 10-7/8 inches (274 mm)

Weight

35.2 lbs (16.4 kg)

Supplied Accessories

- Dual-wand IR blaster cable
- Remote control with two size "AA" alkaline batteries
- Clip (see item 19 on page 3)
- Owner's Manual (this book)

WARNING: If you decide to wall mount this television, always use the Toshiba wall bracket specified below or another UL-approved wall bracket appropriate for the size and weight of this television. The use of any wall bracket other than the Toshiba wall bracket specified below or another UL-approved wall bracket appropriate for the size and weight of this television for wall mounting this television could result in serious bodily injury and/or property damage.

In the U.S.:

Use Toshiba wall bracket model number **FWB2027** or, if no longer available, another UL-approved wall bracket appropriate for the size and weight of the television. For more information, call TACP's Consumer Solutions Center at 1-800-631-3811 or visit TACP's website at www.tacp.toshiba.com.

** E-EDID = Enhanced-Extended Display Identification

Limited United States Warranty for LCD Televisions 26" and Larger

Toshiba America Consumer Products, L.L.C. ("TACP") makes the following limited warranties to original consumers in the United States.

THESE LIMITED WARRANTIES EXTEND TO THE ORIGINAL CONSUMER PURCHASER OR ANY PERSON RECEIVING THIS LCD TELEVISION AS A GIFT FROM THE ORIGINAL CONSUMER PURCHASER AND TO NO OTHER PURCHASER OR TRANSFEREE.

LCD TELEVISIONS PURCHASED IN THE U.S.A. AND USED ANYWHERE OUTSIDE OF THE U.S.A., INCLUDING, WITHOUT LIMITATION, CANADA AND MEXICO, ARE NOT COVERED BY THESE WARRANTIES.

LCD TELEVISIONS PURCHASED ANYWHERE OUTSIDE OF THE U.S.A., INCLUDING, WITHOUT LIMITATION, CANADA AND MEXICO, AND USED IN THE U.S.A., ARE NOT COVERED BY THESE WARRANTIES.

Limited One (1) Year Warranty on Parts and Labor

TACP warrants this LCD Television and its parts against defects in materials or workmanship for a period of one (1) year after the date of original retail purchase. DURING THIS PERIOD, TACP WILL, AT TACP'S OPTION, REPAIR OR REPLACE A DEFECTIVE PART WITH A NEW OR REFURBISHED PART WITHOUT CHARGE TO YOU FOR PARTS OR LABOR. During this period, TACP Authorized Service Station personnel will come to your home when warranty service is required. Depending on the type of repair required, the service will either be performed in your home or the LCD Television will be taken to a TACP Authorized Service Station for repair and returned to your home at no cost to you.

Rental Units

The warranty for LCD Television rental units begins on the date of the first rental or thirty (30) days after the date of shipment to the rental firm, whichever comes first.

Limited Warranty for Commercial Units

TACP warrants LCD Televisions that are sold and used for commercial purposes as follows: all parts are warranted against defects in materials or workmanship for a period of ninety (90) days after the date of original retail purchase. DURING THIS PERIOD, TACP WILL, AT TACP'S OPTION, REPAIR OR REPLACE A DEFECTIVE PART WITH A NEW OR REFURBISHED PART WITHOUT CHARGE TO YOU.

Owner's Manual and Product Registration Card

Read this owner's manual thoroughly before operating this LCD Television. Complete and mail the enclosed product registration card or register your LCD Television online at www.tacp.toshiba.com/service as soon as possible. By registering your LCD Television you will enable TACP to bring you new products specifically designed to meet your needs and help us to contact you in the unlikely event a safety notification is required under the U.S. Consumer Product Safety Act. **Failure to complete and return the product registration card does not diminish your warranty rights.**

Your Responsibility

THE ABOVE WARRANTIES ARE SUBJECT TO THE FOLLOWING CONDITIONS:

- (1) You must retain your original bill of sale or provide other proof of purchase.
- (2) All warranty servicing of this LCD Television must be performed by an Authorized TACP Service Station.

- (3) The warranties from TACP are effective only if this LCD Television is purchased and operated in the Continental U.S.A. or Puerto Rico.
- (4) Labor service charges for set installation, setup, adjustment of customer controls, and installation or repair of antenna systems are not covered by this warranty. Reception problems caused by inadequate antenna systems, misaligned satellite dishes, cable television distribution, VCRs, DVD players/recorders, personal computer level IEEE-1394 devices, and any other connected signal source device are your responsibility.
- (5) Warranties extend only to defects in materials or workmanship as limited above, and do not extend to any LCD Television or parts that have been lost or discarded by you or to damage to the LCD Television or parts caused by fires, misuse, accident, Acts of God (such as lightning or fluctuations in electric power), improper installation, improper maintenance, or use in violation of instructions furnished by TACP; use or malfunction through simultaneous use of this LCD Television and connected equipment; or to units that have been modified or had the serial number removed, altered, defaced, or rendered illegible.

How to Obtain Warranty Service

If, after following all of the operating instructions in this manual and reviewing the section entitled "Troubleshooting," you find that service is needed:

- (1) To find the nearest TACP Authorized Service Station, visit TACP's website at www.tacp.toshiba.com/service or contact TACP's Consumer Solution Center toll free at 1-800-575-5469.
- (2) You must present your original bill of sale or other proof of purchase to the TACP Authorized Service Station.

**For additional information, visit TACP's website:
www.tacp.toshiba.com**

ALL WARRANTIES IMPLIED BY THE LAW OF ANY STATE OF THE U.S.A., INCLUDING THE IMPLIED WARRANTIES OF MERCHANTABILITY AND FITNESS FOR A PARTICULAR PURPOSE, ARE EXPRESSLY LIMITED TO THE DURATION OF THE LIMITED WARRANTIES SET FORTH ABOVE. WITH THE EXCEPTION OF ANY WARRANTIES IMPLIED BY THE LAW OF ANY STATE OF THE U.S.A. AS HEREBY LIMITED, THE FOREGOING WARRANTY IS EXCLUSIVE AND IN LIEU OF ALL OTHER WARRANTIES, GUARANTEES, AGREEMENTS, AND SIMILAR OBLIGATIONS OF TACP WITH RESPECT TO THE REPAIR OR REPLACEMENT OF ANY PARTS. IN NO EVENT SHALL TACP BE LIABLE FOR CONSEQUENTIAL OR INCIDENTAL DAMAGES (INCLUDING, BUT NOT LIMITED TO, LOST PROFITS, BUSINESS INTERRUPTION, OR MODIFICATION OR ERASURE OF RECORDED DATA CAUSED BY USE, MISUSE OR INABILITY TO USE THIS LCD TELEVISION).

No person, agent, distributor, dealer, or company is authorized to change, modify, or extend the terms of these warranties in any manner whatsoever. The time within which an action must be commenced to enforce any obligation of TACP arising under the warranty or under any statute or law of the United States or any state thereof is hereby limited to ninety (90) days from the date you discover, or should have discovered, the defect. This limitation does not apply to implied warranties arising under the law of any state of the U.S.A.

THIS WARRANTY GIVES YOU SPECIFIC LEGAL RIGHTS AND YOU MAY ALSO HAVE OTHER RIGHTS WHICH MAY VARY FROM STATE TO STATE IN THE U.S.A. SOME STATES OF THE U.S.A. DO NOT ALLOW LIMITATIONS ON THE DURATION OF AN IMPLIED WARRANTY, WHEN AN ACTION MAY BE BROUGHT, OR THE EXCLUSION OR LIMITATION OF INCIDENTAL OR CONSEQUENTIAL DAMAGES. THEREFORE, THE ABOVE PROVISIONS MAY NOT APPLY TO YOU UNDER SUCH CIRCUMSTANCES.

[0305]

A copy of the GPL source code in this product may be obtained by contacting Toshiba Consumer Solutions at (800)631-3811. There will be a charge to cover the costs of providing the source code.

A copy of the LGPL source code in this product may be obtained by contacting Toshiba Consumer Solutions at (800)631-3811. There will be a charge to cover the costs of providing the source code.

USB Protocol Copyright © 2005 The NetBSD Foundation, Inc. All rights reserved.

Redistribution and use in source and binary forms, with or without modification, are permitted provided that the following conditions are met:

1. Redistributions of source code must retain the above copyright notice, this list of conditions and the following disclaimer.
2. Redistributions in binary form must reproduce the above copyright notice, this list of conditions and the following disclaimer in the documentation and/or other materials provided with the distribution.
3. Neither the name of The NetBSD Foundation nor the names of its contributors may be used to endorse or promote products derived from this software without specified prior written permission.

THIS SOFTWARE IS PROVIDED BY THE NETBSD FOUNDATION, INC. AND CONTRIBUTORS "AS IS" AND ANY EXPRESS OR IMPLIED WARRANTIES, INCLUDING, BUT NOT LIMITED TO, THE IMPLIED WARRANTIES OF MERCHANTABILITY AND FITNESS FOR A PARTICULAR PURPOSE ARE DISCLAIMED. IN NO EVENT SHALL THE FOUNDATION OR CONTRIBUTORS BE LIABLE FOR ANY DIRECT, INDIRECT, INCIDENTAL, SPECIAL, EXEMPLARY, OR CONSEQUENTIAL DAMAGES (INCLUDING, BUT NOT LIMITED TO, PROCUREMENT OF SUBSTITUTE GOODS OR SERVICES; LOSS OF USE, DATA, OR PROFITS; OR BUSINESS INTERRUPTION) HOWEVER CAUSED AND ON ANY THEORY OF LIABILITY, WHETHER IN CONTRACT, STRICT LIABILITY, OR TORT (INCLUDING NEGLIGENCE OR OTHERWISE) ARISING IN ANY WAY OUT OF THE USE OF THIS SOFTWARE, EVEN IF ADVISED OF THE POSSIBILITY OF SUCH DAMAGE.

This product includes software developed by the OpenSSL Project for use in the OpenSSL Toolkit (<http://www.openssl.org>).

This product includes cryptographic software written by Eric Young (eyay@cryptsoft.com).

OpenSSL 0.9.7d Copyright © 1998-2000 the OpenSSL Project. All Rights reserved. Redistribution and use in source and binary forms, with or without modification, are permitted provided that the following conditions are met:

1. Redistributions of source code must retain the above copyright notice, this list of conditions and the following disclaimer.
2. Redistributions in binary form must reproduce the above copyright notice, this list of conditions and the following disclaimer in the documentation and/or other materials provided with the distribution.
3. All advertising materials mentioning features or use of this software must display the following acknowledgement: This product includes software developed by the OpenSSL Project for use in the OpenSSL Toolkit (<http://www.openssl.org>).
4. The names "OpenSSL Toolkit" and "Open SSL Project" must not be used to endorse or promote products derived from this software without prior written permission. For written permission, please contact openssl-core@openssl.org.
5. Products derived from this software may not be called "OpenSSL" nor may "Open SSL" appear in their names without prior written permission of the OpenSSL Project.
6. Redistributions of any form whatsoever must retain the following acknowledgement: "This product includes software developed by the OpenSSL Project for use in the OpenSSL Toolkit (<http://www.openssl.org>)."

THIS SOFTWARE IS PROVIDED BY THE OpenSSL PROJECT "AS IS" AND ANY EXPRESSED OR IMPLIED WARRANTIES, INCLUDING, BUT NOT LIMITED TO, THE IMPLIED WARRANTIES OF MERCHANTABILITY AND FITNESS FOR A PARTICULAR PURPOSE ARE DISCLAIMED. IN NO EVENT SHALL THE OpenSSL PROJECT OR CONTRIBUTORS BE LIABLE FOR ANY DIRECT, INDIRECT, INCIDENTAL, SPECIAL, EXEMPLARY, OR CONSEQUENTIAL DAMAGES (INCLUDING, BUT NOT LIMITED TO, PROCUREMENT OF SUBSTITUTE GOODS OR SERVICES; LOSS OF USE, DATA, OR PROFITS; OR BUSINESS INTERRUPTION) HOWEVER CAUSED AND ON ANY THEORY OF LIABILITY, WHETHER IN CONTRACT, STRICT LIABILITY, OR TORT (INCLUDING NEGLIGENCE OR OTHERWISE) ARISING IN ANY WAY OUT OF THE USE OF THIS SOFTWARE, EVEN IF ADVISED OF THE POSSIBILITY OF SUCH DAMAGE. This product includes cryptographic software written by Eric Young (eyay@cryptsoft.com). This product includes software written by Tim Hudson (tjh@cryptsoft.com).

Copyright © 1995-1998 Eric Young (eyay@cryptsoft.com). All Rights reserved. This package is an SSL implementation written by Eric Young (eyay@cryptsoft.com). The implementation was written so as to conform with Netscapes SSL. This library is free for commercial and non-commercial use so long as the following conditions are adhered to. The following conditions apply to all code found in this distribution, be it the RC4, RSA, lhash, DES, etc., code; not just the SSL code. The SSL documentation included with this distribution is covered by the same copyright terms except that the holder is Tim Hudson (tjh@cryptsoft.com).

Copyright remains Eric Young's, and as such any Copyright notices in the code are not to be removed. If this package is used in a product, Eric Young should be given attribution as the author of the parts of the library used. This can be in the form of a textual message at program startup or in documentation (online or textual) provided with the package.

Redistribution and use in source and binary forms, with or without modification, are permitted provided that the following conditions are met:

1. Redistributions of source code must retain the copyright notice, this list of conditions and the following disclaimer.
2. Redistributions in binary form must reproduce the above copyright notice, this list of conditions and the following disclaimer in the documentation and/or other materials provided with the distribution.
3. All advertising materials mentioning features or use of this software must display the following acknowledgement: "This product includes cryptographic software written by Eric Young (eyay@cryptsoft.com)." The word 'cryptographic' can be left out if the routines from the library being used are not cryptographic related.
4. If you include any Windows specific code (or derivative thereof) from the apps directory (application code) you must include an acknowledgement: "This product includes software written by Tim Hudson (tjh@cryptsoft.com)."

THIS SOFTWARE IS PROVIDED BY ERIC YOUNG "AS IS" AND ANY EXPRESS OR IMPLIED WARRANTIES, INCLUDING, BUT NOT LIMITED TO, THE IMPLIED WARRANTIES OF MERCHANTABILITY AND FITNESS FOR A PARTICULAR PURPOSE ARE DISCLAIMED. IN NO EVENT SHALL THE AUTHOR OR CONTRIBUTORS BE LIABLE FOR ANY DIRECT, INDIRECT, INCIDENTAL, SPECIAL, EXEMPLARY, OR CONSEQUENTIAL DAMAGES (INCLUDING, BUT NOT LIMITED TO, PROCUREMENT OF SUBSTITUTE GOODS OR SERVICES; LOSS OF USE, DATA, OR PROFITS; OR BUSINESS INTERRUPTION) HOWEVER CAUSED AND ON ANY THEORY OF LIABILITY, WHETHER IN CONTRACT, STRICT LIABILITY, OR TORT (INCLUDING NEGLIGENCE OR OTHERWISE) ARISING IN ANY WAY OUT OF THE USE OF THIS SOFTWARE, EVEN IF ADVISED OF THE POSSIBILITY OF SUCH DAMAGE. The license and distribution terms for any publicly available version or derivative of this code cannot be changed, i.e. this code cannot simply be copied and put under another distribution license (including the GNU Public License).

Chapter 11: Appendix

Notes

Notes

Index

A

Antenna cables	11
Audio system connection	20
Auto aspect	63
Auto power off	75

B

Back of the TV	10
Back lighting feature	67
Blocking channels	78

C

Cable box connection	14, 16
CableCARD™	12
CableClear® DNR	66
Cables	11
Camcorder connection	13
CH ▲▼ buttons	60
Channel Browser	58
Channel Number buttons	60
Channel programming:	
Automatic programming	36
Manually adding and deleting	37
Cinema mode	64
Closed captions	68
Color temperature	66
ColorStream®	10, 15, 17
Connecting devices	12–22
Component video cables	11
Component video (ColorStream®)	15, 17

D

Device connections	12–22
Defaults, restore TV factory	41
Digital Audio Out	20
Digital signal meter	40
DNR (Digital Noise Reduction)	66
Dolby Digital	20, 72
DVD player connection	16, 17
DVI connection	19
Dynamic Contrast	67

F G H I

Factory defaults, restore TV	41
Favorite channels	38
Features, TV	7
Focus	72
FREEZE	64
Front of the TV	9
GameTimer™	79
G-LINK® connection	21
HDMI connection	19
HOME button	59
INPUT button	56
Input lock	78
Installation, care, and service	3–4, 8
Installation, setup	8
Integrated digital tuning	7
IR blaster	21

L

Labeling video inputs	57
Language selection	35
Last mode memory feature	75
Locking video inputs	78
LOCKS menu	76
Channels, blocking	78
Enable rating blocking	77
GameTimer	79
New PIN code	76
Unlocking programs temporarily	78
Video inputs, locking	78

Index (continued)

M

Menu system	29, 30
MPEG Noise Reduction	67
MTS feature	70
MUTE button	70

O P

On/Off timer	73
Optical audio cable	11
Panel lock	79
PC Connection	22
PC setting	74
Picture adjustments:	
Color temperature	66
Picture mode	65
Picture quality	65
Picture scroll	63
Picture size selection	61
POWER button	28
Problems with TV	80-84

R

RECALL button	70
Remote control:	
Battery installation	23
Device code table	24, 25
Effective range	23
Functional key chart	27
Learning about the buttons	28
Programming	24
Searching and sampling the code	24
Restore TV factory defaults	41
RTN button	60

S

Safety, care, installation, and service	2-4
SAP sound	70
Satellite receiver connection	15
Scrolling the TheaterWide® picture	63
Service	4
Setup, TV	8, 12-22, 35
Setup, TV Guide On Screen® system	31
Sleep timer	73
Sound quality adjustments	71
Specifications	85
SRS 3D	72
SRS WOW	72
StableSound®	71
Stereo sound	70
S-video cables	11
System restore	41
System status	41

T

TheaterWide® picture	62
Time and Date setting	39
Troubleshooting	80-84
TruBass	72
TV Guide On Screen®	21, 31, 42

V

V-Chip blocking (Locks menu)	77-78
VCR connection	13-18
Video cables	11
Video input labels	57
Video input lock	78
VOL (volume) ▲▼ buttons	28

W

Warranty	86
WOW, SRS	72

TOSHIBA AMERICA CONSUMER PRODUCTS, L.L.C.

HEAD OFFICE: 82 TOTOWA ROAD, WAYNE, NJ 07470, U.S.A.
NATIONAL SERVICE DIVISION: 1420-B TOSHIBA DRIVE, LEBANON, TN 37087, U.S.A.

MANUFACTURED BY
TOSHIBA ELECTROMEX, S.A. DE C.V.

CableClear, ColorStream, StableSound, and TheaterWide are registered trademarks of Toshiba America Consumer Products, L.L.C.
Channel Browser, GameTimer, and SurfLock are trademarks of Toshiba America Consumer Products, L.L.C.

PRINTED IN USA
(05-09)

Copyright © 2005 TOSHIBA CORPORATION. All rights reserved.

TOSHIBA

Free Manuals Download Website

<http://myh66.com>

<http://usermanuals.us>

<http://www.somanuals.com>

<http://www.4manuals.cc>

<http://www.manual-lib.com>

<http://www.404manual.com>

<http://www.luxmanual.com>

<http://aubethermostatmanual.com>

Golf course search by state

<http://golfingnear.com>

Email search by domain

<http://emailbydomain.com>

Auto manuals search

<http://auto.somanuals.com>

TV manuals search

<http://tv.somanuals.com>