

# TOSHIBA

# REGZA

## Owner's Manual

### Integrated High Definition LCD Television

COLORSTREAM<sup>®</sup> HD

DOLBY  
DIGITAL

SRS  
WOW

HDMI

HDTV  
HIGH-DEFINITION TELEVISION

**40XF550U**

**46XF550U**

**52XF550U**

For an overview of steps for setting up your new TV, see page 9.

Note: To display a High Definition picture, the TV must be receiving a High Definition signal (such as an over-the-air High Definition TV broadcast, a High Definition digital cable program, or a High Definition digital satellite program). For details, please contact your TV antenna installer, cable provider, or satellite provider.

#### Owner's Record

The model number and serial number are on the back of your TV. Record these numbers in the spaces below. Refer to these numbers whenever you communicate with your Toshiba dealer about this TV.

Model number:

Serial number:

## Dear Customer,

Thank you for purchasing this Toshiba LCD TV. This manual will help you use the many exciting features of your new LCD TV. **Before operating your LCD TV, please read this manual completely**, and keep it nearby for future reference.

### Safety Precautions

**WARNING: TO REDUCE THE RISK OF FIRE OR ELECTRIC SHOCK, DO NOT EXPOSE THIS APPLIANCE TO RAIN OR MOISTURE.**

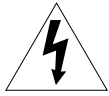

**WARNING**  
RISK OF ELECTRIC SHOCK  
DO NOT OPEN.



**WARNING: TO REDUCE THE RISK OF ELECTRIC SHOCK, DO NOT REMOVE COVER (OR BACK). NO USER-SERVICEABLE PARTS INSIDE. REFER SERVICING TO QUALIFIED SERVICE PERSONNEL.**

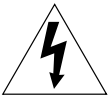

The lightning flash with arrowhead symbol, within an equilateral triangle, is intended to alert the user to the presence of uninsulated "dangerous voltage" within the product's enclosure that may be of sufficient magnitude to constitute a risk of electric shock to persons.



The exclamation point within an equilateral triangle is intended to alert the user to the presence of important operating and maintenance (servicing) instructions in the literature accompanying the appliance.

### WARNING

To prevent injury, this apparatus must be securely attached to the floor/wall in accordance with the installation instructions. See item 20 on page 3 and instructions on page 5.

**WARNING:** If you decide to wall mount this television, always use a UL Listed wall bracket appropriate for the size and weight of this television. The use of any wall bracket other than a UL Listed wall bracket appropriate for the size and weight of this television for wall mounting this television could result in serious bodily injury and/or property damage. See "Removing the Pedestal Stand" (page 5).

### NOTE TO CATV INSTALLERS

This is a reminder to call the CATV system installer's attention to Article 820-40 of the U.S. NEC, which provides guidelines for proper grounding and, in particular, specifies that the cable ground shall be connected to the grounding system of the building, as close to the point of cable entry as practical. For additional antenna grounding information, see items 27 and 28 on page 4.

## CHILD SAFETY:

It Makes A Difference How and Where You Use Your Flat Panel Display

**Congratulations on your purchase! As you enjoy your new product, please keep these safety tips in mind:**

### The Issue

• The home theater entertainment experience is a growing trend and larger flat panel displays are popular purchases. However, flat panel displays are not always supported on the proper stands or installed according to the manufacturer's recommendations.

• Flat panel displays that are inappropriately situated on dressers, bookcases, shelves, desks, speakers, chests or carts may fall over and cause injury.



### TOSHIBA Cares!

• The consumer electronics industry is committed to making home entertainment enjoyable and safe.

### Tune Into Safety

- One size does NOT fit all. Follow the manufacturer's recommendations for the safe installation and use of your flat panel display.
- Carefully read and understand all enclosed instructions for proper use of this product.
- Don't allow children to climb on or play with furniture and television sets.
- Don't place flat panel displays on furniture that can easily be used as steps, such as a chest of drawers.
- Remember that children can become excited while watching a program, especially on a "larger than life" flat panel display. Care should be taken to place or install the display where it cannot be pushed, pulled over, or knocked down.
- Care should be taken to route all cords and cables connected to the flat panel display so that they cannot be pulled or grabbed by curious children.



### Wall Mounting: If you decide to wall mount your flat panel display, always:

- Use a mount that has been recommended by the display manufacturer and/or listed by an independent laboratory (such as UL, CSA, ETL).
- Follow all instructions supplied by the display and wall mount manufacturers.
- If you have any doubts about your ability to safely install your flat panel display, contact your retailer about professional installation.
- Make sure that the wall where you are mounting the display is appropriate. Some wall mounts are not designed to be mounted to walls with steel studs or old cinder block construction. If you are unsure, contact a professional installer.
- A minimum of two people are required for installation. Flat panel displays can be heavy.



[www.CE.org/safety](http://www.CE.org/safety)

## Important Safety Instructions

- 1) **Read these instructions.**
  - 2) **Keep these instructions.**
  - 3) **Heed all warnings.**
  - 4) **Follow all instructions.**
- 
- 5) **Do not use this apparatus near water.**
  - 6) **Clean only with dry cloth.**
  - 7) **Do not block any ventilation openings.** Install in accordance with the manufacturer's instructions.
  - 8) **Do not install near any heat sources** such as radiators, heat registers, stoves, or other apparatus (including amplifiers) that produce heat.



- 9) **Do not defeat the safety purpose of the polarized or grounding type plug.** A polarized plug has two blades with one wider than the other. A grounding type plug has two blades and a third grounding prong. The wide blade or the third prong are provided for your safety. If the provided plug does not fit into your outlet, consult an electrician for replacement of the obsolete outlet.

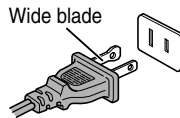

- 10) **Protect the power cord** from being walked on or pinched, particularly at plugs, convenience receptacles, and the point where they exit from the apparatus.

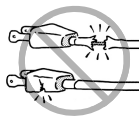

- 11) **Only use attachments/accessories specified by the manufacturer.**

- 12) **Use only with the cart, stand, tripod, bracket, or table specified by the manufacturer, or sold with the apparatus.** When a cart is used, use caution when moving the cart/apparatus combination to avoid injury from tip-over.



- 13) **Unplug this apparatus during lightning storms or when unused for long periods of time.**

- 14) **Refer all servicing to qualified service personnel.** Servicing is required when the apparatus has been damaged in any way, such as power-supply cord or plug is damaged, liquid has been spilled or objects have fallen into the apparatus, the apparatus has been exposed to rain or moisture, does not operate normally, or has been dropped.

## Additional Safety Precautions

- 14a) **CAUTION:** If the TV is dropped and the cabinet or enclosure surface has been damaged or the TV does not operate normally, take the following precautions:
  - ALWAYS turn off the TV and unplug the power cord to avoid possible electric shock or fire.
  - NEVER allow your body to come in contact with any broken glass or liquid from the damaged television. The LCD panel inside the TV contains glass and a toxic liquid. If the liquid comes in contact with your mouth or eyes, or your skin is cut by broken glass, rinse the affected area thoroughly with water and consult your doctor.
  - ALWAYS contact a service technician to inspect the TV any time it has been damaged or dropped.

- 15) **CAUTION:**
  - To reduce the risk of electric shock, do not use the polarized plug with an extension cord, receptacle, or other outlet unless the blades can be inserted completely to prevent blade exposure.
  - To prevent electric shock, match wide blade of plug to wide slot; fully insert.
- 16) **WARNING:** To prevent the spread of fire, keep candles or other open flames away from this product at all times.

## Installation, Care, and Service

### Installation

Follow these recommendations and precautions and heed all warnings when installing your TV:

- 17) Never modify this equipment. Changes or modifications may void: a) the warranty, and b) the user's authority to operate this equipment under the rules of the Federal Communications Commission.

- 18) **DANGER: RISK OF SERIOUS PERSONAL INJURY, DEATH, OR EQUIPMENT DAMAGE!** Never place the TV on an unstable cart, stand, or table. The TV may fall, causing serious personal injury, death, or serious damage to the TV.



- 19) To avoid damage to this product, never place or store the TV in direct sunlight; hot, humid areas; or areas subject to excessive dust or vibration.

- 20) Always place the TV on the floor or a sturdy, level, stable surface that can support the weight of the unit. To secure the TV, use a sturdy strap from the hooks on the rear of the TV pedestal to a wall stud, pillar, or other immovable structure. Make sure the strap is tight, secure, and parallel to the floor.

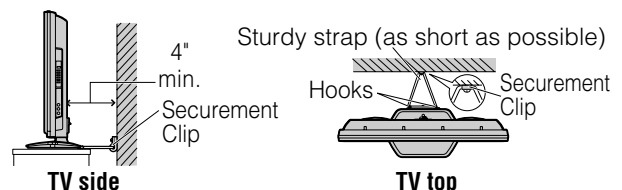

- 21) The apparatus shall not be exposed to dripping or splashing and that no objects filled with liquids, such as vases, shall be placed on the apparatus.

- 22) Never block or cover the slots or openings in the TV cabinet back, bottom, and sides. Never place the TV:
  - on a bed, sofa, rug, or similar surface;
  - too close to drapes, curtains, or walls; or
  - in a confined space such as a bookcase, built-in cabinet, or any other place with poor ventilation.

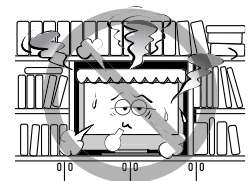

The slots and openings are provided to protect the TV from overheating and to help maintain reliable operation of the TV. Leave a space of at least 4 (four) inches around the TV.

(continued)

- 23) Always place the back of the television at least four (4) inches away from any vertical surface (such as a wall) to allow proper ventilation.
- 24) Never allow anything to rest on or roll over the power cord, and never place the TV where the power cord is subject to wear or abuse.
- 25) Never overload wall outlets and extension cords.
- 26) Always operate this equipment from a 120 VAC, 60 Hz power source only.
- 27) Always make sure the antenna system is properly grounded to provide adequate protection against voltage surges and built-up static charges (see Section 810 of the National Electric Code).

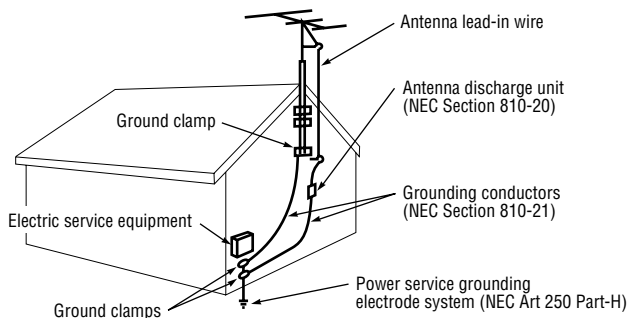





- 28)  **DANGER: RISK OF SERIOUS PERSONAL INJURY OR DEATH!**
- Use extreme care to make sure you are never in a position where your body (or any item you are in contact with, such as a ladder or screwdriver) can accidentally touch overhead power lines. Never locate the antenna near overhead power lines or other electrical circuits.
  - Never attempt to install any of the following during lightning activity: a) an antenna system; or b) cables, wires, or any home theater component connected to an antenna or phone system.

## Care

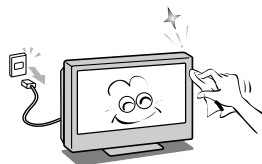
For better performance and safer operation of your TOSHIBA TV, follow these recommendations and precautions:



- 29) If you use the TV in a room whose temperature is 32 °F (0 °C) or below, the picture brightness may vary until the LCD warms up. This is not a sign of malfunction.
- 30) Always unplug the TV before cleaning. Gently wipe the display panel surface (the TV screen) using a dry, soft cloth only (cotton, flannel, etc.). A hard cloth may damage the surface of the panel. Avoid contact with alcohol, thinner, benzene, acidic or alkaline solvent cleaners, abrasive cleaners, or chemical cloths, which may damage the surface. Never spray volatile compounds such as insecticide on the cabinet. Such products may damage or discolor the cabinet.



- 31)  **WARNING: RISK OF ELECTRIC SHOCK!**   
Never spill liquids or push objects of any kind into the TV cabinet slots.
- 32) While it is thundering, do not touch the connecting cables or apparatus.
- 33) For added protection of your TV from lightning and power surges, always unplug the power cord and disconnect the antenna from the TV if you leave the TV unattended or unused for long periods of time.
- 34) During normal use, the TV may make occasional snapping or popping sounds. This is normal, especially when the unit is being turned on or off. If these sounds become frequent or continuous, unplug the power cord and contact a Toshiba Authorized Service Center.
- 35)  **WARNING: RISK OF SERIOUS PERSONAL INJURY OR EQUIPMENT DAMAGE!**   
Never strike the screen with a sharp or heavy object.

- 36) • The LCD screen of this product can be damaged by ultraviolet radiation from the sun. When selecting a location for the television, avoid locations where the screen may be exposed to direct sunlight, such as in front of a window.
- Never touch, press, or place anything on the LCD screen. These actions will damage the LCD screen. If you need to clean the LCD screen, follow the instructions in item 30 on this page.

## Service

- 37)  **WARNING: RISK OF ELECTRIC SHOCK!**   
Never attempt to service the TV yourself. Opening and removing the covers may expose you to dangerous voltage or other hazards. Failure to follow this WARNING may result in death or serious injury. Refer all servicing not specified in this manual to a Toshiba Authorized Service Center.
- 38) If you have the TV serviced:
- Ask the service technician to use only replacement parts specified by the manufacturer.
  - Upon completion of service, ask the service technician to perform routine safety checks to determine that the TV is in safe operating condition.
- 39) The cold cathode fluorescent lamp in the LCD panel contains a small amount of mercury.
- When the TV reaches the end of its useful life, dispose of the used TV by the approved method for your area, or ask a qualified service technician to properly dispose of the TV.
-  **Note:** The lamp(s) inside this product contain mercury. Disposal may be regulated due to environmental considerations. For disposal or recycling information, contact your local authorities or the Electronics Industries Alliance ([www.eiae.org](http://www.eiae.org)).

## Choosing a location for your LCD TV

### To Display your LCD TV on the included Pedestal Stand:

Observe the following safety precautions:

- 1) Read and Follow the pedestal assembly instructions included with the pedestal.

**CAUTION:** Before beginning pedestal assembly, carefully lay the front of the LCD Panel face down on a flat, cushioned surface such as a quilt or blanket. Leave the bottom of the unit protruding over the edge of the surface and assemble the pedestal as indicated below.

**Note:** Extreme care should always be used when attaching the pedestal stand to avoid damage to the LCD panel.

- 2) Place the TV on a sturdy, level surface that can support the weight of the TV.
- 3) Be sure to secure the TV to a wall stud, pillar, surface, or other immovable structure. To secure the TV in this manner: (1) attach the provided securement clip to an immovable structure, then (2) pass a sturdy strap through the securement clip and attach each end to the hooks located on the back of the TV. Be sure to leave at least 4 inches between the TV and the wall or similar structure for ventilation. See item 20, page 3 for additional details.

### To Display your LCD TV using a Wall Bracket:

If you decide to wall mount your LCD TV, always use a UL-listed wall bracket appropriate for the size and weight of the LCD TV (see page 2) :

- 1) **CAUTION:** Two people are required for installation.
- 2) Unplug and remove any cables and/or other component connectors from the rear of the TV.
- 3) Follow the instructions provided with your wall bracket. Before proceeding, make sure the appropriate bracket(s) are attached to the wall and the back of the TV as described in the instructions provided with the wall bracket.
- 4) After attaching the appropriate bracket(s) to the wall and the back of the TV, remove the pedestal stand from the TV as described below.

## Removing the Pedestal Stand

- 1) Carefully lay the front of the unit face down on a flat, cushioned surface such as a quilt or blanket. Leave the stand protruding over the edge of the surface.

**Note:** Extreme care should always be used when removing the pedestal stand to avoid damage to the LCD panel.

- 2) Remove the jack pack cover on the back of the TV to expose the pedestal stand screws. The jack pack cover can be removed without tools.
- 3) Remove the five screws shown in the diagram below. This will allow removal of the pedestal stand.
- 4) Once you have removed all five screws holding the pedestal stand in place, remove the pedestal stand from the TV by sliding the pedestal stand away from the TV.

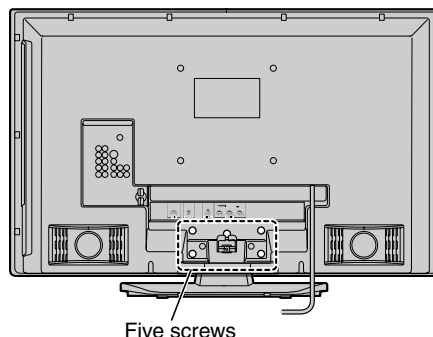

---

## **FCC Declaration of Conformity Compliance Statement (Part 15):**

The **Toshiba 40XF550U, 46XF550U, and 52XF550U Televisions** comply with Part 15 of the FCC rules.

Operation is subject to the following two conditions: (1) this device may not cause harmful interference, and (2) this device must accept any interference received, including interference that may cause undesired operation.

The party responsible for compliance to these rules is:

Toshiba America Consumer Products, L.L.C.

82 Totowa Rd. Wayne, NJ 07470.

Ph: 1-800-631-3811

**Note:** *This equipment has been tested and found to comply with the limits for a Class B digital device, pursuant to Part 15 of the FCC rules. These limits are designed to provide reasonable protection against harmful interference in a residential installation. This equipment generates, uses, and can radiate radio frequency energy and, if not installed and used in accordance with the instructions, may cause harmful interference to radio communications. However, there is no guarantee that interference will not occur in a particular installation. If this equipment does cause harmful interference to radio or television reception, which can be determined by removing and applying power to the equipment, the user is encouraged to try to correct the interference by one or more of the following measures:*

- Reorient or relocate the receiving antenna.
- Increase the separation between the equipment and the receiver.
- Connect the equipment into an outlet on a circuit different from that to which the receiver is connected.
- Consult the dealer or an experienced radio/TV technician for help.

**Caution:** *Changes or modifications to this equipment not expressly approved by Toshiba could void the user's authority to operate this equipment.*

---

## **Important notes about your LCD TV**

**The following symptoms are technical limitations of LCD Display technology and are not an indication of malfunction; therefore, Toshiba is not responsible for perceived issues resulting from these symptoms.**

- 1) An afterimage (ghost) may appear on the screen if a fixed, non-moving image is displayed for a long period of time. The afterimage is not permanent and will disappear in a short period of time.
- 2) The LCD panel contained in this TV is manufactured using an extremely high level of precision technology; however, there may be an occasional pixel (dot of light) that does not operate properly (does not light, remains constantly lit, etc.). This is a structural property of LCD technology, is not a sign of malfunction, and is not covered under your warranty. Such pixels are not visible when the picture is viewed from a normal viewing distance.

**Note:** *Interactive video games that involve shooting a "gun" type of joystick at an on-screen target may not work with this TV.*

---

## **Trademark Information**

- WOW, SRS and (●) symbol are registered trademarks of SRS Labs, Inc.  
WOW technology is incorporated under license from SRS Labs, Inc.
- Manufactured under license from Dolby Laboratories.  
Dolby and the double-D symbol are registered trademarks of Dolby Laboratories.
- HDMI, the HDMI logo and High-Definition Multimedia Interface are trademarks or registered trademarks of HDMI Licensing LLC.
- Deep Color is trademark of HDMI Licensing LLC.
- "x.v.Color" and the "x.v.Color" logo are trademarks of Sony Corporation.

# Contents

<b>Important Safety Instructions</b> .....	<b>3</b>
<b>Installation, Care, and Service</b> .....	<b>3</b>
<b>Chapter 1: Introduction</b> .....	<b>9</b>
Features of your new TV .....	9
Overview of steps for installing, setting up, and using your new TV .....	9
TV front and side panel controls and connections .....	10
TV back panel connections .....	11
<b>Chapter 2: Connecting your TV</b> .....	<b>12</b>
Overview of cable types .....	12
About the connection illustrations .....	12
Connecting a VCR (or a VCR with S-video) and antenna, Cable TV or Camcorder .....	13
Connecting a DVD player with ColorStream® (component video), a VCR, and a satellite receiver .....	14
Connecting a device to the IR OUT infrared terminal using the IR blaster cable for IR pass-through device control .....	15
Connecting an HDMI™ or DVI device to the HDMI input .....	16
REGZA-LINK connection .....	17
Connecting a digital audio system .....	18
Connecting an audio system .....	18
Connecting a personal computer (PC) .....	19
<b>Chapter 3: Using the remote control</b> .....	<b>20</b>
Preparing the remote control for use .....	20
Installing the remote control batteries .....	20
Learning about the remote control .....	21
Remote Control functional key chart .....	22
Using the remote control to operate your other devices .....	24
Programming the remote control to operate your other devices .....	24
Device code setup .....	24
Searching and sampling the code of a device (8500) .....	25
Using the volume lock feature (8000) .....	25
Operational feature reset (8900) .....	25
Multi-brand remote control device codes .....	26
<b>Chapter 4: Menu layout and navigation</b> .....	<b>33</b>
Main menu layout .....	33
Setup/Installation menu layout .....	33
THINC™ menu .....	33
Navigating the menu system .....	34
<b>Chapter 5: Setting up your TV</b> .....	<b>35</b>
Setting the Demo Mode .....	35
Selecting the menu language .....	35
Configuring the input source for the ANT/CABLE terminal .....	36
Programming channels into the TV's channel memory .....	36
Programming channels automatically .....	36
Manually adding and deleting channels in the channel memory .....	37
Setting the Auto Input feature .....	37
Labeling channels .....	38
Setting the HDMI™ audio mode .....	39
Viewing the digital signal meter .....	39
Setting the time zone .....	39
Viewing the system status .....	40
Selecting the Blue LED Illumination level .....	40
Selecting the Power-On Mode .....	40
Selecting the Demo Mode .....	40
<b>Chapter 6: Using the TV's features</b> .....	<b>41</b>
Selecting the video input source to view .....	41
Labeling the video input sources .....	41
Tuning channels .....	42
Tuning channels using the Channel Browser™ .....	42
Setting the Channel Tuning Mode .....	44
Tuning to the next programmed channel .....	44
Tuning to a specific channel (programmed or unprogrammed) .....	44
Switching between two channels using Channel Return .....	45
Switching between two channels using SurfLock™ .....	45
Selecting the picture size .....	45
Scrolling the TheaterWide® picture (TheaterWide 2 and 3 only) .....	47
Using the auto aspect ratio feature .....	47
Using the FREEZE feature .....	48
Adjusting the picture .....	48
Selecting the picture mode .....	48
Adjusting the picture quality .....	48
Using the TheaterLock™ feature .....	49
Using the closed caption mode .....	49
Base closed captions .....	49
Digital CC Settings .....	50
CC Selector .....	50
Using the Closed Caption button on the remote control .....	50
Adjusting the audio .....	50
Muting the sound .....	50
Using the digital audio selector .....	51
Selecting stereo/SAP broadcasts .....	51
Adjusting the audio quality .....	51
Using the StableSound® feature .....	52
Selecting the optical audio output format .....	52
Using the Dolby® Digital Dynamic Range Control feature .....	52
Using the Locks menu .....	52
Entering the PIN code .....	52
If you cannot remember your PIN code .....	53
Changing your PIN code .....	53
Blocking TV programs and movies by rating (V-Chip) .....	53
Downloading an additional rating system for blocking TV programs and movies .....	54
Blocking channels .....	55
Unlocking programs temporarily .....	55
Using the input lock feature .....	55
Using the GameTimer® .....	55
Using the control panel lock feature .....	56
Using the PC settings feature .....	56
Setting the PC Audio .....	57
Setting the sleep timer .....	57
Using REGZA-LINK .....	57
REGZA-LINK playback device (HD DVD player, etc.) control .....	57
REGZA-LINK input source selection .....	58
VOLUME and MUTE controls of Audio Receiver .....	58
Other REGZA-LINK functions .....	58
Using the HDMI settings feature .....	59
Displaying TV status information .....	60
Understanding the auto power off feature .....	60
Understanding the last mode memory feature .....	60

(continued)

<b>Chapter 7: Using the TV's advanced features</b> . . . . .	<b>61</b>
Using the advanced picture settings features . . . . .	61
Using dynamic contrast . . . . .	61
Using the static gamma feature . . . . .	61
Selecting the color temperature . . . . .	61
Selecting the cinema mode (480i and 1080i signals) . . . . .	62
Using the ClearFrame™ feature . . . . .	62
Using the Film Stabilization feature . . . . .	62
Using CableClear® digital noise reduction . . . . .	62
Using MPEG noise reduction . . . . .	63
Using the ColorMaster™ feature . . . . .	63
Using x.v.Color Selection feature . . . . .	64
Using the Game Mode feature . . . . .	64
Using the advanced audio settings features . . . . .	64
Using the SRS WOW® surround sound feature . . . . .	64
<b>Chapter 8: Troubleshooting</b> . . . . .	<b>65</b>
General troubleshooting . . . . .	65
LED indications . . . . .	66
<b>Chapter 9: Appendix</b> . . . . .	<b>68</b>
Specifications . . . . .	68
Acceptable signal formats	
for PC IN and HDMI terminals . . . . .	69
Limited United States Warranty	
for LCD Televisions 26" and Larger . . . . .	70
Limited Canadian Warranty	
for Toshiba Brand Flat Panel Televisions . . . . .	71
<b>Index</b> . . . . .	<b>73</b>



## Features of your new TV

The following are just a few of the many exciting features of your new Toshiba widescreen, integrated HD, LCD TV:

- **Super Narrow Bezel and Blue LED Illumination.**
- **Integrated digital tuning (8VSB ATSC and QAM)** eliminates the need for a separate digital converter set-top box (in most cases).
- **1080p output resolution.**
- **Three HDMI™** digital, high-definition multimedia interfaces with 1080p input support (🔗 page 16).
- **HDMI capabilities**
  - Lip-Sync Latency** feature activates an auto audio/video display timing adjustment function that allows HDMI source devices to accurately perform synchronization automatically.
  - Deep Color** feature allows the HDMI source to increase the available colors bits within the boundaries defined by the RGB or YCbCr color space.
  - x.v.Color** feature expands the acceptable color range (limits) in HDMI signals and allows for sending of wider color signals from HDMI.
- **REGZA-LINK** allows control of external devices from the TV remote via HDMI connection (🔗 page 57).
- **Two sets of ColorStream® HD** high-resolution component video inputs (🔗 page 14).
- **SRS WOW™** audio technologies (🔗 page 64).
- **Digital Audio Out** optical audio connection with Dolby® Digital optical output format (🔗 page 52).
- **CableClear®** digital picture noise reduction (🔗 page 62).
- **PC IN (Analog RGB)** computer terminal (🔗 page 19).
- **Channel Labeling** allows you to put the Call Letters (e.g. ABC, HBO, etc.) on the screen along with the station numbers, so you always know what you're watching (🔗 page 38).
- **IR OUT** infrared terminal using the IR blaster cable for IR pass-through device control (🔗 pages 12 and 15).
- **ColorMaster™** allows you to adjust the TV's standard colors. The menu for this feature has a unique "black" design to enhance contrast while you're adjusting the color (🔗 page 63).

## Overview of steps for installing, setting up, and using your new TV

Follow these steps to set up your TV and begin using its many exciting features.

- 1** Observe the following when choosing a location for the TV:
    - Read "Important notes about your LCD TV" (🔗 page 6).
    - Place the TV in a proper location (🔗 pages 2–5)
  - 2** Do not plug in any power cords until AFTER you have connected all cables and devices to your TV.
  - 3** BEFORE connecting cables or devices to the TV, learn the functions of the TV's connections and controls (🔗 pages 10–11).
  - 4** Connect your other electronic device(s) to the TV (🔗 pages 12–19).
  - 5** See "Chapter 3: Using the remote control" (🔗 page 20) for an overview of the buttons on the remote control, install the batteries and prepare to operate your other device(s).
  - 6** AFTER connecting all cables and devices, plug in the power cords for your TV and other devices.
- Note: After you turn on the TV, the Menu Language selection and Demo Mode selection menus appear automatically by default. You can turn off the On-Screen demonstration mode by setting the Demo Mode to Off. (🔗 page 35).**
- 7** See "Menu layout and navigation" for a quick overview of navigating the TV's menu system (🔗 page 33).
  - 8** Program channels into the TV's channel memory (🔗 page 36).
  - 9** For details on using the TV's features, see Chapters 6 and 7.
  - 10** For help, refer to the Troubleshooting Guide, see Chapter 8.
  - 11** For technical specifications and warranty information, see Chapter 9.

## TV front and side panel controls and connections

Model 40XF550U is used in this manual for illustration purposes.

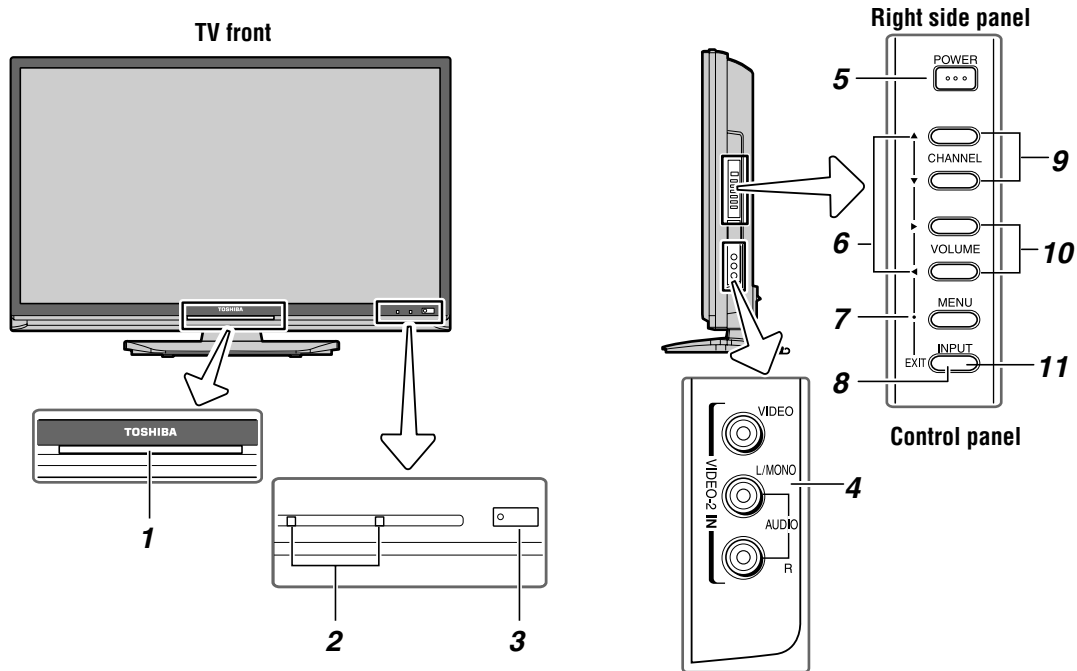

**1 Illumination** — Power indicator

This slit will be illuminated by the blue LED back light. See “Selecting the Blue LED Illumination level” on page 40 for additional information.

**2 Green and Yellow LEDs**

Green: See “LED indications” on page 66.

Yellow = Power-On Mode indicator (☞ “Selecting the Power-On Mode” on page 40)

See “LED indications” on page 66 for additional information.

**3 Remote sensor** — Point the remote control toward this remote sensor.

**Effective range:**

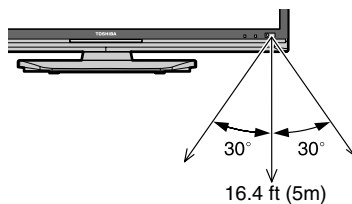

**4 VIDEO-2 IN** — The side panel A/V connections are referred to as “VIDEO 2” and include standard A/V connections.

**5 POWER** — Press to turn the TV on and off.

If the TV stops responding to the controls on the remote control or TV control panel and you cannot turn off the TV, press and hold the **POWER** button on the TV control panel for 5 or more seconds to reset the TV.

**6 ARROWS** — When a menu is on-screen, these buttons function as up/down/left/right menu navigation buttons.

**7 MENU (ENTER)** — Press to access the menu system (☞ page 33). When a menu is on-screen, the **MENU** button on the TV’s control panel functions as the **ENTER** button.

**8 EXIT** — Press to instantly close an on-screen menu.

**9 CHANNEL** — When no menu is on-screen, these buttons change the channel (programmed channels only; ☞ page 36).

**10 VOLUME** — These buttons adjust the volume level.

**11 INPUT** — Repeatedly press to change the source you are viewing (**ANT/CABLE, VIDEO 1, VIDEO 2, ColorStream HD1, ColorStream HD2, HDMI 1, HDMI 2, HDMI 3, PC**).

## TV back panel connections

For an explanation of cable types and connections, see pages 12–19.

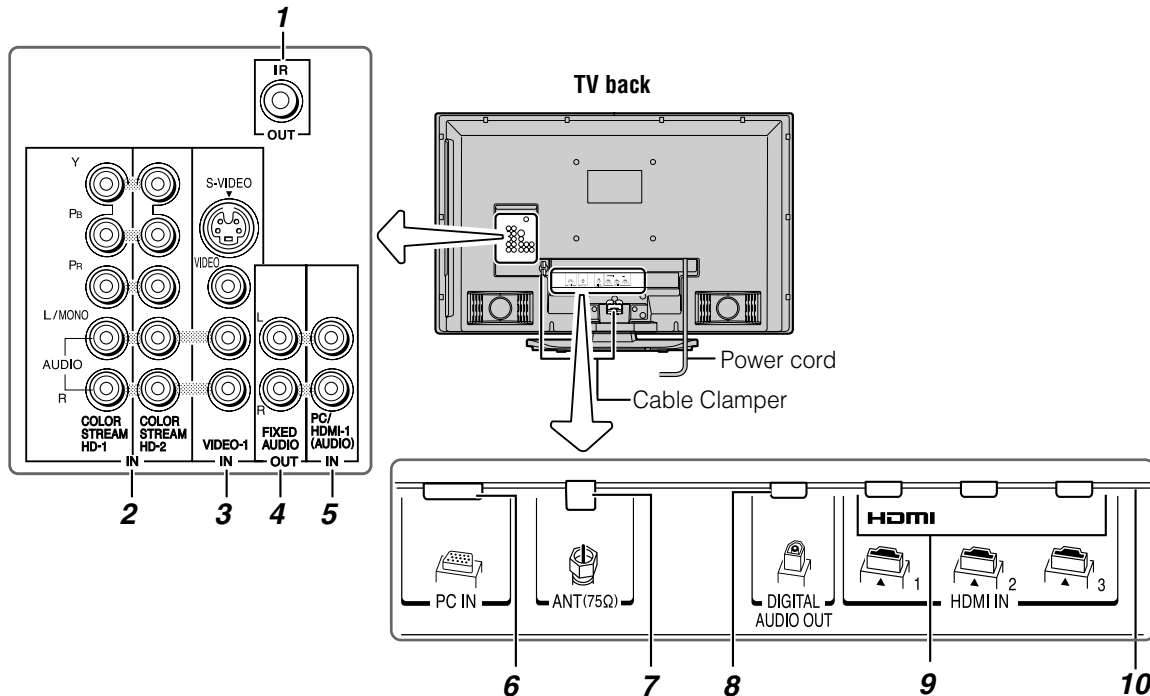

- 1 IR OUT** — For controlling infrared remote-controlled devices through the TV. You can connect up to two devices with an optical IR blaster cable (see page 12), and then control the devices using the TV's IR pass-through features.
- 2 ColorStream® HD1 and ColorStream® HD2** — Two sets of ColorStream® high-definition component video inputs (with standard stereo audio inputs) for connecting devices with component video output, such as a Toshiba DVD player with ColorStream®.  
*Note: Component video cables carry only video information; separate audio cables are required for a complete connection.*
- 3 VIDEO 1 IN** — Standard (composite) video and standard audio inputs plus optional S-video inputs for connecting devices with composite video or S-video output.  
*Note: Standard (composite) video and S-video cables carry only video information; separate audio cables are required for a complete connection.*
- 4 Fixed Audio OUT** — Analog audio outputs for connecting an audio amplifier.
- 5 PC/HDMI 1 (AUDIO) IN** — PC audio input terminal is shared with HDMI 1 analog audio input terminal, and their use can be configured in the **Audio Setup** menu (see page 57).
- 6 PC IN** — For use when connecting a personal computer.
- 7 ANT/CABLE** — Antenna input that supports analog (NTSC) and digital (ATSC) off-air antenna signals and analog and digital Cable TV (QAM) signals.
- 8 DIGITAL AUDIO OUT** — Optical audio output in Dolby Digital or PCM (pulse-code modulation) format for connecting an external Dolby Digital decoder, amplifier, A/V receiver, or home theater system with optical audio input.
- 9 HDMI™ IN** — High-Definition Multimedia Interface input receives digital audio and uncompressed digital video from an HDMI device or uncompressed digital video from a DVI device. HDMI connection is necessary to receive 1080p signals.
- 10 Service port** — For service use only. Used for updating the television's firmware.

HDMI, the HDMI logo and High-Definition Multimedia Interface are trademarks or registered trademarks of HDMI Licensing LLC. Manufactured under license from Dolby Laboratories. Dolby and the double-D symbol are registered trademarks of Dolby Laboratories.

## Chapter 2: Connecting your TV

### Overview of cable types

Cables can be purchased from most stores that sell audio/video devices. Before purchasing any cables, be sure of connector types required by your devices and the length of each cable.

#### Coaxial (F-type) cable



Coaxial (F-type) cable is used for connecting your antenna, cable TV service, and/or cable converter box to the **ANT/CABLE** input on your TV.

#### Standard A/V cables (red/white/yellow)

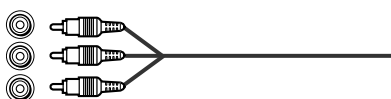

Standard A/V cables (composite video) usually come in sets of three, and are for use with video devices with analog audio and composite video output. These cables (and the related inputs on your TV) are typically color-coded according to use: yellow for video, red for stereo right audio, and white for stereo left (or mono) audio.

#### S-video cable



S-video cable is for use with video devices with S-video output. Separate audio cables are required for a complete connection.

**Note:** An S-video cable provides better picture performance than a composite video cable. If you connect an S-video cable, be sure to disconnect the standard (composite) video cable or the picture performance will be unacceptable.

#### Component video cables (red/green/blue)

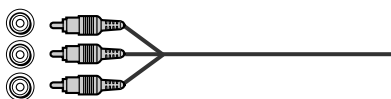

Component video cables come in sets of three and are for use with video devices with component video output. (ColorStream® is Toshiba's brand of component video.) These cables are typically color-coded red, green, and blue. Separate audio cables are required for a complete connection.

**Note:** Component video cables provide better picture performance than a standard (composite) video or S-video cable.

#### HDMI™ cable (with HDMI Logo “HDMI”)



HDMI (High-Definition Multimedia Interface) cable is for use with devices with an HDMI output. An HDMI cable delivers digital audio and video in its native format. This cable carries both video and audio information; therefore, separate audio cables are not required for a complete HDMI device connection (ⓘ pages 16, 17 and 19).

**Note:** HDMI cable provides better picture performance than a standard (composite) video or S-video cable.

#### Dual-wand IR blaster cable



Dual-wand IR blaster cable is for use with video devices with IR (infrared) remote control. This cable can be used with the TV's IR pass-through feature (ⓘ page 15).

#### To obtain IR blaster cable:

Visit <http://ceaccessories.toshiba.com/>

#### Optical audio cable



Optical audio cable is for connecting receivers with Dolby Digital or PCM (pulse-code modulation) optical audio input to the TV's **DIGITAL AUDIO OUT** terminal (ⓘ page 18).

#### Analog RGB (15-pin) computer cable

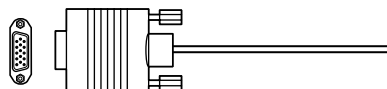

Analog RGB (15-pin) computer cable is for connecting a PC to the TV's **PC IN** terminal (ⓘ page 19).

**Note:** Separate audio cables are required for a complete connection.

### About the connection illustrations

You can connect different types and brands of devices to your TV in several different configurations. The connection illustrations in this manual are representative of typical device connections only. The input/output terminals on your devices may differ from those illustrated herein. For details on connecting and using your specific devices, refer to each device's owner's manual.

# Connecting a VCR (or a VCR with S-video) and antenna, Cable TV or Camcorder

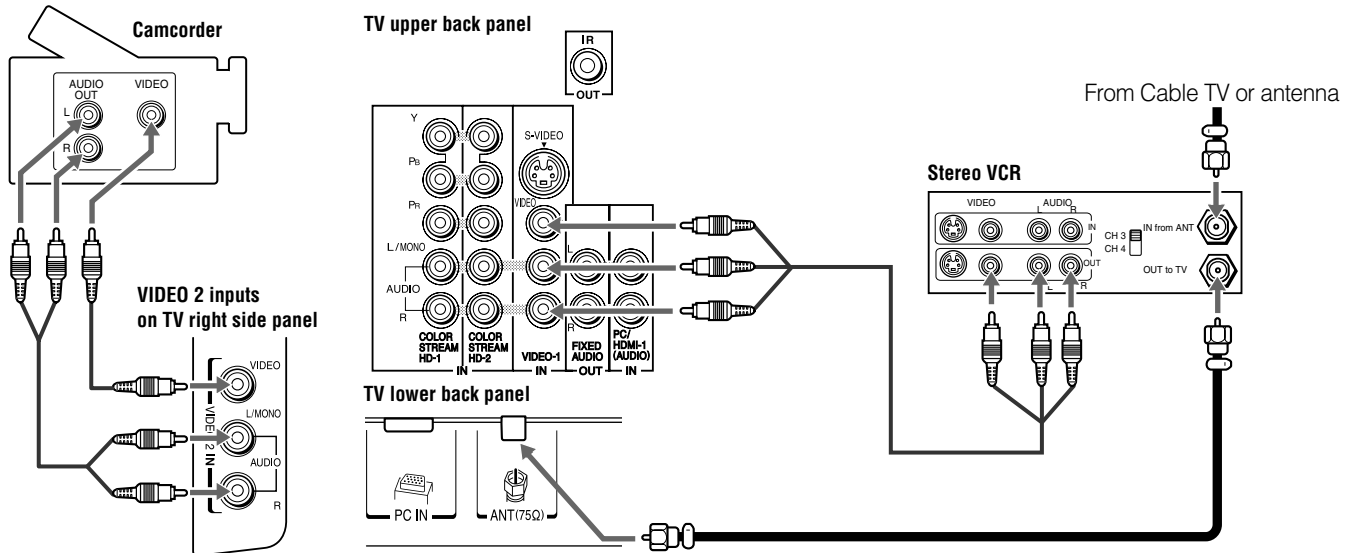

**You will need:**

- coaxial cables
- standard A/V cables
  - For better picture performance, if your VCR has S-video, use an S-video cable (plus the audio cables) instead of the standard video cable.
  - For better picture performance, if your camcorder has S-video, connect an S-video cable (plus the audio cables) to **VIDEO 1** on the TV back instead of the **VIDEO 2** on the TV right side panel.
  - If you have a mono VCR, connect **L/MONO** on the TV to your VCR's audio out terminal using the white audio cable only.
- S-video cable (if your VCR or camcorder has S-video)
  - Do not connect both types of video cable to **VIDEO 1** at the same time or the picture performance will be unacceptable.
- standard audio cables (if your VCR or camcorder has S-video)

**Note:** When you use a Cable box, you may not be able to use the remote control to program or access certain features on the TV.

**To view the antenna or Cable signal:**

Select the **ANT/CABLE** video input source on the TV.\*

**To view basic and premium Cable channels:**

Turn OFF the VCR. Select the **ANT/CABLE** video input source on the TV.\* Tune the TV to channel 3 or 4 (whichever channel the Cable box output is set to). Use the Cable box controls to change channels.

**To view the VCR:**

Turn ON the VCR. Select the **VIDEO 1** video input source on the TV.\*

**To view the camcorder video:**

Select the **VIDEO 2** video input source on the TV.\*

\* To select the video input source, press **INPUT** on the remote control (page 21). To program the TV remote control to operate other devices, see Chapter 3.

The unauthorized recording, use, distribution, or revision of television programs, videotapes, DVDs, and other materials is prohibited under the Copyright Laws of the United States and other countries, and may subject you to civil and criminal liability.

## Connecting a DVD player with ColorStream® (component video), a VCR, and a satellite receiver

Your TV has two sets of ColorStream® (component video) inputs.

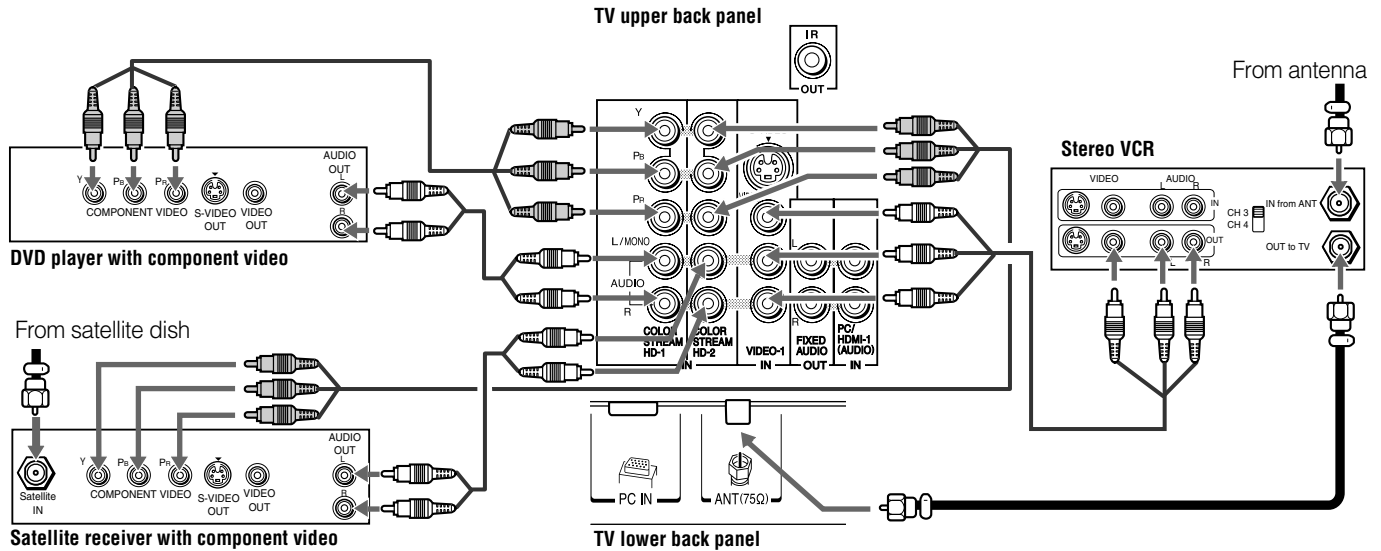

### You will need:

- coaxial cables
- standard A/V cables
  - For better picture performance, if your VCR has S-video, use an S-video cable (plus the audio cables) instead of the standard video cable. Do not connect both types of video cable to **VIDEO 1** at the same time or the picture performance will be unacceptable.
  - If you have a mono VCR, connect **L/MONO** on the TV to your VCR's audio out terminal using the white audio cable only.
- standard audio cables
- component video cables
  - You can connect the component video cables (plus audio cables) from the DVD player or satellite receiver to either set of **ColorStream** terminals on the TV (**HD1** or **HD2**). The **ColorStream HD1** and **HD2** terminals can be used to display Progressive (480p, 720p) and Interlaced (480i, 1080i). Please check the Owner's Manual of the DVD player or satellite in order to determine the best output signal available (1080p is not supported).
  - If your DVD player or satellite receiver does not have component video, connect a standard A/V cable to **VIDEO 2** on the side panel. If your DVD player has HDMI video, see page 16.

### To view antenna or Cable channels:

Select the **ANT/CABLE** video input source on the TV.\*

### To view the DVD player:

Turn ON the DVD player. Select the **ColorStream HD1** video input source on the TV.\*

### To view satellite programs using the component video connections:

Turn on the satellite receiver. Select the **ColorStream HD2** video input source on the TV.\*

### To view the VCR or view and record antenna channels:

Turn ON the VCR. Tune the VCR to the channel you want to watch. Select the **VIDEO 1** video input source on the TV.\*

### To record a TV program while watching a DVD:

Turn ON the VCR. Tune the VCR to the channel to record. Select the **ColorStream HD1** video input source on the TV\* to view the DVD.

\* To select the video input source, press **INPUT** on the remote control (page 21). To program the TV remote control to operate other devices, see Chapter 3.

The unauthorized recording, use, distribution, or revision of television programs, videotapes, DVDs, and other materials is prohibited under the Copyright Laws of the United States and other countries, and may subject you to civil and criminal liability.

## Connecting a device to the IR OUT infrared terminal using the IR blaster cable for IR pass-through device control

You can use the TV's **IR OUT** terminal (infrared pass-through) to remotely operate (through the TV) many infrared remote-controlled devices (such as Toshiba infrared remote-controlled VCRs or DVD players) enclosed within an entertainment center or similar cabinet. Without the **IR OUT** connection, the device typically would need to be visible to operate it remotely.

### You will need:

- dual-wand IR blaster cable (see page 12)
- other audio/video cables as required to connect the device(s) to the TV (see pages 13–17)

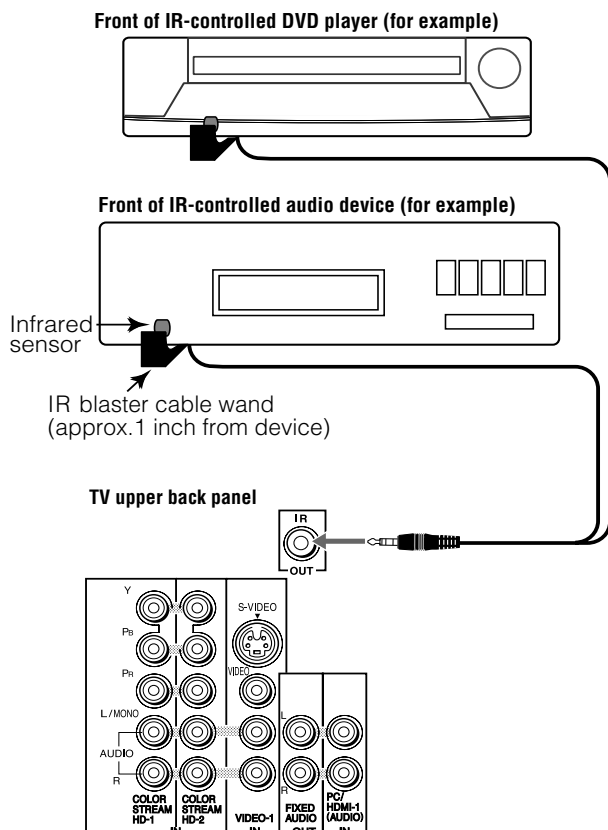

### To connect the IR blaster cable:

- 1 Locate the infrared sensor on the front of your device. This sensor is marked on some devices.\*
  - 2 Align one of the IR blaster cable's wands about 1 inch away from the infrared sensor on the front of the device and attach it using double-sided mounting tape. If you have a second device, attach the second wand in a similar manner. (See illustration.)
- Note:** If you do not have a second device, coil the second wand with a rubber band and leave it behind the TV.
- 3 Plug the IR blaster cable's plug into the TV's **IR OUT** terminal.

### To control the device(s):

Point either the device's remote control or the TV remote control (that you previously programmed to operate the device; see Chapter 3) toward the front of the TV and press the button for the desired function. The signal passes from the remote control through the TV to the device via the IR blaster cable.

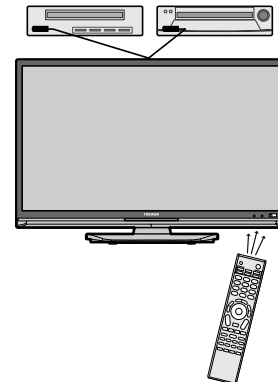

### Note:

- If you use the device's remote control to operate the device, you also will need to use the TV's remote control to operate the TV.
- The IR pass-through feature does not support all IR-controlled devices; satisfactory performance may not be attainable with certain devices.

### \*If you cannot locate the device's infrared sensor:

- 1 Turn OFF the device.
- 2 Starting at the lower left corner of the device, place the end of the device's remote control (with the infrared emitter) so it touches the front of the device and press **POWER**. (Do not use the TV's remote control for this step.)
- 3 If the device turns on, the point at which the remote control touched the device is the location of the sensor.
- 4 If the device does not turn on, move the remote control slightly to the right and press **POWER** again.
- 5 Repeat step 4 until you locate the device's infrared sensor.

## Connecting an HDMI™ or DVI device to the HDMI input

The HDMI input on your TV receives digital audio and uncompressed digital video from an HDMI source device, or uncompressed digital video from a DVI (Digital Visual Interface) source device.

This input is designed to accept HDCP (High-Bandwidth Digital-Content Protection) program material in digital form from EIA/CEA-861-D-compliant<sup>[1]</sup> consumer electronic devices (such as a set-top box or DVD player with HDMI or DVI output).

The HDMI input can accept and display VGA, SVGA, XGA, WXGA, SXGA, 480i (60Hz), 480p (60Hz), 720p (60Hz), 1080i (60Hz), and 1080p (24Hz/60Hz) signal formats. For detailed signal specifications, see page 69.

Supported Audio format: Linear PCM, sampling rate 32/44.1/48 kHz

### Note:

- To connect a PC to the HDMI input, see page 19.
- Some of legacy HDMI sources may not work properly with your latest HDMI TV, due to new standard adoption. Please try to set Off the following three options (Lip-Sync Latency, Deep Color, x.v.Color). Your legacy HDMI source should operate properly with your TV. See page 69.
- Supported Audio format : Linear PCM, sampling rate 32/44.1/48kHz

### To connect an HDMI device, you will need:

- one HDMI cable (type A connector) per HDMI device
  - For proper operation, it is recommended that you use an HDMI cable with the HDMI Logo (**HDMI**).
  - To display an 1080p/60Hz signal format, you will need a Category 2 cable. Conventional HDMI/DVI cable may not work properly.
  - HDMI cable transfers both video and audio. Separate analog audio cables are not required (see illustration).
  - See “Setting the HDMI™ audio mode” (page 39).

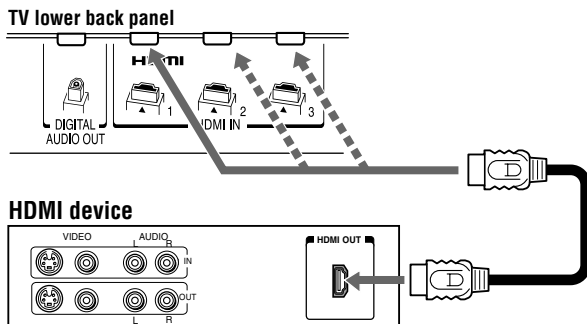

### To view the HDMI device video:

Select the HDMI 1, HDMI 2, or HDMI 3 video input source on the TV.\*

\* To select the video input source, press **INPUT** on the remote control (page 21). To program the TV remote control to operate other devices, see Chapter 3.

### To connect a DVI device, you will need:

- one HDMI-to-DVI adapter cable (HDMI type A connector) per DVI device
  - For proper operation, the length of an HDMI-to-DVI adapter cable should not exceed 9.8 ft (3m). The recommended length is 6.6 ft (2m).
- one pair of standard analog audio cables per DVI device
  - An HDMI-to-DVI adapter cable transfers video only. Separate analog audio cables are required (see illustration).
  - See “Setting the HDMI™ audio mode” (page 39).

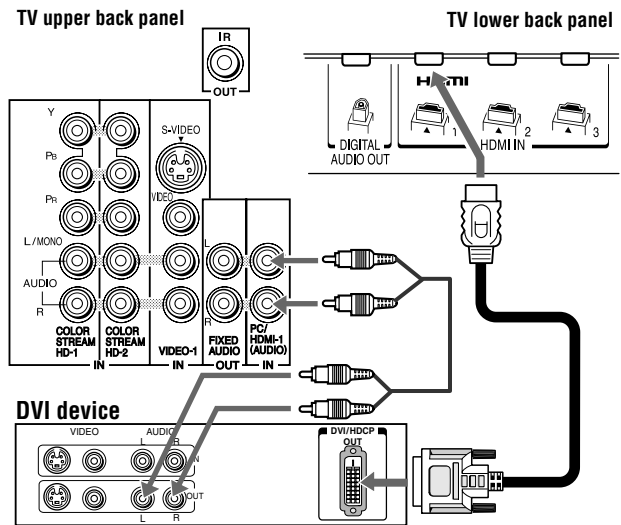

**Note:** To ensure that the HDMI or DVI device is reset properly, it is recommended that you follow these procedures:

- When turning on your electronic components, **turn on the TV first**, and then the HDMI or DVI device.
- When turning off your electronic components, **turn off the HDMI or DVI device first**, and then the TV.

[1] EIA/CEA-861-D compliance covers the transmission of uncompressed digital video with high-bandwidth digital content protection, which is being standardized for reception of high-definition video signals. Because this is an evolving technology, it is possible that some devices may not operate properly with the TV.

HDMI, the HDMI logo and High-Definition Multimedia Interface are trademarks or registered trademarks of HDMI Licensing LLC.



## REGZA-LINK connection

You can control the basic functions of connected audio/video devices using the TV's remote control if you connect a REGZA-LINK compatible audio receiver or playback device. For an explanation of setup and operations, see pages 57 and 58.

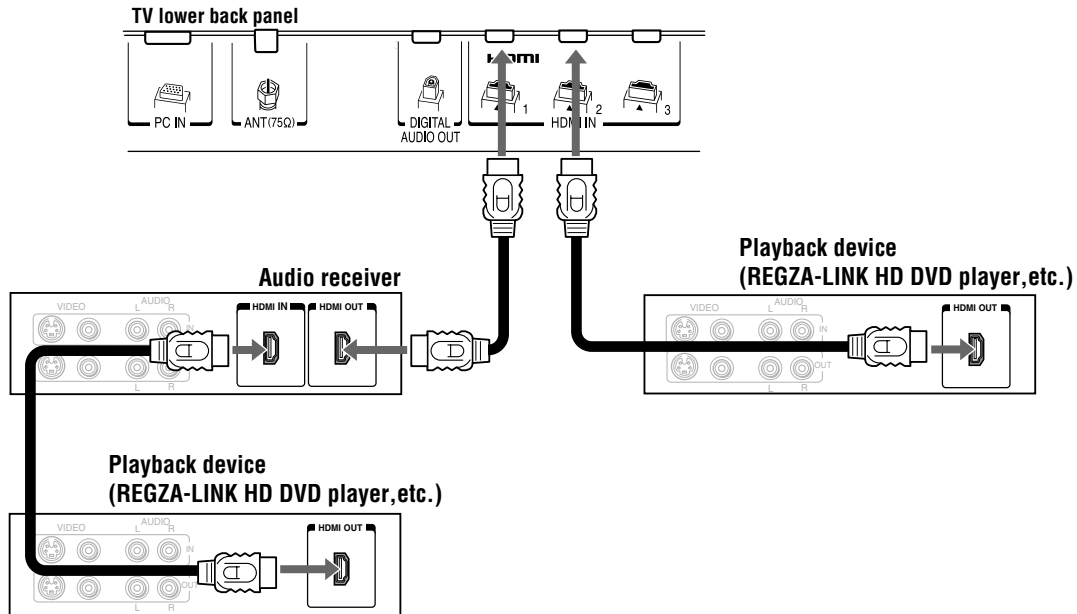

### To connect an Audio Receiver and Playback Devices, you will need:

- HDMI cables (☞ page 16)

#### Note:

- If several devices are connected, REGZA-LINK feature may not operate properly.
- For proper operation, it is recommended that you use HDMI cables with the HDMI Logo (HDMI).

### Before controlling the device(s):

- After completing the above connections, set the **REGZA-LINK Setup** menu as you desire (☞ page 59).
- The connected devices must also be set. For details, see the operation manual for each device.
- The REGZA-LINK feature uses the CEC technology as regulated by the HDMI standard.
- This feature is limited to models incorporating Toshiba's REGZA-LINK. However, Toshiba is not liable for those operations. Refer to the individual instruction manuals for compatibility information.

## Connecting a digital audio system

The TV's **DIGITAL AUDIO OUT** terminal outputs a Dolby®\* Digital  or 2-channel down-mixed PCM (pulse-code modulation) signal for use with an external Dolby® Digital decoder or other external audio system with optical audio input.

### You will need:

- optical audio cable (Use an optical audio cable that has the larger "TosLink" connector and not the smaller "mini-optical" connector.)

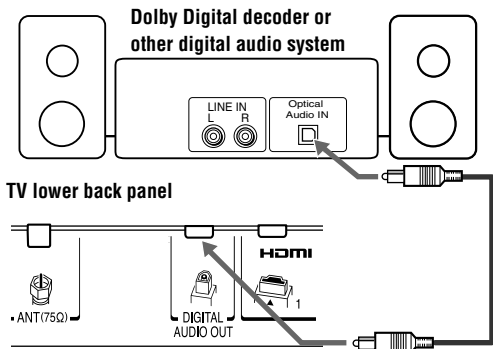

### To control the audio:

- Turn on the TV and the digital audio device.
- Press **MENU** on the TV's remote control and open the **Audio** menu.
- Highlight **Audio Setup** and press **ENTER**.

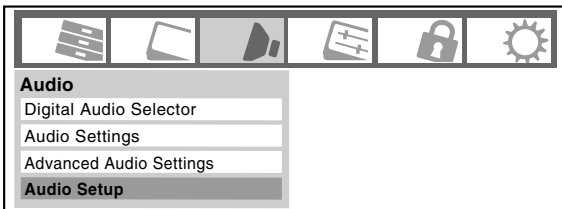

- In the **Optical Output Format** field, select either **Dolby Digital** or **PCM**, depending on your device (see "Selecting the optical audio output format" on page 52).

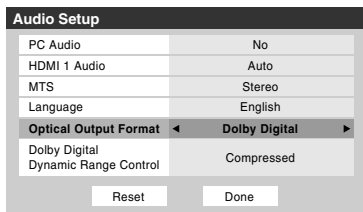

### Note:

- Some audio systems may not be compatible with Dolby Digital bitstream signals. Older audio systems that are not compatible with standard optical out signals may not work properly, creating a high noise level that may damage speakers or headphones. **THIS DAMAGE IS NOT COVERED BY YOUR WARRANTY.**
- The **DIGITAL AUDIO OUT** terminal may not output some digital audio sources because of copy restrictions.

\* Manufactured under license from Dolby Laboratories. Dolby, and the double-D symbol are registered trademarks of Dolby Laboratories.

## Connecting an audio system

This connection allows you to use external speakers with an external analog audio amplifier to adjust the sound level.

### You will need:

- standard audio cables

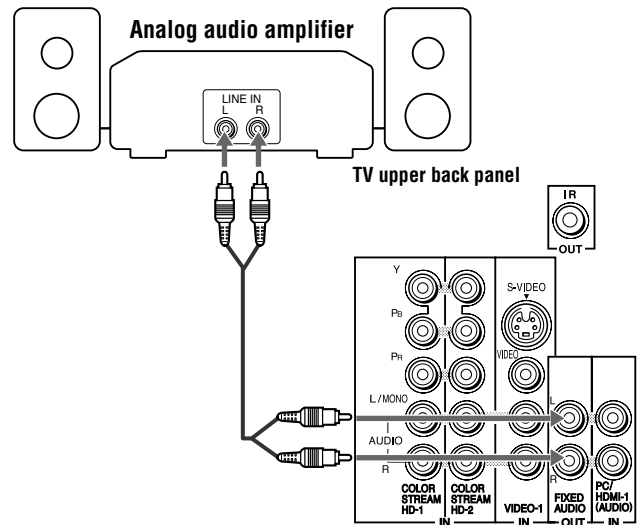

### To control the audio:

- Turn on the TV and the stereo amplifier.
- Minimize the sound volume from the TV's built-in speakers and control the volume level using the amplifier's remote control.

## Connecting a personal computer (PC)

With either the PC IN or HDMI connection, you can watch your computer's display on the TV and hear the sound from the TV's speakers.

### To connect a PC to the PC IN terminal on the TV:

When connecting a PC to the PC IN terminal on the TV, use an analog RGB (15-pin) computer cable and a PC audio cable.

#### TV upper back panel

#### TV lower back panel

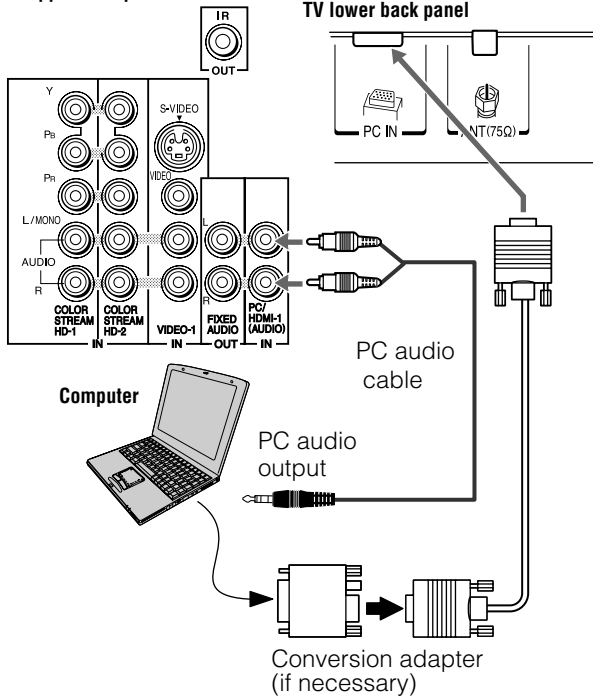

- To use a PC, set the monitor output resolution on the PC before connecting it to the TV. The PC IN terminal can accept and display VGA, SVGA, XGA, WXGA, and SXGA signal formats. For detailed signal specifications, see page 69.
- To display the optimum picture, use the PC setting feature (🔧 “Using the PC settings feature” on page 56).

#### Note:

- The PC audio input terminals on the TV are shared with the HDMI 1 analog audio input terminals (🔧 page 57).
- Some PC models cannot be connected to this TV.
- An adapter is not needed for computers with a compatible mini D-sub 15-pin terminal.
- Depending on the DVD's title and the specifications of the PC on which you are playing the DVD-Video, some scenes may be skipped or you may not be able to pause during multi-angle scenes.

- Signal names for mini D-sub 15-pin connector

Pin No.	Signal name	Pin No.	Signal name	Pin No.	Signal name
1	R	6	Ground	11	NC
2	G	7	Ground	12	NC
3	B	8	Ground	13	H-sync
4	NC *	9	NC	14	V-sync
5	NC	10	Ground	15	NC

\*NC=Not connected

### To connect a PC to the HDMI terminal on the TV:

When connecting a PC to the HDMI terminal on the TV, use an adapter cable and analog audio cables.

If connecting a PC with an HDMI terminal, use an HDMI cable (type A connector). Separate analog cables are not necessary (🔧 page 16).

#### TV upper back panel

#### TV lower back panel

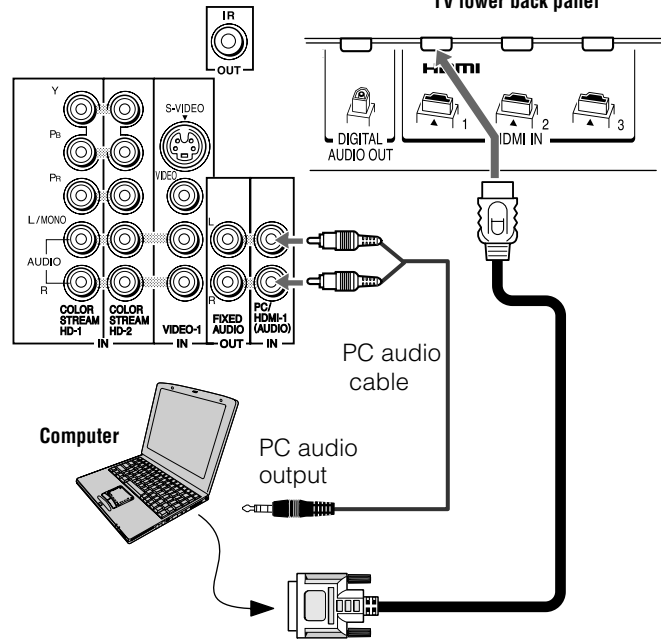

The HDMI input can accept and display VGA, SVGA, XGA, WXGA, SXGA, 480i (60Hz), 480p (60Hz), 720p (60Hz), 1080i (60Hz), and 1080p (24Hz/60Hz) signal formats. For detailed signal specifications, see page 69.

#### Note:

- The edges of the images may be hidden.
- If receiving a 480i (HDMI), 480p (HDMI), 720p, 1080i, or 1080p signal program, Native mode scales the video to display the entire picture within the borders of the screen (i.e. no overscanning).

## Chapter 3: Using the remote control

### Preparing the remote control for use

Your TV remote control can operate your TV and many other devices such as cable converter boxes, satellite receivers, VCRs, DVD players, and HTIBs (home theater in a box), even if they are different brands.

#### If you have a Toshiba device:

Your TV remote control is preprogrammed to operate most Toshiba devices (see page 24).

#### If you have a non-Toshiba device or a Toshiba device that the remote control is not preprogrammed to operate:

You can program the TV remote control so it will operate the other device (see pages 22–32).

### Installing the remote control batteries

- 1 Slide the battery cover off the back of the remote control.

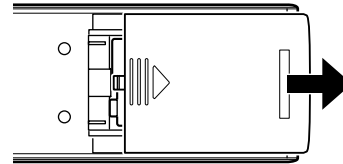

- 2 Install two “AA” size alkaline batteries. Match the + and – symbols on the batteries to the symbols on the battery compartment.

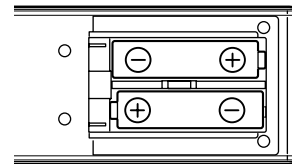

- 3 Slide the battery cover on to the remote control until the lock snaps.

**Caution:** Batteries must not be exposed to excessive heat such as sunshine, fire or the like.

#### Note:

- Be sure to use AA size alkaline batteries.
- Dispose of batteries in a designated disposal area.
- Batteries should always be disposed of with the environment in mind. Always dispose of batteries in accordance with applicable laws and regulations.
- If the remote control does not operate correctly, or if the operating range becomes reduced, replace batteries with new ones.
- When necessary to replace batteries in the remote control, always replace both batteries with new ones. Never mix battery types or use new and used batteries in combination.
- Always remove batteries from the remote control if they are dead or if the remote control is not to be used for an extended period of time. This will prevent battery acid from leaking into the battery compartment.

## Learning about the remote control

The buttons used for operating the TV only are described here. For the REGZA-LINK remote control functions, see the section “Using REGZA-LINK” (page 57). For a complete list of the remote control’s functions, see the remote control functional key chart (pages 22–23).

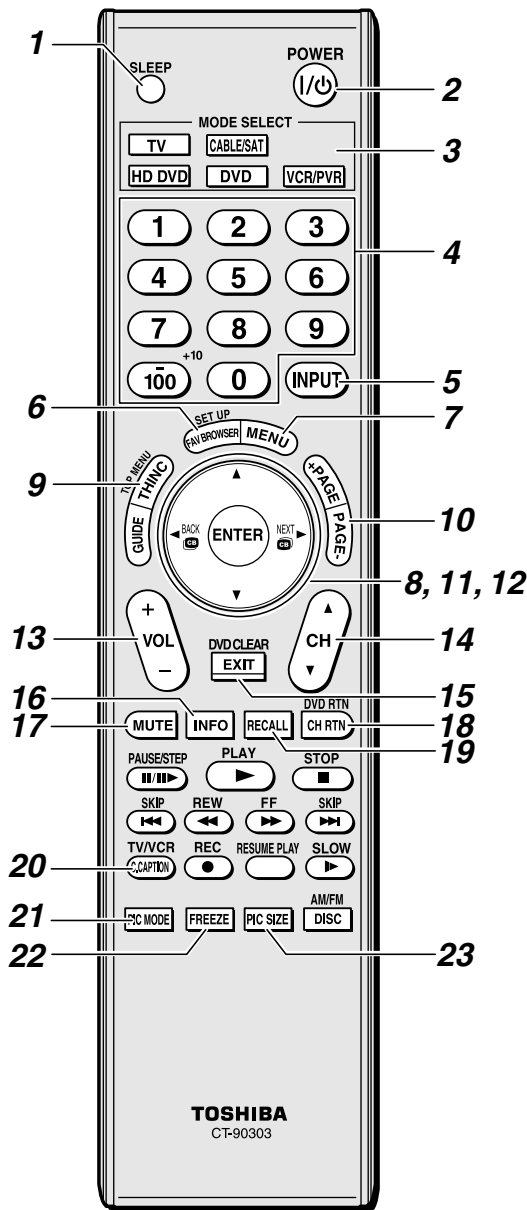

**Note:** The error message “Not Available” may appear if you press a key for a function that is not available.

- 1 **SLEEP** accesses the sleep timer (page 57).
- 2 **POWER** turns the TV on and off. When the TV is on, the blue LED indicator on the TV front will be illuminated.

- 3 **MODE SELECT** sets the five remote control device modes: **TV**, **CABLE/SAT**, **HD DVD**, **DVD**, and **VCR/PVR**. Press **TV** until the keypad blinks 3 times to control the TV. The selected **MODE** key blinks each time any key is pressed. (page 24). When the Auto Input feature is set, these keys can also be used to change inputs on the TV (page 37).
- 4 **Channel Numbers (0–9, –/100)** directly tune channels. The **100** button is used to tune digital channels (page 44) or to edit the Favorite List (page 42).
- 5 **INPUT** selects the video input source (page 41).
- 6 **FAV BROWSER** accesses the Favorites List in the Channel Browser™ (page 42).
- 7 **MENU** accesses the main TV menu system (pages 33 and 34).
- 8 **ENTER** activates highlighted items in the main menu system.
- 9 **THINC** accesses the THINC menu (page 33).
- 10 **PAGE + / -** are used for paging up and down in channel lists.
- 11 **BACK / NEXT** While watching TV, these buttons open the Channel Browser™ and tune to the previous/next channel in the channel history (page 43). (Also see “Arrow buttons.”)
- 12 **Arrow buttons (▲▼◀▶)** When a menu is on-screen, these buttons select or adjust programming menus. (Also see **BACK / NEXT**.)
- 13 **VOL + -** adjusts the volume level.
- 14 **CH ▲▼** cycles through programmed channels when no menu is on-screen (page 36).
- 15 **EXIT** closes on-screen menus.
- 16 **INFO** displays TV status information as well as program details, when available (page 60).
- 17 **MUTE** reduces or turns off the sound (page 50).
- 18 **CH RTN** returns to the last viewed channel or source (page 45).
- 19 **RECALL** displays TV status information (page 60).
- 20 **C.CAPTION (TV/VCR)** opens the closed caption/audio selector screen. (The audio selector is not available for analog channels.) (page 49.) By using this button, it is also possible to select TV mode and view one program while another is being recorded.
- 21 **PIC MODE** selects the picture mode (page 48).
- 22 **FREEZE** freezes the picture. Press again to restore the moving picture.
- 23 **PIC SIZE** cycles through the picture sizes: **Natural**, **TheaterWide 1/2/3**, **Full**, **4:3 HD**, **Native**, and **Dot by Dot** (page 45).

## Remote Control functional key chart

REMOTE CONTROL KEY	TV	CABLE/SAT		HD DVD		DVD		VCR/PVR	
	Toshiba TV	CABLE	SAT (satellite)	HD DVD Player	HD DVD Recorder	DVD/VCR (Orion)	DVD Player/Recorder	VCR (Toshiba)	PVR
SLEEP	(TV) Sleep	(TV) Sleep	(TV) Sleep	(TV) Sleep	(TV) Sleep	(TV) Sleep	(TV) Sleep	(TV) Sleep	(TV) Sleep
MODE SELECT	Remote control device mode selection								
POWER	Power	Power	Power	Power	Power	Power	Power	Power	Power
1	Digit 1	Digit 1	Digit 1	Digit 1	Digit 1	Digit 1	Digit 1	Digit 1	Digit 1
2	Digit 2	Digit 2	Digit 2	Digit 2	Digit 2	Digit 2	Digit 2	Digit 2	Digit 2
3	Digit 3	Digit 3	Digit 3	Digit 3	Digit 3	Digit 3	Digit 3	Digit 3	Digit 3
4	Digit 4	Digit 4	Digit 4	Digit 4	Digit 4	Digit 4	Digit 4	Digit 4	Digit 4
5	Digit 5	Digit 5	Digit 5	Digit 5	Digit 5	Digit 5	Digit 5	Digit 5	Digit 5
6	Digit 6	Digit 6	Digit 6	Digit 6	Digit 6	Digit 6	Digit 6	Digit 6	Digit 6
7	Digit 7	Digit 7	Digit 7	Digit 7	Digit 7	Digit 7	Digit 7	Digit 7	Digit 7
8	Digit 8	Digit 8	Digit 8	Digit 8	Digit 8	Digit 8	Digit 8	Digit 8	Digit 8
9	Digit 9	Digit 9	Digit 9	Digit 9	Digit 9	Digit 9	Digit 9	Digit 9	Digit 9
0	Digit 0	Digit 0	Digit 0	Digit 0	Digit 0	Digit 0	Digit 0	Digit 0	Digit 0
100/-/+10	- (digital separator)	----	- (sub CH)	10	10	- (digital separator)	- (digital separator)	100	----
INPUT	(TV) Input	(TV) Input	(TV) Input	(TV) Input	(TV) Input	(TV) Input	(TV) Input	(TV) Input	(TV) Input
▲	Menu select up	Menu select up	Menu select up	Menu select up	Menu select up	Menu select up	Menu select up	----	Menu select up
▼	Menu select down	Menu select down	Menu select down	Menu select down	Menu select down	Menu select down	Menu select down	----	Menu select down
	Menu select left/right/ Back Next	Menu select left/right	Menu select left/right	Menu select left/right	Menu select left/right	Menu select left/right	Menu select left/right	----	Menu select left/right
ENTER	Enter	Enter	Select/Enter	Enter	Enter	Enter	Enter	----	Enter
FAV BROWSER/SETUP	FAV BROWSER	----	----	DVD setup	DVD setup	DVD setup	DVD setup	----	----
MENU	Menu	Cable menu	Action, menu	DVD menu	DVD menu	DVD menu	DVD menu	----	Menu
THINC/TOP MENU	THINC	THINC	THINC	Top menu	Top menu	Top menu	Top menu	THINC	THINC
GUIDE	Guide	Cable Guide	SAT Guide	----	----	DVD TV Guide	DVD TV Guide	----	Guide
PAGE +/-	Page up/down	Cable page up/down	Guide page up/down	Page up/down	----	Guide page up/down	Guide page up/down	----	----
VOL▲/▼	Volume up/down*1	Volume up/down*1	Volume up/down*1	(TV) Volume up/down	(TV) Volume up/down	Volume up/down*1	Volume up/down*1	Volume up/down*1	Volume up/down*1
CH▲/▼	Channel up/down	Channel up/down	Channel up/down	----	Channel up/down	DVD Channel up/down	DVD Channel up/down	Channel up/down	Channel up/down
EXIT/DVD CLEAR	Exit	Exit	Exit	DVD clear	DVD clear	DVD clear	DVD clear	----	Exit
MUTE	Mute*1	Mute*1	Mute*1	(TV) Mute*1	(TV) Mute*1	Mute*1	Mute*1	Mute*1	Mute*1
INFO	Guide Info	Info	Info	Display	Display	Display	Display	----	Info
RECALL	(TV) Display	(TV) Display	(TV) Display	(TV) Display	(TV) Display	(TV) Display	(TV) Display	(TV) Display	(TV) Display

### Chapter 3: Using the remote control

REMOTE CONTROL KEY	TV	CABLE/SAT		HD DVD		DVD		VCR/PVR	
	Toshiba TV	CABLE	SAT (satellite)	HD DVD Player	HD DVD Recorder	DVD/VCR (Orion)	DVD Player/Recorder	VCR (Toshiba)	PVR
CH RTN/ DVD RTN	Last Channel	Last Channel	Last Channel	DVD RTN	DVD RTN	DVD RTN	DVD RTN	----	----
PAUSE/ STEP	Pause	Cable Pause	SAT Pause	Pause/Step	Pause	Pause	Pause	Pause	Pause
PLAY	Play	Cable Play	SAT Play	Play	Play	Play	Play	Play	Play
STOP	Stop	Cable Stop	SAT Stop	Stop	Stop	Stop	Stop	Stop	Stop
SKIP -	SkipREW/ Day -	----	----	Skip REW	Skip REW	Skip REW	Skip REW	----	----
SKIP +	SkipFWD/ Day +	----	----	Skip FWD	Skip FWD	Skip FWD	Skip FWD	----	----
REW	Rewind	Cable Rewind	SAT Rewind	Rewind	Rewind	Rewind	Rewind	Rewind	Rewind
FF	FF	Cable FF	SAT FF	Fast FWD	Fast FWD	FWD	FWD	FWD	FWD
C.CAPTION/ TV/VCR	C.Caption	----	TV/SAT	----	----	TV/VCR	----	TV/VCR	Reverse
REC	REC menu (Single click)	Cable Record (Double click)	SAT Record (Double click)	----	Record (Double click)	Record (Double click)	DVD Record (Double click) <sup>*2</sup>	Record (Double click)	Record (Double click)
RESUME PLAY	----	----	----	Resume Play	Resume Play	----	----	----	----
SLOW/DIR +	Slow/Dir +	----	----	Slow FWD	Slow FWD	Slow FWD	Slow FWD	Slow FWD	Slow FWD
PIC MODE	(TV) Picture mode	(TV) Picture mode	(TV) Picture mode	(TV) Picture mode	(TV) Picture mode	(TV) Picture mode	(TV) Picture mode	(TV) Picture mode	(TV) Picture mode
FREEZE	(TV) Freeze	(TV) Freeze	(TV) Freeze	(TV) Freeze	(TV) Freeze	(TV) Freeze	(TV) Freeze	(TV) Freeze	(TV) Freeze
PIC SIZE	(TV) Picture size	(TV) Picture size	(TV) Picture size	(TV) Picture size	(TV) Picture size	(TV) Picture size	(TV) Picture size	(TV) Picture size	(TV) Picture size
DISC/AM/ FM	----	----	----	----	----	DVD/VCR	----	----	Replay

**Note:**

- “----” = key does not send a signal in that remote control mode.

\*1 Volume will affect the TV by default. When the volume is unlocked, all the devices will have their own volume if their ID has volume data. See “Using the volume lock feature” (page 25).

\*2 DVD : REC is only for DVD Recorder, no function is picked for DVD Player.

## Using the remote control to operate your other devices

Your TV remote control has one dedicated TV mode and four programmable multi-brand modes: **CABLE/SAT**, **HD DVD**, **DVD**, and **VCR/PVR**. The default device modes and programmable device modes are listed below.

**Note:** The TV remote control is preprogrammed to operate most Toshiba devices. To operate a non-Toshiba device or a Toshiba device that the remote control is not preprogrammed to operate, you will need to program the remote control. See "Programming the remote control to operate your other devices" (at right).

MODE SELECT	Default device mode control (before programming)
-------------	--

TV	Toshiba TV
CABLE/SAT	Toshiba Satellite receiver
HD DVD	Toshiba HD DVD Player
DVD	Orion DVD
VCR/PVR	Toshiba VCR

MODE SELECT	Device mode control after programming
-------------	---------------------------------------

TV	Toshiba TV
CABLE/SAT	
HD DVD	Multi-brand video/audio devices
DVD	
VCR/PVR	

**Note:** Although your new TV's remote control includes codes for many devices, it may not include codes for some or all of the features on certain devices you wish to control. If you are unable to program the TV's remote control to operate your device or some of the features on that device, use the device's remote control or the controls on the device.

## Programming the remote control to operate your other devices

### Device code setup

- Find the code for your device brand in the remote control device code table on pages 26–32.  
If more than one code is listed, try each one separately until you find one that works.
- Press the applicable mode select button (**CABLE/SAT**, **HD DVD**, **DVD**, or **VCR/PVR**), until the mode select button blinks 3 times.
- While holding down **RECALL**, press the five-digit device code for your device.
  - If a valid code is entered, the mode select button will blink twice.
  - If an invalid code is entered, the mode select button will blink one long blink.
- Point the remote control at the device and press **POWER** to test the code.
  - If the device responds to the remote control, you have entered the correct code.
  - If the device does not respond to the remote control, repeat steps 3 and 4 using another code.
- To control the TV, press the "TV" mode select button.

#### Note:

- Although the TV remote control includes codes for many devices, it may not include codes for some or all of the features on certain devices you want to control. If you are unable to program the TV remote control to operate your device or some of the features on that device, use the device's original remote control (or the control buttons on the device).
- Every time you change the batteries you will need to reprogram the remote control.
- Some newer VCRs respond to either of two codes. These VCRs have a switch labeled "VCR1/VCR2." If your VCR has this kind of switch and does not respond to the codes for your VCR brand, set the switch to the other position ("VCR1" or "VCR2") and reprogram the remote control.



## Searching and sampling the code of a device (8500)

If you do not know the device code for a particular device, you can cycle the remote control through the available codes for that device mode and sample the functions to find the code that operates the target device. The keys available to be sampled, provided they are applicable to that mode, are **POWER**, 1, **VOL**, **CH**, and **PLAY**. Invalid keys will be ignored while in program mode.

### To cycle through each available device code and sample its functions:

- 1** Press the appropriate mode select button on the remote control.
  - 2** While holding down **RECALL**, press 8, 5, 0, 0. The remote control will enter program mode.
  - 3** Point the remote control at the target device and press **POWER** (or other function buttons that are available to be sampled).
  - 4** If the device responds to the remote control:
    - Press **RECALL** to store the device code. The mode select button will blink two times and the remote control will exit the program mode.
- If the device does not respond to the remote control:
- Press **▲**, and then press **POWER**. Repeat this step until the device responds to the remote control, and then press **RECALL**.

**Note:** When a search cycle is completed, the mode select button will blink three times. The remote control will begin to cycle through the available codes again. If no key is pressed within 10 seconds during programming, the remote control will exit the program mode and return to the previous code.

## Using the volume lock feature (8000)

By default (factory setting), the remote control's volume keys (**VOL** and **MUTE**) are locked to the "TV" device mode.

The remote control will operate the TV's volume, even when "TV" is not the current device mode.

If you unlock the remote control's volume keys, each device mode will have its own volume (if the device ID has volume data). The remote control will operate the volume of the device associated with the current device mode.

If you lock the remote control's volume keys to a specific device mode, the remote control will operate the volume of the device associated with the locked mode, even when the locked mode is not the current device mode.

See "Using the remote control to operate your other devices" on page 24.

### To lock the remote control's volume keys to a specific mode (CABLE/SAT in this example):

- 1** Press CABLE/SAT.
- 2** While holding down the **RECALL** button, press 8, 0, 0, 0.
- 3** Press **VOL**. The CABLE/SAT mode select button will blink two times (locked).
  - The remote control's volume keys will now operate the volume of the device associated with the CABLE/SAT mode, even when CABLE/SAT is not the current device mode.

### To unlock the remote control's volume keys:

- 1** While holding down **RECALL**, press 8, 0, 0, 0.
- 2** Press **VOL**. The CABLE/SAT mode select button will blink four times.
  - The CABLE/SAT mode will be unlocked.

## Operational feature reset (8900)

This feature clears all programmed remote control features not related to "Device code setup" and resets the volume lock to the "TV" device mode.

### To reset the remote control:

While holding down **RECALL**, press 8, 9, 0, 0. The mode select button will respond with four blinks.

## Multi-brand remote control device codes

### TVs

Brand	Code
Toshiba	01524

### Cable boxes

Brand	Code
A-Mark	10008, 10144
ABC	10237, 10003, 10008, 10014, 10017
Accuphase	10003, 10014, 10017
Acorn	10237
Action	10237
Active	10237
Americast	10899
Amino	11822
Archer	10237
BCC	10276
Bell & Howell	10014
Bell South	10899
British Telecom	10003
Century	10008
Citation	10017
Clearmaster	10883
ClearMax	10883
Cool Box	10883
Coolmax	10883
Digeo	11187
Digi	10637
Director	10476
Dumont	10637
Emerson	10014
Fosgate	10276
GE	10144
General Instrument	10476, 10810, 10276, 10003, 10012, 10014
Gibraltar	10003
GMI	10883
GoldStar	10144
Hamlin	10009, 10273
Hitachi	10003, 10008, 10009
Insight	10476, 10810
Jebsee	10014
Jerrold	10476, 10810, 10276, 10003, 10012, 10014
Memorex	10000
Mitsubishi	10003
Motorola	11376, 10476, 10810, 10276, 11187, 11254, 10014, 11106
Multitech	10883
Myrio	11822
Nova Vision	10008
Novaplex	10008, 10017

NSC	10012, 10637
Oak	10017
Pace	11877, 10877, 10237, 10008
Panasonic	10000, 10008, 10144, 10107
Panther	10637
Paragon	10000, 10008, 10525
Penney	10000, 10637
Philips	11305, 10317
Pioneer	11877, 10877, 10144, 10533
Prism	10012
Pulsar	10000
Quasar	10000
RadioShack	10883
RCA	11256
Regal	10276, 10279, 10273
Runco	10000
Samsung	10003, 10144
Scientific Atlanta	11877, 10877, 10477, 10237, 10003, 10000, 10008, 10012, 10017
Sony	11006
Sprucer	10144
Starcom	10003, 10014
Stargate	10014
Storm	10637
Supercable	10276
Supermax	10883
Thomson	11256
Tocom	10012
Torx	10003
Toshiba	10000
Tristar	10883
United Cable	10276, 10003, 10014
US Electronics	10276, 10003, 10008, 10017
V2	10883
Videoway	10000
Viewmaster	10883
Vision	10883
Vortex View	10883
Zenith	10000, 10525, 10899, 10017

### Satellite receivers

Brand	Code
AlphaStar	10772
Bell ExpressVu	10775
Chaparral	10216
Coolsat	11806
Crossdigital	11109

DirecTV	11377, 10392, 10566, 10639, 11639, 11142, 10247, 10749, 11749, 10724, 10819, 11856, 11076, 11108, 10099, 11109, 11414, 11442, 11609, 11392, 11640
Dish Network System	11505, 11005, 10775, 11170, 11775
Dishpro	11505, 11005, 10775, 11775
Echostar	11505, 11005, 10775, 11170, 11775
Expressvu	10775, 11775
Fortec Star	11821
Funai	11377
GE	10392, 10566
General Instrument	10869
GOI	10775, 11775
Hitachi	10749, 10819
Houston	10775
HTS	10775, 11775
Hughes Network Systems	11142, 10749, 11749, 11442
Humax	11790
Innova	10099
Jerrold	10869
JVC	10775, 11170, 11775
LG	11226, 11414
Magnavox	10724, 10722
McIntosh	10869
Memorex	10724
Mitsubishi	10749
Motorola	10869
Netsat	10099
Next Level	10869
Optimus	10724
Panasonic	10247, 10701
Pansat	11807
Paysat	10724
Philips	11142, 10749, 11749, 10775, 10724, 10819, 11076, 10722, 10099, 11442
Pioneer	11142, 11442
Primestar	10869
Proscan	10392, 10566
RadioShack	10566, 10775, 10869
RCA	10392, 10566, 11142, 10775, 10855, 10143, 11392, 11442
Samsung	11377, 11142, 11276, 11108, 11109, 11442, 11609
SKY	10099
Sony	10639, 11639, 11640

### Chapter 3: Using the remote control

Star Choice	10869
Star Trak	10772, 10869
Thomson	10392, 10566
Tivo	11142, 11442
Toshiba	10749, 11749, 10790, 10819, 11285, 11286, 11287, 11289, 11857, 11858
UltimateTV	11392, 11640
Ultrasat	11806
Uniden	10724, 10722
Voom	10869
Zenith	11856

### DVDs

Brand	Code
3D LAB	20503, 20539
Accurian	21072, 21416
Advent	21016
Afreedy	20698
Aiwa	20641
Akai	20695, 20705, 20770, 20899, 21089
Alba	20672, 20717
Alco	20790
Allegro	20869
Apex Digital	20533, 20672, 20717, 20755, 20794, 20796, 20797, 20830, 21004, 21020, 21056, 21061, 21100
Arrgo	21023
Aspire Digital	21168, 21407
Audiovox	20717, 20790, 21041, 21071, 21072, 21121, 21122
Axion	21071, 21072
Blaupunkt	20717
Blue Parade	20571
Blue Sky	20695
Bose	21895
Brandt	20651
Broksonic	20695, 20868
California Audio Labs	20490
Celestial	21020
Centrex	20672, 21004
Cinea	20831
CineVision	20876, 20833, 20869
Citizen	21003, 21277
Clairtone	20571
Coby	20778, 21086, 21107, 21177
Craig	20831
Creative	20503, 20539
Curtis Mathes	21087
CyberHome	20816, 20874, 21023, 21024, 21117, 21129, 21502
Cytron	20705

Daewoo	20784, 20705, 20770, 20833, 20869, 21169, 21172, 21234, 21242
Dansai	20770
Decca	20770
Denon	20490, 20634
Denver	20778
Desay	21407
Digitrex	20672
Disney	20675, 21270
DiViDo	20705
Dual	20675, 21068
Durabrand	21127
DVD2000	20521
Electrohome	21003
Emerson	20591, 20675, 20821, 21268
Enterprise	20591
Entivo	20503, 20539
Enzer	20770
ESA	20821, 21268
Firstline	20651
Fisher	20670
Funai	20675, 21268, 21334
Gateway	21073, 21158
GE	20522, 20815, 20717
Go Video	20573, 20744, 20717, 20715, 20741, 20783, 20833, 20869, 21044, 21075, 21099, 21158, 21304, 21730
Go Vision	21071, 21072
GoldStar	20741, 20801, 20869
Goodmans	20790
Gradiente	20490, 20651
Greenhill	20717
Grundig	20539, 20705
Harman/Kardon	20582, 20702
Hitachi	20573, 20664, 21247
Hiteker	20672
Humax	21588
iLo	21348
Initial	20717
Insignia	21268
Integra	20571, 20627
IRT	20783
JBL	20702
Jensen	21016
JMB	20695
JVC	20558, 20623, 20867, 21164
Kawasaki	20790
Kenwood	20490, 20534
KLH	20717, 20790, 21020, 21149
Kloss	20533
Koss	20651, 21061
Lasonic	20627, 20798
Lecson	21533

Lenoxx	21127
LG	20591, 20741, 20801, 20869
LiteOn	21058, 21158, 21416, 21440
Loewe	20511, 20741
Logix	20783
Magnasonic	20651, 20675
Magnavox	20503, 20539, 20646, 20675, 20821, 21268
Marantz	20503, 20539, 20675
McIntosh	21533
Medion	20651
Memorex	20695, 20831, 21270
Microsoft	20522, 21708
Minato	20752
Mintek	20839, 20717
Mitsubishi	21521, 20521
NAD	20591, 20741
Naiko	20770
NEC	20785, 20869
Nesa	20717
NexxTech	21402
Norcent	21003, 21107, 21265
Onkyo	20503, 20627, 20792, 21769
Optimus	20571
Orion	21854
Oritron	20651
Palsonic	20672
Panasonic	20503, 20490, 20571, 20703, 21362, 21462, 21490, 21762
Philips	20503, 20539, 20646, 20675, 20854, 21260, 21267, 21354
PianoDisc	21024
Pioneer	20525, 20571, 20631
Polaroid	21020, 21061, 21086
PolkAudio	20539
Portland	20770
Presidian	20675, 21072
Prima	21016
Proceed	20672
Proscan	20522
ProVision	20778
Qwestar	20651
Radionette	20741
RadioShack	20571
RCA	20522, 20571, 20717, 20790, 20822, 21022, 21132, 21769
Realistic	20571
Reoc	20752
Rio	20869
Rotel	20623
Rowa	21004
Saba	20651

(continued)

Sampo	20698, 20752
Samsung	20490, 20573, 20744, 20820, 20899, 21044, 21075
Sansui	20695
Sanyo	20670, 20675, 20695, 20873, 21334
Schneider	20783
Schwaiger	20752
Sensory Science	21158
Sharp	20630, 20675, 20752, 21256
Sharper Image	21117
Sherwood	20770, 21043
Shinsonic	20533, 20839
Slim Art	20784
Sonic Blue	20573, 20715, 20783, 20869, 21099
Sony	20533, 21533, 20864, 21033, 21070, 21431
Sova	21122
Superscan	20821
SVA	20717
Sylvania	20675, 20821, 21268
Symphonic	20675, 20821, 21268, 21334
Tatung	20770
Teac	20571, 20717, 20790
Technics	20490, 20703
Technika	20770
Tevion	20651
Theta Digital	20571
Thomson	20522, 20511
Tivo	21503, 21588
Toshiba	20503, 20573, 20539, 20695, 21045, 21154, 21503, 21515, 21588, 21769, 21854
Unimax	20770
Universum	20591
Urban Concepts	20503, 20539
US Logic	20839
V	21064, 21226
Venturer	20790
Visio	21064, 21226
Vizio	21064, 21226
Xbox	20522, 21708
Yamaha	20490, 20539, 20545
Zenith	20503, 20591, 20741, 20869
Zeus	20784
Zoece	21265

### HD DVDs

Brand	Code
LG	60741
Onkyo	61769

RCA	61769
Toshiba	61510, 61515, 61769

### DVD-R

Brand	Code
Accurian	21416
Apex Digital	21056
Aspire Digital	21168
Coby	21086
CyberHome	21129, 21502
Funai	20675, 21334
Gateway	21073, 21158
Go Video	20741, 21158, 21304, 21730
iLo	21348
JVC	21164
LG	20741
LiteOn	21158, 21416, 21440
Magnavox	20646, 20675
Panasonic	20490
Philips	20646
Pioneer	20631
Polaroid	21086
RCA	20522
Samsung	20490
Sensory Science	21158
Sharp	20675
Sony	21033, 21070, 21431
Sylvania	20675
Toshiba	21510
Zenith	20741

### DVD/VCR Combo

Brand	Code
Allegro	20869
Apex Digital	21061
Broksonic	20695
CineVision	20833, 20869
Daewoo	20833, 20869
Emerson	20675
Funai	20675
Go Video	20744, 20715, 20741, 20833, 20869, 21044, 21075
GoldStar	20741
Hitachi	20664
JVC	20867, 21164
LG	20741
Magnavox	20675
Memorex	20695
Panasonic	21762
Philips	20675, 21267
Polaroid	21061
Presidian	20675
RCA	20522, 20822
Samsung	20820, 21044, 21075
Sansui	20695
Sanyo	20670, 20873
Sharp	20630

Sony	20864, 21033, 21070, 21431
Sylvania	20675
Symphonic	20675
Toshiba	20503, 21854
Zenith	20741, 20869
Emerson	31593
Funai	31593
Hitachi	30000
Magnavox	31593
Presidian	31593
RCA	30060
Sanyo	30104
Sharp	30848
Sylvania	30000, 30593, 31593
Symphonic	30000, 31593
Toshiba	41788

### VCRs

Brand	Code
A-Mark	30037, 30240, 30000, 30278, 30046
ABS	31972
Admiral	30060, 30048, 30039, 30047, 30104, 30209, 30020, 30062, 30479
Adventura	30037, 30240, 30000
Adyson	30072
Aiko	30278
Aiwa	30037, 30000, 30124, 30307
Akai	30041, 30061, 30106, 30175
Alba	30209, 30072, 30278
Alienware	31972
Allegro	30039
America Action	30278
American High	30035, 30081
Amstrad	30000
Asha	30240
Astra	30035, 30240
Audiovox	30037, 30278, 30038
Avis	30000, 30072
Beaumarck	30240
Bell & Howell	30035, 30048, 30039, 30000, 30104, 30046, 30479
Broksonic	30184, 30121, 30209, 30002, 30208, 30479, 31479
Calix	30037
Candle	30037, 30038
Canon	30035
Capehart	30002, 30020, 30062
Carrera	30240
Carver	30035, 30081

### Chapter 3: Using the remote control

CCE	30072, 30278	Gemini	30060	Magnavox	30035, 30037, 30048, 30039, 30081, 30240, 30000, 30149, 30563, 30593, 30618, 31593, 31781
Cineral	30278	Genexxa	30037, 30000, 30278	Magnin	30240
Citizen	30035, 30037, 30240, 30000, 30209, 30278, 30479, 31278	Go Video	30240, 30432, 30526, 30614	Marantz	30035, 30081, 30038, 30062
Classic	30037	GoldStar	30035, 30037, 30039, 30000, 30278, 30038, 31237	Marta	30037
Colortyme	30060, 30035, 30045, 30278	Goodmans	30037, 30081, 30000, 30072, 30278, 30020, 30062	Matsui	30037, 30209
Colt	30000, 30072	Gradiente	30000, 30008	Matsushita	30035, 30162, 30081, 31162
Craig	30037, 30047, 30240, 30072, 30271	Granada	30081, 30042	Media Center PC	31972
Criterion	30000, 30072	Grundig	30081	MEI	30035
Crosley	30035, 30081, 30000, 30149	Harley Davidson	30000	Memorex	30035, 30162, 30037, 30048, 30039, 30047, 30240, 30000, 30104, 30209, 30072, 30278, 30062, 30046, 30307, 30479, 31037, 31162, 31237, 31262
Crown	30072, 30278	Harman/Kardon	30081, 30038	Metz	30037
Curtis Mathes	30060, 30035, 30162, 30240, 30000, 30041, 30278, 30432, 30760, 31035	Harvard	30072	MGA	30060, 30240, 30043, 30061
Cybernex	30240	Harwood	30072	MGN Technology	30240
CyberPower	31972	Headquarter	30046	Microsoft	31972
Daewoo	30037, 30045, 30278, 30020, 30046, 30561, 31278	Hewlett Packard	31972	Midland	30240
Daytron	30037, 30278, 30020	HI-Q	30035, 30047, 30000	Mind	31972
Dell	31972	Hitachi	30035, 30037, 30045, 30000, 30042, 30041, 30089, 30105	Minolta	30042, 30105
Denon	30081, 30042	Howard Computers	31972	Mitsubishi	30060, 30048, 30047, 30000, 30042, 30067, 30043, 30041, 30061, 30807
Derwent	30041	HP	31972	Motorola	30035, 30048
DirecTV	30739	Hughes Network Systems	30042, 30739	Movie Walker	30072
Dual	30000	Humax	30739	MTC	30240, 30000, 30072
Durabrand	30039, 30038	Hush	31972	MTX	30000
Dynatech	30240, 30000	Hytek	30047, 30000, 30072	Multitech	30039, 30000, 30072
Electrohome	30060, 30037, 30240, 30000, 30043, 30209, 30061	iBUYPOWER	31972	NAD	30240, 30104
Electrophonic	30037	ITT Nokia	30240, 30041	NEC	30104, 30067, 30041, 30038
Emerald	30184, 30121	Janeil	30240	New Tech	30072
Emerex	30032	Jensen	30067, 30041	Nikko	30037, 30278
Emerson	30037, 30184, 30240, 30000, 30121, 30043, 30209, 30002, 30278, 30202, 30208, 30061, 30479, 30561, 30593, 31278, 31479, 31593	JVC	30067, 30041, 30008, 30061, 31162	Nikkodo	30037, 30278
Fisher	30039, 30047, 30000, 30104, 30046	KEC	30037, 30278	Nishi	30240
Fuji	30035, 30033	Kenwood	30067, 30041, 30038, 30046 30072	Niveus Media	31972
Fujitsu	30000	KLH	30072	Noblex	30240
Funai	30037, 30000, 30072, 30278, 30593, 31593	Kodak	30035, 30037	Northgate	31972
Garrard	30000	KTV	30000	Olympus	30035, 30162, 30104
Gateway	31972	LG	30037, 30240, 30038, 31037	Onkyo	30222
GE	30060, 30035, 30048, 30240, 30000, 30149, 30202, 30760, 30807, 31035, 31060	Linksys	31972	Optimus	31062, 30035, 30162, 30037, 30048, 30047, 30240, 30000, 30104, 30062, 30432, 30593, 31048, 31162, 31262
		Lloyd's	30240, 30000, 30072, 30038, 30208	Optonica	30062
		Loewe	30081		
		Logik	30240, 30000, 30072		
		Lumatron	30278		
		Luxor	30046, 30106		
		LXI	30037, 30000, 30042, 30067		
		M Electronic	30240		
		Magnasonic	30037, 30240, 30000, 30072, 30278, 30020, 30593, 31278		

(continued)

### Chapter 3: Using the remote control

Orion	30184, 30240, 30000, 30104, 30121, 30209, 30002, 30278, 30208, 30479, 31479	Realistic	30035, 30162, 30037, 30048, 30047, 30240, 30000, 30104, 30121, 30278, 30046, 30062, 31162	Sylvania	30035, 30081, 30000, 30043, 30593, 31593, 31781
Panama	30035	ReplayTV	30614, 30616	Symphonic	30240, 30000, 30002, 30593, 31593
Panasonic	31062, 30035, 30162, 30000, 30020, 30225, 30614, 30616, 31035, 31162, 31262	Ricavision	31972	Systemax	31972
Penney	30035, 30162, 30037, 30047, 30081, 30240, 30000, 30042, 30067, 30038, 31035, 31237	Runco	30039	Tagar Systems	31972
Pentax	30042, 30105	Samsung	30060, 30240, 30045, 30000, 30038, 30432, 30739, 31014	Tandy	30000, 30104
Philco	30035, 30081, 30000, 30209, 30479	Samtron	30240	Tatung	30048, 30081, 30000, 30067, 30041, 30008
Philips	30035, 30162, 30048, 30081, 30045, 30000, 30209, 30062, 30616, 30618, 30739, 31081, 31181	Sanky	30048, 30039	Teac	30000, 30067, 30041
Pilot	30037	Sansui	30240, 30000, 30067, 30209, 30041, 30072, 30002, 30271, 30479, 31479	Technics	30035, 30162, 30037, 30000
Pioneer	30162, 30081, 30042, 30067	Sanyo	30047, 30240, 30000, 30104, 30046, 30159, 30479	Teknika	30035, 30037, 30000
Polk Audio	30081	Scientific Atlanta	30008	Telecorder	30240
Portland	30278, 30020	Scott	30184, 30045, 30121, 30043, 30208, 30210	Telefunken	30041, 30208
Presidian	31593	Sears	30060, 30035, 30162, 30037, 30048, 30039, 30047, 30033, 30045, 30000, 30042, 30104, 30067, 30043, 30209, 30041, 30072, 30046, 30105, 31237	Tevion	30479
Profitronic	30240	Sharp	30048, 30047, 30032, 30000, 30062, 30807, 30848	Thomas	30000, 30002
Proscan	30060, 30202, 30760, 31060	Shintom	30039, 30240, 30000, 30072, 30208	Thomson	30060, 30041, 30202
Protec	30000, 30072	Shogun	30240	Tisonic	30278
Protech	30072	Siemens	30037, 30104	Tivo	30618, 30636, 30739, 31996
Pulsar	30039, 30240, 30278	Signature	30060, 30035, 30037, 30048, 30000, 30149, 30046, 30479	TMK	30240, 30000, 30208
Pulser	30240	Singer	30037, 30240, 30072	TNIX	30037
Quarter	30046	Sonic Blue	30614, 30616	Tocom	30240
Quartz	30035, 30047, 30046	Sonographe	30046	Toshiba	30240, 30045, 30000, 30043, 30209, 30041, 30062, 30210, 30845, 31008, 31145, 31972, 31996
Quasar	30035, 30162, 30002, 31035, 31162	Sony	30035, 30047, 30032, 30033, 30000, 30067, 30046, 30636, 31032, 31232, 31972	Tosonic	30278
RadioShack	30035, 30162, 30037, 30048, 30047, 30240, 30000, 30104, 30046, 30062, 31037, 31162	Soundmaster	30000	Totevision	30037, 30240
Radix	30037	Stack 9	31972	Touch	31972
Randex	30037	STS	30042, 30105	Trix	30037
RCA	30060, 30035, 30048, 30240, 30045, 30000, 30042, 30149, 30105, 30106, 30202, 30760, 30807, 30880, 31035, 31060	SV2000	30000, 30072	Ultra	30045, 30278, 30020
		SVA	30000	Unitech	30240
				Vector	30045
				Vector Research	30184, 30038
				Vextra	30072
				Victor	30067, 30041, 30008
				Video Concepts	30045, 30061, 30210
				Videomagic	30037
				Videosonic	30240, 30000, 30072
				Viewsonic	31972
				Villain	30000
				Voodoo	31972
				Wards	30060, 30035, 30037, 30048, 30047, 30081, 30033, 30240, 30045, 30000, 30042, 30043, 30041, 30072, 30038, 30149, 30046, 30062, 30479, 30760

Wharfedale	30593
White Westinghouse	30000, 30209, 30072, 30278, 30479
World	30209, 30002, 30479
XR-1000	30035, 30240, 30000, 30072, 30208
Yamaha	30041, 30038
Zenith	30037, 30039, 30033, 30000, 30209, 30041, 30278, 30479, 31139, 31479
ZT Group	31972

### PVRs

Brand	Code
ABS	31972
Alienware	31972
CyberPower	31972
Dell	31972
DirecTV	30739
Gateway	31972
Hewlett Packard	31972
Howard Computers	31972
HP	31972
Hughes Network Systems	30739
Humax	30739
Hush	31972
iBUYPOWER	31972
Linksys	31972
Media Center PC	31972
Microsoft	31972
Mind	31972
Niveus Media	31972
Northgate	31972
Panasonic	30616
Philips	30618, 30739
RCA	30880
ReplayTV	30614, 30616
Samsung	30739
Sonic Blue	30614, 30616
Sony	30636, 31972
Stack 9	31972
Systemax	31972
Tagar Systems	31972
Tivo	30618, 30636, 30739
Toshiba	31008, 31972, 31996
Touch	31972
Viewsonic	31972
Voodoo	31972
ZT Group	31972

### Cable/PVR Combo

Brand	Code
Americast	10899
Amino	11822
Digeo	11187
General Instrument	10810
Jerrold	10810

Motorola	11376, 10810, 11187, 11106
Myrio	11822
Pace	11877, 10237
Pioneer	11877, 10877
RCA	11256
Scientific Atlanta	11877, 10877
Sony	11006
Supercable	10276
Thomson	11256
Zenith	10899

### DBS/PVR Combo

Brand	Code
DirecTV	11377, 10392, 10639, 11142, 11076, 10099, 11392, 11442, 11640
Dish Network System	11505, 10775
Dishpro	11505, 10775
Echostar	11505, 10775, 11170
Expressvu	10775
Hughes Network Systems	11142, 11442
JVC	11170
Motorola	10869
Philips	11142, 11442
Proscan	10392
RCA	11392
Samsung	11442
Sony	10639, 11640
Star Choice	10869
Hughes Network Systems	30739
Philips	30739
Samsung	30739

### Audio Amp

Brand	Code
Adcom	40577
Bose	40674
Carver	40892
Curtis Mathes	40300
GE	40078
Harman/Kardon	40892
JVC	40331
Left Coast	40892
Marantz	40892
NEC	40264
Optimus	40013, 40300, 40823
Philips	40892
Pioneer	40013, 40300, 40823
Polk Audio	40892
RCA	40013, 40300, 40823
Realistic	40013
Shure	40264
Sony	40689, 40815
Soundesign	40078
Victor	40331

Wards	40078, 40013
Yamaha	40354, 40133

### CD players

Brand	Code
Acoustic Research	50420
Aiwa	50157
Arcam	50157
Audio Research	50157
Burmester	50420
Cairn	50157
California Audio Labs	50029, 50303
Cambridge Soundworks	50157
Carver	50157, 50179
Curtis Mathes	50032
Denon	50003, 50034
DKK	50000
DMX Electronics	50157
Fisher	50000, 50179
Garrard	50420
Genexxa	50032
Grundig	50157
Hafler	50173
Harman/Kardon	50100, 50157, 50173
Hitachi	50032
Inkel	50157, 50180
Integra	50101
Jerrold	50003
JVC	50032, 50072
Kenwood	50626, 50000, 50029, 50028, 50037, 50190
KLH	51711
Krell	50157
Linn	50157
LXI	50179
Magnavox	50157, 50274
Marantz	50626, 50029, 50157, 50180
Matsui	50157
McIntosh	50256
MCS	50029
Memorex	50000, 50032, 50179, 50420, 50468
Micromega	50157
Miro	50000
Mission	50157
Modulaire	50000, 50032, 50087, 50179, 50180, 50420, 50468
MTC	50420
NSM	50157
Onkyo	51327, 50101
Optimus	50000, 50032, 50037, 50087, 50179, 50420, 50468
Panasonic	50029, 50303, 50388, 50752
Parasound	50420
Penney	50029

(continued)

## Chapter 3: Using the remote control

Philips	50626, 50157, 50274
Pioneer	51062, 50032, 51087, 50468
PolkAudio	50157
Proceed	50420
Proton	50157
QED	50157
Quad	50157
Quasar	50029
RadioShack	50000, 50032, 50179, 50180, 50420, 50468
RCA	51062, 50032, 50053, 50179, 50420, 50468
Realistic	50000, 50032, 50087, 50179, 50180, 50420, 50468
Revox	50157
Rotel	50157, 50420
SAE	50157
Sansui	50000, 50157
Sanyo	50000, 50087, 50179
Sears	50179
Sharp	50037, 50180
Sherwood	50180
Sonic Frontiers	50157
Sony	50490, 50000, 50100, 51364, 50185
Sugden	50157
Sylvania	50157
Symphonic	50180
TAG McLaren	50157
Tandy	50032
Tascam	50420
Teac	50490, 50180, 50420
Technics	50029, 50303
Techwood	50303
Thule Audio	50157
Victor	50072
Wards	50032, 50157, 50053, 50087, 50179
Yamaha	50490, 50036, 51292
Yorx	50000

### Audio Amp/Tuners

Brand	Code
ADC	40531
Aiwa	41405, 40189, 40121, 41388, 41641
Alco	41390
AMC	41077
Anam	41609, 41074
Apex Digital	41774
Arcam	41189
Audiotronic	41189
Audiovox	41390
B&K	40701, 40820

Bose	41229, 40639, 41253, 41933
Cairn	40189
Capetronic	40531
Carver	41189, 40189, 40121, 41289
Curtis Mathes	40014
Denon	41360, 40121, 40771, 41142, 41306
Emerson	40531
Fisher	41801
Grundig	40189
Harman/Kardon	40110, 40189, 40891, 41289, 41304, 41306
Hitachi	41273, 41801
Integra	40135, 40842, 41298, 41320
JBL	40110, 41306
JVC	41058, 40074, 41374, 41495, 41811
Kawasaki	41390
Kenwood	41313, 41570, 41569, 40186
KLH	41390, 41428
Koss	41366, 41497
LG	41293
Linn	40189
Liquid Video	41497
Magnavox	41189, 41269, 40189, 40531, 41266, 41514
Marantz	41189, 41269, 40189, 40891, 41289
McIntosh	41289
Micromega	41189, 40189
Mitsubishi	41393
Myryad	41189
Nakamichi	41313
Onkyo	40135, 40842, 41298, 41320, 41531
Optimus	41023, 40074, 40014, 40121, 40186, 40531, 41074
Oritron	41366, 41497
Panasonic	41308, 41518, 40309, 41288, 41316, 41548, 41633, 41763, 41764
Philips	41189, 41269, 40189, 40891, 41266
Pioneer	41023, 40014, 40150, 40531, 40630, 41384
Polaroid	41508
Polk Audio	40189, 41289
Proscan	41254
RadioShack	41609







RCA	41023, 41609, 41254, 40531, 41074, 41390, 41511
Realistic	41609, 40121, 40186
Revox	40189
Samsung	41295, 41304, 41500
Sansui	41189, 40189
Sanyo	41251, 41469, 41801
Sharp	40186
Sherwood	41077
Sirius	41811
Sony	41058, 41441, 41258, 41622, 41658, 41758, 41858
Stereophonics	41023
Sunfire	41313
Teac	41074, 41390
Technics	41308, 41518, 40309, 41633
Thorens	41189
Toshiba	40135, 40842, 41788
Venturer	41390
Victor	40074
Wards	40189, 40014
Yamaha	41023, 40176, 40186, 41176, 41276, 41331, 41375
Zenith	41293



# Chapter 4: Menu layout and navigation



## Main menu layout

To open the main menus (illustrated below), press **MENU** on the remote control or TV control panel.

Icon	Item	Page	
	Channel Browser™	42	
	Favorites Browser	42	
	REGZA-LINK Player Control	57	
	Start Demo	35	
	Mode	48	
	Picture Settings	48	
	Noise Reduction	62	
	ColorMaster	63	
	x.v.Color Selection	64	
	Game Mode	64	
	Theater Settings	45	
	TheaterLock	49	
		Digital Audio Selector	51
		Audio Settings	51
Advanced Audio Settings		64	
Audio Setup		51	
	CC Selector	50	
	Base CC Mode	49	
	Digital CC Settings	50	
	Auto Input	37	
	Input Labeling	41	
	Channel Labeling	38	
	Menu Language	35	
	Channel Browser Setup	43	
	Enable Rating Blocking	53	
	Edit Rating Limits	54	
	Channels Block	55	
	Input Lock	55	
	Control Panel Lock	56	
	GameTimer®	55	
	New PIN Code	53	
	Installation	36	
	REGZA-LINK Setup	58	
	Sleep Timer	57	
	HDMI Settings	59	
	PC Settings	56	
	Blue LED Illumination	40	
	Power-On Mode	40	
	Demo Mode	40	

## Setup/Installation menu layout

To open the **Installation** menu (illustrated below), press **MENU** on the remote control or TV control panel, open the **Setup** menu, select **Installation**, and press **ENTER**.

Icon	Item	Page
	Input Configuration	36
	Channel Program	36
	Channel Add/Delete	37
	Channel Tuning Mode	44
	Signal Meter	39
	Time Zone Setup	39
	System Information	40

## THINC™ menu

The THINC\* menu provides access to the **Channel Browser**, **Favorites Browser**, and **REGZA-LINK Player Control** features.

The THINC menu is not part of the main menu system. You can only view the THINC menu by pressing **THINC** on the remote control.



\* Toshiba Home Interactive Network Connection.

## Navigating the menu system

You can use the buttons on the remote control or TV control panel to access and navigate your TV's on-screen menu system.

- Press **MENU** to open the menu system.

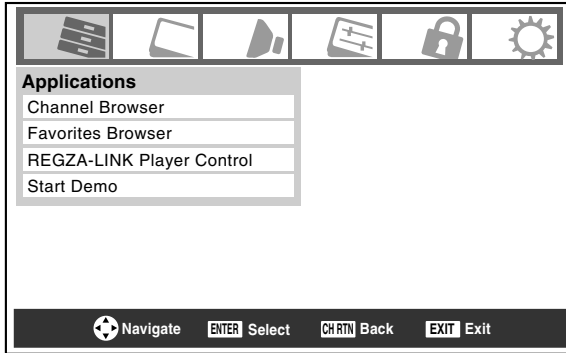

- When a menu is open, use the up/down/left/right arrow buttons (**▲▼◀▶**) on the remote control or TV control panel to move in the corresponding direction in the menu.
- Press **ENTER** to save your menu settings or select a highlighted item. (A highlighted menu item appears in a different color in the menu.)
- All menus close automatically if you do not make a selection within 60 seconds, except the signal meter menu, which closes automatically after about 5 minutes.
- To close a menu instantly, press **EXIT**.

### Note:

- The menu background may sometimes appear black, depending on the signal the TV is receiving. This is not a sign of malfunction.
- The Video sub-menu appears with a black background, which looks different from other menus.

## Setting the Demo Mode

When you first turn on the TV, menu language selection and Demo Mode selection windows will appear by default.

### To select settings:

- 1 From the menu language selection window, select your preferred language.



- 2 Press **ENTER**. Next the Demo Mode setting window will appear.

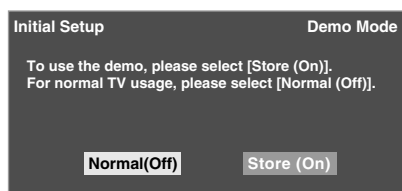

For normal TV usage, select **Normal (Off)**.

If you do not make a selection within 120 seconds, the Demo Mode setting window will automatically disappear. The TV will switch to Normal mode.

To enable the on-screen demonstration, select **Store (On)**. The ClearFrame™ demonstration window will display for 60 seconds. To restart the on-screen demonstration, press **MENU** on the remote or on the TV for 2 seconds.

**Note:** The on-screen demonstration will automatically restart if you do not make a selection within 120 seconds.

### To change the demo mode setting:

Press the **MENU** and **VOLUME** buttons on the TV control panel at the same time and hold for about 2 seconds, or use the **Demo Mode** item in the **Setup** menu (page 40).

## Selecting the menu language

You can choose from three different languages (English, French and Spanish) for the on-screen display of menus and messages.

### To select the menu language:

- 1 Press **MENU** and open the **Preferences** menu.
- 2 Highlight **Menu Language** and press **▶**.
- 3 Press **▲** or **▼** to select your preferred menu language and press **ENTER**.



- 4 Press **EXIT** to close the **Preferences** menu.

## Configuring the input source for the ANT/CABLE terminal

To configure the ANT/CABLE input source:

- 1 Press **MENU** and open the **Setup** menu.
- 2 Highlight **Installation** and press **ENTER**.

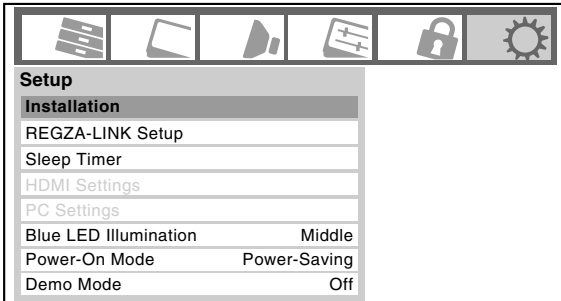

- 3 (A new set of **Installation** menu icons will appear, as shown below.) Open the **Terrestrial** menu, highlight **Input Configuration**, and press **ENTER**.

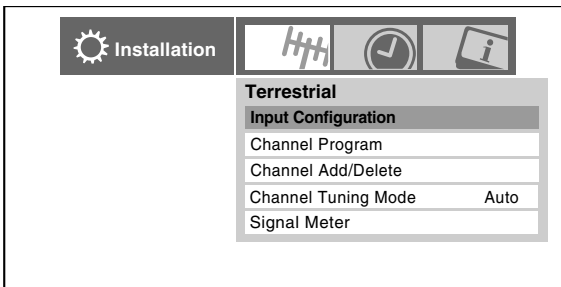

- 4 Press **◀** or **▶** to select the input source (**Cable** or **Antenna**) for the **ANT/CABLE** input on the TV.



- 5 To save your new settings, highlight **Done** and press **ENTER**. To revert to your original settings, highlight **Cancel** and press **ENTER**.

## Programming channels into the TV's channel memory

When you press **CH** or **CH** on the remote control or TV control panel, your TV will stop only on the channels you programmed into the TV's channel memory.

Follow the steps below to program channels into the TV's channel memory.

### Programming channels automatically

Your TV can automatically detect all active channels in your area and store them in its memory. After the channels are programmed automatically, you can manually add or erase individual channels in the channel memory.

#### Note:

- You must configure the ANT/CABLE input source before programming channels (see page 36).
- If the ANT/CABLE input signal type is set to **Cable**, the automatic channel programming process erases channels that were previously programmed into the TV's memory.
- If the ANT/CABLE input signal type is set to **Antenna**, the automatic channel programming process adds newly found channels to the existing set of programmed channels (and does NOT erase channels that were previously programmed into the TV's memory.) To remove an Antenna source channel from the memory, you must manually delete it.
- To tune the TV to a channel not programmed in the channel memory, you must use the Channel Number buttons on the remote control.
- Programming channels when the ANT/CABLE input is configured for **Cable** will take substantially longer than when the antenna input is configured for **Antenna**. This is normal; however, once channel programming is finished, you should not have to repeat the programming process again unless your Cable TV service lineup changes significantly.

### To program channels automatically:

- 1 Configure the antenna input source, if you have not already done so (see page 36).
- 2 From the **Setup** menu, highlight **Installation** and press **ENTER**. A new set of **Installation** menu icons will appear.

- Open the **Terrestrial** menu, highlight **Channel Program** to bring up the **Start**, and press **ENTER** again to begin channel programming.

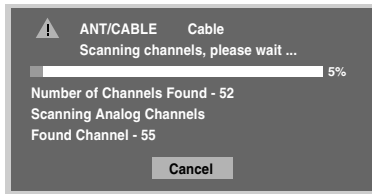

The TV will automatically cycle through all the antenna channels, and store all active channels in the channel memory. While the TV is cycling through the channels, the message “Scanning channels, please wait” appears (as shown above).

- To cancel channel programming, press **EXIT** on the remote control (or highlight **Cancel** in the on-screen display and press **ENTER**).  
When channel programming is finished, press **CH** or **CH** to view the programmed channels.

## Manually adding and deleting channels in the channel memory

After automatically programming channels into the channel memory, you can manually add or delete individual channels.

### To add or delete channels in the channel memory:

- From the **Setup** menu, highlight **Installation** and press **ENTER**. A new set of **Installation** menu icons will appear.
- Open the **Terrestrial** menu, highlight **Channel Add/Delete**, and then press **ENTER**.

### To add a channel to the channel memory:

Highlight the unchecked box next to the channel number you want to add, and then press **ENTER** to check the box.

### To manually add digital subchannels on a physical channel:

Use the Channel Numbers and the Dash (**100**) on the remote control to enter the channel number (for example, 56-1).

If the channel is found, the number will be added to the list and the box will be checked.

If the channel is not found, a message will appear.

### To remove a channel from the channel memory:

Highlight the checked box next to the channel number you want to remove, and then press **ENTER** to uncheck the box.

### To save your new settings:

Highlight **Done** and press **ENTER**.

**Note:** A video preview of the currently highlighted channel is provided to assist you in adding/deleting channels.

### To revert to your original settings:

Highlight **Cancel** and press **ENTER** before saving.

### To remove all channels from the channel memory:

Highlight **Reset** and press **ENTER**, and then highlight **Done** and press **ENTER**.

### To remove encrypted channels from the channel memory:

If an encrypted channel is accidentally added to the channel list by programming channels, you can remove the unwanted encrypted (non-viewable) channel while you are channel surfing. When you tune into an encrypted channel, the following message will appear.

Digital Channel Is Encrypted - Press 1 on remote to remove channel

Press **1** while the message is on the screen to remove the unnecessary channel from the channel list.

## Setting the Auto Input feature

This feature allows you to change TV inputs using the **MODE SELECT** buttons—**TV**, **CABLE/SAT**, **HD DVD**, **DVD**, **VCR/PVR**—on the remote control. Once an input has been set for a specific **MODE SELECT** button, the TV will automatically switch to the input when you press and hold the **MODE SELECT** button for 2 seconds.

Auto Input settings options for each **MODE SELECT** button are shown below.

- TV:** ANT/CABLE
- CABLE/SAT:** ANT/CABLE, Video 1, Video 2, ColorStream HD1, ColorStream HD2, HDMI 1, HDMI 2, HDMI 3, PC
- HD DVD:** Video 1, Video 2, ColorStream HD1, ColorStream HD2, HDMI 1, HDMI 2, HDMI 3, PC
- DVD:** Video 1, Video 2, ColorStream HD1, ColorStream HD2, HDMI 1, HDMI 2, HDMI 3, PC
- VCR/PVR:** ANT/CABLE, Video 1, Video 2, ColorStream HD1, ColorStream HD2, HDMI 1, HDMI 2, HDMI 3, PC

**Note:** The TV mode select button will be restricted to the ANT/CABLE input.

### To set the Auto Input:

- From the **Preferences** menu, highlight **Auto Input** and press **ENTER**.

(continued)

- Press ▲ or ▼ to highlight **Enable Auto Input** and then press ◀ or ▶ to select **On**.

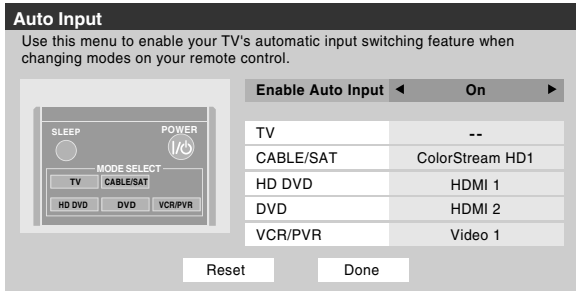

- Press ▲ or ▼ to select the mode field you want to set.
- Press ◀ or ▶ to select the desired input source for that mode.
- Repeat steps 3 and 4 for other modes.
- To save your settings, highlight **Done** and press **ENTER**.

### To turn off the Auto Input:

Select **Off** in step 2.

**Note:** Setting the feature to **Off** will not cancel any settings; however, all items will be grayed out.

### To reset Auto Input:

Highlight **Reset** and press **ENTER**.

## Labeling channels

A list of common channel labels (logos) for various channels (ABC, CBS, etc.) will be programmed into the TV. You will be able to view and assign these logos from the **Channel Labeling** window. If the desired channel label is not provided in the list, you will be able to manually enter/edit labels using the software keyboard.

### To assign channel labels:

- From the **Preferences** menu, highlight **Channel Labeling** and press **ENTER**.  
The **Channel Labeling** window opens.
- Press **CH** or **CH** to select the channel you want to label.
- Press ▲▼◀▶ to highlight the desired channel label and press **ENTER**.
- Repeat steps 2 and 3 for other channels.
- To save your settings, highlight **Done** and press **ENTER**.  
The maximum number of labels that can be stored is 128.

### To remove channel labels:

- Open the **Channel Labeling** window.
- Press **CH** or **CH** to select the channel for which you want to remove the label.

- Press ▲▼◀▶ to highlight **No Label** and press **ENTER**.
- Repeat steps 2 and 3 for other channels.
- To save your settings, highlight **Done** and press **ENTER**.

If the desired channel label is not available from the list of presets, you can create a custom label.

### To create and assign a custom label:

- Open the **Channel Labeling** window.
- Press **CH** or **CH** to select a channel you want to label.
- Press ▲▼▶ to highlight **Custom** and press **ENTER**.  
The software keyboard will appear.



- Repeatedly press the corresponding key on the remote control to highlight the desired character on the on-screen software keyboard.
- The highlighted character is entered after you either press a different key, press ▶ key, or after a two-second pause.
- Repeat steps 4 and 5 until you have entered all desired text.
- When finished, press **ENTER**.
- New labels will be added to the list in alphabetical order and marked with an icon ✎ to indicate that they are custom. Highlight the new custom label and press **ENTER** to assign.

Assigned channel labels will be displayed in the banner, **Channel Add/Delete**, **Channels Block**, and **Channel Browser**.

### To delete the custom label:

- Open the **Channel Labeling** window.
- Highlight the label to be deleted and press **100**.
- Highlight **Yes** from the deletion confirmation window and press **ENTER**.

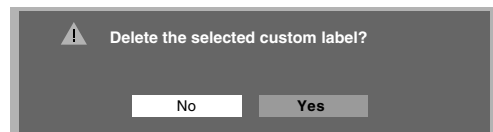

- Highlight **Done** and press **ENTER** to save changes, and go back to the **Channel Labeling** window.

## Setting the HDMI™ audio mode

To set the HDMI audio mode:

- 1 From the **Audio** menu, highlight **Audio Setup** and press **ENTER**.
- 2 Press **▲** or **▼** to select **HDMI 1 Audio** and then press **◀** or **▶** to select the HDMI 1 audio mode (**Auto**, **Digital**, or **Analog**). (**Auto** is the recommended mode.) See “Connecting an HDMI or DVI device to the HDMI input” (page 16).

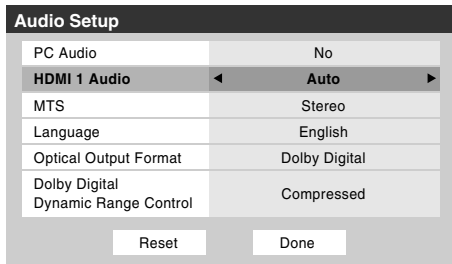

- 3 To save your setting, highlight **Done** and press **ENTER**.

Mode	Description
Auto	When viewing the HDMI 1 input, if digital audio from the HDMI input is available, it will be output. If not, the TV will automatically detect and output analog audio from the Shared Analog Audio inputs.
Digital	When viewing the HDMI 1 input, digital audio from the HDMI input will be output.
Analog	When viewing the HDMI 1 input, analog audio from the Shared Analog Audio inputs will be output.

**Note:** Because the PC and HDMI 1 inputs share the same set of analog audio inputs, the **PC Audio** menu setting influences the **HDMI 1 Audio** menu setting. If **PC Audio** is set to “No,” the **HDMI 1 Audio** setting changes to “Auto.” If **PC Audio** is set to “Yes,” the **HDMI 1 Audio** setting is set to “Digital” and is grayed out in the menu. (Also see item 5 on page 11 and “Setting the PC Audio” on page 57.)

## Viewing the digital signal meter

You can view the digital signal meter in the ANT/CABLE digital TV input source only.

To view the digital signal meter:

- 1 From the **Setup** menu, highlight **Installation** and press **ENTER**. A new set of Installation menu icons will appear.
- 2 Open the **Terrestrial** menu, highlight **Signal Meter**, and press **ENTER**.
- 3 Press **▲▼◀▶** to select the antenna input and digital channel whose signal you want to check.

**Note:**

- The physical digital channel number listed in the Signal Meter screen may not correspond to a virtual TV channel number. Contact your local broadcasters to obtain the RF channel numbers for your local digital stations.
- The signal strength does not change between virtual channels on the same physical channel.

To close the screen and return to the **Terrestrial** menu:

Highlight **Done** and press **ENTER**.

To return to normal viewing:

Press **EXIT**.

## Setting the time zone

The Time Zone setup will allow you to specify the correct time zone for your region. This feature will allow the TV status information to show the correct time zone information (page 60).

To set the time zone:

- 1 From the **Setup** menu, highlight **Installation** and press **ENTER**. A new set of Installation menu icons will appear.
- 2 Open the **Time Zone** menu, highlight **Time Zone Setup**, and press **ENTER**.
- 3 Press **◀** or **▶** to select the region, highlight **Done**, and then press **ENTER**.

After the time zone has been set, you will be asked to set the current Daylight Saving Time status.

To set the **Daylight Saving Time** status:

- 1 Press **◀** or **▶** to select **Yes** or **No**, highlight **Done**, and then press **ENTER**.

## Viewing the system status

To view the system status:

- 1 From the **Setup** menu, highlight **Installation** and press **ENTER**. A new set of Installation menu icons will appear.
- 2 Open the **System Status** menu, highlight **System Information**, and press **ENTER**.
- 3 Press **◀▶** to scroll through the menu bar to select the **Software Version** and view the related information.

To close the screen and return to the Installation menu:

Highlight **Done** and press **ENTER**.

To return to normal viewing:

Press **EXIT**.

### Reset Factory Defaults

To reset all settings and channels to their factory default values:

- 1 From the **Setup** menu, highlight **Installation** and press **ENTER**. A new set of Installation menu icons will appear.
- 2 Open the **System Status** menu, highlight **System Information**, and press **ENTER**.
- 3 Press **◀▶** to scroll through the menu bar to select **Factory Defaults**.
- 4 Enter your PIN code (or 0000 if no PIN code has been set).
- 5 Highlight **Yes** and press **ENTER**. The TV will turn off automatically after a few seconds. After the TV turns off, unplug the TV power cord and then plug it in again to complete the reset process.

To cancel the reset:

Highlight **No** and press **ENTER**.

## Selecting the Blue LED Illumination level

You can adjust the brightness of the blue LED located on the front panel (the options are High, Middle, and Low).

To set the Blue LED Illumination level:

- 1 Press **MENU**, and open the **Setup** menu.
- 2 Highlight **Blue LED Illumination** and press **▶**.
- 3 Press **▲** or **▼** to select your desired illumination level, and press **ENTER**.

## Selecting the Power-On Mode

You can select either **Power-Saving** or **Fast** mode.

- **Power-Saving** mode keeps power consumption in standby mode to below 3W. As a result, it takes a bit longer for the TV to turn on.
- **Fast** mode increases power consumption in standby mode. As a result, the TV will turn on more quickly. While in **Fast** mode, the yellow LED on the front of the TV will be lit.

To set the Power-On Mode feature:

- 1 From the **Setup** menu, highlight **Power-On Mode** and press **▶**.
- 2 Press **▲** or **▼** to select either **Power-Saving** or **Fast**, and press **ENTER**.

To return to normal viewing:

Press **EXIT**.

## Selecting the Demo Mode

You can set the TV's demo mode to On or Off.

This feature is provided for demonstrational purposes only.

To select the Demo Mode:

- 1 Press **MENU**, and open the **Setup** menu.
- 2 Highlight **Demo Mode** and press **▶**.
- 3 Press **▲** or **▼** to select either **On** or **Off**, and press **ENTER**.

**Note:** If the demo mode has been set to **On**, the Demo mode will run automatically when you turn on the TV.



## Selecting the video input source to view

To select the video input source to view:

- 1 Press **INPUT** on the remote control or TV control panel.
- 2 And then either:
  - a) Press 0–8; or
  - b) Repeatedly press **▲▼** on the remote control and then press **ENTER** to change the input; or
  - c) Repeatedly press **INPUT** on the remote control or TV control panel to change the input.

The current signal source displays in the top right corner of the **Input Selection** screen.

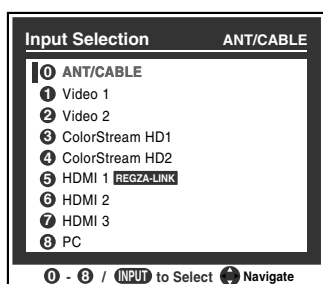

### Note:

- You can label the video input sources according to the specific devices you have connected to the TV (see “Labeling the video input sources” at right).
- Sources can also be “hidden” (see “Labeling the video input sources” at right).
- “No Video Signal” will appear randomly on the screen if no signal is received in video input mode.
- If a CEC device is connected to an HDMI input, the REGZA-LINK icon will appear.
- When the Auto Input feature is set, you can also select a video input source by pressing and holding **MODE SELECT** button for 2 seconds (see page 37).

### If a REGZA-LINK device with HDMI switching capability (e.g. Audio Receiver) is connected to the HDMI input:

Press **INPUT** on the remote or TV control panel repeatedly to highlight **HDMI 1**, **HDMI 2** or **HDMI 3**.

If the connected CEC device has any connected devices, a separate device selection popup window will appear.

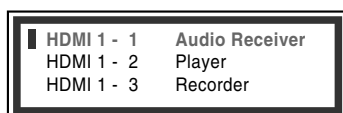

Press **INPUT** repeatedly to highlight the desired input source, and then press **EXIT**.

### Note:

- When selecting REGZA-LINK input sources from the popup window using **INPUT**, some REGZA-LINK devices may automatically turn on.
- When selecting input sources using **▲▼**, you will have to press **ENTER** to actually select a particular device from the popup window.

## Labeling the video input sources

You can label each video input source according to the type of device you connected to each source, from the following preset list of labels:

- -- (default label)
- Audio Receiver
- Cable
- Compact Disc
- DTV
- DVD
- Game Console
- HD DVD
- HDMI Switch (HDMI inputs only)
- Laser Disk
- Satellite/DSS
- VCR
- Video Recorder
- Hide (to hide an unused input in the **Input Selection** screen and in the Channel Browser Inputs list)

**Note:** If you select PC in the Input Selection screen, you can choose only “--”, “Game Console”, or “Hide” as the label.

To label the video input sources:

- 1 Press **MENU** and open the **Preferences** menu.
- 2 Highlight **Input Labeling** and press **ENTER**.

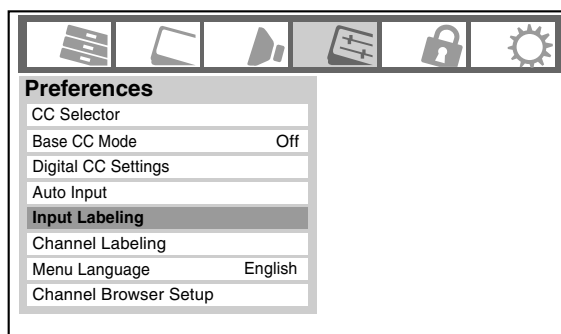

- 3 Press **▲** or **▼** to highlight the video source you want to label.

(continued)

- 4 Press ◀ or ▶ to select the desired label for that input source. If a particular input is not used, you can select **Hide** as the label, which will cause that input to be “grayed out” in the Input Selection screen and skipped over when you press (INPUT) on the remote control.
- 5 To save the new input labels, highlight **Done** and press (ENTER).  
To revert to the factory default labels, highlight **Reset** and press (ENTER).

**Input labeling example:**

The screen below left shows the default **Input Selection** screen (with none of the inputs labeled as a specific device). The screen below right is an example of how you could label the inputs if you connected a VCR to VIDEO 1, Cable TV to VIDEO 2, a video recorder to ColorStream HD1, a DTV set-top box to HDMI 1, a satellite/DSS set-top box to HDMI 2, and a DVD player to HDMI 3. Also note that the ColorStream HD2 input is labeled “Hidden,” which means that input will be skipped over when (INPUT) is pressed.

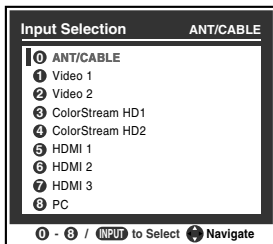

Input Selection screen with no inputs labeled.

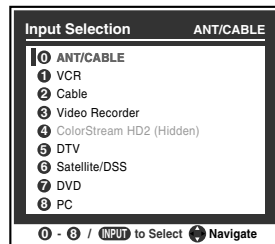

Input Selection screen with all inputs labeled except input 4, which has been hidden.

**To clear the input labels:**

- 1 From the **Preferences** menu, highlight **Input Labeling** and press (ENTER).
- 2 Highlight **Reset** and press (ENTER).

## Tuning channels

### Tuning channels using the Channel Browser™

The Channel Browser™ provides an easy navigation interface for all your channels and inputs. This feature allows you to:

- Navigate the contents of all of your inputs.
- Keep a list of your favorite channels (see “Favorites Browser,” below).
- Keep a history of the last 32 channels or inputs viewed.
- Quickly surf and tune your recently viewed channels/inputs from the Channel Browser™ History List (illustrated on the next page).
- Surf via Browse mode (to immediately tune channels as you highlight them in the Channel Browser™) or Select mode (to surf over channels in the Channel Browser™ before you select one to tune).
- Quickly change inputs from the Inputs List.
- Quickly select REGZA-LINK devices from the REGZA-LINK List.

### Favorites Browser

The Favorites Browser allows you to quickly set up a favorite channels/inputs list that is integrated into the Channel Browser™.

**To add a favorite channel/input:**

- 1 Tune to the channel or input.
- 2 Press and hold (CHANNEL BROWSER) on the remote control for 3 seconds.

**Note:** Additions are added to the beginning of the Favorites list on the left side of the Channel Browser™.

**To delete a favorite channel/input:**

- 1 Press (CHANNEL BROWSER) to open the Favorites list.
- 2 Highlight the channel or input to delete by pressing (BACK) or (NEXT).
- 3 Press and hold (100) for 3 seconds. The channel/input will be removed from the Favorites list.

**To set up the Channel Browser™:**

- 1 From the **Preferences** menu, highlight **Channel Browser Setup** and press **ENTER**.
- 2 Press **▲** to highlight **Navigation**, and then press **◀** or **▶** to select either **Browse Mode** or **Select Mode**.

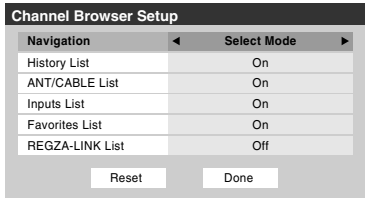

- 3 Press **▼** to highlight **History List**, and then press **◀** or **▶** to select the setting you prefer: either **On** or **Off**.

**Note:** *History List* will be cleared every time the TV is powered off.

- 4 Press **▼** to highlight **ANT/CABLE List**, and then press **◀** or **▶** to select **On** or **Off**.
- 5 Press **▼** to highlight **Inputs List**, and then press **◀** or **▶** to select **On** or **Off**.
- 6 Press **▼** to highlight **Favorites List**, then press **◀** or **▶** to select **On** or **Off**.
- 7 Press **▼** to highlight **REGZA-LINK List**, and then press **◀** or **▶** to select **On** or **Off**.

**Note:** *REGZA-LINK List* will be automatically grayed out and set to **Off** when **Enable REGZA-LINK** is switched to **Off**. (See "To set the REGZA-LINK Setup" on page 59 for more information.)

- 8 To save your entries, highlight **Done** and press **ENTER**. To return to factory defaults, highlight **Reset** and press **ENTER**.

**To open the Channel Browser™:**

- Press **BACK** **CB** **◀** or **NEXT** **CB** **▶** on the remote control.
- Press **BACK** **CB** **◀** to surf backward through the previously tuned 32 channels in the History list, the channels in the ANT/CABLE channel list, the inputs in the Inputs list, the REGZA-LINK devices in the REGZA-LINK list, or the favorite channels/inputs in the Favorites list.
- Press **NEXT** **CB** **▶** to surf forward through the channel History, the ANT/CABLE channel list, the Inputs list, the REGZA-LINK list, or the favorite channels/inputs in the Favorites list.

**Elements of the Channel Browser™**

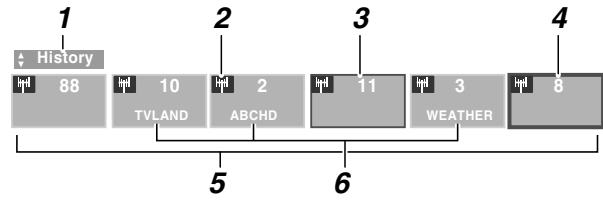

- 1 Current list (**History**, **ANT/CABLE**, **Inputs**, **Favorites**, or **REGZA-LINK**)
- 2 Input type
- 3 Channel or input currently being viewed
- 4 Channel or input that is currently highlighted in the browser
- 5 Channels stored in the History List
- 6 Channel labels

**To toggle among the available lists:**

After opening the Channel Browser™, press **▲** or **▼** to toggle among **History**, **ANT/CABLE**, **Inputs**, **Favorites**, and **REGZA-LINK**.

**Note:**

- The Channel Browser™ opens in **History List** by default. Once another list has been selected, the Channel Browser™ will open in the last selected list.
- If all lists are turned off, pressing **BACK** **CB** **◀**, **NEXT** **CB** **▶**, or **CH BROWSER** will not display the Channel Browser™. If **Favorites List** is turned off, **CH BROWSER** will have no effect.
- Pressing **CH BROWSER** will bring up the Channel Browser™ Favorites list regardless of the last selected list in the Channel Browser™.

**To tune to a channel or input in Browse mode:**

- 1 While watching TV, press **BACK** **CB** **◀** or **NEXT** **CB** **▶** to open the Channel Browser™ and surf back to a previous item or surf forward to the next item in the list.  
In **Browse** mode, when you stop on an item in the Channel Browser™, it will be highlighted and the TV will automatically tune to the channel or input.
- 2 Press **EXIT** to close the Channel Browser™.

**To tune to a channel or input in Select mode:**

- 1 While watching TV, press **BACK** **CB** **◀** or **NEXT** **CB** **▶** to open the Channel Browser™ and surf back to a previous item or forward to the next item in the list.  
In **Select** mode, when you stop on an item in the Channel Browser™, it will be highlighted but you must press **ENTER** to tune the TV to the highlighted item.
- 2 Press **ENTER** to tune the TV to the highlighted item.
- 3 Press **EXIT** to close the Channel Browser™.



(continued)

## Adding and clearing channels and inputs in the History List

### Adding channels and inputs to the History List:

As a channel or input is tuned, the Channel Browser™ adds it to the History List and displays it on the “right side” of the Channel Browser™. Previously tuned channels/inputs are “shifted” to the left, eventually moving off the left side. Press  ◀ to surf backward through the previously tuned channels/inputs. Any channel or input that is tuned repeatedly will not be repeated in the History List, but instead is moved to the end of the list on the right side of the Channel Browser™.

The Channel Browser™ will store the following channels:

- All channels that are tuned using the numeric buttons on the remote control.
- All channels that are tuned using  or  on the remote control.

**Note:** Whenever an item is selected that cannot be tuned (for various reasons), the TV will automatically tune to the previously viewed channel or input.

### Clearing channels from the History List:

- Reconfiguring the **ANT/CABLE** input will clear the History List.

**Note:** See page 36 for details on configuring the antenna input.



- Once 32 channels or inputs are stored in the History List, the oldest item will be removed from the list when a new channel or input is tuned.
- Turning off the TV will clear the History List.

## Setting the Channel Tuning Mode

This feature allows you to choose how tuning will be handled for analog and digital channels when the TV is in Antenna mode.





**Note:** To use this feature, the **Input Configuration** must be set to **Antenna** (see page 36).

The channel tuning mode has three options.

Mode	Description
Standard	Both analog and digital channels can be tuned normally
Auto (default)	Digital channels will have priority when manually entering a channel number using the Channel Number (0-9) on the remote control, analog channels can still be tuned by  /  if available
Digital	Only digital channels can be tuned

**Note:** Digital mode will be most useful after analog channels are shut down by the government in 2009.

## To set the Channel Tuning Mode:



- 1 From the **Setup** menu, highlight **Installation** and press . A new set of **Installation** menu icons will appear.
- 2 Open the **Terrestrial** menu, highlight **Channel Tuning Mode**, and then press  and  to select your desired mode, and press .

### Note:

- The Channel Add/Delete & Channels Block windows as well as the Channel Browser ANT/CABLE list will be updated automatically when you change the mode. Also, the History List will be cleared, but the Favorites List will be saved.
- Even if the Channel Tuning Mode is set to **Digital**, analog channel 3 will still be the default channel to prevent the initial case where no digital channels have been found in prior channel scans. (Channel Add/Delete will not have anything listed until a scan is done.)

## Tuning to the next programmed channel

### To tune to the next programmed channel:

Press  or  on the remote control or TV control panel.



**Note:** This feature will not work unless you program channels into the TV's channel memory (see page 36).

## Tuning to a specific channel (programmed or unprogrammed)

### Tuning analog channels:

Press the Channel Number (0–9) on the remote control. For example, to select channel 125, press 1, 2, 5, then .

### Tuning digital channels:

Press the Channel Number (0–9) on the remote control, followed by the dash () button and then the sub-channel number. For example, to select digital channel 125-1, press 1, 2, 5, -, 1, then .

**Note:** If a digital channel is not programmed—either through the automatic channel scan (see page 36) or the channel add/delete function (see page 37)—you will have to tune the RF channel using the Channel Number and dash () on the remote control.

## Switching between two channels using Channel Return

The Channel Return feature allows you to switch between two channels without entering an actual channel number each time.

- 1 Select the first channel you want to view.
- 2 Select a second channel using the Channel Number buttons (and the dash ( $\text{CH RTN}$ ) button if selecting a digital channel).
- 3 Press  $\text{CH RTN}$  on the remote control. The previous channel will display. Each time you press  $\text{CH RTN}$ , the TV will switch back and forth between the last two channels that were tuned.

**Note:** If you press  $\text{CH RTN}$  from a non-antenna input, the TV will return to the last-viewed input.

## Switching between two channels using SurfLock™

The SurfLock™ feature temporarily “memorizes” one channel to the  $\text{CH RTN}$  button, so you can return to that channel quickly from any other channel by pressing  $\text{CH RTN}$ . To memorize a channel to the  $\text{CH RTN}$  button:

- 1 Tune the TV to the channel you want to program into the  $\text{CH RTN}$  button.
- 2 Press and hold  $\text{CH RTN}$  for about 2 seconds until the message “Memorized” appears on-screen. The channel has been programmed to the  $\text{CH RTN}$  button.
- 3 You can then change channels repeatedly, and when you press  $\text{CH RTN}$ , the memorized channel will be tuned.

The TV will return to the memorized channel one time only. Once you press  $\text{CH RTN}$  and then change channels again, the CH RTN memory will be cleared and the button will function as Channel Return, by switching back and forth between the last two channels that are tuned. This feature also works for external inputs.

## Selecting the picture size

You can view many program formats in a variety of picture sizes—**Natural**, **TheaterWide 1**, **TheaterWide 2**, **TheaterWide 3**, **Full**, **4:3 HD**, **Native**, and **Dot by Dot**.

**Note:** The “picture size” illustrations are examples only. The format of the image (in any of the picture sizes) will vary depending on the format of the signal you are currently watching. Select the picture size that displays the current program the way that looks best to you.

You can save separate picture size preferences for each input on your TV.

### To select the picture size using the remote control:

- 1 Press  $\text{PIC SIZE}$  on the remote control.
- 2 While the **Picture Size** screen is open, you can do one of the following to select the desired picture size:
  - Repeatedly press  $\text{PIC SIZE}$ .
  - Press the corresponding Number button (0–6) while the **Picture Size** screen is open.
  - Press  $\blacktriangle$  or  $\blacktriangledown$  while the **Picture Size** screen is open.

### To select the picture size using the menus:

- 1 Select **Picture Size** in the **Theater Settings** menu.
- 2 Press  $\blacktriangleleft$  or  $\blacktriangleright$  to select the desired picture size setting.
- 3 Highlight **Done** and press  $\text{ENTER}$ .

**Note:** Some of the picture sizes may not be available depending on the receiving signal format (those will be “grayed out” in the **Picture Size** screen).

Using these functions to change the picture size (i.e., changing the height/ width ratio) for any purpose other than your private viewing may be prohibited under the Copyright Laws of the United States and other countries, and may subject you to civil and criminal liability.

**Note:** If you select one of the TheaterWide® picture sizes, the top and bottom edges of the picture (including subtitles or captions) may be hidden. To view the hidden edges, either scroll the picture (**TheaterWide 2** and **3** only) or try viewing the program in **Full** or **Natural** picture size.

(continued)

Picture Size

Natural

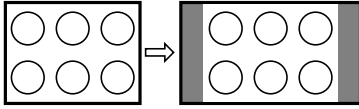

Some program formats will display with sidebars and/or bars at the top and bottom.

TheaterWide 1  
(for 4:3 format programs)

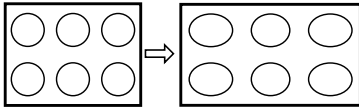

The center of the picture remains close to its original proportion, but the left and right edges are stretched wider to fill the screen.

TheaterWide 2  
(for letter box programs)

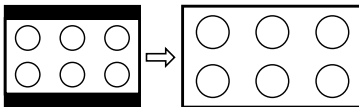

The top and bottom edges of the picture may be hidden\*.

TheaterWide 3  
(for letter box programs with subtitles)

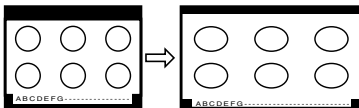

The top and bottom edges are hidden\*.

Full  
(for 16:9 [480i, 480p] source programs only)

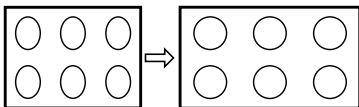

- If receiving a squeezed 4:3 format program, the picture is stretched wider to fill the width of the screen, but not stretched taller.
- None of the picture is hidden.

Picture Size

4:3 HD  
(for 720p, 1080i, and 1080p program sources only)

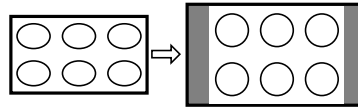

Picture is not distorted from original size.

Native  
(for 480i (HDMI), 480p (HDMI), 720p, 1080i, and 1080p signal programs)

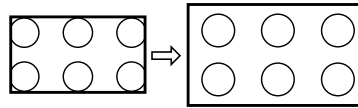

- If receiving a 480i (HDMI), 480p (HDMI), 720p, 1080i, or 1080p signal program, Native mode scales the video to display the entire picture within the borders of the screen (i.e. no overscanning).
- This is especially useful for external HD sources such as HD-DVD, DVHS movies, or PC graphics.

Note:

- This mode is supported only for HDMI (1080p, 1080i, 720p, 480p, and 480i), ColorStream (1080i and 720p), and ANT/CABLE (digital) inputs (1080p, 1080i, and 720p).
- Depending on the input signals, the border of the picture may be hidden, displayed in black, or noisy.

Dot by Dot

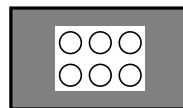

“Dot by Dot” is a non-scaling display. Depending on the input signal format, the picture is displayed with sidebars and/or bars at the top and bottom. (Example: VGA input source)

\* To view the hidden areas (such as subtitles or captions), see “Scrolling the TheaterWide® picture” (page 47).

## Scrolling the TheaterWide® picture (TheaterWide 2 and 3 only)

You can set separate scroll settings for the TheaterWide 2 and TheaterWide 3 modes for each input.

### To set the scroll settings:

- 1 Press **MENU** and open the **Video** menu.
- 2 Highlight **Theater Settings** and press **ENTER**.

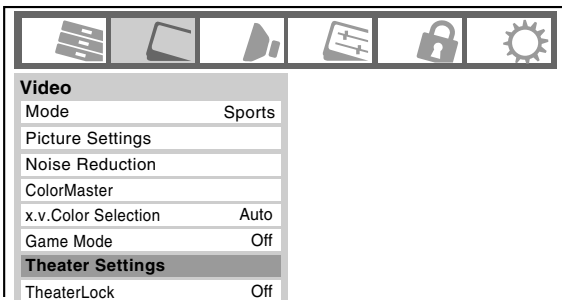

- 3 In the **Picture Size** field, select either **TheaterWide 2** or **TheaterWide 3** (you cannot scroll in any other mode).
- 4 Press **▼** to highlight the **Picture Scroll** field.
- 5 Press **◀** or **▶** to scroll the picture up and down as needed, from -10 to +20.
- 6 To save the new settings, highlight **Done** and press **ENTER**. To revert to the factory defaults, highlight **Reset** and press **ENTER**.

## Using the auto aspect ratio feature

When the auto aspect ratio feature is set to **On**, the TV will automatically select the picture size when one of the following input sources is received:

- A 480i, 480p, 720p, 1080i digital signal from the **ANT/CABLE** input
- A 480i signal from the **Video 1** or **Video 2** input
- A 480i, 480p, 720p, 1080i signal from the **ColorStream HD1** or **HD2** input
- A 480i, 480p, 720p, 1080i, 1080p, or VGA (60/72/75Hz) signal from the **HDMI 1/2/3** input

Aspect ratio of signal source	Automatic aspect size (automatically selected when Auto Aspect is On)
4:3 normal	Natural (with sidebars)
4:3 letter box	TheaterWide 2
16:9 full	Full
Not defined (no ID-1 data or HDMI aspect data)	The current picture size you set under "Selecting the picture size" on page 45.

**Note:** The auto aspect ratio feature is not applicable to the PC input.

### To turn on the auto aspect ratio feature:

- 1 From the **Video** menu, highlight **Theater Settings** and press **ENTER**.
- 2 In the **Auto Aspect Ratio** field, select **On**.
- 3 To save the new settings, highlight **Done** and press **ENTER**. To revert to the factory defaults, highlight **Reset** and press **ENTER**.

### To turn off the auto aspect ratio feature:

Select **Off** in step 2 above.

## Using the FREEZE feature

### To use the FREEZE feature:

- 1 When viewing the TV, press **FREEZE** to make the picture a still picture.
- 2 To return to the moving picture, press **FREEZE** again (or any other button).

**Note:** If the TV is left in FREEZE mode for more than 15 minutes, the FREEZE mode will automatically be released and the TV will return to moving picture.

Using the FREEZE function for any purpose other than your private viewing may be prohibited under the Copyright Laws of the United States and other countries, and may subject you to civil and criminal liability.

## Adjusting the picture

### Selecting the picture mode

You can select your desired picture settings from the following modes, as described below.

Mode	Picture Quality
Sports	Bright and dynamic picture
Standard	Standard picture settings
Movie	Lower contrast for darkened room
PC	Designed for viewing of PC tables and documents
Preference	Your personal preferences

**Note:** PC mode is available for HDMI and PC inputs only (grayed out for other inputs).

- 1 From the **Video** menu, highlight **Mode** and press **ENTER**.
- 2 Press **▲** or **▼** to select the picture mode you prefer and press **ENTER**.

**Note:** The picture mode you select affects the current input only. You can select a different picture mode for each input.

## Adjusting the picture quality

You can adjust the picture quality (Contrast, Backlight, DynaLight™, Brightness, Color, Tint, and Sharpness) to your personal preferences.

Selection	Pressing ◀	Pressing ▶
Contrast	lower	higher
Backlight*	darker	lighter
DynaLight**	On/Off	On/Off
Brightness	darker	lighter
Color	paler	deeper
Tint	reddish	greenish
Sharpness	softer	sharper

\* Backlight  
This feature adjusts the brightness of the entire screen. When in video mode and no signal is input, this will automatically be set to 0. (Settings are stored in memory.)

\*\*DynaLight  
This function automatically strengthens the black coloring of dark areas in the video according to the level of darkness.

### To adjust the picture quality:

- 1 From the **Video** menu, highlight **Picture Settings** and press **ENTER**.
- 2 Press **▲** or **▼** to select the picture quality you want to adjust (**Contrast, Backlight, DynaLight, Brightness, Color, Tint, or Sharpness**), and then press **◀** or **▶** to adjust the setting, as described in the table above.
- 3 To save the new settings, highlight **Done** and press **ENTER**. You can use any of the picture modes (⏏ “Selecting the picture mode,” above left) as a starting point for adjusting the picture settings.  
To revert back to the base mode that you began adjusting the picture settings from, highlight **Reset** and press **ENTER**.

The picture qualities you adjusted are automatically saved in the **Preference** mode (⏏ “Selecting the picture mode,” above left) until **Reset** is selected.



## Using the TheaterLock™ feature

The TheaterLock™ feature allows you to “lock” all items that affect the picture mode setting. In other words, those settings that when adjusted cause the Mode setting to automatically change to “Preference” will be grayed out and unavailable when the TheaterLock setting is set to “On”. Items that do not influence Mode status will not be affected e.g., Noise Reduction, x.v.Color Selection, Game Mode, etc.

### To turn on TheaterLock™:

- 1 From the **Video** menu, press ▲ or ▼ to highlight the **TheaterLock** field, press ► and ▲▼ to select **On**, and press **ENTER**.

### To turn off TheaterLock™:

Select **Off** in step 1 above.

**Note:** When TheaterLock is set to **On**, a lock icon (🔒) will also be displayed in all Video menu windows where items are disabled.

## Using the closed caption mode

### Base closed captions

The closed caption mode has two options:

- **Captions**—An on-screen display of the dialogue, narration, and sound effects of TV programs and videos that are closed captioned (usually marked “CC” in program guides).
- **Text**—An on-screen display of information not related to the current program, such as weather or stock data (when provided by individual stations).

### To view captions or text:

- 1 From the **Preferences** menu, highlight **Base CC Mode** and press ►.
  - 2 Press ▲ or ▼ to select the desired closed caption mode and press **ENTER**.
- **To view captions:** Highlight **CC1**, **CC2**, **CC3**, or **CC4**. (**CC1** displays translation of the primary language in your area.)



**Note:** If the program or video you selected is not closed captioned, no captions will display on-screen.

- **To view text:** Highlight **T1**, **T2**, **T3**, or **T4**.

WORLD WEATHER	Temps		Current Weather
	F	C	
LONDON	51	11	Clear
MOSCOW	57	14	Cloudy
PARIS	53	12	Clear
ROME	66	19	Cloudy
TOKYO	65	18	Rain

**Note:** If text is not available in your area, a black rectangle may appear on screen. If this happens, set the Base CC Mode to **Off**.

- **To turn off the closed caption mode:** Select **Off** in step 2 above.

**Note:** A closed caption signal may not display in the following situations:

- When a videotape has been dubbed
- When the signal reception is weak
- When the signal reception is non-standard

(continued)

## Digital CC Settings

You can customize the closed caption display characteristics by changing the background color, opacity, text size, type, edge, and color.

### Note:

- This feature is available for digital channels only.
- You cannot set the Caption Text and Background as the same color.

Mode	Description
Caption Size	Auto, Small, Standard, Large
Caption Text Type	Auto, Default, Mono w. Serif, Prop. w. Serif, Mono w/o Serif, Prop. w/o Serif, Casual, Cursive, Small Capitals
Caption Text Edge	Auto, None, Raised, Depressed, Uniform, Left Drop Shadow, Right Drop shadow
Caption Text Color	Auto, Black, White, Red, Green, Blue, Yellow, Magenta, Cyan
Text Foreground Opacity	Auto, Transparent, Translucent, Flashing, Solid
Background Color	Auto, Black, White, Red, Green, Blue, Yellow, Magenta, Cyan
Text Background Opacity	Auto, Transparent, Translucent, Flashing, Solid
Caption Text Edge Color	Auto, Black, White, Red, Green, Blue, Yellow, Magenta, Cyan

### To customize the closed captions:

- 1 From the **Preferences** menu, highlight **Digital CC Settings** and press **ENTER**.
- 2 Press **▲** or **▼** to highlight the characteristic you want to change, and then press **◀** or **▶** to select the format for that characteristic (see table above).
- 3 To save the new settings, highlight **Done** and press **ENTER**. To revert to the factory defaults, highlight **Reset** and press **ENTER**.

## CC Selector

You can use the **CC Selector** to temporarily override the default analog caption mode (set in **Base CC Mode**) for a particular channel. However, once you change to another analog channel, the closed caption setting will automatically change back to the current **Base CC Mode** setting.

You can also use the **CC Selector** to select digital closed caption services (if available). When such services are not available, the **CC Selector** presents a default list of services. If the selected service is not available, the next best service will be used instead.

### To select closed captions:

- 1 From the **Preferences** menu, highlight **CC Selector** and press **ENTER**.
- 2 Press **▲** or **▼** to select **Closed Caption**, and then press **◀** or **▶** to select the desired service.
- 3 Press **EXIT**.

## Using the Closed Caption button on the remote control

### If you press **CCAPTION** when an analog channel is tuned:

- The CC selector will be active and will display CC1-4 and T1-4 as the options.
- The audio selector will be disabled.

### If you press **CCAPTION** when a digital channel is tuned:

- The CC selector will be active and will display the possible caption options (available languages) for that channel or service. For example, in addition to English, a channel might offer closed captions in Spanish and/or French.
- The audio selector will be active and will offer different audio choices for the digital channel (Dolby or AC3, for example).

## Adjusting the audio

### Muting the sound

Press **MUTE** on the remote control to partially reduce (1/2 MUTE) or turn off (MUTE) the sound. Each time you press **MUTE**, the mute mode will change in the following order:



If the closed caption mode is set to **Off** when you select “MUTE” mode, the closed caption feature is automatically activated if the TV program is Closed Captioned. To mute the audio without automatically activating the closed caption feature, use **VOL** to set the volume to 0. See “Using the closed caption mode” (page 49) for more information on closed caption modes.

## Using the digital audio selector

You can use the **Digital Audio Selector** to conveniently switch between audio tracks on a digital channel (for those channels that have multiple audio tracks). This temporarily overrides the audio track chosen by the language option under **Audio Setup** (see “Selecting stereo/SAP broadcasts” on page 51).

### To use the digital audio selector:

- 1 Press **MENU** and open the **Audio** menu.
- 2 Highlight **Digital Audio Selector** and press **ENTER**.

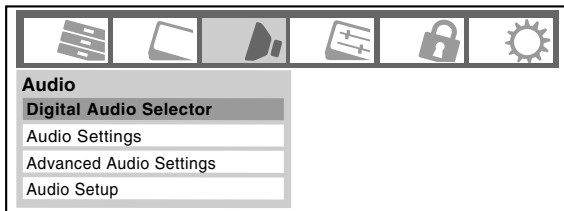

- 3 Press **▲** or **▼** to select **Audio**, and then press **◀** or **▶** to select the desired service.
- 4 Press **EXIT**.

## Selecting stereo/SAP broadcasts

The multi-channel TV sound (MTS) feature allows you to output high-fidelity stereo sound. MTS also can transmit a second audio program (SAP) containing a second language, music, or other audio information (when provided by individual stations).

When the TV receives a stereo or SAP broadcast, the word “STEREO” or “SAP” appears on-screen when **RECALL** is pressed. The MTS feature is only available for analog signals on the **ANT/CABLE** input.

### To listen to stereo sound:

- 1 From the **Audio** menu, highlight **Audio Setup** and press **ENTER**.
- 2 In the **MTS** field, select **Stereo**.
- 3 To save the new settings, highlight **Done** and press **ENTER**. To reset the settings to the factory defaults, highlight **Reset** and press **ENTER**.

#### Note:

- You can typically leave the TV in **Stereo** mode because it will automatically output the type of sound being broadcast (stereo or monaural).
- If the stereo sound is noisy, select **Mono** to reduce the noise.

### To listen to an alternate language on an ATSC digital station (if available):

Highlight the **Language** field in step 2 above, and then press **◀** or **▶** to select the language you prefer.

### To listen to a second audio program on an analog station (if available):

Select **SAP** in step 2.

#### Note:

- A second audio program (SAP) can be heard only on those TV stations that offer it. For example, a station might broadcast another language as a second audio program. If you have SAP on, you will see the current program on the screen but hear the other language instead of the program's normal audio.
- If you have SAP on and the station you are watching is not broadcasting a second audio program, the station's normal audio will be output. However, occasionally there is no sound at all in **SAP** mode. If this happens, set the **MTS** feature to **Stereo** mode.

## Adjusting the audio quality

You can adjust the audio quality by adjusting the bass, treble, and balance.

### To adjust the audio quality:

- 1 From the **Audio** menu, highlight **Audio Settings** and press **ENTER**.
- 2 Press **▼** or **▲** to highlight the item you want to adjust (**Bass**, **Treble**, or **Balance**).
- 3 Press **◀** or **▶** to adjust the level.
  - **◀** makes the bass or treble weaker or increases the balance in the left channel (depending on the item selected).
  - **▶** makes the bass or treble stronger or increases the balance in the right channel (depending on the item selected).
- 4 To save the new settings, highlight **Done** and press **ENTER**. To reset the settings to the factory defaults, highlight **Reset** and press **ENTER**.

(continued)

## Using the StableSound® feature

The StableSound® feature limits the highest volume level to prevent extreme changes in volume when the signal source changes (for example, to prevent the sudden increase in volume that often happens when a TV program switches to a commercial).

### To turn on the StableSound® feature:

- 1 From the **Audio** menu, highlight **Audio Settings** and press **ENTER**.
- 2 In the **StableSound** field, select **On**.
- 3 To save the new settings, highlight **Done** and press **ENTER**. To revert to the factory defaults, highlight **Reset** and press **ENTER**.

**Note:** The RESET function returns your audio adjustments to the following factory settings:

Bass . . . . . center (50)  
 Treble . . . . . center (50)  
 Balance . . . . . center (0)  
 StableSound . . Off

**Note:** This feature will be gray out in digital channels, to turn it **On** or **Off**, it's necessary to be tuned in an analog channel.

### To turn off the StableSound feature:

Select **Off** in step 2 above.

## Selecting the optical audio output format

You can use this feature to select the optical audio output format when you connect a Dolby Digital decoder or other digital audio system to the **DIGITAL AUDIO OUT** terminal on the TV (see "Connecting a digital audio system" on page 18).

### To select the optical audio output format:

- 1 From the **Audio** menu, highlight **Audio Setup** and press **ENTER**.
- 2 In the **Optical Output Format** field, select either **Dolby Digital** or **PCM**, depending on your device.
- 3 To save the new settings, highlight **Done** and press **ENTER**. To revert to the factory defaults, highlight **Reset** and press **ENTER**.

## Using the Dolby® Digital Dynamic Range Control feature

This dynamic range control feature causes the ATSC dynamic range to be further compressed, allowing you to switch from digital to analog broadcasts at the same dynamic range.

### To use the Dolby Digital Dynamic Range Control:

- 1 From the **Audio** menu, highlight **Audio Setup** and press **ENTER**.
- 2 In the **Dolby Digital Dynamic Range Control** field, select **Compressed**. When **Standard** is selected, the audio is output with minimal compression.
- 3 To save the new settings, highlight **Done** and press **ENTER**. To revert to the factory defaults, highlight **Reset** and press **ENTER**.

**Note:**

- This item will be grayed out for NTSC signals, Video, ColorStream, HDMI, and PC inputs.
- The Dolby Digital Dynamic Range Control will function in relation to Optical Output Format (PCM mode).

## Using the Locks menu

The Locks menu includes the Enable Rating Blocking, Edit Rating Limits, Channels Block, Input Lock, Control Panel Lock, Game Timer, and New PIN Code features. You can use these features after entering the correct PIN code.

### Entering the PIN code

- 1 On the remote control or TV control panel, press **MENU** and highlight the **Locks** menu icon.

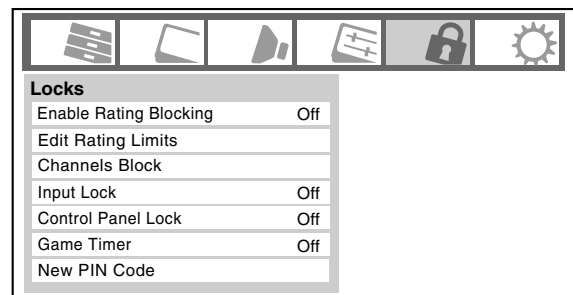

- 2 Press **▼**, which displays the PIN code entry screen.
- The **Lock System** screen (below) appears if a PIN code has not been stored. Press the Channel Number buttons to enter a new four-digit code, enter the code a second time to confirm, and press **ENTER**.

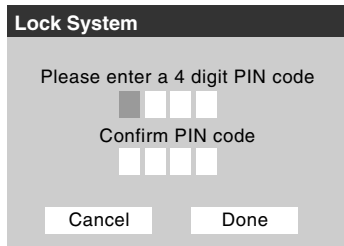

- The **Locks/Active** screen appears if the PIN code is already stored. Use the Number buttons to enter your four-digit code and press **ENTER**.

If the wrong PIN code is entered, the message “Incorrect PIN code, please try again!” appears. Highlight **Retry** and press **ENTER**. Enter the code again and press **ENTER**.

When the correct PIN code is entered, the **Locks** menu opens.

### If you cannot remember your PIN code

While the PIN code entering screen is displayed, press **RECALL** four times within five seconds. The PIN code will be cleared and you can enter a new PIN code.

### Changing your PIN code

- From the **Locks** menu, press **▼** to display the PIN code entering screen.
- Enter your four-digit PIN code and press **ENTER**.
- Press **▼** to highlight **New PIN Code** and press **ENTER**.
- Press the Number buttons to enter a new four-digit code. Reenter the PIN code to confirm it.
- Press **ENTER**. The new PIN code is now active.

### Blocking TV programs and movies by rating (V-Chip)

Some TV programs and movies include signals that classify the content of the program (violence, sex, dialog, language). The V-Chip feature in this TV detects the signals and blocks the programs according to the ratings you select. (For rating descriptions, see the tables on the next page.)

**Note:** Rating blocking is a function of the V-Chip feature in this TV, which supports the U.S. V-Chip system only.

#### To block and unblock TV programs and movies:

- From the **Locks** menu, press **▼** to display the PIN code entering screen.
- Enter your four-digit PIN code and press **ENTER**.
- Press **▼** to highlight **Enable Rating Blocking**.
- Press **▶** and **▼** to select **On**, and then press **ENTER**.
- Press **▼** to highlight **Edit Rating Limits** and press **ENTER**. The **Edit Rating Limits** screen appears.
- Press **▲▼◀▶** and then press **ENTER** to select the level of blocking you prefer. A box with an “X” is a rating that will be blocked. As you highlight a rating, a definition for the rating appears at the bottom of the screen.
- When done selecting the ratings you want to block, highlight **Done** and press **ENTER**.

(continued)

## Downloading an additional rating system for blocking TV programs and movies

In the future, an additional rating system may become available for use in selectively blocking programs.

**Note:** The currently tuned station must be receiving a digital signal before an additional rating system can be downloaded.

### To download the additional rating system (if available):

- 1 From the **Locks** menu, press ▼ to display the PIN code entering screen.
- 2 Enter your four-digit PIN code and press **ENTER**.
- 3 Press ▼ to highlight **Enable Rating Blocking**.
- 4 Press ► and ▼ to select **On**, and press **ENTER**.
- 5 Press ▼ to highlight **Edit Rating Limits** and press **ENTER**. The **Edit Rating Limits** screen appears.
- 6 Highlight **Alt RS** and press **ENTER**. The **Edit Alternate Ratings** screen will appear.
 

**Note:**

  - The **Alt RS** button will only be available if an additional rating system is currently available.
  - It may take several minutes for the TV to download the additional rating system.
  - The information displayed in the **Alternate Ratings** screen will depend on the configuration of the additional rating system available at the time of download.
- 7 Press ▲▼◀▶ and then press **ENTER** to select the level of blocking you prefer. A box with an "X" is a rating that will be blocked.
- 8 When you are finished selecting the ratings you want to block, highlight **Done** and press **ENTER**.
- 9 In the **Edit Rating Limits** screen, highlight **Done** and press **ENTER**.

**Note:**

- The additional rating system can only be downloaded one time. You will not be able to download any updates to the rating system should such updates become available.
- The additional rating system is not designed, transmitted, or controlled by the TV or Toshiba, nor is the availability of an additional rating system determined or controlled by Toshiba. Similarly, the rating of programs in an additional rating system is not determined, transmitted, or controlled by the TV or Toshiba.
- The additional rating system is an evolving technology; therefore, availability, content, and format may vary.

Independent rating system for broadcasters	
Ratings	Description and Content themes
<b>TV-MA</b>	Mature Audience Only (This program is specifically designed to be viewed by adults and therefore may be unsuitable for children under 17.) <b>L</b> ) Crude or indecent language <b>S</b> ) Explicit sexual activity <b>V</b> ) Graphic violence
<b>TV-14</b>	Parents Strongly Cautioned (This program contains some material that many parents would find unsuitable for children under 14 years of age.) <b>D</b> ) Intensely suggestive dialog <b>L</b> ) Strong, coarse language <b>S</b> ) Intense sexual situations <b>V</b> ) Intense violence
<b>TV-PG</b>	Parental Guidance Suggested (This program contains material parents may find unsuitable for younger children.) <b>D</b> ) Some suggestive dialog <b>L</b> ) Infrequent coarse language <b>S</b> ) Some sexual situations <b>V</b> ) Moderate violence
<b>TV-G</b>	General Audience (Most parents would find this program suitable for all ages.)
<b>TV-Y7, TV-Y7FV</b>	Directed to Older Children (This program is designed for children age 7 and above. Note: Programs in which fantasy violence may be more intense or more combative than other programs in this category are designated TV-Y7FV.)
<b>TV-Y</b>	All Children (This program is designed to be appropriate for all children.)

Independent rating system for movies	
Ratings	Description and Content themes
<b>X</b>	X-rated (For adults only)
<b>NC-17</b>	Not intended for anyone 17 and under
<b>R</b>	Restricted (Under 17 requires accompanying parent or adult)
<b>PG-13</b>	Parents Strongly Cautioned (Some material may be inappropriate for children under 13)
<b>PG</b>	Parental Guidance Suggested (Some material may not be suitable for children)
<b>G</b>	General Audience (Appropriate for all ages)

**Note:**

- If you place an "X" in the box next to "None Rated," programs rated "None" will be blocked; however, programs that do not provide any rating information will not be blocked.
- To display the rating of the program you are watching, press **RECALL** on the remote control. If it is rated "None," the word "NONE" appears in the **RECALL** screen (as shown below right). If rating information is not provided, no rating will appear in the **RECALL** screen.

TV - PG L V

NONE

## Blocking channels

With the Channels Block feature, you can block specific channels. You will not be able to tune blocked channels unless you unlock them.

### To block channels:

- 1 From the **Locks** menu, press ▼ to display the PIN code entering screen.
- 2 Enter your four-digit PIN code and press **ENTER** (see page 52).
- 3 Press ▼ to highlight **Channels Block** and then press **ENTER**. A list of the channels available for that input will be displayed along with the call letters for each channel, if available.
- 4 Press ▲▼ to highlight the channel you want to block and press **ENTER**, which puts an "X" in the box next to that channel.
- 5 Repeat step 4 for other channels you want to block.
- 6 Highlight **Done** and press **ENTER**.

### To unblock individual channels:

In step 4 above, press ▲▼ to highlight the channel you want to unblock, press **ENTER** to remove the "X" from the box, highlight **Done** and press **ENTER**.

### To block all channels at once:

Highlight **Block All** in step 4 above and then highlight **Done** and press **ENTER**.

### To unblock all locked channels at once:

Highlight **Allow All** in step 4 above and then highlight **Done** and press **ENTER**.

## Unlocking programs temporarily

If you try to tune the TV to a program that exceeds the rating limits you set, the TV will enter program lock mode and the following message will appear on-screen:

This program exceeds the rating limit you set.  
Push 'mute' to enter PIN.

You can either temporarily unlock the program or select an unlocked program to watch.

### To temporarily unlock the program:

- 1 Press **MUTE**.
- 2 Enter your four-digit PIN code and press **ENTER**. If the correct code is entered, the program lock mode is released and the normal picture appears. All locking is disabled until the TV is turned off, and will be enabled when the TV is turned on again.

## Using the input lock feature

You can use the Input Lock feature to lock the video inputs (**Video 1, Video 2, ColorStream HD1, ColorStream HD2, HDMI 1, HDMI 2, HDMI 3, and PC**) and channels 3 and 4. You will not be able to view the input sources or channels until you unlock the inputs.

### To lock/unlock the video inputs:

- 1 From the **Locks** menu, press ▼ to display the PIN code entering screen.
- 2 Enter your four-digit PIN code and press **ENTER**.
- 3 Press ▼ to highlight **Input Lock** and press ►.
- 4 Press ▲ or ▼ to select the level of video input locking you prefer, as described below.

Mode	Description
Video	Locks Video 1, Video 2, ColorStream HD1/HD2, HDMI 1, HDMI 2, HDMI 3, and PC.
Video+	Locks Video 1, Video 2, ColorStream HD1/HD2, HDMI 1, HDMI 2, HDMI 3, PC and channels 3 and 4. <ul style="list-style-type: none"> <li>• Select <b>Video+</b> if you play video tapes via an ANT/CABLE input.</li> </ul>
Off	Unlocks all video inputs and channels 3 and 4.

- 5 Press **ENTER**.

## Using the GameTimer®

You can use the GameTimer to set a time limit for playing a video game (30–120 minutes). When the GameTimer expires, the TV enters Input Lock mode and locks out the input source for the video game device.

### To set the GameTimer®:

- 1 From the **Locks** menu, press ▼ to display the PIN code entering screen.
- 2 Enter your four-digit PIN code and press **ENTER**.
- 3 Press ▼ to highlight **Game Timer** and press ►.
- 4 Press ▲ or ▼ to select the length of time until the Input Lock is activated (30, 60, 90, or 120 minutes) and press **ENTER**.

### To cancel the GameTimer®:

Select **Off** in step 4 above.

(continued)

### To deactivate the Input Lock once the GameTimer has activated it:

Set the **Input Lock** to **Off** (☞ “Using the input lock feature” as described above).

**Note:**

- A message will appear when 10 minutes, 3 minutes, and 1 minute remain on the GameTimer.
- If the TV loses power with time remaining on the GameTimer, when power is restored the TV will enter Input Lock mode (as if the GameTimer had been activated) and you will have to deactivate the Input Lock (as described above).

### Using the control panel lock feature

You can lock the control panel to prevent your settings from being changed accidentally (by children, for example). When the control panel lock is **On**, none of the controls on the TV control panel will operate except **POWER**.

#### To lock the control panel:

- 1 From the **Locks** menu, press ▼ to display the PIN code entering screen.
- 2 Enter your four-digit PIN code and press (ENTER).
- 3 Press ▼ to highlight **Control Panel Lock**.
- 4 Press ► and ▲ ▼ to highlight **On** and press (ENTER). When the control panel is locked and any button on the control panel (except **POWER**) is pressed, the message “Not Available” appears.

#### To unlock the control panel:

Highlight **Off** in step 4 above, or press and hold the **VOLUME –** button on the TV control panel for about 10 seconds until the volume icon appears.

## Using the PC settings feature

You can view an image from a PC on the TV screen.

When a PC is connected to the TV's PC IN terminal, you can use the PC Settings feature to make adjustments to the image. If the edges of the picture are cut off, readjust the **Horizontal Position** and **Vertical Position**. If the picture is affected by interference, readjust the **Clock Phase** and **Sampling Clock**.

#### To adjust the PC settings:

- 1 Select PC input mode (☞ “Selecting the video input source to view” page 41).
- 2 From the **Setup** menu, highlight **PC Settings** and press (ENTER).
- 3 Press ▲ or ▼ to highlight the item you want to adjust.
- 4 Press ◀ or ▶ to make the appropriate adjustments.

**Note:** If a PC is not connected or there is no pc input signal, this feature will be grayed out in the **Setup** menu.

**Note:** The screen is disrupted momentarily when adjusting the PC settings. This is not a sign of malfunction.

Mode	Description
Horizontal Position	Moves the picture left/right. The adjustment range is within ±10 from center.*
Vertical Position	Moves the picture up/down. The adjustment range is within ±10 from center.*
Clock Phase	Helps to reduce noise and sharpen the picture. The adjustment range is within ±32 from center.*
Sampling Clock	Helps to reduce noise and minimize periodic vertical stripes on the screen. The adjustment range is within ±5 from center.*





\* The default settings and /or adjustment range vary depending on the input signal format.



## Setting the PC Audio

This function allows you to output or mute the sound from your PC when connecting using the PC IN terminal and an analog RGB cable.

### To set the PC Audio:





- 1 From the **Audio** menu, highlight **Audio Setup** and press .
- 2 Press  or  to select **PC Audio** and then press  or  to select **No** or **Yes**.  
**Yes:** When viewing the PC input, the audio from the PC Audio input can be heard.  
**No:** When viewing the PC input, there will be no audio.

**Note:** Because the PC and HDMI 1 inputs share the same set of analog audio inputs, the **PC Audio** menu setting influences the **HDMI 1 Audio** menu setting. If **PC Audio** is set to "No," the **HDMI 1 Audio** setting changes to "Auto." If **PC Audio** is set to "Yes," the **HDMI 1 Audio** setting is set to "Digital" and is grayed out in the menu. (Also see item 5 on page 11 and "Setting the HDMI™ audio mode" on page 39.)



## Setting the sleep timer

You can set the sleep timer to turn off the TV after a set length of time (maximum of 180 minutes).

### To set the sleep timer using the remote control:

Press  on the remote control to set the length of time until the TV turns off. Repeatedly press  to increase the time in 10-minute increments, or press  or  to increase or decrease the time in 10-minute increments, to a maximum of 180 minutes.

### To set the sleep timer using the on-screen menus:

- 1 From the **Setup** menu, highlight **Sleep Timer** and press .
  - 2 Press the Number buttons to enter the length of time in 10-minute increments.
  - 3 Highlight **Done** and press .
- Note:** When a power failure occurs, the sleep timer setting may be cleared.

### To display the remaining sleep time:

Press .

**Note:** A message will display on-screen when there is one minute remaining on the sleep timer.

### To cancel the sleep timer:

Repeatedly press  until it is set to 0 minute.

## Using REGZA-LINK

This is a new feature that uses CEC technology and allows you to control Toshiba REGZA-LINK compatible devices from the TV remote via HDMI connection ( page 17).











When the **Enable REGZA-LINK** in the **REGZA-LINK Setup** menu ( page 58) is set to **On**, the following REGZA-LINK functions will be enabled.

### REGZA-LINK playback device (HD DVD player, etc.) control

With your TV's remote control, or using the **REGZA-LINK Player Control** menu, you can control the connected REGZA-LINK playback device you are watching.

#### Available remote control key functions:

Before using the following key functions, first set the MODE SELECT switch on the remote control to **TV**.

Button	Description
	Begins playback.
	Stops playback.
	Pauses the picture during play or record mode.
	Skips forward.
	Skips backward.
	Fast-forwards.
	Rewinds/reverses.
	Navigate contents menu, etc.
	Enters contents menu, etc.
	Returns to the previous menu.

**Note:** These functions depend on the devices connected.

(continued)

**REGZA-LINK Player Control menu functions:**

- 1 Press **THINC** and open the **THINC Applications** menu.
- 2 Highlight **REGZA-LINK Player Control** and press **ENTER**.
- 3 Press **▲** or **▼** to select the item you want to control and press **ENTER**.

Item	Description
Power	Turns the select device on and off.
Top Menu	Accesses the top menu of a DVD.
Menu	Accesses the menu of a DVD.
Contents Menu	Accesses the contents list when you press <b>ENTER</b> . At this time, the <b>REGZA-LINK Player Control</b> menu will disappear.

**Note:**

- These functions depend on the devices that are connected.
- The REGZA-LINK Player Control item will be grayed out in the following conditions:
  - A non-HDMI input is currently selected.
  - The **Enable REGZA-LINK** item is set to **Off**.
  - The connected CEC device is not a playback or recording device.

**REGZA-LINK input source selection**

If a REGZA-LINK device with HDMI switching capability (e.g. Audio Receiver) is connected to the HDMI input, you can select another REGZA-LINK device that is connected to the master HDMI device using the TV's INPUT button. See page 41 for details.

**VOLUME and MUTE controls of Audio Receiver**

With your TV's remote control, you can adjust or mute the sound volume of the Audio Receiver. First, set the MODE SELECT switch on the remote control to **TV**.

- **[+VOL]** **[VOL]** adjust the volume level.
- **[MUTE]** turns off the sound.

**Note:**

- To use this function:
  - Set **Speaker Preference** to **Audio Receiver** in the **REGZA-LINK Setup** menu.
  - Confirm that a connected REGZA-LINK device (such as HD DVD player, etc) is selected for the Audio Receiver input source.
- You can also use this function when the audio receiver is connected to the TV's **DIGITAL AUDIO OUT** terminal (not HDMI connection). In this case, select a digital audio input mode on the Audio Receiver.
- These functions depend on the device connected.

**Other REGZA-LINK functions**

When the **Enable REGZA-LINK** and each item in the **REGZA-LINK Setup** menu are set to **On**, the following functions will be enabled.

Item	Description
TV Auto Input Switch	If a connected HDMI device starts playing video or audio, the TV will automatically switch to the appropriate HDMI input.
TV Auto Power	If a REGZA-LINK device is turned on the TV turns on automatically.
Device Auto Standby	If the TV is turned off, the TV will send a message to turn off all of the REGZA-LINK devices connected to the TV.
Speaker Preference	From this item, you can set your audio output preference to the TV speakers or the audio receiver speakers. When this item is set to Audio Receiver, the TV remote can be used to adjust or mute the volume of the audio. This item will be grayed out unless a REGZA-LINK compatible audio receiver is connected.

**Note:** When you turn on the Audio Receiver, change its input source, or adjust the sound volume, the sound will be output from the audio receiver's speakers even if **TV Speakers** has been selected. Turn the TV off and on again to output the sound from the TV speakers.

### To set the REGZA-LINK Setup:

- 1 From the **Setup** menu, highlight **REGZA-LINK Setup** and press **ENTER**.
- 2 Press **▲** or **▼** to highlight **Enable REGZA-LINK**.
- 3 Press **◀** or **▶** to select **On**.  
*Note: if you set **Enable REGZA-LINK** to **Off**, the other items will be grayed out.*
- 4 Press **▲** or **▼** to highlight the **REGZA-LINK** setup item you want to use, and press **◀** or **▶** to select **On** or desired mode.
  - TV Auto Input Switch: On/Off
  - TV Auto Power: On/Off
  - Device Auto Standby: On/Off
  - Speaker Preference: TV Speakers/Audio Receiver
- 5 To save the new settings, highlight **Done** and press **ENTER**. To revert to the factory defaults, highlight **Reset** and press **ENTER**.

## Using the HDMI settings feature

This menu consists of the following 3 items (new HDMI capabilities) and will be grayed out on non-HDMI inputs. Some HDMI legacy sources may not work properly with your HDMI TV, please try setting the following options (Lip-Sync Latency, Deep Color, and x.v.Color) to **Off**. Adjusting these settings should allow your HDMI legacy source to operate properly with your TV.

*Note: You must disconnect your source device first before settings can be adjusted.*

- **Lip-Sync Latency: On**  
This option activates an auto audio/video display timing adjustment function that allows HDMI source devices to accurately perform synchronization automatically.
- **Deep Color: On**  
This feature allows the HDMI source to increase available colors bits within the boundaries defined by the RGB or YCbCr color space.
- **x.v.Color: On**  
This feature expands the acceptable color range (limits) in the HDMI signals, then allows sending wider color signals from HDMI source.

All above HDMI settings need proper HDMI source device. If HDMI source products does not support these features, the TV may not work properly by activating these features.

*Note: If your HDMI connection is capable of 1080p and/or your TV is capable of refresh rates greater than 60Hz or supports Deep Color, you will need a Category 2 cable. Conventional HDMI/DVI cables may not work properly with this mode.*

### To set the HDMI Settings:

- 1 Select the appropriate HDMI input mode (**HDMI 1**, **HDMI 2** or **HDMI 3**).
- 2 From the **Setup** menu, highlight **HDMI Settings** and press **ENTER**.
- 3 Press **▲** or **▼** to highlight the item you want to set.
- 4 Press **◀** or **▶** to select **On** or **Off**.
- 5 To save the new settings, highlight **Done** and press **ENTER**. To revert to the factory defaults, highlight **Reset** and press **ENTER**.

## Displaying TV status information

### To display TV status information using RECALL:

Press **RECALL** on the remote control.

The following information will display (if applicable):

- Current input (**ANT/CABLE**, **Video 1**, etc.)
- If ANT/CABLE is the current input, either “CABLE” (for cable TV) or “ANT” (for over-the-air broadcasts).
- Channel number (if in **ANT/CABLE** mode)
- Channel label (if set)
- Digital signal strength indicator (bar graph in lower right corner of box; for ATSC signal only)
- Stereo, Mono or SAP audio status (when HDMI input mode, Dolby Digital or PCM)
- Video resolution
- Aspect ratio of incoming video signal (4:3 or 16:9)
- V-Chip rating status
- GameTimer (if set)
- x.v.Color status of incoming signal



### To close the RECALL screen:

Press **RECALL** again.

### To display TV status information using INFO:

(only available for ANT/CABLE input)

Press **INFO** on the remote control.

The following additional information will display for off air digital channels (if applicable):

- Title
- Duration
- Detailed description

To display Next information, press **INFO** on the remote control again. Pressing **INFO** a third time will remove the entire banner.



**Note:** The location of the banner can be moved to the top or bottom of the screen by pressing **▲** or **▼** while the **RECALL** or **INFO** display is on-screen. (The last position will be stored to memory.)

## Understanding the auto power off feature

The TV will automatically turn itself off after approximately 15 minutes if it is tuned to a vacant channel or a station that completes its broadcast for the day. This feature functions in **ANT/CABLE** mode only.

## Understanding the last mode memory feature

**If the power is cut off while you are viewing the TV, the Last Mode Memory feature automatically turns on the TV when the power is resupplied.**

**Note:** If it's possible, and you will be away from the TV for an extended period of time you should unplug the power cord.

# Chapter 7: Using the TV's advanced features

## Using the advanced picture settings features

### Using dynamic contrast

When dynamic contrast is set to **Low**, **Middle**, or **High**, the TV will detect changes in the picture quality that affect the appearance of your contrast settings and then automatically adjust the video.

To select dynamic contrast preferences:

- 1 Press **MENU** and open the **Video** menu.
- 2 Highlight **Picture Settings** and press **ENTER**.

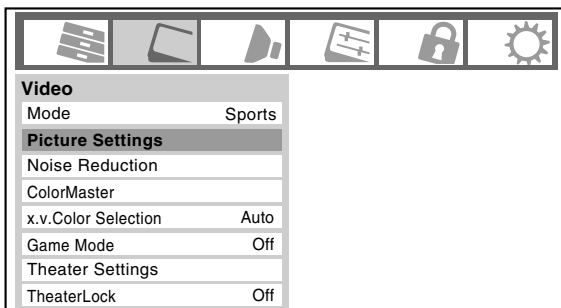

- 3 Highlight **Advanced Picture Settings** and press **ENTER**.
- 4 In the **Dynamic Contrast** field, select either **Off**, **Low**, **Middle** or **High**.
- 5 To save the new settings, highlight **Done** and press **ENTER**. To revert to the factory defaults, highlight **Reset** and press **ENTER**.

**Note:** If you select one of the factory-set picture modes (**Sports**, **Standard**, **Movie** or **PC**) and then change the dynamic contrast setting, the picture mode automatically changes to **Preference**.

### Using the static gamma feature

The static gamma feature allows you to adjust the levels of black in the picture.

To adjust the static gamma settings:

- 1 From the **Video** menu, highlight **Picture Settings** and press **ENTER**.
- 2 Highlight **Advanced Picture Settings** and press **ENTER**.
- 3 In the **Static Gamma** field, press **◀** or **▶** to adjust the static gamma.

The adjustment range is within  $\pm 4$  from center.

- If the setting is moved in the minus direction, the detail of black colors will be decreased.
- If the setting is moved in the plus direction, the detail of black colors will be increased.

- 4 To save the new settings, highlight **Done** and press **ENTER**. To revert the factory defaults, highlight **Reset** and press **ENTER**.

**Note:** If you select one of the factory-set picture modes (**Sports**, **Standard**, **Movie** or **PC**) and then change the static gamma setting, the picture mode automatically changes to **Preference**.

### Selecting the color temperature

You can change the quality of the picture by selecting from three preset color temperatures (Cool, Medium, and Warm), as described below.

Mode	Picture Quality
Cool	blueish
Medium	neutral
Warm	reddish

To select the color temperature:

- 1 From the **Video** menu, highlight **Picture Settings** and press **ENTER**.
- 2 Highlight **Advanced Picture Settings** and press **ENTER**.
- 3 Highlight **Color Temperature** and press **ENTER**.
- 4 In the **Color Temperature** field, select the mode you prefer (**Cool**, **Medium**, or **Warm**).
- 5 Press **▲** or **▼** to select either **B Drive** or **G Drive**, and then press **◀** or **▶** to adjust the settings.
  - B Drive: **▶** makes the picture blueish.
  - G Drive: **▶** makes the picture greenish.

**Note:** The **B Drive** and **G Drive** settings are connected to the **Color Temperature** settings and will change based on which setting is selected in step 4 above.

- 6 To save the new settings, highlight **Done** and press **ENTER**. To revert to the factory defaults, highlight **Reset** and press **ENTER**.

**Note:** If you select one of the factory-set picture modes (**Sports**, **Standard**, **Movie** or **PC**) and then change the color temperature mode, the picture mode automatically changes to **Preference**.

(continued)

## Selecting the cinema mode (480i and 1080i signals)

When you view a DVD (3:2 pulldown processed) from a DVD player connected to the **Video 1**, **Video 2**, **ColorStream HD1**, **ColorStream HD2** (component video), or **HDMI** inputs on the TV, smoother motion can be obtained by setting the **Cinema Mode** to **Film**.

### To set the Cinema Mode to Film:

- 1 From the **Video** menu, highlight **Picture Settings** and press **ENTER**.
- 2 Highlight **Advanced Picture Settings** and press **ENTER**.
- 3 In the **Cinema Mode** field, select **Film**.
- 4 To save the new settings, highlight **Done** and press **ENTER**. To revert to the factory defaults, highlight **Reset** and press **ENTER**.

### To set the Cinema Mode to Video:

Select **Video** in step 3 above.

## Using the ClearFrame™ feature

The new ClearFrame 120 Hz anti-blur technology doubles the frame rate from 60 frames per second to 120 frames per second, virtually eliminating motion blur without adding flicker or reducing image brightness.

### To turn on the ClearFrame:

- 1 From the **Video** menu, highlight **Picture Settings** and press **ENTER**.
- 2 Highlight **Advanced Picture Settings** and press **ENTER**.
- 3 In the **ClearFrame** field, select **On**.
- 4 To save the new settings, highlight **Done** and press **ENTER**. To revert to the factory defaults, highlight **Reset** and press **ENTER**.

#### Note:

- If you select one of the factory-set picture modes (**Sports**, **Standard**, **Movie** or **PC**) and then change the ClearFrame setting, the picture mode automatically changes to Preference.
- When **ClearFrame** is set to **Off**, the Film Stabilization feature will not be available (grayed out and set to Off).

## Using the Film Stabilization feature

This feature helps to eliminate video shaking that can occur when **Cinema Mode** is set to **Film** (3:2 pull down process enabled).

### To turn on Film Stabilization:

- 1 From the **Video** menu, highlight **Picture Settings** and press **ENTER**.
- 2 Highlight **Advanced Picture Settings** and press **ENTER**.
- 3 In the **Film Stabilization** field, select **Smooth**.
- 4 To save the new settings, highlight **Done** and press **ENTER**. To revert to the factory defaults, highlight **Reset** and press **ENTER**.

#### Note:

- If you select one of the factory-set picture modes (**Sports**, **Standard**, **Movie** or **PC**) and then change the Film Stabilization setting, the picture mode automatically changes to Preference.
- When **Cinema Mode** is set to **Video** or **ClearFrame** is set to **Off**, **Film Stabilization** will be grayed out and set to off automatically.

## Using CableClear® digital noise reduction

The CableClear® digital noise reduction feature allows you to reduce visible interference in your TV picture. This may be useful when receiving a broadcast with a weak signal (especially a Cable channel) or playing a noisy video cassette or disc.

### To change the CableClear settings:

- 1 From the **Video** menu, highlight **Noise Reduction** and press **ENTER**.
- 2 In the **CableClear** field, select your desired setting.

#### Note:

- If the current input is **ANT/CABLE**, **Video 1**, or **Video 2**, the menu will display the text "CableClear." The available selections are **Off**, **Auto**, **Low**, **Middle**, and **High**.
  - If the current input is **ColorStream HD1**, **ColorStream HD2**, **HDMI 1**, **HDMI 2** or **HDMI 3**, the menu will display the text "DNR." The available selections are **Off**, **Auto**, **Low**, **Middle**, and **High**. **Auto** will react proportionally to the strength of the noise. **Low**, **Middle**, and **High** will reduce the noise in varying degrees, from lowest to highest, respectively.
- 3 To save the new settings, highlight **Done** and press **ENTER**. To revert to the factory defaults, highlight **Reset** and press **ENTER**.

## Using MPEG noise reduction

The MPEG noise reduction feature allows you to reduce visible interference caused by MPEG compression. Choices for MPEG noise reduction are **Off**, **Low**, **Middle**, and **High**. **Off** is automatically selected when this feature is disabled ("grayed out").

### To select the MPEG noise reduction level:

- 1 From the **Video** menu, highlight **Noise Reduction** and press **ENTER**.
- 2 Press **▲** or **▼** to highlight the **MPEG Noise Reduction** field, and then press **◀** or **▶** to select either **Off**, **Low**, **Middle** or **High**.
- 3 To save the new settings, highlight **Done** and press **ENTER**. To revert to the factory defaults, highlight **Reset** and press **ENTER**.

## Using the ColorMaster™ feature

The ColorMaster feature allows you to adjust standard colors. The menu will consist of 3 items: ColorMaster, Color Palette Adjustment, and Reset.

### To turn on ColorMaster:

- 1 From the **Video** menu, highlight **ColorMaster** and press **ENTER**.
- 2 In the **ColorMaster** field, select **On**.

**Note:** If you select one of the factory-set picture modes (**Sports**, **Standard**, **Movie** or **PC**) and then change the ColorMaster setting, the picture mode automatically changes to **Preference**.

### To turn off ColorMaster:

Select **Off** in Step 2 above.

## Using Color Palette Adjustment

When color palette adjustment is selected, the list of base colors will be displayed. You can select a base color to adjust.

**Note:** To use **Color Palette Adjustment**, **ColorMaster** must be set to **On**.

### To adjust the Base Colors:

- 1 From the **ColorMaster** menu, highlight **Color Palette Adjustment** and press **ENTER**.
- 2 The **Select Standard Color** window will be displayed. Press **▲** or **▼** to highlight the color you want to adjust, and then press **ENTER**.
- 3 The **Color Adjustment** window will be displayed. Press **FREEZE** to freeze the picture. To return to moving picture, press **FREEZE** again.

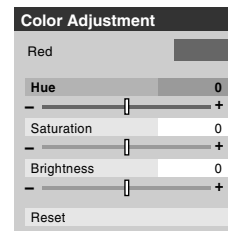

- 4 Press **▲** or **▼** to select either **Hue**, **Saturation**, or **Brightness**, and then press **◀** and **▶** to adjust the setting.
 

**Note:** To revert to the factory settings of the **Hue**, **Saturation**, and **Brightness** for the selected color, Highlight **Reset** and press **ENTER**.
- 5 Press **CH RTN** to return to the previous menu.
- 6 Repeat steps 2 through 5 to adjust any other color.

### To reset ColorMaster to its factory settings:

- 1 From the **ColorMaster** menu, highlight **Reset**, and then press **ENTER**.
- 2 A confirmation message will appear. Highlight **OK**, and then press **ENTER**.
- 3 Press **EXIT**.

(continued)

## Using x.v.Color Selection feature

The color range “x.v.Color” is an international standard and enables a wider color range than conventional video applications.

When set to **Auto**, picture settings are automatically set when an x.v.Color signal is detected.

When set to **On**, x.v.Color detection does not occur, so picture settings are always adjusted for x.v.Color.

When set to **Off**, normal processing occurs.

**Note:** If a non-HDMI input is selected or the **x.v.Color** setting in the **HDMI Settings** menu is set to **Off**, this feature will appear grayed out in the **Video** menu.

### To change the x.v.Color Selection:

- 1 Press **MENU**, and open the **Video** menu.
- 2 Press **▲** or **▼** to highlight **x.v.Color Selection**, press **▶**, and then press **▲** or **▼** to select the settings you prefer (**Auto**, **On** or **Off**), and press **ENTER**.

“x.v.Color” and the “x.v.Color” logo are trademarks of Sony Corporation.

## Using the Game Mode feature

You can use the Game Mode feature for shorter frame delays when playing a video game requiring split-second timing between the on-screen display and input from the controller (such as music creation and high-action games).

This feature is more effective for 480i and 1080i input signals.

**Note:** To use the Game Mode feature, the current video input must be **Video 1**, **Video 2**, **ColorStream HD1**, **ColorStream HD2**, **HDMI 1**, **HDMI 2**, **HDMI 3**, or **PC**. The Game Mode cannot be turned on when the **ANT/CABLE** input is selected.

### To turn on Game Mode:

- 1 From the **Video** menu, press **▲** or **▼** to highlight the **Game Mode** field, press **▶** and **▲** **▼** to select **On**, and press **ENTER**.

### To turn off Game Mode:

Select **Off** in step 1 above, change the video input, or turn the TV off and then on again.

**Note:** You can change the video input by pressing **INPUT** on the remote control (page 41).

## Using the advanced audio settings features

### Using the SRS WOW® surround sound feature

SRS WOW® is a special combination of SRS Labs audio technologies (SRS 3D®, SRS Focus®, and SRS TruBass®) that creates a thrilling surround sound experience with deep, rich bass from stereo sound sources. Your TV's audio will sound fuller, richer, and wider.

### To adjust the WOW® settings:

- 1 Put the TV in **STEREO** mode (page 51) “Selecting stereo/SAP broadcasts” on page 51).
- 2 From the **Audio** menu, highlight **Advanced Audio Settings** and press **ENTER**.
- 3 Press **▼** or **▲** to highlight the feature you want to adjust, and then press **◀** or **▶** to adjust the item.

Mode	Description
WOW: SRS 3D	To turn the surround sound effect <b>On</b> or <b>Off</b> . <b>Note:</b> If the broadcast is monaural, the Stereo Extension effect will not work.
WOW: SRS Focus	To turn the vocal emphasis effect <b>On</b> or <b>Off</b> .
WOW: SRS TruBass	To select the desired bass expansion level ( <b>Off</b> , <b>Low</b> , or <b>High</b> ).

**Note:** If the broadcast is monaural, the SRS 3D effect will not work.

- 4 To save the new settings, highlight **Done** and press **ENTER**. To revert to the factory defaults, highlight **Reset** and press **ENTER**.

WOW, SRS and **●** symbol are registered trademarks of SRS Labs, Inc.  
WOW technology is incorporated under license from SRS Labs, Inc.



# Chapter 8: Troubleshooting

## General troubleshooting

Before calling a service technician, please check this chapter for a possible cause of the problem and some solutions you can try.

### Black box on-screen

- The closed caption feature is set to one of the Text modes (**T1**, **T2**, **T3**, or **T4**). Set the closed caption feature to **Off** (ⓘ page 49).

### TV stops responding to controls

- If the TV stops responding to the controls on the remote control or TV control panel and you cannot turn off the TV, press and hold the **POWER** button on the TV control panel for 5 or more seconds to reset the TV.

### Other problems

- If your TV's problem is not addressed in this Troubleshooting section or the recommended solution has not worked, use the Restore Factory Defaults procedure (ⓘ page 40).

### TV will not turn on

- Make sure the power cord is plugged in, and then press **POWER**.
- The remote control batteries may be dead. Replace the batteries or try the control panel buttons.

### Picture problems

#### General picture problems

- Check the antenna/cable connections (ⓘ Chapter 2).
- Press **INPUT** on the remote control or TV and select a valid video input source (ⓘ page 41). If no device is connected to a particular input on the TV, no picture will display when you select that particular input source. For device connection details, see Chapter 2.
- Antenna reception may be poor. Use a highly directional outdoor antenna (if applicable).
- The station may have broadcast difficulties. Try another channel.
- Adjust the picture qualities (ⓘ page 48).
- If you are using a VCR, make sure **TV/VCR** on the remote control is set correctly (ⓘ page 21).
- Do not connect both a standard video cable and an S-video cable to the **VIDEO 1** input at the same time (ⓘ page 13).

#### Noisy picture

- If you are watching an analog channel (off-air broadcast or Cable TV), you can set the **CableClear®/DNR** feature to **AUTO** to reduce visible interference in the TV picture (ⓘ page 62).

#### Video Input Selection problems

- If the **Input Selection** window does not appear when you press **INPUT** on the remote control or TV, press **INPUT** a second time, which will change to the next video input source and display the **Input Selection** window.

#### Cannot view external signals or channel 3 or 4

- If you cannot view signals from external devices connected to **VIDEO 1**, **VIDEO 2**, **ColorStream®**, **HDMI 1**, **HDMI 2**, **HDMI 3**, **PC** or from channels 3 or 4, make sure the **Input Lock** is set to **Off** (ⓘ page 55).

#### Poor color or no color

- The station may have broadcast difficulties. Try another channel.
- Adjust the **Tint** and/or **Color** (ⓘ page 48).

#### Poor composite or S-video picture

- If the TV is connected to an external A/V device (e.g., DVD player, video game system, set-top box, etc.) try using a **ColorStream** or **HDMI** video connection instead.
- If you connect an S-video cable, be sure to disconnect the standard (composite) video cable. Do not connect both types of video cable at the same time.

#### Picture and sound are out of sync

- As with all products that contain a digital display, in rare instances, when viewing certain content (e.g., television broadcasts, video games, DVDs), you may notice that the sound and picture are slightly out of sync. This phenomenon can be caused by various factors including, without limitation, video processing within the TV, video processing in an attached gaming system, and video processing or different compression rates used by broadcasters in their programming. You may want to try one or more of the following suggestions, which may help to reduce the effect of this phenomenon:
  - If the TV is connected to an A/V receiver that has a programmable audio delay feature, use this feature to help synchronize the sound to the picture.
  - If you notice this phenomenon only on certain TV channels, please contact your local broadcast, cable, or satellite provider to inform them of this issue.

### LED indications while in reboot from standby

- When you plug the power cord in, the yellow LED will blink until the TV enters standby mode, (plugged in but not powered on). This is normal and is not a sign of malfunction.

### Sound problems

- Check the antenna/cable connections (ⓘ Chapter 2).
- The station may have broadcast difficulties. Try another channel.
- The sound may be muted. Press **VOLUME**.
- If you hear no sound, try setting the **MTS** feature to **Stereo** mode (ⓘ page 51).
- If you are not receiving a second audio program from a known SAP source, make sure the **MTS** feature is set to **SAP** mode (ⓘ page 51).
- If you hear audio that seems "incorrect" for the program you are watching (such as music or a foreign language), the SAP mode may be on. Set the **MTS** feature to **Stereo** mode (ⓘ page 51).

(continued)

### Remote control problems

- Make sure the remote control is set to the correct device mode (☞ page 21).
- Remove all obstructions between the remote control and the TV.
- The remote control batteries may be dead. Replace the batteries (☞ page 20).
- Your TV remote control may not operate certain features on your external device. Refer to the owner's manual for your other device to determine its available features. If your TV remote control does not operate a specific feature on another device, use the remote control that came with the device (☞ pages 26–32).
- If the TV still does not act as expected, use the Reset Factory Defaults procedure (☞ page 40).

### Channel tuning problems

- Make sure the remote control is set to the correct device mode (☞ page 21).
- The channel may have been erased from the channel memory by the **Channel Add/Delete** feature. Add the channel to the channel memory (☞ page 37).
- The channel may be blocked by the **Channels Block** feature. Unblock the channel (☞ page 55).
- If you are unable to tune digital channels, check the antenna configuration (☞ page 36). If you are still unable to tune digital channels, clear all channels from the channel list (☞ page 37) and reprogram channels into the channel memory (☞ page 36). If you are still unable to tune digital channels, use the Reset Factory Defaults procedure (☞ page 40). Also see “TV stops responding to controls” and “Other problems” (☞ page 65).

### Closed caption problems

- If the program or video you selected is not closed-captioned, no captions will display (☞ page 49).
- If text is not available, a black rectangle may appear. If this happens, turn off the closed caption feature (☞ page 49).
- A closed-caption signal may not display correctly in the following situations: a) when a videotape has been dubbed; b) when the signal reception is weak; or c) when the signal reception is nonstandard (☞ page 49).

### Rating blocking (V-Chip) problems

- If you forget your PIN code: While the PIN code entering screen is displayed, press **RECALL** four times within 5 seconds. The PIN code you previously stored will be cleared (☞ page 52).
- The V-Chip feature is available for the U.S. V-Chip system only (☞ page 53).

### No REGZA-LINK operation

- The REGZA-LINK feature is available for Toshiba REGZA-LINK compatible devices.
- Make sure the HDMI cables with the HDMI Logo (**HDMI**) are used.
- When the connected REGZA-LINK device does not work correctly after you have changed settings of the device, turn off your TV and unplug the power cord, then plug and turn on again.
- If several devices are connected, REGZA-LINK feature may not operate properly.
- Read the instruction manual furnished with the connected REGZA-LINK device.

### HDMI problems

#### For HDMI cables

- Make sure the HDMI cables with the HDMI Logo (**HDMI**) are used (☞ pages 16, 17 and 19).

#### For Deep Color

- You should need to use Category 2 cable to work properly. Normal HDMI cable or DVI cable may not work with this option (☞ page 59).

#### For Legacy HDMI source

- Some of legacy HDMI sources may not work properly with latest HDMI TV products, due to new standard adoption. Please try to set Off the HDMI settings (Lip-Sync Latency, Deep Color, x.v.Color). Your legacy HDMI source should operate properly with this TV products (☞ page 59).

## LED indications

The green and yellow LED lights on the TV front indicate the TV's status, as described below.

**Note:** If the TV loses A/C power (e.g., a power outage occurs or the power cord is unplugged), when power is restored, the yellow LED will blink while the TV is booting until the remote control is usable. This is normal and is not a sign of malfunction.

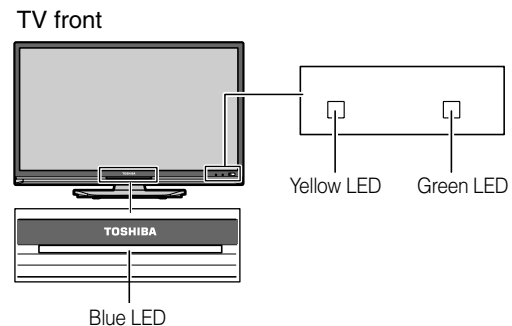

### LED Indication

- **Blue is ON (solid)**  
The TV is operating properly.
- **Yellow is ON (solid)**  
Standby with Power-On Mode set to Fast.  
See “Selecting the Power-On Mode” (☞ page 40).
- **Yellow blinks**  
Fan stopped (40XF550U and 46XF550U only).  
Turn OFF the TV and unplug the power cord. Plug the power cord in again and turn ON the TV.
- **Yellow blinks three times**  
TV is powering up.  
Wait several seconds until the yellow LED stops blinking.
- **Green blinks slowly**  
Abnormal operation of BUS line.  
Turn OFF the TV and unplug the power cord. Plug the power cord in again and turn ON the TV.

- **Green blinks quickly**

Power protect detection.

Turn OFF the TV and unplug the power cord. Plug the power cord in again and turn ON the TV.

- **Green blinks slowly**

**Yellow blinks slowly**

Charis calibration error.

Turn OFF the TV and unplug the power cord. Plug the power cord in again and turn ON the TV.

If, after trying the solutions, the problem still exists:

- In the U.S., call TACP Consumer Solutions at 1-800-575-5469.
- In Canada, locate the nearest Toshiba authorized service depot by directing your web browser to **www.toshiba.ca**; click “Home Entertainment,” and then click “Support.”

## Specifications

### Note:

- *This model complies with the specifications listed below.*
- *Designs and specifications are subject to change without notice.*
- *This model may not be compatible with features and/or specifications that may be added in the future.*

### Television System

NTSC standard  
ATSC standard (8VSB)  
Digital Cable (64 QAM, 256 QAM; in-the-clear, unencrypted)

### Channel Coverage

VHF: 2 through 13  
UHF: 14 through 69  
Cable TV: Mid band (A-8 through A-1, A through I)  
Super band (J through W)  
Hyper band (AA through ZZ, AAA, BBB)  
Ultra band (65 through 94, 100 through 135)

**Power Source:** 120 V AC, 60 Hz

### Power Consumption

40XF550U: 3.0 Arms (maximum current)  
0.6 W in standby mode  
46XF550U: 2.8 Arms (maximum current)  
0.4 W in standby mode  
52XF550U: 3.0 Arms (maximum current)  
0.4 W in standby mode

**Audio Power:** 10 W + 10 W

### Speaker Type

Two 4 inches (100 mm) round

### Video/Audio Terminals

#### S-VIDEO INPUT:

Y: 1 V(p-p), 75 ohm, negative sync.  
C: 0.286 V(p-p) (burst signal), 75 ohm

#### VIDEO/AUDIO INPUT:

VIDEO: 1 V(p-p), 75 ohm, negative sync.  
AUDIO: 150 mV(rms) (30% modulation equivalent, 22 k ohm or greater)

#### ColorStream® (component video) HD INPUT:

VIDEO: Y: 1V(p-p), 75 ohm  
Pr: 0.7 V(p-p), 75 ohm  
Pb: 0.7 V(p-p), 75 ohm  
Suggested formats: 1080i, 720p, 480p, 480i  
AUDIO: 150 mV(rms), 22 k ohm or greater

#### HDMI™ INPUT:

HDMI compliant (type A connector)  
HDCP compliant  
Audio Lip Sync supported  
Deep Color supported (10 bit 4:4:4, 12 bit 4:4:4)  
x.v.Color supported  
Suggested formats: See table on the next page.  
HDMI Audio: 2-channel Linear-PCM; 32/44.1/48 kHz  
sampling frequency; 16/20/24 bits per sample

#### FIXED AUDIO OUTPUT:

150 mv (rms) (30% modulation equivalent, 2.2 k ohm or less)

#### DIGITAL AUDIO OUTPUT:

Optical type

#### IR OUT:

3 V(p-p), 3.5 mm mono socket

#### PC INPUT:

15-Pin D-sub Analog RGB

### Dimensions

40XF550U: Width: 36-7/8 inches (934 mm)  
Height: 22-7/8 inches (578 mm)  
Depth: 5-1/8 inches (130 mm)  
46XF550U: Width: 42-1/4 inches (1,070 mm)  
Height: 26 inches (659 mm)  
Depth: 5-3/8 inches (135 mm)  
52XF550U: Width: 47-7/8 inches (1,215 mm)  
Height: 31-5/8 inches (802 mm)  
Depth: 12-7/8 inches (325 mm)

### Mass (weight)

40XF550U: 67.0 lbs (30.4 kg)  
46XF550U: 84.4 lbs (38.3 kg)  
52XF550U: 102.7 lbs (46.6 kg)

### Operating conditions

Temperature: 32°F - 95°F (0°C - 35°C)  
Humidity: 20 - 80% (no moisture condensation)

### Supplied Accessories

- Remote control with two size “AA” alkaline batteries
- Owner’s manual (this book)
- Securement Clip  
Use this clip to attach the TV to a wall stud, pillar, or other immovable structure. See item 20 on page 3 and instructions on page 5.
- Cleaning cloth (to clean the cabinet and control panel)

## Acceptable signal formats for PC IN and HDMI terminals

### PC IN signal formats

**Note:** Depending on the connected PC, the following status may occur; incorrect display, false format detection, picture position failure, blur, or judder. But this is not a malfunction of your TV.

Format	Resolution	V. Frequency	H. Frequency	Pixel Clock Frequency
VGA	640 × 480	59.940Hz	31.469kHz	25.175MHz
		72.809Hz	37.861kHz	31.500MHz
		75.000Hz	37.500kHz	31.500MHz
SVGA	800 × 600	60.317Hz	37.879kHz	40.000MHz
		72.188Hz	48.077kHz	50.000MHz
		75.000Hz	46.875kHz	49.500MHz
XGA	1024 × 768	60.004Hz	48.363kHz	65.000MHz
		70.069Hz	56.476kHz	75.000MHz
		75.029Hz	60.023kHz	78.750MHz
WXGA	1280 × 768	59.995Hz	47.396kHz	68.250MHz
		59.870Hz	47.776kHz	79.500MHz
		74.893Hz	60.289kHz	102.250MHz
	1360 × 768	60.015Hz	47.712kHz	85.500MHz
SXGA	1280 × 1024	60.020Hz	63.981kHz	108.000MHz

### HDMI signal formats

Format	Resolution	V. Frequency	H. Frequency	Pixel Clock Frequency
VGA	640 × 480	59.940Hz	31.469kHz	25.175MHz
		72.809Hz	37.861kHz	31.500MHz
		75.000Hz	37.500kHz	31.500MHz
SVGA	800 × 600	60.317Hz	37.879kHz	40.000MHz
		72.188Hz	48.077kHz	50.000MHz
		75.000Hz	46.875kHz	49.500MHz
XGA	1024 × 768	60.004Hz	48.363kHz	65.000MHz
		70.069Hz	56.476kHz	75.000MHz
		75.029Hz	60.023kHz	78.750MHz
WXGA	1280 × 768	59.995Hz	47.396kHz	68.250MHz
		59.870Hz	47.776kHz	79.500MHz
		74.893Hz	60.289kHz	102.250MHz
	1360 × 768	60.015Hz	47.712kHz	85.500MHz
SXGA	1280 × 1024	60.020Hz	63.981kHz	108.000MHz
480i	720 × 480i	59.940/60Hz	15.734/15.750kHz	27.000/27.027MHz
480p	720 × 480p	59.940/60Hz	31.469/31.500kHz	27.000/27.027MHz
720p	1280 × 720p	59.940/60Hz	44.955/45.000kHz	74.176/74.250MHz
1080i	1920 × 1080i	59.940/60Hz	33.716/33.750kHz	74.176/74.250MHz
1080p	1920 × 1080p	23.976/24Hz	26.973/27.000kHz	74.176/74.250MHz
1080p	1920 × 1080p	59.940/60Hz	67.433/67.500kHz	148.352/148.500MHz

## Limited United States Warranty

### for LCD Televisions 26" and Larger

Toshiba America Consumer Products, L.L.C. ("TACP") makes the following limited warranties to original consumers in the United States.

**THESE LIMITED WARRANTIES EXTEND TO THE ORIGINAL CONSUMER PURCHASER OR ANY PERSON RECEIVING THIS LCD TELEVISION AS A GIFT FROM THE ORIGINAL CONSUMER PURCHASER AND TO NO OTHER PURCHASER OR TRANSFEREE. LCD TELEVISIONS PURCHASED IN THE U.S.A. AND USED ANYWHERE OUTSIDE OF THE U.S.A., INCLUDING, WITHOUT LIMITATION, CANADA AND MEXICO, ARE NOT COVERED BY THESE WARRANTIES.**

**LCD TELEVISIONS PURCHASED ANYWHERE OUTSIDE OF THE U.S.A., INCLUDING, WITHOUT LIMITATION, CANADA AND MEXICO, AND USED IN THE U.S.A., ARE NOT COVERED BY THESE WARRANTIES.**

#### Limited One (1) Year Warranty on Parts and Labor

TACP warrants this LCD Television and its parts against defects in materials or workmanship for a period of one (1) year after the date of original retail purchase. DURING THIS PERIOD, TACP WILL, AT TACP'S OPTION, REPAIR OR REPLACE A DEFECTIVE PART WITH A NEW OR REFURBISHED PART WITHOUT CHARGE TO YOU FOR PARTS OR LABOR. During this period, TACP Authorized Service Station personnel will come to your home when warranty service is required. Depending on the type of repair required, the service will either be performed in your home or the LCD Television will be taken to a TACP Authorized Service Station for repair and returned to your home at no cost to you.

#### Rental Units

The warranty for LCD Television rental units begins on the date of the first rental or thirty (30) days after the date of shipment to the rental firm, whichever comes first.

#### Limited Warranty for Commercial Units

TACP warrants LCD Televisions that are sold and used for commercial purposes as follows: all parts are warranted against defects in materials or workmanship for a period of ninety (90) days after the date of original retail purchase. DURING THIS PERIOD, TACP WILL, AT TACP'S OPTION, REPAIR OR REPLACE A DEFECTIVE PART WITH A NEW OR REFURBISHED PART WITHOUT CHARGE TO YOU.

#### Owner's Manual and Product Registration Card

Read this owner's manual thoroughly before operating this LCD Television.

Complete and mail the enclosed product registration card or register your LCD Television online at [www.tacp.toshiba.com/service](http://www.tacp.toshiba.com/service) as soon as possible. By registering your LCD Television you will enable TACP to bring you new products specifically designed to meet your needs and help us to contact you in the unlikely event a safety notification is required under the U.S. Consumer Product Safety Act. **Failure to complete and return the product registration card does not diminish your warranty rights.**

#### Your Responsibility

THE ABOVE WARRANTIES ARE SUBJECT TO THE FOLLOWING CONDITIONS:

- (1) You must retain your original bill of sale or provide other proof of purchase.
- (2) All warranty servicing of this LCD Television must be performed by an Authorized TACP Service Station.
- (3) The warranties from TACP are effective only if this LCD Television is purchased and operated in the Continental U.S.A. or Puerto Rico.
- (4) Labor service charges for set installation, setup, adjustment of customer controls, and installation or repair of antenna systems are not covered by this warranty. Reception problems caused by inadequate antenna systems, misaligned satellite dishes, cable

television distribution, VCRs, DVD players/recorders, personal computer level IEEE-1394 devices, and any other connected signal source device are your responsibility.

- (5) Warranties extend only to defects in materials or workmanship as limited above, and do not extend to any LCD Television or parts that have been lost or discarded by you or to damage to the LCD Television or parts caused by fires, misuse, accident, Acts of God (such as lightning or fluctuations in electric power), improper installation, improper maintenance, or use in violation of instructions furnished by TACP; use or malfunction through simultaneous use of this LCD Television and connected equipment; or to units that have been modified or had the serial number removed, altered, defaced, or rendered illegible.

#### How to Obtain Warranty Service

If, after following all of the operating instructions in this manual and reviewing the section entitled "Troubleshooting," you find that service is needed:

- (1) To find the nearest TACP Authorized Service Station, visit TACP's website at [www.tacp.toshiba.com/service](http://www.tacp.toshiba.com/service) or contact TACP's Consumer Solution Center toll free at 1-800-575-5469.
- (2) You must present your original bill of sale or other proof of purchase to the TACP Authorized Service Station.

---

**For additional information, visit TACP's website:  
[www.tacp.toshiba.com](http://www.tacp.toshiba.com)**

---

ALL WARRANTIES IMPLIED BY THE LAW OF ANY STATE OF THE U.S.A., INCLUDING THE IMPLIED WARRANTIES OF MERCHANTABILITY AND FITNESS FOR A PARTICULAR PURPOSE, ARE EXPRESSLY LIMITED TO THE DURATION OF THE LIMITED WARRANTIES SET FORTH ABOVE. WITH THE EXCEPTION OF ANY WARRANTIES IMPLIED BY THE LAW OF ANY STATE OF THE U.S.A. AS HEREBY LIMITED, THE FOREGOING WARRANTY IS EXCLUSIVE AND IN LIEU OF ALL OTHER WARRANTIES, GUARANTEES, AGREEMENTS, AND SIMILAR OBLIGATIONS OF TACP WITH RESPECT TO THE REPAIR OR REPLACEMENT OF ANY PARTS. IN NO EVENT SHALL TACP BE LIABLE FOR CONSEQUENTIAL OR INCIDENTAL DAMAGES (INCLUDING, BUT NOT LIMITED TO, LOST PROFITS, BUSINESS INTERRUPTION, OR MODIFICATION OR ERASURE OF RECORDED DATA CAUSED BY USE, MISUSE OR INABILITY TO USE THIS LCD TELEVISION).

No person, agent, distributor, dealer, or company is authorized to change, modify, or extend the terms of these warranties in any manner whatsoever. The time within which an action must be commenced to enforce any obligation of TACP arising under the warranty or under any statute or law of the United States or any state thereof is hereby limited to ninety (90) days from the date you discover, or should have discovered, the defect. This limitation does not apply to implied warranties arising under the law of any state of the U.S.A.

THIS WARRANTY GIVES YOU SPECIFIC LEGAL RIGHTS AND YOU MAY ALSO HAVE OTHER RIGHTS WHICH MAY VARY FROM STATE TO STATE IN THE U.S.A. SOME STATES OF THE U.S.A. DO NOT ALLOW LIMITATIONS ON THE DURATION OF AN IMPLIED WARRANTY, WHEN AN ACTION MAY BE BROUGHT, OR THE EXCLUSION OR LIMITATION OF INCIDENTAL OR CONSEQUENTIAL DAMAGES. THEREFORE, THE ABOVE PROVISIONS MAY NOT APPLY TO YOU UNDER SUCH CIRCUMSTANCES.

## Limited Canadian Warranty for Toshiba Brand Flat Panel Televisions

Toshiba of Canada Limited ("TCL") makes the following limited warranties to original consumers in Canada. THESE LIMITED WARRANTIES EXTEND TO THE ORIGINAL CONSUMER PURCHASER OR ANY PERSON RECEIVING THIS TOSHIBA BRAND FLAT PANEL TELEVISION (the "TELEVISION(S)" or "Television(s)") AS A GIFT FROM THE ORIGINAL CONSUMER PURCHASER AND TO NO OTHER PURCHASER OR TRANSFEREE.

TELEVISIONS PURCHASED IN CANADA, AND USED ANYWHERE OUTSIDE OF CANADA INCLUDING, WITHOUT LIMITATION, THE UNITED STATES AND MEXICO, ARE NOT COVERED BY THESE WARRANTIES.

TELEVISIONS PURCHASED ANYWHERE OUTSIDE OF CANADA, INCLUDING, WITHOUT LIMITATION, THE UNITED STATES AND MEXICO, AND USED IN CANADA, ARE NOT COVERED BY THESE WARRANTIES.

### Limited One (1) Year Warranty on Parts and Labour

Subject to the more limited warranty if the Television is used for any commercial or business purposes as set out below, TCL warrants the Television and its parts against material defects in materials or workmanship that result in the Television failing for a period of one (1) year after the date of original retail purchase. DURING THIS PERIOD, TCL WILL, AT TCL'S OPTION, REPAIR OR REPLACE A DEFECTIVE PART WITH A NEW OR REFURBISHED PART WITHOUT CHARGE TO YOU FOR PARTS OR LABOUR.

- (a) FOR TELEVISIONS 32 INCHES OR LESS: YOU MUST DELIVER THE ENTIRE TELEVISION TO A TCL TELEVISION AUTHORIZED SERVICE PROVIDER ("ASP"). YOU MUST PAY FOR ALL TRANSPORTATION AND INSURANCE CHARGES FOR THE TELEVISION TO AND FROM THE ASP.
- (b) FOR TELEVISIONS OVER 32 INCHES: During this period, ASP personnel will come to your home when warranty service is required. Depending on the type of repair required, the service will either be performed in your home or the Television will be taken to an ASP for repair and returned to your home at no cost to you. **IN-HOME SERVICE ONLY APPLIES WITHIN 100 KILOMETERS OF AN ASP. IF YOU ARE NOT WITHIN 100 KILOMETERS OF AN ASP, YOU MUST DELIVER THE ENTIRE TELEVISION TO AN ASP. YOU MUST PAY FOR ALL TRANSPORTATION AND INSURANCE CHARGES FOR THE TELEVISION TO AND FROM THE ASP.**

### Limited Warranty for Commercial Units

TCL warrants Televisions that are used for any commercial or business purposes as follows: all parts are warranted against material defects in materials or workmanship that result in the Television failing for a period of ninety (90) days after the date of original retail purchase. DURING THIS PERIOD, TCL WILL, AT TCL'S OPTION, REPAIR OR REPLACE THE DEFECTIVE PART WITH A NEW OR REFURBISHED PART WITHOUT CHARGE TO YOU.

- (c) FOR TELEVISIONS 32 INCHES OR LESS: YOU MUST DELIVER THE ENTIRE TELEVISION TO AN ASP. YOU MUST PAY FOR ALL TRANSPORTATION AND INSURANCE CHARGES FOR THE TELEVISION TO AND FROM THE ASP.

- (d) FOR TELEVISIONS OVER 32 INCHES: During this period, ASP personnel will come on-site when warranty service is required. Depending on the type of repair required, the service will either be performed on-site or the Television will be taken to an ASP for repair and returned at no cost to you. **ON-SITE SERVICE ONLY APPLIES WITHIN 100 KILOMETERS OF AN ASP. IF YOU ARE NOT WITHIN 100 KILOMETERS OF AN ASP, YOU MUST DELIVER THE ENTIRE TELEVISION TO AN ASP. YOU MUST PAY FOR ALL TRANSPORTATION AND INSURANCE CHARGES FOR THE TELEVISION TO AND FROM THE ASP.**

### Rental Units

The warranty for Television rental units begins with the date of first rental or thirty (30) days from the date of shipment to the rental firm, whichever comes first.

### Your Responsibility

THE ABOVE WARRANTIES ARE SUBJECT TO THE FOLLOWING CONDITIONS:

- (1) You must provide your bill of sale or other proof of purchase.
- (2) All warranty servicing of this Television must be performed by an ASP.
- (3) The warranties from TCL are effective only if the Television is (i) purchased as new and unopened from TCL or from TCL's authorized distributors, dealers or resellers ("ADR's") and (ii) located/operated in Canada.
- (4) Labour charges for set installation, setup, adjustment of customer controls, and installation or repair of antenna systems are not covered by these warranties. Reception problems caused by inadequate antenna systems are your responsibility.
- (5) Warranties extend only to material defects in materials or workmanship as limited above, and do not extend to:
  - a. Service, repairs or replacement made necessary by accident, misuse, abuse, moisture, liquids, dust, dirt, neglect, accident, damage, 24/7 applications, improper installation, improper operation, improper cleaning, improper maintenance, normal wear and tear, screen burn or image retention caused by prolonged display of static images and/or phosphor aging, or any other external cause or event, act or omission outside the control of TCL, including fire, theft, acts of God, alteration, power failures, power surges or power shortages, lightning, other electrical faults, or repairs, modifications or replacements by persons other than those authorized by TCL to service the Television;
  - b. Replacement of missing, discarded or lost parts, the provision of retrofits, or preventive maintenance;
  - c. Repair of damage that is cosmetic only or does not affect the Television functionality, such as wear and tear, scratches and dents;
  - d. Service on Toshiba-branded accessory items (such accessory items may be covered by their own warranty);
  - e. Service on third party products or service made necessary by use of incompatible third party products;
  - f. Service made necessary by the simultaneous use of this Television and connected equipment;
  - g. Modifications to the Television not approved in writing by TCL, and service made necessary by the use or installation of non-Toshiba modifications to the Television;
  - h. Service of a Television on which the TOSHIBA label or logo, rating label or serial number have been defaced or removed;
  - i. On-site service and repair of the Television; and
  - j. Damage to the Television caused by failure to follow the specifications, User manuals or guides as to usage and/or storage.

(continued)

### Disclaimer and Limitation of Remedy

TO THE EXTENT NOT PRECLUDED BY LAW, ALL OTHER EXPRESS AND IMPLIED WARRANTIES, CONDITIONS AND REPRESENTATIONS FOR THIS TELEVISION, INCLUDING THE IMPLIED WARRANTIES, CONDITIONS AND REPRESENTATIONS OF MERCHANTABILITY AND FITNESS FOR A PARTICULAR PURPOSE, ARE HEREBY DISCLAIMED AND EXCLUDED. IF THE APPLICABLE LAW, STATUTORY OR OTHERWISE, PRECLUDES THE EXCLUSION OF ANY IMPLIED WARRANTIES, CONDITIONS AND REPRESENTATIONS THEN SUCH IMPLIED WARRANTIES, CONDITIONS AND REPRESENTATIONS ARE OTHERWISE LIMITED IN DURATION TO THE TERM OF THIS EXPRESS WRITTEN LIMITED WARRANTY. TO THE EXTENT NOT PRECLUDED BY LAW, STATUTORY OR OTHERWISE, THIS WRITTEN WARRANTY SUPERCEDES AND SPECIFICALLY DISCLAIMS ANY OTHER WARRANTY, CONDITION OR REPRESENTATION NOT STATED IN THIS WARRANTY, WHETHER MADE BY TCL, TOSHIBA CORPORATION, THEIR AFFILIATES, ADRs AND ASPs AND WHETHER MADE ORALLY OR IN WRITING (INCLUDING ANY STATEMENT IN ANY BROCHURE, PRESS RELEASE, ANNOUNCEMENT, ADVERTISEMENT, POINT OF SALE DISPLAY, ETC.).

YOU MUST READ AND FOLLOW ALL SET-UP AND USAGE INSTRUCTIONS IN THE APPLICABLE USER GUIDES AND/OR MANUALS. IF YOU FAIL TO DO SO, THIS TELEVISION MAY NOT FUNCTION PROPERLY AND YOU MAY SUFFER DAMAGE. THIS WARRANTY WILL NOT COVER ANY SERVICE THAT IS REQUIRED, IN PART OR IN WHOLE, AS A RESULT OF ANY FAILURE TO FOLLOW THE SET-UP AND USAGE INSTRUCTIONS. THIS WARRANTY DOES NOT APPLY AND SHALL BE VOID AND UNENFORCEABLE IF THE TELEVISION IS OPENED, SERVICED, OR REPAIRED BY PERSONS OTHER THAN THOSE AUTHORIZED BY TCL TO SERVICE OR REPAIR THE TELEVISION.

IF THE TELEVISION FAILS TO WORK AS WARRANTED ABOVE, YOUR SOLE AND EXCLUSIVE REMEDY SHALL BE REPAIR OR REPLACEMENT OF THE DEFECTIVE PART. IN NO EVENT WILL TCL, TOSHIBA CORPORATION, THEIR AFFILIATES, ADRs OR ASPs (THE "RELATED PARTIES") BE LIABLE TO YOU OR ANY THIRD PARTY FOR ANY DAMAGES, MONEY, REIMBURSEMENT, COSTS OR EXPENSES. THIS LIMITATION APPLIES TO DAMAGES, MONEY, REIMBURSEMENT, COSTS OR EXPENSES OF ANY KIND WHATSOEVER INCLUDING ANY DIRECT OR INDIRECT DAMAGES, DAMAGE TO PROPERTY OR PERSON, LOST PROFITS, LOST SAVINGS, INCONVENIENCE OR OTHER SPECIAL, INCIDENTAL, EXEMPLARY OR CONSEQUENTIAL DAMAGES, WHETHER FOR BREACH OF WARRANTY, BREACH OF CONTRACT, TORT (INCLUDING NEGLIGENCE), UNDER A STATUTE OR UNDER ANY OTHER LAW OR FORM OR ACTION, OR WHETHER ARISING OUT OF THE USE OF OR INABILITY TO USE THE TELEVISION, EVEN IF ANY OF THE RELATED PARTIES HAS BEEN ADVISED OF THE POSSIBILITY OF SUCH DAMAGES OR OF ANY CLAIM BY ANY OTHER PARTY.

No person, agent, distributor, dealer or company is authorized to change, modify or extend the terms of these warranties in any manner whatsoever.

### Arbitration and Dispute Resolution

To the extent not precluded by law, any claim, dispute, controversy or disagreement (whether for breach of warranty, breach of contract, tort (including negligence), under a statute or under any other law or form of action) against any of the Related Parties arising out of, or otherwise relating to: (i) this warranty; (ii) the Television; (iii) any oral or written representations, statements, brochures, press releases, advertising, announcement, point of sale display, or promotional material relating to the Television; (iv) the relationships that result from this warranty, (the foregoing claims, disputes controversies and disagreements are collectively referred to as the "Dispute"), shall be referred to and resolved by final and binding arbitration (to the exclusion of the courts). To the extent not precluded by law, you agree to waive any right that you may have to commence or participate in any representative or class proceeding against the Related Parties relating to any Dispute. If and where applicable and to the extent not precluded by law, you further

agree to opt out of any such representative or class proceedings. Arbitration of any Dispute will be conducted in the forum and in the manner as agreed to between you and TCL. Failing such agreement, the arbitration will be conducted by one arbitrator pursuant to the laws and rules relating to arbitration generally in force in the jurisdiction in which you reside at the time that the Dispute arises. To the extent not precluded by law, no claim, dispute, controversy or disagreement of any other person may be joined or combined with any Dispute by you, without the prior written consent of TCL.

### Critical Applications

The Television you have purchased is not designed for any "critical applications." "Critical applications" means life support systems, medical applications, connections to implanted medical devices, commercial transportation, nuclear facilities or systems or any other applications where Television failure could lead to injury to persons or loss of life or catastrophic property damage.

IF THE CUSTOMER USES THE TELEVISION IN ANY CRITICAL APPLICATION, THE CUSTOMER - AND NOT TCL, ITS AFFILIATES, ADRs OR ASPs - ASSUME SOLE AND FULL RESPONSIBILITY FOR SUCH USE. TCL RESERVES THE RIGHT TO REFUSE TO SERVICE ANY TELEVISION USED IN A CRITICAL APPLICATION. TCL, ITS AFFILIATES, ADRs AND ASPs HEREBY DISCLAIM ANY AND ALL LIABILITY, DAMAGES AND CONSEQUENCES ARISING OUT OF THE SERVICE OR REFUSAL TO SERVICE SUCH TELEVISION AND FURTHER DISCLAIM ANY AND ALL LIABILITY, CONSEQUENCES AND DAMAGES THAT MAY ARISE OR RESULT FROM THE USE OF THE TELEVISION IN ANY CRITICAL APPLICATIONS.

### General Provisions

If and to the extent that any provision of this limited warranty should generally be found to be unenforceable, the unenforceable provision shall be severed from the warranty and deemed not to form part of the warranty. The remaining provisions of this warranty shall be and remain valid and enforceable. If and to the extent that any provision of this limited warranty as it relates to any of the Related Parties is found to be invalid or unenforceable in respect of that party (the "Excluded Party"), the Excluded Party shall be deemed to be severed or excluded from the provision, and the provision shall remain valid, enforceable and applicable in respect of the other or remaining Related Parties.

To the extent permitted by law, this limited warranty shall be governed and construed in accordance with the laws of Ontario.

If there is any inconsistency between this limited warranty, on the one hand, and any statement in the packaging of the Television or in any other document enclosed with, or used in the context of the promotion or sale of, the Television, on the other hand, the provisions of this limited warranty shall prevail.

### How to Obtain Warranty Services

If, after following all of the operating instructions in this manual and checking the "Troubleshooting" section, you find that service is needed:

- (1) To find the nearest ASP, visit TCL's web site at [www.toshiba.ca](http://www.toshiba.ca), or call toll free 1-800-268-3404
- (2) Present your bill of sale or other proof of purchase to the ASP.

For additional information, visit TCL's website at [www.toshiba.ca](http://www.toshiba.ca)

A copy of the GPL source code in this product may be obtained by contacting Toshiba Consumer Solutions at (800)631-3811. There will be a charge to cover the costs of providing the source code.

A copy of the LGPL source code in this product may be obtained by contacting Toshiba Consumer Solutions at (800)631-3811. There will be a charge to cover the costs of providing the source code.

Portions of this software are copyright © <2007> The FreeType Project ([www.freetype.org](http://www.freetype.org)). All rights reserved.

This software is based in part on the work of the Independent JPEG Group.



# Index

- A**
- Antenna input configuration ..... 36
  - Audio quality adjustments ..... 51
  - Audio system connection ..... 18
  - Auto aspect..... 47
  - Auto Input ..... 37
  - Auto power off ..... 60
- B**
- Base closed captions..... 49
  - Blocking channels ..... 55
- C**
- C (CLOSED). CAPTION button..... 50
  - CableClear® ..... 62
  - CH ▲▼ buttons ..... 21, 44
  - CH RTN button..... 21, 45
  - Channel Browser™ ..... 42
  - Channel labeling ..... 38
  - Channel Number buttons ..... 21, 44
  - Channel programming
    - Automatic programming ..... 36
    - Manually adding and deleting... 37
  - Channel Tuning Mode ..... 44
  - Cinema mode..... 62
  - ClearFrame™ ..... 62
  - Closed captions..... 49
  - Color temperature ..... 61
  - ColorMaster™ ..... 63
  - ColorStream® ..... 14
  - Component video ..... 14
- D**
- Deep Color..... 59
  - Demo mode ..... 35, 40
  - Device codes table ..... 26
  - Digital Audio Out ..... 18
  - Digital audio selector ..... 51
  - Digital CC Settings ..... 50
  - Digital signal meter ..... 39
  - Dolby Digital..... 18
  - Dolby Digital Dynamic Range
    - Control..... 52
  - DVD player connection ..... 14
  - DVI connection..... 16
  - DynaLight™ ..... 48
  - Dynamic contrast..... 61
- F**
- Film Stabilization ..... 62
  - FREEZE ..... 48
- G**
- Game Mode feature..... 64
  - GameTimer® ..... 55
- H**
- HDMI audio mode..... 39
  - HDMI settings..... 59
    - Deep Color ..... 59
    - Lip-Sync Latency ..... 59
    - x.v.Color..... 59
  - HDMI™ connection..... 16
- I**
- INFO button..... 60
  - INPUT button..... 41
  - Integrated digital tuning..... 9
  - IR blaster..... 15
  - IR OUT connection ..... 15
- L**
- Labeling video input..... 41
  - Language selection..... 35
  - Last mode memory feature ..... 60
  - LED indications..... 10, 66
  - Lip-Sync Latency ..... 59
  - LOCKS menu
    - Channels, blocking..... 55
    - Control Panel lock..... 56
    - Enable rating blocking..... 53
    - New PIN code..... 53
    - Unlocking programs
      - temporarily ..... 55
    - Video inputs, locking ..... 55
- M**
- MODE SELECT..... 21, 24
  - MPEG noise reduction ..... 63
  - MTS feature ..... 51
  - MUTE button ..... 50
- O**
- Optical audio output format ..... 52
- P**
- PC Audio..... 57
  - PC connection ..... 19
  - PC settings..... 56
  - Picture mode ..... 48
  - Picture quality..... 48
  - Picture scroll..... 47
  - Picture size selection ..... 45
  - POWER button..... 10, 21
  - Power-On Mode ..... 40
- R**
- RECALL button..... 60
  - REGZA-LINK connection..... 17
  - REGZA-LINK feature ..... 57
  - Remote control
    - Battery installation ..... 20
    - Learning about the buttons ..... 21
    - Operational feature..... 25
    - Volume lock feature..... 25
  - Reset Factory Defaults..... 40
- S**
- SAP sound ..... 51
  - Satellite receiver connection..... 14
  - Scroll settings ..... 47
  - Sleep timer ..... 57
  - StableSound® ..... 52
  - Stereo sound ..... 51
  - SurfLock™ ..... 45
  - System status ..... 40
- T**
- TheaterLock™ feature..... 49
  - TheaterWide® picture size ..... 46
  - THINC button..... 21
  - THINC™ menu ..... 33
  - Time Zone ..... 39
  - TV status information ..... 60
- V**
- V-Chip ..... 53
  - VCR connection ..... 13, 14
  - Video input label ..... 41
  - Video input lock ..... 55
- W**
- WOW:SRS 3D ..... 64
  - WOW:SRS Focus ..... 64
  - WOW:SRS TruBass..... 64
- X**
- x.v.Color Selection ..... 64

## **TOSHIBA AMERICA CONSUMER PRODUCTS, L.L.C.**

Corporate Headquarters: 82 TOTOWA ROAD, WAYNE, NJ 07470, U.S.A.

NATIONAL SERVICE DIVISION: 1420-B TOSHIBA DRIVE, LEBANON, TN 37087, U.S.A.

## **TOSHIBA OF CANADA LTD.**

HEAD OFFICE: 191 McNABB STREET, MARKHAM, ONTARIO, L3R 8H2, CANADA – TEL: (905) 470-5400

SERVICE CENTERS:

TORONTO: 191 McNABB STREET, MARKHAM, ONTARIO L3R 8H2, CANADA – TEL: (905) 470- 5400

MONTREAL: 18050 TRANS CANADA, KIRKLAND, QUEBEC, H9J 4A1, CANADA – TEL: (514) 390-7766

VANCOUVER: 13551 COMMERCE PARKWAY, SUITE 110, RICHMOND, B.C., V6V 2L1, CANADA – TEL: (604) 303-2500

MANUFACTURED BY

**TOSHIBA ELECTROMEX, S.A. DE C.V.**

CableClear, ColorStream, GameTimer, StableSound, and TheaterWide are registered trademarks of Toshiba America Consumer Products, L.L.C.

Channel Browser, SurfLock, DynaLight, ClearFrame, ColorMaster, TheaterLock and THINC are trademarks of Toshiba America Consumer Products, L.L.C.

REGZA is a trademark of Toshiba Corporation.

PRINTED IN USA  
(08-01)

# **TOSHIBA**

## Free Manuals Download Website

<http://myh66.com>

<http://usermanuals.us>

<http://www.somanuals.com>

<http://www.4manuals.cc>

<http://www.manual-lib.com>

<http://www.404manual.com>

<http://www.luxmanual.com>

<http://aubethermostatmanual.com>

Golf course search by state

<http://golfingnear.com>

Email search by domain

<http://emailbydomain.com>

Auto manuals search

<http://auto.somanuals.com>

TV manuals search

<http://tv.somanuals.com>